

FCC Test Report

Report No.: RF170609C20A

FCC ID: QXO-AP3915E

Test Model: AP3915e

Series Model: AP7632 (refer to item 3.1 for more details)

Received Date: Jun. 09, 2017

Test Date: Jun. 09 ~ Aug. 09, 2017

Issued Date: Sep. 05, 2017

Applicant: Extreme Networks, Inc.

Address: 6480 VIA DEL ORO SAN JOSE CA 95119 USA

Issued By: Bureau Veritas Consumer Products Services (H.K.) Ltd., Taoyuan Branch

Lab Address: No. 47-2, 14th Ling, Chia Pau Vil., Lin Kou Dist., New Taipei City, Taiwan (R.O.C.)

Test Location: No. 19, Hwa Ya 2nd Rd., Wen Hwa Vil., Kwei Shan Dist., Taoyuan City 33383, TAIWAN (R.O.C.)



This report is for your exclusive use. Any copying or replication of this report to or for any other person or entity, or use of our name or trademark, is permitted only with our prior written permission. This report sets forth our findings solely with respect to the test samples identified herein. The results set forth in this report are not indicative or representative of the quality or characteristics of the lot from which a test sample was taken or any similar or identical product unless specifically and expressly noted. Our report includes all of the tests requested by you and the results thereof based upon the information that you provided to us. You have 60 days from date of issuance of this report to notify us of any material error or omission caused by our negligence, provided, however, that such notice shall be in writing and shall specifically address the issue you wish to raise. A failure to raise such issue within the prescribed time shall constitute your unqualified acceptance of the completeness of this report, the tests conducted and the correctness of the report contents. Unless specific mention, the uncertainty of measurement has been explicitly taken into account to declare the compliance or non-compliance to the specification. The report must not be used by the client to claim product certification, approval, or endorsement by TAF or any government agencies.

Table of Contents

Release Control Record	4
1 Certificate of Conformity	5
2 Summary of Test Results	6
2.1 Measurement Uncertainty.....	6
2.2 Modification Record.....	6
3 General Information	7
3.1 General Description of EUT.....	7
3.2 Description of Test Modes.....	17
3.2.1 Test Mode Applicability and Tested Channel Detail.....	18
3.3 Duty Cycle of Test Signal.....	21
3.4 Description of Support Units.....	27
3.4.1 Configuration of System under Test.....	28
3.5 General Description of Applied Standards.....	29
4 Test Types and Results	30
4.1 Radiated Emission and Bandedge Measurement.....	30
4.1.1 Limits of Radiated Emission and Bandedge Measurement.....	30
4.1.2 Test Instruments.....	31
4.1.3 Test Procedures.....	32
4.1.4 Deviation from Test Standard.....	32
4.1.5 Test Setup.....	33
4.1.6 EUT Operating Conditions.....	34
4.1.7 Test Results.....	35
4.2 Conducted Emission Measurement.....	165
4.2.1 Limits of Conducted Emission Measurement.....	165
4.2.2 Test Instruments.....	165
4.2.3 Test Procedures.....	166
4.2.4 Deviation from Test Standard.....	166
4.2.5 Test Setup.....	166
4.2.6 EUT Operating Conditions.....	166
4.2.7 Test Results.....	167
4.3 Transmit Power Measurement.....	187
4.3.1 Limits of Transmit Power Measurement.....	187
4.3.2 Test Setup.....	187
4.3.3 Test Instruments.....	188
4.3.4 Test Procedure.....	188
4.3.5 Deviation from Test Standard.....	188
4.3.6 EUT Operating Conditions.....	188
4.3.7 Test Result.....	189
4.4 Occupied Bandwidth Measurement.....	261
4.4.1 Test Setup.....	261
4.4.2 Test Instruments.....	261
4.4.3 Test Procedure.....	261
4.4.4 Test Result.....	262
4.5 Peak Power Spectral Density Measurement.....	280
4.5.1 Limits of Peak Power Spectral Density Measurement.....	280
4.5.2 Test Setup.....	280
4.5.3 Test Instruments.....	280
4.5.4 Test Procedures.....	280
4.5.5 Deviation from Test Standard.....	281
4.5.6 EUT Operating Conditions.....	281
4.5.7 Test Results.....	282
4.6 Frequency Stability.....	312
4.6.1 Limits of Frequency Stability Measurement.....	312

4.6.2	Test Setup.....	312
4.6.3	Test Instruments	312
4.6.4	Test Procedure	312
4.6.5	Deviation from Test Standard	312
4.6.6	EUT Operating Condition	312
4.6.7	Test Results	313
4.7	6dB Bandwidth Measurement.....	319
4.7.1	Limits of 6dB Bandwidth Measurement.....	319
4.7.2	Test Setup.....	319
4.7.3	Test Instruments	319
4.7.4	Test Procedure	319
4.7.5	Deviation from Test Standard	319
4.7.6	EUT Operating Condition	319
4.7.7	Test Results	320
5	Pictures of Test Arrangements.....	332
	Appendix – Information on the Testing Laboratories	333

Release Control Record

Issue No.	Description	Date Issued
RF170609C20A	Original release.	Sep. 05, 2017

1 Certificate of Conformity

Product: Wireless 802.11 a/ac+b/g/n Indoor Access Point

Brand: Extreme Networks

Test Model: AP3915e

Series Model: AP7632 (refer to item 3.1 for more details)

Sample Status: Engineering sample

Applicant: Extreme Networks, Inc.

Test Date: Jun. 09 ~ Aug. 09, 2017

Standards: 47 CFR FCC Part 15, Subpart E (Section 15.407)
ANSI C63.10:2013

The above equipment has been tested by **Bureau Veritas Consumer Products Services (H.K.) Ltd., Taoyuan Branch**, and found compliance with the requirement of the above standards. The test record, data evaluation & Equipment Under Test (EUT) configurations represented herein are true and accurate accounts of the measurements of the sample's EMC characteristics under the conditions specified in this report.

Prepared by : Celine Chou , **Date:** Sep. 05, 2017
Celine Chou / Specialist

Approved by : Ken Liu , **Date:** Sep. 05, 2017
Ken Liu / Senior Manager

2 Summary of Test Results

47 CFR FCC Part 15, Subpart E (Section 15.407)			
FCC Clause	Test Item	Result	Remarks
15.407(b)(6)	AC Power Conducted Emissions	Pass	Meet the requirement of limit. Minimum passing margin is -5.08dB at 0.46813MHz.
15.407(b) (1/2/3/4(i/ii)/6)	Radiated Emissions & Band Edge Measurement	Pass	Meet the requirement of limit. Minimum passing margin is -1.1dB at 5350.00MHz.
15.407(a)(1/2/3)	Max Average Transmit Power	Pass	Meet the requirement of limit.
---	Occupied Bandwidth Measurement	-	Reference only.
15.407(a)(1/2/3)	Peak Power Spectral Density	Pass	Meet the requirement of limit.
15.407(e)	6dB bandwidth	Pass	Meet the requirement of limit. (U-NII-3 Band only)
15.407(g)	Frequency Stability	Pass	Meet the requirement of limit.
15.203	Antenna Requirement	Pass	Antenna connectors are RP-SMA Male, N Male, RPSMA and Fixed N-Male Std polarity not a standard connector.

2.1 Measurement Uncertainty

Where relevant, the following measurement uncertainty levels have been estimated for tests performed on the EUT as specified in CISPR 16-4-2:

Measurement	Frequency	Expanded Uncertainty (k=2) (\pm)
Conducted Emissions at mains ports	150kHz ~ 30MHz	2.94 dB
Radiated Emissions up to 1 GHz	30MHz ~ 200MHz	3.86 dB
	200MHz ~ 1000MHz	3.87 dB
Radiated Emissions above 1 GHz	1GHz ~ 18GHz	2.29 dB
	18GHz ~ 40GHz	2.29 dB

2.2 Modification Record

There were no modifications required for compliance.

3 General Information

3.1 General Description of EUT

Product	Wireless 802.11 a/ac+b/g/n Indoor Access Point
Brand	Extreme Networks
Test Model	AP3915e
Series Model	AP7632
Model Difference	Refer to note for more details
Sample Status	Engineering sample
Power Supply Rating	12Vdc from adapter 54Vdc from POE
Modulation Type	256QAM, 64QAM, 16QAM, QPSK, BPSK
Modulation Technology	OFDM
Transfer Rate	802.11a: 54/48/36/24/18/12/9/6Mbps 802.11n: up to 300Mbps 802.11ac: up to 866.7Mbps
Operating Frequency	5260~5320MHz, 5500~5720MHz
Number of Channel	5260~5320MHz: 802.11a, 802.11n (HT20), 802.11ac (VHT20): 4 802.11n (HT40), 802.11ac (VHT40): 2 802.11ac (VHT80): 1 5500~5720MHz: 802.11a, 802.11n (HT20), 802.11ac (VHT20): 12 802.11n (HT40), 802.11ac (VHT40): 6 802.11ac (VHT80): 3
Output Power	ML-2452-APA2-01, ML-2452-APA2-02 and ML-2452-HPA5-036 Ant.: CDD Mode: 5260~5320MHz: 223.583mW 5500~5720MHz: 237.173mW Beamforming Mode: 5260~5320MHz: 111.686mW 5500~5720MHz: 118.577mW ML-2452-HPAG4A6-01 Ant.: CDD Mode: 5260~5320MHz: 160.254mW 5500~5720MHz: 177.126mW Beamforming Mode: 5260~5320MHz: 80.168mW 5500~5720MHz: 88.512mW

Output Power	ML-2452-HPA6M4-S36 Ant.: CDD Mode: 5260~5320MHz: 171.483mW 5500~5720MHz: 177.126mW Beamforming Mode: 5260~5320MHz: 85.704mW 5500~5720MHz: 88.512mW ML-2452-PNL9M3-036 Ant.: CDD Mode: 5260~5320MHz: 81.379mW 5500~5720MHz: 83.293mW Beamforming Mode: 5260~5320MHz: 81.379mW 5500~5720MHz: 83.293mW ML-2452-PNL6M3-N36, ML-2452-PNA5-01R and ML-2452-PNA7-01R Ant.: CDD Mode: 5260~5320MHz: 67.770mW 5500~5720MHz: 79.152mW Beamforming Mode: 5260~5320MHz: 33.884mW 5500~5720MHz: 39.537mW ML-2452-PTA2M2-036 and ML-2452-PTA4M4-036 Ant.: CDD Mode: 5260~5320MHz: 181.928mW 5500~5720MHz: 204.004mW Beamforming Mode: 5260~5320MHz: 90.991mW 5500~5720MHz: 102.094mW
Antenna Type	Refer to Note
Antenna Connector	Refer to Note
Accessory Device	NA
Cable Supplied	NA

Note:

1. This report is prepared for FCC class II permissive change. The difference compared with the original report (BV ADT report no.: RF170609C20-1) is adding 5.26GHz to 5.32GHz and 5.50GHz to 5.72GHz by software.

2. The EUT incorporates a MIMO function. Physically, the EUT provides 2 completed transmitters and 2 receivers.

Modulation Mode	TX Function	Beamforming
802.11a	2TX	Not Support
802.11n (HT20)	2TX	Support
802.11n (HT40)	2TX	Support
802.11ac (VHT20)	2TX	Support
802.11ac (VHT40)	2TX	Support
802.11ac (VHT80)	2TX	Support

* The modulation and bandwidth are similar for 802.11n mode for 20MHz/40MHz and 802.11ac mode for 20MHz/40MHz, therefore investigated worst case to representative mode in test report. (Final test mode refer section 3.2.1)

* For 802.11n and 802.11ac, CDD mode and Beamforming mode are presented in power output test item. For other test items, CDD mode is the worst case for final tests after pretesting.

3. All models are listed as below. Model: AP3915e was chosen for final test.

Brand	Model	Difference
Extreme Networks	AP3915e	All models are electrically identical, only the cover printing is different.
	AP7632	

4. The EUT consumes power from the following adapter and POE. (Support unit only)

Adapter	
Brand	Powertron Electronics Corp.
Model	PA1024-120IB200
Input Power	100-240Vac, 50-60Hz, 0.6A.
Output Power	12Vdc, 2A, 24W Max
Power Line	1.5m power cable with one core attached on adapter

POE	
Brand	EnGenius
Model	EPA5006GP
Input Power	100-240Vac, 50-60Hz, 0.8A
Output Power	54Vdc, 0.6A Pin 4, 5: 54Vdc Pin 7, 8: Return

5. The following antennas were provided to the EUT.

No.	Function	Type	Manufacturer/ Vendor	Model	Gain (dBi)		Connector
					2.4GHz Band	5GHz Band	
1	WLAN	Dipole	Wha Yu	ML-2452-APA2-01	3.17	4.85	RP-SMA Male
2	WLAN	Dipole	Wha Yu	ML-2452-APA2-02	3	5	RP-SMA Male
3	WLAN	Dipole	Laird	ML-2452-HPA5-036	3	5	RP-SMA Male
4	WLAN	Dipole	Laird	ML-2452-HPAG4A6-01	4	7.3	N Male
5	WLAN	Dipole	Ventev	ML-2452-HPA6M4-S36	6.0	6.0	RP-SMA
6	WLAN	Panel	Laird	ML-2452-PNL9M3-036	11.0	10.7	RP-SMA Male
7	WLAN	Panel	Laird	ML-2452-PNL6M3-N36	6	6	N Male
8	WLAN	Panel	Laird	ML-2452-PNA5-01R	5.5	6	N Male
9	WLAN & BT LE & Zigbee	Panel	Laird	ML-2452-PNA7-01R	7.8	10.7	N Male
10	WLAN	Patch	Laird	ML-2452-PTA2M2-036	4	5	RP-SMA Male
11	WLAN	Patch	Laird	ML-2452-PTA4M4-036	5	6.6	RP-SMA Male
12	BT LE & Zigbee	Omni	Laird	ML-2499-HPA8-01	8	-	Fixed N-Male Std polarity

* ML-2452-PNL9M3-036 Ant. was cross-polarized antenna.

6. Power Setting as below.

ML-2452-APA2-01, ML-2452-APA2-02 and ML-2452-HPA5-036 Ant. (same power setting):

CDD Mode						
	802.11a	802.11n (HT20)		802.11n (HT40)		802.11ac (VHT80)
CH 52	19.5	19	CH 54	20.5	CH 58	16
CH 60	19.5	19	CH 62	17.5	CH 106	15
CH 64	19	19	CH 102	16.5	CH 122	21
CH 100	18.5	18.5	CH 110	20.5	CH 138	21
CH 116	19	19	CH 134	20		
CH 140	17.5	17	CH 142	20.5		
CH 144	18.5	18.5				
Beamforming Mode						
	802.11n (HT20)		802.11n (HT40)		802.11ac (VHT80)	
CH 52	19	CH 54	20.5	CH 58	16	
CH 60	19	CH 62	17.5	CH 106	15	
CH 64	19	CH 102	16.5	CH 122	21	
CH 100	18.5	CH 110	20.5	CH 138	21	
CH 116	19	CH 134	20			
CH 140	17	CH 142	20.5			
CH 144	18.5					

ML-2452-HPAG4A6-01 Ant. (individual power setting):

CDD Mode						
	802.11a	802.11n (HT20)		802.11n (HT40)		802.11ac (VHT80)
CH 52	15.5	15.5	CH 54	18	CH 58	17
CH 60	15.5	15.5	CH 62	17.5	CH 106	16
CH 64	15.5	15.5	CH 102	17	CH 122	19.5
CH 100	14.5	14.5	CH 110	17	CH 138	19.5
CH 116	14	14.5	CH 134	18.5		
CH 140	16	16.5	CH 142	19		
CH 144	16.5	16.5				
Beamforming Mode						
	802.11n (HT20)		802.11n (HT40)		802.11ac (VHT80)	
CH 52	15.5	CH 54	18	CH 58	17	
CH 60	15.5	CH 62	17.5	CH 106	16	
CH 64	15.5	CH 102	17	CH 122	19.5	
CH 100	14.5	CH 110	17	CH 138	19.5	
CH 116	14.5	CH 134	18.5			
CH 140	16.5	CH 142	19			
CH 144	16.5					

ML-2452-HPA6M4-S36 Ant. (individual power setting):

CDD Mode						
	802.11a	802.11n (HT20)		802.11n (HT40)		802.11ac (VHT80)
CH 52	17	17.5	CH 54	19	CH 58	17
CH 60	17	17.5	CH 62	17.5	CH 106	16
CH 64	17	17.5	CH 102	17.5	CH 122	19.5
CH 100	15.5	16	CH 110	19	CH 138	19.5
CH 116	15.5	16	CH 134	19		
CH 140	17	18	CH 142	19		
CH 144	16.5	16.5				
Beamforming Mode						
	802.11n (HT20)		802.11n (HT40)		802.11ac (VHT80)	
CH 52	17.5	CH 54	19	CH 58	17	
CH 60	17.5	CH 62	17.5	CH 106	16	
CH 64	17.5	CH 102	17.5	CH 122	19.5	
CH 100	16	CH 110	19	CH 138	19.5	
CH 116	16	CH 134	19			
CH 140	18	CH 142	19			
CH 144	16.5					

ML-2452-PNL9M3-036 Ant. (individual power setting):

CDD Mode						
	802.11a	802.11n (HT20)		802.11n (HT40)		802.11ac (VHT80)
CH 52	14.5	15	CH 54	16	CH 58	16
CH 60	14.5	15	CH 62	16	CH 106	15
CH 64	15	15	CH 102	15.5	CH 122	16
CH 100	14.5	14.5	CH 110	16	CH 138	16
CH 116	14.5	14.5	CH 134	15.5		
CH 140	14.5	15	CH 142	15.5		
CH 144	15	15				
Beamforming Mode						
	802.11n (HT20)		802.11n (HT40)		802.11ac (VHT80)	
CH 52	15	CH 54	16	CH 58	16	
CH 60	15	CH 62	16	CH 106	15	
CH 64	15	CH 102	15.5	CH 122	16	
CH 100	14.5	CH 110	16	CH 138	16	
CH 116	14.5	CH 134	15.5			
CH 140	15	CH 142	15.5			
CH 144	15					

ML-2452-PNL6M3-N36, ML-2452-PNA5-01R and ML-2452-PNA7-01R Ant. (same power setting):

CDD Mode						
	802.11a	802.11n (HT20)		802.11n (HT40)		802.11ac (VHT80)
CH 52	12.5	13	CH 54	15	CH 58	15
CH 60	12.5	12.5	CH 62	14.5	CH 106	16
CH 64	12.5	12.5	CH 102	13.5	CH 122	16
CH 100	11	11.5	CH 110	14	CH 138	16
CH 116	11	11.5	CH 134	14.5		
CH 140	13	13.5	CH 142	15.5		
CH 144	13	13				
Beamforming Mode						
	802.11n (HT20)		802.11n (HT40)		802.11ac (VHT80)	
CH 52	13	CH 54	15	CH 58	15	
CH 60	12.5	CH 62	14.5	CH 106	16	
CH 64	12.5	CH 102	13.5	CH 122	16	
CH 100	11.5	CH 110	14	CH 138	16	
CH 116	11.5	CH 134	14.5			
CH 140	13.5	CH 142	15.5			
CH 144	13					

ML-2452-PTA2M2-036 and ML-2452-PTA4M4-036 Ant. (same power setting):

CDD Mode							
	802.11a	802.11n (HT20)		802.11n (HT40)		802.11ac (VHT80)	
CH 52	16.5	16.5	CH 54	19.5	CH 58	17.5	
CH 60	16.5	16.5	CH 62	19	CH 106	16	
CH 64	16.5	16.5	CH 102	16.5	CH 122	20.5	
CH 100	15	15	CH 110	18	CH 138	20.5	
CH 116	15	15.5	CH 134	19.5			
CH 140	16.5	16.5	CH 142	20			
CH 144	15.5	16					
Beamforming Mode							
	802.11n (HT20)			802.11n (HT40)		802.11ac (VHT80)	
CH 52	16.5		CH 54	19.5		CH 58 17.5	
CH 60	16.5		CH 62	19		CH 106 16	
CH 64	16.5		CH 102	16.5		CH 122 20.5	
CH 100	15		CH 110	18		CH 138 20.5	
CH 116	15.5		CH 134	19.5			
CH 140	16.5		CH 142	20			
CH 144	16						

7. 2.4GHz & 5GHz & BT LE or 2.4GHz & 5GHz & Zigbee technology can transmit at same time. BT LE and Zigbee cannot transmit simultaneously.
8. Spurious emission of the simultaneous operation (2.4GHz & 5GHz & BT LE or 2.4GHz & 5GHz & Zigbee) has been evaluated and no non-compliance was found.

3.2 Description of Test Modes

5260~5320MHz:

4 channels are provided for 802.11a, 802.11n (HT20), 802.11ac (VHT20):

Channel	Frequency	Channel	Frequency
52	5260 MHz	60	5300 MHz
56	5280 MHz	64	5320 MHz

2 channels are provided for 802.11n (HT40), 802.11ac (VHT40):

Channel	Frequency	Channel	Frequency
54	5270 MHz	62	5310 MHz

1 channel is provided for 802.11ac (VHT80):

Channel	Frequency
58	5290MHz

5500~5720MHz:

12 channels are provided for 802.11a, 802.11n (HT20), 802.11ac (VHT20):

Channel	Frequency	Channel	Frequency
100	5500 MHz	124	5620 MHz
104	5520 MHz	128	5640 MHz
108	5540 MHz	132	5660 MHz
112	5560 MHz	136	5680 MHz
116	5580 MHz	140	5700 MHz
120	5600 MHz	144	5720 MHz

6 channels are provided for 802.11n (HT40), 802.11ac (VHT40):

Channel	Frequency	Channel	Frequency
102	5510 MHz	126	5630 MHz
110	5550 MHz	134	5670 MHz
118	5590 MHz	142	5710 MHz

3 channels are provided for 802.11ac (VHT80):

Channel	Frequency	Channel	Frequency
106	5530 MHz	122	5610 MHz
138	5690 MHz		

3.2.1 Test Mode Applicability and Tested Channel Detail

EUT Configure Mode	Applicable to				Description
	RE \geq 1G	RE $<$ 1G	PLC	APCM	
A	-	√	√	-	EUT with ML-2452-APA2-02 Ant. power by adapter
B	√	√	√	√	EUT with ML-2452-APA2-02 Ant. power by POE
C	-	√	√	-	EUT with ML-2452-HPAG4A6-01 Ant. power by adapter
D	√	√	√	√	EUT with ML-2452-HPAG4A6-01 Ant. power by POE
E	-	-	-	√	EUT with ML-2452-HPA6M4-S36 Ant. power by POE
F	-	√	√	-	EUT with ML-2452-PNL9M3-036 Ant. power by adapter
G	√	√	√	√	EUT with ML-2452-PNL9M3-036 Ant. power by POE
H	-	√	√	-	EUT with ML-2452-PNA7-01R Ant. power by adapter
I	√	√	√	√	EUT with ML-2452-PNA7-01R Ant. power by POE
J	-	√	√	-	EUT with ML-2452-PTA4M4-036 Ant. power by adapter
K	√	√	√	√	EUT with ML-2452-PTA4M4-036 Ant. power by POE

Where RE \geq 1G: Radiated Emission above 1GHz & Bandedge Measurement
 RE $<$ 1G: Radiated Emission below 1GHz
 PLC: Power Line Conducted Emission
 APCM: Antenna Port Conducted Measurement

Note:

- The EUT had been pre-tested on the positioned of each 3 axis. The worst case was found when positioned on **Y-plane for test mode I and Z-plane for test mode B, D, G, K.**
- "-" means no effect.

Radiated Emission Test (Above 1GHz):

- Pre-Scan has been conducted to determine the worst-case mode from all possible combinations between available modulations, data rates and antenna ports (if EUT with antenna diversity architecture).
- Following channel(s) was (were) selected for the final test as listed below.

EUT Configure Mode	Mode	Frequency Band (MHz)	Available Channel	Tested Channel	Modulation Technology	Data Rate (Mbps)
B, D, G, I, K	802.11a	5260-5320	52 to 64	52, 60, 64	OFDM	6.0
	802.11n (HT20)		52 to 64	52, 60, 64	OFDM	6.5
	802.11n (HT40)		54 to 62	54, 62	OFDM	13.5
	802.11ac (VHT80)		58	58	OFDM	29.3
B, D, G, I, K	802.11a	5500-5720	100 to 144	100, 116, 140, 144	OFDM	6.0
	802.11n (HT20)		100 to 144	100, 116, 140, 144	OFDM	6.5
	802.11n (HT40)		102 to 142	102, 110, 134, 142	OFDM	13.5
	802.11ac (VHT80)		106 to 138	106, 122, 138	OFDM	29.3

Radiated Emission Test (Below 1GHz):

- Pre-Scan has been conducted to determine the worst-case mode from all possible combinations between available modulations, data rates and antenna ports (if EUT with antenna diversity architecture).
- Following channel(s) was (were) selected for the final test as listed below.

EUT Configure Mode	Mode	Frequency Band (MHz)	Available Channel	Tested Channel	Modulation Technology	Data Rate (Mbps)
A, B, C, D, F, G, H, I, J, K	802.11a	5260-5320	52 to 64	52	OFDM	6.0
	802.11a	5500-5720	100 to 144		OFDM	6.0

Power Line Conducted Emission Test:

- Pre-Scan has been conducted to determine the worst-case mode from all possible combinations between available modulations, data rates and antenna ports (if EUT with antenna diversity architecture).
- Following channel(s) was (were) selected for the final test as listed below.

EUT Configure Mode	Mode	Frequency Band (MHz)	Available Channel	Tested Channel	Modulation Technology	Data Rate (Mbps)
A, B, C, D, F, G, H, I, J, K	802.11a	5260-5320	52 to 64	52	OFDM	6.0
	802.11a	5500-5720	100 to 144		OFDM	6.0

Transmit Power Measurement:

- This item includes all test value of each mode, but only includes spectrum plot of worst value of each mode.
- Pre-Scan has been conducted to determine the worst-case mode from all possible combinations between available modulations, data rates and antenna ports (if EUT with antenna diversity architecture).
- Following channel(s) was (were) selected for the final test as listed below.

EUT Configure Mode	Mode	Frequency Band (MHz)	Available Channel	Tested Channel	Modulation Technology	Data Rate (Mbps)
CDD Mode						
B, D, E, G, I, K	802.11a	5260-5320	52 to 64	52, 60, 64	OFDM	6.0
	802.11n (HT20)		52 to 64	52, 60, 64	OFDM	6.5
	802.11n (HT40)		54 to 62	54, 62	OFDM	13.5
	802.11ac (VHT80)		58	58	OFDM	29.3
B, D, E, G, I, K	802.11a	5500-5720	100 to 144	100, 116, 140, 144	OFDM	6.0
	802.11n (HT20)		100 to 144	100, 116, 140, 144	OFDM	6.5
	802.11n (HT40)		102 to 142	102, 110, 134, 142	OFDM	13.5
	802.11ac (VHT80)		106 to 138	106, 122, 138	OFDM	29.3
Beamforming Mode						
B, D, E, G, I, K	802.11n (HT20)	5260-5320	52 to 64	52, 60, 64	OFDM	6.5
	802.11n (HT40)		54 to 62	54, 62	OFDM	13.5
	802.11ac (VHT80)		58	58	OFDM	29.3
B, D, E, G, I, K	802.11n (HT20)	5500-5720	100 to 144	100, 116, 140, 144	OFDM	6.5
	802.11n (HT40)		102 to 142	102, 110, 134, 142	OFDM	13.5
	802.11ac (VHT80)		106 to 138	106, 122, 138	OFDM	29.3

Peak Power Spectral Density, Bandwidth and Frequency Stability Measurement:

- This item includes all test value of each mode, but only includes spectrum plot of worst value of each mode.
- Pre-Scan has been conducted to determine the worst-case mode from all possible combinations between available modulations, data rates and antenna ports (if EUT with antenna diversity architecture).
- Following channel(s) was (were) selected for the final test as listed below.

EUT Configure Mode	Mode	Frequency Band (MHz)	Available Channel	Tested Channel	Modulation Technology	Data Rate (Mbps)
B, D, E, G, I, K	802.11a	5260-5320	52 to 64	52, 60, 64	OFDM	6.0
	802.11n (HT20)		52 to 64	52, 60, 64	OFDM	6.5
	802.11n (HT40)		54 to 62	54, 62	OFDM	13.5
	802.11ac (VHT80)		58	58	OFDM	29.3
B, D, E, G, I, K	802.11a	5500-5720	100 to 144	100, 116, 140, 144	OFDM	6.0
	802.11n (HT20)		100 to 144	100, 116, 140, 144	OFDM	6.5
	802.11n (HT40)		102 to 142	102, 110, 134, 142	OFDM	13.5
	802.11ac (VHT80)		106 to 138	106, 122, 138	OFDM	29.3

Test Condition:

Applicable to	Environmental Conditions	Input Power (System)	Tested by
RE_≥1G	28 deg. C, 68% RH 22 deg. C, 67% RH 25 deg. C, 69% RH 24 deg. C, 66% RH 26 deg. C, 69% RH 27 deg. C, 68% RH	120Vac, 60Hz	James Chang Jones Chang
RE<1G	23 deg. C, 64% RH 27 deg. C, 66% RH	120Vac, 60Hz 54Vdc	Jones Chang Willy Cheng
PLC	25 deg. C, 75% RH	120Vac, 60Hz 54Vdc	Luis Lee
APCM	25 deg. C, 60% RH	120Vac, 60Hz	Edward Lin Ted Chang Cedric Wu

3.3 Duty Cycle of Test Signal

Test Mode B

Duty cycle of test signal is < 98%, duty factor is required.

802.11a: Duty cycle = $2.018/2.107 = 0.958$, Duty factor = $10 * \log(1/0.958) = 0.19$

802.11n (HT20): Duty cycle = $4.935/5.040 = 0.979$, Duty factor = $10 * \log(1/0.979) = 0.09$

802.11n (HT40): Duty cycle = $2.397/2.502 = 0.958$, Duty factor = $10 * \log(1/0.958) = 0.19$

802.11ac (VHT80): Duty cycle = $1.127/1.222 = 0.922$, Duty factor = $10 * \log(1/0.922) = 0.35$

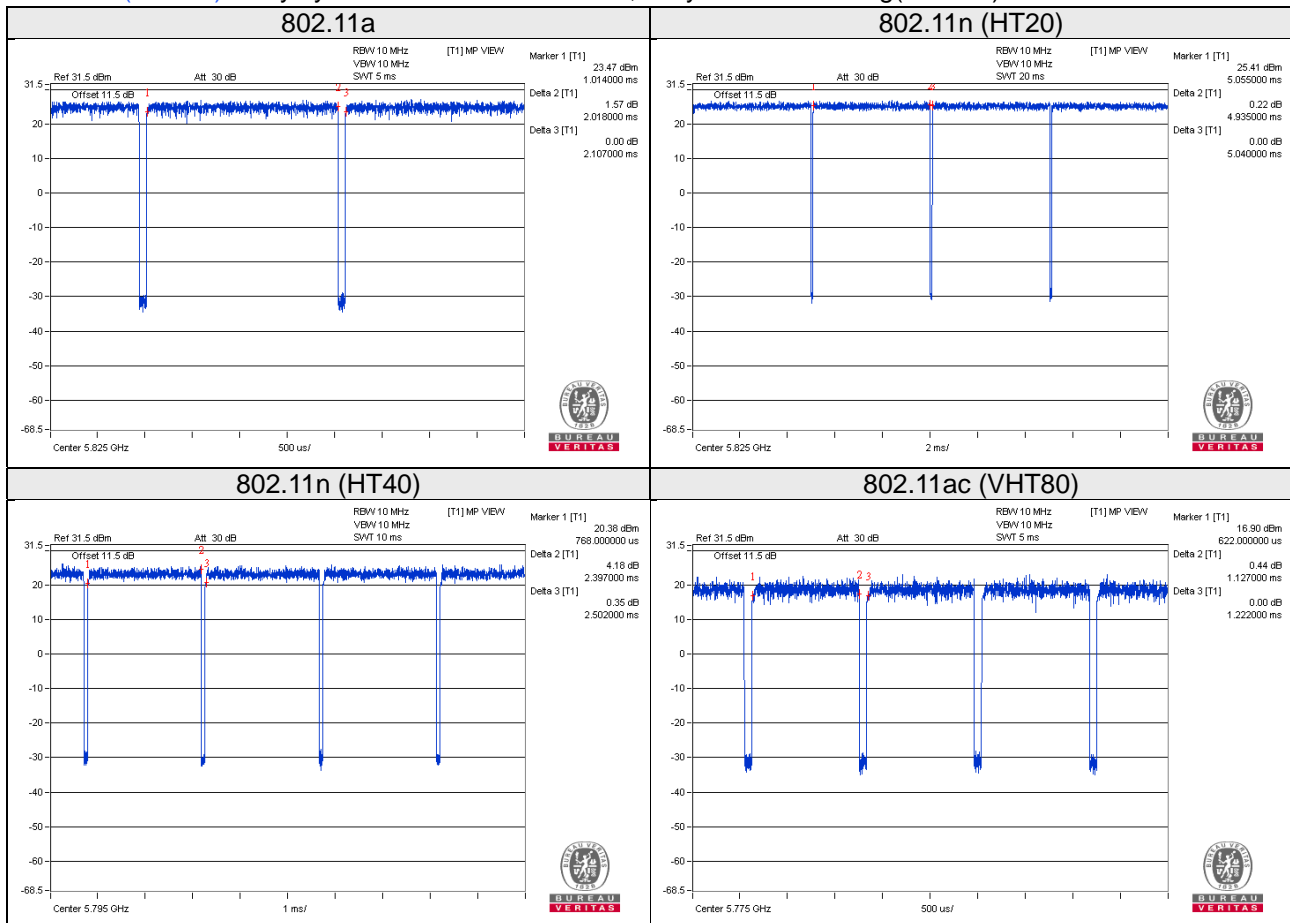

Test Mode D

802.11a, 802.11n (HT40), 802.11ac (VHT80): Duty cycle of test signal is < 98%, duty factor is required.

802.11n (HT20): Duty cycle of test signal is ≥ 98%, duty factor is not required.

802.11a: Duty cycle = $2.027/2.108 = 0.962$, Duty factor = $10 * \log(1/0.962) = 0.17$

802.11n (HT20): Duty cycle = $4.955/5.045 = 0.982$

802.11n (HT40): Duty cycle = $2.405/2.505 = 0.960$, Duty factor = $10 * \log(1/0.960) = 0.18$

802.11ac (VHT80): Duty cycle = $1.131/1.217 = 0.929$, Duty factor = $10 * \log(1/0.929) = 0.32$

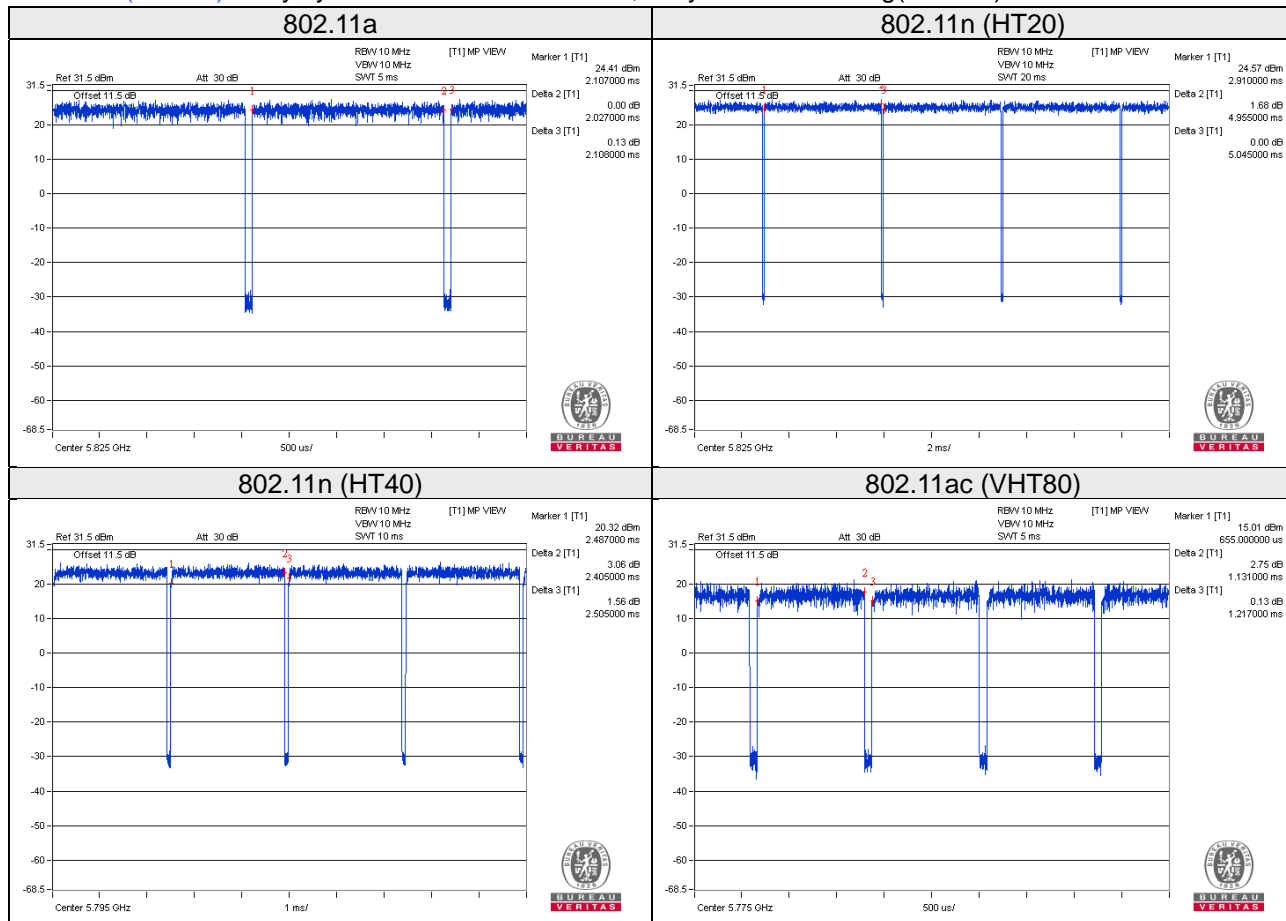

Test Mode E

802.11a, 802.11n (HT40), 802.11ac (VHT80): Duty cycle of test signal is < 98%, duty factor is required.

802.11n (HT20): Duty cycle of test signal is ≥ 98%, duty factor is not required.

802.11a: Duty cycle = 2.027/2.108 = 0.962, Duty factor = 10 * log(1/0.962) = 0.17

802.11n (HT20): Duty cycle = 4.955/5.045 = 0.982

802.11n (HT40): Duty cycle = 2.405/2.505 = 0.960, Duty factor = 10 * log(1/0.960) = 0.18

802.11ac (VHT80): Duty cycle = 1.131/1.217 = 0.929, Duty factor = 10 * log(1/0.929) = 0.32

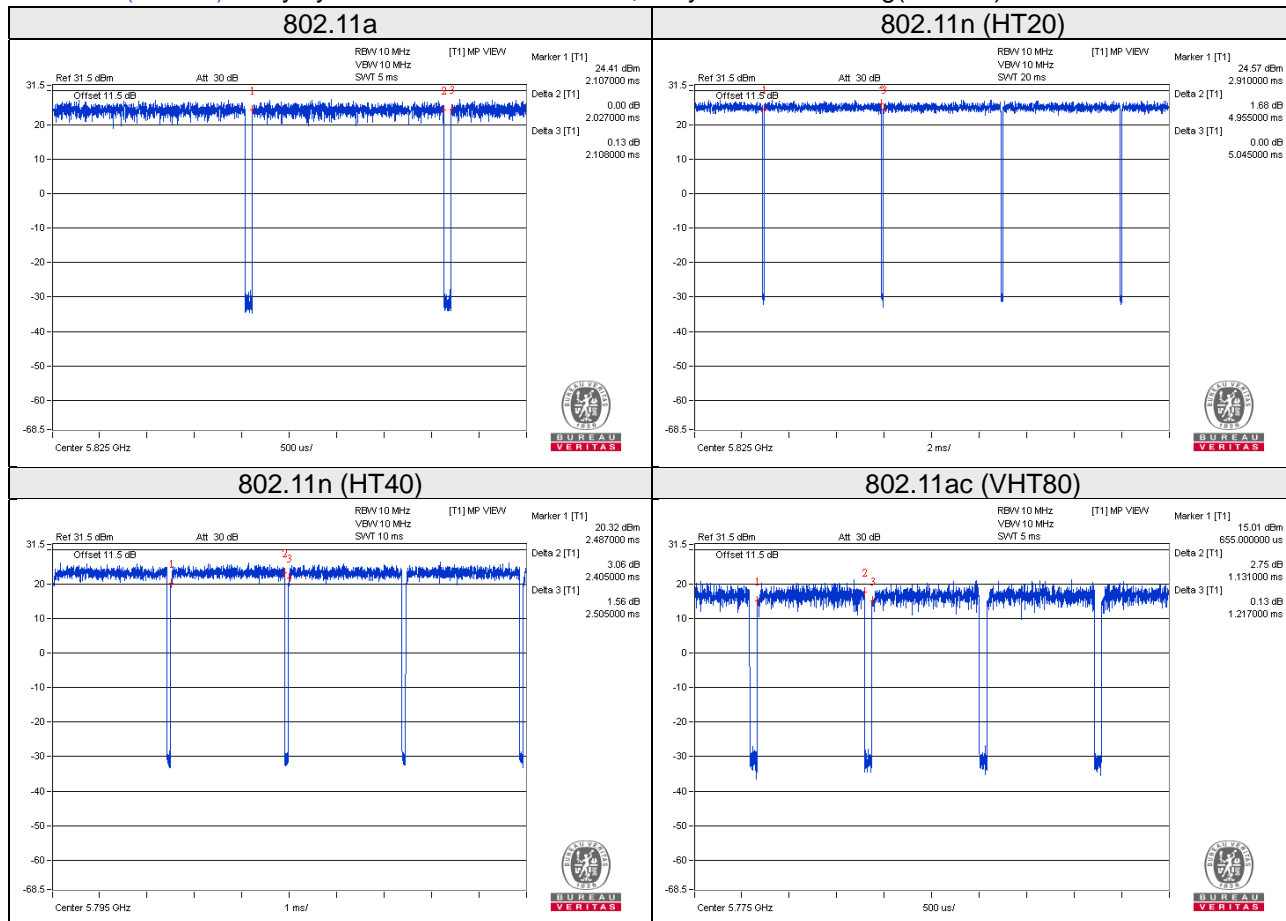

Test Mode G

802.11a, 802.11n (HT40), 802.11ac (VHT80): Duty cycle of test signal is < 98%, duty factor is required.

802.11n (HT20): Duty cycle of test signal is ≥ 98%, duty factor is not required.

802.11a: Duty cycle = $2.024/2.110 = 0.959$, Duty factor = $10 * \log(1/0.959) = 0.18$

802.11n (HT20): Duty cycle = $4.960/5.055 = 0.981$

802.11n (HT40): Duty cycle = $2.403/2.500 = 0.961$, Duty factor = $10 * \log(1/0.961) = 0.17$

802.11ac (VHT80): Duty cycle = $1.126/1.215 = 0.927$, Duty factor = $10 * \log(1/0.927) = 0.33$

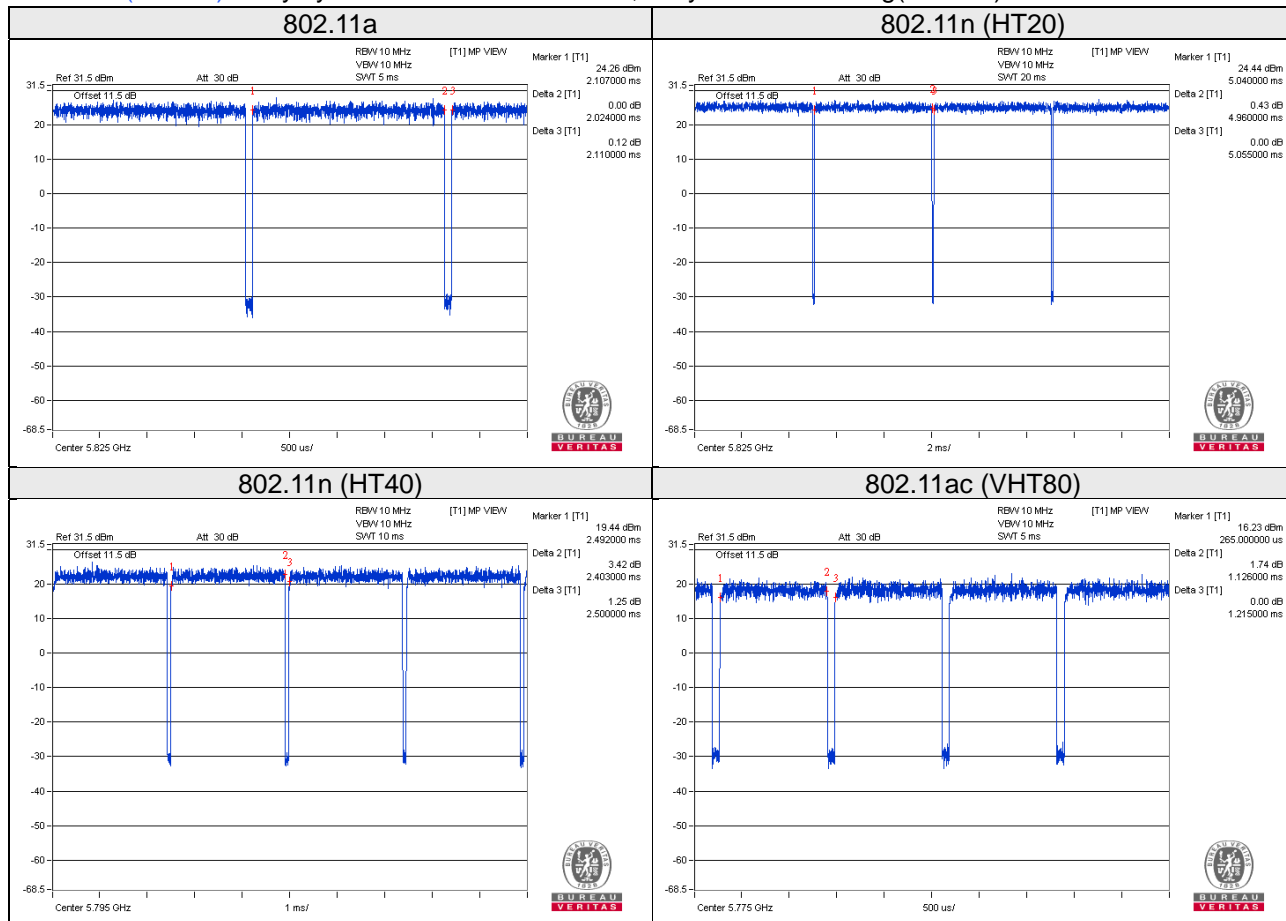

Test Mode I

802.11a, 802.11n (HT40), 802.11ac (VHT80): Duty cycle of test signal is < 98%, duty factor is required.

802.11n (HT20): Duty cycle of test signal is ≥ 98%, duty factor is not required.

802.11a: Duty cycle = 2.020/2.122 = 0.952, Duty factor = 10 * log(1/0.952) = 0.21

802.11n (HT20): Duty cycle = 4.955/5.055 = 0.980

802.11n (HT40): Duty cycle = 2.410/2.495 = 0.966, Duty factor = 10 * log(1/0.966) = 0.15

802.11ac (VHT80): Duty cycle = 1.131/1.222 = 0.927, Duty factor = 10 * log(1/0.927) = 0.33

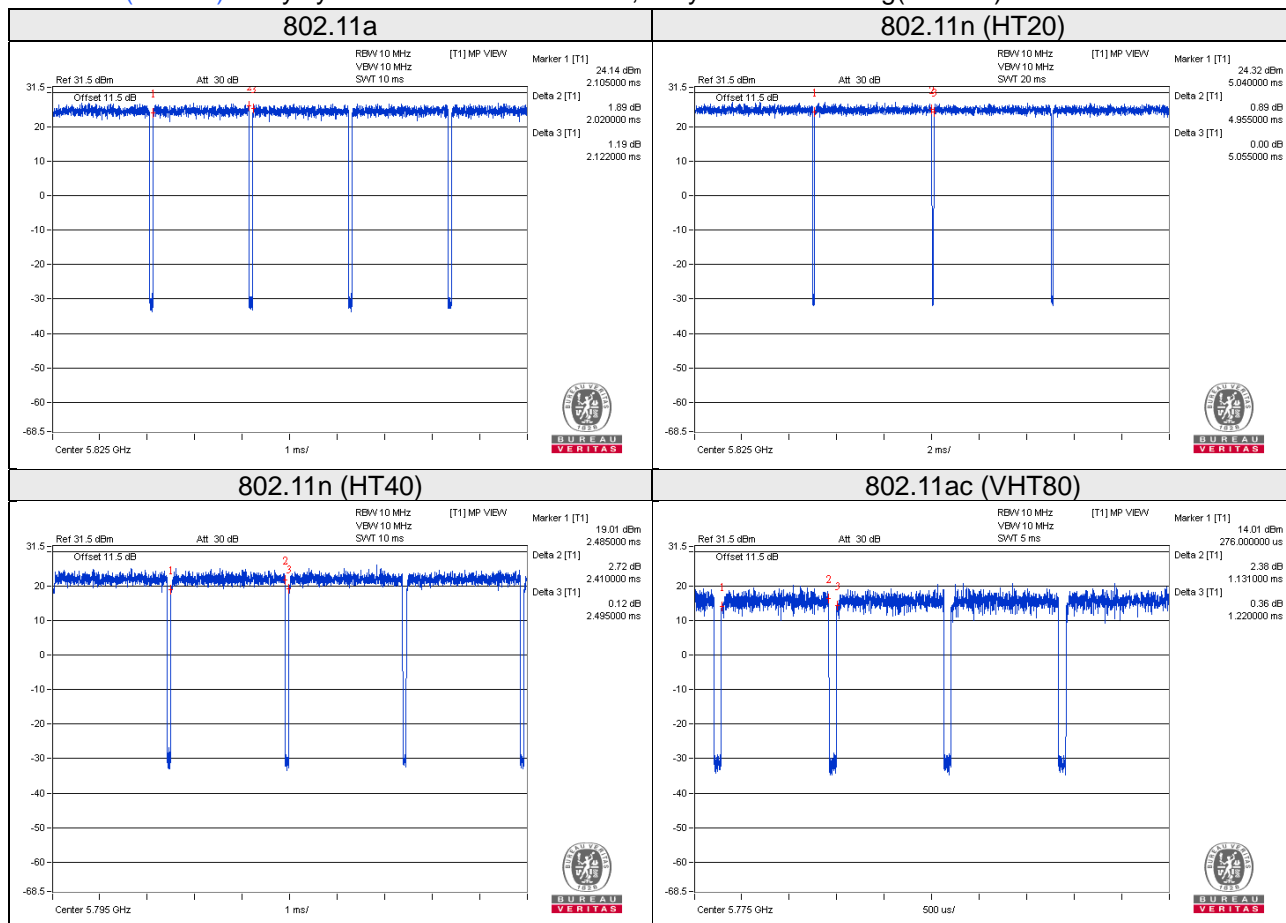

Test Mode K

802.11a, 802.11n (HT40), 802.11ac (VHT80): Duty cycle of test signal is < 98%, duty factor is required.

802.11n (HT20): Duty cycle of test signal is ≥ 98%, duty factor is not required.

802.11a: Duty cycle = 2.022/2.105 = 0.961, Duty factor = 10 * log(1/0.961) = 0.17

802.11n (HT20): Duty cycle = 4.950/5.048 = 0.981

802.11n (HT40): Duty cycle = 2.407/2.495 = 0.965, Duty factor = 10 * log(1/0.965) = 0.16

802.11ac (VHT80): Duty cycle = 1.127/1.220 = 0.924, Duty factor = 10 * log(1/0.924) = 0.34

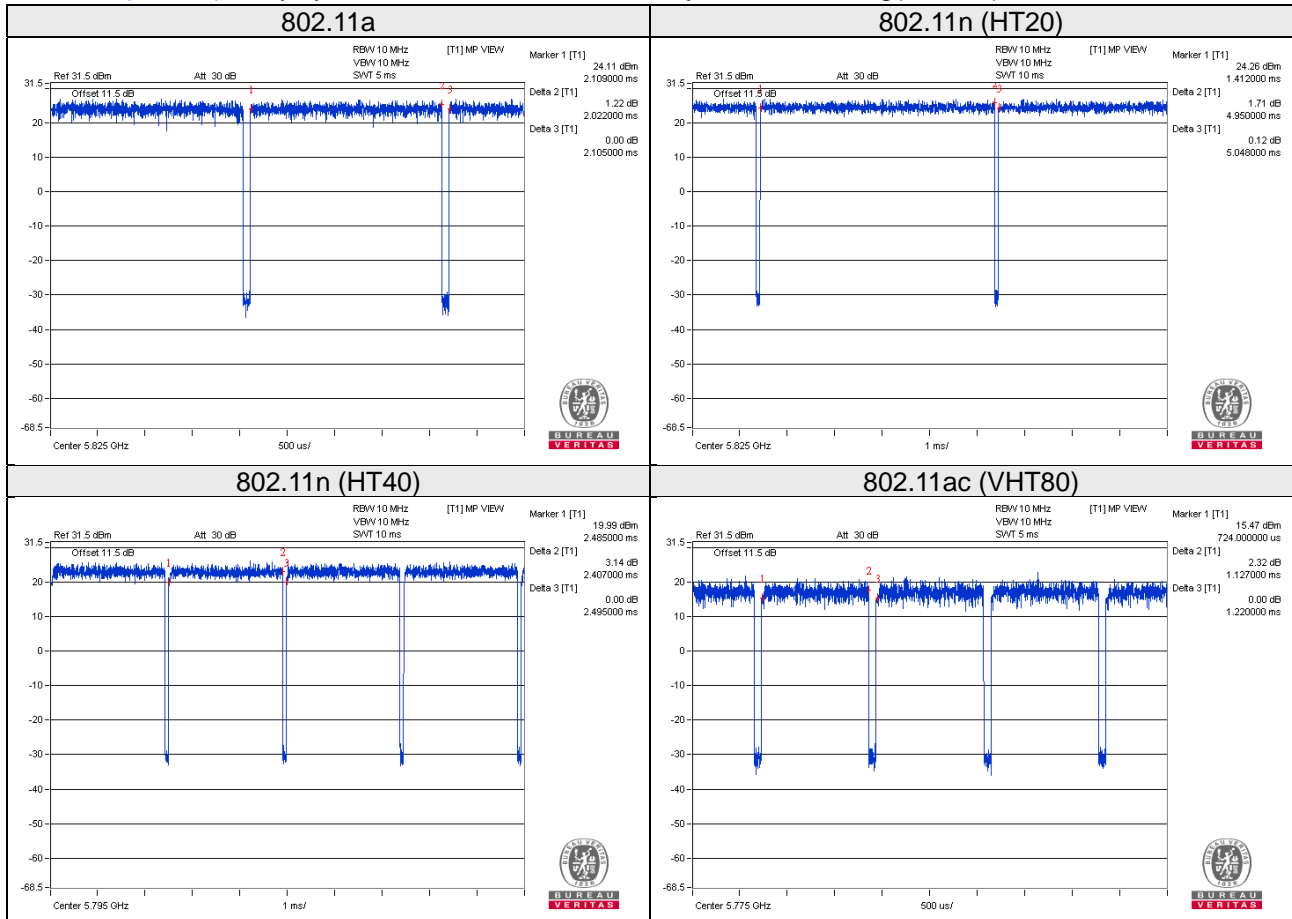

3.4 Description of Support Units

The EUT has been tested as an independent unit together with other necessary accessories or support units. The following support units or accessories were used to form a representative test configuration during the tests.

ID	Product	Brand	Model No.	Serial No.	FCC ID	Remarks
A.	Notebook	DELL	E5410	1HC2XM1	FCC DoC Approved	-
B.	USB Flash	HP	v250W	10	FCC DoC Approved	-
C.	Adapter	Powertron Electronics Corp.	PA1024-120IB200	NA	NA	Provided by manufacturer
D.	POE	EnGenius	EPA5006GP	NA	NA	Provided by manufacturer

Note:

1. All power cords of the above support units are non-shielded (1.8m).
2. Item A acted as a communication partner to transfer data.

ID	Descriptions	Qty.	Length (m)	Shielding (Yes/No)	Cores (Qty.)	Remarks
1.	RJ45, Cat5e	1	3	N	0	-
2.	RJ45, Cat5e	1	1.8	N	0	-
3.	Console cable	1	1	N	0	Provided by manufacturer
4.	Power cable	1	1.5	N	1	Provided by manufacturer

Note: The core(s) is(are) originally attached to the cable(s).

3.4.1 Configuration of System under Test

Adapter Mode

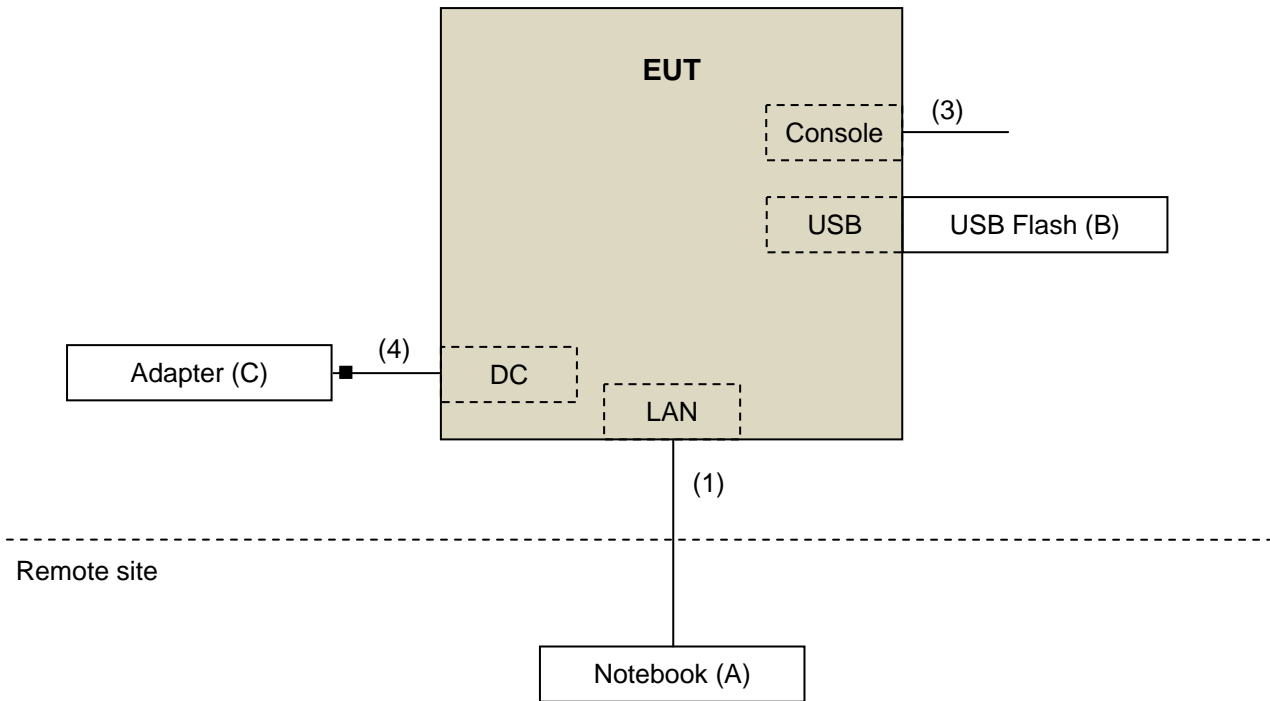

POE Mode

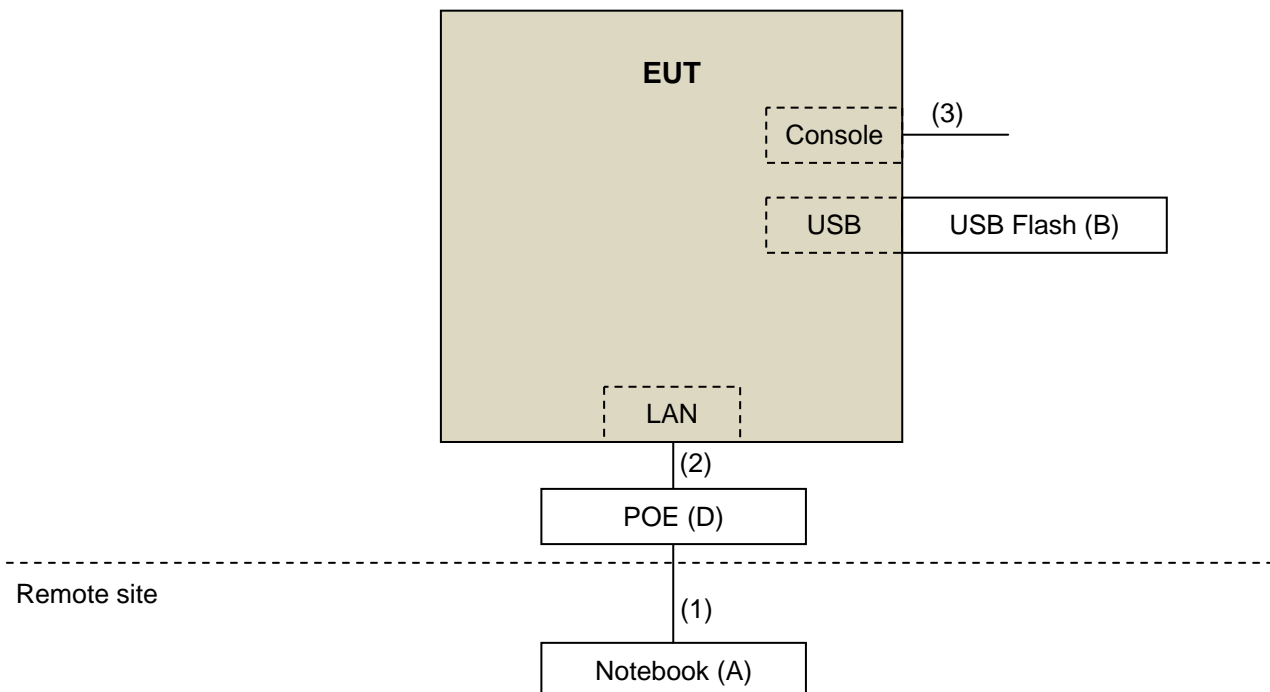

3.5 General Description of Applied Standards

The EUT is a RF Product. According to the specifications of the manufacturer, it must comply with the requirements of the following standards:

FCC Part 15, Subpart E (15.407)

KDB 789033 D02 General UNII Test Procedure New Rules v01r04

KDB 662911 D01 Multiple Transmitter Output v02r01

ANSI C63.10:2013

All test items have been performed and recorded as per the above standards.

Note: The EUT has been verified to comply with the requirements of FCC Part 15, Subpart B, Class B (DoC).
The test report has been issued separately.

4 Test Types and Results

4.1 Radiated Emission and Bandedge Measurement

4.1.1 Limits of Radiated Emission and Bandedge Measurement

Radiated emissions which fall in the restricted bands must comply with the radiated emission limits specified as below table.

Frequencies (MHz)	Field Strength (microvolts/meter)	Measurement Distance (meters)
0.009 ~ 0.490	2400/F(kHz)	300
0.490 ~ 1.705	24000/F(kHz)	30
1.705 ~ 30.0	30	30
30 ~ 88	100	3
88 ~ 216	150	3
216 ~ 960	200	3
Above 960	500	3

NOTE:

1. The lower limit shall apply at the transition frequencies.
2. Emission level (dBuV/m) = 20 log Emission level (uV/m).
3. For frequencies above 1000MHz, the field strength limits are based on average detector, however, the peak field strength of any emission shall not exceed the maximum permitted average limits, specified above by more than 20dB under any condition of modulation.

Limits of unwanted emission out of the restricted bands

Applicable To		Limit	
789033 D02 General UNII Test Procedure New Rules v01r04		Field Strength at 3m	
		PK: 74 (dBµV/m)	AV: 54 (dBµV/m)
Frequency Band	Applicable To	EIRP Limit	Equivalent Field Strength at 3m
5150~5250 MHz	15.407(b)(1)	PK: -27 (dBm/MHz)	PK: 68.2(dBµV/m)
5250~5350 MHz	15.407(b)(2)		
5470~5725 MHz	15.407(b)(3)		
5725~5850 MHz	<input checked="" type="checkbox"/> 15.407(b)(4)(i)	PK: -27 (dBm/MHz) ^{*1} PK: 10 (dBm/MHz) ^{*2} PK: 15.6 (dBm/MHz) ^{*3} PK: 27 (dBm/MHz) ^{*4}	PK: 68.2(dBµV/m) ^{*1} PK: 105.2 (dBµV/m) ^{*2} PK: 110.8(dBµV/m) ^{*3} PK: 122.2 (dBµV/m) ^{*4}
	<input type="checkbox"/> 15.407(b)(4)(ii)	Emission limits in section 15.247(d)	
^{*1} beyond 75 MHz or more above of the band edge.		^{*2} below the band edge increasing linearly to 10 dBm/MHz at 25 MHz above.	
^{*3} below the band edge increasing linearly to a level of 15.6 dBm/MHz at 5 MHz above.		^{*4} from 5 MHz above or below the band edge increasing linearly to a level of 27 dBm/MHz at the band edge.	

Note: The following formula is used to convert the equipment isotropic radiated power (eirp) to field strength:

$$E = \frac{1000000 \sqrt{30P}}{3} \mu\text{V/m, where P is the eirp (Watts).}$$

4.1.2 Test Instruments

Description & Manufacturer	Model No.	Serial No.	Cal. Date	Cal. Due
Test Receiver ROHDE & SCHWARZ	ESIB7	100187	May 02, 2017	May 01, 2018
Spectrum Analyzer ROHDE & SCHWARZ	FSP40	100041	Nov. 16, 2016	Nov. 15, 2017
BILOG Antenna SCHWARZBECK	VULB9168	9168-171	Dec. 28, 2016	Dec. 27, 2017
HORN Antenna SCHWARZBECK	9120D	209	Dec. 27, 2016	Dec. 26, 2017
HORN Antenna SCHWARZBECK	BBHA 9170	BBHA9170241	Dec. 14, 2016	Dec. 13, 2017
Loop Antenna	EM-6879	269	Aug. 11, 2016	Aug. 10, 2017
Preamplifier Agilent	8447D	2944A10738	Aug. 22, 2016	Aug. 21, 2017
Preamplifier Agilent	8449B	3008A01922	Sep. 18, 2016	Sep. 17, 2017
RF signal cable HUBER+SUHNER	SUCOFLEX 104	Cable-CH3-03 (214378)	Aug. 22, 2016	Aug. 21, 2017
RF signal cable HUBER+SUHNER	SUCOFLEX 106	Cable-CH3-03 (309224+12738)	Aug. 22, 2016	Aug. 21, 2017
Software BV ADT	ADT_Radiated_ V7.6.15.9.4	NA	NA	NA
Antenna Tower inn-co GmbH	MA 4000	013303	NA	NA
Antenna Tower Controller BV ADT	AT100	AT93021702	NA	NA
Turn Table BV ADT	TT100	TT93021702	NA	NA
Turn Table Controller BV ADT	SC100	SC93021702	NA	NA
26GHz ~ 40GHz Amplifier	EM26400	815221	Oct. 17, 2016	Oct. 16, 2017
High Speed Peak Power Meter	ML2495A	0824012	Aug. 11, 2016	Aug. 10, 2017
Power Sensor	MA2411B	0738171	Aug. 11, 2016	Aug. 10, 2017
WIT Standard Temperature And Humidity Chamber	TH-4S-C	W981030	Jun. 08, 2017	Jun. 07, 2018

- Note: 1. The calibration interval of the above test instruments is 12 months and the calibrations are traceable to NML/ROC and NIST/USA.
2. The test was performed in HwaYa Chamber 3.
3. The horn antenna and preamplifier (model: 8449B) are used only for the measurement of emission frequency above 1GHz if tested.
4. The FCC Designation Number is TW0003. The number will be varied with the Lab location and scope as attached.
5. The IC Site Registration No. is IC 7450F-3.

4.1.3 Test Procedures

For Radiated emission below 30MHz

- a. The EUT was placed on the top of a rotating table 0.8 meters above the ground at a 3 meter chamber room. The table was rotated 360 degrees to determine the position of the highest radiation.
- b. The EUT was set 3 meters away from the interference-receiving antenna, which was mounted on the top of a variable-height antenna tower.
- c. Both X and Y axes of the antenna are set to make the measurement.
- d. For each suspected emission, the EUT was arranged to its worst case and the rotatable table was turned from 0 degrees to 360 degrees to find the maximum reading.
- e. The test-receiver system was set to Quasi-Peak Detect Function and Specified Bandwidth with Maximum Hold Mode.

Note:

1. The resolution bandwidth and video bandwidth of test receiver/spectrum analyzer is 9kHz at frequency below 30MHz.

For Radiated emission above 30MHz

- a. The EUT was placed on the top of a rotating table 0.8 meters (for 30MHz ~ 1GHz) / 1.5 meters (for above 1GHz) above the ground at 3 meter chamber room for test. The table was rotated 360 degrees to determine the position of the highest radiation.
- b. The EUT was set 3 meters away from the interference-receiving antenna, which was mounted on the top of a variable-height antenna tower.
- c. The height of antenna is varied from one meter to four meters above the ground to determine the maximum value of the field strength. Both horizontal and vertical polarizations of the antenna are set to make the measurement.
- d. For each suspected emission, the EUT was arranged to its worst case and then the antenna was tuned to heights from 1 meter to 4 meters and the rotatable table was turned from 0 degrees to 360 degrees to find the maximum reading.
- e. The test-receiver system was set to quasi-peak detect function and specified bandwidth with maximum hold mode when the test frequency is below 1 GHz.
- f. The test-receiver system was set to peak and average detect function and specified bandwidth with maximum hold mode when the test frequency is above 1 GHz. If the peak reading value also meets average limit, measurement with the average detector is unnecessary.

Note:

1. The resolution bandwidth and video bandwidth of test receiver/spectrum analyzer is 120kHz for Quasi-peak detection (QP) at frequency below 1GHz.
2. The resolution bandwidth of test receiver/spectrum analyzer is 1 MHz and the video bandwidth is 3 MHz for Peak detection (PK) at frequency above 1GHz.
3. The resolution bandwidth of test receiver/spectrum analyzer is 1MHz and the video bandwidth is $\geq 1/T$ (Duty cycle < 98%) or 10Hz (Duty cycle $\geq 98\%$) for Average detection (AV) at frequency above 1GHz.
4. All modes of operation were investigated and the worst-case emissions are reported.

4.1.4 Deviation from Test Standard

No deviation.

4.1.5 Test Setup

For Radiated emission below 30MHz

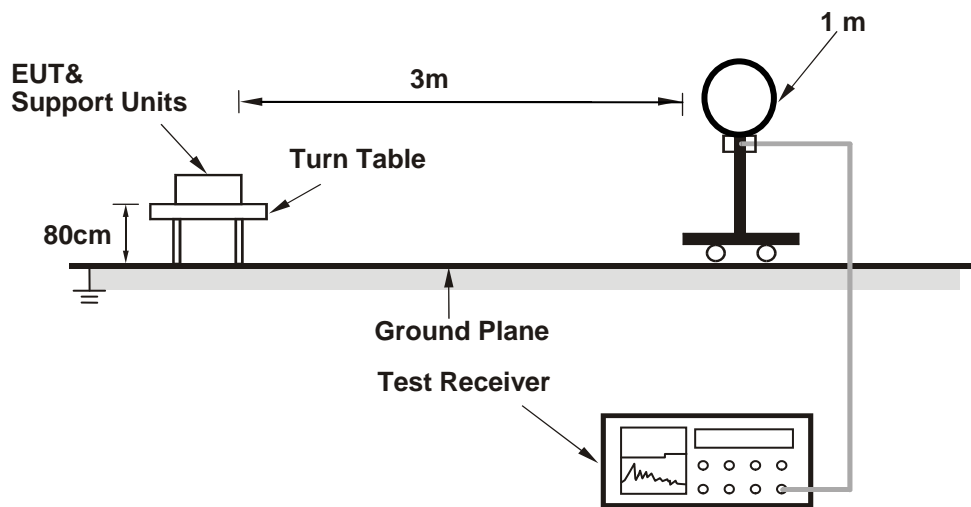

For Radiated emission 30MHz to 1GHz

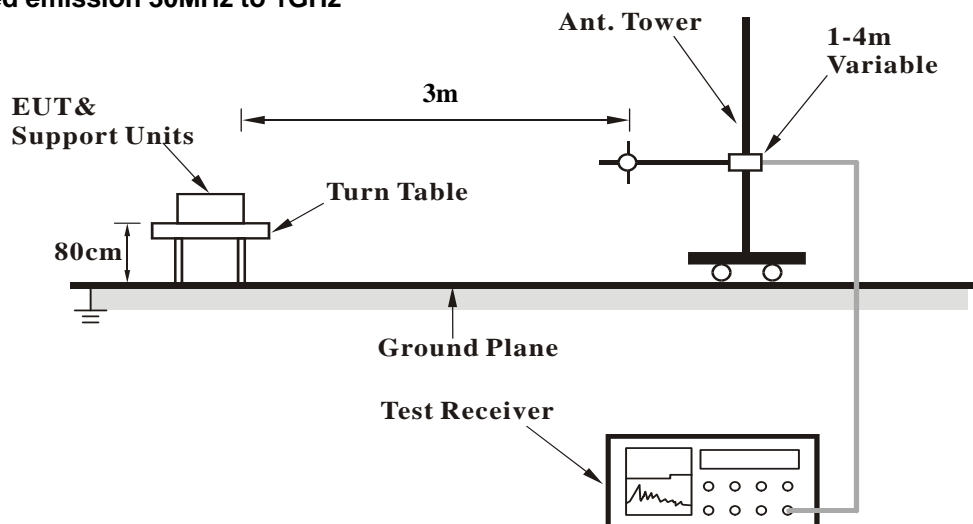

For Radiated emission above 1GHz

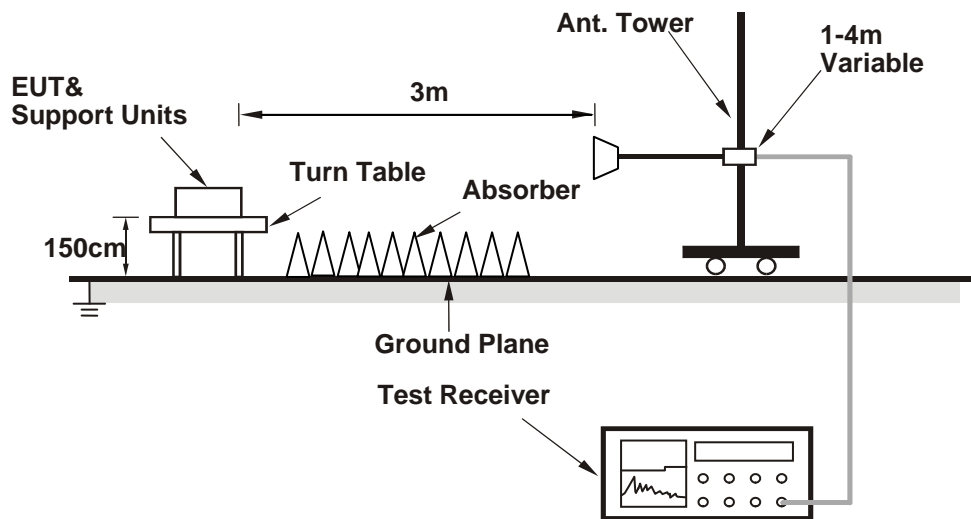

For the actual test configuration, please refer to the attached file (Test Setup Photo).

4.1.6 EUT Operating Conditions

- a. Placed the EUT on the testing table.
- b. Prepared a notebook to act as a communication partner and placed it outside of testing area.
- c. The communication partner connected with EUT via a RJ45 cable and ran a test program (provided by manufacturer) to enable EUT under transmission condition continuously at specific channel frequency.
- d. The communication partner sent data to EUT by command "PING".
- e. The necessary accessories enable the system in full functions.

4.1.7 Test Results

Above 1GHz data:

Test Mode B

802.11a

CHANNEL	TX Channel 52	DETECTOR FUNCTION	Peak (PK)
FREQUENCY RANGE	1GHz ~ 40GHz		Average (AV)

ANTENNA POLARITY & TEST DISTANCE: HORIZONTAL AT 3 M								
NO.	FREQ. (MHz)	EMISSION LEVEL (dBuV/m)	LIMIT (dBuV/m)	MARGIN (dB)	ANTENNA HEIGHT (m)	TABLE ANGLE (Degree)	RAW VALUE (dBuV)	CORRECTION FACTOR (dB/m)
1	5150.00	55.4 PK	74.0	-18.6	2.21 H	336	54.6	0.8
2	5150.00	42.1 AV	54.0	-11.9	2.21 H	336	41.3	0.8
3	*5260.00	104.2 PK			1.26 H	359	65.4	38.8
4	*5260.00	93.9 AV			1.26 H	359	55.1	38.8
5	5350.00	56.1 PK	74.0	-17.9	2.23 H	126	55.0	1.1
6	5350.00	42.9 AV	54.0	-11.1	2.23 H	126	41.8	1.1
7	#10520.00	58.2 PK	74.0	-15.8	1.63 H	233	44.5	13.7
8	#10520.00	44.7 AV	54.0	-9.3	1.63 H	233	31.0	13.7

ANTENNA POLARITY & TEST DISTANCE: VERTICAL AT 3 M								
NO.	FREQ. (MHz)	EMISSION LEVEL (dBuV/m)	LIMIT (dBuV/m)	MARGIN (dB)	ANTENNA HEIGHT (m)	TABLE ANGLE (Degree)	RAW VALUE (dBuV)	CORRECTION FACTOR (dB/m)
1	5150.00	56.9 PK	74.0	-17.1	1.60 V	296	56.1	0.8
2	5150.00	44.4 AV	54.0	-9.6	1.60 V	296	43.6	0.8
3	*5260.00	122.7 PK			1.57 V	299	83.9	38.8
4	*5260.00	112.1 AV			1.57 V	299	73.3	38.8
5	5350.00	57.4 PK	74.0	-16.6	1.72 V	35	56.3	1.1
6	5350.00	45.4 AV	54.0	-8.6	1.72 V	35	44.3	1.1
7	#10520.00	58.5 PK	74.0	-15.5	1.31 V	263	44.8	13.7
8	#10520.00	45.1 AV	54.0	-8.9	1.31 V	263	31.4	13.7

Remarks:

1. Emission Level(dBuV/m) = Raw Value(dBuV) + Correction Factor(dB/m)
2. Correction Factor(dB/m) = Antenna Factor(dB/m) + Cable Factor(dB) – Pre-Amplifier Factor(dB)
3. The other emission levels were very low against the limit.
4. Margin value = Emission Level – Limit value
5. " * ": Fundamental frequency.
6. " # ": The radiated frequency is out of the restricted band.

CHANNEL	TX Channel 60	DETECTOR FUNCTION	Peak (PK)
FREQUENCY RANGE	1GHz ~ 40GHz		Average (AV)

ANTENNA POLARITY & TEST DISTANCE: HORIZONTAL AT 3 M								
NO.	FREQ. (MHz)	EMISSION LEVEL (dBuV/m)	LIMIT (dBuV/m)	MARGIN (dB)	ANTENNA HEIGHT (m)	TABLE ANGLE (Degree)	RAW VALUE (dBuV)	CORRECTION FACTOR (dB/m)
1	*5300.00	105.7 PK			1.63 H	39	66.8	38.9
2	*5300.00	94.9 AV			1.63 H	39	56.0	38.9
3	5350.00	56.0 PK	74.0	-18.0	1.44 H	138	54.9	1.1
4	5350.00	42.7 AV	54.0	-11.3	1.44 H	138	41.6	1.1
5	10600.00	58.9 PK	74.0	-15.1	1.55 H	163	45.1	13.8
6	10600.00	44.9 AV	54.0	-9.1	1.55 H	163	31.1	13.8
ANTENNA POLARITY & TEST DISTANCE: VERTICAL AT 3 M								
NO.	FREQ. (MHz)	EMISSION LEVEL (dBuV/m)	LIMIT (dBuV/m)	MARGIN (dB)	ANTENNA HEIGHT (m)	TABLE ANGLE (Degree)	RAW VALUE (dBuV)	CORRECTION FACTOR (dB/m)
1	*5300.00	122.1 PK			1.63 V	299	83.2	38.9
2	*5300.00	111.5 AV			1.63 V	299	72.6	38.9
3	5350.00	62.0 PK	74.0	-12.0	1.77 V	284	60.9	1.1
4	5350.00	48.9 AV	54.0	-5.1	1.77 V	284	47.8	1.1
5	10600.00	59.0 PK	74.0	-15.0	1.96 V	284	45.2	13.8
6	10600.00	45.1 AV	54.0	-8.9	1.96 V	284	31.3	13.8

Remarks:

1. Emission Level(dBuV/m) = Raw Value(dBuV) + Correction Factor(dB/m)
2. Correction Factor(dB/m) = Antenna Factor(dB/m) + Cable Factor(dB) – Pre-Amplifier Factor(dB)
3. The other emission levels were very low against the limit.
4. Margin value = Emission Level – Limit value
5. " * ": Fundamental frequency.
6. " # ": The radiated frequency is out of the restricted band.

CHANNEL	TX Channel 64	DETECTOR FUNCTION	Peak (PK)
FREQUENCY RANGE	1GHz ~ 40GHz		Average (AV)

ANTENNA POLARITY & TEST DISTANCE: HORIZONTAL AT 3 M								
NO.	FREQ. (MHz)	EMISSION LEVEL (dBuV/m)	LIMIT (dBuV/m)	MARGIN (dB)	ANTENNA HEIGHT (m)	TABLE ANGLE (Degree)	RAW VALUE (dBuV)	CORRECTION FACTOR (dB/m)
1	*5320.00	101.5 PK			1.22 H	11	62.5	39.0
2	*5320.00	90.7 AV			1.22 H	11	51.7	39.0
3	5350.00	56.4 PK	74.0	-17.6	1.63 H	8	55.3	1.1
4	5350.00	42.9 AV	54.0	-11.1	1.63 H	8	41.8	1.1
5	10640.00	58.4 PK	74.0	-15.6	1.36 H	129	44.5	13.9
6	10640.00	44.4 AV	54.0	-9.6	1.36 H	129	30.5	13.9
ANTENNA POLARITY & TEST DISTANCE: VERTICAL AT 3 M								
NO.	FREQ. (MHz)	EMISSION LEVEL (dBuV/m)	LIMIT (dBuV/m)	MARGIN (dB)	ANTENNA HEIGHT (m)	TABLE ANGLE (Degree)	RAW VALUE (dBuV)	CORRECTION FACTOR (dB/m)
1	*5320.00	118.2 PK			1.53 V	294	79.2	39.0
2	*5320.00	108.1 AV			1.53 V	294	69.1	39.0
3	5350.00	66.6 PK	74.0	-7.4	1.56 V	286	65.5	1.1
4	5350.00	52.5 AV	54.0	-1.5	1.56 V	286	51.4	1.1
5	10640.00	57.5 PK	74.0	-16.5	2.09 V	234	43.6	13.9
6	10640.00	44.5 AV	54.0	-9.5	2.09 V	234	30.6	13.9

Remarks:

1. Emission Level(dBuV/m) = Raw Value(dBuV) + Correction Factor(dB/m)
2. Correction Factor(dB/m) = Antenna Factor(dB/m) + Cable Factor(dB) – Pre-Amplifier Factor(dB)
3. The other emission levels were very low against the limit.
4. Margin value = Emission Level – Limit value
5. " * ": Fundamental frequency.
6. " # ": The radiated frequency is out of the restricted band.

CHANNEL	TX Channel 100	DETECTOR FUNCTION	Peak (PK)
FREQUENCY RANGE	1GHz ~ 40GHz		Average (AV)

ANTENNA POLARITY & TEST DISTANCE: HORIZONTAL AT 3 M								
NO.	FREQ. (MHz)	EMISSION LEVEL (dBuV/m)	LIMIT (dBuV/m)	MARGIN (dB)	ANTENNA HEIGHT (m)	TABLE ANGLE (Degree)	RAW VALUE (dBuV)	CORRECTION FACTOR (dB/m)
1	5460.00	56.5 PK	74.0	-17.5	1.33 H	81	55.3	1.2
2	5460.00	43.1 AV	54.0	-10.9	1.33 H	81	41.9	1.2
3	#5470.00	58.9 PK	74.0	-15.1	1.57 H	33	57.7	1.2
4	#5470.00	44.6 AV	54.0	-9.4	1.57 H	33	43.4	1.2
5	*5500.00	106.9 PK			3.30 H	204	67.6	39.3
6	*5500.00	96.0 AV			3.30 H	204	56.7	39.3
7	11000.00	60.4 PK	74.0	-13.6	1.42 H	138	45.1	15.3
8	11000.00	46.4 AV	54.0	-7.6	1.42 H	138	31.1	15.3
ANTENNA POLARITY & TEST DISTANCE: VERTICAL AT 3 M								
NO.	FREQ. (MHz)	EMISSION LEVEL (dBuV/m)	LIMIT (dBuV/m)	MARGIN (dB)	ANTENNA HEIGHT (m)	TABLE ANGLE (Degree)	RAW VALUE (dBuV)	CORRECTION FACTOR (dB/m)
1	5460.00	63.3 PK	74.0	-10.7	2.02 V	290	62.1	1.2
2	5460.00	47.7 AV	54.0	-6.3	2.02 V	290	46.5	1.2
3	#5470.00	69.7 PK	74.0	-4.3	2.35 V	298	68.5	1.2
4	#5470.00	52.8 AV	54.0	-1.2	2.35 V	298	51.6	1.2
5	*5500.00	116.2 PK			2.51 V	354	76.9	39.3
6	*5500.00	105.6 AV			2.51 V	354	66.3	39.3
7	11000.00	60.3 PK	74.0	-13.7	1.53 V	248	45.0	15.3
8	11000.00	46.5 AV	54.0	-7.5	1.53 V	248	31.2	15.3

Remarks:

1. Emission Level(dBuV/m) = Raw Value(dBuV) + Correction Factor(dB/m)
2. Correction Factor(dB/m) = Antenna Factor(dB/m) + Cable Factor(dB) – Pre-Amplifier Factor(dB)
3. The other emission levels were very low against the limit.
4. Margin value = Emission Level – Limit value
5. " * ": Fundamental frequency.
6. " # ": The radiated frequency is out of the restricted band.

CHANNEL	TX Channel 116	DETECTOR FUNCTION	Peak (PK)
FREQUENCY RANGE	1GHz ~ 40GHz		Average (AV)

ANTENNA POLARITY & TEST DISTANCE: HORIZONTAL AT 3 M

NO.	FREQ. (MHz)	EMISSION LEVEL (dBuV/m)	LIMIT (dBuV/m)	MARGIN (dB)	ANTENNA HEIGHT (m)	TABLE ANGLE (Degree)	RAW VALUE (dBuV)	CORRECTION FACTOR (dB/m)
1	*5580.00	108.9 PK			2.92 H	198	69.4	39.5
2	*5580.00	98.8 AV			2.92 H	198	59.3	39.5
3	11160.00	59.7 PK	74.0	-14.3	1.64 H	142	44.8	14.9
4	11160.00	46.2 AV	54.0	-7.8	1.64 H	142	31.3	14.9

ANTENNA POLARITY & TEST DISTANCE: VERTICAL AT 3 M

NO.	FREQ. (MHz)	EMISSION LEVEL (dBuV/m)	LIMIT (dBuV/m)	MARGIN (dB)	ANTENNA HEIGHT (m)	TABLE ANGLE (Degree)	RAW VALUE (dBuV)	CORRECTION FACTOR (dB/m)
1	*5580.00	118.6 PK			2.55 V	266	79.1	39.5
2	*5580.00	107.8 AV			2.55 V	266	68.3	39.5
3	11160.00	60.1 PK	74.0	-13.9	2.23 V	279	45.2	14.9
4	11160.00	46.2 AV	54.0	-7.8	2.23 V	279	31.3	14.9

Remarks:

1. Emission Level(dBuV/m) = Raw Value(dBuV) + Correction Factor(dB/m)
2. Correction Factor(dB/m) = Antenna Factor(dB/m) + Cable Factor(dB) – Pre-Amplifier Factor(dB)
3. The other emission levels were very low against the limit.
4. Margin value = Emission Level – Limit value
5. " * ": Fundamental frequency.
6. " # ": The radiated frequency is out of the restricted band.

CHANNEL	TX Channel 140	DETECTOR FUNCTION	Peak (PK)
FREQUENCY RANGE	1GHz ~ 40GHz		Average (AV)

ANTENNA POLARITY & TEST DISTANCE: HORIZONTAL AT 3 M								
NO.	FREQ. (MHz)	EMISSION LEVEL (dBuV/m)	LIMIT (dBuV/m)	MARGIN (dB)	ANTENNA HEIGHT (m)	TABLE ANGLE (Degree)	RAW VALUE (dBuV)	CORRECTION FACTOR (dB/m)
1	*5700.00	103.7 PK			2.37 H	217	63.9	39.8
2	*5700.00	93.0 AV			2.37 H	217	53.2	39.8
3	#5725.00	55.8 PK	74.0	-18.2	1.70 H	209	53.8	2.0
4	#5725.00	44.2 AV	54.0	-9.8	1.70 H	209	42.2	2.0
5	11400.00	61.4 PK	74.0	-12.6	1.98 H	207	46.9	14.5
6	11400.00	47.1 AV	54.0	-6.9	1.98 H	207	32.6	14.5
ANTENNA POLARITY & TEST DISTANCE: VERTICAL AT 3 M								
NO.	FREQ. (MHz)	EMISSION LEVEL (dBuV/m)	LIMIT (dBuV/m)	MARGIN (dB)	ANTENNA HEIGHT (m)	TABLE ANGLE (Degree)	RAW VALUE (dBuV)	CORRECTION FACTOR (dB/m)
1	*5700.00	115.1 PK			2.29 V	287	75.3	39.8
2	*5700.00	104.1 AV			2.29 V	287	64.3	39.8
3	#5725.00	67.5 PK	74.0	-6.5	2.39 V	75	65.5	2.0
4	#5725.00	52.5 AV	54.0	-1.5	2.39 V	75	50.5	2.0
5	11400.00	60.5 PK	74.0	-13.5	2.11 V	198	46.0	14.5
6	11400.00	46.9 AV	54.0	-7.1	2.11 V	198	32.4	14.5

Remarks:

1. Emission Level(dBuV/m) = Raw Value(dBuV) + Correction Factor(dB/m)
2. Correction Factor(dB/m) = Antenna Factor(dB/m) + Cable Factor(dB) – Pre-Amplifier Factor(dB)
3. The other emission levels were very low against the limit.
4. Margin value = Emission Level – Limit value
5. " * ": Fundamental frequency.
6. " # ": The radiated frequency is out of the restricted band.

CHANNEL	TX Channel 144	DETECTOR FUNCTION	Peak (PK)
FREQUENCY RANGE	1GHz ~ 40GHz		Average (AV)

ANTENNA POLARITY & TEST DISTANCE: HORIZONTAL AT 3 M

NO.	FREQ. (MHz)	EMISSION LEVEL (dBuV/m)	LIMIT (dBuV/m)	MARGIN (dB)	ANTENNA HEIGHT (m)	TABLE ANGLE (Degree)	RAW VALUE (dBuV)	CORRECTION FACTOR (dB/m)
1	#5470.00	54.9 PK	74.0	-19.1	2.21 H	144	53.7	1.2
2	#5470.00	42.7 AV	54.0	-11.3	2.21 H	144	41.5	1.2
3	*5720.00	108.8 PK			2.47 H	133	68.9	39.9
4	*5720.00	98.3 AV			2.47 H	133	58.4	39.9
5	#5850.00	56.1 PK	74.0	-17.9	2.77 H	212	53.8	2.3
6	#5850.00	43.2 AV	54.0	-10.8	2.77 H	212	40.9	2.3
7	11440.00	60.2 PK	74.0	-13.8	1.85 H	139	45.7	14.5
8	11440.00	46.9 AV	54.0	-7.1	1.85 H	139	32.4	14.5

ANTENNA POLARITY & TEST DISTANCE: VERTICAL AT 3 M

NO.	FREQ. (MHz)	EMISSION LEVEL (dBuV/m)	LIMIT (dBuV/m)	MARGIN (dB)	ANTENNA HEIGHT (m)	TABLE ANGLE (Degree)	RAW VALUE (dBuV)	CORRECTION FACTOR (dB/m)
1	#5470.00	55.4 PK	74.0	-18.6	1.37 V	222	54.2	1.2
2	#5470.00	43.0 AV	54.0	-11.0	1.37 V	222	41.8	1.2
3	*5720.00	122.1 PK			2.25 V	50	82.2	39.9
4	*5720.00	111.4 AV			2.25 V	50	71.5	39.9
5	#5850.00	56.5 PK	74.0	-17.5	2.41 V	287	54.2	2.3
6	#5850.00	43.9 AV	54.0	-10.1	2.41 V	287	41.6	2.3
7	11440.00	60.2 PK	74.0	-13.8	1.71 V	111	45.7	14.5
8	11440.00	47.2 AV	54.0	-6.8	1.71 V	111	32.7	14.5

Remarks:

1. Emission Level(dBuV/m) = Raw Value(dBuV) + Correction Factor(dB/m)
2. Correction Factor(dB/m) = Antenna Factor(dB/m) + Cable Factor(dB) – Pre-Amplifier Factor(dB)
3. The other emission levels were very low against the limit.
4. Margin value = Emission Level – Limit value
5. " * ": Fundamental frequency.
6. " # ": The radiated frequency is out of the restricted band.

802.11n (HT20)

CHANNEL	TX Channel 52	DETECTOR FUNCTION	Peak (PK) Average (AV)
FREQUENCY RANGE	1GHz ~ 40GHz		

ANTENNA POLARITY & TEST DISTANCE: HORIZONTAL AT 3 M

NO.	FREQ. (MHz)	EMISSION LEVEL (dBuV/m)	LIMIT (dBuV/m)	MARGIN (dB)	ANTENNA HEIGHT (m)	TABLE ANGLE (Degree)	RAW VALUE (dBuV)	CORRECTION FACTOR (dB/m)
1	5150.00	55.3 PK	74.0	-18.7	1.12 H	231	54.5	0.8
2	5150.00	42.0 AV	54.0	-12.0	1.12 H	231	41.2	0.8
3	*5260.00	104.3 PK			1.26 H	358	65.5	38.8
4	*5260.00	93.4 AV			1.26 H	358	54.6	38.8
5	5350.00	56.0 PK	74.0	-18.0	1.47 H	111	54.9	1.1
6	5350.00	42.7 AV	54.0	-11.3	1.47 H	111	41.6	1.1
7	#10520.00	58.5 PK	74.0	-15.5	1.94 H	163	44.8	13.7
8	#10520.00	44.7 AV	54.0	-9.3	1.94 H	163	31.0	13.7

ANTENNA POLARITY & TEST DISTANCE: VERTICAL AT 3 M

NO.	FREQ. (MHz)	EMISSION LEVEL (dBuV/m)	LIMIT (dBuV/m)	MARGIN (dB)	ANTENNA HEIGHT (m)	TABLE ANGLE (Degree)	RAW VALUE (dBuV)	CORRECTION FACTOR (dB/m)
1	5150.00	56.9 PK	74.0	-17.1	1.52 V	232	56.1	0.8
2	5150.00	44.2 AV	54.0	-9.8	1.52 V	232	43.4	0.8
3	*5260.00	122.5 PK			1.63 V	297	83.7	38.8
4	*5260.00	111.6 AV			1.63 V	297	72.8	38.8
5	5350.00	57.4 PK	74.0	-16.6	1.64 V	296	56.3	1.1
6	5350.00	45.4 AV	54.0	-8.6	1.64 V	296	44.3	1.1
7	#10520.00	58.4 PK	74.0	-15.6	2.09 V	256	44.7	13.7
8	#10520.00	45.4 AV	54.0	-8.6	2.09 V	256	31.7	13.7

Remarks:

1. Emission Level(dBuV/m) = Raw Value(dBuV) + Correction Factor(dB/m)
2. Correction Factor(dB/m) = Antenna Factor(dB/m) + Cable Factor(dB) – Pre-Amplifier Factor(dB)
3. The other emission levels were very low against the limit.
4. Margin value = Emission Level – Limit value
5. " * ": Fundamental frequency.
6. " # ": The radiated frequency is out of the restricted band.

CHANNEL	TX Channel 60	DETECTOR FUNCTION	Peak (PK)
FREQUENCY RANGE	1GHz ~ 40GHz		Average (AV)

ANTENNA POLARITY & TEST DISTANCE: HORIZONTAL AT 3 M								
NO.	FREQ. (MHz)	EMISSION LEVEL (dBuV/m)	LIMIT (dBuV/m)	MARGIN (dB)	ANTENNA HEIGHT (m)	TABLE ANGLE (Degree)	RAW VALUE (dBuV)	CORRECTION FACTOR (dB/m)
1	*5300.00	103.8 PK			1.27 H	31	64.9	38.9
2	*5300.00	93.3 AV			1.27 H	31	54.4	38.9
3	5350.00	55.9 PK	74.0	-18.1	1.67 H	197	54.8	1.1
4	5350.00	42.7 AV	54.0	-11.3	1.67 H	197	41.6	1.1
5	10600.00	58.4 PK	74.0	-15.6	2.01 H	248	44.6	13.8
6	10600.00	45.0 AV	54.0	-9.0	2.01 H	248	31.2	13.8

ANTENNA POLARITY & TEST DISTANCE: VERTICAL AT 3 M								
NO.	FREQ. (MHz)	EMISSION LEVEL (dBuV/m)	LIMIT (dBuV/m)	MARGIN (dB)	ANTENNA HEIGHT (m)	TABLE ANGLE (Degree)	RAW VALUE (dBuV)	CORRECTION FACTOR (dB/m)
1	*5300.00	121.9 PK			1.56 V	299	83.0	38.9
2	*5300.00	111.0 AV			1.56 V	299	72.1	38.9
3	5350.00	66.8 PK	74.0	-7.2	1.55 V	302	65.7	1.1
4	5350.00	49.3 AV	54.0	-4.7	1.55 V	302	48.2	1.1
5	10600.00	58.3 PK	74.0	-15.7	2.28 V	193	44.5	13.8
6	10600.00	45.3 AV	54.0	-8.7	2.28 V	193	31.5	13.8

Remarks:

1. Emission Level(dBuV/m) = Raw Value(dBuV) + Correction Factor(dB/m)
2. Correction Factor(dB/m) = Antenna Factor(dB/m) + Cable Factor(dB) – Pre-Amplifier Factor(dB)
3. The other emission levels were very low against the limit.
4. Margin value = Emission Level – Limit value
5. " * ": Fundamental frequency.
6. " # ": The radiated frequency is out of the restricted band.

CHANNEL	TX Channel 64	DETECTOR FUNCTION	Peak (PK)
FREQUENCY RANGE	1GHz ~ 40GHz		Average (AV)

ANTENNA POLARITY & TEST DISTANCE: HORIZONTAL AT 3 M								
NO.	FREQ. (MHz)	EMISSION LEVEL (dBuV/m)	LIMIT (dBuV/m)	MARGIN (dB)	ANTENNA HEIGHT (m)	TABLE ANGLE (Degree)	RAW VALUE (dBuV)	CORRECTION FACTOR (dB/m)
1	*5320.00	102.4 PK			1.23 H	1	63.4	39.0
2	*5320.00	90.9 AV			1.23 H	1	51.9	39.0
3	5350.00	56.1 PK	74.0	-17.9	1.29 H	237	55.0	1.1
4	5350.00	42.9 AV	54.0	-11.1	1.29 H	237	41.8	1.1
5	10640.00	57.7 PK	74.0	-16.3	1.14 H	226	43.8	13.9
6	10640.00	44.5 AV	54.0	-9.5	1.14 H	226	30.6	13.9

ANTENNA POLARITY & TEST DISTANCE: VERTICAL AT 3 M								
NO.	FREQ. (MHz)	EMISSION LEVEL (dBuV/m)	LIMIT (dBuV/m)	MARGIN (dB)	ANTENNA HEIGHT (m)	TABLE ANGLE (Degree)	RAW VALUE (dBuV)	CORRECTION FACTOR (dB/m)
1	*5320.00	118.9 PK			1.54 V	294	79.9	39.0
2	*5320.00	108.3 AV			1.54 V	294	69.3	39.0
3	5350.00	68.0 PK	74.0	-6.0	1.55 V	304	66.9	1.1
4	5350.00	52.5 AV	54.0	-1.5	1.55 V	304	51.4	1.1
5	10640.00	57.9 PK	74.0	-16.1	2.09 V	234	44.0	13.9
6	10640.00	44.6 AV	54.0	-9.4	2.09 V	234	30.7	13.9

Remarks:

1. Emission Level(dBuV/m) = Raw Value(dBuV) + Correction Factor(dB/m)
2. Correction Factor(dB/m) = Antenna Factor(dB/m) + Cable Factor(dB) – Pre-Amplifier Factor(dB)
3. The other emission levels were very low against the limit.
4. Margin value = Emission Level – Limit value
5. " * ": Fundamental frequency.
6. " # ": The radiated frequency is out of the restricted band.

CHANNEL	TX Channel 100	DETECTOR FUNCTION	Peak (PK)
FREQUENCY RANGE	1GHz ~ 40GHz		Average (AV)

ANTENNA POLARITY & TEST DISTANCE: HORIZONTAL AT 3 M								
NO.	FREQ. (MHz)	EMISSION LEVEL (dBuV/m)	LIMIT (dBuV/m)	MARGIN (dB)	ANTENNA HEIGHT (m)	TABLE ANGLE (Degree)	RAW VALUE (dBuV)	CORRECTION FACTOR (dB/m)
1	5460.00	56.0 PK	74.0	-18.0	2.01 H	112	54.8	1.2
2	5460.00	42.6 AV	54.0	-11.4	2.01 H	112	41.4	1.2
3	#5470.00	59.7 PK	74.0	-14.3	2.46 H	172	58.5	1.2
4	#5470.00	44.9 AV	54.0	-9.1	2.46 H	172	43.7	1.2
5	*5500.00	108.7 PK			3.83 H	207	69.4	39.3
6	*5500.00	97.6 AV			3.83 H	207	58.3	39.3
7	11000.00	60.2 PK	74.0	-13.8	1.42 H	179	44.9	15.3
8	11000.00	46.5 AV	54.0	-7.5	1.42 H	179	31.2	15.3

ANTENNA POLARITY & TEST DISTANCE: VERTICAL AT 3 M								
NO.	FREQ. (MHz)	EMISSION LEVEL (dBuV/m)	LIMIT (dBuV/m)	MARGIN (dB)	ANTENNA HEIGHT (m)	TABLE ANGLE (Degree)	RAW VALUE (dBuV)	CORRECTION FACTOR (dB/m)
1	5460.00	61.7 PK	74.0	-12.3	2.58 V	291	60.5	1.2
2	5460.00	48.1 AV	54.0	-5.9	2.58 V	291	46.9	1.2
3	#5470.00	68.8 PK	74.0	-5.2	2.44 V	353	67.6	1.2
4	#5470.00	52.4 AV	54.0	-1.6	2.44 V	353	51.2	1.2
5	*5500.00	116.3 PK			2.52 V	35	77.0	39.3
6	*5500.00	105.6 AV			2.52 V	35	66.3	39.3
7	11000.00	61.3 PK	74.0	-12.7	1.99 V	188	46.0	15.3
8	11000.00	47.8 AV	54.0	-6.2	1.99 V	188	32.5	15.3

Remarks:

1. Emission Level(dBuV/m) = Raw Value(dBuV) + Correction Factor(dB/m)
2. Correction Factor(dB/m) = Antenna Factor(dB/m) + Cable Factor(dB) – Pre-Amplifier Factor(dB)
3. The other emission levels were very low against the limit.
4. Margin value = Emission Level – Limit value
5. " * ": Fundamental frequency.
6. " # ": The radiated frequency is out of the restricted band.

CHANNEL	TX Channel 116	DETECTOR FUNCTION	Peak (PK)
FREQUENCY RANGE	1GHz ~ 40GHz		Average (AV)

ANTENNA POLARITY & TEST DISTANCE: HORIZONTAL AT 3 M								
NO.	FREQ. (MHz)	EMISSION LEVEL (dBuV/m)	LIMIT (dBuV/m)	MARGIN (dB)	ANTENNA HEIGHT (m)	TABLE ANGLE (Degree)	RAW VALUE (dBuV)	CORRECTION FACTOR (dB/m)
1	*5580.00	114.1 PK			3.78 H	198	74.6	39.5
2	*5580.00	102.8 AV			3.78 H	198	63.3	39.5
3	11160.00	59.8 PK	74.0	-14.2	1.88 H	223	44.9	14.9
4	11160.00	46.2 AV	54.0	-7.8	1.88 H	223	31.3	14.9
ANTENNA POLARITY & TEST DISTANCE: VERTICAL AT 3 M								
NO.	FREQ. (MHz)	EMISSION LEVEL (dBuV/m)	LIMIT (dBuV/m)	MARGIN (dB)	ANTENNA HEIGHT (m)	TABLE ANGLE (Degree)	RAW VALUE (dBuV)	CORRECTION FACTOR (dB/m)
1	*5580.00	119.2 PK			2.55 V	80	79.7	39.5
2	*5580.00	107.8 AV			2.55 V	80	68.3	39.5
3	11160.00	59.7 PK	74.0	-14.3	2.23 V	178	44.8	14.9
4	11160.00	46.1 AV	54.0	-7.9	2.23 V	178	31.2	14.9

Remarks:

1. Emission Level(dBuV/m) = Raw Value(dBuV) + Correction Factor(dB/m)
2. Correction Factor(dB/m) = Antenna Factor(dB/m) + Cable Factor(dB) – Pre-Amplifier Factor(dB)
3. The other emission levels were very low against the limit.
4. Margin value = Emission Level – Limit value
5. " * ": Fundamental frequency.
6. " # ": The radiated frequency is out of the restricted band.

CHANNEL	TX Channel 140	DETECTOR FUNCTION	Peak (PK)
FREQUENCY RANGE	1GHz ~ 40GHz		Average (AV)

ANTENNA POLARITY & TEST DISTANCE: HORIZONTAL AT 3 M								
NO.	FREQ. (MHz)	EMISSION LEVEL (dBuV/m)	LIMIT (dBuV/m)	MARGIN (dB)	ANTENNA HEIGHT (m)	TABLE ANGLE (Degree)	RAW VALUE (dBuV)	CORRECTION FACTOR (dB/m)
1	*5700.00	104.7 PK			3.03 H	198	64.9	39.8
2	*5700.00	93.4 AV			3.03 H	198	53.6	39.8
3	#5725.00	55.1 PK	74.0	-18.9	1.84 H	222	53.1	2.0
4	#5725.00	43.3 AV	54.0	-10.7	1.84 H	222	41.3	2.0
5	11400.00	61.0 PK	74.0	-13.0	1.93 H	269	46.5	14.5
6	11400.00	47.2 AV	54.0	-6.8	1.93 H	269	32.7	14.5
ANTENNA POLARITY & TEST DISTANCE: VERTICAL AT 3 M								
NO.	FREQ. (MHz)	EMISSION LEVEL (dBuV/m)	LIMIT (dBuV/m)	MARGIN (dB)	ANTENNA HEIGHT (m)	TABLE ANGLE (Degree)	RAW VALUE (dBuV)	CORRECTION FACTOR (dB/m)
1	*5700.00	115.0 PK			2.28 V	68	75.2	39.8
2	*5700.00	104.0 AV			2.28 V	68	64.2	39.8
3	#5725.00	66.7 PK	74.0	-7.3	2.39 V	75	64.7	2.0
4	#5725.00	52.6 AV	54.0	-1.4	2.39 V	75	50.6	2.0
5	11140.00	61.3 PK	74.0	-12.7	2.05 V	136	46.5	14.8
6	11140.00	47.4 AV	54.0	-6.6	2.05 V	136	32.6	14.8

Remarks:

1. Emission Level(dBuV/m) = Raw Value(dBuV) + Correction Factor(dB/m)
2. Correction Factor(dB/m) = Antenna Factor(dB/m) + Cable Factor(dB) – Pre-Amplifier Factor(dB)
3. The other emission levels were very low against the limit.
4. Margin value = Emission Level – Limit value
5. " * ": Fundamental frequency.
6. " # ": The radiated frequency is out of the restricted band.

CHANNEL	TX Channel 144	DETECTOR FUNCTION	Peak (PK)
FREQUENCY RANGE	1GHz ~ 40GHz		Average (AV)

ANTENNA POLARITY & TEST DISTANCE: HORIZONTAL AT 3 M

NO.	FREQ. (MHz)	EMISSION LEVEL (dBuV/m)	LIMIT (dBuV/m)	MARGIN (dB)	ANTENNA HEIGHT (m)	TABLE ANGLE (Degree)	RAW VALUE (dBuV)	CORRECTION FACTOR (dB/m)
1	#5470.00	55.0 PK	74.0	-19.0	2.49 H	146	53.8	1.2
2	#5470.00	42.7 AV	54.0	-11.3	2.49 H	146	41.5	1.2
3	*5720.00	109.1 PK			2.47 H	137	69.2	39.9
4	*5720.00	98.1 AV			2.47 H	137	58.2	39.9
5	#5850.00	55.2 PK	74.0	-18.8	2.63 H	208	52.9	2.3
6	#5850.00	43.4 AV	54.0	-10.6	2.63 H	208	41.1	2.3
7	11440.00	60.3 PK	74.0	-13.7	1.82 H	113	45.8	14.5
8	11440.00	46.6 AV	54.0	-7.4	1.82 H	113	32.1	14.5

ANTENNA POLARITY & TEST DISTANCE: VERTICAL AT 3 M

NO.	FREQ. (MHz)	EMISSION LEVEL (dBuV/m)	LIMIT (dBuV/m)	MARGIN (dB)	ANTENNA HEIGHT (m)	TABLE ANGLE (Degree)	RAW VALUE (dBuV)	CORRECTION FACTOR (dB/m)
1	#5470.00	54.6 PK	74.0	-19.4	2.05 V	177	53.4	1.2
2	#5470.00	42.8 AV	54.0	-11.2	2.05 V	177	41.6	1.2
3	*5720.00	121.8 PK			2.25 V	80	81.9	39.9
4	*5720.00	110.6 AV			2.25 V	80	70.7	39.9
5	#5850.00	55.4 PK	74.0	-18.6	1.88 V	213	53.1	2.3
6	#5850.00	44.0 AV	54.0	-10.0	1.88 V	213	41.7	2.3
7	11440.00	60.9 PK	74.0	-13.1	1.79 V	252	46.4	14.5
8	11440.00	47.0 AV	54.0	-7.0	1.79 V	252	32.5	14.5

Remarks:

1. Emission Level(dBuV/m) = Raw Value(dBuV) + Correction Factor(dB/m)
2. Correction Factor(dB/m) = Antenna Factor(dB/m) + Cable Factor(dB) – Pre-Amplifier Factor(dB)
3. The other emission levels were very low against the limit.
4. Margin value = Emission Level – Limit value
5. " * ": Fundamental frequency.
6. " # ": The radiated frequency is out of the restricted band.

802.11n (HT40)

CHANNEL	TX Channel 54	DETECTOR FUNCTION	Peak (PK) Average (AV)
FREQUENCY RANGE	1GHz ~ 40GHz		

ANTENNA POLARITY & TEST DISTANCE: HORIZONTAL AT 3 M

NO.	FREQ. (MHz)	EMISSION LEVEL (dBuV/m)	LIMIT (dBuV/m)	MARGIN (dB)	ANTENNA HEIGHT (m)	TABLE ANGLE (Degree)	RAW VALUE (dBuV)	CORRECTION FACTOR (dB/m)
1	5150.00	55.7 PK	74.0	-18.3	1.55 H	238	54.9	0.8
2	5150.00	42.2 AV	54.0	-11.8	1.55 H	238	41.4	0.8
3	*5270.00	100.6 PK			1.14 H	315	61.7	38.9
4	*5270.00	91.1 AV			1.14 H	315	52.2	38.9
5	5350.00	55.7 PK	74.0	-18.3	1.63 H	304	54.6	1.1
6	5350.00	43.0 AV	54.0	-11.0	1.63 H	304	41.9	1.1
7	#10540.00	59.3 PK	74.0	-14.7	1.42 H	258	45.6	13.7
8	#10540.00	45.2 AV	54.0	-8.8	1.42 H	258	31.5	13.7

ANTENNA POLARITY & TEST DISTANCE: VERTICAL AT 3 M

NO.	FREQ. (MHz)	EMISSION LEVEL (dBuV/m)	LIMIT (dBuV/m)	MARGIN (dB)	ANTENNA HEIGHT (m)	TABLE ANGLE (Degree)	RAW VALUE (dBuV)	CORRECTION FACTOR (dB/m)
1	5150.00	57.7 PK	74.0	-16.3	1.44 V	318	56.9	0.8
2	5150.00	44.3 AV	54.0	-9.7	1.44 V	318	43.5	0.8
3	*5270.00	118.1 PK			1.39 V	42	79.2	38.9
4	*5270.00	108.5 AV			1.39 V	42	69.6	38.9
5	5350.00	67.3 PK	74.0	-6.7	1.75 V	286	66.2	1.1
6	5350.00	52.6 AV	54.0	-1.4	1.75 V	286	51.5	1.1
7	#10540.00	58.8 PK	74.0	-15.2	1.89 V	235	45.1	13.7
8	#10540.00	45.1 AV	54.0	-8.9	1.89 V	235	31.4	13.7

Remarks:

1. Emission Level(dBuV/m) = Raw Value(dBuV) + Correction Factor(dB/m)
2. Correction Factor(dB/m) = Antenna Factor(dB/m) + Cable Factor(dB) – Pre-Amplifier Factor(dB)
3. The other emission levels were very low against the limit.
4. Margin value = Emission Level – Limit value
5. " * ": Fundamental frequency.
6. " # ": The radiated frequency is out of the restricted band.

CHANNEL	TX Channel 62	DETECTOR FUNCTION	Peak (PK)
FREQUENCY RANGE	1GHz ~ 40GHz		Average (AV)

ANTENNA POLARITY & TEST DISTANCE: HORIZONTAL AT 3 M								
NO.	FREQ. (MHz)	EMISSION LEVEL (dBuV/m)	LIMIT (dBuV/m)	MARGIN (dB)	ANTENNA HEIGHT (m)	TABLE ANGLE (Degree)	RAW VALUE (dBuV)	CORRECTION FACTOR (dB/m)
1	*5310.00	97.6 PK			1.80 H	225	58.7	38.9
2	*5310.00	87.7 AV			1.80 H	225	48.8	38.9
3	5350.00	57.5 PK	74.0	-16.5	1.39 H	228	56.4	1.1
4	5350.00	43.2 AV	54.0	-10.8	1.39 H	228	42.1	1.1
5	10620.00	58.9 PK	74.0	-15.1	1.74 H	278	45.1	13.8
6	10620.00	45.3 AV	54.0	-8.7	1.74 H	278	31.5	13.8
ANTENNA POLARITY & TEST DISTANCE: VERTICAL AT 3 M								
NO.	FREQ. (MHz)	EMISSION LEVEL (dBuV/m)	LIMIT (dBuV/m)	MARGIN (dB)	ANTENNA HEIGHT (m)	TABLE ANGLE (Degree)	RAW VALUE (dBuV)	CORRECTION FACTOR (dB/m)
1	*5310.00	114.1 PK			1.61 V	298	75.2	38.9
2	*5310.00	104.1 AV			1.61 V	298	65.2	38.9
3	5350.00	66.0 PK	74.0	-8.0	1.85 V	289	64.9	1.1
4	5350.00	52.7 AV	54.0	-1.3	1.85 V	289	51.6	1.1
5	10620.00	58.6 PK	74.0	-15.4	2.13 V	229	44.8	13.8
6	10620.00	45.1 AV	54.0	-8.9	2.13 V	229	31.3	13.8

Remarks:

1. Emission Level(dBuV/m) = Raw Value(dBuV) + Correction Factor(dB/m)
2. Correction Factor(dB/m) = Antenna Factor(dB/m) + Cable Factor(dB) – Pre-Amplifier Factor(dB)
3. The other emission levels were very low against the limit.
4. Margin value = Emission Level – Limit value
5. " * ": Fundamental frequency.
6. " # ": The radiated frequency is out of the restricted band.

CHANNEL	TX Channel 102	DETECTOR FUNCTION	Peak (PK)
FREQUENCY RANGE	1GHz ~ 40GHz		Average (AV)

ANTENNA POLARITY & TEST DISTANCE: HORIZONTAL AT 3 M								
NO.	FREQ. (MHz)	EMISSION LEVEL (dBuV/m)	LIMIT (dBuV/m)	MARGIN (dB)	ANTENNA HEIGHT (m)	TABLE ANGLE (Degree)	RAW VALUE (dBuV)	CORRECTION FACTOR (dB/m)
1	5460.00	54.9 PK	74.0	-19.1	3.12 H	269	53.7	1.2
2	5460.00	42.7 AV	54.0	-11.3	3.12 H	269	41.5	1.2
3	#5470.00	59.4 PK	74.0	-14.6	3.70 H	202	58.2	1.2
4	#5470.00	45.5 AV	54.0	-8.5	3.70 H	202	44.3	1.2
5	*5510.00	100.2 PK			3.30 H	42	60.9	39.3
6	*5510.00	90.1 AV			3.30 H	42	50.8	39.3
7	11020.00	60.1 PK	74.0	-13.9	1.88 H	193	44.9	15.2
8	11020.00	46.9 AV	54.0	-7.1	1.88 H	193	31.7	15.2

ANTENNA POLARITY & TEST DISTANCE: VERTICAL AT 3 M								
NO.	FREQ. (MHz)	EMISSION LEVEL (dBuV/m)	LIMIT (dBuV/m)	MARGIN (dB)	ANTENNA HEIGHT (m)	TABLE ANGLE (Degree)	RAW VALUE (dBuV)	CORRECTION FACTOR (dB/m)
1	5460.00	59.3 PK	74.0	-14.7	2.27 V	352	58.1	1.2
2	5460.00	47.5 AV	54.0	-6.5	2.27 V	352	46.3	1.2
3	#5470.00	67.4 PK	74.0	-6.6	2.65 V	320	66.2	1.2
4	#5470.00	52.3 AV	54.0	-1.7	2.65 V	320	51.1	1.2
5	*5510.00	108.8 PK			2.85 V	41	69.5	39.3
6	*5510.00	99.1 AV			2.85 V	41	59.8	39.3
7	11020.00	60.3 PK	74.0	-13.7	2.03 V	173	45.1	15.2
8	11020.00	47.0 AV	54.0	-7.0	2.03 V	173	31.8	15.2

Remarks:

1. Emission Level(dBuV/m) = Raw Value(dBuV) + Correction Factor(dB/m)
2. Correction Factor(dB/m) = Antenna Factor(dB/m) + Cable Factor(dB) – Pre-Amplifier Factor(dB)
3. The other emission levels were very low against the limit.
4. Margin value = Emission Level – Limit value
5. " * ": Fundamental frequency.
6. " # ": The radiated frequency is out of the restricted band.

CHANNEL	TX Channel 110	DETECTOR	Peak (PK)
FREQUENCY RANGE	1GHz ~ 40GHz	FUNCTION	Average (AV)

ANTENNA POLARITY & TEST DISTANCE: HORIZONTAL AT 3 M

NO.	FREQ. (MHz)	EMISSION LEVEL (dBuV/m)	LIMIT (dBuV/m)	MARGIN (dB)	ANTENNA HEIGHT (m)	TABLE ANGLE (Degree)	RAW VALUE (dBuV)	CORRECTION FACTOR (dB/m)
1	*5550.00	109.1 PK			3.83 H	199	69.8	39.3
2	*5550.00	99.5 AV			3.83 H	199	60.2	39.3
3	11100.00	59.9 PK	74.0	-14.1	2.29 H	147	45.1	14.8
4	11100.00	46.6 AV	54.0	-7.4	2.29 H	147	31.8	14.8

ANTENNA POLARITY & TEST DISTANCE: VERTICAL AT 3 M

NO.	FREQ. (MHz)	EMISSION LEVEL (dBuV/m)	LIMIT (dBuV/m)	MARGIN (dB)	ANTENNA HEIGHT (m)	TABLE ANGLE (Degree)	RAW VALUE (dBuV)	CORRECTION FACTOR (dB/m)
1	*5550.00	114.7 PK			2.47 V	144	75.4	39.3
2	*5550.00	104.9 AV			2.47 V	144	65.6	39.3
3	11100.00	59.8 PK	74.0	-14.2	2.31 V	122	45.0	14.8
4	11100.00	46.6 AV	54.0	-7.4	2.31 V	122	31.8	14.8

Remarks:

1. Emission Level(dBuV/m) = Raw Value(dBuV) + Correction Factor(dB/m)
2. Correction Factor(dB/m) = Antenna Factor(dB/m) + Cable Factor(dB) – Pre-Amplifier Factor(dB)
3. The other emission levels were very low against the limit.
4. Margin value = Emission Level – Limit value
5. " * ": Fundamental frequency.
6. " # ": The radiated frequency is out of the restricted band.

CHANNEL	TX Channel 134	DETECTOR FUNCTION	Peak (PK)
FREQUENCY RANGE	1GHz ~ 40GHz		Average (AV)

ANTENNA POLARITY & TEST DISTANCE: HORIZONTAL AT 3 M

NO.	FREQ. (MHz)	EMISSION LEVEL (dBuV/m)	LIMIT (dBuV/m)	MARGIN (dB)	ANTENNA HEIGHT (m)	TABLE ANGLE (Degree)	RAW VALUE (dBuV)	CORRECTION FACTOR (dB/m)
1	*5670.00	103.8 PK			3.86 H	34	64.1	39.7
2	*5670.00	94.0 AV			3.86 H	34	54.3	39.7
3	#5725.00	57.2 PK	74.0	-16.8	1.30 H	33	55.2	2.0
4	#5725.00	44.7 AV	54.0	-9.3	1.30 H	33	42.7	2.0
5	11340.00	60.5 PK	74.0	-13.5	2.63 H	177	45.8	14.7
6	11340.00	47.3 AV	54.0	-6.7	2.63 H	177	32.6	14.7

ANTENNA POLARITY & TEST DISTANCE: VERTICAL AT 3 M

NO.	FREQ. (MHz)	EMISSION LEVEL (dBuV/m)	LIMIT (dBuV/m)	MARGIN (dB)	ANTENNA HEIGHT (m)	TABLE ANGLE (Degree)	RAW VALUE (dBuV)	CORRECTION FACTOR (dB/m)
1	*5670.00	112.6 PK			2.58 V	71	72.9	39.7
2	*5670.00	102.9 AV			2.58 V	71	63.2	39.7
3	#5725.00	66.9 PK	74.0	-7.1	2.26 V	353	64.9	2.0
4	#5725.00	52.4 AV	54.0	-1.6	2.26 V	353	50.4	2.0
5	11340.00	60.3 PK	74.0	-13.7	2.23 V	138	45.6	14.7
6	11340.00	47.2 AV	54.0	-6.8	2.23 V	138	32.5	14.7

Remarks:

1. Emission Level(dBuV/m) = Raw Value(dBuV) + Correction Factor(dB/m)
2. Correction Factor(dB/m) = Antenna Factor(dB/m) + Cable Factor(dB) – Pre-Amplifier Factor(dB)
3. The other emission levels were very low against the limit.
4. Margin value = Emission Level – Limit value
5. " * ": Fundamental frequency.
6. " # ": The radiated frequency is out of the restricted band.

CHANNEL	TX Channel 142	DETECTOR FUNCTION	Peak (PK)
FREQUENCY RANGE	1GHz ~ 40GHz		Average (AV)

ANTENNA POLARITY & TEST DISTANCE: HORIZONTAL AT 3 M								
NO.	FREQ. (MHz)	EMISSION LEVEL (dBuV/m)	LIMIT (dBuV/m)	MARGIN (dB)	ANTENNA HEIGHT (m)	TABLE ANGLE (Degree)	RAW VALUE (dBuV)	CORRECTION FACTOR (dB/m)
1	#5470.00	55.5 PK	74.0	-18.5	1.82 H	157	54.3	1.2
2	#5470.00	42.6 AV	54.0	-11.4	1.82 H	157	41.4	1.2
3	*5710.00	105.4 PK			2.47 H	4	65.5	39.9
4	*5710.00	95.7 AV			2.47 H	4	55.8	39.9
5	#5850.00	55.3 PK	74.0	-18.7	2.53 H	141	53.0	2.3
6	#5850.00	43.4 AV	54.0	-10.6	2.53 H	141	41.1	2.3
7	11420.00	60.0 PK	74.0	-14.0	1.99 H	113	45.6	14.4
8	11420.00	47.2 AV	54.0	-6.8	1.99 H	113	32.8	14.4

ANTENNA POLARITY & TEST DISTANCE: VERTICAL AT 3 M								
NO.	FREQ. (MHz)	EMISSION LEVEL (dBuV/m)	LIMIT (dBuV/m)	MARGIN (dB)	ANTENNA HEIGHT (m)	TABLE ANGLE (Degree)	RAW VALUE (dBuV)	CORRECTION FACTOR (dB/m)
1	#5470.00	55.9 PK	74.0	-18.1	2.12 V	258	54.7	1.2
2	#5470.00	43.7 AV	54.0	-10.3	2.12 V	258	42.5	1.2
3	*5710.00	119.0 PK			2.40 V	68	79.1	39.9
4	*5710.00	109.1 AV			2.40 V	68	69.2	39.9
5	#5850.00	55.9 PK	74.0	-18.1	1.72 V	279	53.6	2.3
6	#5850.00	44.4 AV	54.0	-9.6	1.72 V	279	42.1	2.3
7	11420.00	60.0 PK	74.0	-14.0	1.86 V	73	45.6	14.4
8	11420.00	47.0 AV	54.0	-7.0	1.86 V	73	32.6	14.4

Remarks:

1. Emission Level(dBuV/m) = Raw Value(dBuV) + Correction Factor(dB/m)
2. Correction Factor(dB/m) = Antenna Factor(dB/m) + Cable Factor(dB) – Pre-Amplifier Factor(dB)
3. The other emission levels were very low against the limit.
4. Margin value = Emission Level – Limit value
5. " * ": Fundamental frequency.
6. " # ": The radiated frequency is out of the restricted band.

802.11ac (VHT80)

CHANNEL	TX Channel 58	DETECTOR FUNCTION	Peak (PK) Average (AV)
FREQUENCY RANGE	1GHz ~ 40GHz		

ANTENNA POLARITY & TEST DISTANCE: HORIZONTAL AT 3 M

NO.	FREQ. (MHz)	EMISSION LEVEL (dBuV/m)	LIMIT (dBuV/m)	MARGIN (dB)	ANTENNA HEIGHT (m)	TABLE ANGLE (Degree)	RAW VALUE (dBuV)	CORRECTION FACTOR (dB/m)
1	5150.00	55.3 PK	74.0	-18.7	1.70 H	264	54.5	0.8
2	5150.00	42.2 AV	54.0	-11.8	1.70 H	264	41.4	0.8
3	*5290.00	91.7 PK			1.66 H	225	52.8	38.9
4	*5290.00	81.6 AV			1.66 H	225	42.7	38.9
5	5350.00	56.1 PK	74.0	-17.9	1.44 H	140	55.0	1.1
6	5350.00	43.0 AV	54.0	-11.0	1.44 H	140	41.9	1.1
7	#10580.00	58.4 PK	74.0	-15.6	1.90 H	188	44.6	13.8
8	#10580.00	45.4 AV	54.0	-8.6	1.90 H	188	31.6	13.8

ANTENNA POLARITY & TEST DISTANCE: VERTICAL AT 3 M

NO.	FREQ. (MHz)	EMISSION LEVEL (dBuV/m)	LIMIT (dBuV/m)	MARGIN (dB)	ANTENNA HEIGHT (m)	TABLE ANGLE (Degree)	RAW VALUE (dBuV)	CORRECTION FACTOR (dB/m)
1	5150.00	56.5 PK	74.0	-17.5	1.54 V	229	55.7	0.8
2	5150.00	43.2 AV	54.0	-10.8	1.54 V	229	42.4	0.8
3	*5290.00	109.4 PK			1.74 V	295	70.5	38.9
4	*5290.00	98.5 AV			1.74 V	295	59.6	38.9
5	5350.00	65.4 PK	74.0	-8.6	1.63 V	302	64.3	1.1
6	5350.00	52.5 AV	54.0	-1.5	1.63 V	302	51.4	1.1
7	#10580.00	58.3 PK	74.0	-15.7	2.38 V	159	44.5	13.8
8	#10580.00	45.4 AV	54.0	-8.6	2.38 V	159	31.6	13.8

Remarks:

1. Emission Level(dBuV/m) = Raw Value(dBuV) + Correction Factor(dB/m)
2. Correction Factor(dB/m) = Antenna Factor(dB/m) + Cable Factor(dB) – Pre-Amplifier Factor(dB)
3. The other emission levels were very low against the limit.
4. Margin value = Emission Level – Limit value
5. " * ": Fundamental frequency.
6. " # ": The radiated frequency is out of the restricted band.

CHANNEL	TX Channel 106	DETECTOR FUNCTION	Peak (PK)
FREQUENCY RANGE	1GHz ~ 40GHz		Average (AV)

ANTENNA POLARITY & TEST DISTANCE: HORIZONTAL AT 3 M

NO.	FREQ. (MHz)	EMISSION LEVEL (dBuV/m)	LIMIT (dBuV/m)	MARGIN (dB)	ANTENNA HEIGHT (m)	TABLE ANGLE (Degree)	RAW VALUE (dBuV)	CORRECTION FACTOR (dB/m)
1	5460.00	54.6 PK	74.0	-19.4	1.49 H	193	53.4	1.2
2	5460.00	42.5 AV	54.0	-11.5	1.49 H	193	41.3	1.2
3	#5470.00	57.2 PK	74.0	-16.8	1.00 H	173	56.0	1.2
4	#5470.00	44.2 AV	54.0	-9.8	1.00 H	173	43.0	1.2
5	*5530.00	93.2 PK			2.36 H	1	53.9	39.3
6	*5530.00	83.3 AV			2.36 H	1	44.0	39.3
7	#5725.00	55.0 PK	74.0	-19.0	1.74 H	223	53.0	2.0
8	#5725.00	43.2 AV	54.0	-10.8	1.74 H	223	41.2	2.0
9	11060.00	59.6 PK	74.0	-14.4	1.81 H	216	44.7	14.9
10	11060.00	46.7 AV	54.0	-7.3	1.81 H	216	31.8	14.9

ANTENNA POLARITY & TEST DISTANCE: VERTICAL AT 3 M

NO.	FREQ. (MHz)	EMISSION LEVEL (dBuV/m)	LIMIT (dBuV/m)	MARGIN (dB)	ANTENNA HEIGHT (m)	TABLE ANGLE (Degree)	RAW VALUE (dBuV)	CORRECTION FACTOR (dB/m)
1	5460.00	63.1 PK	74.0	-10.9	2.26 V	258	61.9	1.2
2	5460.00	49.9 AV	54.0	-4.1	2.26 V	258	48.7	1.2
3	#5470.00	65.6 PK	74.0	-8.4	2.15 V	302	64.4	1.2
4	#5470.00	52.6 AV	54.0	-1.4	2.15 V	302	51.4	1.2
5	*5530.00	104.3 PK			2.72 V	40	65.0	39.3
6	*5530.00	94.4 AV			2.72 V	40	55.1	39.3
7	#5725.00	54.8 PK	74.0	-19.2	2.17 V	289	52.8	2.0
8	#5725.00	43.6 AV	54.0	-10.4	2.17 V	289	41.6	2.0
9	11060.00	59.4 PK	74.0	-14.6	3.12 V	248	44.5	14.9
10	11060.00	46.6 AV	54.0	-7.4	3.12 V	248	31.7	14.9

Remarks:

1. Emission Level(dBuV/m) = Raw Value(dBuV) + Correction Factor(dB/m)
2. Correction Factor(dB/m) = Antenna Factor(dB/m) + Cable Factor(dB) – Pre-Amplifier Factor(dB)
3. The other emission levels were very low against the limit.
4. Margin value = Emission Level – Limit value
5. " * ": Fundamental frequency.
6. " # ": The radiated frequency is out of the restricted band.

CHANNEL	TX Channel 122	DETECTOR FUNCTION	Peak (PK)
FREQUENCY RANGE	1GHz ~ 40GHz		Average (AV)

ANTENNA POLARITY & TEST DISTANCE: HORIZONTAL AT 3 M								
NO.	FREQ. (MHz)	EMISSION LEVEL (dBuV/m)	LIMIT (dBuV/m)	MARGIN (dB)	ANTENNA HEIGHT (m)	TABLE ANGLE (Degree)	RAW VALUE (dBuV)	CORRECTION FACTOR (dB/m)
1	#5470.00	57.4 PK	74.0	-16.6	2.20 H	6	56.2	1.2
2	#5470.00	43.0 AV	54.0	-11.0	2.20 H	6	41.8	1.2
3	*5610.00	101.5 PK			2.42 H	129	61.9	39.6
4	*5610.00	91.5 AV			2.42 H	129	51.9	39.6
5	#5725.00	58.1 PK	74.0	-15.9	1.82 H	10	56.1	2.0
6	#5725.00	43.9 AV	54.0	-10.1	1.82 H	10	41.9	2.0
7	11220.00	60.0 PK	74.0	-14.0	1.91 H	168	44.9	15.1
8	11220.00	46.2 AV	54.0	-7.8	1.91 H	168	31.1	15.1
ANTENNA POLARITY & TEST DISTANCE: VERTICAL AT 3 M								
NO.	FREQ. (MHz)	EMISSION LEVEL (dBuV/m)	LIMIT (dBuV/m)	MARGIN (dB)	ANTENNA HEIGHT (m)	TABLE ANGLE (Degree)	RAW VALUE (dBuV)	CORRECTION FACTOR (dB/m)
1	#5470.00	61.6 PK	74.0	-12.4	1.71 V	290	60.4	1.2
2	#5470.00	48.3 AV	54.0	-5.7	1.71 V	290	47.1	1.2
3	*5610.00	110.0 PK			2.35 V	70	70.4	39.6
4	*5610.00	100.2 AV			2.35 V	70	60.6	39.6
5	#5725.00	67.8 PK	74.0	-6.2	2.44 V	38	65.8	2.0
6	#5725.00	52.7 AV	54.0	-1.3	2.44 V	38	50.7	2.0
7	11220.00	59.8 PK	74.0	-14.2	1.38 V	199	44.7	15.1
8	11220.00	47.0 AV	54.0	-7.0	1.38 V	199	31.9	15.1

Remarks:

1. Emission Level(dBuV/m) = Raw Value(dBuV) + Correction Factor(dB/m)
2. Correction Factor(dB/m) = Antenna Factor(dB/m) + Cable Factor(dB) – Pre-Amplifier Factor(dB)
3. The other emission levels were very low against the limit.
4. Margin value = Emission Level – Limit value
5. " * ": Fundamental frequency.
6. " # ": The radiated frequency is out of the restricted band.

CHANNEL	TX Channel 138	DETECTOR FUNCTION	Peak (PK)
FREQUENCY RANGE	1GHz ~ 40GHz		Average (AV)

ANTENNA POLARITY & TEST DISTANCE: HORIZONTAL AT 3 M								
NO.	FREQ. (MHz)	EMISSION LEVEL (dBuV/m)	LIMIT (dBuV/m)	MARGIN (dB)	ANTENNA HEIGHT (m)	TABLE ANGLE (Degree)	RAW VALUE (dBuV)	CORRECTION FACTOR (dB/m)
1	#5470.00	54.5 PK	74.0	-19.5	2.24 H	214	53.3	1.2
2	#5470.00	42.6 AV	54.0	-11.4	2.24 H	214	41.4	1.2
3	*5690.00	101.7 PK			2.51 H	228	61.9	39.8
4	*5690.00	91.2 AV			2.51 H	228	51.4	39.8
5	#5850.00	54.9 PK	74.0	-19.1	2.73 H	199	52.6	2.3
6	#5850.00	43.6 AV	54.0	-10.4	2.73 H	199	41.3	2.3
7	11380.00	60.7 PK	74.0	-13.3	1.86 H	148	46.2	14.5
8	11380.00	47.1 AV	54.0	-6.9	1.86 H	148	32.6	14.5

ANTENNA POLARITY & TEST DISTANCE: VERTICAL AT 3 M								
NO.	FREQ. (MHz)	EMISSION LEVEL (dBuV/m)	LIMIT (dBuV/m)	MARGIN (dB)	ANTENNA HEIGHT (m)	TABLE ANGLE (Degree)	RAW VALUE (dBuV)	CORRECTION FACTOR (dB/m)
1	#5470.00	63.2 PK	74.0	-10.8	2.25 V	288	62.0	1.2
2	#5470.00	47.3 AV	54.0	-6.7	2.25 V	288	46.1	1.2
3	*5690.00	113.4 PK			2.26 V	61	73.6	39.8
4	*5690.00	103.1 AV			2.26 V	61	63.3	39.8
5	#5850.00	65.9 PK	74.0	-8.1	3.03 V	300	63.6	2.3
6	#5850.00	52.4 AV	54.0	-1.6	3.03 V	300	50.1	2.3
7	11380.00	59.8 PK	74.0	-14.2	1.47 V	65	45.3	14.5
8	11380.00	46.6 AV	54.0	-7.4	1.47 V	65	32.1	14.5

Remarks:

1. Emission Level(dBuV/m) = Raw Value(dBuV) + Correction Factor(dB/m)
2. Correction Factor(dB/m) = Antenna Factor(dB/m) + Cable Factor(dB) – Pre-Amplifier Factor(dB)
3. The other emission levels were very low against the limit.
4. Margin value = Emission Level – Limit value
5. " * ": Fundamental frequency.
6. " # ": The radiated frequency is out of the restricted band.

Test Mode D

802.11a

CHANNEL	TX Channel 52	DETECTOR FUNCTION	Peak (PK)
FREQUENCY RANGE	1GHz ~ 40GHz		Average (AV)

ANTENNA POLARITY & TEST DISTANCE: HORIZONTAL AT 3 M

NO.	FREQ. (MHz)	EMISSION LEVEL (dBuV/m)	LIMIT (dBuV/m)	MARGIN (dB)	ANTENNA HEIGHT (m)	TABLE ANGLE (Degree)	RAW VALUE (dBuV)	CORRECTION FACTOR (dB/m)
1	5150.00	54.5 PK	74.0	-19.5	1.23 H	265	53.7	0.8
2	5150.00	41.2 AV	54.0	-12.8	1.23 H	265	40.4	0.8
3	*5260.00	103.5 PK			1.76 H	0	64.7	38.8
4	*5260.00	93.4 AV			1.76 H	0	54.6	38.8
5	#10520.00	56.8 PK	74.0	-17.2	1.97 H	293	43.1	13.7
6	#10520.00	43.5 AV	54.0	-10.5	1.97 H	293	29.8	13.7

ANTENNA POLARITY & TEST DISTANCE: VERTICAL AT 3 M

NO.	FREQ. (MHz)	EMISSION LEVEL (dBuV/m)	LIMIT (dBuV/m)	MARGIN (dB)	ANTENNA HEIGHT (m)	TABLE ANGLE (Degree)	RAW VALUE (dBuV)	CORRECTION FACTOR (dB/m)
1	5150.00	55.2 PK	74.0	-18.8	1.47 V	185	54.4	0.8
2	5150.00	43.4 AV	54.0	-10.6	1.47 V	185	42.6	0.8
3	*5260.00	115.9 PK			1.66 V	293	77.1	38.8
4	*5260.00	105.9 AV			1.66 V	293	67.1	38.8
5	#10520.00	58.1 PK	74.0	-15.9	1.78 V	223	44.4	13.7
6	#10520.00	44.6 AV	54.0	-9.4	1.78 V	223	30.9	13.7

Remarks:

1. Emission Level(dBuV/m) = Raw Value(dBuV) + Correction Factor(dB/m)
2. Correction Factor(dB/m) = Antenna Factor(dB/m) + Cable Factor(dB) – Pre-Amplifier Factor(dB)
3. The other emission levels were very low against the limit.
4. Margin value = Emission Level – Limit value
5. " * ": Fundamental frequency.
6. " # ": The radiated frequency is out of the restricted band.

CHANNEL	TX Channel 60	DETECTOR FUNCTION	Peak (PK)
FREQUENCY RANGE	1GHz ~ 40GHz		Average (AV)

ANTENNA POLARITY & TEST DISTANCE: HORIZONTAL AT 3 M

NO.	FREQ. (MHz)	EMISSION LEVEL (dBuV/m)	LIMIT (dBuV/m)	MARGIN (dB)	ANTENNA HEIGHT (m)	TABLE ANGLE (Degree)	RAW VALUE (dBuV)	CORRECTION FACTOR (dB/m)
1	*5300.00	103.2 PK			1.81 H	2	64.3	38.9
2	*5300.00	93.1 AV			1.81 H	2	54.2	38.9
3	10600.00	57.6 PK	74.0	-16.4	1.12 H	108	43.8	13.8
4	10600.00	44.2 AV	54.0	-9.8	1.12 H	108	30.4	13.8

ANTENNA POLARITY & TEST DISTANCE: VERTICAL AT 3 M

NO.	FREQ. (MHz)	EMISSION LEVEL (dBuV/m)	LIMIT (dBuV/m)	MARGIN (dB)	ANTENNA HEIGHT (m)	TABLE ANGLE (Degree)	RAW VALUE (dBuV)	CORRECTION FACTOR (dB/m)
1	*5300.00	116.4 PK			2.00 V	192	77.5	38.9
2	*5300.00	106.3 AV			2.00 V	192	67.4	38.9
3	10600.00	57.4 PK	74.0	-16.6	1.32 V	226	43.6	13.8
4	10600.00	44.0 AV	54.0	-10.0	1.32 V	226	30.2	13.8

Remarks:

1. Emission Level(dBuV/m) = Raw Value(dBuV) + Correction Factor(dB/m)
2. Correction Factor(dB/m) = Antenna Factor(dB/m) + Cable Factor(dB) – Pre-Amplifier Factor(dB)
3. The other emission levels were very low against the limit.
4. Margin value = Emission Level – Limit value
5. " * ": Fundamental frequency.
6. " # ": The radiated frequency is out of the restricted band.

CHANNEL	TX Channel 64	DETECTOR FUNCTION	Peak (PK)
FREQUENCY RANGE	1GHz ~ 40GHz		Average (AV)

ANTENNA POLARITY & TEST DISTANCE: HORIZONTAL AT 3 M								
NO.	FREQ. (MHz)	EMISSION LEVEL (dBuV/m)	LIMIT (dBuV/m)	MARGIN (dB)	ANTENNA HEIGHT (m)	TABLE ANGLE (Degree)	RAW VALUE (dBuV)	CORRECTION FACTOR (dB/m)
1	*5320.00	103.2 PK			1.56 H	39	64.2	39.0
2	*5320.00	93.1 AV			1.56 H	39	54.1	39.0
3	5350.00	56.4 PK	74.0	-17.6	1.29 H	39	55.3	1.1
4	5350.00	42.4 AV	54.0	-11.6	1.29 H	39	41.3	1.1
5	10640.00	57.1 PK	74.0	-16.9	1.87 H	214	43.2	13.9
6	10640.00	44.1 AV	54.0	-9.9	1.87 H	214	30.2	13.9

ANTENNA POLARITY & TEST DISTANCE: VERTICAL AT 3 M								
NO.	FREQ. (MHz)	EMISSION LEVEL (dBuV/m)	LIMIT (dBuV/m)	MARGIN (dB)	ANTENNA HEIGHT (m)	TABLE ANGLE (Degree)	RAW VALUE (dBuV)	CORRECTION FACTOR (dB/m)
1	*5320.00	113.1 PK			2.06 V	309	74.1	39.0
2	*5320.00	102.6 AV			2.06 V	309	63.6	39.0
3	5350.00	66.5 PK	74.0	-7.5	1.25 V	205	65.4	1.1
4	5350.00	51.3 AV	54.0	-2.7	1.25 V	205	50.2	1.1
5	10640.00	57.4 PK	74.0	-16.6	1.95 V	184	43.5	13.9
6	10640.00	44.6 AV	54.0	-9.4	1.95 V	184	30.7	13.9

Remarks:

1. Emission Level(dBuV/m) = Raw Value(dBuV) + Correction Factor(dB/m)
2. Correction Factor(dB/m) = Antenna Factor(dB/m) + Cable Factor(dB) – Pre-Amplifier Factor(dB)
3. The other emission levels were very low against the limit.
4. Margin value = Emission Level – Limit value
5. " * ": Fundamental frequency.
6. " # ": The radiated frequency is out of the restricted band.

CHANNEL	TX Channel 100	DETECTOR FUNCTION	Peak (PK)
FREQUENCY RANGE	1GHz ~ 40GHz		Average (AV)

ANTENNA POLARITY & TEST DISTANCE: HORIZONTAL AT 3 M								
NO.	FREQ. (MHz)	EMISSION LEVEL (dBuV/m)	LIMIT (dBuV/m)	MARGIN (dB)	ANTENNA HEIGHT (m)	TABLE ANGLE (Degree)	RAW VALUE (dBuV)	CORRECTION FACTOR (dB/m)
1	5460.00	54.0 PK	74.0	-20.0	1.18 H	314	52.8	1.2
2	5460.00	41.4 AV	54.0	-12.6	1.18 H	314	40.2	1.2
3	#5470.00	57.5 PK	74.0	-16.5	1.38 H	331	56.3	1.2
4	#5470.00	43.0 AV	54.0	-11.0	1.38 H	331	41.8	1.2
5	*5500.00	104.2 PK			1.50 H	360	64.9	39.3
6	*5500.00	94.1 AV			1.50 H	360	54.8	39.3
7	11000.00	58.4 PK	74.0	-15.6	1.14 H	123	43.1	15.3
8	11000.00	44.8 AV	54.0	-9.2	1.14 H	123	29.5	15.3

ANTENNA POLARITY & TEST DISTANCE: VERTICAL AT 3 M								
NO.	FREQ. (MHz)	EMISSION LEVEL (dBuV/m)	LIMIT (dBuV/m)	MARGIN (dB)	ANTENNA HEIGHT (m)	TABLE ANGLE (Degree)	RAW VALUE (dBuV)	CORRECTION FACTOR (dB/m)
1	5460.00	61.0 PK	74.0	-13.0	2.20 V	180	59.8	1.2
2	5460.00	44.8 AV	54.0	-9.2	2.20 V	180	43.6	1.2
3	#5470.00	67.5 PK	74.0	-6.5	2.22 V	176	66.3	1.2
4	#5470.00	51.4 AV	54.0	-2.6	2.22 V	176	50.2	1.2
5	*5500.00	114.2 PK			1.80 V	202	74.9	39.3
6	*5500.00	104.6 AV			1.80 V	202	65.3	39.3
7	11000.00	58.3 PK	74.0	-15.7	1.74 V	260	43.0	15.3
8	11000.00	46.2 AV	54.0	-7.8	1.74 V	260	30.9	15.3

Remarks:

1. Emission Level(dBuV/m) = Raw Value(dBuV) + Correction Factor(dB/m)
2. Correction Factor(dB/m) = Antenna Factor(dB/m) + Cable Factor(dB) – Pre-Amplifier Factor(dB)
3. The other emission levels were very low against the limit.
4. Margin value = Emission Level – Limit value
5. " * ": Fundamental frequency.
6. " # ": The radiated frequency is out of the restricted band.

CHANNEL	TX Channel 116	DETECTOR FUNCTION	Peak (PK)
FREQUENCY RANGE	1GHz ~ 40GHz		Average (AV)

ANTENNA POLARITY & TEST DISTANCE: HORIZONTAL AT 3 M

NO.	FREQ. (MHz)	EMISSION LEVEL (dBuV/m)	LIMIT (dBuV/m)	MARGIN (dB)	ANTENNA HEIGHT (m)	TABLE ANGLE (Degree)	RAW VALUE (dBuV)	CORRECTION FACTOR (dB/m)
1	*5580.00	107.3 PK			1.16 H	24	67.8	39.5
2	*5580.00	96.5 AV			1.16 H	24	57.0	39.5
3	11160.00	58.4 PK	74.0	-15.6	1.18 H	319	43.5	14.9
4	11160.00	44.8 AV	54.0	-9.2	1.18 H	319	29.9	14.9

ANTENNA POLARITY & TEST DISTANCE: VERTICAL AT 3 M

NO.	FREQ. (MHz)	EMISSION LEVEL (dBuV/m)	LIMIT (dBuV/m)	MARGIN (dB)	ANTENNA HEIGHT (m)	TABLE ANGLE (Degree)	RAW VALUE (dBuV)	CORRECTION FACTOR (dB/m)
1	*5580.00	118.0 PK			1.77 V	33	78.5	39.5
2	*5580.00	107.4 AV			1.77 V	33	67.9	39.5
3	11160.00	58.5 PK	74.0	-15.5	1.44 V	41	43.6	14.9
4	11160.00	44.9 AV	54.0	-9.1	1.44 V	41	30.0	14.9

Remarks:

1. Emission Level(dBuV/m) = Raw Value(dBuV) + Correction Factor(dB/m)
2. Correction Factor(dB/m) = Antenna Factor(dB/m) + Cable Factor(dB) – Pre-Amplifier Factor(dB)
3. The other emission levels were very low against the limit.
4. Margin value = Emission Level – Limit value
5. " * ": Fundamental frequency.
6. " # ": The radiated frequency is out of the restricted band.

CHANNEL	TX Channel 140	DETECTOR FUNCTION	Peak (PK)
FREQUENCY RANGE	1GHz ~ 40GHz		Average (AV)

ANTENNA POLARITY & TEST DISTANCE: HORIZONTAL AT 3 M								
NO.	FREQ. (MHz)	EMISSION LEVEL (dBuV/m)	LIMIT (dBuV/m)	MARGIN (dB)	ANTENNA HEIGHT (m)	TABLE ANGLE (Degree)	RAW VALUE (dBuV)	CORRECTION FACTOR (dB/m)
1	*5700.00	107.1 PK			1.98 H	230	67.3	39.8
2	*5700.00	96.3 AV			1.98 H	230	56.5	39.8
3	#5725.00	55.7 PK	74.0	-18.3	1.74 H	80	53.7	2.0
4	#5725.00	43.6 AV	54.0	-10.4	1.74 H	80	41.6	2.0
5	11400.00	58.9 PK	74.0	-15.1	1.41 H	160	44.4	14.5
6	11400.00	45.1 AV	54.0	-8.9	1.41 H	160	30.6	14.5
ANTENNA POLARITY & TEST DISTANCE: VERTICAL AT 3 M								
NO.	FREQ. (MHz)	EMISSION LEVEL (dBuV/m)	LIMIT (dBuV/m)	MARGIN (dB)	ANTENNA HEIGHT (m)	TABLE ANGLE (Degree)	RAW VALUE (dBuV)	CORRECTION FACTOR (dB/m)
1	*5700.00	115.7 PK			1.55 V	286	75.9	39.8
2	*5700.00	105.3 AV			1.55 V	286	65.5	39.8
3	#5725.00	67.2 PK	74.0	-6.8	1.60 V	317	65.2	2.0
4	#5725.00	52.5 AV	54.0	-1.5	1.60 V	317	50.5	2.0
5	11400.00	59.4 PK	74.0	-14.6	1.65 V	236	44.9	14.5
6	11400.00	44.6 AV	54.0	-9.4	1.65 V	236	30.1	14.5

Remarks:

1. Emission Level(dBuV/m) = Raw Value(dBuV) + Correction Factor(dB/m)
2. Correction Factor(dB/m) = Antenna Factor(dB/m) + Cable Factor(dB) – Pre-Amplifier Factor(dB)
3. The other emission levels were very low against the limit.
4. Margin value = Emission Level – Limit value
5. " * ": Fundamental frequency.
6. " # ": The radiated frequency is out of the restricted band.

CHANNEL	TX Channel 144	DETECTOR FUNCTION	Peak (PK)
FREQUENCY RANGE	1GHz ~ 40GHz		Average (AV)

ANTENNA POLARITY & TEST DISTANCE: HORIZONTAL AT 3 M								
NO.	FREQ. (MHz)	EMISSION LEVEL (dBuV/m)	LIMIT (dBuV/m)	MARGIN (dB)	ANTENNA HEIGHT (m)	TABLE ANGLE (Degree)	RAW VALUE (dBuV)	CORRECTION FACTOR (dB/m)
1	#5470.00	55.5 PK	74.0	-18.5	2.11 H	123	54.3	1.2
2	#5470.00	46.5 AV	54.0	-7.5	2.11 H	123	45.3	1.2
3	*5720.00	105.0 PK			2.08 H	124	65.1	39.9
4	*5720.00	95.0 AV			2.08 H	124	55.1	39.9
5	#5825.00	56.9 PK	74.0	-17.1	2.00 H	150	54.7	2.2
6	#5825.00	46.5 AV	54.0	-7.5	2.00 H	150	44.3	2.2
7	11440.00	60.0 PK	74.0	-14.0	1.76 H	181	45.5	14.5
8	11440.00	47.2 AV	54.0	-6.8	1.76 H	181	32.7	14.5

ANTENNA POLARITY & TEST DISTANCE: VERTICAL AT 3 M								
NO.	FREQ. (MHz)	EMISSION LEVEL (dBuV/m)	LIMIT (dBuV/m)	MARGIN (dB)	ANTENNA HEIGHT (m)	TABLE ANGLE (Degree)	RAW VALUE (dBuV)	CORRECTION FACTOR (dB/m)
1	#5470.00	55.5 PK	74.0	-18.5	2.33 V	33	54.3	1.2
2	#5470.00	45.9 AV	54.0	-8.1	2.33 V	33	44.7	1.2
3	*5720.00	118.0 PK			2.40 V	24	78.1	39.9
4	*5720.00	107.7 AV			2.40 V	24	67.8	39.9
5	#5825.00	57.9 PK	74.0	-16.1	2.50 V	0	55.7	2.2
6	#5825.00	47.7 AV	54.0	-6.3	2.50 V	0	45.5	2.2
7	11440.00	60.5 PK	74.0	-13.5	2.00 V	90	46.0	14.5
8	11440.00	47.6 AV	54.0	-6.4	2.00 V	90	33.1	14.5

Remarks:

1. Emission Level(dBuV/m) = Raw Value(dBuV) + Correction Factor(dB/m)
2. Correction Factor(dB/m) = Antenna Factor(dB/m) + Cable Factor(dB) – Pre-Amplifier Factor(dB)
3. The other emission levels were very low against the limit.
4. Margin value = Emission Level – Limit value
5. " * ": Fundamental frequency.
6. " # ": The radiated frequency is out of the restricted band.

802.11n (HT20)

CHANNEL	TX Channel 52	DETECTOR FUNCTION	Peak (PK) Average (AV)
FREQUENCY RANGE	1GHz ~ 40GHz		

ANTENNA POLARITY & TEST DISTANCE: HORIZONTAL AT 3 M

NO.	FREQ. (MHz)	EMISSION LEVEL (dBuV/m)	LIMIT (dBuV/m)	MARGIN (dB)	ANTENNA HEIGHT (m)	TABLE ANGLE (Degree)	RAW VALUE (dBuV)	CORRECTION FACTOR (dB/m)
1	5150.00	54.9 PK	74.0	-19.1	1.30 H	268	54.1	0.8
2	5150.00	41.3 AV	54.0	-12.7	1.30 H	268	40.5	0.8
3	*5260.00	103.4 PK			1.65 H	21	64.6	38.8
4	*5260.00	92.0 AV			1.65 H	21	53.2	38.8
5	#10520.00	57.0 PK	74.0	-17.0	1.83 H	147	43.3	13.7
6	#10520.00	44.0 AV	54.0	-10.0	1.83 H	147	30.3	13.7

ANTENNA POLARITY & TEST DISTANCE: VERTICAL AT 3 M

NO.	FREQ. (MHz)	EMISSION LEVEL (dBuV/m)	LIMIT (dBuV/m)	MARGIN (dB)	ANTENNA HEIGHT (m)	TABLE ANGLE (Degree)	RAW VALUE (dBuV)	CORRECTION FACTOR (dB/m)
1	5150.00	53.4 PK	74.0	-20.6	1.88 V	223	52.6	0.8
2	5150.00	40.7 AV	54.0	-13.3	1.88 V	223	39.9	0.8
3	*5260.00	115.7 PK			1.70 V	293	76.9	38.8
4	*5260.00	105.3 AV			1.70 V	293	66.5	38.8
5	#10520.00	57.5 PK	74.0	-16.5	1.23 V	256	43.8	13.7
6	#10520.00	43.5 AV	54.0	-10.5	1.23 V	256	29.8	13.7

Remarks:

1. Emission Level(dBuV/m) = Raw Value(dBuV) + Correction Factor(dB/m)
2. Correction Factor(dB/m) = Antenna Factor(dB/m) + Cable Factor(dB) – Pre-Amplifier Factor(dB)
3. The other emission levels were very low against the limit.
4. Margin value = Emission Level – Limit value
5. " * ": Fundamental frequency.
6. " # ": The radiated frequency is out of the restricted band.

CHANNEL	TX Channel 60	DETECTOR FUNCTION	Peak (PK)
FREQUENCY RANGE	1GHz ~ 40GHz		Average (AV)

ANTENNA POLARITY & TEST DISTANCE: HORIZONTAL AT 3 M								
NO.	FREQ. (MHz)	EMISSION LEVEL (dBuV/m)	LIMIT (dBuV/m)	MARGIN (dB)	ANTENNA HEIGHT (m)	TABLE ANGLE (Degree)	RAW VALUE (dBuV)	CORRECTION FACTOR (dB/m)
1	*5300.00	104.1 PK			1.81 H	2	65.2	38.9
2	*5300.00	93.8 AV			1.81 H	2	54.9	38.9
3	10600.00	57.1 PK	74.0	-16.9	1.23 H	145	43.3	13.8
4	10600.00	44.0 AV	54.0	-10.0	1.23 H	145	30.2	13.8
ANTENNA POLARITY & TEST DISTANCE: VERTICAL AT 3 M								
NO.	FREQ. (MHz)	EMISSION LEVEL (dBuV/m)	LIMIT (dBuV/m)	MARGIN (dB)	ANTENNA HEIGHT (m)	TABLE ANGLE (Degree)	RAW VALUE (dBuV)	CORRECTION FACTOR (dB/m)
1	*5300.00	116.3 PK			1.83 V	219	77.4	38.9
2	*5300.00	105.8 AV			1.83 V	219	66.9	38.9
3	10600.00	57.7 PK	74.0	-16.3	1.22 V	284	43.9	13.8
4	10600.00	44.0 AV	54.0	-10.0	1.22 V	284	30.2	13.8

Remarks:

1. Emission Level(dBuV/m) = Raw Value(dBuV) + Correction Factor(dB/m)
2. Correction Factor(dB/m) = Antenna Factor(dB/m) + Cable Factor(dB) – Pre-Amplifier Factor(dB)
3. The other emission levels were very low against the limit.
4. Margin value = Emission Level – Limit value
5. " * ": Fundamental frequency.
6. " # ": The radiated frequency is out of the restricted band.

CHANNEL	TX Channel 64	DETECTOR FUNCTION	Peak (PK)
FREQUENCY RANGE	1GHz ~ 40GHz		Average (AV)

ANTENNA POLARITY & TEST DISTANCE: HORIZONTAL AT 3 M								
NO.	FREQ. (MHz)	EMISSION LEVEL (dBuV/m)	LIMIT (dBuV/m)	MARGIN (dB)	ANTENNA HEIGHT (m)	TABLE ANGLE (Degree)	RAW VALUE (dBuV)	CORRECTION FACTOR (dB/m)
1	*5320.00	104.1 PK			1.90 H	360	65.1	39.0
2	*5320.00	92.9 AV			1.90 H	360	53.9	39.0
3	5350.00	55.0 PK	74.0	-19.0	1.50 H	133	53.9	1.1
4	5350.00	41.8 AV	54.0	-12.2	1.50 H	133	40.7	1.1
5	10640.00	56.6 PK	74.0	-17.4	1.22 H	159	42.7	13.9
6	10640.00	43.9 AV	54.0	-10.1	1.22 H	159	30.0	13.9
ANTENNA POLARITY & TEST DISTANCE: VERTICAL AT 3 M								
NO.	FREQ. (MHz)	EMISSION LEVEL (dBuV/m)	LIMIT (dBuV/m)	MARGIN (dB)	ANTENNA HEIGHT (m)	TABLE ANGLE (Degree)	RAW VALUE (dBuV)	CORRECTION FACTOR (dB/m)
1	*5320.00	116.6 PK			1.72 V	301	77.6	39.0
2	*5320.00	106.2 AV			1.72 V	301	67.2	39.0
3	5350.00	66.6 PK	74.0	-7.4	1.53 V	328	65.5	1.1
4	5350.00	52.5 AV	54.0	-1.5	1.53 V	328	51.4	1.1
5	10640.00	57.3 PK	74.0	-16.7	1.38 V	269	43.4	13.9
6	10640.00	43.7 AV	54.0	-10.3	1.38 V	269	29.8	13.9

Remarks:

1. Emission Level(dBuV/m) = Raw Value(dBuV) + Correction Factor(dB/m)
2. Correction Factor(dB/m) = Antenna Factor(dB/m) + Cable Factor(dB) – Pre-Amplifier Factor(dB)
3. The other emission levels were very low against the limit.
4. Margin value = Emission Level – Limit value
5. " * ": Fundamental frequency.
6. " # ": The radiated frequency is out of the restricted band.

CHANNEL	TX Channel 100	DETECTOR FUNCTION	Peak (PK)
FREQUENCY RANGE	1GHz ~ 40GHz		Average (AV)

ANTENNA POLARITY & TEST DISTANCE: HORIZONTAL AT 3 M								
NO.	FREQ. (MHz)	EMISSION LEVEL (dBuV/m)	LIMIT (dBuV/m)	MARGIN (dB)	ANTENNA HEIGHT (m)	TABLE ANGLE (Degree)	RAW VALUE (dBuV)	CORRECTION FACTOR (dB/m)
1	5460.00	53.0 PK	74.0	-21.0	1.77 H	276	51.8	1.2
2	5460.00	41.0 AV	54.0	-13.0	1.77 H	276	39.8	1.2
3	#5470.00	53.5 PK	74.0	-20.5	1.84 H	231	52.3	1.2
4	#5470.00	42.4 AV	54.0	-11.6	1.84 H	231	41.2	1.2
5	*5500.00	106.1 PK			1.32 H	42	66.8	39.3
6	*5500.00	95.4 AV			1.32 H	42	56.1	39.3
7	11000.00	58.3 PK	74.0	-15.7	1.42 H	114	43.0	15.3
8	11000.00	45.1 AV	54.0	-8.9	1.42 H	114	29.8	15.3

ANTENNA POLARITY & TEST DISTANCE: VERTICAL AT 3 M								
NO.	FREQ. (MHz)	EMISSION LEVEL (dBuV/m)	LIMIT (dBuV/m)	MARGIN (dB)	ANTENNA HEIGHT (m)	TABLE ANGLE (Degree)	RAW VALUE (dBuV)	CORRECTION FACTOR (dB/m)
1	5460.00	60.1 PK	74.0	-13.9	1.45 V	334	58.9	1.2
2	5460.00	46.5 AV	54.0	-7.5	1.45 V	334	45.3	1.2
3	#5470.00	68.1 PK	74.0	-5.9	1.44 V	344	66.9	1.2
4	#5470.00	52.3 AV	54.0	-1.7	1.44 V	344	51.1	1.2
5	*5500.00	116.0 PK			1.46 V	337	76.7	39.3
6	*5500.00	105.2 AV			1.46 V	337	65.9	39.3
7	11000.00	68.5 PK	74.0	-5.5	1.55 V	231	53.2	15.3
8	11000.00	44.3 AV	54.0	-9.7	1.55 V	231	29.0	15.3

Remarks:

1. Emission Level(dBuV/m) = Raw Value(dBuV) + Correction Factor(dB/m)
2. Correction Factor(dB/m) = Antenna Factor(dB/m) + Cable Factor(dB) – Pre-Amplifier Factor(dB)
3. The other emission levels were very low against the limit.
4. Margin value = Emission Level – Limit value
5. " * ": Fundamental frequency.
6. " # ": The radiated frequency is out of the restricted band.

CHANNEL	TX Channel 116	DETECTOR FUNCTION	Peak (PK)
FREQUENCY RANGE	1GHz ~ 40GHz		Average (AV)

ANTENNA POLARITY & TEST DISTANCE: HORIZONTAL AT 3 M

NO.	FREQ. (MHz)	EMISSION LEVEL (dBuV/m)	LIMIT (dBuV/m)	MARGIN (dB)	ANTENNA HEIGHT (m)	TABLE ANGLE (Degree)	RAW VALUE (dBuV)	CORRECTION FACTOR (dB/m)
1	*5580.00	107.4 PK			1.43 H	41	67.9	39.5
2	*5580.00	97.0 AV			1.43 H	41	57.5	39.5
3	11160.00	58.8 PK	74.0	-15.2	1.29 H	221	43.9	14.9
4	11160.00	45.2 AV	54.0	-8.8	1.29 H	221	30.3	14.9

ANTENNA POLARITY & TEST DISTANCE: VERTICAL AT 3 M

NO.	FREQ. (MHz)	EMISSION LEVEL (dBuV/m)	LIMIT (dBuV/m)	MARGIN (dB)	ANTENNA HEIGHT (m)	TABLE ANGLE (Degree)	RAW VALUE (dBuV)	CORRECTION FACTOR (dB/m)
1	*5580.00	115.4 PK			1.24 V	357	75.9	39.5
2	*5580.00	105.8 AV			1.24 V	357	66.3	39.5
3	11160.00	58.2 PK	74.0	-15.8	1.68 V	313	43.3	14.9
4	11160.00	44.5 AV	54.0	-9.5	1.68 V	313	29.6	14.9

Remarks:

1. Emission Level(dBuV/m) = Raw Value(dBuV) + Correction Factor(dB/m)
2. Correction Factor(dB/m) = Antenna Factor(dB/m) + Cable Factor(dB) – Pre-Amplifier Factor(dB)
3. The other emission levels were very low against the limit.
4. Margin value = Emission Level – Limit value
5. " * ": Fundamental frequency.
6. " # ": The radiated frequency is out of the restricted band.

CHANNEL	TX Channel 140	DETECTOR FUNCTION	Peak (PK)
FREQUENCY RANGE	1GHz ~ 40GHz		Average (AV)

ANTENNA POLARITY & TEST DISTANCE: HORIZONTAL AT 3 M

NO.	FREQ. (MHz)	EMISSION LEVEL (dBuV/m)	LIMIT (dBuV/m)	MARGIN (dB)	ANTENNA HEIGHT (m)	TABLE ANGLE (Degree)	RAW VALUE (dBuV)	CORRECTION FACTOR (dB/m)
1	*5700.00	106.2 PK			1.44 H	41	66.4	39.8
2	*5700.00	95.5 AV			1.44 H	41	55.7	39.8
3	#5725.00	55.8 PK	74.0	-18.2	1.30 H	77	53.8	2.0
4	#5725.00	44.5 AV	54.0	-9.5	1.30 H	77	42.5	2.0
5	11400.00	58.1 PK	74.0	-15.9	1.57 H	189	43.6	14.5
6	11400.00	44.8 AV	54.0	-9.2	1.57 H	189	30.3	14.5

ANTENNA POLARITY & TEST DISTANCE: VERTICAL AT 3 M

NO.	FREQ. (MHz)	EMISSION LEVEL (dBuV/m)	LIMIT (dBuV/m)	MARGIN (dB)	ANTENNA HEIGHT (m)	TABLE ANGLE (Degree)	RAW VALUE (dBuV)	CORRECTION FACTOR (dB/m)
1	*5700.00	117.1 PK			1.31 V	20	77.3	39.8
2	*5700.00	106.0 AV			1.31 V	20	66.2	39.8
3	#5725.00	65.9 PK	74.0	-8.1	1.09 V	296	63.9	2.0
4	#5725.00	52.3 AV	54.0	-1.7	1.09 V	296	50.3	2.0
5	11400.00	58.0 PK	74.0	-16.0	1.23 V	32	43.5	14.5
6	11400.00	44.7 AV	54.0	-9.3	1.23 V	32	30.2	14.5

Remarks:

1. Emission Level(dBuV/m) = Raw Value(dBuV) + Correction Factor(dB/m)
2. Correction Factor(dB/m) = Antenna Factor(dB/m) + Cable Factor(dB) – Pre-Amplifier Factor(dB)
3. The other emission levels were very low against the limit.
4. Margin value = Emission Level – Limit value
5. " * ": Fundamental frequency.
6. " # ": The radiated frequency is out of the restricted band.

CHANNEL	TX Channel 144	DETECTOR FUNCTION	Peak (PK)
FREQUENCY RANGE	1GHz ~ 40GHz		Average (AV)

ANTENNA POLARITY & TEST DISTANCE: HORIZONTAL AT 3 M								
NO.	FREQ. (MHz)	EMISSION LEVEL (dBuV/m)	LIMIT (dBuV/m)	MARGIN (dB)	ANTENNA HEIGHT (m)	TABLE ANGLE (Degree)	RAW VALUE (dBuV)	CORRECTION FACTOR (dB/m)
1	#5470.00	56.0 PK	74.0	-18.0	2.22 H	120	54.8	1.2
2	#5470.00	44.7 AV	54.0	-9.3	2.22 H	120	43.5	1.2
3	*5720.00	105.7 PK			2.19 H	125	65.8	39.9
4	*5720.00	94.8 AV			2.19 H	125	54.9	39.9
5	#5825.00	56.3 PK	74.0	-17.7	1.92 H	100	54.1	2.2
6	#5825.00	46.2 AV	54.0	-7.8	1.92 H	100	44.0	2.2
7	11440.00	59.6 PK	74.0	-14.4	1.77 H	196	45.1	14.5
8	11440.00	46.9 AV	54.0	-7.1	1.77 H	196	32.4	14.5

ANTENNA POLARITY & TEST DISTANCE: VERTICAL AT 3 M								
NO.	FREQ. (MHz)	EMISSION LEVEL (dBuV/m)	LIMIT (dBuV/m)	MARGIN (dB)	ANTENNA HEIGHT (m)	TABLE ANGLE (Degree)	RAW VALUE (dBuV)	CORRECTION FACTOR (dB/m)
1	#5470.00	56.3 PK	74.0	-17.7	2.50 V	179	55.1	1.2
2	#5470.00	46.0 AV	54.0	-8.0	2.50 V	179	44.8	1.2
3	*5720.00	119.2 PK			2.23 V	26	79.3	39.9
4	*5720.00	107.8 AV			2.23 V	26	67.9	39.9
5	#5825.00	57.0 PK	74.0	-17.0	2.40 V	279	54.8	2.2
6	#5825.00	46.9 AV	54.0	-7.1	2.40 V	279	44.7	2.2
7	11440.00	60.8 PK	74.0	-13.2	2.49 V	214	46.3	14.5
8	11440.00	47.6 AV	54.0	-6.4	2.49 V	214	33.1	14.5

Remarks:

1. Emission Level(dBuV/m) = Raw Value(dBuV) + Correction Factor(dB/m)
2. Correction Factor(dB/m) = Antenna Factor(dB/m) + Cable Factor(dB) – Pre-Amplifier Factor(dB)
3. The other emission levels were very low against the limit.
4. Margin value = Emission Level – Limit value
5. " * ": Fundamental frequency.
6. " # ": The radiated frequency is out of the restricted band.

802.11n (HT40)

CHANNEL	TX Channel 54	DETECTOR FUNCTION	Peak (PK) Average (AV)
FREQUENCY RANGE	1GHz ~ 40GHz		

ANTENNA POLARITY & TEST DISTANCE: HORIZONTAL AT 3 M

NO.	FREQ. (MHz)	EMISSION LEVEL (dBuV/m)	LIMIT (dBuV/m)	MARGIN (dB)	ANTENNA HEIGHT (m)	TABLE ANGLE (Degree)	RAW VALUE (dBuV)	CORRECTION FACTOR (dB/m)
1	*5270.00	100.8 PK			2.06 H	28	61.9	38.9
2	*5270.00	91.2 AV			2.06 H	28	52.3	38.9
3	5350.00	54.9 PK	74.0	-19.1	1.22 H	177	53.8	1.1
4	5350.00	41.6 AV	54.0	-12.4	1.22 H	177	40.5	1.1
5	#10540.00	57.6 PK	74.0	-16.4	2.00 H	17	43.9	13.7
6	#10540.00	44.3 AV	54.0	-9.7	2.00 H	17	30.6	13.7

ANTENNA POLARITY & TEST DISTANCE: VERTICAL AT 3 M

NO.	FREQ. (MHz)	EMISSION LEVEL (dBuV/m)	LIMIT (dBuV/m)	MARGIN (dB)	ANTENNA HEIGHT (m)	TABLE ANGLE (Degree)	RAW VALUE (dBuV)	CORRECTION FACTOR (dB/m)
1	*5270.00	114.0 PK			1.59 V	294	75.1	38.9
2	*5270.00	104.0 AV			1.59 V	294	65.1	38.9
3	5350.00	58.7 PK	74.0	-15.3	1.89 V	193	57.6	1.1
4	5350.00	45.9 AV	54.0	-8.1	1.89 V	193	44.8	1.1
5	#10540.00	57.9 PK	74.0	-16.1	1.23 V	336	44.2	13.7
6	#10540.00	44.3 AV	54.0	-9.7	1.23 V	336	30.6	13.7

Remarks:

1. Emission Level(dBuV/m) = Raw Value(dBuV) + Correction Factor(dB/m)
2. Correction Factor(dB/m) = Antenna Factor(dB/m) + Cable Factor(dB) – Pre-Amplifier Factor(dB)
3. The other emission levels were very low against the limit.
4. Margin value = Emission Level – Limit value
5. " * ": Fundamental frequency.
6. " # ": The radiated frequency is out of the restricted band.

CHANNEL	TX Channel 62	DETECTOR FUNCTION	Peak (PK)
FREQUENCY RANGE	1GHz ~ 40GHz		Average (AV)

ANTENNA POLARITY & TEST DISTANCE: HORIZONTAL AT 3 M								
NO.	FREQ. (MHz)	EMISSION LEVEL (dBuV/m)	LIMIT (dBuV/m)	MARGIN (dB)	ANTENNA HEIGHT (m)	TABLE ANGLE (Degree)	RAW VALUE (dBuV)	CORRECTION FACTOR (dB/m)
1	*5310.00	97.5 PK			1.88 H	19	58.6	38.9
2	*5310.00	88.0 AV			1.88 H	19	49.1	38.9
3	5350.00	55.5 PK	74.0	-18.5	1.95 H	29	54.4	1.1
4	5350.00	42.4 AV	54.0	-11.6	1.95 H	29	41.3	1.1
5	10620.00	57.6 PK	74.0	-16.4	2.10 H	78	43.8	13.8
6	10620.00	44.2 AV	54.0	-9.8	2.10 H	78	30.4	13.8

ANTENNA POLARITY & TEST DISTANCE: VERTICAL AT 3 M								
NO.	FREQ. (MHz)	EMISSION LEVEL (dBuV/m)	LIMIT (dBuV/m)	MARGIN (dB)	ANTENNA HEIGHT (m)	TABLE ANGLE (Degree)	RAW VALUE (dBuV)	CORRECTION FACTOR (dB/m)
1	*5310.00	111.1 PK			1.74 V	320	72.2	38.9
2	*5310.00	101.7 AV			1.74 V	320	62.8	38.9
3	5350.00	65.6 PK	74.0	-8.4	1.97 V	322	64.5	1.1
4	5350.00	52.2 AV	54.0	-1.8	1.97 V	322	51.1	1.1
5	10620.00	56.3 PK	74.0	-17.7	2.00 V	220	42.5	13.8
6	10620.00	43.5 AV	54.0	-10.5	2.00 V	220	29.7	13.8

Remarks:

1. Emission Level(dBuV/m) = Raw Value(dBuV) + Correction Factor(dB/m)
2. Correction Factor(dB/m) = Antenna Factor(dB/m) + Cable Factor(dB) – Pre-Amplifier Factor(dB)
3. The other emission levels were very low against the limit.
4. Margin value = Emission Level – Limit value
5. " * ": Fundamental frequency.
6. " # ": The radiated frequency is out of the restricted band.

CHANNEL	TX Channel 102	DETECTOR FUNCTION	Peak (PK)
FREQUENCY RANGE	1GHz ~ 40GHz		Average (AV)

ANTENNA POLARITY & TEST DISTANCE: HORIZONTAL AT 3 M								
NO.	FREQ. (MHz)	EMISSION LEVEL (dBuV/m)	LIMIT (dBuV/m)	MARGIN (dB)	ANTENNA HEIGHT (m)	TABLE ANGLE (Degree)	RAW VALUE (dBuV)	CORRECTION FACTOR (dB/m)
1	5460.00	53.7 PK	74.0	-20.3	1.60 H	50	52.5	1.2
2	5460.00	42.0 AV	54.0	-12.0	1.60 H	50	40.8	1.2
3	#5470.00	55.3 PK	74.0	-18.7	1.50 H	87	54.1	1.2
4	#5470.00	44.7 AV	54.0	-9.3	1.50 H	87	43.5	1.2
5	*5510.00	98.8 PK			1.32 H	41	59.5	39.3
6	*5510.00	89.5 AV			1.32 H	41	50.2	39.3
7	11020.00	58.6 PK	74.0	-15.4	1.80 H	209	43.4	15.2
8	11020.00	45.5 AV	54.0	-8.5	1.80 H	209	30.3	15.2

ANTENNA POLARITY & TEST DISTANCE: VERTICAL AT 3 M								
NO.	FREQ. (MHz)	EMISSION LEVEL (dBuV/m)	LIMIT (dBuV/m)	MARGIN (dB)	ANTENNA HEIGHT (m)	TABLE ANGLE (Degree)	RAW VALUE (dBuV)	CORRECTION FACTOR (dB/m)
1	5460.00	59.2 PK	74.0	-14.8	1.90 V	187	58.0	1.2
2	5460.00	47.9 AV	54.0	-6.1	1.90 V	187	46.7	1.2
3	#5470.00	66.1 PK	74.0	-7.9	1.96 V	220	64.9	1.2
4	#5470.00	52.8 AV	54.0	-1.2	1.96 V	220	51.6	1.2
5	*5510.00	110.0 PK			1.78 V	293	70.7	39.3
6	*5510.00	100.8 AV			1.78 V	293	61.5	39.3
7	11020.00	58.0 PK	74.0	-16.0	1.66 V	300	42.8	15.2
8	11020.00	45.0 AV	54.0	-9.0	1.66 V	300	29.8	15.2

Remarks:

1. Emission Level(dBuV/m) = Raw Value(dBuV) + Correction Factor(dB/m)
2. Correction Factor(dB/m) = Antenna Factor(dB/m) + Cable Factor(dB) – Pre-Amplifier Factor(dB)
3. The other emission levels were very low against the limit.
4. Margin value = Emission Level – Limit value
5. " * ": Fundamental frequency.
6. " # ": The radiated frequency is out of the restricted band.

CHANNEL	TX Channel 110	DETECTOR FUNCTION	Peak (PK)
FREQUENCY RANGE	1GHz ~ 40GHz		Average (AV)

ANTENNA POLARITY & TEST DISTANCE: HORIZONTAL AT 3 M								
NO.	FREQ. (MHz)	EMISSION LEVEL (dBuV/m)	LIMIT (dBuV/m)	MARGIN (dB)	ANTENNA HEIGHT (m)	TABLE ANGLE (Degree)	RAW VALUE (dBuV)	CORRECTION FACTOR (dB/m)
1	5460.00	53.5 PK	74.0	-20.5	1.30 H	46	52.3	1.2
2	5460.00	41.3 AV	54.0	-12.7	1.30 H	46	40.1	1.2
3	#5470.00	57.5 PK	74.0	-16.5	1.47 H	37	56.3	1.2
4	#5470.00	43.9 AV	54.0	-10.1	1.47 H	37	42.7	1.2
5	*5550.00	104.0 PK			1.32 H	43	64.7	39.3
6	*5550.00	94.6 AV			1.32 H	43	55.3	39.3
7	11100.00	57.8 PK	74.0	-16.2	1.56 H	333	43.0	14.8
8	11100.00	44.6 AV	54.0	-9.4	1.56 H	333	29.8	14.8
ANTENNA POLARITY & TEST DISTANCE: VERTICAL AT 3 M								
NO.	FREQ. (MHz)	EMISSION LEVEL (dBuV/m)	LIMIT (dBuV/m)	MARGIN (dB)	ANTENNA HEIGHT (m)	TABLE ANGLE (Degree)	RAW VALUE (dBuV)	CORRECTION FACTOR (dB/m)
1	5460.00	56.7 PK	74.0	-17.3	2.05 V	112	55.5	1.2
2	5460.00	44.3 AV	54.0	-9.7	2.05 V	112	43.1	1.2
3	#5470.00	64.7 PK	74.0	-9.3	2.07 V	148	63.5	1.2
4	#5470.00	49.1 AV	54.0	-4.9	2.07 V	148	47.9	1.2
5	*5550.00	112.7 PK			1.83 V	301	73.4	39.3
6	*5550.00	103.5 AV			1.83 V	301	64.2	39.3
7	11100.00	59.4 PK	74.0	-14.6	1.44 V	340	44.6	14.8
8	11100.00	46.8 AV	54.0	-7.2	1.44 V	340	32.0	14.8

Remarks:

1. Emission Level(dBuV/m) = Raw Value(dBuV) + Correction Factor(dB/m)
2. Correction Factor(dB/m) = Antenna Factor(dB/m) + Cable Factor(dB) – Pre-Amplifier Factor(dB)
3. The other emission levels were very low against the limit.
4. Margin value = Emission Level – Limit value
5. " * ": Fundamental frequency.
6. " # ": The radiated frequency is out of the restricted band.

CHANNEL	TX Channel 134	DETECTOR FUNCTION	Peak (PK)
FREQUENCY RANGE	1GHz ~ 40GHz		Average (AV)

ANTENNA POLARITY & TEST DISTANCE: HORIZONTAL AT 3 M

NO.	FREQ. (MHz)	EMISSION LEVEL (dBuV/m)	LIMIT (dBuV/m)	MARGIN (dB)	ANTENNA HEIGHT (m)	TABLE ANGLE (Degree)	RAW VALUE (dBuV)	CORRECTION FACTOR (dB/m)
1	*5670.00	104.6 PK			1.21 H	41	64.9	39.7
2	*5670.00	95.0 AV			1.21 H	41	55.3	39.7
3	#5725.00	57.3 PK	74.0	-16.7	1.48 H	37	55.3	2.0
4	#5725.00	46.3 AV	54.0	-7.7	1.48 H	37	44.3	2.0
5	11340.00	57.5 PK	74.0	-16.5	1.80 H	139	42.8	14.7
6	11340.00	44.3 AV	54.0	-9.7	1.80 H	139	29.6	14.7

ANTENNA POLARITY & TEST DISTANCE: VERTICAL AT 3 M

NO.	FREQ. (MHz)	EMISSION LEVEL (dBuV/m)	LIMIT (dBuV/m)	MARGIN (dB)	ANTENNA HEIGHT (m)	TABLE ANGLE (Degree)	RAW VALUE (dBuV)	CORRECTION FACTOR (dB/m)
1	*5670.00	113.7 PK			1.65 V	293	74.0	39.7
2	*5670.00	104.5 AV			1.65 V	293	64.8	39.7
3	#5725.00	63.5 PK	74.0	-10.5	1.72 V	299	61.5	2.0
4	#5725.00	52.3 AV	54.0	-1.7	1.72 V	299	50.3	2.0
5	11340.00	58.1 PK	74.0	-15.9	1.25 V	40	43.4	14.7
6	11340.00	45.0 AV	54.0	-9.0	1.25 V	40	30.3	14.7

Remarks:

1. Emission Level(dBuV/m) = Raw Value(dBuV) + Correction Factor(dB/m)
2. Correction Factor(dB/m) = Antenna Factor(dB/m) + Cable Factor(dB) – Pre-Amplifier Factor(dB)
3. The other emission levels were very low against the limit.
4. Margin value = Emission Level – Limit value
5. " * ": Fundamental frequency.
6. " # ": The radiated frequency is out of the restricted band.

CHANNEL	TX Channel 142	DETECTOR FUNCTION	Peak (PK)
FREQUENCY RANGE	1GHz ~ 40GHz		Average (AV)

ANTENNA POLARITY & TEST DISTANCE: HORIZONTAL AT 3 M								
NO.	FREQ. (MHz)	EMISSION LEVEL (dBuV/m)	LIMIT (dBuV/m)	MARGIN (dB)	ANTENNA HEIGHT (m)	TABLE ANGLE (Degree)	RAW VALUE (dBuV)	CORRECTION FACTOR (dB/m)
1	#5470.00	55.6 PK	74.0	-18.4	2.10 H	99	54.4	1.2
2	#5470.00	45.1 AV	54.0	-8.9	2.10 H	99	43.9	1.2
3	*5710.00	101.6 PK			2.20 H	126	61.7	39.9
4	*5710.00	92.3 AV			2.20 H	126	52.4	39.9
5	#5825.00	56.9 PK	74.0	-17.1	1.90 H	133	54.7	2.2
6	#5825.00	46.4 AV	54.0	-7.6	1.90 H	133	44.2	2.2
7	11420.00	59.2 PK	74.0	-14.8	1.69 H	212	44.8	14.4
8	11420.00	46.3 AV	54.0	-7.7	1.69 H	212	31.9	14.4

ANTENNA POLARITY & TEST DISTANCE: VERTICAL AT 3 M								
NO.	FREQ. (MHz)	EMISSION LEVEL (dBuV/m)	LIMIT (dBuV/m)	MARGIN (dB)	ANTENNA HEIGHT (m)	TABLE ANGLE (Degree)	RAW VALUE (dBuV)	CORRECTION FACTOR (dB/m)
1	#5470.00	56.7 PK	74.0	-17.3	2.29 V	19	55.5	1.2
2	#5470.00	46.3 AV	54.0	-7.7	2.29 V	19	45.1	1.2
3	*5710.00	114.0 PK			2.21 V	20	74.1	39.9
4	*5710.00	104.1 AV			2.21 V	20	64.2	39.9
5	#5825.00	57.0 PK	74.0	-17.0	2.33 V	0	54.8	2.2
6	#5825.00	47.2 AV	54.0	-6.8	2.33 V	0	45.0	2.2
7	11420.00	60.1 PK	74.0	-13.9	1.85 V	222	45.7	14.4
8	11420.00	46.8 AV	54.0	-7.2	1.85 V	222	32.4	14.4

Remarks:

1. Emission Level(dBuV/m) = Raw Value(dBuV) + Correction Factor(dB/m)
2. Correction Factor(dB/m) = Antenna Factor(dB/m) + Cable Factor(dB) – Pre-Amplifier Factor(dB)
3. The other emission levels were very low against the limit.
4. Margin value = Emission Level – Limit value
5. " * ": Fundamental frequency.
6. " # ": The radiated frequency is out of the restricted band.

802.11ac (VHT80)

CHANNEL	TX Channel 58	DETECTOR FUNCTION	Peak (PK)
FREQUENCY RANGE	1GHz ~ 40GHz		Average (AV)

ANTENNA POLARITY & TEST DISTANCE: HORIZONTAL AT 3 M

NO.	FREQ. (MHz)	EMISSION LEVEL (dBuV/m)	LIMIT (dBuV/m)	MARGIN (dB)	ANTENNA HEIGHT (m)	TABLE ANGLE (Degree)	RAW VALUE (dBuV)	CORRECTION FACTOR (dB/m)
1	*5290.00	94.7 PK			1.79 H	360	55.8	38.9
2	*5290.00	85.1 AV			1.79 H	360	46.2	38.9
3	5350.00	55.6 PK	74.0	-18.4	1.72 H	0	54.5	1.1
4	5350.00	43.2 AV	54.0	-10.8	1.72 H	0	42.1	1.1
5	#10580.00	57.6 PK	74.0	-16.4	1.66 H	18	43.8	13.8
6	#10580.00	44.3 AV	54.0	-9.7	1.66 H	18	30.5	13.8

ANTENNA POLARITY & TEST DISTANCE: VERTICAL AT 3 M

NO.	FREQ. (MHz)	EMISSION LEVEL (dBuV/m)	LIMIT (dBuV/m)	MARGIN (dB)	ANTENNA HEIGHT (m)	TABLE ANGLE (Degree)	RAW VALUE (dBuV)	CORRECTION FACTOR (dB/m)
1	*5290.00	106.6 PK			1.75 V	331	67.7	38.9
2	*5290.00	97.8 AV			1.75 V	331	58.9	38.9
3	5350.00	64.8 PK	74.0	-9.2	1.67 V	322	63.7	1.1
4	5350.00	52.2 AV	54.0	-1.8	1.67 V	322	51.1	1.1
5	#10580.00	56.9 PK	74.0	-17.1	1.95 V	222	43.1	13.8
6	#10580.00	44.0 AV	54.0	-10.0	1.95 V	222	30.2	13.8

Remarks:

1. Emission Level(dBuV/m) = Raw Value(dBuV) + Correction Factor(dB/m)
2. Correction Factor(dB/m) = Antenna Factor(dB/m) + Cable Factor(dB) – Pre-Amplifier Factor(dB)
3. The other emission levels were very low against the limit.
4. Margin value = Emission Level – Limit value
5. " * ": Fundamental frequency.
6. " # ": The radiated frequency is out of the restricted band.

CHANNEL	TX Channel 106	DETECTOR FUNCTION	Peak (PK)
FREQUENCY RANGE	1GHz ~ 40GHz		Average (AV)

ANTENNA POLARITY & TEST DISTANCE: HORIZONTAL AT 3 M								
NO.	FREQ. (MHz)	EMISSION LEVEL (dBuV/m)	LIMIT (dBuV/m)	MARGIN (dB)	ANTENNA HEIGHT (m)	TABLE ANGLE (Degree)	RAW VALUE (dBuV)	CORRECTION FACTOR (dB/m)
1	5460.00	54.8 PK	74.0	-19.2	1.45 H	42	53.6	1.2
2	5460.00	42.5 AV	54.0	-11.5	1.45 H	42	41.3	1.2
3	#5470.00	56.7 PK	74.0	-17.3	1.49 H	56	55.5	1.2
4	#5470.00	45.6 AV	54.0	-8.4	1.49 H	56	44.4	1.2
5	*5530.00	94.4 PK			1.33 H	42	55.1	39.3
6	*5530.00	84.9 AV			1.33 H	42	45.6	39.3
7	11060.00	57.7 PK	74.0	-16.3	1.89 H	324	42.8	14.9
8	11060.00	44.9 AV	54.0	-9.1	1.89 H	324	30.0	14.9
ANTENNA POLARITY & TEST DISTANCE: VERTICAL AT 3 M								
NO.	FREQ. (MHz)	EMISSION LEVEL (dBuV/m)	LIMIT (dBuV/m)	MARGIN (dB)	ANTENNA HEIGHT (m)	TABLE ANGLE (Degree)	RAW VALUE (dBuV)	CORRECTION FACTOR (dB/m)
1	5460.00	59.1 PK	74.0	-14.9	1.91 V	310	57.9	1.2
2	5460.00	48.9 AV	54.0	-5.1	1.91 V	310	47.7	1.2
3	#5470.00	64.7 PK	74.0	-9.3	1.99 V	160	63.5	1.2
4	#5470.00	52.5 AV	54.0	-1.5	1.99 V	160	51.3	1.2
5	*5530.00	105.6 PK			1.81 V	231	66.3	39.3
6	*5530.00	95.5 AV			1.81 V	231	56.2	39.3
7	11060.00	57.2 PK	74.0	-16.8	1.88 V	149	42.3	14.9
8	11060.00	44.5 AV	54.0	-9.5	1.88 V	149	29.6	14.9

Remarks:

1. Emission Level(dBuV/m) = Raw Value(dBuV) + Correction Factor(dB/m)
2. Correction Factor(dB/m) = Antenna Factor(dB/m) + Cable Factor(dB) – Pre-Amplifier Factor(dB)
3. The other emission levels were very low against the limit.
4. Margin value = Emission Level – Limit value
5. " * ": Fundamental frequency.
6. " # ": The radiated frequency is out of the restricted band.

CHANNEL	TX Channel 122	DETECTOR FUNCTION	Peak (PK)
FREQUENCY RANGE	1GHz ~ 40GHz		Average (AV)

ANTENNA POLARITY & TEST DISTANCE: HORIZONTAL AT 3 M								
NO.	FREQ. (MHz)	EMISSION LEVEL (dBuV/m)	LIMIT (dBuV/m)	MARGIN (dB)	ANTENNA HEIGHT (m)	TABLE ANGLE (Degree)	RAW VALUE (dBuV)	CORRECTION FACTOR (dB/m)
1	5460.00	54.1 PK	74.0	-19.9	2.03 H	96	52.9	1.2
2	5460.00	42.5 AV	54.0	-11.5	2.03 H	96	41.3	1.2
3	#5470.00	55.7 PK	74.0	-18.3	2.06 H	23	54.5	1.2
4	#5470.00	43.8 AV	54.0	-10.2	2.06 H	23	42.6	1.2
5	*5610.00	98.3 PK			2.11 H	117	58.7	39.6
6	*5610.00	88.7 AV			2.11 H	117	49.1	39.6
7	#5725.00	55.6 PK	74.0	-18.4	1.99 H	302	53.6	2.0
8	#5725.00	44.8 AV	54.0	-9.2	1.99 H	302	42.8	2.0
9	11220.00	58.5 PK	74.0	-15.5	1.56 H	111	43.4	15.1
10	11220.00	45.9 AV	54.0	-8.1	1.56 H	111	30.8	15.1

ANTENNA POLARITY & TEST DISTANCE: VERTICAL AT 3 M								
NO.	FREQ. (MHz)	EMISSION LEVEL (dBuV/m)	LIMIT (dBuV/m)	MARGIN (dB)	ANTENNA HEIGHT (m)	TABLE ANGLE (Degree)	RAW VALUE (dBuV)	CORRECTION FACTOR (dB/m)
1	5460.00	58.9 PK	74.0	-15.1	1.89 V	144	57.7	1.2
2	5460.00	45.4 AV	54.0	-8.6	1.89 V	144	44.2	1.2
3	#5470.00	61.3 PK	74.0	-12.7	1.88 V	140	60.1	1.2
4	#5470.00	47.9 AV	54.0	-6.1	1.88 V	140	46.7	1.2
5	*5610.00	110.5 PK			1.81 V	297	70.9	39.6
6	*5610.00	100.5 AV			1.81 V	297	60.9	39.6
7	#5725.00	62.9 PK	74.0	-11.1	2.07 V	214	60.9	2.0
8	#5725.00	51.6 AV	54.0	-2.4	2.07 V	214	49.6	2.0
9	11220.00	59.4 PK	74.0	-14.6	2.15 V	198	44.3	15.1
10	11220.00	46.5 AV	54.0	-7.5	2.15 V	198	31.4	15.1

Remarks:

1. Emission Level(dBuV/m) = Raw Value(dBuV) + Correction Factor(dB/m)
2. Correction Factor(dB/m) = Antenna Factor(dB/m) + Cable Factor(dB) – Pre-Amplifier Factor(dB)
3. The other emission levels were very low against the limit.
4. Margin value = Emission Level – Limit value
5. " * ": Fundamental frequency.
6. " # ": The radiated frequency is out of the restricted band.

CHANNEL	TX Channel 138	DETECTOR FUNCTION	Peak (PK)
FREQUENCY RANGE	1GHz ~ 40GHz		Average (AV)

ANTENNA POLARITY & TEST DISTANCE: HORIZONTAL AT 3 M								
NO.	FREQ. (MHz)	EMISSION LEVEL (dBuV/m)	LIMIT (dBuV/m)	MARGIN (dB)	ANTENNA HEIGHT (m)	TABLE ANGLE (Degree)	RAW VALUE (dBuV)	CORRECTION FACTOR (dB/m)
1	#5470.00	54.7 PK	74.0	-19.3	1.90 H	123	53.5	1.2
2	#5470.00	43.1 AV	54.0	-10.9	1.90 H	123	41.9	1.2
3	*5690.00	97.5 PK			1.96 H	119	57.7	39.8
4	*5690.00	87.7 AV			1.96 H	119	47.9	39.8
5	#5825.00	56.3 PK	74.0	-17.7	2.03 H	131	54.1	2.2
6	#5825.00	45.1 AV	54.0	-8.9	2.03 H	131	42.9	2.2
7	11380.00	57.5 PK	74.0	-16.5	1.56 H	320	43.0	14.5
8	11380.00	46.4 AV	54.0	-7.6	1.56 H	320	31.9	14.5

ANTENNA POLARITY & TEST DISTANCE: VERTICAL AT 3 M								
NO.	FREQ. (MHz)	EMISSION LEVEL (dBuV/m)	LIMIT (dBuV/m)	MARGIN (dB)	ANTENNA HEIGHT (m)	TABLE ANGLE (Degree)	RAW VALUE (dBuV)	CORRECTION FACTOR (dB/m)
1	#5470.00	57.9 PK	74.0	-16.1	2.09 V	100	56.7	1.2
2	#5470.00	46.7 AV	54.0	-7.3	2.09 V	100	45.5	1.2
3	*5690.00	110.1 PK			2.01 V	104	70.3	39.8
4	*5690.00	100.3 AV			2.01 V	104	60.5	39.8
5	#5825.00	63.7 PK	74.0	-10.3	2.00 V	39	61.5	2.2
6	#5825.00	49.5 AV	54.0	-4.5	2.00 V	39	47.3	2.2
7	11380.00	59.3 PK	74.0	-14.7	2.55 V	313	44.8	14.5
8	11380.00	47.6 AV	54.0	-6.4	2.55 V	313	33.1	14.5

Remarks:

1. Emission Level(dBuV/m) = Raw Value(dBuV) + Correction Factor(dB/m)
2. Correction Factor(dB/m) = Antenna Factor(dB/m) + Cable Factor(dB) – Pre-Amplifier Factor(dB)
3. The other emission levels were very low against the limit.
4. Margin value = Emission Level – Limit value
5. " * ": Fundamental frequency.
6. " # ": The radiated frequency is out of the restricted band.

Test Mode G

802.11a

CHANNEL	TX Channel 52	DETECTOR FUNCTION	Peak (PK)
FREQUENCY RANGE	1GHz ~ 40GHz		Average (AV)

ANTENNA POLARITY & TEST DISTANCE: HORIZONTAL AT 3 M

NO.	FREQ. (MHz)	EMISSION LEVEL (dBuV/m)	LIMIT (dBuV/m)	MARGIN (dB)	ANTENNA HEIGHT (m)	TABLE ANGLE (Degree)	RAW VALUE (dBuV)	CORRECTION FACTOR (dB/m)
1	5150.00	53.4 PK	74.0	-20.6	1.56 H	352	52.6	0.8
2	5150.00	40.5 AV	54.0	-13.5	1.56 H	352	39.7	0.8
3	*5260.00	118.4 PK			1.05 H	346	79.6	38.8
4	*5260.00	107.2 AV			1.05 H	346	68.4	38.8
5	#10520.00	60.8 PK	74.0	-13.2	1.16 H	211	47.1	13.7
6	#10520.00	47.1 AV	54.0	-6.9	1.16 H	211	33.4	13.7

ANTENNA POLARITY & TEST DISTANCE: VERTICAL AT 3 M

NO.	FREQ. (MHz)	EMISSION LEVEL (dBuV/m)	LIMIT (dBuV/m)	MARGIN (dB)	ANTENNA HEIGHT (m)	TABLE ANGLE (Degree)	RAW VALUE (dBuV)	CORRECTION FACTOR (dB/m)
1	5150.00	54.1 PK	74.0	-19.9	1.23 V	341	53.3	0.8
2	5150.00	41.7 AV	54.0	-12.3	1.23 V	341	40.9	0.8
3	*5260.00	119.0 PK			1.52 V	345	80.2	38.8
4	*5260.00	107.2 AV			1.52 V	345	68.4	38.8
5	#10520.00	60.9 PK	74.0	-13.1	1.36 V	309	47.2	13.7
6	#10520.00	47.1 AV	54.0	-6.9	1.36 V	309	33.4	13.7

Remarks:

1. Emission Level(dBuV/m) = Raw Value(dBuV) + Correction Factor(dB/m)
2. Correction Factor(dB/m) = Antenna Factor(dB/m) + Cable Factor(dB) – Pre-Amplifier Factor(dB)
3. The other emission levels were very low against the limit.
4. Margin value = Emission Level – Limit value
5. " * ": Fundamental frequency.
6. " # ": The radiated frequency is out of the restricted band.

CHANNEL	TX Channel 60	DETECTOR FUNCTION	Peak (PK)
FREQUENCY RANGE	1GHz ~ 40GHz		Average (AV)

ANTENNA POLARITY & TEST DISTANCE: HORIZONTAL AT 3 M								
NO.	FREQ. (MHz)	EMISSION LEVEL (dBuV/m)	LIMIT (dBuV/m)	MARGIN (dB)	ANTENNA HEIGHT (m)	TABLE ANGLE (Degree)	RAW VALUE (dBuV)	CORRECTION FACTOR (dB/m)
1	*5300.00	117.3 PK			1.92 H	353	78.4	38.9
2	*5300.00	106.7 AV			1.92 H	353	67.8	38.9
3	5350.00	61.7 PK	74.0	-12.3	1.79 H	348	60.6	1.1
4	5350.00	45.9 AV	54.0	-8.1	1.79 H	348	44.8	1.1
5	10600.00	61.5 PK	74.0	-12.5	1.62 H	175	47.7	13.8
6	10600.00	47.6 AV	54.0	-6.4	1.62 H	175	33.8	13.8
ANTENNA POLARITY & TEST DISTANCE: VERTICAL AT 3 M								
NO.	FREQ. (MHz)	EMISSION LEVEL (dBuV/m)	LIMIT (dBuV/m)	MARGIN (dB)	ANTENNA HEIGHT (m)	TABLE ANGLE (Degree)	RAW VALUE (dBuV)	CORRECTION FACTOR (dB/m)
1	*5300.00	118.8 PK			1.08 V	351	79.9	38.9
2	*5300.00	106.9 AV			1.08 V	351	68.0	38.9
3	5350.00	62.2 PK	74.0	-11.8	1.79 V	343	61.1	1.1
4	5350.00	47.0 AV	54.0	-7.0	1.79 V	343	45.9	1.1
5	10600.00	61.4 PK	74.0	-12.6	1.26 V	305	47.6	13.8
6	10600.00	47.9 AV	54.0	-6.1	1.26 V	305	34.1	13.8

Remarks:

1. Emission Level(dBuV/m) = Raw Value(dBuV) + Correction Factor(dB/m)
2. Correction Factor(dB/m) = Antenna Factor(dB/m) + Cable Factor(dB) – Pre-Amplifier Factor(dB)
3. The other emission levels were very low against the limit.
4. Margin value = Emission Level – Limit value
5. " * ": Fundamental frequency.
6. " # ": The radiated frequency is out of the restricted band.

CHANNEL	TX Channel 64	DETECTOR FUNCTION	Peak (PK)
FREQUENCY RANGE	1GHz ~ 40GHz		Average (AV)

ANTENNA POLARITY & TEST DISTANCE: HORIZONTAL AT 3 M								
NO.	FREQ. (MHz)	EMISSION LEVEL (dBuV/m)	LIMIT (dBuV/m)	MARGIN (dB)	ANTENNA HEIGHT (m)	TABLE ANGLE (Degree)	RAW VALUE (dBuV)	CORRECTION FACTOR (dB/m)
1	*5320.00	115.1 PK			1.46 H	349	76.1	39.0
2	*5320.00	105.0 AV			1.46 H	349	66.0	39.0
3	5350.00	64.1 PK	74.0	-9.9	1.60 H	356	63.0	1.1
4	5350.00	49.6 AV	54.0	-4.4	1.60 H	356	48.5	1.1
5	10640.00	60.8 PK	74.0	-13.2	1.29 H	223	46.9	13.9
6	10640.00	47.4 AV	54.0	-6.6	1.29 H	223	33.5	13.9
ANTENNA POLARITY & TEST DISTANCE: VERTICAL AT 3 M								
NO.	FREQ. (MHz)	EMISSION LEVEL (dBuV/m)	LIMIT (dBuV/m)	MARGIN (dB)	ANTENNA HEIGHT (m)	TABLE ANGLE (Degree)	RAW VALUE (dBuV)	CORRECTION FACTOR (dB/m)
1	*5320.00	115.4 PK			1.27 V	348	76.4	39.0
2	*5320.00	105.1 AV			1.27 V	348	66.1	39.0
3	5350.00	64.0 PK	74.0	-10.0	1.48 V	347	62.9	1.1
4	5350.00	50.5 AV	54.0	-3.5	1.48 V	347	49.4	1.1
5	10640.00	61.4 PK	74.0	-12.6	1.13 V	301	47.5	13.9
6	10640.00	47.3 AV	54.0	-6.7	1.13 V	301	33.4	13.9

Remarks:

1. Emission Level(dBuV/m) = Raw Value(dBuV) + Correction Factor(dB/m)
2. Correction Factor(dB/m) = Antenna Factor(dB/m) + Cable Factor(dB) – Pre-Amplifier Factor(dB)
3. The other emission levels were very low against the limit.
4. Margin value = Emission Level – Limit value
5. " * ": Fundamental frequency.
6. " # ": The radiated frequency is out of the restricted band.

CHANNEL	TX Channel 100	DETECTOR FUNCTION	Peak (PK)
FREQUENCY RANGE	1GHz ~ 40GHz		Average (AV)

ANTENNA POLARITY & TEST DISTANCE: HORIZONTAL AT 3 M								
NO.	FREQ. (MHz)	EMISSION LEVEL (dBuV/m)	LIMIT (dBuV/m)	MARGIN (dB)	ANTENNA HEIGHT (m)	TABLE ANGLE (Degree)	RAW VALUE (dBuV)	CORRECTION FACTOR (dB/m)
1	5460.00	60.1 PK	74.0	-13.9	2.06 H	324	58.9	1.2
2	5460.00	45.1 AV	54.0	-8.9	2.06 H	324	43.9	1.2
3	#5470.00	64.0 PK	74.0	-10.0	1.88 H	355	62.8	1.2
4	#5470.00	49.4 AV	54.0	-4.6	1.88 H	355	48.2	1.2
5	*5500.00	115.6 PK			1.84 H	347	76.3	39.3
6	*5500.00	104.3 AV			1.84 H	347	65.0	39.3
7	11000.00	61.9 PK	74.0	-12.1	1.13 H	331	46.6	15.3
8	11000.00	47.8 AV	54.0	-6.2	1.13 H	331	32.5	15.3

ANTENNA POLARITY & TEST DISTANCE: VERTICAL AT 3 M								
NO.	FREQ. (MHz)	EMISSION LEVEL (dBuV/m)	LIMIT (dBuV/m)	MARGIN (dB)	ANTENNA HEIGHT (m)	TABLE ANGLE (Degree)	RAW VALUE (dBuV)	CORRECTION FACTOR (dB/m)
1	5460.00	62.8 PK	74.0	-11.2	1.61 V	313	61.6	1.2
2	5460.00	46.6 AV	54.0	-7.4	1.61 V	313	45.4	1.2
3	#5470.00	64.5 PK	74.0	-9.5	1.91 V	353	63.3	1.2
4	#5470.00	50.3 AV	54.0	-3.7	1.91 V	353	49.1	1.2
5	*5500.00	116.0 PK			1.20 V	354	76.7	39.3
6	*5500.00	105.2 AV			1.20 V	354	65.9	39.3
7	11000.00	60.6 PK	74.0	-13.4	1.33 V	307	45.3	15.3
8	11000.00	47.5 AV	54.0	-6.5	1.33 V	307	32.2	15.3

Remarks:

1. Emission Level(dBuV/m) = Raw Value(dBuV) + Correction Factor(dB/m)
2. Correction Factor(dB/m) = Antenna Factor(dB/m) + Cable Factor(dB) – Pre-Amplifier Factor(dB)
3. The other emission levels were very low against the limit.
4. Margin value = Emission Level – Limit value
5. " * ": Fundamental frequency.
6. " # ": The radiated frequency is out of the restricted band.

CHANNEL	TX Channel 116	DETECTOR FUNCTION	Peak (PK)
FREQUENCY RANGE	1GHz ~ 40GHz		Average (AV)

ANTENNA POLARITY & TEST DISTANCE: HORIZONTAL AT 3 M

NO.	FREQ. (MHz)	EMISSION LEVEL (dBuV/m)	LIMIT (dBuV/m)	MARGIN (dB)	ANTENNA HEIGHT (m)	TABLE ANGLE (Degree)	RAW VALUE (dBuV)	CORRECTION FACTOR (dB/m)
1	*5580.00	116.9 PK			1.95 H	353	77.4	39.5
2	*5580.00	106.0 AV			1.95 H	353	66.5	39.5
3	11160.00	60.5 PK	74.0	-13.5	1.47 H	339	45.6	14.9
4	11160.00	47.2 AV	54.0	-6.8	1.47 H	339	32.3	14.9

ANTENNA POLARITY & TEST DISTANCE: VERTICAL AT 3 M

NO.	FREQ. (MHz)	EMISSION LEVEL (dBuV/m)	LIMIT (dBuV/m)	MARGIN (dB)	ANTENNA HEIGHT (m)	TABLE ANGLE (Degree)	RAW VALUE (dBuV)	CORRECTION FACTOR (dB/m)
1	*5580.00	118.0 PK			1.08 V	348	78.5	39.5
2	*5580.00	106.5 AV			1.08 V	348	67.0	39.5
3	11160.00	60.8 PK	74.0	-13.2	1.11 V	338	45.9	14.9
4	11160.00	47.3 AV	54.0	-6.7	1.11 V	338	32.4	14.9

Remarks:

1. Emission Level(dBuV/m) = Raw Value(dBuV) + Correction Factor(dB/m)
2. Correction Factor(dB/m) = Antenna Factor(dB/m) + Cable Factor(dB) – Pre-Amplifier Factor(dB)
3. The other emission levels were very low against the limit.
4. Margin value = Emission Level – Limit value
5. " * ": Fundamental frequency.
6. " # ": The radiated frequency is out of the restricted band.

CHANNEL	TX Channel 140	DETECTOR FUNCTION	Peak (PK)
FREQUENCY RANGE	1GHz ~ 40GHz		Average (AV)

ANTENNA POLARITY & TEST DISTANCE: HORIZONTAL AT 3 M

NO.	FREQ. (MHz)	EMISSION LEVEL (dBuV/m)	LIMIT (dBuV/m)	MARGIN (dB)	ANTENNA HEIGHT (m)	TABLE ANGLE (Degree)	RAW VALUE (dBuV)	CORRECTION FACTOR (dB/m)
1	*5700.00	115.0 PK			2.04 H	357	75.2	39.8
2	*5700.00	103.7 AV			2.04 H	357	63.9	39.8
3	#5725.00	64.3 PK	74.0	-9.7	1.51 H	353	62.3	2.0
4	#5725.00	51.1 AV	54.0	-2.9	1.51 H	353	49.1	2.0
5	11400.00	60.4 PK	74.0	-13.6	1.76 H	324	45.9	14.5
6	11400.00	47.2 AV	54.0	-6.8	1.76 H	324	32.7	14.5

ANTENNA POLARITY & TEST DISTANCE: VERTICAL AT 3 M

NO.	FREQ. (MHz)	EMISSION LEVEL (dBuV/m)	LIMIT (dBuV/m)	MARGIN (dB)	ANTENNA HEIGHT (m)	TABLE ANGLE (Degree)	RAW VALUE (dBuV)	CORRECTION FACTOR (dB/m)
1	*5700.00	115.0 PK			1.04 V	349	75.2	39.8
2	*5700.00	104.6 AV			1.04 V	349	64.8	39.8
3	#5725.00	65.7 PK	74.0	-8.3	1.04 V	350	63.7	2.0
4	#5725.00	51.8 AV	54.0	-2.2	1.04 V	350	49.8	2.0
5	11400.00	61.3 PK	74.0	-12.7	1.22 V	308	46.8	14.5
6	11400.00	47.3 AV	54.0	-6.7	1.22 V	308	32.8	14.5

Remarks:

1. Emission Level(dBuV/m) = Raw Value(dBuV) + Correction Factor(dB/m)
2. Correction Factor(dB/m) = Antenna Factor(dB/m) + Cable Factor(dB) – Pre-Amplifier Factor(dB)
3. The other emission levels were very low against the limit.
4. Margin value = Emission Level – Limit value
5. " * ": Fundamental frequency.
6. " # ": The radiated frequency is out of the restricted band.

CHANNEL	TX Channel 144	DETECTOR FUNCTION	Peak (PK)
FREQUENCY RANGE	1GHz ~ 40GHz		Average (AV)

ANTENNA POLARITY & TEST DISTANCE: HORIZONTAL AT 3 M								
NO.	FREQ. (MHz)	EMISSION LEVEL (dBuV/m)	LIMIT (dBuV/m)	MARGIN (dB)	ANTENNA HEIGHT (m)	TABLE ANGLE (Degree)	RAW VALUE (dBuV)	CORRECTION FACTOR (dB/m)
1	#5470.00	55.5 PK	74.0	-18.5	1.79 H	349	54.3	1.2
2	#5470.00	43.1 AV	54.0	-10.9	1.79 H	349	41.9	1.2
3	*5720.00	114.9 PK			2.12 H	4	75.0	39.9
4	*5720.00	104.0 AV			2.12 H	4	64.1	39.9
5	#5825.00	56.1 PK	74.0	-17.9	2.04 H	355	53.9	2.2
6	#5825.00	44.7 AV	54.0	-9.3	2.04 H	355	42.5	2.2
7	11440.00	60.4 PK	74.0	-13.6	1.93 H	335	45.9	14.5
8	11440.00	46.6 AV	54.0	-7.4	1.93 H	335	32.1	14.5

ANTENNA POLARITY & TEST DISTANCE: VERTICAL AT 3 M								
NO.	FREQ. (MHz)	EMISSION LEVEL (dBuV/m)	LIMIT (dBuV/m)	MARGIN (dB)	ANTENNA HEIGHT (m)	TABLE ANGLE (Degree)	RAW VALUE (dBuV)	CORRECTION FACTOR (dB/m)
1	#5470.00	55.8 PK	74.0	-18.2	1.52 V	352	54.6	1.2
2	#5470.00	43.4 AV	54.0	-10.6	1.52 V	352	42.2	1.2
3	*5720.00	114.2 PK			1.13 V	340	74.3	39.9
4	*5720.00	103.5 AV			1.13 V	340	63.6	39.9
5	#5825.00	56.8 PK	74.0	-17.2	1.34 V	347	54.6	2.2
6	#5825.00	44.6 AV	54.0	-9.4	1.34 V	347	42.4	2.2
7	11440.00	60.9 PK	74.0	-13.1	1.86 V	327	46.4	14.5
8	11440.00	47.0 AV	54.0	-7.0	1.86 V	327	32.5	14.5

Remarks:

1. Emission Level(dBuV/m) = Raw Value(dBuV) + Correction Factor(dB/m)
2. Correction Factor(dB/m) = Antenna Factor(dB/m) + Cable Factor(dB) – Pre-Amplifier Factor(dB)
3. The other emission levels were very low against the limit.
4. Margin value = Emission Level – Limit value
5. " * ": Fundamental frequency.
6. " # ": The radiated frequency is out of the restricted band.

802.11n (HT20)

CHANNEL	TX Channel 52	DETECTOR FUNCTION	Peak (PK)
FREQUENCY RANGE	1GHz ~ 40GHz		Average (AV)

ANTENNA POLARITY & TEST DISTANCE: HORIZONTAL AT 3 M								
NO.	FREQ. (MHz)	EMISSION LEVEL (dBuV/m)	LIMIT (dBuV/m)	MARGIN (dB)	ANTENNA HEIGHT (m)	TABLE ANGLE (Degree)	RAW VALUE (dBuV)	CORRECTION FACTOR (dB/m)
1	5150.00	53.2 PK	74.0	-20.8	1.33 H	329	52.4	0.8
2	5150.00	40.3 AV	54.0	-13.7	1.33 H	329	39.5	0.8
3	*5260.00	118.8 PK			1.22 H	344	80.0	38.8
4	*5260.00	108.2 AV			1.22 H	344	69.4	38.8
5	#10520.00	60.7 PK	74.0	-13.3	1.36 H	282	47.0	13.7
6	#10520.00	46.9 AV	54.0	-7.1	1.36 H	282	33.2	13.7
ANTENNA POLARITY & TEST DISTANCE: VERTICAL AT 3 M								
NO.	FREQ. (MHz)	EMISSION LEVEL (dBuV/m)	LIMIT (dBuV/m)	MARGIN (dB)	ANTENNA HEIGHT (m)	TABLE ANGLE (Degree)	RAW VALUE (dBuV)	CORRECTION FACTOR (dB/m)
1	5150.00	53.6 PK	74.0	-20.4	1.54 V	343	52.8	0.8
2	5150.00	41.7 AV	54.0	-12.3	1.54 V	343	40.9	0.8
3	*5260.00	117.8 PK			1.10 V	345	79.0	38.8
4	*5260.00	107.2 AV			1.10 V	345	68.4	38.8
5	#10520.00	61.0 PK	74.0	-13.0	1.22 V	311	47.3	13.7
6	#10520.00	47.3 AV	54.0	-6.7	1.22 V	311	33.6	13.7

Remarks:

1. Emission Level(dBuV/m) = Raw Value(dBuV) + Correction Factor(dB/m)
2. Correction Factor(dB/m) = Antenna Factor(dB/m) + Cable Factor(dB) – Pre-Amplifier Factor(dB)
3. The other emission levels were very low against the limit.
4. Margin value = Emission Level – Limit value
5. " * ": Fundamental frequency.
6. " # ": The radiated frequency is out of the restricted band.

CHANNEL	TX Channel 60	DETECTOR FUNCTION	Peak (PK)
FREQUENCY RANGE	1GHz ~ 40GHz		Average (AV)

ANTENNA POLARITY & TEST DISTANCE: HORIZONTAL AT 3 M								
NO.	FREQ. (MHz)	EMISSION LEVEL (dBuV/m)	LIMIT (dBuV/m)	MARGIN (dB)	ANTENNA HEIGHT (m)	TABLE ANGLE (Degree)	RAW VALUE (dBuV)	CORRECTION FACTOR (dB/m)
1	*5300.00	117.9 PK			1.26 H	347	79.0	38.9
2	*5300.00	106.9 AV			1.26 H	347	68.0	38.9
3	5350.00	63.6 PK	74.0	-10.4	1.22 H	356	62.5	1.1
4	5350.00	46.8 AV	54.0	-7.2	1.22 H	356	45.7	1.1
5	10600.00	61.5 PK	74.0	-12.5	1.12 H	263	47.7	13.8
6	10600.00	47.8 AV	54.0	-6.2	1.12 H	263	34.0	13.8

ANTENNA POLARITY & TEST DISTANCE: VERTICAL AT 3 M								
NO.	FREQ. (MHz)	EMISSION LEVEL (dBuV/m)	LIMIT (dBuV/m)	MARGIN (dB)	ANTENNA HEIGHT (m)	TABLE ANGLE (Degree)	RAW VALUE (dBuV)	CORRECTION FACTOR (dB/m)
1	*5300.00	118.8 PK			1.89 V	356	79.9	38.9
2	*5300.00	107.2 AV			1.89 V	356	68.3	38.9
3	5350.00	65.0 PK	74.0	-9.0	1.25 V	351	63.9	1.1
4	5350.00	47.2 AV	54.0	-6.8	1.25 V	351	46.1	1.1
5	10600.00	59.7 PK	74.0	-14.3	1.71 V	313	45.9	13.8
6	10600.00	46.0 AV	54.0	-8.0	1.71 V	313	32.2	13.8

Remarks:

1. Emission Level(dBuV/m) = Raw Value(dBuV) + Correction Factor(dB/m)
2. Correction Factor(dB/m) = Antenna Factor(dB/m) + Cable Factor(dB) – Pre-Amplifier Factor(dB)
3. The other emission levels were very low against the limit.
4. Margin value = Emission Level – Limit value
5. " * ": Fundamental frequency.
6. " # ": The radiated frequency is out of the restricted band.

CHANNEL	TX Channel 64	DETECTOR FUNCTION	Peak (PK)
FREQUENCY RANGE	1GHz ~ 40GHz		Average (AV)

ANTENNA POLARITY & TEST DISTANCE: HORIZONTAL AT 3 M								
NO.	FREQ. (MHz)	EMISSION LEVEL (dBuV/m)	LIMIT (dBuV/m)	MARGIN (dB)	ANTENNA HEIGHT (m)	TABLE ANGLE (Degree)	RAW VALUE (dBuV)	CORRECTION FACTOR (dB/m)
1	*5320.00	115.1 PK			1.21 H	347	76.1	39.0
2	*5320.00	103.5 AV			1.21 H	347	64.5	39.0
3	5350.00	63.0 PK	74.0	-11.0	1.24 H	357	61.9	1.1
4	5350.00	49.4 AV	54.0	-4.6	1.24 H	357	48.3	1.1
5	10640.00	61.7 PK	74.0	-12.3	1.39 H	249	47.8	13.9
6	10640.00	47.3 AV	54.0	-6.7	1.39 H	249	33.4	13.9
ANTENNA POLARITY & TEST DISTANCE: VERTICAL AT 3 M								
NO.	FREQ. (MHz)	EMISSION LEVEL (dBuV/m)	LIMIT (dBuV/m)	MARGIN (dB)	ANTENNA HEIGHT (m)	TABLE ANGLE (Degree)	RAW VALUE (dBuV)	CORRECTION FACTOR (dB/m)
1	*5320.00	115.4 PK			1.27 V	342	76.4	39.0
2	*5320.00	104.7 AV			1.27 V	342	65.7	39.0
3	5350.00	64.0 PK	74.0	-10.0	1.27 V	350	62.9	1.1
4	5350.00	50.4 AV	54.0	-3.6	1.27 V	350	49.3	1.1
5	10640.00	59.3 PK	74.0	-14.7	1.14 V	289	45.4	13.9
6	10640.00	46.0 AV	54.0	-8.0	1.14 V	289	32.1	13.9

Remarks:

1. Emission Level(dBuV/m) = Raw Value(dBuV) + Correction Factor(dB/m)
2. Correction Factor(dB/m) = Antenna Factor(dB/m) + Cable Factor(dB) – Pre-Amplifier Factor(dB)
3. The other emission levels were very low against the limit.
4. Margin value = Emission Level – Limit value
5. " * ": Fundamental frequency.
6. " # ": The radiated frequency is out of the restricted band.

CHANNEL	TX Channel 100	DETECTOR FUNCTION	Peak (PK)
FREQUENCY RANGE	1GHz ~ 40GHz		Average (AV)

ANTENNA POLARITY & TEST DISTANCE: HORIZONTAL AT 3 M								
NO.	FREQ. (MHz)	EMISSION LEVEL (dBuV/m)	LIMIT (dBuV/m)	MARGIN (dB)	ANTENNA HEIGHT (m)	TABLE ANGLE (Degree)	RAW VALUE (dBuV)	CORRECTION FACTOR (dB/m)
1	5460.00	59.7 PK	74.0	-14.3	1.64 H	339	58.5	1.2
2	5460.00	45.9 AV	54.0	-8.1	1.64 H	339	44.7	1.2
3	#5470.00	64.4 PK	74.0	-9.6	1.91 H	353	63.2	1.2
4	#5470.00	49.6 AV	54.0	-4.4	1.91 H	353	48.4	1.2
5	*5500.00	115.5 PK			1.63 H	353	76.2	39.3
6	*5500.00	104.1 AV			1.63 H	353	64.8	39.3
7	11000.00	61.1 PK	74.0	-12.9	1.55 H	343	45.8	15.3
8	11000.00	47.8 AV	54.0	-6.2	1.55 H	343	32.5	15.3

ANTENNA POLARITY & TEST DISTANCE: VERTICAL AT 3 M								
NO.	FREQ. (MHz)	EMISSION LEVEL (dBuV/m)	LIMIT (dBuV/m)	MARGIN (dB)	ANTENNA HEIGHT (m)	TABLE ANGLE (Degree)	RAW VALUE (dBuV)	CORRECTION FACTOR (dB/m)
1	5460.00	59.3 PK	74.0	-14.7	1.19 V	314	58.1	1.2
2	5460.00	46.9 AV	54.0	-7.1	1.19 V	314	45.7	1.2
3	#5470.00	63.9 PK	74.0	-10.1	1.42 V	353	62.7	1.2
4	#5470.00	50.3 AV	54.0	-3.7	1.42 V	353	49.1	1.2
5	*5500.00	115.9 PK			1.09 V	351	76.6	39.3
6	*5500.00	105.2 AV			1.09 V	351	65.9	39.3
7	11000.00	61.8 PK	74.0	-12.2	1.33 V	328	46.5	15.3
8	11000.00	47.7 AV	54.0	-6.3	1.33 V	328	32.4	15.3

Remarks:

1. Emission Level(dBuV/m) = Raw Value(dBuV) + Correction Factor(dB/m)
2. Correction Factor(dB/m) = Antenna Factor(dB/m) + Cable Factor(dB) – Pre-Amplifier Factor(dB)
3. The other emission levels were very low against the limit.
4. Margin value = Emission Level – Limit value
5. " * ": Fundamental frequency.
6. " # ": The radiated frequency is out of the restricted band.

CHANNEL	TX Channel 116	DETECTOR FUNCTION	Peak (PK)
FREQUENCY RANGE	1GHz ~ 40GHz		Average (AV)

ANTENNA POLARITY & TEST DISTANCE: HORIZONTAL AT 3 M								
NO.	FREQ. (MHz)	EMISSION LEVEL (dBuV/m)	LIMIT (dBuV/m)	MARGIN (dB)	ANTENNA HEIGHT (m)	TABLE ANGLE (Degree)	RAW VALUE (dBuV)	CORRECTION FACTOR (dB/m)
1	*5580.00	115.8 PK			1.46 H	351	76.3	39.5
2	*5580.00	105.0 AV			1.46 H	351	65.5	39.5
3	11160.00	60.7 PK	74.0	-13.3	3.46 H	177	45.8	14.9
4	11160.00	47.2 AV	54.0	-6.8	3.46 H	177	32.3	14.9
ANTENNA POLARITY & TEST DISTANCE: VERTICAL AT 3 M								
NO.	FREQ. (MHz)	EMISSION LEVEL (dBuV/m)	LIMIT (dBuV/m)	MARGIN (dB)	ANTENNA HEIGHT (m)	TABLE ANGLE (Degree)	RAW VALUE (dBuV)	CORRECTION FACTOR (dB/m)
1	*5580.00	116.2 PK			1.07 V	353	76.7	39.5
2	*5580.00	105.5 AV			1.07 V	353	66.0	39.5
3	11160.00	61.3 PK	74.0	-12.7	1.48 V	347	46.4	14.9
4	11160.00	47.4 AV	54.0	-6.6	1.48 V	347	32.5	14.9

Remarks:

1. Emission Level(dBuV/m) = Raw Value(dBuV) + Correction Factor(dB/m)
2. Correction Factor(dB/m) = Antenna Factor(dB/m) + Cable Factor(dB) – Pre-Amplifier Factor(dB)
3. The other emission levels were very low against the limit.
4. Margin value = Emission Level – Limit value
5. " * ": Fundamental frequency.
6. " # ": The radiated frequency is out of the restricted band.

CHANNEL	TX Channel 140	DETECTOR FUNCTION	Peak (PK)
FREQUENCY RANGE	1GHz ~ 40GHz		Average (AV)

ANTENNA POLARITY & TEST DISTANCE: HORIZONTAL AT 3 M								
NO.	FREQ. (MHz)	EMISSION LEVEL (dBuV/m)	LIMIT (dBuV/m)	MARGIN (dB)	ANTENNA HEIGHT (m)	TABLE ANGLE (Degree)	RAW VALUE (dBuV)	CORRECTION FACTOR (dB/m)
1	*5700.00	114.0 PK			1.43 H	3	74.2	39.8
2	*5700.00	103.2 AV			1.43 H	3	63.4	39.8
3	#5725.00	64.9 PK	74.0	-9.1	1.29 H	356	62.9	2.0
4	#5725.00	51.0 AV	54.0	-3.0	1.29 H	356	49.0	2.0
5	11400.00	61.1 PK	74.0	-12.9	1.44 H	331	46.6	14.5
6	11400.00	47.5 AV	54.0	-6.5	1.44 H	331	33.0	14.5
ANTENNA POLARITY & TEST DISTANCE: VERTICAL AT 3 M								
NO.	FREQ. (MHz)	EMISSION LEVEL (dBuV/m)	LIMIT (dBuV/m)	MARGIN (dB)	ANTENNA HEIGHT (m)	TABLE ANGLE (Degree)	RAW VALUE (dBuV)	CORRECTION FACTOR (dB/m)
1	*5700.00	115.0 PK			1.08 V	350	75.2	39.8
2	*5700.00	104.1 AV			1.08 V	350	64.3	39.8
3	#5725.00	65.7 PK	74.0	-8.3	1.11 V	349	63.7	2.0
4	#5725.00	52.0 AV	54.0	-2.0	1.11 V	349	50.0	2.0
5	11400.00	61.5 PK	74.0	-12.5	1.59 V	328	47.0	14.5
6	11400.00	47.5 AV	54.0	-6.5	1.59 V	328	33.0	14.5

Remarks:

1. Emission Level(dBuV/m) = Raw Value(dBuV) + Correction Factor(dB/m)
2. Correction Factor(dB/m) = Antenna Factor(dB/m) + Cable Factor(dB) – Pre-Amplifier Factor(dB)
3. The other emission levels were very low against the limit.
4. Margin value = Emission Level – Limit value
5. " * ": Fundamental frequency.
6. " # ": The radiated frequency is out of the restricted band.

CHANNEL	TX Channel 144	DETECTOR FUNCTION	Peak (PK)
FREQUENCY RANGE	1GHz ~ 40GHz		Average (AV)

ANTENNA POLARITY & TEST DISTANCE: HORIZONTAL AT 3 M								
NO.	FREQ. (MHz)	EMISSION LEVEL (dBuV/m)	LIMIT (dBuV/m)	MARGIN (dB)	ANTENNA HEIGHT (m)	TABLE ANGLE (Degree)	RAW VALUE (dBuV)	CORRECTION FACTOR (dB/m)
1	#5470.00	54.1 PK	74.0	-19.9	1.81 H	302	52.9	1.2
2	#5470.00	42.7 AV	54.0	-11.3	1.81 H	302	41.5	1.2
3	*5720.00	121.3 PK			2.48 H	13	81.4	39.9
4	*5720.00	110.6 AV			2.48 H	13	70.7	39.9
5	#5825.00	57.4 PK	74.0	-16.6	2.31 H	324	55.2	2.2
6	#5825.00	43.7 AV	54.0	-10.3	2.31 H	324	41.5	2.2
7	11440.00	60.4 PK	74.0	-13.6	1.77 H	359	45.9	14.5
8	11440.00	46.7 AV	54.0	-7.3	1.77 H	359	32.2	14.5
ANTENNA POLARITY & TEST DISTANCE: VERTICAL AT 3 M								
NO.	FREQ. (MHz)	EMISSION LEVEL (dBuV/m)	LIMIT (dBuV/m)	MARGIN (dB)	ANTENNA HEIGHT (m)	TABLE ANGLE (Degree)	RAW VALUE (dBuV)	CORRECTION FACTOR (dB/m)
1	#5470.00	55.1 PK	74.0	-18.9	1.27 V	344	53.9	1.2
2	#5470.00	43.1 AV	54.0	-10.9	1.27 V	344	41.9	1.2
3	*5720.00	122.4 PK			1.11 V	349	82.5	39.9
4	*5720.00	111.4 AV			1.11 V	349	71.5	39.9
5	#5825.00	58.8 PK	74.0	-15.2	1.16 V	355	56.6	2.2
6	#5825.00	44.9 AV	54.0	-9.1	1.16 V	355	42.7	2.2
7	11440.00	59.5 PK	74.0	-14.5	1.21 V	358	45.0	14.5
8	11440.00	46.5 AV	54.0	-7.5	1.21 V	358	32.0	14.5

Remarks:

1. Emission Level(dBuV/m) = Raw Value(dBuV) + Correction Factor(dB/m)
2. Correction Factor(dB/m) = Antenna Factor(dB/m) + Cable Factor(dB) – Pre-Amplifier Factor(dB)
3. The other emission levels were very low against the limit.
4. Margin value = Emission Level – Limit value
5. " * ": Fundamental frequency.
6. " # ": The radiated frequency is out of the restricted band.

802.11n (HT40)

CHANNEL	TX Channel 54	DETECTOR	Peak (PK)
FREQUENCY RANGE	1GHz ~ 40GHz	FUNCTION	Average (AV)

ANTENNA POLARITY & TEST DISTANCE: HORIZONTAL AT 3 M

NO.	FREQ. (MHz)	EMISSION LEVEL (dBuV/m)	LIMIT (dBuV/m)	MARGIN (dB)	ANTENNA HEIGHT (m)	TABLE ANGLE (Degree)	RAW VALUE (dBuV)	CORRECTION FACTOR (dB/m)
1	5150.00	53.9 PK	74.0	-20.1	1.96 H	350	53.1	0.8
2	5150.00	40.7 AV	54.0	-13.3	1.96 H	350	39.9	0.8
3	*5270.00	111.8 PK			1.26 H	342	72.9	38.9
4	*5270.00	101.8 AV			1.26 H	342	62.9	38.9
5	5350.00	56.3 PK	74.0	-17.7	1.99 H	338	55.2	1.1
6	5350.00	45.4 AV	54.0	-8.6	1.99 H	338	44.3	1.1
7	#10540.00	58.8 PK	74.0	-15.2	1.37 H	241	45.1	13.7
8	#10540.00	45.4 AV	54.0	-8.6	1.37 H	241	31.7	13.7

ANTENNA POLARITY & TEST DISTANCE: VERTICAL AT 3 M

NO.	FREQ. (MHz)	EMISSION LEVEL (dBuV/m)	LIMIT (dBuV/m)	MARGIN (dB)	ANTENNA HEIGHT (m)	TABLE ANGLE (Degree)	RAW VALUE (dBuV)	CORRECTION FACTOR (dB/m)
1	5150.00	54.5 PK	74.0	-19.5	1.50 V	340	53.7	0.8
2	5150.00	42.6 AV	54.0	-11.4	1.50 V	340	41.8	0.8
3	*5270.00	112.2 PK			1.94 V	349	73.3	38.9
4	*5270.00	102.7 AV			1.94 V	349	63.8	38.9
5	5350.00	61.4 PK	74.0	-12.6	1.55 V	352	60.3	1.1
6	5350.00	47.4 AV	54.0	-6.6	1.55 V	352	46.3	1.1
7	#10540.00	59.1 PK	74.0	-14.9	1.58 V	302	45.4	13.7
8	#10540.00	45.9 AV	54.0	-8.1	1.58 V	302	32.2	13.7

Remarks:

1. Emission Level(dBuV/m) = Raw Value(dBuV) + Correction Factor(dB/m)
2. Correction Factor(dB/m) = Antenna Factor(dB/m) + Cable Factor(dB) – Pre-Amplifier Factor(dB)
3. The other emission levels were very low against the limit.
4. Margin value = Emission Level – Limit value
5. " * ": Fundamental frequency.
6. " # ": The radiated frequency is out of the restricted band.

CHANNEL	TX Channel 62	DETECTOR FUNCTION	Peak (PK)
FREQUENCY RANGE	1GHz ~ 40GHz		Average (AV)

ANTENNA POLARITY & TEST DISTANCE: HORIZONTAL AT 3 M								
NO.	FREQ. (MHz)	EMISSION LEVEL (dBuV/m)	LIMIT (dBuV/m)	MARGIN (dB)	ANTENNA HEIGHT (m)	TABLE ANGLE (Degree)	RAW VALUE (dBuV)	CORRECTION FACTOR (dB/m)
1	*5310.00	110.2 PK			1.20 H	345	71.3	38.9
2	*5310.00	100.8 AV			1.20 H	345	61.9	38.9
3	5350.00	63.2 PK	74.0	-10.8	1.77 H	352	62.1	1.1
4	5350.00	50.3 AV	54.0	-3.7	1.77 H	352	49.2	1.1
5	10620.00	58.8 PK	74.0	-15.2	1.33 H	277	45.0	13.8
6	10620.00	45.7 AV	54.0	-8.3	1.33 H	277	31.9	13.8
ANTENNA POLARITY & TEST DISTANCE: VERTICAL AT 3 M								
NO.	FREQ. (MHz)	EMISSION LEVEL (dBuV/m)	LIMIT (dBuV/m)	MARGIN (dB)	ANTENNA HEIGHT (m)	TABLE ANGLE (Degree)	RAW VALUE (dBuV)	CORRECTION FACTOR (dB/m)
1	*5310.00	110.9 PK			1.08 V	347	72.0	38.9
2	*5310.00	101.4 AV			1.08 V	347	62.5	38.9
3	5350.00	64.1 PK	74.0	-9.9	2.23 V	352	63.0	1.1
4	5350.00	51.7 AV	54.0	-2.3	2.23 V	352	50.6	1.1
5	10620.00	59.3 PK	74.0	-14.7	1.11 V	324	45.5	13.8
6	10620.00	46.2 AV	54.0	-7.8	1.11 V	324	32.4	13.8

Remarks:

1. Emission Level(dBuV/m) = Raw Value(dBuV) + Correction Factor(dB/m)
2. Correction Factor(dB/m) = Antenna Factor(dB/m) + Cable Factor(dB) – Pre-Amplifier Factor(dB)
3. The other emission levels were very low against the limit.
4. Margin value = Emission Level – Limit value
5. " * ": Fundamental frequency.
6. " # ": The radiated frequency is out of the restricted band.

CHANNEL	TX Channel 102	DETECTOR FUNCTION	Peak (PK)
FREQUENCY RANGE	1GHz ~ 40GHz		Average (AV)

ANTENNA POLARITY & TEST DISTANCE: HORIZONTAL AT 3 M								
NO.	FREQ. (MHz)	EMISSION LEVEL (dBuV/m)	LIMIT (dBuV/m)	MARGIN (dB)	ANTENNA HEIGHT (m)	TABLE ANGLE (Degree)	RAW VALUE (dBuV)	CORRECTION FACTOR (dB/m)
1	5460.00	61.1 PK	74.0	-12.9	1.22 H	338	59.9	1.2
2	5460.00	49.1 AV	54.0	-4.9	1.22 H	338	47.9	1.2
3	#5470.00	66.4 PK	74.0	-7.6	1.42 H	350	65.2	1.2
4	#5470.00	52.1 AV	54.0	-1.9	1.42 H	350	50.9	1.2
5	*5510.00	111.6 PK			1.60 H	354	72.3	39.3
6	*5510.00	101.5 AV			1.60 H	354	62.2	39.3
7	11020.00	61.3 PK	74.0	-12.7	1.16 H	338	46.1	15.2
8	11020.00	47.9 AV	54.0	-6.1	1.16 H	338	32.7	15.2

ANTENNA POLARITY & TEST DISTANCE: VERTICAL AT 3 M								
NO.	FREQ. (MHz)	EMISSION LEVEL (dBuV/m)	LIMIT (dBuV/m)	MARGIN (dB)	ANTENNA HEIGHT (m)	TABLE ANGLE (Degree)	RAW VALUE (dBuV)	CORRECTION FACTOR (dB/m)
1	5460.00	61.0 PK	74.0	-13.0	1.17 V	319	59.8	1.2
2	5460.00	49.1 AV	54.0	-4.9	1.17 V	319	47.9	1.2
3	#5470.00	67.1 PK	74.0	-6.9	1.06 V	349	65.9	1.2
4	#5470.00	52.6 AV	54.0	-1.4	1.06 V	349	51.4	1.2
5	*5510.00	111.2 PK			1.40 V	349	71.9	39.3
6	*5510.00	101.7 AV			1.40 V	349	62.4	39.3
7	11020.00	61.0 PK	74.0	-13.0	1.22 V	343	45.8	15.2
8	11020.00	47.9 AV	54.0	-6.1	1.22 V	343	32.7	15.2

Remarks:

1. Emission Level(dBuV/m) = Raw Value(dBuV) + Correction Factor(dB/m)
2. Correction Factor(dB/m) = Antenna Factor(dB/m) + Cable Factor(dB) – Pre-Amplifier Factor(dB)
3. The other emission levels were very low against the limit.
4. Margin value = Emission Level – Limit value
5. " * ": Fundamental frequency.
6. " # ": The radiated frequency is out of the restricted band.

CHANNEL	TX Channel 110	DETECTOR	Peak (PK)
FREQUENCY RANGE	1GHz ~ 40GHz	FUNCTION	Average (AV)

ANTENNA POLARITY & TEST DISTANCE: HORIZONTAL AT 3 M								
NO.	FREQ. (MHz)	EMISSION LEVEL (dBuV/m)	LIMIT (dBuV/m)	MARGIN (dB)	ANTENNA HEIGHT (m)	TABLE ANGLE (Degree)	RAW VALUE (dBuV)	CORRECTION FACTOR (dB/m)
1	*5550.00	112.7 PK			1.29 H	354	73.4	39.3
2	*5550.00	102.9 AV			1.29 H	354	63.6	39.3
3	11100.00	60.8 PK	74.0	-13.2	1.12 H	353	46.0	14.8
4	11100.00	47.5 AV	54.0	-6.5	1.12 H	353	32.7	14.8
ANTENNA POLARITY & TEST DISTANCE: VERTICAL AT 3 M								
NO.	FREQ. (MHz)	EMISSION LEVEL (dBuV/m)	LIMIT (dBuV/m)	MARGIN (dB)	ANTENNA HEIGHT (m)	TABLE ANGLE (Degree)	RAW VALUE (dBuV)	CORRECTION FACTOR (dB/m)
1	*5550.00	112.7 PK			1.09 V	347	73.4	39.3
2	*5550.00	103.0 AV			1.09 V	347	63.7	39.3
3	11100.00	60.6 PK	74.0	-13.4	1.18 V	322	45.8	14.8
4	11100.00	47.5 AV	54.0	-6.5	1.18 V	322	32.7	14.8

Remarks:

1. Emission Level(dBuV/m) = Raw Value(dBuV) + Correction Factor(dB/m)
2. Correction Factor(dB/m) = Antenna Factor(dB/m) + Cable Factor(dB) – Pre-Amplifier Factor(dB)
3. The other emission levels were very low against the limit.
4. Margin value = Emission Level – Limit value
5. " * ": Fundamental frequency.
6. " # ": The radiated frequency is out of the restricted band.

CHANNEL	TX Channel 134	DETECTOR FUNCTION	Peak (PK)
FREQUENCY RANGE	1GHz ~ 40GHz		Average (AV)

ANTENNA POLARITY & TEST DISTANCE: HORIZONTAL AT 3 M

NO.	FREQ. (MHz)	EMISSION LEVEL (dBuV/m)	LIMIT (dBuV/m)	MARGIN (dB)	ANTENNA HEIGHT (m)	TABLE ANGLE (Degree)	RAW VALUE (dBuV)	CORRECTION FACTOR (dB/m)
1	*5670.00	110.3 PK			2.03 H	354	70.6	39.7
2	*5670.00	100.7 AV			2.03 H	354	61.0	39.7
3	#5725.00	63.4 PK	74.0	-10.6	1.48 H	345	61.4	2.0
4	#5725.00	48.5 AV	54.0	-5.5	1.48 H	345	46.5	2.0
5	11340.00	60.4 PK	74.0	-13.6	1.54 H	339	45.7	14.7
6	11340.00	47.5 AV	54.0	-6.5	1.54 H	339	32.8	14.7

ANTENNA POLARITY & TEST DISTANCE: VERTICAL AT 3 M

NO.	FREQ. (MHz)	EMISSION LEVEL (dBuV/m)	LIMIT (dBuV/m)	MARGIN (dB)	ANTENNA HEIGHT (m)	TABLE ANGLE (Degree)	RAW VALUE (dBuV)	CORRECTION FACTOR (dB/m)
1	*5670.00	110.9 PK			1.01 V	345	71.2	39.7
2	*5670.00	101.3 AV			1.01 V	345	61.6	39.7
3	#5725.00	63.6 PK	74.0	-10.4	1.34 V	349	61.6	2.0
4	#5725.00	49.4 AV	54.0	-4.6	1.34 V	349	47.4	2.0
5	11340.00	61.5 PK	74.0	-12.5	1.16 V	324	46.8	14.7
6	11340.00	47.4 AV	54.0	-6.6	1.16 V	324	32.7	14.7

Remarks:

1. Emission Level(dBuV/m) = Raw Value(dBuV) + Correction Factor(dB/m)
2. Correction Factor(dB/m) = Antenna Factor(dB/m) + Cable Factor(dB) – Pre-Amplifier Factor(dB)
3. The other emission levels were very low against the limit.
4. Margin value = Emission Level – Limit value
5. " * ": Fundamental frequency.
6. " # ": The radiated frequency is out of the restricted band.

CHANNEL	TX Channel 142	DETECTOR FUNCTION	Peak (PK)
FREQUENCY RANGE	1GHz ~ 40GHz		Average (AV)

ANTENNA POLARITY & TEST DISTANCE: HORIZONTAL AT 3 M								
NO.	FREQ. (MHz)	EMISSION LEVEL (dBuV/m)	LIMIT (dBuV/m)	MARGIN (dB)	ANTENNA HEIGHT (m)	TABLE ANGLE (Degree)	RAW VALUE (dBuV)	CORRECTION FACTOR (dB/m)
1	#5470.00	56.2 PK	74.0	-17.8	1.73 H	347	55.0	1.2
2	#5470.00	43.2 AV	54.0	-10.8	1.73 H	347	42.0	1.2
3	*5710.00	110.5 PK			1.82 H	359	70.6	39.9
4	*5710.00	101.1 AV			1.82 H	359	61.2	39.9
5	#5825.00	55.9 PK	74.0	-18.1	1.98 H	355	53.7	2.2
6	#5825.00	44.8 AV	54.0	-9.2	1.98 H	355	42.6	2.2
7	11420.00	60.9 PK	74.0	-13.1	2.12 H	349	46.5	14.4
8	11420.00	47.1 AV	54.0	-6.9	2.12 H	349	32.7	14.4

ANTENNA POLARITY & TEST DISTANCE: VERTICAL AT 3 M								
NO.	FREQ. (MHz)	EMISSION LEVEL (dBuV/m)	LIMIT (dBuV/m)	MARGIN (dB)	ANTENNA HEIGHT (m)	TABLE ANGLE (Degree)	RAW VALUE (dBuV)	CORRECTION FACTOR (dB/m)
1	#5470.00	55.4 PK	74.0	-18.6	1.05 V	353	54.2	1.2
2	#5470.00	43.5 AV	54.0	-10.5	1.05 V	353	42.3	1.2
3	*5710.00	111.1 PK			1.05 V	344	71.2	39.9
4	*5710.00	101.4 AV			1.05 V	344	61.5	39.9
5	#5825.00	57.4 PK	74.0	-16.6	1.23 V	354	55.2	2.2
6	#5825.00	44.8 AV	54.0	-9.2	1.23 V	354	42.6	2.2
7	11420.00	60.1 PK	74.0	-13.9	1.14 V	323	45.7	14.4
8	11420.00	46.8 AV	54.0	-7.2	1.14 V	323	32.4	14.4

Remarks:

1. Emission Level(dBuV/m) = Raw Value(dBuV) + Correction Factor(dB/m)
2. Correction Factor(dB/m) = Antenna Factor(dB/m) + Cable Factor(dB) – Pre-Amplifier Factor(dB)
3. The other emission levels were very low against the limit.
4. Margin value = Emission Level – Limit value
5. " * ": Fundamental frequency.
6. " # ": The radiated frequency is out of the restricted band.

802.11ac (VHT80)

CHANNEL	TX Channel 58	DETECTOR FUNCTION	Peak (PK)
FREQUENCY RANGE	1GHz ~ 40GHz		Average (AV)

ANTENNA POLARITY & TEST DISTANCE: HORIZONTAL AT 3 M

NO.	FREQ. (MHz)	EMISSION LEVEL (dBuV/m)	LIMIT (dBuV/m)	MARGIN (dB)	ANTENNA HEIGHT (m)	TABLE ANGLE (Degree)	RAW VALUE (dBuV)	CORRECTION FACTOR (dB/m)
1	5150.00	57.7 PK	74.0	-16.3	1.50 H	353	56.9	0.8
2	5150.00	44.6 AV	54.0	-9.4	1.50 H	353	43.8	0.8
3	*5290.00	107.7 PK			1.26 H	351	68.8	38.9
4	*5290.00	96.5 AV			1.26 H	351	57.6	38.9
5	5350.00	64.1 PK	74.0	-9.9	1.74 H	346	63.0	1.1
6	5350.00	50.4 AV	54.0	-3.6	1.74 H	346	49.3	1.1
7	#10580.00	59.9 PK	74.0	-14.1	1.40 H	268	46.1	13.8
8	#10580.00	45.7 AV	54.0	-8.3	1.40 H	268	31.9	13.8

ANTENNA POLARITY & TEST DISTANCE: VERTICAL AT 3 M

NO.	FREQ. (MHz)	EMISSION LEVEL (dBuV/m)	LIMIT (dBuV/m)	MARGIN (dB)	ANTENNA HEIGHT (m)	TABLE ANGLE (Degree)	RAW VALUE (dBuV)	CORRECTION FACTOR (dB/m)
1	5150.00	58.3 PK	74.0	-15.7	1.63 V	343	57.5	0.8
2	5150.00	45.7 AV	54.0	-8.3	1.63 V	343	44.9	0.8
3	*5290.00	108.1 PK			1.88 V	349	69.2	38.9
4	*5290.00	98.1 AV			1.88 V	349	59.2	38.9
5	5350.00	66.8 PK	74.0	-7.2	1.40 V	350	65.7	1.1
6	5350.00	52.9 AV	54.0	-1.1	1.40 V	350	51.8	1.1
7	#10580.00	60.4 PK	74.0	-13.6	1.33 V	313	46.6	13.8
8	#10580.00	46.3 AV	54.0	-7.7	1.33 V	313	32.5	13.8

Remarks:

1. Emission Level(dBuV/m) = Raw Value(dBuV) + Correction Factor(dB/m)
2. Correction Factor(dB/m) = Antenna Factor(dB/m) + Cable Factor(dB) – Pre-Amplifier Factor(dB)
3. The other emission levels were very low against the limit.
4. Margin value = Emission Level – Limit value
5. " * ": Fundamental frequency.
6. " # ": The radiated frequency is out of the restricted band.

CHANNEL	TX Channel 106	DETECTOR FUNCTION	Peak (PK)
FREQUENCY RANGE	1GHz ~ 40GHz		Average (AV)

ANTENNA POLARITY & TEST DISTANCE: HORIZONTAL AT 3 M

NO.	FREQ. (MHz)	EMISSION LEVEL (dBuV/m)	LIMIT (dBuV/m)	MARGIN (dB)	ANTENNA HEIGHT (m)	TABLE ANGLE (Degree)	RAW VALUE (dBuV)	CORRECTION FACTOR (dB/m)
1	5460.00	64.0 PK	74.0	-10.0	1.18 H	314	62.8	1.2
2	5460.00	50.8 AV	54.0	-3.2	1.18 H	314	49.6	1.2
3	#5470.00	65.7 PK	74.0	-8.3	1.42 H	350	64.5	1.2
4	#5470.00	51.8 AV	54.0	-2.2	1.42 H	350	50.6	1.2
5	*5530.00	106.8 PK			2.09 H	4	67.5	39.3
6	*5530.00	96.8 AV			2.09 H	4	57.5	39.3
7	#5725.00	58.2 PK	74.0	-15.8	1.28 H	342	56.2	2.0
8	#5725.00	44.5 AV	54.0	-9.5	1.28 H	342	42.5	2.0
9	11060.00	60.8 PK	74.0	-13.2	1.38 H	315	45.9	14.9
10	11060.00	47.7 AV	54.0	-6.3	1.38 H	315	32.8	14.9

ANTENNA POLARITY & TEST DISTANCE: VERTICAL AT 3 M

NO.	FREQ. (MHz)	EMISSION LEVEL (dBuV/m)	LIMIT (dBuV/m)	MARGIN (dB)	ANTENNA HEIGHT (m)	TABLE ANGLE (Degree)	RAW VALUE (dBuV)	CORRECTION FACTOR (dB/m)
1	5460.00	64.4 PK	74.0	-9.6	1.39 V	357	63.2	1.2
2	5460.00	51.4 AV	54.0	-2.6	1.39 V	357	50.2	1.2
3	#5470.00	66.0 PK	74.0	-8.0	1.12 V	348	64.8	1.2
4	#5470.00	52.5 AV	54.0	-1.5	1.12 V	348	51.3	1.2
5	*5530.00	107.6 PK			1.16 V	348	68.3	39.3
6	*5530.00	97.7 AV			1.16 V	348	58.4	39.3
7	#5725.00	58.0 PK	74.0	-16.0	1.16 V	349	56.0	2.0
8	#5725.00	45.1 AV	54.0	-8.9	1.16 V	349	43.1	2.0
9	11060.00	60.7 PK	74.0	-13.3	1.23 V	338	45.8	14.9
10	11060.00	47.8 AV	54.0	-6.2	1.23 V	338	32.9	14.9

Remarks:

1. Emission Level(dBuV/m) = Raw Value(dBuV) + Correction Factor(dB/m)
2. Correction Factor(dB/m) = Antenna Factor(dB/m) + Cable Factor(dB) – Pre-Amplifier Factor(dB)
3. The other emission levels were very low against the limit.
4. Margin value = Emission Level – Limit value
5. " * ": Fundamental frequency.
6. " # ": The radiated frequency is out of the restricted band.

CHANNEL	TX Channel 122	DETECTOR FUNCTION	Peak (PK)
FREQUENCY RANGE	1GHz ~ 40GHz		Average (AV)

ANTENNA POLARITY & TEST DISTANCE: HORIZONTAL AT 3 M

NO.	FREQ. (MHz)	EMISSION LEVEL (dBuV/m)	LIMIT (dBuV/m)	MARGIN (dB)	ANTENNA HEIGHT (m)	TABLE ANGLE (Degree)	RAW VALUE (dBuV)	CORRECTION FACTOR (dB/m)
1	5460.00	57.1 PK	74.0	-16.9	1.45 H	308	55.9	1.2
2	5460.00	44.7 AV	54.0	-9.3	1.45 H	308	43.5	1.2
3	#5470.00	59.7 PK	74.0	-14.3	1.18 H	345	58.5	1.2
4	#5470.00	45.7 AV	54.0	-8.3	1.18 H	345	44.5	1.2
5	*5610.00	107.4 PK			1.39 H	354	67.8	39.6
6	*5610.00	97.3 AV			1.39 H	354	57.7	39.6
7	#5725.00	60.0 PK	74.0	-14.0	1.34 H	358	58.0	2.0
8	#5725.00	48.2 AV	54.0	-5.8	1.34 H	358	46.2	2.0
9	11220.00	59.9 PK	74.0	-14.1	1.92 H	355	44.8	15.1
10	11220.00	46.6 AV	54.0	-7.4	1.92 H	355	31.5	15.1

ANTENNA POLARITY & TEST DISTANCE: VERTICAL AT 3 M

NO.	FREQ. (MHz)	EMISSION LEVEL (dBuV/m)	LIMIT (dBuV/m)	MARGIN (dB)	ANTENNA HEIGHT (m)	TABLE ANGLE (Degree)	RAW VALUE (dBuV)	CORRECTION FACTOR (dB/m)
1	5460.00	57.5 PK	74.0	-16.5	1.27 V	332	56.3	1.2
2	5460.00	45.0 AV	54.0	-9.0	1.27 V	332	43.8	1.2
3	#5470.00	59.4 PK	74.0	-14.6	1.48 V	354	58.2	1.2
4	#5470.00	46.6 AV	54.0	-7.4	1.48 V	354	45.4	1.2
5	*5610.00	107.8 PK			1.08 V	344	68.2	39.6
6	*5610.00	97.6 AV			1.08 V	344	58.0	39.6
7	#5725.00	60.7 PK	74.0	-13.3	1.37 V	349	58.7	2.0
8	#5725.00	48.7 AV	54.0	-5.3	1.37 V	349	46.7	2.0
9	11220.00	60.1 PK	74.0	-13.9	1.22 V	334	45.0	15.1
10	11220.00	46.7 AV	54.0	-7.3	1.22 V	334	31.6	15.1

Remarks:

1. Emission Level(dBuV/m) = Raw Value(dBuV) + Correction Factor(dB/m)
2. Correction Factor(dB/m) = Antenna Factor(dB/m) + Cable Factor(dB) – Pre-Amplifier Factor(dB)
3. The other emission levels were very low against the limit.
4. Margin value = Emission Level – Limit value
5. " * ": Fundamental frequency.
6. " # ": The radiated frequency is out of the restricted band.

CHANNEL	TX Channel 138	DETECTOR FUNCTION	Peak (PK)
FREQUENCY RANGE	1GHz ~ 40GHz		Average (AV)

ANTENNA POLARITY & TEST DISTANCE: HORIZONTAL AT 3 M								
NO.	FREQ. (MHz)	EMISSION LEVEL (dBuV/m)	LIMIT (dBuV/m)	MARGIN (dB)	ANTENNA HEIGHT (m)	TABLE ANGLE (Degree)	RAW VALUE (dBuV)	CORRECTION FACTOR (dB/m)
1	#5470.00	56.1 PK	74.0	-17.9	1.78 H	347	54.9	1.2
2	#5470.00	43.9 AV	54.0	-10.1	1.78 H	347	42.7	1.2
3	*5690.00	108.6 PK			1.67 H	357	68.8	39.8
4	*5690.00	97.9 AV			1.67 H	357	58.1	39.8
5	#5825.00	58.4 PK	74.0	-15.6	1.71 H	357	56.2	2.2
6	#5825.00	46.4 AV	54.0	-7.6	1.71 H	357	44.2	2.2
7	11380.00	60.1 PK	74.0	-13.9	1.86 H	348	45.6	14.5
8	11380.00	47.2 AV	54.0	-6.8	1.86 H	348	32.7	14.5

ANTENNA POLARITY & TEST DISTANCE: VERTICAL AT 3 M								
NO.	FREQ. (MHz)	EMISSION LEVEL (dBuV/m)	LIMIT (dBuV/m)	MARGIN (dB)	ANTENNA HEIGHT (m)	TABLE ANGLE (Degree)	RAW VALUE (dBuV)	CORRECTION FACTOR (dB/m)
1	#5470.00	55.4 PK	74.0	-18.6	1.17 V	343	54.2	1.2
2	#5470.00	44.2 AV	54.0	-9.8	1.17 V	343	43.0	1.2
3	*5690.00	107.4 PK			1.00 V	349	67.6	39.8
4	*5690.00	97.4 AV			1.00 V	349	57.6	39.8
5	#5825.00	59.5 PK	74.0	-14.5	1.10 V	346	57.3	2.2
6	#5825.00	47.6 AV	54.0	-6.4	1.10 V	346	45.4	2.2
7	11380.00	61.0 PK	74.0	-13.0	1.18 V	335	46.5	14.5
8	11380.00	46.5 AV	54.0	-7.5	1.18 V	335	32.0	14.5

Remarks:

1. Emission Level(dBuV/m) = Raw Value(dBuV) + Correction Factor(dB/m)
2. Correction Factor(dB/m) = Antenna Factor(dB/m) + Cable Factor(dB) – Pre-Amplifier Factor(dB)
3. The other emission levels were very low against the limit.
4. Margin value = Emission Level – Limit value
5. " * ": Fundamental frequency.
6. " # ": The radiated frequency is out of the restricted band.

Test Mode I

802.11a

CHANNEL	TX Channel 52	DETECTOR FUNCTION	Peak (PK)
FREQUENCY RANGE	1GHz ~ 40GHz		Average (AV)

ANTENNA POLARITY & TEST DISTANCE: HORIZONTAL AT 3 M

NO.	FREQ. (MHz)	EMISSION LEVEL (dBuV/m)	LIMIT (dBuV/m)	MARGIN (dB)	ANTENNA HEIGHT (m)	TABLE ANGLE (Degree)	RAW VALUE (dBuV)	CORRECTION FACTOR (dB/m)
1	5150.00	57.5 PK	74.0	-16.5	1.86 H	354	56.7	0.8
2	5150.00	46.3 AV	54.0	-7.7	1.86 H	354	45.5	0.8
3	*5260.00	117.8 PK			1.72 H	342	79.0	38.8
4	*5260.00	108.2 AV			1.72 H	342	69.4	38.8
5	5460.00	58.7 PK	74.0	-15.3	1.44 H	353	57.5	1.2
6	5460.00	50.0 AV	54.0	-4.0	1.44 H	353	48.8	1.2
7	#10520.00	57.4 PK	74.0	-16.6	1.23 H	337	43.7	13.7
8	#10520.00	44.3 AV	54.0	-9.7	1.23 H	337	30.6	13.7

ANTENNA POLARITY & TEST DISTANCE: VERTICAL AT 3 M

NO.	FREQ. (MHz)	EMISSION LEVEL (dBuV/m)	LIMIT (dBuV/m)	MARGIN (dB)	ANTENNA HEIGHT (m)	TABLE ANGLE (Degree)	RAW VALUE (dBuV)	CORRECTION FACTOR (dB/m)
1	5150.00	54.2 PK	74.0	-19.8	1.96 V	319	53.4	0.8
2	5150.00	41.4 AV	54.0	-12.6	1.96 V	319	40.6	0.8
3	*5260.00	104.9 PK			3.15 V	16	66.1	38.8
4	*5260.00	95.0 AV			3.15 V	16	56.2	38.8
5	5460.00	54.5 PK	74.0	-19.5	2.13 V	124	53.3	1.2
6	5460.00	41.6 AV	54.0	-12.4	2.13 V	124	40.4	1.2
7	#10520.00	56.8 PK	74.0	-17.2	3.09 V	341	43.1	13.7
8	#10520.00	43.7 AV	54.0	-10.3	3.09 V	341	30.0	13.7

Remarks:

1. Emission Level(dBuV/m) = Raw Value(dBuV) + Correction Factor(dB/m)
2. Correction Factor(dB/m) = Antenna Factor(dB/m) + Cable Factor(dB) – Pre-Amplifier Factor(dB)
3. The other emission levels were very low against the limit.
4. Margin value = Emission Level – Limit value
5. " * ": Fundamental frequency.
6. " # ": The radiated frequency is out of the restricted band.

CHANNEL	TX Channel 60	DETECTOR FUNCTION	Peak (PK)
FREQUENCY RANGE	1GHz ~ 40GHz		Average (AV)

ANTENNA POLARITY & TEST DISTANCE: HORIZONTAL AT 3 M								
NO.	FREQ. (MHz)	EMISSION LEVEL (dBuV/m)	LIMIT (dBuV/m)	MARGIN (dB)	ANTENNA HEIGHT (m)	TABLE ANGLE (Degree)	RAW VALUE (dBuV)	CORRECTION FACTOR (dB/m)
1	*5300.00	117.2 PK			1.80 H	352	78.3	38.9
2	*5300.00	106.6 AV			1.80 H	352	67.7	38.9
3	10600.00	57.6 PK	74.0	-16.4	1.61 H	291	43.8	13.8
4	10600.00	43.9 AV	54.0	-10.1	1.61 H	291	30.1	13.8
ANTENNA POLARITY & TEST DISTANCE: VERTICAL AT 3 M								
NO.	FREQ. (MHz)	EMISSION LEVEL (dBuV/m)	LIMIT (dBuV/m)	MARGIN (dB)	ANTENNA HEIGHT (m)	TABLE ANGLE (Degree)	RAW VALUE (dBuV)	CORRECTION FACTOR (dB/m)
1	*5300.00	103.0 PK			3.76 V	21	64.1	38.9
2	*5300.00	92.6 AV			3.76 V	21	53.7	38.9
3	10600.00	57.3 PK	74.0	-16.7	3.02 V	120	43.5	13.8
4	10600.00	43.9 AV	54.0	-10.1	3.02 V	120	30.1	13.8

Remarks:

1. Emission Level(dBuV/m) = Raw Value(dBuV) + Correction Factor(dB/m)
2. Correction Factor(dB/m) = Antenna Factor(dB/m) + Cable Factor(dB) – Pre-Amplifier Factor(dB)
3. The other emission levels were very low against the limit.
4. Margin value = Emission Level – Limit value
5. " * ": Fundamental frequency.
6. " # ": The radiated frequency is out of the restricted band.

CHANNEL	TX Channel 64	DETECTOR FUNCTION	Peak (PK)
FREQUENCY RANGE	1GHz ~ 40GHz		Average (AV)

ANTENNA POLARITY & TEST DISTANCE: HORIZONTAL AT 3 M

NO.	FREQ. (MHz)	EMISSION LEVEL (dBuV/m)	LIMIT (dBuV/m)	MARGIN (dB)	ANTENNA HEIGHT (m)	TABLE ANGLE (Degree)	RAW VALUE (dBuV)	CORRECTION FACTOR (dB/m)
1	*5320.00	117.7 PK			2.03 H	343	78.7	39.0
2	*5320.00	107.3 AV			2.03 H	343	68.3	39.0
3	5350.00	66.2 PK	74.0	-7.8	1.82 H	347	65.1	1.1
4	5350.00	52.4 AV	54.0	-1.6	1.82 H	347	51.3	1.1
5	10640.00	57.0 PK	74.0	-17.0	1.73 H	223	43.1	13.9
6	10640.00	43.4 AV	54.0	-10.6	1.73 H	223	29.5	13.9

ANTENNA POLARITY & TEST DISTANCE: VERTICAL AT 3 M

NO.	FREQ. (MHz)	EMISSION LEVEL (dBuV/m)	LIMIT (dBuV/m)	MARGIN (dB)	ANTENNA HEIGHT (m)	TABLE ANGLE (Degree)	RAW VALUE (dBuV)	CORRECTION FACTOR (dB/m)
1	*5320.00	104.1 PK			3.05 V	26	65.1	39.0
2	*5320.00	93.8 AV			3.05 V	26	54.8	39.0
3	5350.00	55.8 PK	74.0	-18.2	3.58 V	33	54.7	1.1
4	5350.00	42.3 AV	54.0	-11.7	3.58 V	33	41.2	1.1
5	10640.00	56.7 PK	74.0	-17.3	3.31 V	230	42.8	13.9
6	10640.00	43.3 AV	54.0	-10.7	3.31 V	230	29.4	13.9

Remarks:

1. Emission Level(dBuV/m) = Raw Value(dBuV) + Correction Factor(dB/m)
2. Correction Factor(dB/m) = Antenna Factor(dB/m) + Cable Factor(dB) – Pre-Amplifier Factor(dB)
3. The other emission levels were very low against the limit.
4. Margin value = Emission Level – Limit value
5. " * ": Fundamental frequency.
6. " # ": The radiated frequency is out of the restricted band.

CHANNEL	TX Channel 100	DETECTOR FUNCTION	Peak (PK)
FREQUENCY RANGE	1GHz ~ 40GHz		Average (AV)

ANTENNA POLARITY & TEST DISTANCE: HORIZONTAL AT 3 M								
NO.	FREQ. (MHz)	EMISSION LEVEL (dBuV/m)	LIMIT (dBuV/m)	MARGIN (dB)	ANTENNA HEIGHT (m)	TABLE ANGLE (Degree)	RAW VALUE (dBuV)	CORRECTION FACTOR (dB/m)
1	5460.00	63.7 PK	74.0	-10.3	1.36 H	344	62.5	1.2
2	5460.00	48.2 AV	54.0	-5.8	1.36 H	344	47.0	1.2
3	#5470.00	67.3 PK	74.0	-6.7	1.46 H	342	66.1	1.2
4	#5470.00	52.5 AV	54.0	-1.5	1.46 H	342	51.3	1.2
5	*5500.00	117.2 PK			1.48 H	353	77.9	39.3
6	*5500.00	106.6 AV			1.48 H	353	67.3	39.3
7	11000.00	60.2 PK	74.0	-13.8	1.32 H	69	44.9	15.3
8	11000.00	46.7 AV	54.0	-7.3	1.32 H	69	31.4	15.3

ANTENNA POLARITY & TEST DISTANCE: VERTICAL AT 3 M								
NO.	FREQ. (MHz)	EMISSION LEVEL (dBuV/m)	LIMIT (dBuV/m)	MARGIN (dB)	ANTENNA HEIGHT (m)	TABLE ANGLE (Degree)	RAW VALUE (dBuV)	CORRECTION FACTOR (dB/m)
1	5460.00	55.9 PK	74.0	-18.1	3.13 V	53	54.7	1.2
2	5460.00	41.6 AV	54.0	-12.4	3.13 V	53	40.4	1.2
3	#5470.00	57.7 PK	74.0	-16.3	3.40 V	29	56.5	1.2
4	#5470.00	43.9 AV	54.0	-10.1	3.40 V	29	42.7	1.2
5	*5500.00	104.8 PK			3.38 V	20	65.5	39.3
6	*5500.00	94.1 AV			3.38 V	20	54.8	39.3
7	11000.00	57.8 PK	74.0	-16.2	3.11 V	79	42.5	15.3
8	11000.00	44.7 AV	54.0	-9.3	3.11 V	79	29.4	15.3

Remarks:

1. Emission Level(dBuV/m) = Raw Value(dBuV) + Correction Factor(dB/m)
2. Correction Factor(dB/m) = Antenna Factor(dB/m) + Cable Factor(dB) – Pre-Amplifier Factor(dB)
3. The other emission levels were very low against the limit.
4. Margin value = Emission Level – Limit value
5. " * ": Fundamental frequency.
6. " # ": The radiated frequency is out of the restricted band.

CHANNEL	TX Channel 116	DETECTOR	Peak (PK)
FREQUENCY RANGE	1GHz ~ 40GHz	FUNCTION	Average (AV)

ANTENNA POLARITY & TEST DISTANCE: HORIZONTAL AT 3 M

NO.	FREQ. (MHz)	EMISSION LEVEL (dBuV/m)	LIMIT (dBuV/m)	MARGIN (dB)	ANTENNA HEIGHT (m)	TABLE ANGLE (Degree)	RAW VALUE (dBuV)	CORRECTION FACTOR (dB/m)
1	*5580.00	116.7 PK			1.56 H	346	77.2	39.5
2	*5580.00	106.1 AV			1.56 H	346	66.6	39.5
3	11160.00	58.1 PK	74.0	-15.9	1.12 H	128	43.2	14.9
4	11160.00	44.7 AV	54.0	-9.3	1.12 H	128	29.8	14.9

ANTENNA POLARITY & TEST DISTANCE: VERTICAL AT 3 M

NO.	FREQ. (MHz)	EMISSION LEVEL (dBuV/m)	LIMIT (dBuV/m)	MARGIN (dB)	ANTENNA HEIGHT (m)	TABLE ANGLE (Degree)	RAW VALUE (dBuV)	CORRECTION FACTOR (dB/m)
1	*5580.00	103.7 PK			3.59 V	21	64.2	39.5
2	*5580.00	93.1 AV			3.59 V	21	53.6	39.5
3	11160.00	58.0 PK	74.0	-16.0	3.08 V	79	43.1	14.9
4	11160.00	44.6 AV	54.0	-9.4	3.08 V	79	29.7	14.9

Remarks:

1. Emission Level(dBuV/m) = Raw Value(dBuV) + Correction Factor(dB/m)
2. Correction Factor(dB/m) = Antenna Factor(dB/m) + Cable Factor(dB) – Pre-Amplifier Factor(dB)
3. The other emission levels were very low against the limit.
4. Margin value = Emission Level – Limit value
5. " * ": Fundamental frequency.
6. " # ": The radiated frequency is out of the restricted band.

CHANNEL	TX Channel 140	DETECTOR FUNCTION	Peak (PK)
FREQUENCY RANGE	1GHz ~ 40GHz		Average (AV)

ANTENNA POLARITY & TEST DISTANCE: HORIZONTAL AT 3 M

NO.	FREQ. (MHz)	EMISSION LEVEL (dBuV/m)	LIMIT (dBuV/m)	MARGIN (dB)	ANTENNA HEIGHT (m)	TABLE ANGLE (Degree)	RAW VALUE (dBuV)	CORRECTION FACTOR (dB/m)
1	*5700.00	117.0 PK			1.84 H	348	77.2	39.8
2	*5700.00	106.4 AV			1.84 H	348	66.6	39.8
3	#5725.00	68.1 PK	74.0	-5.9	1.53 H	350	66.1	2.0
4	#5725.00	52.5 AV	54.0	-1.5	1.53 H	350	50.5	2.0
5	11400.00	59.9 PK	74.0	-14.1	1.70 H	114	45.4	14.5
6	11400.00	45.7 AV	54.0	-8.3	1.70 H	114	31.2	14.5

ANTENNA POLARITY & TEST DISTANCE: VERTICAL AT 3 M

NO.	FREQ. (MHz)	EMISSION LEVEL (dBuV/m)	LIMIT (dBuV/m)	MARGIN (dB)	ANTENNA HEIGHT (m)	TABLE ANGLE (Degree)	RAW VALUE (dBuV)	CORRECTION FACTOR (dB/m)
1	*5700.00	105.7 PK			3.04 V	22	65.9	39.8
2	*5700.00	95.1 AV			3.04 V	22	55.3	39.8
3	#5725.00	55.3 PK	74.0	-18.7	3.05 V	23	53.3	2.0
4	#5725.00	43.3 AV	54.0	-10.7	3.05 V	23	41.3	2.0
5	11400.00	59.0 PK	74.0	-15.0	1.21 V	228	44.5	14.5
6	11400.00	45.2 AV	54.0	-8.8	1.21 V	228	30.7	14.5

Remarks:

1. Emission Level(dBuV/m) = Raw Value(dBuV) + Correction Factor(dB/m)
2. Correction Factor(dB/m) = Antenna Factor(dB/m) + Cable Factor(dB) – Pre-Amplifier Factor(dB)
3. The other emission levels were very low against the limit.
4. Margin value = Emission Level – Limit value
5. " * ": Fundamental frequency.
6. " # ": The radiated frequency is out of the restricted band.

CHANNEL	TX Channel 144	DETECTOR FUNCTION	Peak (PK)
FREQUENCY RANGE	1GHz ~ 40GHz		Average (AV)

ANTENNA POLARITY & TEST DISTANCE: HORIZONTAL AT 3 M

NO.	FREQ. (MHz)	EMISSION LEVEL (dBuV/m)	LIMIT (dBuV/m)	MARGIN (dB)	ANTENNA HEIGHT (m)	TABLE ANGLE (Degree)	RAW VALUE (dBuV)	CORRECTION FACTOR (dB/m)
1	#5470.00	60.5 PK	74.0	-13.5	1.80 H	91	59.3	1.2
2	#5470.00	42.0 AV	54.0	-12.0	1.80 H	91	40.8	1.2
3	*5720.00	119.8 PK			1.50 H	345	79.9	39.9
4	*5720.00	109.5 AV			1.50 H	345	69.6	39.9
5	#5825.00	58.0 PK	74.0	-16.0	1.96 H	0	55.8	2.2
6	#5825.00	45.8 AV	54.0	-8.2	1.96 H	0	43.6	2.2
7	11440.00	59.8 PK	74.0	-14.2	2.13 H	175	45.3	14.5
8	11440.00	47.2 AV	54.0	-6.8	2.13 H	175	32.7	14.5

ANTENNA POLARITY & TEST DISTANCE: VERTICAL AT 3 M

NO.	FREQ. (MHz)	EMISSION LEVEL (dBuV/m)	LIMIT (dBuV/m)	MARGIN (dB)	ANTENNA HEIGHT (m)	TABLE ANGLE (Degree)	RAW VALUE (dBuV)	CORRECTION FACTOR (dB/m)
1	#5470.00	54.8 PK	74.0	-19.2	2.38 V	279	53.6	1.2
2	#5470.00	43.7 AV	54.0	-10.3	2.38 V	279	42.5	1.2
3	*5720.00	105.3 PK			2.40 V	6	65.4	39.9
4	*5720.00	95.5 AV			2.40 V	6	55.6	39.9
5	#5825.00	56.3 PK	74.0	-17.7	2.06 V	300	54.1	2.2
6	#5825.00	45.3 AV	54.0	-8.7	2.06 V	300	43.1	2.2
7	11440.00	59.1 PK	74.0	-14.9	1.99 V	179	44.6	14.5
8	11440.00	47.0 AV	54.0	-7.0	1.99 V	179	32.5	14.5

Remarks:

1. Emission Level(dBuV/m) = Raw Value(dBuV) + Correction Factor(dB/m)
2. Correction Factor(dB/m) = Antenna Factor(dB/m) + Cable Factor(dB) – Pre-Amplifier Factor(dB)
3. The other emission levels were very low against the limit.
4. Margin value = Emission Level – Limit value
5. " * ": Fundamental frequency.
6. " # ": The radiated frequency is out of the restricted band.

802.11n (HT20)

CHANNEL	TX Channel 52	DETECTOR FUNCTION	Peak (PK) Average (AV)
FREQUENCY RANGE	1GHz ~ 40GHz		

ANTENNA POLARITY & TEST DISTANCE: HORIZONTAL AT 3 M

NO.	FREQ. (MHz)	EMISSION LEVEL (dBuV/m)	LIMIT (dBuV/m)	MARGIN (dB)	ANTENNA HEIGHT (m)	TABLE ANGLE (Degree)	RAW VALUE (dBuV)	CORRECTION FACTOR (dB/m)
1	5150.00	56.8 PK	74.0	-17.2	1.96 H	338	56.0	0.8
2	5150.00	45.9 AV	54.0	-8.1	1.96 H	338	45.1	0.8
3	*5260.00	118.3 PK			1.60 H	346	79.5	38.8
4	*5260.00	107.1 AV			1.60 H	346	68.3	38.8
5	5350.00	58.2 PK	74.0	-15.8	1.78 H	347	57.1	1.1
6	5350.00	48.5 AV	54.0	-5.5	1.78 H	347	47.4	1.1
7	#10520.00	57.2 PK	74.0	-16.8	1.70 H	222	43.5	13.7
8	#10520.00	43.7 AV	54.0	-10.3	1.70 H	222	30.0	13.7

ANTENNA POLARITY & TEST DISTANCE: VERTICAL AT 3 M

NO.	FREQ. (MHz)	EMISSION LEVEL (dBuV/m)	LIMIT (dBuV/m)	MARGIN (dB)	ANTENNA HEIGHT (m)	TABLE ANGLE (Degree)	RAW VALUE (dBuV)	CORRECTION FACTOR (dB/m)
1	5150.00	54.3 PK	74.0	-19.7	3.08 V	162	53.5	0.8
2	5150.00	41.4 AV	54.0	-12.6	3.08 V	162	40.6	0.8
3	*5260.00	105.2 PK			3.17 V	24	66.4	38.8
4	*5260.00	95.0 AV			3.17 V	24	56.2	38.8
5	5350.00	54.7 PK	74.0	-19.3	1.18 V	269	53.6	1.1
6	5350.00	41.5 AV	54.0	-12.5	1.18 V	269	40.4	1.1
7	#10520.00	57.2 PK	74.0	-16.8	2.60 V	49	43.5	13.7
8	#10520.00	43.5 AV	54.0	-10.5	2.60 V	49	29.8	13.7

Remarks:

1. Emission Level(dBuV/m) = Raw Value(dBuV) + Correction Factor(dB/m)
2. Correction Factor(dB/m) = Antenna Factor(dB/m) + Cable Factor(dB) – Pre-Amplifier Factor(dB)
3. The other emission levels were very low against the limit.
4. Margin value = Emission Level – Limit value
5. " * ": Fundamental frequency.
6. " # ": The radiated frequency is out of the restricted band.

CHANNEL	TX Channel 60	DETECTOR	Peak (PK)
FREQUENCY RANGE	1GHz ~ 40GHz	FUNCTION	Average (AV)

ANTENNA POLARITY & TEST DISTANCE: HORIZONTAL AT 3 M

NO.	FREQ. (MHz)	EMISSION LEVEL (dBuV/m)	LIMIT (dBuV/m)	MARGIN (dB)	ANTENNA HEIGHT (m)	TABLE ANGLE (Degree)	RAW VALUE (dBuV)	CORRECTION FACTOR (dB/m)
1	*5300.00	117.6 PK			1.75 H	348	78.7	38.9
2	*5300.00	107.3 AV			1.75 H	348	68.4	38.9
3	10600.00	57.9 PK	74.0	-16.1	1.78 H	321	44.1	13.8
4	10600.00	44.0 AV	54.0	-10.0	1.78 H	321	30.2	13.8

ANTENNA POLARITY & TEST DISTANCE: VERTICAL AT 3 M

NO.	FREQ. (MHz)	EMISSION LEVEL (dBuV/m)	LIMIT (dBuV/m)	MARGIN (dB)	ANTENNA HEIGHT (m)	TABLE ANGLE (Degree)	RAW VALUE (dBuV)	CORRECTION FACTOR (dB/m)
1	*5300.00	102.4 PK			3.78 V	17	63.5	38.9
2	*5300.00	92.1 AV			3.78 V	17	53.2	38.9
3	10600.00	57.3 PK	74.0	-16.7	3.16 V	116	43.5	13.8
4	10600.00	43.7 AV	54.0	-10.3	3.16 V	116	29.9	13.8

Remarks:

1. Emission Level(dBuV/m) = Raw Value(dBuV) + Correction Factor(dB/m)
2. Correction Factor(dB/m) = Antenna Factor(dB/m) + Cable Factor(dB) – Pre-Amplifier Factor(dB)
3. The other emission levels were very low against the limit.
4. Margin value = Emission Level – Limit value
5. " * ": Fundamental frequency.
6. " # ": The radiated frequency is out of the restricted band.

CHANNEL	TX Channel 64	DETECTOR FUNCTION	Peak (PK)
FREQUENCY RANGE	1GHz ~ 40GHz		Average (AV)

ANTENNA POLARITY & TEST DISTANCE: HORIZONTAL AT 3 M								
NO.	FREQ. (MHz)	EMISSION LEVEL (dBuV/m)	LIMIT (dBuV/m)	MARGIN (dB)	ANTENNA HEIGHT (m)	TABLE ANGLE (Degree)	RAW VALUE (dBuV)	CORRECTION FACTOR (dB/m)
1	*5320.00	116.8 PK			1.85 H	348	77.8	39.0
2	*5320.00	106.3 AV			1.85 H	348	67.3	39.0
3	5350.00	67.1 PK	74.0	-6.9	2.38 H	359	66.0	1.1
4	5350.00	52.4 AV	54.0	-1.6	2.38 H	359	51.3	1.1
5	10640.00	57.1 PK	74.0	-16.9	1.73 H	191	43.2	13.9
6	10640.00	43.6 AV	54.0	-10.4	1.73 H	191	29.7	13.9
ANTENNA POLARITY & TEST DISTANCE: VERTICAL AT 3 M								
NO.	FREQ. (MHz)	EMISSION LEVEL (dBuV/m)	LIMIT (dBuV/m)	MARGIN (dB)	ANTENNA HEIGHT (m)	TABLE ANGLE (Degree)	RAW VALUE (dBuV)	CORRECTION FACTOR (dB/m)
1	*5320.00	100.5 PK			3.32 V	25	61.5	39.0
2	*5320.00	90.1 AV			3.32 V	25	51.1	39.0
3	5350.00	56.2 PK	74.0	-17.8	3.22 V	20	55.1	1.1
4	5350.00	43.4 AV	54.0	-10.6	3.22 V	20	42.3	1.1
5	10640.00	58.1 PK	74.0	-15.9	2.99 V	222	44.2	13.9
6	10640.00	43.8 AV	54.0	-10.2	2.99 V	222	29.9	13.9

Remarks:

1. Emission Level(dBuV/m) = Raw Value(dBuV) + Correction Factor(dB/m)
2. Correction Factor(dB/m) = Antenna Factor(dB/m) + Cable Factor(dB) – Pre-Amplifier Factor(dB)
3. The other emission levels were very low against the limit.
4. Margin value = Emission Level – Limit value
5. " * ": Fundamental frequency.
6. " # ": The radiated frequency is out of the restricted band.

CHANNEL	TX Channel 100	DETECTOR FUNCTION	Peak (PK)
FREQUENCY RANGE	1GHz ~ 40GHz		Average (AV)

ANTENNA POLARITY & TEST DISTANCE: HORIZONTAL AT 3 M								
NO.	FREQ. (MHz)	EMISSION LEVEL (dBuV/m)	LIMIT (dBuV/m)	MARGIN (dB)	ANTENNA HEIGHT (m)	TABLE ANGLE (Degree)	RAW VALUE (dBuV)	CORRECTION FACTOR (dB/m)
1	5460.00	63.5 PK	74.0	-10.5	1.64 H	350	62.3	1.2
2	5460.00	48.8 AV	54.0	-5.2	1.64 H	350	47.6	1.2
3	#5470.00	68.5 PK	74.0	-5.5	1.67 H	346	67.3	1.2
4	#5470.00	52.7 AV	54.0	-1.3	1.67 H	346	51.5	1.2
5	*5500.00	116.2 PK			1.31 H	353	76.9	39.3
6	*5500.00	105.6 AV			1.31 H	353	66.3	39.3
7	11000.00	58.4 PK	74.0	-15.6	1.51 H	182	43.1	15.3
8	11000.00	44.8 AV	54.0	-9.2	1.51 H	182	29.5	15.3

ANTENNA POLARITY & TEST DISTANCE: VERTICAL AT 3 M								
NO.	FREQ. (MHz)	EMISSION LEVEL (dBuV/m)	LIMIT (dBuV/m)	MARGIN (dB)	ANTENNA HEIGHT (m)	TABLE ANGLE (Degree)	RAW VALUE (dBuV)	CORRECTION FACTOR (dB/m)
1	5460.00	52.8 PK	74.0	-21.2	3.13 V	29	51.6	1.2
2	5460.00	41.4 AV	54.0	-12.6	3.13 V	29	40.2	1.2
3	#5470.00	57.1 PK	74.0	-16.9	3.63 V	22	55.9	1.2
4	#5470.00	43.3 AV	54.0	-10.7	3.63 V	22	42.1	1.2
5	*5500.00	103.7 PK			3.38 V	28	64.4	39.3
6	*5500.00	93.2 AV			3.38 V	28	53.9	39.3
7	11000.00	58.3 PK	74.0	-15.7	2.97 V	91	43.0	15.3
8	11000.00	44.9 AV	54.0	-9.1	2.97 V	91	29.6	15.3

Remarks:

1. Emission Level(dBuV/m) = Raw Value(dBuV) + Correction Factor(dB/m)
2. Correction Factor(dB/m) = Antenna Factor(dB/m) + Cable Factor(dB) – Pre-Amplifier Factor(dB)
3. The other emission levels were very low against the limit.
4. Margin value = Emission Level – Limit value
5. " * ": Fundamental frequency.
6. " # ": The radiated frequency is out of the restricted band.

CHANNEL	TX Channel 116	DETECTOR FUNCTION	Peak (PK)
FREQUENCY RANGE	1GHz ~ 40GHz		Average (AV)

ANTENNA POLARITY & TEST DISTANCE: HORIZONTAL AT 3 M								
NO.	FREQ. (MHz)	EMISSION LEVEL (dBuV/m)	LIMIT (dBuV/m)	MARGIN (dB)	ANTENNA HEIGHT (m)	TABLE ANGLE (Degree)	RAW VALUE (dBuV)	CORRECTION FACTOR (dB/m)
1	*5580.00	116.4 PK			1.95 H	352	76.9	39.5
2	*5580.00	105.7 AV			1.95 H	352	66.2	39.5
3	11160.00	58.4 PK	74.0	-15.6	1.67 H	226	43.5	14.9
4	11160.00	44.7 AV	54.0	-9.3	1.67 H	226	29.8	14.9
ANTENNA POLARITY & TEST DISTANCE: VERTICAL AT 3 M								
NO.	FREQ. (MHz)	EMISSION LEVEL (dBuV/m)	LIMIT (dBuV/m)	MARGIN (dB)	ANTENNA HEIGHT (m)	TABLE ANGLE (Degree)	RAW VALUE (dBuV)	CORRECTION FACTOR (dB/m)
1	*5580.00	104.5 PK			3.75 V	21	65.0	39.5
2	*5580.00	93.7 AV			3.75 V	21	54.2	39.5
3	11160.00	58.4 PK	74.0	-15.6	2.22 V	139	43.5	14.9
4	11160.00	44.7 AV	54.0	-9.3	2.22 V	139	29.8	14.9

Remarks:

1. Emission Level(dBuV/m) = Raw Value(dBuV) + Correction Factor(dB/m)
2. Correction Factor(dB/m) = Antenna Factor(dB/m) + Cable Factor(dB) – Pre-Amplifier Factor(dB)
3. The other emission levels were very low against the limit.
4. Margin value = Emission Level – Limit value
5. " * ": Fundamental frequency.
6. " # ": The radiated frequency is out of the restricted band.

CHANNEL	TX Channel 140	DETECTOR FUNCTION	Peak (PK)
FREQUENCY RANGE	1GHz ~ 40GHz		Average (AV)

ANTENNA POLARITY & TEST DISTANCE: HORIZONTAL AT 3 M

NO.	FREQ. (MHz)	EMISSION LEVEL (dBuV/m)	LIMIT (dBuV/m)	MARGIN (dB)	ANTENNA HEIGHT (m)	TABLE ANGLE (Degree)	RAW VALUE (dBuV)	CORRECTION FACTOR (dB/m)
1	*5700.00	117.3 PK			1.37 H	350	77.5	39.8
2	*5700.00	106.2 AV			1.37 H	350	66.4	39.8
3	#5725.00	66.8 PK	74.0	-7.2	1.36 H	357	64.8	2.0
4	#5725.00	52.6 AV	54.0	-1.4	1.36 H	357	50.6	2.0
5	11400.00	59.6 PK	74.0	-14.4	1.21 H	221	45.1	14.5
6	11400.00	45.4 AV	54.0	-8.6	1.21 H	221	30.9	14.5

ANTENNA POLARITY & TEST DISTANCE: VERTICAL AT 3 M

NO.	FREQ. (MHz)	EMISSION LEVEL (dBuV/m)	LIMIT (dBuV/m)	MARGIN (dB)	ANTENNA HEIGHT (m)	TABLE ANGLE (Degree)	RAW VALUE (dBuV)	CORRECTION FACTOR (dB/m)
1	*5700.00	105.1 PK			2.76 V	22	65.3	39.8
2	*5700.00	93.8 AV			2.76 V	22	54.0	39.8
3	#5725.00	57.0 PK	74.0	-17.0	3.38 V	15	55.0	2.0
4	#5725.00	43.8 AV	54.0	-10.2	3.38 V	15	41.8	2.0
5	11400.00	59.5 PK	74.0	-14.5	2.91 V	226	45.0	14.5
6	11400.00	45.7 AV	54.0	-8.3	2.91 V	226	31.2	14.5

Remarks:

1. Emission Level(dBuV/m) = Raw Value(dBuV) + Correction Factor(dB/m)
2. Correction Factor(dB/m) = Antenna Factor(dB/m) + Cable Factor(dB) – Pre-Amplifier Factor(dB)
3. The other emission levels were very low against the limit.
4. Margin value = Emission Level – Limit value
5. " * ": Fundamental frequency.
6. " # ": The radiated frequency is out of the restricted band.

CHANNEL	TX Channel 144	DETECTOR FUNCTION	Peak (PK)
FREQUENCY RANGE	1GHz ~ 40GHz		Average (AV)

ANTENNA POLARITY & TEST DISTANCE: HORIZONTAL AT 3 M

NO.	FREQ. (MHz)	EMISSION LEVEL (dBuV/m)	LIMIT (dBuV/m)	MARGIN (dB)	ANTENNA HEIGHT (m)	TABLE ANGLE (Degree)	RAW VALUE (dBuV)	CORRECTION FACTOR (dB/m)
1	#5470.00	57.3 PK	74.0	-16.7	2.22 H	33	56.1	1.2
2	#5470.00	33.8 AV	54.0	-20.2	2.22 H	33	32.6	1.2
3	*5720.00	118.2 PK			2.32 H	334	78.3	39.9
4	*5720.00	108.4 AV			2.32 H	334	68.5	39.9
5	#5825.00	58.4 PK	74.0	-15.6	2.12 H	134	56.2	2.2
6	#5825.00	47.2 AV	54.0	-6.8	2.12 H	134	45.0	2.2
7	11440.00	61.0 PK	74.0	-13.0	1.89 H	149	46.5	14.5
8	11440.00	48.1 AV	54.0	-5.9	1.89 H	149	33.6	14.5

ANTENNA POLARITY & TEST DISTANCE: VERTICAL AT 3 M

NO.	FREQ. (MHz)	EMISSION LEVEL (dBuV/m)	LIMIT (dBuV/m)	MARGIN (dB)	ANTENNA HEIGHT (m)	TABLE ANGLE (Degree)	RAW VALUE (dBuV)	CORRECTION FACTOR (dB/m)
1	#5470.00	56.7 PK	74.0	-17.3	2.55 V	21	55.5	1.2
2	#5470.00	42.7 AV	54.0	-11.3	2.55 V	21	41.5	1.2
3	*5720.00	107.0 PK			2.65 V	9	67.1	39.9
4	*5720.00	96.5 AV			2.65 V	9	56.6	39.9
5	#5825.00	57.7 PK	74.0	-16.3	2.24 V	7	55.5	2.2
6	#5825.00	44.1 AV	54.0	-9.9	2.24 V	7	41.9	2.2
7	11440.00	58.4 PK	74.0	-15.6	1.96 V	73	43.9	14.5
8	11440.00	46.5 AV	54.0	-7.5	1.96 V	73	32.0	14.5

Remarks:

1. Emission Level(dBuV/m) = Raw Value(dBuV) + Correction Factor(dB/m)
2. Correction Factor(dB/m) = Antenna Factor(dB/m) + Cable Factor(dB) – Pre-Amplifier Factor(dB)
3. The other emission levels were very low against the limit.
4. Margin value = Emission Level – Limit value
5. " * ": Fundamental frequency.
6. " # ": The radiated frequency is out of the restricted band.

802.11n (HT40)

CHANNEL	TX Channel 54	DETECTOR FUNCTION	Peak (PK) Average (AV)
FREQUENCY RANGE	1GHz ~ 40GHz		

ANTENNA POLARITY & TEST DISTANCE: HORIZONTAL AT 3 M

NO.	FREQ. (MHz)	EMISSION LEVEL (dBuV/m)	LIMIT (dBuV/m)	MARGIN (dB)	ANTENNA HEIGHT (m)	TABLE ANGLE (Degree)	RAW VALUE (dBuV)	CORRECTION FACTOR (dB/m)
1	*5270.00	112.2 PK			1.50 H	356	73.3	38.9
2	*5270.00	102.9 AV			1.50 H	356	64.0	38.9
3	5350.00	63.4 PK	74.0	-10.6	1.90 H	356	62.3	1.1
4	5350.00	52.0 AV	54.0	-2.0	1.90 H	356	50.9	1.1
5	#10540.00	57.6 PK	74.0	-16.4	1.22 H	280	43.9	13.7
6	#10540.00	44.3 AV	54.0	-9.7	1.22 H	280	30.6	13.7

ANTENNA POLARITY & TEST DISTANCE: VERTICAL AT 3 M

NO.	FREQ. (MHz)	EMISSION LEVEL (dBuV/m)	LIMIT (dBuV/m)	MARGIN (dB)	ANTENNA HEIGHT (m)	TABLE ANGLE (Degree)	RAW VALUE (dBuV)	CORRECTION FACTOR (dB/m)
1	*5270.00	100.4 PK			3.74 V	26	61.5	38.9
2	*5270.00	90.9 AV			3.74 V	26	52.0	38.9
3	5350.00	54.6 PK	74.0	-19.4	3.64 V	16	53.5	1.1
4	5350.00	41.9 AV	54.0	-12.1	3.64 V	16	40.8	1.1
5	#10540.00	57.5 PK	74.0	-16.5	3.01 V	206	43.8	13.7
6	#10540.00	44.3 AV	54.0	-9.7	3.01 V	206	30.6	13.7

Remarks:

1. Emission Level(dBuV/m) = Raw Value(dBuV) + Correction Factor(dB/m)
2. Correction Factor(dB/m) = Antenna Factor(dB/m) + Cable Factor(dB) – Pre-Amplifier Factor(dB)
3. The other emission levels were very low against the limit.
4. Margin value = Emission Level – Limit value
5. " * ": Fundamental frequency.
6. " # ": The radiated frequency is out of the restricted band.

CHANNEL	TX Channel 62	DETECTOR FUNCTION	Peak (PK)
FREQUENCY RANGE	1GHz ~ 40GHz		Average (AV)

ANTENNA POLARITY & TEST DISTANCE: HORIZONTAL AT 3 M								
NO.	FREQ. (MHz)	EMISSION LEVEL (dBuV/m)	LIMIT (dBuV/m)	MARGIN (dB)	ANTENNA HEIGHT (m)	TABLE ANGLE (Degree)	RAW VALUE (dBuV)	CORRECTION FACTOR (dB/m)
1	*5310.00	111.6 PK			1.63 H	346	72.7	38.9
2	*5310.00	102.2 AV			1.63 H	346	63.3	38.9
3	5350.00	65.1 PK	74.0	-8.9	1.55 H	341	64.0	1.1
4	5350.00	52.5 AV	54.0	-1.5	1.55 H	341	51.4	1.1
5	10620.00	57.1 PK	74.0	-16.9	1.12 H	205	43.3	13.8
6	10620.00	44.1 AV	54.0	-9.9	1.12 H	205	30.3	13.8

ANTENNA POLARITY & TEST DISTANCE: VERTICAL AT 3 M								
NO.	FREQ. (MHz)	EMISSION LEVEL (dBuV/m)	LIMIT (dBuV/m)	MARGIN (dB)	ANTENNA HEIGHT (m)	TABLE ANGLE (Degree)	RAW VALUE (dBuV)	CORRECTION FACTOR (dB/m)
1	*5310.00	100.1 PK			3.16 V	25	61.2	38.9
2	*5310.00	90.7 AV			3.16 V	25	51.8	38.9
3	5350.00	56.6 PK	74.0	-17.4	3.41 V	26	55.5	1.1
4	5350.00	43.6 AV	54.0	-10.4	3.41 V	26	42.5	1.1
5	10620.00	57.5 PK	74.0	-16.5	2.74 V	171	43.7	13.8
6	10620.00	44.0 AV	54.0	-10.0	2.74 V	171	30.2	13.8

Remarks:

1. Emission Level(dBuV/m) = Raw Value(dBuV) + Correction Factor(dB/m)
2. Correction Factor(dB/m) = Antenna Factor(dB/m) + Cable Factor(dB) – Pre-Amplifier Factor(dB)
3. The other emission levels were very low against the limit.
4. Margin value = Emission Level – Limit value
5. " * ": Fundamental frequency.
6. " # ": The radiated frequency is out of the restricted band.

CHANNEL	TX Channel 102	DETECTOR FUNCTION	Peak (PK)
FREQUENCY RANGE	1GHz ~ 40GHz		Average (AV)

ANTENNA POLARITY & TEST DISTANCE: HORIZONTAL AT 3 M								
NO.	FREQ. (MHz)	EMISSION LEVEL (dBuV/m)	LIMIT (dBuV/m)	MARGIN (dB)	ANTENNA HEIGHT (m)	TABLE ANGLE (Degree)	RAW VALUE (dBuV)	CORRECTION FACTOR (dB/m)
1	5460.00	62.1 PK	74.0	-11.9	1.42 H	353	60.9	1.2
2	5460.00	49.3 AV	54.0	-4.7	1.42 H	353	48.1	1.2
3	#5470.00	68.4 PK	74.0	-5.6	1.42 H	350	67.2	1.2
4	#5470.00	52.6 AV	54.0	-1.4	1.42 H	350	51.4	1.2
5	*5510.00	112.1 PK			1.49 H	353	72.8	39.3
6	*5510.00	102.2 AV			1.49 H	353	62.9	39.3
7	11020.00	58.5 PK	74.0	-15.5	2.00 H	277	43.3	15.2
8	11020.00	45.4 AV	54.0	-8.6	2.00 H	277	30.2	15.2

ANTENNA POLARITY & TEST DISTANCE: VERTICAL AT 3 M								
NO.	FREQ. (MHz)	EMISSION LEVEL (dBuV/m)	LIMIT (dBuV/m)	MARGIN (dB)	ANTENNA HEIGHT (m)	TABLE ANGLE (Degree)	RAW VALUE (dBuV)	CORRECTION FACTOR (dB/m)
1	5460.00	54.3 PK	74.0	-19.7	2.75 V	27	53.1	1.2
2	5460.00	42.2 AV	54.0	-11.8	2.75 V	27	41.0	1.2
3	#5470.00	56.3 PK	74.0	-17.7	2.75 V	35	55.1	1.2
4	#5470.00	43.1 AV	54.0	-10.9	2.75 V	35	41.9	1.2
5	*5510.00	99.8 PK			3.49 V	22	60.5	39.3
6	*5510.00	89.9 AV			3.49 V	22	50.6	39.3
7	11020.00	58.4 PK	74.0	-15.6	1.96 V	238	43.2	15.2
8	11020.00	45.5 AV	54.0	-8.5	1.96 V	238	30.3	15.2

Remarks:

1. Emission Level(dBuV/m) = Raw Value(dBuV) + Correction Factor(dB/m)
2. Correction Factor(dB/m) = Antenna Factor(dB/m) + Cable Factor(dB) – Pre-Amplifier Factor(dB)
3. The other emission levels were very low against the limit.
4. Margin value = Emission Level – Limit value
5. " * ": Fundamental frequency.
6. " # ": The radiated frequency is out of the restricted band.

CHANNEL	TX Channel 110	DETECTOR	Peak (PK)
FREQUENCY RANGE	1GHz ~ 40GHz	FUNCTION	Average (AV)

ANTENNA POLARITY & TEST DISTANCE: HORIZONTAL AT 3 M

NO.	FREQ. (MHz)	EMISSION LEVEL (dBuV/m)	LIMIT (dBuV/m)	MARGIN (dB)	ANTENNA HEIGHT (m)	TABLE ANGLE (Degree)	RAW VALUE (dBuV)	CORRECTION FACTOR (dB/m)
1	*5550.00	112.8 PK			1.36 H	353	73.5	39.3
2	*5550.00	103.5 AV			1.36 H	353	64.2	39.3
3	11100.00	58.6 PK	74.0	-15.4	1.64 H	183	43.8	14.8
4	11100.00	45.5 AV	54.0	-8.5	1.64 H	183	30.7	14.8

ANTENNA POLARITY & TEST DISTANCE: VERTICAL AT 3 M

NO.	FREQ. (MHz)	EMISSION LEVEL (dBuV/m)	LIMIT (dBuV/m)	MARGIN (dB)	ANTENNA HEIGHT (m)	TABLE ANGLE (Degree)	RAW VALUE (dBuV)	CORRECTION FACTOR (dB/m)
1	*5550.00	100.8 PK			3.63 V	20	61.5	39.3
2	*5550.00	91.1 AV			3.63 V	20	51.8	39.3
3	11100.00	58.6 PK	74.0	-15.4	2.79 V	49	43.8	14.8
4	11100.00	45.5 AV	54.0	-8.5	2.79 V	49	30.7	14.8

Remarks:

1. Emission Level(dBuV/m) = Raw Value(dBuV) + Correction Factor(dB/m)
2. Correction Factor(dB/m) = Antenna Factor(dB/m) + Cable Factor(dB) – Pre-Amplifier Factor(dB)
3. The other emission levels were very low against the limit.
4. Margin value = Emission Level – Limit value
5. " * ": Fundamental frequency.
6. " # ": The radiated frequency is out of the restricted band.

CHANNEL	TX Channel 134	DETECTOR FUNCTION	Peak (PK)
FREQUENCY RANGE	1GHz ~ 40GHz		Average (AV)

ANTENNA POLARITY & TEST DISTANCE: HORIZONTAL AT 3 M

NO.	FREQ. (MHz)	EMISSION LEVEL (dBuV/m)	LIMIT (dBuV/m)	MARGIN (dB)	ANTENNA HEIGHT (m)	TABLE ANGLE (Degree)	RAW VALUE (dBuV)	CORRECTION FACTOR (dB/m)
1	*5670.00	111.9 PK			1.51 H	357	72.2	39.7
2	*5670.00	102.3 AV			1.51 H	357	62.6	39.7
3	#5725.00	63.2 PK	74.0	-10.8	1.31 H	353	61.2	2.0
4	#5725.00	52.4 AV	54.0	-1.6	1.31 H	353	50.4	2.0
5	11340.00	58.9 PK	74.0	-15.1	1.18 H	179	44.2	14.7
6	11340.00	45.5 AV	54.0	-8.5	1.18 H	179	30.8	14.7

ANTENNA POLARITY & TEST DISTANCE: VERTICAL AT 3 M

NO.	FREQ. (MHz)	EMISSION LEVEL (dBuV/m)	LIMIT (dBuV/m)	MARGIN (dB)	ANTENNA HEIGHT (m)	TABLE ANGLE (Degree)	RAW VALUE (dBuV)	CORRECTION FACTOR (dB/m)
1	*5670.00	100.9 PK			2.79 V	22	61.2	39.7
2	*5670.00	91.1 AV			2.79 V	22	51.4	39.7
3	#5725.00	54.8 PK	74.0	-19.2	3.54 V	20	52.8	2.0
4	#5725.00	43.4 AV	54.0	-10.6	3.54 V	20	41.4	2.0
5	11340.00	58.6 PK	74.0	-15.4	3.02 V	81	43.9	14.7
6	11340.00	45.5 AV	54.0	-8.5	3.02 V	81	30.8	14.7

Remarks:

1. Emission Level(dBuV/m) = Raw Value(dBuV) + Correction Factor(dB/m)
2. Correction Factor(dB/m) = Antenna Factor(dB/m) + Cable Factor(dB) – Pre-Amplifier Factor(dB)
3. The other emission levels were very low against the limit.
4. Margin value = Emission Level – Limit value
5. " * ": Fundamental frequency.
6. " # ": The radiated frequency is out of the restricted band.

CHANNEL	TX Channel 142	DETECTOR FUNCTION	Peak (PK)
FREQUENCY RANGE	1GHz ~ 40GHz		Average (AV)

ANTENNA POLARITY & TEST DISTANCE: HORIZONTAL AT 3 M								
NO.	FREQ. (MHz)	EMISSION LEVEL (dBuV/m)	LIMIT (dBuV/m)	MARGIN (dB)	ANTENNA HEIGHT (m)	TABLE ANGLE (Degree)	RAW VALUE (dBuV)	CORRECTION FACTOR (dB/m)
1	#5470.00	56.7 PK	74.0	-17.3	1.77 H	0	55.5	1.2
2	#5470.00	45.4 AV	54.0	-8.6	1.77 H	0	44.2	1.2
3	*5710.00	116.8 PK			1.73 H	357	76.9	39.9
4	*5710.00	107.4 AV			1.73 H	357	67.5	39.9
5	#5825.00	58.1 PK	74.0	-15.9	1.63 H	203	55.9	2.2
6	#5825.00	46.9 AV	54.0	-7.1	1.63 H	203	44.7	2.2
7	11420.00	59.4 PK	74.0	-14.6	2.03 H	73	45.0	14.4
8	11420.00	46.5 AV	54.0	-7.5	2.03 H	73	32.1	14.4

ANTENNA POLARITY & TEST DISTANCE: VERTICAL AT 3 M								
NO.	FREQ. (MHz)	EMISSION LEVEL (dBuV/m)	LIMIT (dBuV/m)	MARGIN (dB)	ANTENNA HEIGHT (m)	TABLE ANGLE (Degree)	RAW VALUE (dBuV)	CORRECTION FACTOR (dB/m)
1	#5470.00	54.5 PK	74.0	-19.5	2.89 V	356	53.3	1.2
2	#5470.00	44.0 AV	54.0	-10.0	2.89 V	356	42.8	1.2
3	*5710.00	100.1 PK			3.11 V	9	60.2	39.9
4	*5710.00	90.1 AV			3.11 V	9	50.2	39.9
5	#5825.00	56.3 PK	74.0	-17.7	2.90 V	0	54.1	2.2
6	#5825.00	45.1 AV	54.0	-8.9	2.90 V	0	42.9	2.2
7	11420.00	58.0 PK	74.0	-16.0	2.77 V	25	43.6	14.4
8	11420.00	46.4 AV	54.0	-7.6	2.77 V	25	32.0	14.4

Remarks:

1. Emission Level(dBuV/m) = Raw Value(dBuV) + Correction Factor(dB/m)
2. Correction Factor(dB/m) = Antenna Factor(dB/m) + Cable Factor(dB) – Pre-Amplifier Factor(dB)
3. The other emission levels were very low against the limit.
4. Margin value = Emission Level – Limit value
5. " * ": Fundamental frequency.
6. " # ": The radiated frequency is out of the restricted band.

802.11ac (VHT80)

CHANNEL	TX Channel 58	DETECTOR FUNCTION	Peak (PK)
FREQUENCY RANGE	1GHz ~ 40GHz		Average (AV)

ANTENNA POLARITY & TEST DISTANCE: HORIZONTAL AT 3 M

NO.	FREQ. (MHz)	EMISSION LEVEL (dBuV/m)	LIMIT (dBuV/m)	MARGIN (dB)	ANTENNA HEIGHT (m)	TABLE ANGLE (Degree)	RAW VALUE (dBuV)	CORRECTION FACTOR (dB/m)
1	*5290.00	108.9 PK			1.74 H	346	70.0	38.9
2	*5290.00	99.6 AV			1.74 H	346	60.7	38.9
3	5350.00	65.3 PK	74.0	-8.7	1.67 H	348	64.2	1.1
4	5350.00	52.4 AV	54.0	-1.6	1.67 H	348	51.3	1.1
5	#10580.00	57.3 PK	74.0	-16.7	1.18 H	217	43.5	13.8
6	#10580.00	44.2 AV	54.0	-9.8	1.18 H	217	30.4	13.8

ANTENNA POLARITY & TEST DISTANCE: VERTICAL AT 3 M

NO.	FREQ. (MHz)	EMISSION LEVEL (dBuV/m)	LIMIT (dBuV/m)	MARGIN (dB)	ANTENNA HEIGHT (m)	TABLE ANGLE (Degree)	RAW VALUE (dBuV)	CORRECTION FACTOR (dB/m)
1	*5290.00	98.0 PK			3.64 V	18	59.1	38.9
2	*5290.00	87.6 AV			3.64 V	18	48.7	38.9
3	5350.00	56.1 PK	74.0	-17.9	3.39 V	25	55.0	1.1
4	5350.00	43.2 AV	54.0	-10.8	3.39 V	25	42.1	1.1
5	#10580.00	57.5 PK	74.0	-16.5	2.70 V	15	43.7	13.8
6	#10580.00	44.2 AV	54.0	-9.8	2.70 V	15	30.4	13.8

Remarks:

1. Emission Level(dBuV/m) = Raw Value(dBuV) + Correction Factor(dB/m)
2. Correction Factor(dB/m) = Antenna Factor(dB/m) + Cable Factor(dB) – Pre-Amplifier Factor(dB)
3. The other emission levels were very low against the limit.
4. Margin value = Emission Level – Limit value
5. " * ": Fundamental frequency.
6. " # ": The radiated frequency is out of the restricted band.

CHANNEL	TX Channel 106	DETECTOR FUNCTION	Peak (PK)
FREQUENCY RANGE	1GHz ~ 40GHz		Average (AV)

ANTENNA POLARITY & TEST DISTANCE: HORIZONTAL AT 3 M

NO.	FREQ. (MHz)	EMISSION LEVEL (dBuV/m)	LIMIT (dBuV/m)	MARGIN (dB)	ANTENNA HEIGHT (m)	TABLE ANGLE (Degree)	RAW VALUE (dBuV)	CORRECTION FACTOR (dB/m)
1	5460.00	64.3 PK	74.0	-9.7	1.27 H	346	63.1	1.2
2	5460.00	51.3 AV	54.0	-2.7	1.27 H	346	50.1	1.2
3	#5470.00	65.5 PK	74.0	-8.5	1.38 H	344	64.3	1.2
4	#5470.00	52.4 AV	54.0	-1.6	1.38 H	344	51.2	1.2
5	*5530.00	108.2 PK			1.45 H	360	68.9	39.3
6	*5530.00	98.7 AV			1.45 H	360	59.4	39.3
7	11060.00	58.5 PK	74.0	-15.5	1.17 H	218	43.6	14.9
8	11060.00	45.4 AV	54.0	-8.6	1.17 H	218	30.5	14.9

ANTENNA POLARITY & TEST DISTANCE: VERTICAL AT 3 M

NO.	FREQ. (MHz)	EMISSION LEVEL (dBuV/m)	LIMIT (dBuV/m)	MARGIN (dB)	ANTENNA HEIGHT (m)	TABLE ANGLE (Degree)	RAW VALUE (dBuV)	CORRECTION FACTOR (dB/m)
1	5460.00	57.0 PK	74.0	-17.0	3.53 V	34	55.8	1.2
2	5460.00	44.9 AV	54.0	-9.1	3.53 V	34	43.7	1.2
3	#5470.00	59.5 PK	74.0	-14.5	3.59 V	31	58.3	1.2
4	#5470.00	45.7 AV	54.0	-8.3	3.59 V	31	44.5	1.2
5	*5530.00	98.2 PK			3.61 V	21	58.9	39.3
6	*5530.00	88.3 AV			3.61 V	21	49.0	39.3
7	11060.00	58.6 PK	74.0	-15.4	3.30 V	112	43.7	14.9
8	11060.00	45.6 AV	54.0	-8.4	3.30 V	112	30.7	14.9

Remarks:

1. Emission Level(dBuV/m) = Raw Value(dBuV) + Correction Factor(dB/m)
2. Correction Factor(dB/m) = Antenna Factor(dB/m) + Cable Factor(dB) – Pre-Amplifier Factor(dB)
3. The other emission levels were very low against the limit.
4. Margin value = Emission Level – Limit value
5. " * ": Fundamental frequency.
6. " # ": The radiated frequency is out of the restricted band.

CHANNEL	TX Channel 122	DETECTOR FUNCTION	Peak (PK)
FREQUENCY RANGE	1GHz ~ 40GHz		Average (AV)

ANTENNA POLARITY & TEST DISTANCE: HORIZONTAL AT 3 M

NO.	FREQ. (MHz)	EMISSION LEVEL (dBuV/m)	LIMIT (dBuV/m)	MARGIN (dB)	ANTENNA HEIGHT (m)	TABLE ANGLE (Degree)	RAW VALUE (dBuV)	CORRECTION FACTOR (dB/m)
1	5460.00	58.1 PK	74.0	-15.9	1.80 H	340	56.9	1.2
2	5460.00	46.8 AV	54.0	-7.2	1.80 H	340	45.6	1.2
3	#5470.00	60.7 PK	74.0	-13.3	1.80 H	346	59.5	1.2
4	#5470.00	48.3 AV	54.0	-5.7	1.80 H	346	47.1	1.2
5	*5610.00	111.5 PK			1.76 H	339	71.9	39.6
6	*5610.00	101.9 AV			1.76 H	339	62.3	39.6
7	#5725.00	65.5 PK	74.0	-8.5	1.64 H	338	63.5	2.0
8	#5725.00	52.8 AV	54.0	-1.2	1.64 H	338	50.8	2.0
9	11220.00	58.9 PK	74.0	-15.1	1.66 H	352	43.8	15.1
10	11220.00	46.8 AV	54.0	-7.2	1.66 H	352	31.7	15.1

ANTENNA POLARITY & TEST DISTANCE: VERTICAL AT 3 M

NO.	FREQ. (MHz)	EMISSION LEVEL (dBuV/m)	LIMIT (dBuV/m)	MARGIN (dB)	ANTENNA HEIGHT (m)	TABLE ANGLE (Degree)	RAW VALUE (dBuV)	CORRECTION FACTOR (dB/m)
1	5460.00	56.0 PK	74.0	-18.0	2.10 V	331	54.8	1.2
2	5460.00	44.1 AV	54.0	-9.9	2.10 V	331	42.9	1.2
3	#5470.00	56.2 PK	74.0	-17.8	2.12 V	340	55.0	1.2
4	#5470.00	43.5 AV	54.0	-10.5	2.12 V	340	42.3	1.2
5	*5610.00	99.4 PK			2.94 V	13	59.8	39.6
6	*5610.00	89.9 AV			2.94 V	13	50.3	39.6
7	#5725.00	56.2 PK	74.0	-17.8	1.63 V	2	54.2	2.0
8	#5725.00	44.9 AV	54.0	-9.1	1.63 V	2	42.9	2.0
9	11220.00	57.7 PK	74.0	-16.3	1.87 V	0	42.6	15.1
10	11220.00	46.1 AV	54.0	-7.9	1.87 V	0	31.0	15.1

Remarks:

1. Emission Level(dBuV/m) = Raw Value(dBuV) + Correction Factor(dB/m)
2. Correction Factor(dB/m) = Antenna Factor(dB/m) + Cable Factor(dB) – Pre-Amplifier Factor(dB)
3. The other emission levels were very low against the limit.
4. Margin value = Emission Level – Limit value
5. " * ": Fundamental frequency.
6. " # ": The radiated frequency is out of the restricted band.

CHANNEL	TX Channel 138	DETECTOR FUNCTION	Peak (PK)
FREQUENCY RANGE	1GHz ~ 40GHz		Average (AV)

ANTENNA POLARITY & TEST DISTANCE: HORIZONTAL AT 3 M								
NO.	FREQ. (MHz)	EMISSION LEVEL (dBuV/m)	LIMIT (dBuV/m)	MARGIN (dB)	ANTENNA HEIGHT (m)	TABLE ANGLE (Degree)	RAW VALUE (dBuV)	CORRECTION FACTOR (dB/m)
1	#5470.00	58.7 PK	74.0	-15.3	1.80 H	356	57.5	1.2
2	#5470.00	45.5 AV	54.0	-8.5	1.80 H	356	44.3	1.2
3	*5690.00	113.1 PK			1.71 H	345	73.3	39.8
4	*5690.00	103.5 AV			1.71 H	345	63.7	39.8
5	#5825.00	65.0 PK	74.0	-9.0	1.61 H	343	62.8	2.2
6	#5825.00	52.3 AV	54.0	-1.7	1.61 H	343	50.1	2.2
7	11380.00	58.9 PK	74.0	-15.1	1.36 H	21	44.4	14.5
8	11380.00	46.3 AV	54.0	-7.7	1.36 H	21	31.8	14.5

ANTENNA POLARITY & TEST DISTANCE: VERTICAL AT 3 M								
NO.	FREQ. (MHz)	EMISSION LEVEL (dBuV/m)	LIMIT (dBuV/m)	MARGIN (dB)	ANTENNA HEIGHT (m)	TABLE ANGLE (Degree)	RAW VALUE (dBuV)	CORRECTION FACTOR (dB/m)
1	#5470.00	56.3 PK	74.0	-17.7	1.80 V	350	55.1	1.2
2	#5470.00	44.8 AV	54.0	-9.2	1.80 V	350	43.6	1.2
3	*5690.00	100.0 PK			3.13 V	9	60.2	39.8
4	*5690.00	90.1 AV			3.13 V	9	50.3	39.8
5	#5825.00	56.9 PK	74.0	-17.1	1.77 V	344	54.7	2.2
6	#5825.00	43.5 AV	54.0	-10.5	1.77 V	344	41.3	2.2
7	11380.00	58.1 PK	74.0	-15.9	2.23 V	359	43.6	14.5
8	11380.00	45.8 AV	54.0	-8.2	2.23 V	359	31.3	14.5

Remarks:

1. Emission Level(dBuV/m) = Raw Value(dBuV) + Correction Factor(dB/m)
2. Correction Factor(dB/m) = Antenna Factor(dB/m) + Cable Factor(dB) – Pre-Amplifier Factor(dB)
3. The other emission levels were very low against the limit.
4. Margin value = Emission Level – Limit value
5. " * ": Fundamental frequency.
6. " # ": The radiated frequency is out of the restricted band.

Test Mode K

802.11a

CHANNEL	TX Channel 52	DETECTOR FUNCTION	Peak (PK)
FREQUENCY RANGE	1GHz ~ 40GHz		Average (AV)

ANTENNA POLARITY & TEST DISTANCE: HORIZONTAL AT 3 M

NO.	FREQ. (MHz)	EMISSION LEVEL (dBuV/m)	LIMIT (dBuV/m)	MARGIN (dB)	ANTENNA HEIGHT (m)	TABLE ANGLE (Degree)	RAW VALUE (dBuV)	CORRECTION FACTOR (dB/m)
1	5150.00	55.6 PK	74.0	-18.4	1.95 H	65	54.8	0.8
2	5150.00	43.0 AV	54.0	-11.0	1.95 H	65	42.2	0.8
3	*5260.00	118.0 PK			3.20 H	43	79.2	38.8
4	*5260.00	107.6 AV			3.20 H	43	68.8	38.8
5	5350.00	56.9 PK	74.0	-17.1	2.94 H	71	55.8	1.1
6	5350.00	43.9 AV	54.0	-10.1	2.94 H	71	42.8	1.1
7	#10520.00	57.6 PK	74.0	-16.4	1.38 H	149	43.9	13.7
8	#10520.00	44.0 AV	54.0	-10.0	1.38 H	149	30.3	13.7

ANTENNA POLARITY & TEST DISTANCE: VERTICAL AT 3 M

NO.	FREQ. (MHz)	EMISSION LEVEL (dBuV/m)	LIMIT (dBuV/m)	MARGIN (dB)	ANTENNA HEIGHT (m)	TABLE ANGLE (Degree)	RAW VALUE (dBuV)	CORRECTION FACTOR (dB/m)
1	5150.00	54.9 PK	74.0	-19.1	1.50 V	200	54.1	0.8
2	5150.00	41.9 AV	54.0	-12.1	1.50 V	200	41.1	0.8
3	*5260.00	113.0 PK			3.92 V	7	74.2	38.8
4	*5260.00	102.3 AV			3.92 V	7	63.5	38.8
5	5350.00	55.2 PK	74.0	-18.8	1.66 V	283	54.1	1.1
6	5350.00	42.0 AV	54.0	-12.0	1.66 V	283	40.9	1.1
7	#10520.00	56.9 PK	74.0	-17.1	1.62 V	238	43.2	13.7
8	#10520.00	43.7 AV	54.0	-10.3	1.62 V	238	30.0	13.7

Remarks:

1. Emission Level(dBuV/m) = Raw Value(dBuV) + Correction Factor(dB/m)
2. Correction Factor(dB/m) = Antenna Factor(dB/m) + Cable Factor(dB) – Pre-Amplifier Factor(dB)
3. The other emission levels were very low against the limit.
4. Margin value = Emission Level – Limit value
5. " * ": Fundamental frequency.
6. " # ": The radiated frequency is out of the restricted band.

CHANNEL	TX Channel 60	DETECTOR FUNCTION	Peak (PK)
FREQUENCY RANGE	1GHz ~ 40GHz		Average (AV)

ANTENNA POLARITY & TEST DISTANCE: HORIZONTAL AT 3 M

NO.	FREQ. (MHz)	EMISSION LEVEL (dBuV/m)	LIMIT (dBuV/m)	MARGIN (dB)	ANTENNA HEIGHT (m)	TABLE ANGLE (Degree)	RAW VALUE (dBuV)	CORRECTION FACTOR (dB/m)
1	*5300.00	118.3 PK			2.99 H	66	79.4	38.9
2	*5300.00	107.2 AV			2.99 H	66	68.3	38.9
3	10600.00	57.7 PK	74.0	-16.3	2.01 H	274	43.9	13.8
4	10600.00	44.4 AV	54.0	-9.6	2.01 H	274	30.6	13.8

ANTENNA POLARITY & TEST DISTANCE: VERTICAL AT 3 M

NO.	FREQ. (MHz)	EMISSION LEVEL (dBuV/m)	LIMIT (dBuV/m)	MARGIN (dB)	ANTENNA HEIGHT (m)	TABLE ANGLE (Degree)	RAW VALUE (dBuV)	CORRECTION FACTOR (dB/m)
1	*5300.00	111.8 PK			3.39 V	329	72.9	38.9
2	*5300.00	100.9 AV			3.39 V	329	62.0	38.9
3	10600.00	58.6 PK	74.0	-15.4	1.49 V	226	44.8	13.8
4	10600.00	44.5 AV	54.0	-9.5	1.49 V	226	30.7	13.8

Remarks:

1. Emission Level(dBuV/m) = Raw Value(dBuV) + Correction Factor(dB/m)
2. Correction Factor(dB/m) = Antenna Factor(dB/m) + Cable Factor(dB) – Pre-Amplifier Factor(dB)
3. The other emission levels were very low against the limit.
4. Margin value = Emission Level – Limit value
5. " * ": Fundamental frequency.
6. " # ": The radiated frequency is out of the restricted band.

CHANNEL	TX Channel 64	DETECTOR FUNCTION	Peak (PK)
FREQUENCY RANGE	1GHz ~ 40GHz		Average (AV)

ANTENNA POLARITY & TEST DISTANCE: HORIZONTAL AT 3 M

NO.	FREQ. (MHz)	EMISSION LEVEL (dBuV/m)	LIMIT (dBuV/m)	MARGIN (dB)	ANTENNA HEIGHT (m)	TABLE ANGLE (Degree)	RAW VALUE (dBuV)	CORRECTION FACTOR (dB/m)
1	*5320.00	118.3 PK			2.99 H	65	79.3	39.0
2	*5320.00	107.4 AV			2.99 H	65	68.4	39.0
3	5350.00	65.7 PK	74.0	-8.3	3.16 H	41	64.6	1.1
4	5350.00	52.3 AV	54.0	-1.7	3.16 H	41	51.2	1.1
5	10640.00	57.7 PK	74.0	-16.3	2.63 H	209	43.8	13.9
6	10640.00	43.8 AV	54.0	-10.2	2.63 H	209	29.9	13.9

ANTENNA POLARITY & TEST DISTANCE: VERTICAL AT 3 M

NO.	FREQ. (MHz)	EMISSION LEVEL (dBuV/m)	LIMIT (dBuV/m)	MARGIN (dB)	ANTENNA HEIGHT (m)	TABLE ANGLE (Degree)	RAW VALUE (dBuV)	CORRECTION FACTOR (dB/m)
1	*5320.00	114.0 PK			3.82 V	347	75.0	39.0
2	*5320.00	103.3 AV			3.82 V	347	64.3	39.0
3	5350.00	56.9 PK	74.0	-17.1	1.57 V	299	55.8	1.1
4	5350.00	44.5 AV	54.0	-9.5	1.57 V	299	43.4	1.1
5	10640.00	57.7 PK	74.0	-16.3	1.77 V	192	43.8	13.9
6	10640.00	44.2 AV	54.0	-9.8	1.77 V	192	30.3	13.9

Remarks:

1. Emission Level(dBuV/m) = Raw Value(dBuV) + Correction Factor(dB/m)
2. Correction Factor(dB/m) = Antenna Factor(dB/m) + Cable Factor(dB) – Pre-Amplifier Factor(dB)
3. The other emission levels were very low against the limit.
4. Margin value = Emission Level – Limit value
5. " * ": Fundamental frequency.
6. " # ": The radiated frequency is out of the restricted band.

CHANNEL	TX Channel 100	DETECTOR FUNCTION	Peak (PK)
FREQUENCY RANGE	1GHz ~ 40GHz		Average (AV)

ANTENNA POLARITY & TEST DISTANCE: HORIZONTAL AT 3 M

NO.	FREQ. (MHz)	EMISSION LEVEL (dBuV/m)	LIMIT (dBuV/m)	MARGIN (dB)	ANTENNA HEIGHT (m)	TABLE ANGLE (Degree)	RAW VALUE (dBuV)	CORRECTION FACTOR (dB/m)
1	5460.00	61.2 PK	74.0	-12.8	2.84 H	56	60.0	1.2
2	5460.00	46.2 AV	54.0	-7.8	2.84 H	56	45.0	1.2
3	#5470.00	67.9 PK	74.0	-6.1	2.78 H	58	66.7	1.2
4	#5470.00	51.4 AV	54.0	-2.6	2.78 H	58	50.2	1.2
5	*5500.00	116.5 PK			3.78 H	45	77.2	39.3
6	*5500.00	106.2 AV			3.78 H	45	66.9	39.3
7	11000.00	58.8 PK	74.0	-15.2	2.58 H	77	43.5	15.3
8	11000.00	45.1 AV	54.0	-8.9	2.58 H	77	29.8	15.3

ANTENNA POLARITY & TEST DISTANCE: VERTICAL AT 3 M

NO.	FREQ. (MHz)	EMISSION LEVEL (dBuV/m)	LIMIT (dBuV/m)	MARGIN (dB)	ANTENNA HEIGHT (m)	TABLE ANGLE (Degree)	RAW VALUE (dBuV)	CORRECTION FACTOR (dB/m)
1	5460.00	65.7 PK	74.0	-8.3	3.79 V	353	64.5	1.2
2	5460.00	49.1 AV	54.0	-4.9	3.79 V	353	47.9	1.2
3	#5470.00	65.7 PK	74.0	-8.3	3.97 V	3	64.5	1.2
4	#5470.00	48.5 AV	54.0	-5.5	3.97 V	3	47.3	1.2
5	*5500.00	113.0 PK			3.88 V	349	73.7	39.3
6	*5500.00	102.8 AV			3.88 V	349	63.5	39.3
7	11000.00	58.6 PK	74.0	-15.4	3.16 V	20	43.3	15.3
8	11000.00	45.2 AV	54.0	-8.8	3.16 V	20	29.9	15.3

Remarks:

1. Emission Level(dBuV/m) = Raw Value(dBuV) + Correction Factor(dB/m)
2. Correction Factor(dB/m) = Antenna Factor(dB/m) + Cable Factor(dB) – Pre-Amplifier Factor(dB)
3. The other emission levels were very low against the limit.
4. Margin value = Emission Level – Limit value
5. " * ": Fundamental frequency.
6. " # ": The radiated frequency is out of the restricted band.

CHANNEL	TX Channel 116	DETECTOR FUNCTION	Peak (PK)
FREQUENCY RANGE	1GHz ~ 40GHz		Average (AV)

ANTENNA POLARITY & TEST DISTANCE: HORIZONTAL AT 3 M								
NO.	FREQ. (MHz)	EMISSION LEVEL (dBuV/m)	LIMIT (dBuV/m)	MARGIN (dB)	ANTENNA HEIGHT (m)	TABLE ANGLE (Degree)	RAW VALUE (dBuV)	CORRECTION FACTOR (dB/m)
1	*5580.00	118.6 PK			3.61 H	49	79.1	39.5
2	*5580.00	108.3 AV			3.61 H	49	68.8	39.5
3	11160.00	59.0 PK	74.0	-15.0	3.59 H	289	44.1	14.9
4	11160.00	45.1 AV	54.0	-8.9	3.59 H	289	30.2	14.9
ANTENNA POLARITY & TEST DISTANCE: VERTICAL AT 3 M								
NO.	FREQ. (MHz)	EMISSION LEVEL (dBuV/m)	LIMIT (dBuV/m)	MARGIN (dB)	ANTENNA HEIGHT (m)	TABLE ANGLE (Degree)	RAW VALUE (dBuV)	CORRECTION FACTOR (dB/m)
1	*5580.00	114.7 PK			3.92 V	345	75.2	39.5
2	*5580.00	103.8 AV			3.92 V	345	64.3	39.5
3	11160.00	58.4 PK	74.0	-15.6	3.32 V	318	43.5	14.9
4	11160.00	44.9 AV	54.0	-9.1	3.32 V	318	30.0	14.9

Remarks:

1. Emission Level(dBuV/m) = Raw Value(dBuV) + Correction Factor(dB/m)
2. Correction Factor(dB/m) = Antenna Factor(dB/m) + Cable Factor(dB) – Pre-Amplifier Factor(dB)
3. The other emission levels were very low against the limit.
4. Margin value = Emission Level – Limit value
5. " * ": Fundamental frequency.
6. " # ": The radiated frequency is out of the restricted band.

CHANNEL	TX Channel 140	DETECTOR FUNCTION	Peak (PK)
FREQUENCY RANGE	1GHz ~ 40GHz		Average (AV)

ANTENNA POLARITY & TEST DISTANCE: HORIZONTAL AT 3 M								
NO.	FREQ. (MHz)	EMISSION LEVEL (dBuV/m)	LIMIT (dBuV/m)	MARGIN (dB)	ANTENNA HEIGHT (m)	TABLE ANGLE (Degree)	RAW VALUE (dBuV)	CORRECTION FACTOR (dB/m)
1	*5700.00	116.6 PK			4.00 H	37	76.8	39.8
2	*5700.00	106.0 AV			4.00 H	37	66.2	39.8
3	#5725.00	65.6 PK	74.0	-8.4	2.07 H	286	63.6	2.0
4	#5725.00	52.3 AV	54.0	-1.7	2.07 H	286	50.3	2.0
5	11400.00	58.9 PK	74.0	-15.1	2.58 H	194	44.4	14.5
6	11400.00	45.5 AV	54.0	-8.5	2.58 H	194	31.0	14.5
ANTENNA POLARITY & TEST DISTANCE: VERTICAL AT 3 M								
NO.	FREQ. (MHz)	EMISSION LEVEL (dBuV/m)	LIMIT (dBuV/m)	MARGIN (dB)	ANTENNA HEIGHT (m)	TABLE ANGLE (Degree)	RAW VALUE (dBuV)	CORRECTION FACTOR (dB/m)
1	*5700.00	112.9 PK			3.90 V	353	73.1	39.8
2	*5700.00	102.4 AV			3.90 V	353	62.6	39.8
3	#5725.00	64.6 PK	74.0	-9.4	3.42 V	4	62.6	2.0
4	#5725.00	50.2 AV	54.0	-3.8	3.42 V	4	48.2	2.0
5	11400.00	59.2 PK	74.0	-14.8	2.30 V	292	44.7	14.5
6	11400.00	45.1 AV	54.0	-8.9	2.30 V	292	30.6	14.5

Remarks:

1. Emission Level(dBuV/m) = Raw Value(dBuV) + Correction Factor(dB/m)
2. Correction Factor(dB/m) = Antenna Factor(dB/m) + Cable Factor(dB) – Pre-Amplifier Factor(dB)
3. The other emission levels were very low against the limit.
4. Margin value = Emission Level – Limit value
5. " * ": Fundamental frequency.
6. " # ": The radiated frequency is out of the restricted band.

CHANNEL	TX Channel 144	DETECTOR FUNCTION	Peak (PK)
FREQUENCY RANGE	1GHz ~ 40GHz		Average (AV)

ANTENNA POLARITY & TEST DISTANCE: HORIZONTAL AT 3 M								
NO.	FREQ. (MHz)	EMISSION LEVEL (dBuV/m)	LIMIT (dBuV/m)	MARGIN (dB)	ANTENNA HEIGHT (m)	TABLE ANGLE (Degree)	RAW VALUE (dBuV)	CORRECTION FACTOR (dB/m)
1	#5470.00	54.4 PK	74.0	-19.6	1.12 H	53	53.2	1.2
2	#5470.00	43.2 AV	54.0	-10.8	1.12 H	53	42.0	1.2
3	*5720.00	117.7 PK			1.12 H	53	77.8	39.9
4	*5720.00	107.3 AV			1.12 H	53	67.4	39.9
5	#5825.00	56.1 PK	74.0	-17.9	1.22 H	39	53.9	2.2
6	#5825.00	44.2 AV	54.0	-9.8	1.22 H	39	42.0	2.2
7	11440.00	59.7 PK	74.0	-14.3	1.33 H	162	45.2	14.5
8	11440.00	46.0 AV	54.0	-8.0	1.33 H	162	31.5	14.5

ANTENNA POLARITY & TEST DISTANCE: VERTICAL AT 3 M								
NO.	FREQ. (MHz)	EMISSION LEVEL (dBuV/m)	LIMIT (dBuV/m)	MARGIN (dB)	ANTENNA HEIGHT (m)	TABLE ANGLE (Degree)	RAW VALUE (dBuV)	CORRECTION FACTOR (dB/m)
1	#5470.00	54.4 PK	74.0	-19.6	1.74 V	144	53.2	1.2
2	#5470.00	42.8 AV	54.0	-11.2	1.74 V	144	41.6	1.2
3	*5720.00	114.8 PK			3.86 V	352	74.9	39.9
4	*5720.00	104.1 AV			3.86 V	352	64.2	39.9
5	#5825.00	54.4 PK	74.0	-19.6	1.47 V	179	52.2	2.2
6	#5825.00	43.4 AV	54.0	-10.6	1.47 V	179	41.2	2.2
7	11440.00	60.0 PK	74.0	-14.0	2.98 V	184	45.5	14.5
8	11440.00	46.8 AV	54.0	-7.2	2.98 V	184	32.3	14.5

Remarks:

1. Emission Level(dBuV/m) = Raw Value(dBuV) + Correction Factor(dB/m)
2. Correction Factor(dB/m) = Antenna Factor(dB/m) + Cable Factor(dB) – Pre-Amplifier Factor(dB)
3. The other emission levels were very low against the limit.
4. Margin value = Emission Level – Limit value
5. " * ": Fundamental frequency.
6. " # ": The radiated frequency is out of the restricted band.

802.11n (HT20)

CHANNEL	TX Channel 52	DETECTOR FUNCTION	Peak (PK) Average (AV)
FREQUENCY RANGE	1GHz ~ 40GHz		

ANTENNA POLARITY & TEST DISTANCE: HORIZONTAL AT 3 M

NO.	FREQ. (MHz)	EMISSION LEVEL (dBuV/m)	LIMIT (dBuV/m)	MARGIN (dB)	ANTENNA HEIGHT (m)	TABLE ANGLE (Degree)	RAW VALUE (dBuV)	CORRECTION FACTOR (dB/m)
1	5150.00	54.9 PK	74.0	-19.1	3.13 H	22	54.1	0.8
2	5150.00	42.8 AV	54.0	-11.2	3.13 H	22	42.0	0.8
3	*5260.00	117.6 PK			3.07 H	41	78.8	38.8
4	*5260.00	106.8 AV			3.07 H	41	68.0	38.8
5	5350.00	56.4 PK	74.0	-17.6	2.97 H	60	55.3	1.1
6	5350.00	43.3 AV	54.0	-10.7	2.97 H	60	42.2	1.1
7	#10520.00	57.3 PK	74.0	-16.7	3.03 H	87	43.6	13.7
8	#10520.00	43.9 AV	54.0	-10.1	3.03 H	87	30.2	13.7

ANTENNA POLARITY & TEST DISTANCE: VERTICAL AT 3 M

NO.	FREQ. (MHz)	EMISSION LEVEL (dBuV/m)	LIMIT (dBuV/m)	MARGIN (dB)	ANTENNA HEIGHT (m)	TABLE ANGLE (Degree)	RAW VALUE (dBuV)	CORRECTION FACTOR (dB/m)
1	5150.00	54.6 PK	74.0	-19.4	3.31 V	309	53.8	0.8
2	5150.00	41.9 AV	54.0	-12.1	3.31 V	309	41.1	0.8
3	*5260.00	113.9 PK			3.91 V	3	75.1	38.8
4	*5260.00	103.1 AV			3.91 V	3	64.3	38.8
5	5350.00	55.4 PK	74.0	-18.6	1.98 V	162	54.3	1.1
6	5350.00	42.4 AV	54.0	-11.6	1.98 V	162	41.3	1.1
7	#10520.00	57.3 PK	74.0	-16.7	2.22 V	183	43.6	13.7
8	#10520.00	43.7 AV	54.0	-10.3	2.22 V	183	30.0	13.7

Remarks:

1. Emission Level(dBuV/m) = Raw Value(dBuV) + Correction Factor(dB/m)
2. Correction Factor(dB/m) = Antenna Factor(dB/m) + Cable Factor(dB) – Pre-Amplifier Factor(dB)
3. The other emission levels were very low against the limit.
4. Margin value = Emission Level – Limit value
5. " * ": Fundamental frequency.
6. " # ": The radiated frequency is out of the restricted band.

CHANNEL	TX Channel 60	DETECTOR	Peak (PK)
FREQUENCY RANGE	1GHz ~ 40GHz	FUNCTION	Average (AV)

ANTENNA POLARITY & TEST DISTANCE: HORIZONTAL AT 3 M

NO.	FREQ. (MHz)	EMISSION LEVEL (dBuV/m)	LIMIT (dBuV/m)	MARGIN (dB)	ANTENNA HEIGHT (m)	TABLE ANGLE (Degree)	RAW VALUE (dBuV)	CORRECTION FACTOR (dB/m)
1	*5300.00	117.5 PK			3.00 H	67	78.6	38.9
2	*5300.00	106.9 AV			3.00 H	67	68.0	38.9
3	10600.00	57.8 PK	74.0	-16.2	3.42 H	N/A	44.0	13.8
4	10600.00	44.5 AV	54.0	-9.5	3.42 H	N/A	30.7	13.8

ANTENNA POLARITY & TEST DISTANCE: VERTICAL AT 3 M

NO.	FREQ. (MHz)	EMISSION LEVEL (dBuV/m)	LIMIT (dBuV/m)	MARGIN (dB)	ANTENNA HEIGHT (m)	TABLE ANGLE (Degree)	RAW VALUE (dBuV)	CORRECTION FACTOR (dB/m)
1	*5300.00	115.1 PK			3.84 V	0	76.2	38.9
2	*5300.00	104.0 AV			3.84 V	0	65.1	38.9
3	10600.00	58.8 PK	74.0	-15.2	3.15 V	13	45.0	13.8
4	10600.00	44.4 AV	54.0	-9.6	3.15 V	13	30.6	13.8

Remarks:

1. Emission Level(dBuV/m) = Raw Value(dBuV) + Correction Factor(dB/m)
2. Correction Factor(dB/m) = Antenna Factor(dB/m) + Cable Factor(dB) – Pre-Amplifier Factor(dB)
3. The other emission levels were very low against the limit.
4. Margin value = Emission Level – Limit value
5. " * ": Fundamental frequency.
6. " # ": The radiated frequency is out of the restricted band.

CHANNEL	TX Channel 64	DETECTOR FUNCTION	Peak (PK)
FREQUENCY RANGE	1GHz ~ 40GHz		Average (AV)

ANTENNA POLARITY & TEST DISTANCE: HORIZONTAL AT 3 M								
NO.	FREQ. (MHz)	EMISSION LEVEL (dBuV/m)	LIMIT (dBuV/m)	MARGIN (dB)	ANTENNA HEIGHT (m)	TABLE ANGLE (Degree)	RAW VALUE (dBuV)	CORRECTION FACTOR (dB/m)
1	*5320.00	116.5 PK			2.83 H	51	77.5	39.0
2	*5320.00	105.8 AV			2.83 H	51	66.8	39.0
3	5350.00	67.2 PK	74.0	-6.8	3.10 H	72	66.1	1.1
4	5350.00	52.3 AV	54.0	-1.7	3.10 H	72	51.2	1.1
5	10640.00	58.7 PK	74.0	-15.3	2.81 H	173	44.8	13.9
6	10640.00	45.1 AV	54.0	-8.9	2.81 H	173	31.2	13.9

ANTENNA POLARITY & TEST DISTANCE: VERTICAL AT 3 M								
NO.	FREQ. (MHz)	EMISSION LEVEL (dBuV/m)	LIMIT (dBuV/m)	MARGIN (dB)	ANTENNA HEIGHT (m)	TABLE ANGLE (Degree)	RAW VALUE (dBuV)	CORRECTION FACTOR (dB/m)
1	*5320.00	114.2 PK			3.63 V	345	75.2	39.0
2	*5320.00	103.3 AV			3.63 V	345	64.3	39.0
3	5350.00	62.2 PK	74.0	-11.8	3.75 V	336	61.1	1.1
4	5350.00	48.4 AV	54.0	-5.6	3.75 V	336	47.3	1.1
5	10640.00	57.3 PK	74.0	-16.7	3.33 V	235	43.4	13.9
6	10640.00	43.9 AV	54.0	-10.1	3.33 V	235	30.0	13.9

Remarks:

1. Emission Level(dBuV/m) = Raw Value(dBuV) + Correction Factor(dB/m)
2. Correction Factor(dB/m) = Antenna Factor(dB/m) + Cable Factor(dB) – Pre-Amplifier Factor(dB)
3. The other emission levels were very low against the limit.
4. Margin value = Emission Level – Limit value
5. " * ": Fundamental frequency.
6. " # ": The radiated frequency is out of the restricted band.

CHANNEL	TX Channel 100	DETECTOR FUNCTION	Peak (PK)
FREQUENCY RANGE	1GHz ~ 40GHz		Average (AV)

ANTENNA POLARITY & TEST DISTANCE: HORIZONTAL AT 3 M								
NO.	FREQ. (MHz)	EMISSION LEVEL (dBuV/m)	LIMIT (dBuV/m)	MARGIN (dB)	ANTENNA HEIGHT (m)	TABLE ANGLE (Degree)	RAW VALUE (dBuV)	CORRECTION FACTOR (dB/m)
1	5460.00	59.3 PK	74.0	-14.7	4.00 H	31	58.1	1.2
2	5460.00	46.4 AV	54.0	-7.6	4.00 H	31	45.2	1.2
3	#5470.00	65.5 PK	74.0	-8.5	2.36 H	21	64.3	1.2
4	#5470.00	48.8 AV	54.0	-5.2	2.36 H	21	47.6	1.2
5	*5500.00	117.0 PK			4.00 H	49	77.7	39.3
6	*5500.00	105.6 AV			4.00 H	49	66.3	39.3
7	11000.00	58.6 PK	74.0	-15.4	1.22 H	168	43.3	15.3
8	11000.00	45.1 AV	54.0	-8.9	1.22 H	168	29.8	15.3
ANTENNA POLARITY & TEST DISTANCE: VERTICAL AT 3 M								
NO.	FREQ. (MHz)	EMISSION LEVEL (dBuV/m)	LIMIT (dBuV/m)	MARGIN (dB)	ANTENNA HEIGHT (m)	TABLE ANGLE (Degree)	RAW VALUE (dBuV)	CORRECTION FACTOR (dB/m)
1	5460.00	57.5 PK	74.0	-16.5	3.32 V	344	56.3	1.2
2	5460.00	44.0 AV	54.0	-10.0	3.32 V	344	42.8	1.2
3	#5470.00	65.1 PK	74.0	-8.9	3.90 V	338	63.9	1.2
4	#5470.00	49.1 AV	54.0	-4.9	3.90 V	338	47.9	1.2
5	*5500.00	113.6 PK			3.90 V	350	74.3	39.3
6	*5500.00	102.3 AV			3.90 V	350	63.0	39.3
7	11000.00	58.2 PK	74.0	-15.8	2.93 V	310	42.9	15.3
8	11000.00	45.2 AV	54.0	-8.8	2.93 V	310	29.9	15.3

Remarks:

1. Emission Level(dBuV/m) = Raw Value(dBuV) + Correction Factor(dB/m)
2. Correction Factor(dB/m) = Antenna Factor(dB/m) + Cable Factor(dB) – Pre-Amplifier Factor(dB)
3. The other emission levels were very low against the limit.
4. Margin value = Emission Level – Limit value
5. " * ": Fundamental frequency.
6. " # ": The radiated frequency is out of the restricted band.

CHANNEL	TX Channel 116	DETECTOR FUNCTION	Peak (PK)
FREQUENCY RANGE	1GHz ~ 40GHz		Average (AV)

ANTENNA POLARITY & TEST DISTANCE: HORIZONTAL AT 3 M								
NO.	FREQ. (MHz)	EMISSION LEVEL (dBuV/m)	LIMIT (dBuV/m)	MARGIN (dB)	ANTENNA HEIGHT (m)	TABLE ANGLE (Degree)	RAW VALUE (dBuV)	CORRECTION FACTOR (dB/m)
1	*5580.00	117.3 PK			4.00 H	42	77.8	39.5
2	*5580.00	106.3 AV			4.00 H	42	66.8	39.5
3	11160.00	59.6 PK	74.0	-14.4	2.56 H	296	44.7	14.9
4	11160.00	46.2 AV	54.0	-7.8	2.56 H	296	31.3	14.9
ANTENNA POLARITY & TEST DISTANCE: VERTICAL AT 3 M								
NO.	FREQ. (MHz)	EMISSION LEVEL (dBuV/m)	LIMIT (dBuV/m)	MARGIN (dB)	ANTENNA HEIGHT (m)	TABLE ANGLE (Degree)	RAW VALUE (dBuV)	CORRECTION FACTOR (dB/m)
1	*5580.00	112.7 PK			3.90 V	21	73.2	39.5
2	*5580.00	102.1 AV			3.90 V	21	62.6	39.5
3	11160.00	58.8 PK	74.0	-15.2	3.30 V	319	43.9	14.9
4	11160.00	45.2 AV	54.0	-8.8	3.30 V	319	30.3	14.9

Remarks:

1. Emission Level(dBuV/m) = Raw Value(dBuV) + Correction Factor(dB/m)
2. Correction Factor(dB/m) = Antenna Factor(dB/m) + Cable Factor(dB) – Pre-Amplifier Factor(dB)
3. The other emission levels were very low against the limit.
4. Margin value = Emission Level – Limit value
5. " * ": Fundamental frequency.
6. " # ": The radiated frequency is out of the restricted band.

CHANNEL	TX Channel 140	DETECTOR FUNCTION	Peak (PK)
FREQUENCY RANGE	1GHz ~ 40GHz		Average (AV)

ANTENNA POLARITY & TEST DISTANCE: HORIZONTAL AT 3 M								
NO.	FREQ. (MHz)	EMISSION LEVEL (dBuV/m)	LIMIT (dBuV/m)	MARGIN (dB)	ANTENNA HEIGHT (m)	TABLE ANGLE (Degree)	RAW VALUE (dBuV)	CORRECTION FACTOR (dB/m)
1	*5700.00	114.4 PK			3.85 H	44	74.6	39.8
2	*5700.00	103.4 AV			3.85 H	44	63.6	39.8
3	#5725.00	65.8 PK	74.0	-8.2	3.89 H	39	63.8	2.0
4	#5725.00	52.3 AV	54.0	-1.7	3.89 H	39	50.3	2.0
5	11400.00	59.2 PK	74.0	-14.8	2.85 H	187	44.7	14.5
6	11400.00	45.8 AV	54.0	-8.2	2.85 H	187	31.3	14.5
ANTENNA POLARITY & TEST DISTANCE: VERTICAL AT 3 M								
NO.	FREQ. (MHz)	EMISSION LEVEL (dBuV/m)	LIMIT (dBuV/m)	MARGIN (dB)	ANTENNA HEIGHT (m)	TABLE ANGLE (Degree)	RAW VALUE (dBuV)	CORRECTION FACTOR (dB/m)
1	*5700.00	110.5 PK			3.94 V	354	70.7	39.8
2	*5700.00	100.1 AV			3.94 V	354	60.3	39.8
3	#5725.00	60.1 PK	74.0	-13.9	3.85 V	357	58.1	2.0
4	#5725.00	47.5 AV	54.0	-6.5	3.85 V	357	45.5	2.0
5	11400.00	58.6 PK	74.0	-15.4	3.39 V	325	44.1	14.5
6	11400.00	45.2 AV	54.0	-8.8	3.39 V	325	30.7	14.5

Remarks:

1. Emission Level(dBuV/m) = Raw Value(dBuV) + Correction Factor(dB/m)
2. Correction Factor(dB/m) = Antenna Factor(dB/m) + Cable Factor(dB) – Pre-Amplifier Factor(dB)
3. The other emission levels were very low against the limit.
4. Margin value = Emission Level – Limit value
5. " * ": Fundamental frequency.
6. " # ": The radiated frequency is out of the restricted band.

CHANNEL	TX Channel 144	DETECTOR FUNCTION	Peak (PK)
FREQUENCY RANGE	1GHz ~ 40GHz		Average (AV)

ANTENNA POLARITY & TEST DISTANCE: HORIZONTAL AT 3 M

NO.	FREQ. (MHz)	EMISSION LEVEL (dBuV/m)	LIMIT (dBuV/m)	MARGIN (dB)	ANTENNA HEIGHT (m)	TABLE ANGLE (Degree)	RAW VALUE (dBuV)	CORRECTION FACTOR (dB/m)
1	#5470.00	55.2 PK	74.0	-18.8	1.26 H	59	54.0	1.2
2	#5470.00	43.2 AV	54.0	-10.8	1.26 H	59	42.0	1.2
3	*5720.00	117.9 PK			1.99 H	45	78.0	39.9
4	*5720.00	107.5 AV			1.99 H	45	67.6	39.9
5	#5825.00	55.7 PK	74.0	-18.3	1.34 H	41	53.5	2.2
6	#5825.00	43.8 AV	54.0	-10.2	1.34 H	41	41.6	2.2
7	11440.00	59.8 PK	74.0	-14.2	1.74 H	99	45.3	14.5
8	11440.00	46.5 AV	54.0	-7.5	1.74 H	99	32.0	14.5

ANTENNA POLARITY & TEST DISTANCE: VERTICAL AT 3 M

NO.	FREQ. (MHz)	EMISSION LEVEL (dBuV/m)	LIMIT (dBuV/m)	MARGIN (dB)	ANTENNA HEIGHT (m)	TABLE ANGLE (Degree)	RAW VALUE (dBuV)	CORRECTION FACTOR (dB/m)
1	#5470.00	54.6 PK	74.0	-19.4	3.01 V	328	53.4	1.2
2	#5470.00	42.7 AV	54.0	-11.3	3.01 V	328	41.5	1.2
3	*5720.00	113.4 PK			3.45 V	327	73.5	39.9
4	*5720.00	102.0 AV			3.45 V	327	62.1	39.9
5	#5825.00	55.8 PK	74.0	-18.2	3.14 V	348	53.6	2.2
6	#5825.00	43.4 AV	54.0	-10.6	3.14 V	348	41.2	2.2
7	11440.00	60.1 PK	74.0	-13.9	2.98 V	265	45.6	14.5
8	11440.00	46.7 AV	54.0	-7.3	2.98 V	265	32.2	14.5

Remarks:

1. Emission Level(dBuV/m) = Raw Value(dBuV) + Correction Factor(dB/m)
2. Correction Factor(dB/m) = Antenna Factor(dB/m) + Cable Factor(dB) – Pre-Amplifier Factor(dB)
3. The other emission levels were very low against the limit.
4. Margin value = Emission Level – Limit value
5. " * ": Fundamental frequency.
6. " # ": The radiated frequency is out of the restricted band.

802.11n (HT40)

CHANNEL	TX Channel 54	DETECTOR FUNCTION	Peak (PK) Average (AV)
FREQUENCY RANGE	1GHz ~ 40GHz		

ANTENNA POLARITY & TEST DISTANCE: HORIZONTAL AT 3 M

NO.	FREQ. (MHz)	EMISSION LEVEL (dBuV/m)	LIMIT (dBuV/m)	MARGIN (dB)	ANTENNA HEIGHT (m)	TABLE ANGLE (Degree)	RAW VALUE (dBuV)	CORRECTION FACTOR (dB/m)
1	*5270.00	113.7 PK			3.05 H	36	74.8	38.9
2	*5270.00	104.2 AV			3.05 H	36	65.3	38.9
3	5350.00	60.4 PK	74.0	-13.6	2.94 H	69	59.3	1.1
4	5350.00	46.4 AV	54.0	-7.6	2.94 H	69	45.3	1.1
5	#10540.00	57.5 PK	74.0	-16.5	2.79 H	89	43.8	13.7
6	#10540.00	44.7 AV	54.0	-9.3	2.79 H	89	31.0	13.7

ANTENNA POLARITY & TEST DISTANCE: VERTICAL AT 3 M

NO.	FREQ. (MHz)	EMISSION LEVEL (dBuV/m)	LIMIT (dBuV/m)	MARGIN (dB)	ANTENNA HEIGHT (m)	TABLE ANGLE (Degree)	RAW VALUE (dBuV)	CORRECTION FACTOR (dB/m)
1	*5270.00	110.8 PK			3.87 V	351	71.9	38.9
2	*5270.00	101.3 AV			3.87 V	351	62.4	38.9
3	5350.00	57.8 PK	74.0	-16.2	3.60 V	345	56.7	1.1
4	5350.00	44.6 AV	54.0	-9.4	3.60 V	345	43.5	1.1
5	#10540.00	58.7 PK	74.0	-15.3	2.91 V	217	45.0	13.7
6	#10540.00	44.9 AV	54.0	-9.1	2.91 V	217	31.2	13.7

Remarks:

1. Emission Level(dBuV/m) = Raw Value(dBuV) + Correction Factor(dB/m)
2. Correction Factor(dB/m) = Antenna Factor(dB/m) + Cable Factor(dB) – Pre-Amplifier Factor(dB)
3. The other emission levels were very low against the limit.
4. Margin value = Emission Level – Limit value
5. " * ": Fundamental frequency.
6. " # ": The radiated frequency is out of the restricted band.

CHANNEL	TX Channel 62	DETECTOR FUNCTION	Peak (PK)
FREQUENCY RANGE	1GHz ~ 40GHz		Average (AV)

ANTENNA POLARITY & TEST DISTANCE: HORIZONTAL AT 3 M								
NO.	FREQ. (MHz)	EMISSION LEVEL (dBuV/m)	LIMIT (dBuV/m)	MARGIN (dB)	ANTENNA HEIGHT (m)	TABLE ANGLE (Degree)	RAW VALUE (dBuV)	CORRECTION FACTOR (dB/m)
1	*5310.00	113.9 PK			2.98 H	66	75.0	38.9
2	*5310.00	104.2 AV			2.98 H	66	65.3	38.9
3	5350.00	68.0 PK	74.0	-6.0	2.74 H	32	66.9	1.1
4	5350.00	52.4 AV	54.0	-1.6	2.74 H	32	51.3	1.1
5	10620.00	57.5 PK	74.0	-16.5	2.81 H	33	43.7	13.8
6	10620.00	44.5 AV	54.0	-9.5	2.81 H	33	30.7	13.8
ANTENNA POLARITY & TEST DISTANCE: VERTICAL AT 3 M								
NO.	FREQ. (MHz)	EMISSION LEVEL (dBuV/m)	LIMIT (dBuV/m)	MARGIN (dB)	ANTENNA HEIGHT (m)	TABLE ANGLE (Degree)	RAW VALUE (dBuV)	CORRECTION FACTOR (dB/m)
1	*5310.00	109.7 PK			3.83 V	349	70.8	38.9
2	*5310.00	100.2 AV			3.83 V	349	61.3	38.9
3	5350.00	64.6 PK	74.0	-9.4	3.72 V	4	63.5	1.1
4	5350.00	49.6 AV	54.0	-4.4	3.72 V	4	48.5	1.1
5	10620.00	58.0 PK	74.0	-16.0	3.31 V	162	44.2	13.8
6	10620.00	44.6 AV	54.0	-9.4	3.31 V	162	30.8	13.8

Remarks:

1. Emission Level(dBuV/m) = Raw Value(dBuV) + Correction Factor(dB/m)
2. Correction Factor(dB/m) = Antenna Factor(dB/m) + Cable Factor(dB) – Pre-Amplifier Factor(dB)
3. The other emission levels were very low against the limit.
4. Margin value = Emission Level – Limit value
5. " * ": Fundamental frequency.
6. " # ": The radiated frequency is out of the restricted band.

CHANNEL	TX Channel 102	DETECTOR FUNCTION	Peak (PK)
FREQUENCY RANGE	1GHz ~ 40GHz		Average (AV)

ANTENNA POLARITY & TEST DISTANCE: HORIZONTAL AT 3 M								
NO.	FREQ. (MHz)	EMISSION LEVEL (dBuV/m)	LIMIT (dBuV/m)	MARGIN (dB)	ANTENNA HEIGHT (m)	TABLE ANGLE (Degree)	RAW VALUE (dBuV)	CORRECTION FACTOR (dB/m)
1	5460.00	59.1 PK	74.0	-14.9	4.00 H	61	57.9	1.2
2	5460.00	47.3 AV	54.0	-6.7	4.00 H	61	46.1	1.2
3	#5470.00	66.5 PK	74.0	-7.5	4.00 H	50	65.3	1.2
4	#5470.00	52.4 AV	54.0	-1.6	4.00 H	40	51.2	1.2
5	*5510.00	109.5 PK			3.83 H	50	70.2	39.3
6	*5510.00	99.6 AV			3.83 H	50	60.3	39.3
7	11020.00	59.9 PK	74.0	-14.1	2.41 H	273	44.7	15.2
8	11020.00	45.7 AV	54.0	-8.3	2.41 H	273	30.5	15.2

ANTENNA POLARITY & TEST DISTANCE: VERTICAL AT 3 M								
NO.	FREQ. (MHz)	EMISSION LEVEL (dBuV/m)	LIMIT (dBuV/m)	MARGIN (dB)	ANTENNA HEIGHT (m)	TABLE ANGLE (Degree)	RAW VALUE (dBuV)	CORRECTION FACTOR (dB/m)
1	5460.00	57.5 PK	74.0	-16.5	3.88 V	338	56.3	1.2
2	5460.00	44.8 AV	54.0	-9.2	3.88 V	338	43.6	1.2
3	#5470.00	64.0 PK	74.0	-10.0	3.77 V	353	62.8	1.2
4	#5470.00	49.5 AV	54.0	-4.5	3.77 V	353	48.3	1.2
5	*5510.00	105.8 PK			3.81 V	339	66.5	39.3
6	*5510.00	95.9 AV			3.81 V	339	56.6	39.3
7	11020.00	58.7 PK	74.0	-15.3	3.30 V	327	43.5	15.2
8	11020.00	45.7 AV	54.0	-8.3	3.30 V	327	30.5	15.2

Remarks:

1. Emission Level(dBuV/m) = Raw Value(dBuV) + Correction Factor(dB/m)
2. Correction Factor(dB/m) = Antenna Factor(dB/m) + Cable Factor(dB) – Pre-Amplifier Factor(dB)
3. The other emission levels were very low against the limit.
4. Margin value = Emission Level – Limit value
5. " * ": Fundamental frequency.
6. " # ": The radiated frequency is out of the restricted band.

CHANNEL	TX Channel 110	DETECTOR FUNCTION	Peak (PK)
FREQUENCY RANGE	1GHz ~ 40GHz		Average (AV)

ANTENNA POLARITY & TEST DISTANCE: HORIZONTAL AT 3 M

NO.	FREQ. (MHz)	EMISSION LEVEL (dBuV/m)	LIMIT (dBuV/m)	MARGIN (dB)	ANTENNA HEIGHT (m)	TABLE ANGLE (Degree)	RAW VALUE (dBuV)	CORRECTION FACTOR (dB/m)
1	*5550.00	113.2 PK			3.56 H	61	73.9	39.3
2	*5550.00	103.0 AV			3.56 H	61	63.7	39.3
3	11100.00	58.4 PK	74.0	-15.6	2.62 H	238	43.6	14.8
4	11100.00	45.6 AV	54.0	-8.4	2.62 H	238	30.8	14.8

ANTENNA POLARITY & TEST DISTANCE: VERTICAL AT 3 M

NO.	FREQ. (MHz)	EMISSION LEVEL (dBuV/m)	LIMIT (dBuV/m)	MARGIN (dB)	ANTENNA HEIGHT (m)	TABLE ANGLE (Degree)	RAW VALUE (dBuV)	CORRECTION FACTOR (dB/m)
1	*5550.00	109.8 PK			3.94 V	341	70.5	39.3
2	*5550.00	99.9 AV			3.94 V	341	60.6	39.3
3	11100.00	58.9 PK	74.0	-15.1	3.21 V	305	44.1	14.8
4	11100.00	45.6 AV	54.0	-8.4	3.21 V	305	30.8	14.8

Remarks:

1. Emission Level(dBuV/m) = Raw Value(dBuV) + Correction Factor(dB/m)
2. Correction Factor(dB/m) = Antenna Factor(dB/m) + Cable Factor(dB) – Pre-Amplifier Factor(dB)
3. The other emission levels were very low against the limit.
4. Margin value = Emission Level – Limit value
5. " * ": Fundamental frequency.
6. " # ": The radiated frequency is out of the restricted band.

CHANNEL	TX Channel 134	DETECTOR FUNCTION	Peak (PK)
FREQUENCY RANGE	1GHz ~ 40GHz		Average (AV)

ANTENNA POLARITY & TEST DISTANCE: HORIZONTAL AT 3 M

NO.	FREQ. (MHz)	EMISSION LEVEL (dBuV/m)	LIMIT (dBuV/m)	MARGIN (dB)	ANTENNA HEIGHT (m)	TABLE ANGLE (Degree)	RAW VALUE (dBuV)	CORRECTION FACTOR (dB/m)
1	*5670.00	113.5 PK			3.74 H	58	73.8	39.7
2	*5670.00	103.5 AV			3.74 H	58	63.8	39.7
3	#5725.00	65.8 PK	74.0	-8.2	1.81 H	59	63.8	2.0
4	#5725.00	52.4 AV	54.0	-1.6	1.81 H	59	50.4	2.0
5	11340.00	57.9 PK	74.0	-16.1	2.75 H	331	43.2	14.7
6	11340.00	44.8 AV	54.0	-9.2	2.75 H	331	30.1	14.7

ANTENNA POLARITY & TEST DISTANCE: VERTICAL AT 3 M

NO.	FREQ. (MHz)	EMISSION LEVEL (dBuV/m)	LIMIT (dBuV/m)	MARGIN (dB)	ANTENNA HEIGHT (m)	TABLE ANGLE (Degree)	RAW VALUE (dBuV)	CORRECTION FACTOR (dB/m)
1	*5670.00	108.3 PK			3.46 V	344	68.6	39.7
2	*5670.00	98.9 AV			3.46 V	344	59.2	39.7
3	#5725.00	60.5 PK	74.0	-13.5	3.54 V	343	58.5	2.0
4	#5725.00	48.6 AV	54.0	-5.4	3.54 V	343	46.6	2.0
5	11340.00	58.5 PK	74.0	-15.5	3.41 V	317	43.8	14.7
6	11340.00	45.2 AV	54.0	-8.8	3.41 V	317	30.5	14.7

Remarks:

1. Emission Level(dBuV/m) = Raw Value(dBuV) + Correction Factor(dB/m)
2. Correction Factor(dB/m) = Antenna Factor(dB/m) + Cable Factor(dB) – Pre-Amplifier Factor(dB)
3. The other emission levels were very low against the limit.
4. Margin value = Emission Level – Limit value
5. " * ": Fundamental frequency.
6. " # ": The radiated frequency is out of the restricted band.

CHANNEL	TX Channel 142	DETECTOR FUNCTION	Peak (PK)
FREQUENCY RANGE	1GHz ~ 40GHz		Average (AV)

ANTENNA POLARITY & TEST DISTANCE: HORIZONTAL AT 3 M								
NO.	FREQ. (MHz)	EMISSION LEVEL (dBuV/m)	LIMIT (dBuV/m)	MARGIN (dB)	ANTENNA HEIGHT (m)	TABLE ANGLE (Degree)	RAW VALUE (dBuV)	CORRECTION FACTOR (dB/m)
1	#5470.00	53.5 PK	74.0	-20.5	2.25 H	54	52.3	1.2
2	#5470.00	43.0 AV	54.0	-11.0	2.25 H	54	41.8	1.2
3	*5710.00	114.3 PK			2.52 H	51	74.4	39.9
4	*5710.00	104.8 AV			2.52 H	51	64.9	39.9
5	#5825.00	56.0 PK	74.0	-18.0	2.08 H	51	53.8	2.2
6	#5825.00	44.2 AV	54.0	-9.8	2.08 H	51	42.0	2.2
7	11420.00	60.2 PK	74.0	-13.8	1.96 H	201	45.8	14.4
8	11420.00	46.8 AV	54.0	-7.2	1.96 H	201	32.4	14.4

ANTENNA POLARITY & TEST DISTANCE: VERTICAL AT 3 M								
NO.	FREQ. (MHz)	EMISSION LEVEL (dBuV/m)	LIMIT (dBuV/m)	MARGIN (dB)	ANTENNA HEIGHT (m)	TABLE ANGLE (Degree)	RAW VALUE (dBuV)	CORRECTION FACTOR (dB/m)
1	#5470.00	54.0 PK	74.0	-20.0	2.56 V	273	52.8	1.2
2	#5470.00	42.6 AV	54.0	-11.4	2.56 V	273	41.4	1.2
3	*5710.00	108.5 PK			3.34 V	335	68.6	39.9
4	*5710.00	99.1 AV			3.34 V	335	59.2	39.9
5	#5825.00	55.4 PK	74.0	-18.6	3.04 V	331	53.2	2.2
6	#5825.00	43.2 AV	54.0	-10.8	3.04 V	331	41.0	2.2
7	11420.00	60.5 PK	74.0	-13.5	2.93 V	311	46.1	14.4
8	11420.00	47.1 AV	54.0	-6.9	2.93 V	311	32.7	14.4

Remarks:

1. Emission Level(dBuV/m) = Raw Value(dBuV) + Correction Factor(dB/m)
2. Correction Factor(dB/m) = Antenna Factor(dB/m) + Cable Factor(dB) – Pre-Amplifier Factor(dB)
3. The other emission levels were very low against the limit.
4. Margin value = Emission Level – Limit value
5. " * ": Fundamental frequency.
6. " # ": The radiated frequency is out of the restricted band.

802.11ac (VHT80)

CHANNEL	TX Channel 58	DETECTOR FUNCTION	Peak (PK) Average (AV)
FREQUENCY RANGE	1GHz ~ 40GHz		

ANTENNA POLARITY & TEST DISTANCE: HORIZONTAL AT 3 M								
NO.	FREQ. (MHz)	EMISSION LEVEL (dBuV/m)	LIMIT (dBuV/m)	MARGIN (dB)	ANTENNA HEIGHT (m)	TABLE ANGLE (Degree)	RAW VALUE (dBuV)	CORRECTION FACTOR (dB/m)
1	*5290.00	108.8 PK			2.77 H	59	69.9	38.9
2	*5290.00	99.1 AV			2.77 H	59	60.2	38.9
3	5350.00	65.9 PK	74.0	-8.1	2.73 H	31	64.8	1.1
4	5350.00	52.3 AV	54.0	-1.7	2.73 H	31	51.2	1.1
5	#10580.00	57.9 PK	74.0	-16.1	4.00 H	228	44.1	13.8
6	#10580.00	45.1 AV	54.0	-8.9	4.00 H	228	31.3	13.8
ANTENNA POLARITY & TEST DISTANCE: VERTICAL AT 3 M								
NO.	FREQ. (MHz)	EMISSION LEVEL (dBuV/m)	LIMIT (dBuV/m)	MARGIN (dB)	ANTENNA HEIGHT (m)	TABLE ANGLE (Degree)	RAW VALUE (dBuV)	CORRECTION FACTOR (dB/m)
1	*5290.00	105.2 PK			3.86 V	349	66.3	38.9
2	*5290.00	95.2 AV			3.86 V	349	56.3	38.9
3	5350.00	62.6 PK	74.0	-11.4	3.94 V	343	61.5	1.1
4	5350.00	49.5 AV	54.0	-4.5	3.94 V	343	48.4	1.1
5	#10580.00	58.1 PK	74.0	-15.9	3.01 V	217	44.3	13.8
6	#10580.00	45.0 AV	54.0	-9.0	3.01 V	217	31.2	13.8

Remarks:

1. Emission Level(dBuV/m) = Raw Value(dBuV) + Correction Factor(dB/m)
2. Correction Factor(dB/m) = Antenna Factor(dB/m) + Cable Factor(dB) – Pre-Amplifier Factor(dB)
3. The other emission levels were very low against the limit.
4. Margin value = Emission Level – Limit value
5. " * ": Fundamental frequency.
6. " # ": The radiated frequency is out of the restricted band.

CHANNEL	TX Channel 106	DETECTOR FUNCTION	Peak (PK)
FREQUENCY RANGE	1GHz ~ 40GHz		Average (AV)

ANTENNA POLARITY & TEST DISTANCE: HORIZONTAL AT 3 M								
NO.	FREQ. (MHz)	EMISSION LEVEL (dBuV/m)	LIMIT (dBuV/m)	MARGIN (dB)	ANTENNA HEIGHT (m)	TABLE ANGLE (Degree)	RAW VALUE (dBuV)	CORRECTION FACTOR (dB/m)
1	5460.00	64.3 PK	74.0	-9.7	3.66 H	71	63.1	1.2
2	5460.00	51.9 AV	54.0	-2.1	3.66 H	71	50.7	1.2
3	#5470.00	65.0 PK	74.0	-9.0	2.36 H	56	63.8	1.2
4	#5470.00	52.5 AV	54.0	-1.5	2.36 H	56	51.3	1.2
5	*5530.00	105.4 PK			3.87 H	53	66.1	39.3
6	*5530.00	95.0 AV			3.87 H	53	55.7	39.3
7	11060.00	59.4 PK	74.0	-14.6	1.62 H	319	44.5	14.9
8	11060.00	45.7 AV	54.0	-8.3	1.62 H	319	30.8	14.9
ANTENNA POLARITY & TEST DISTANCE: VERTICAL AT 3 M								
NO.	FREQ. (MHz)	EMISSION LEVEL (dBuV/m)	LIMIT (dBuV/m)	MARGIN (dB)	ANTENNA HEIGHT (m)	TABLE ANGLE (Degree)	RAW VALUE (dBuV)	CORRECTION FACTOR (dB/m)
1	5460.00	59.4 PK	74.0	-14.6	3.15 V	334	58.2	1.2
2	5460.00	46.3 AV	54.0	-7.7	3.15 V	334	45.1	1.2
3	#5470.00	63.8 PK	74.0	-10.2	3.88 V	5	62.6	1.2
4	#5470.00	50.2 AV	54.0	-3.8	3.88 V	5	49.0	1.2
5	*5530.00	102.3 PK			3.94 V	340	63.0	39.3
6	*5530.00	92.0 AV			3.94 V	340	52.7	39.3
7	11060.00	58.9 PK	74.0	-15.1	3.29 V	341	44.0	14.9
8	11060.00	46.0 AV	54.0	-8.0	3.29 V	341	31.1	14.9

Remarks:

1. Emission Level(dBuV/m) = Raw Value(dBuV) + Correction Factor(dB/m)
2. Correction Factor(dB/m) = Antenna Factor(dB/m) + Cable Factor(dB) – Pre-Amplifier Factor(dB)
3. The other emission levels were very low against the limit.
4. Margin value = Emission Level – Limit value
5. " * ": Fundamental frequency.
6. " # ": The radiated frequency is out of the restricted band.

CHANNEL	TX Channel 122	DETECTOR FUNCTION	Peak (PK)
FREQUENCY RANGE	1GHz ~ 40GHz		Average (AV)

ANTENNA POLARITY & TEST DISTANCE: HORIZONTAL AT 3 M								
NO.	FREQ. (MHz)	EMISSION LEVEL (dBuV/m)	LIMIT (dBuV/m)	MARGIN (dB)	ANTENNA HEIGHT (m)	TABLE ANGLE (Degree)	RAW VALUE (dBuV)	CORRECTION FACTOR (dB/m)
1	5460.00	58.5 PK	74.0	-15.5	2.21 H	138	57.3	1.2
2	5460.00	45.4 AV	54.0	-8.6	2.21 H	138	44.2	1.2
3	#5470.00	64.2 PK	74.0	-9.8	2.36 H	53	63.0	1.2
4	#5470.00	48.3 AV	54.0	-5.7	2.36 H	53	47.1	1.2
5	*5610.00	111.4 PK			1.63 H	51	71.8	39.6
6	*5610.00	101.2 AV			1.63 H	51	61.6	39.6
7	#5725.00	63.7 PK	74.0	-10.3	2.30 H	52	61.7	2.0
8	#5725.00	51.8 AV	54.0	-2.2	2.30 H	52	49.8	2.0
9	11220.00	59.9 PK	74.0	-14.1	1.78 H	233	44.8	15.1
10	11220.00	46.6 AV	54.0	-7.4	1.78 H	233	31.5	15.1

ANTENNA POLARITY & TEST DISTANCE: VERTICAL AT 3 M								
NO.	FREQ. (MHz)	EMISSION LEVEL (dBuV/m)	LIMIT (dBuV/m)	MARGIN (dB)	ANTENNA HEIGHT (m)	TABLE ANGLE (Degree)	RAW VALUE (dBuV)	CORRECTION FACTOR (dB/m)
1	5460.00	55.8 PK	74.0	-18.2	2.99 V	341	54.6	1.2
2	5460.00	43.2 AV	54.0	-10.8	2.99 V	341	42.0	1.2
3	#5470.00	58.0 PK	74.0	-16.0	3.94 V	318	56.8	1.2
4	#5470.00	44.2 AV	54.0	-9.8	3.94 V	318	43.0	1.2
5	*5610.00	107.8 PK			3.84 V	357	68.2	39.6
6	*5610.00	97.5 AV			3.84 V	357	57.9	39.6
7	#5725.00	58.6 PK	74.0	-15.4	3.15 V	322	56.6	2.0
8	#5725.00	47.0 AV	54.0	-7.0	3.15 V	322	45.0	2.0
9	11220.00	60.3 PK	74.0	-13.7	2.88 V	346	45.2	15.1
10	11220.00	46.7 AV	54.0	-7.3	2.88 V	346	31.6	15.1

Remarks:

1. Emission Level(dBuV/m) = Raw Value(dBuV) + Correction Factor(dB/m)
2. Correction Factor(dB/m) = Antenna Factor(dB/m) + Cable Factor(dB) – Pre-Amplifier Factor(dB)
3. The other emission levels were very low against the limit.
4. Margin value = Emission Level – Limit value
5. " * ": Fundamental frequency.
6. " # ": The radiated frequency is out of the restricted band.

CHANNEL	TX Channel 138	DETECTOR FUNCTION	Peak (PK)
FREQUENCY RANGE	1GHz ~ 40GHz		Average (AV)

ANTENNA POLARITY & TEST DISTANCE: HORIZONTAL AT 3 M								
NO.	FREQ. (MHz)	EMISSION LEVEL (dBuV/m)	LIMIT (dBuV/m)	MARGIN (dB)	ANTENNA HEIGHT (m)	TABLE ANGLE (Degree)	RAW VALUE (dBuV)	CORRECTION FACTOR (dB/m)
1	#5470.00	55.4 PK	74.0	-18.6	1.69 H	44	54.2	1.2
2	#5470.00	43.6 AV	54.0	-10.4	1.69 H	44	42.4	1.2
3	*5690.00	111.0 PK			1.54 H	45	71.2	39.8
4	*5690.00	101.0 AV			1.54 H	45	61.2	39.8
5	#5825.00	62.7 PK	74.0	-11.3	2.14 H	38	60.5	2.2
6	#5825.00	49.4 AV	54.0	-4.6	2.14 H	38	47.2	2.2
7	11380.00	59.8 PK	74.0	-14.2	1.68 H	73	45.3	14.5
8	11380.00	47.1 AV	54.0	-6.9	1.68 H	73	32.6	14.5

ANTENNA POLARITY & TEST DISTANCE: VERTICAL AT 3 M								
NO.	FREQ. (MHz)	EMISSION LEVEL (dBuV/m)	LIMIT (dBuV/m)	MARGIN (dB)	ANTENNA HEIGHT (m)	TABLE ANGLE (Degree)	RAW VALUE (dBuV)	CORRECTION FACTOR (dB/m)
1	#5470.00	54.8 PK	74.0	-19.2	2.89 V	307	53.6	1.2
2	#5470.00	42.5 AV	54.0	-11.5	2.89 V	307	41.3	1.2
3	*5690.00	107.1 PK			3.71 V	354	67.3	39.8
4	*5690.00	96.1 AV			3.71 V	354	56.3	39.8
5	#5825.00	57.1 PK	74.0	-16.9	3.45 V	327	54.9	2.2
6	#5825.00	45.2 AV	54.0	-8.8	3.45 V	327	43.0	2.2
7	11380.00	60.0 PK	74.0	-14.0	3.32 V	305	45.5	14.5
8	11380.00	46.4 AV	54.0	-7.6	3.32 V	305	31.9	14.5

Remarks:

1. Emission Level(dBuV/m) = Raw Value(dBuV) + Correction Factor(dB/m)
2. Correction Factor(dB/m) = Antenna Factor(dB/m) + Cable Factor(dB) – Pre-Amplifier Factor(dB)
3. The other emission levels were very low against the limit.
4. Margin value = Emission Level – Limit value
5. " * ": Fundamental frequency.
6. " # ": The radiated frequency is out of the restricted band.

Below 1GHz Worst-Case Data: 802.11a

CHANNEL	TX Channel 52	DETECTOR FUNCTION	Quasi-Peak (QP)
FREQUENCY RANGE	9kHz ~ 1GHz		
TEST MODE	A		

ANTENNA POLARITY & TEST DISTANCE: HORIZONTAL AT 3 M

NO.	FREQ. (MHz)	EMISSION LEVEL (dBuV/m)	LIMIT (dBuV/m)	MARGIN (dB)	ANTENNA HEIGHT (m)	TABLE ANGLE (Degree)	RAW VALUE (dBuV)	CORRECTION FACTOR (dB/m)
1	76.56	25.5 QP	40.0	-14.5	1.99 H	237	43.2	-17.7
2	152.39	29.3 QP	43.5	-14.2	1.00 H	246	43.1	-13.8
3	199.05	26.7 QP	43.5	-16.8	1.00 H	225	42.9	-16.2
4	407.09	34.4 QP	46.0	-11.6	1.50 H	209	44.3	-9.9
5	531.53	35.9 QP	46.0	-10.1	1.50 H	135	43.2	-7.3
6	937.88	34.0 QP	46.0	-12.0	1.50 H	12	32.9	1.1

ANTENNA POLARITY & TEST DISTANCE: VERTICAL AT 3 M

NO.	FREQ. (MHz)	EMISSION LEVEL (dBuV/m)	LIMIT (dBuV/m)	MARGIN (dB)	ANTENNA HEIGHT (m)	TABLE ANGLE (Degree)	RAW VALUE (dBuV)	CORRECTION FACTOR (dB/m)
1	49.34	34.0 QP	40.0	-6.0	1.50 V	76	48.3	-14.3
2	115.45	29.9 QP	43.5	-13.6	1.01 V	290	46.6	-16.7
3	201.00	26.9 QP	43.5	-16.6	1.01 V	91	43.2	-16.3
4	393.48	34.9 QP	46.0	-11.1	1.01 V	139	45.1	-10.2
5	490.70	36.2 QP	46.0	-9.8	1.01 V	134	44.4	-8.2
6	895.11	32.3 QP	46.0	-13.7	1.50 V	150	32.3	0.0

Remarks:

1. Emission Level(dBuV/m) = Raw Value(dBuV) + Correction Factor(dB/m)
2. Correction Factor(dB/m) = Antenna Factor(dB/m) + Cable Factor(dB) – Pre-Amplifier Factor(dB)
3. The other emission levels were very low against the limit.
4. Margin value = Emission Level – Limit value

CHANNEL	TX Channel 52	DETECTOR FUNCTION	Quasi-Peak (QP)
FREQUENCY RANGE	9kHz ~ 1GHz		
TEST MODE	B		

ANTENNA POLARITY & TEST DISTANCE: HORIZONTAL AT 3 M

NO.	FREQ. (MHz)	EMISSION LEVEL (dBuV/m)	LIMIT (dBuV/m)	MARGIN (dB)	ANTENNA HEIGHT (m)	TABLE ANGLE (Degree)	RAW VALUE (dBuV)	CORRECTION FACTOR (dB/m)
1	37.68	24.2 QP	40.0	-15.8	2.00 H	75	39.6	-15.4
2	70.73	28.2 QP	40.0	-11.8	2.00 H	227	44.6	-16.4
3	103.78	27.8 QP	43.5	-15.7	2.00 H	91	45.8	-18.0
4	154.33	26.5 QP	43.5	-17.0	2.00 H	236	40.2	-13.7
5	405.15	32.2 QP	46.0	-13.8	2.00 H	205	42.3	-10.1
6	502.36	34.4 QP	46.0	-11.6	1.51 H	128	42.1	-7.7

ANTENNA POLARITY & TEST DISTANCE: VERTICAL AT 3 M

NO.	FREQ. (MHz)	EMISSION LEVEL (dBuV/m)	LIMIT (dBuV/m)	MARGIN (dB)	ANTENNA HEIGHT (m)	TABLE ANGLE (Degree)	RAW VALUE (dBuV)	CORRECTION FACTOR (dB/m)
1	37.68	38.0 QP	40.0	-2.0	1.00 V	157	53.4	-15.4
2	66.84	36.3 QP	40.0	-3.7	1.00 V	30	52.2	-15.9
3	302.10	27.4 QP	46.0	-18.6	1.50 V	25	39.4	-12.0
4	412.92	34.2 QP	46.0	-11.8	1.00 V	133	44.1	-9.9
5	500.42	35.2 QP	46.0	-10.8	1.00 V	195	43.1	-7.9
6	897.05	40.1 QP	46.0	-5.9	1.99 V	177	40.0	0.1

Remarks:

1. Emission Level(dBuV/m) = Raw Value(dBuV) + Correction Factor(dB/m)
2. Correction Factor(dB/m) = Antenna Factor(dB/m) + Cable Factor(dB) – Pre-Amplifier Factor(dB)
3. The other emission levels were very low against the limit.
4. Margin value = Emission Level – Limit value

CHANNEL	TX Channel 52	DETECTOR FUNCTION	Quasi-Peak (QP)
FREQUENCY RANGE	9kHz ~ 1GHz		
TEST MODE	C		

ANTENNA POLARITY & TEST DISTANCE: HORIZONTAL AT 3 M

NO.	FREQ. (MHz)	EMISSION LEVEL (dBuV/m)	LIMIT (dBuV/m)	MARGIN (dB)	ANTENNA HEIGHT (m)	TABLE ANGLE (Degree)	RAW VALUE (dBuV)	CORRECTION FACTOR (dB/m)
1	57.12	27.9 QP	40.0	-12.1	2.00 H	42	42.5	-14.6
2	210.72	29.2 QP	43.5	-14.3	1.01 H	109	45.3	-16.1
3	309.88	30.6 QP	46.0	-15.4	1.01 H	242	42.4	-11.8
4	465.42	34.3 QP	46.0	-11.7	1.51 H	198	42.8	-8.5
5	700.68	39.3 QP	46.0	-6.7	1.51 H	139	42.9	-3.6
6	935.94	34.6 QP	46.0	-11.4	1.51 H	226	33.7	0.9

ANTENNA POLARITY & TEST DISTANCE: VERTICAL AT 3 M

NO.	FREQ. (MHz)	EMISSION LEVEL (dBuV/m)	LIMIT (dBuV/m)	MARGIN (dB)	ANTENNA HEIGHT (m)	TABLE ANGLE (Degree)	RAW VALUE (dBuV)	CORRECTION FACTOR (dB/m)
1	51.29	38.3 QP	40.0	-1.7	1.00 V	15	52.7	-14.4
2	66.84	37.6 QP	40.0	-2.4	1.00 V	32	53.5	-15.9
3	286.55	31.3 QP	46.0	-14.7	1.49 V	251	43.6	-12.3
4	467.36	35.1 QP	46.0	-10.9	1.00 V	169	43.5	-8.4
5	700.68	42.3 QP	46.0	-3.7	1.49 V	7	45.9	-3.6
6	935.94	31.7 QP	46.0	-14.3	1.00 V	68	30.8	0.9

Remarks:

1. Emission Level(dBuV/m) = Raw Value(dBuV) + Correction Factor(dB/m)
2. Correction Factor(dB/m) = Antenna Factor(dB/m) + Cable Factor(dB) – Pre-Amplifier Factor(dB)
3. The other emission levels were very low against the limit.
4. Margin value = Emission Level – Limit value

CHANNEL	TX Channel 52	DETECTOR FUNCTION	Quasi-Peak (QP)
FREQUENCY RANGE	9kHz ~ 1GHz		
TEST MODE	D		

ANTENNA POLARITY & TEST DISTANCE: HORIZONTAL AT 3 M

NO.	FREQ. (MHz)	EMISSION LEVEL (dBuV/m)	LIMIT (dBuV/m)	MARGIN (dB)	ANTENNA HEIGHT (m)	TABLE ANGLE (Degree)	RAW VALUE (dBuV)	CORRECTION FACTOR (dB/m)
1	57.12	28.4 QP	40.0	-11.6	2.00 H	270	43.0	-14.6
2	90.17	36.2 QP	43.5	-7.3	2.00 H	224	55.9	-19.7
3	169.89	29.3 QP	43.5	-14.2	2.00 H	182	43.2	-13.9
4	249.60	21.5 QP	46.0	-24.5	1.01 H	222	35.5	-14.0
5	525.69	25.5 QP	46.0	-20.5	1.51 H	121	32.8	-7.3
6	937.88	32.9 QP	46.0	-13.1	2.00 H	7	31.8	1.1

ANTENNA POLARITY & TEST DISTANCE: VERTICAL AT 3 M

NO.	FREQ. (MHz)	EMISSION LEVEL (dBuV/m)	LIMIT (dBuV/m)	MARGIN (dB)	ANTENNA HEIGHT (m)	TABLE ANGLE (Degree)	RAW VALUE (dBuV)	CORRECTION FACTOR (dB/m)
1	38.01	35.0 QP	40.0	-5.0	1.02 V	98	50.3	-15.3
2	125.17	32.8 QP	43.5	-10.7	1.00 V	136	48.6	-15.8
3	156.28	30.7 QP	43.5	-12.8	1.00 V	118	44.4	-13.7
4	249.60	24.3 QP	46.0	-21.7	1.49 V	192	38.3	-14.0
5	339.04	23.5 QP	46.0	-22.5	1.00 V	204	34.7	-11.2
6	939.83	34.2 QP	46.0	-11.8	1.00 V	70	33.1	1.1

Remarks:

1. Emission Level(dBuV/m) = Raw Value(dBuV) + Correction Factor(dB/m)
2. Correction Factor(dB/m) = Antenna Factor(dB/m) + Cable Factor(dB) – Pre-Amplifier Factor(dB)
3. The other emission levels were very low against the limit.
4. Margin value = Emission Level – Limit value

CHANNEL	TX Channel 52	DETECTOR FUNCTION	Quasi-Peak (QP)
FREQUENCY RANGE	9kHz ~ 1GHz		
TEST MODE	F		

ANTENNA POLARITY & TEST DISTANCE: HORIZONTAL AT 3 M

NO.	FREQ. (MHz)	EMISSION LEVEL (dBuV/m)	LIMIT (dBuV/m)	MARGIN (dB)	ANTENNA HEIGHT (m)	TABLE ANGLE (Degree)	RAW VALUE (dBuV)	CORRECTION FACTOR (dB/m)
1	57.12	27.9 QP	40.0	-12.1	2.00 H	248	42.5	-14.6
2	101.84	28.4 QP	43.5	-15.1	2.00 H	83	46.6	-18.2
3	154.33	30.0 QP	43.5	-13.5	2.00 H	47	43.7	-13.7
4	208.77	31.1 QP	43.5	-12.4	1.00 H	278	47.3	-16.2
5	502.36	32.6 QP	46.0	-13.4	2.00 H	22	40.3	-7.7
6	910.66	39.4 QP	46.0	-6.6	1.50 H	7	38.8	0.6

ANTENNA POLARITY & TEST DISTANCE: VERTICAL AT 3 M

NO.	FREQ. (MHz)	EMISSION LEVEL (dBuV/m)	LIMIT (dBuV/m)	MARGIN (dB)	ANTENNA HEIGHT (m)	TABLE ANGLE (Degree)	RAW VALUE (dBuV)	CORRECTION FACTOR (dB/m)
1	37.68	37.6 QP	40.0	-2.4	1.00 V	132	53.0	-15.4
2	107.67	31.0 QP	43.5	-12.5	1.00 V	71	48.5	-17.5
3	206.83	31.1 QP	43.5	-12.4	1.00 V	12	47.4	-16.3
4	393.48	34.1 QP	46.0	-11.9	1.00 V	138	44.3	-10.2
5	502.36	37.6 QP	46.0	-8.4	1.00 V	170	45.3	-7.7
6	543.19	35.5 QP	46.0	-10.5	1.50 V	144	42.6	-7.1

Remarks:

1. Emission Level(dBuV/m) = Raw Value(dBuV) + Correction Factor(dB/m)
2. Correction Factor(dB/m) = Antenna Factor(dB/m) + Cable Factor(dB) – Pre-Amplifier Factor(dB)
3. The other emission levels were very low against the limit.
4. Margin value = Emission Level – Limit value

CHANNEL	TX Channel 52	DETECTOR FUNCTION	Quasi-Peak (QP)
FREQUENCY RANGE	9kHz ~ 1GHz		
TEST MODE	G		

ANTENNA POLARITY & TEST DISTANCE: HORIZONTAL AT 3 M

NO.	FREQ. (MHz)	EMISSION LEVEL (dBuV/m)	LIMIT (dBuV/m)	MARGIN (dB)	ANTENNA HEIGHT (m)	TABLE ANGLE (Degree)	RAW VALUE (dBuV)	CORRECTION FACTOR (dB/m)
1	57.12	27.8 QP	40.0	-12.2	2.00 H	56	42.4	-14.6
2	78.51	30.4 QP	40.0	-9.6	2.00 H	225	48.7	-18.3
3	154.33	29.8 QP	43.5	-13.7	1.00 H	199	43.5	-13.7
4	204.89	27.6 QP	43.5	-15.9	2.00 H	134	44.0	-16.4
5	504.31	30.6 QP	46.0	-15.4	2.00 H	19	38.3	-7.7
6	914.55	35.1 QP	46.0	-10.9	1.50 H	15	34.3	0.8

ANTENNA POLARITY & TEST DISTANCE: VERTICAL AT 3 M

NO.	FREQ. (MHz)	EMISSION LEVEL (dBuV/m)	LIMIT (dBuV/m)	MARGIN (dB)	ANTENNA HEIGHT (m)	TABLE ANGLE (Degree)	RAW VALUE (dBuV)	CORRECTION FACTOR (dB/m)
1	35.73	38.0 QP	40.0	-2.0	1.00 V	181	53.9	-15.9
2	64.90	34.0 QP	40.0	-6.0	1.00 V	10	49.5	-15.5
3	101.84	31.7 QP	43.5	-11.8	1.00 V	62	49.9	-18.2
4	134.89	28.0 QP	43.5	-15.5	1.00 V	114	42.8	-14.8
5	397.37	34.0 QP	46.0	-12.0	1.00 V	136	44.2	-10.2
6	504.31	35.5 QP	46.0	-10.5	2.00 V	179	43.2	-7.7

Remarks:

1. Emission Level(dBuV/m) = Raw Value(dBuV) + Correction Factor(dB/m)
2. Correction Factor(dB/m) = Antenna Factor(dB/m) + Cable Factor(dB) – Pre-Amplifier Factor(dB)
3. The other emission levels were very low against the limit.
4. Margin value = Emission Level – Limit value

CHANNEL	TX Channel 52	DETECTOR FUNCTION	Quasi-Peak (QP)
FREQUENCY RANGE	9kHz ~ 1GHz		
TEST MODE	H		

ANTENNA POLARITY & TEST DISTANCE: HORIZONTAL AT 3 M

NO.	FREQ. (MHz)	EMISSION LEVEL (dBuV/m)	LIMIT (dBuV/m)	MARGIN (dB)	ANTENNA HEIGHT (m)	TABLE ANGLE (Degree)	RAW VALUE (dBuV)	CORRECTION FACTOR (dB/m)
1	57.12	27.6 QP	40.0	-12.4	2.00 H	250	42.2	-14.6
2	101.84	28.4 QP	43.5	-15.1	2.00 H	258	46.6	-18.2
3	154.33	29.3 QP	43.5	-14.2	2.00 H	50	43.0	-13.7
4	206.83	32.5 QP	43.5	-11.0	1.00 H	270	48.8	-16.3
5	389.59	26.7 QP	46.0	-19.3	2.00 H	277	36.9	-10.2
6	504.31	32.3 QP	46.0	-13.7	1.50 H	19	40.0	-7.7

ANTENNA POLARITY & TEST DISTANCE: VERTICAL AT 3 M

NO.	FREQ. (MHz)	EMISSION LEVEL (dBuV/m)	LIMIT (dBuV/m)	MARGIN (dB)	ANTENNA HEIGHT (m)	TABLE ANGLE (Degree)	RAW VALUE (dBuV)	CORRECTION FACTOR (dB/m)
1	41.57	36.8 QP	40.0	-3.2	1.00 V	231	51.8	-15.0
2	107.67	30.7 QP	43.5	-12.8	1.00 V	256	48.2	-17.5
3	150.45	31.0 QP	43.5	-12.5	1.00 V	271	44.9	-13.9
4	393.48	32.8 QP	46.0	-13.2	1.00 V	147	43.0	-10.2
5	502.36	38.9 QP	46.0	-7.1	1.00 V	191	46.6	-7.7
6	541.25	36.6 QP	46.0	-9.4	1.50 V	153	43.7	-7.1

Remarks:

1. Emission Level(dBuV/m) = Raw Value(dBuV) + Correction Factor(dB/m)
2. Correction Factor(dB/m) = Antenna Factor(dB/m) + Cable Factor(dB) – Pre-Amplifier Factor(dB)
3. The other emission levels were very low against the limit.
4. Margin value = Emission Level – Limit value

CHANNEL	TX Channel 52	DETECTOR FUNCTION	Quasi-Peak (QP)
FREQUENCY RANGE	9kHz ~ 1GHz		
TEST MODE	I		

ANTENNA POLARITY & TEST DISTANCE: HORIZONTAL AT 3 M

NO.	FREQ. (MHz)	EMISSION LEVEL (dBuV/m)	LIMIT (dBuV/m)	MARGIN (dB)	ANTENNA HEIGHT (m)	TABLE ANGLE (Degree)	RAW VALUE (dBuV)	CORRECTION FACTOR (dB/m)
1	78.51	31.0 QP	40.0	-9.0	2.00 H	247	49.3	-18.3
2	154.33	31.2 QP	43.5	-12.3	1.51 H	37	44.9	-13.7
3	206.83	27.4 QP	43.5	-16.1	1.00 H	128	43.7	-16.3
4	395.43	28.0 QP	46.0	-18.0	1.00 H	241	38.1	-10.1
5	519.86	30.5 QP	46.0	-15.5	1.51 H	129	37.9	-7.4
6	935.94	33.6 QP	46.0	-12.4	2.00 H	123	32.7	0.9

ANTENNA POLARITY & TEST DISTANCE: VERTICAL AT 3 M

NO.	FREQ. (MHz)	EMISSION LEVEL (dBuV/m)	LIMIT (dBuV/m)	MARGIN (dB)	ANTENNA HEIGHT (m)	TABLE ANGLE (Degree)	RAW VALUE (dBuV)	CORRECTION FACTOR (dB/m)
1	37.68	36.9 QP	40.0	-3.1	1.00 V	322	52.3	-15.4
2	103.78	31.9 QP	43.5	-11.6	1.00 V	73	49.9	-18.0
3	154.33	29.0 QP	43.5	-14.5	1.00 V	225	42.7	-13.7
4	395.43	34.9 QP	46.0	-11.1	1.49 V	128	45.0	-10.1
5	504.31	35.1 QP	46.0	-10.9	1.00 V	173	42.8	-7.7
6	912.61	36.8 QP	46.0	-9.2	1.49 V	5	36.1	0.7

Remarks:

1. Emission Level(dBuV/m) = Raw Value(dBuV) + Correction Factor(dB/m)
2. Correction Factor(dB/m) = Antenna Factor(dB/m) + Cable Factor(dB) – Pre-Amplifier Factor(dB)
3. The other emission levels were very low against the limit.
4. Margin value = Emission Level – Limit value

CHANNEL	TX Channel 52	DETECTOR FUNCTION	Quasi-Peak (QP)
FREQUENCY RANGE	9kHz ~ 1GHz		
TEST MODE	J		

ANTENNA POLARITY & TEST DISTANCE: HORIZONTAL AT 3 M

NO.	FREQ. (MHz)	EMISSION LEVEL (dBuV/m)	LIMIT (dBuV/m)	MARGIN (dB)	ANTENNA HEIGHT (m)	TABLE ANGLE (Degree)	RAW VALUE (dBuV)	CORRECTION FACTOR (dB/m)
1	57.12	27.7 QP	40.0	-12.3	2.00 H	70	42.3	-14.6
2	101.84	26.9 QP	43.5	-16.6	2.00 H	227	45.1	-18.2
3	154.33	30.3 QP	43.5	-13.2	2.00 H	40	44.0	-13.7
4	206.83	32.0 QP	43.5	-11.5	1.00 H	253	48.3	-16.3
5	502.36	32.9 QP	46.0	-13.1	2.00 H	10	40.6	-7.7
6	747.34	32.2 QP	46.0	-13.8	1.50 H	135	34.5	-2.3

ANTENNA POLARITY & TEST DISTANCE: VERTICAL AT 3 M

NO.	FREQ. (MHz)	EMISSION LEVEL (dBuV/m)	LIMIT (dBuV/m)	MARGIN (dB)	ANTENNA HEIGHT (m)	TABLE ANGLE (Degree)	RAW VALUE (dBuV)	CORRECTION FACTOR (dB/m)
1	39.62	36.5 QP	40.0	-3.5	1.00 V	130	51.7	-15.2
2	109.62	31.5 QP	43.5	-12.0	1.00 V	154	48.8	-17.3
3	197.11	31.2 QP	43.5	-12.3	1.00 V	18	47.4	-16.2
4	393.48	32.1 QP	46.0	-13.9	1.00 V	148	42.3	-10.2
5	502.36	36.6 QP	46.0	-9.4	1.00 V	188	44.3	-7.7
6	543.19	36.0 QP	46.0	-10.0	1.00 V	153	43.1	-7.1

Remarks:

1. Emission Level(dBuV/m) = Raw Value(dBuV) + Correction Factor(dB/m)
2. Correction Factor(dB/m) = Antenna Factor(dB/m) + Cable Factor(dB) – Pre-Amplifier Factor(dB)
3. The other emission levels were very low against the limit.
4. Margin value = Emission Level – Limit value

CHANNEL	TX Channel 52	DETECTOR FUNCTION	Quasi-Peak (QP)
FREQUENCY RANGE	9kHz ~ 1GHz		
TEST MODE	K		

ANTENNA POLARITY & TEST DISTANCE: HORIZONTAL AT 3 M

NO.	FREQ. (MHz)	EMISSION LEVEL (dBuV/m)	LIMIT (dBuV/m)	MARGIN (dB)	ANTENNA HEIGHT (m)	TABLE ANGLE (Degree)	RAW VALUE (dBuV)	CORRECTION FACTOR (dB/m)
1	57.12	28.3 QP	40.0	-11.7	2.00 H	91	42.9	-14.6
2	78.51	30.4 QP	40.0	-9.6	2.00 H	223	48.7	-18.3
3	154.33	30.9 QP	43.5	-12.6	2.00 H	31	44.6	-13.7
4	204.89	27.2 QP	43.5	-16.3	1.00 H	122	43.6	-16.4
5	504.31	30.5 QP	46.0	-15.5	2.00 H	10	38.2	-7.7
6	914.55	40.0 QP	46.0	-6.0	1.50 H	14	39.2	0.8

ANTENNA POLARITY & TEST DISTANCE: VERTICAL AT 3 M

NO.	FREQ. (MHz)	EMISSION LEVEL (dBuV/m)	LIMIT (dBuV/m)	MARGIN (dB)	ANTENNA HEIGHT (m)	TABLE ANGLE (Degree)	RAW VALUE (dBuV)	CORRECTION FACTOR (dB/m)
1	45.45	37.6 QP	40.0	-2.4	1.00 V	317	52.3	-14.7
2	64.90	34.3 QP	40.0	-5.7	1.00 V	11	49.8	-15.5
3	101.84	31.5 QP	43.5	-12.0	1.00 V	75	49.7	-18.2
4	132.95	28.0 QP	43.5	-15.5	1.00 V	133	43.0	-15.0
5	397.37	34.1 QP	46.0	-11.9	1.00 V	134	44.3	-10.2
6	514.03	34.2 QP	46.0	-11.8	1.50 V	187	41.6	-7.4

Remarks:

1. Emission Level(dBuV/m) = Raw Value(dBuV) + Correction Factor(dB/m)
2. Correction Factor(dB/m) = Antenna Factor(dB/m) + Cable Factor(dB) – Pre-Amplifier Factor(dB)
3. The other emission levels were very low against the limit.
4. Margin value = Emission Level – Limit value

4.2 Conducted Emission Measurement

4.2.1 Limits of Conducted Emission Measurement

Frequency (MHz)	Conducted Limit (dBuV)	
	Quasi-peak	Average
0.15 - 0.5	66 - 56	56 - 46
0.50 - 5.0	56	46
5.0 - 30.0	60	50

Note: 1. The lower limit shall apply at the transition frequencies.

2. The limit decreases in line with the logarithm of the frequency in the range of 0.15 to 0.50MHz.

4.2.2 Test Instruments

Description & Manufacturer	Model No.	Serial No.	Cal. Date	Cal. Due
Test Receiver ROHDE & SCHWARZ	ESCI	100613	Nov. 21, 2016	Nov. 20, 2017
RF signal cable (with 10dB PAD) Woken	5D-FB	Cable-cond1-01	Dec. 22, 2016	Dec. 21, 2017
LISN ROHDE & SCHWARZ (EUT)	ESH3-Z5	835239/001	Mar. 10, 2017	Mar. 09, 2018
LISN ROHDE & SCHWARZ (Peripheral)	ESH3-Z5	100311	Jul. 28, 2016	Jul. 27, 2017
			Jul. 28, 2017	Jul. 27, 2018
Software ADT	BV ADT_Cond_ V7.3.7.3	NA	NA	NA

Note: 1. The calibration interval of the above test instruments is 12 months and the calibrations are traceable to NML/ROC and NIST/USA.

2. The test was performed in HwaYa Shielded Room 1.

3. The VCCI Site Registration No. is C-2040.

4.2.3 Test Procedures

- The EUT was placed 0.4 meters from the conducting wall of the shielded room with EUT being connected to the power mains through a line impedance stabilization network (LISN). Other support units were connected to the power mains through another LISN. The two LISNs provide 50 ohm/ 50uH of coupling impedance for the measuring instrument.
- Both lines of the power mains connected to the EUT were checked for maximum conducted interference.
- The frequency range from 150kHz to 30MHz was searched. Emission levels under (Limit - 20dB) was not recorded.

NOTE: The resolution bandwidth and video bandwidth of test receiver is 9kHz for quasi-peak detection (QP) and average detection (AV) at frequency 0.15MHz-30MHz.

4.2.4 Deviation from Test Standard

No deviation.

4.2.5 Test Setup

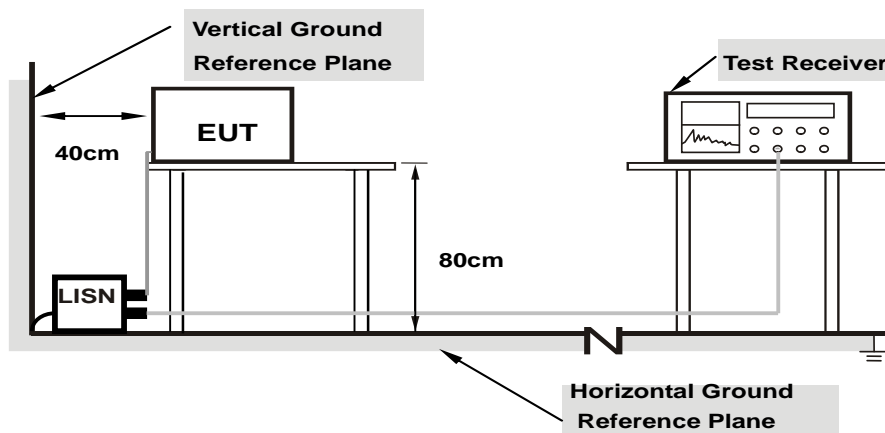

Note: 1.Support units were connected to second LISN.

For the actual test configuration, please refer to the attached file (Test Setup Photo).

4.2.6 EUT Operating Conditions

Same as 4.1.6.

4.2.7 Test Results

Worst-case data: 802.11a

Phase	Line (L)	Detector Function	Quasi-Peak (QP) / Average (AV)
Test Mode	A		

No	Freq. [MHz]	Corr. Factor (dB)	Reading Value		Emission Level		Limit		Margin	
			[dB (uV)]		[dB (uV)]		[dB (uV)]		(dB)	
			Q.P.	AV.	Q.P.	AV.	Q.P.	AV.	Q.P.	AV.
1	0.16200	10.41	37.85	25.14	48.26	35.55	65.36	55.36	-17.10	-19.81
2	0.18666	10.42	34.93	23.45	45.35	33.87	64.18	54.18	-18.83	-20.31
3	0.22985	10.44	26.85	13.75	37.29	24.19	62.46	52.46	-25.17	-28.27
4	0.34124	10.49	33.74	31.51	44.23	42.00	59.17	49.17	-14.94	-7.17
5	0.35876	10.49	33.52	27.87	44.01	38.36	58.76	48.76	-14.75	-10.40
6	7.47400	10.80	25.18	18.85	35.98	29.65	60.00	50.00	-24.02	-20.35

Remarks:

1. Q.P. and AV. are abbreviations of quasi-peak and average individually.
2. The emission levels of other frequencies were very low against the limit.
3. Margin value = Emission level - Limit value
4. Correction factor = Insertion loss + Cable loss
5. Emission Level = Correction Factor + Reading Value.

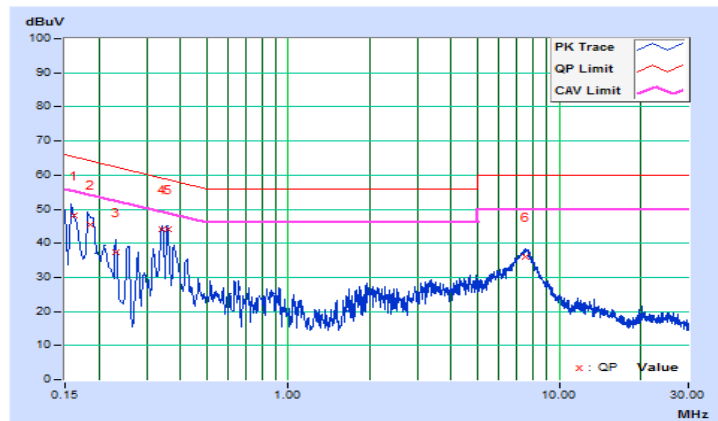

Phase	Neutral (N)	Detector Function	Quasi-Peak (QP) / Average (AV)
Test Mode	A		

No	Freq. [MHz]	Corr. Factor (dB)	Reading Value [dB (uV)]		Emission Level [dB (uV)]		Limit [dB (uV)]		Margin (dB)	
			Q.P.	AV.	Q.P.	AV.	Q.P.	AV.	Q.P.	AV.
			1	0.15687	10.16	36.63	21.65	46.79	31.81	65.63
2	0.18200	10.18	34.00	17.71	44.18	27.89	64.39	54.39	-20.21	-26.50
3	0.20200	10.20	28.86	14.14	39.06	24.34	63.53	53.53	-24.47	-29.19
4	0.35876	10.22	28.01	20.47	38.23	30.69	58.76	48.76	-20.53	-18.07
5	4.49400	10.44	17.68	8.38	28.12	18.82	56.00	46.00	-27.88	-27.18
6	7.56200	10.55	26.47	20.21	37.02	30.76	60.00	50.00	-22.98	-19.24

Remarks:

1. Q.P. and AV. are abbreviations of quasi-peak and average individually.
2. The emission levels of other frequencies were very low against the limit.
3. Margin value = Emission level - Limit value
4. Correction factor = Insertion loss + Cable loss
5. Emission Level = Correction Factor + Reading Value.

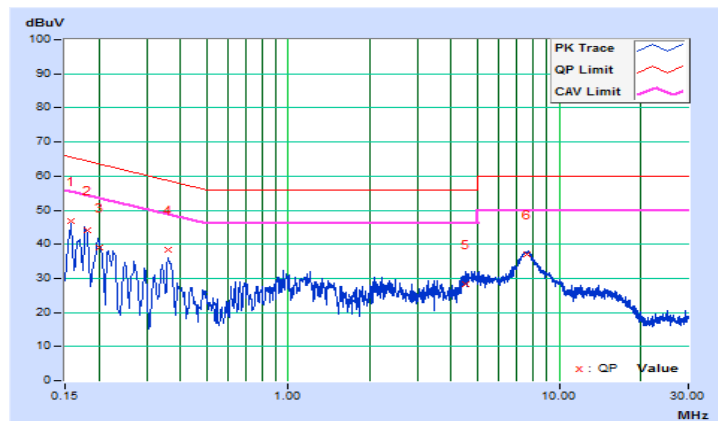

Phase	Line (L)	Detector Function	Quasi-Peak (QP) / Average (AV)
Test Mode	B		

No	Freq. [MHz]	Corr. Factor (dB)	Reading Value [dB (uV)]		Emission Level [dB (uV)]		Limit [dB (uV)]		Margin (dB)	
			Q.P.	AV.	Q.P.	AV.	Q.P.	AV.	Q.P.	AV.
			1	0.15687	10.41	37.88	24.85	48.29	35.26	65.63
2	0.18037	10.42	33.51	21.16	43.93	31.58	64.47	54.47	-20.54	-22.89
3	0.47185	10.50	35.17	30.88	45.67	41.38	56.48	46.48	-10.81	-5.10
4	0.94097	10.46	23.89	20.40	34.35	30.86	56.00	46.00	-21.65	-15.14
5	1.75400	10.51	24.11	20.06	34.62	30.57	56.00	46.00	-21.38	-15.43
6	12.25800	11.02	20.89	15.64	31.91	26.66	60.00	50.00	-28.09	-23.34

Remarks:

1. Q.P. and AV. are abbreviations of quasi-peak and average individually.
2. The emission levels of other frequencies were very low against the limit.
3. Margin value = Emission level - Limit value
4. Correction factor = Insertion loss + Cable loss
5. Emission Level = Correction Factor + Reading Value.

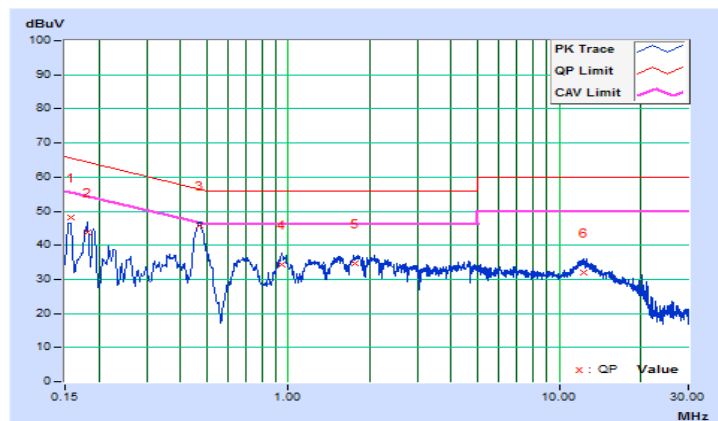

Phase	Neutral (N)	Detector Function	Quasi-Peak (QP) / Average (AV)
Test Mode	B		

No	Freq. [MHz]	Corr. Factor (dB)	Reading Value [dB (uV)]		Emission Level [dB (uV)]		Limit [dB (uV)]		Margin (dB)	
			Q.P.	AV.	Q.P.	AV.	Q.P.	AV.	Q.P.	AV.
			1	0.15400	10.16	38.10	24.32	48.26	34.48	65.78
2	0.18200	10.18	33.02	19.61	43.20	29.79	64.39	54.39	-21.19	-24.60
3	0.20600	10.20	28.76	13.96	38.96	24.16	63.37	53.37	-24.41	-29.21
4	0.47434	10.23	35.20	30.58	45.43	40.81	56.44	46.44	-11.01	-5.63
5	0.94594	10.24	23.53	20.29	33.77	30.53	56.00	46.00	-22.23	-15.47
6	13.39800	10.78	17.86	12.70	28.64	23.48	60.00	50.00	-31.36	-26.52

Remarks:

1. Q.P. and AV. are abbreviations of quasi-peak and average individually.
2. The emission levels of other frequencies were very low against the limit.
3. Margin value = Emission level - Limit value
4. Correction factor = Insertion loss + Cable loss
5. Emission Level = Correction Factor + Reading Value.

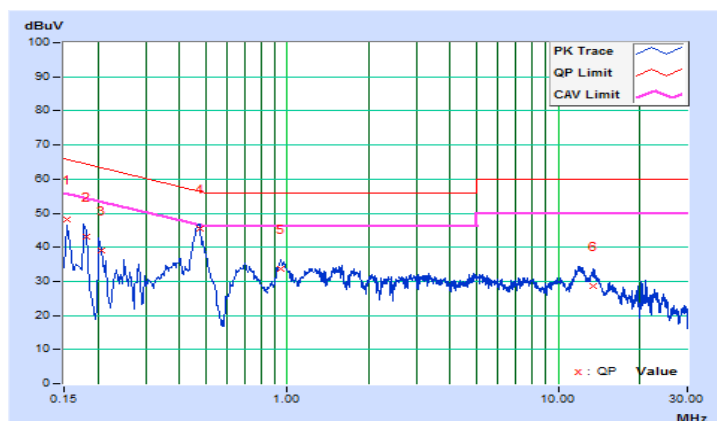

Phase	Line (L)	Detector Function	Quasi-Peak (QP) / Average (AV)
Test Mode	C		

No	Freq. [MHz]	Corr. Factor (dB)	Reading Value [dB (uV)]		Emission Level [dB (uV)]		Limit [dB (uV)]		Margin (dB)	
			Q.P.	AV.	Q.P.	AV.	Q.P.	AV.	Q.P.	AV.
			1	0.17615	10.42	36.93	25.95	47.35	36.37	64.67
2	0.21294	10.44	33.20	18.90	43.64	29.34	63.09	53.09	-19.45	-23.75
3	0.22152	10.44	32.89	18.95	43.33	29.39	62.76	52.76	-19.43	-23.37
4	0.35876	10.49	33.19	24.30	43.68	34.79	58.76	48.76	-15.08	-13.97
5	0.49216	10.50	16.55	8.99	27.05	19.49	56.13	46.13	-29.08	-26.64
6	7.65800	10.81	26.03	19.63	36.84	30.44	60.00	50.00	-23.16	-19.56

Remarks:

1. Q.P. and AV. are abbreviations of quasi-peak and average individually.
2. The emission levels of other frequencies were very low against the limit.
3. Margin value = Emission level - Limit value
4. Correction factor = Insertion loss + Cable loss
5. Emission Level = Correction Factor + Reading Value.

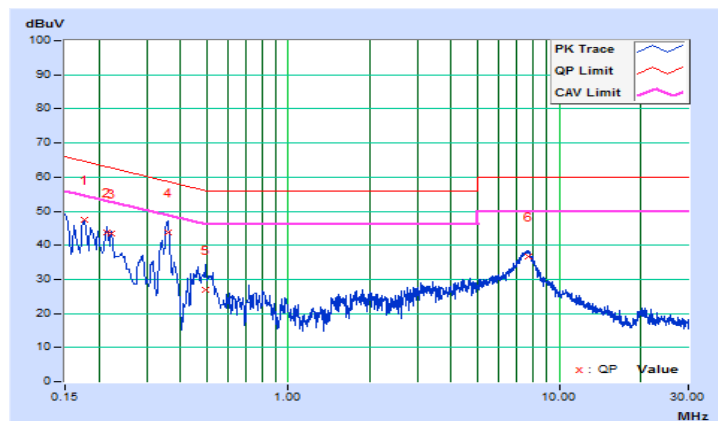

Phase	Neutral (N)	Detector Function	Quasi-Peak (QP) / Average (AV)
Test Mode	C		

No	Freq. [MHz]	Corr. Factor (dB)	Reading Value [dB (uV)]		Emission Level [dB (uV)]		Limit [dB (uV)]		Margin (dB)	
			Q.P.	AV.	Q.P.	AV.	Q.P.	AV.	Q.P.	AV.
			1	0.16105	10.16	39.71	22.89	49.87	33.05	65.41
2	0.18519	10.19	34.83	18.50	45.02	28.69	64.25	54.25	-19.23	-25.56
3	0.20523	10.20	32.43	15.50	42.63	25.70	63.40	53.40	-20.77	-27.70
4	0.25400	10.21	25.18	11.94	35.39	22.15	61.63	51.63	-26.24	-29.48
5	0.36352	10.22	28.07	21.56	38.29	31.78	58.65	48.65	-20.36	-16.87
6	7.56600	10.55	26.59	20.25	37.14	30.80	60.00	50.00	-22.86	-19.20

Remarks:

1. Q.P. and AV. are abbreviations of quasi-peak and average individually.
2. The emission levels of other frequencies were very low against the limit.
3. Margin value = Emission level - Limit value
4. Correction factor = Insertion loss + Cable loss
5. Emission Level = Correction Factor + Reading Value.

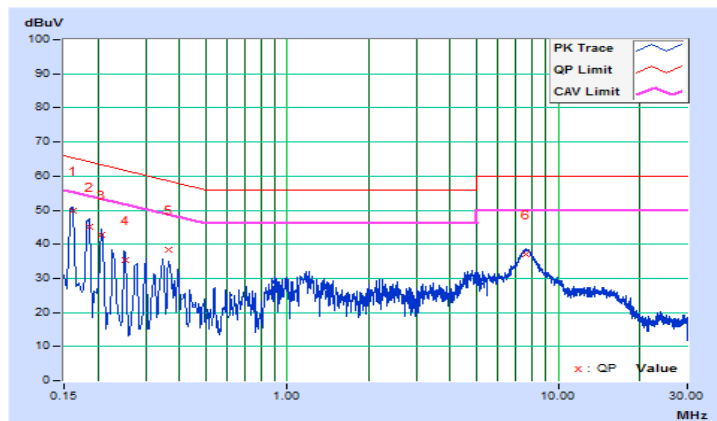

Phase	Line (L)	Detector Function	Quasi-Peak (QP) / Average (AV)
Test Mode	D		

No	Freq. [MHz]	Corr. Factor (dB)	Reading Value [dB (uV)]		Emission Level [dB (uV)]		Limit [dB (uV)]		Margin (dB)	
			Q.P.	AV.	Q.P.	AV.	Q.P.	AV.	Q.P.	AV.
			1	0.16932	10.41	33.94	20.99	44.35	31.40	64.99
2	0.19728	10.43	29.48	17.40	39.91	27.83	63.72	53.72	-23.81	-25.89
3	0.34486	10.49	24.33	17.92	34.82	28.41	59.09	49.09	-24.27	-20.68
4	0.47400	10.50	35.11	30.54	45.61	41.04	56.44	46.44	-10.83	-5.40
5	1.82291	10.51	24.22	19.69	34.73	30.20	56.00	46.00	-21.27	-15.80
6	12.09800	11.01	20.71	15.39	31.72	26.40	60.00	50.00	-28.28	-23.60

Remarks:

1. Q.P. and AV. are abbreviations of quasi-peak and average individually.
2. The emission levels of other frequencies were very low against the limit.
3. Margin value = Emission level - Limit value
4. Correction factor = Insertion loss + Cable loss
5. Emission Level = Correction Factor + Reading Value.

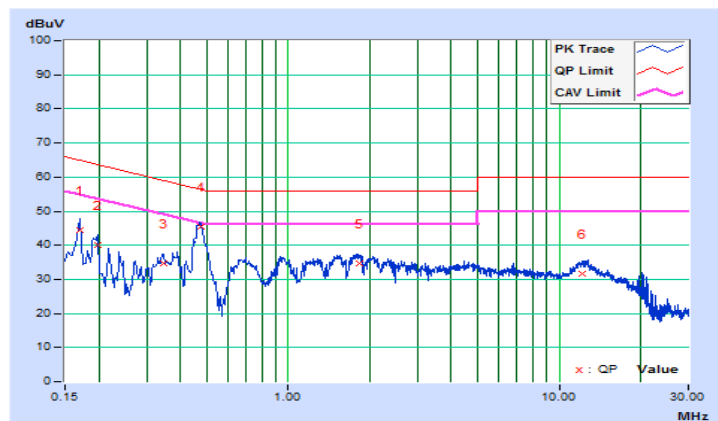

Phase	Neutral (N)	Detector Function	Quasi-Peak (QP) / Average (AV)
Test Mode	D		

No	Freq. [MHz]	Corr. Factor (dB)	Reading Value [dB (uV)]		Emission Level [dB (uV)]		Limit [dB (uV)]		Margin (dB)	
			Q.P.	AV.	Q.P.	AV.	Q.P.	AV.	Q.P.	AV.
			1	0.15687	10.16	36.87	23.17	47.03	33.33	65.63
2	0.19013	10.19	30.81	17.10	41.00	27.29	64.03	54.03	-23.03	-26.74
3	0.37718	10.23	22.89	17.12	33.12	27.35	58.34	48.34	-25.22	-20.99
4	0.46200	10.23	33.80	27.57	44.03	37.80	56.66	46.66	-12.63	-8.86
5	0.94097	10.24	22.24	18.76	32.48	29.00	56.00	46.00	-23.52	-17.00
6	12.11811	10.72	19.59	14.29	30.31	25.01	60.00	50.00	-29.69	-24.99

Remarks:

1. Q.P. and AV. are abbreviations of quasi-peak and average individually.
2. The emission levels of other frequencies were very low against the limit.
3. Margin value = Emission level - Limit value
4. Correction factor = Insertion loss + Cable loss
5. Emission Level = Correction Factor + Reading Value.

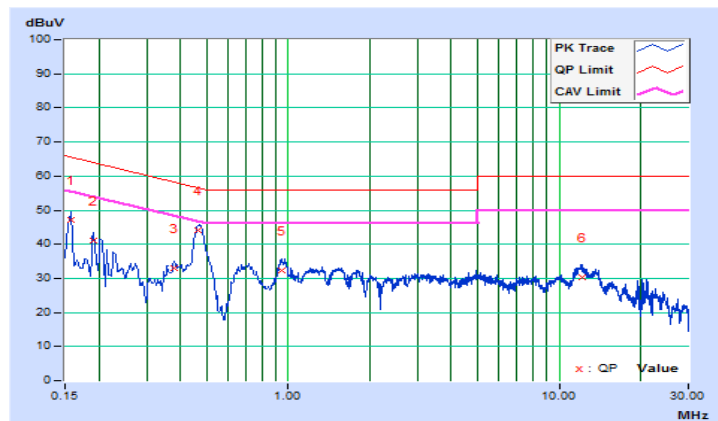

Phase	Line (L)	Detector Function	Quasi-Peak (QP) / Average (AV)
Test Mode	F		

No	Freq. [MHz]	Corr. Factor (dB)	Reading Value [dB (uV)]		Emission Level [dB (uV)]		Limit [dB (uV)]		Margin (dB)	
			Q.P.	AV.	Q.P.	AV.	Q.P.	AV.	Q.P.	AV.
			1	0.15687	10.41	39.72	25.52	50.13	35.93	65.63
2	0.18200	10.42	34.94	23.29	45.36	33.71	64.39	54.39	-19.03	-20.68
3	0.20600	10.43	29.48	18.80	39.91	29.23	63.37	53.37	-23.46	-24.14
4	0.22387	10.44	27.49	15.14	37.93	25.58	62.67	52.67	-24.74	-27.09
5	0.34124	10.49	34.99	28.66	45.48	39.15	59.17	49.17	-13.69	-10.02
6	0.35876	10.49	33.31	30.22	43.80	40.71	58.76	48.76	-14.96	-8.05

Remarks:

1. Q.P. and AV. are abbreviations of quasi-peak and average individually.
2. The emission levels of other frequencies were very low against the limit.
3. Margin value = Emission level - Limit value
4. Correction factor = Insertion loss + Cable loss
5. Emission Level = Correction Factor + Reading Value.

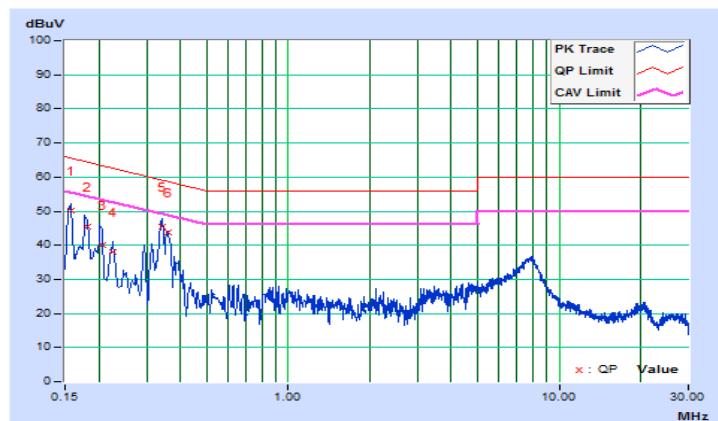

Phase	Neutral (N)	Detector Function	Quasi-Peak (QP) / Average (AV)
Test Mode	F		

No	Freq. [MHz]	Corr. Factor (dB)	Reading Value [dB (uV)]		Emission Level [dB (uV)]		Limit [dB (uV)]		Margin (dB)	
			Q.P.	AV.	Q.P.	AV.	Q.P.	AV.	Q.P.	AV.
			1	0.16755	10.17	36.27	22.73	46.44	32.90	65.08
2	0.19800	10.20	27.75	16.14	37.95	26.34	63.69	53.69	-25.74	-27.35
3	0.21015	10.20	27.59	13.24	37.79	23.44	63.20	53.20	-25.41	-29.76
4	0.35407	10.22	22.76	17.26	32.98	27.48	58.87	48.87	-25.89	-21.39
5	4.78600	10.45	17.82	6.88	28.27	17.33	56.00	46.00	-27.73	-28.67
6	7.85400	10.56	23.54	17.44	34.10	28.00	60.00	50.00	-25.90	-22.00

Remarks:

1. Q.P. and AV. are abbreviations of quasi-peak and average individually.
2. The emission levels of other frequencies were very low against the limit.
3. Margin value = Emission level - Limit value
4. Correction factor = Insertion loss + Cable loss
5. Emission Level = Correction Factor + Reading Value.

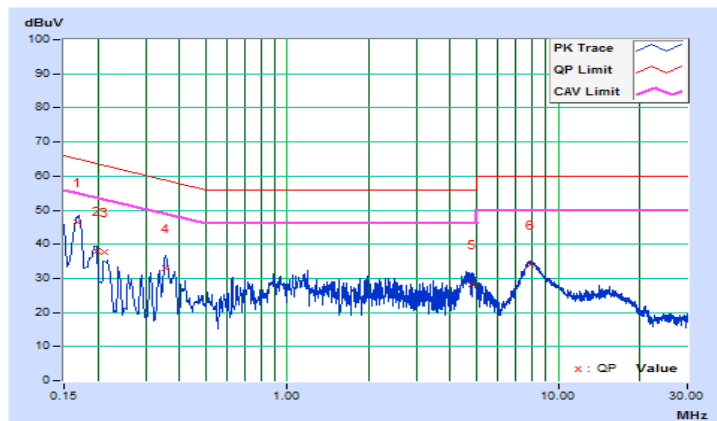

Phase	Line (L)	Detector Function	Quasi-Peak (QP) / Average (AV)
Test Mode	G		

No	Freq. [MHz]	Corr. Factor (dB)	Reading Value [dB (uV)]		Emission Level [dB (uV)]		Limit [dB (uV)]		Margin (dB)	
			Q.P.	AV.	Q.P.	AV.	Q.P.	AV.	Q.P.	AV.
			1	0.17384	10.42	34.98	22.26	45.40	32.68	64.77
2	0.19989	10.43	30.70	17.88	41.13	28.31	63.62	53.62	-22.49	-25.31
3	0.22200	10.44	27.38	15.11	37.82	25.55	62.74	52.74	-24.92	-27.19
4	0.35407	10.49	24.97	19.30	35.46	29.79	58.87	48.87	-23.41	-19.08
5	0.46813	10.50	35.50	30.97	46.00	41.47	56.55	46.55	-10.55	-5.08
6	0.94097	10.46	24.29	20.82	34.75	31.28	56.00	46.00	-21.25	-14.72

Remarks:

1. Q.P. and AV. are abbreviations of quasi-peak and average individually.
2. The emission levels of other frequencies were very low against the limit.
3. Margin value = Emission level - Limit value
4. Correction factor = Insertion loss + Cable loss
5. Emission Level = Correction Factor + Reading Value.

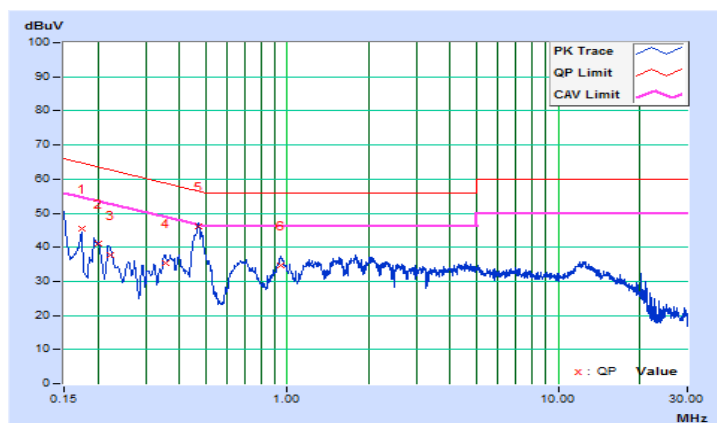

Phase	Neutral (N)	Detector Function	Quasi-Peak (QP) / Average (AV)
Test Mode	G		

No	Freq. [MHz]	Corr. Factor (dB)	Reading Value [dB (uV)]		Emission Level [dB (uV)]		Limit [dB (uV)]		Margin (dB)	
			Q.P.	AV.	Q.P.	AV.	Q.P.	AV.	Q.P.	AV.
			1	0.16932	10.17	32.40	18.32	42.57	28.49	64.99
2	0.19265	10.19	28.96	15.59	39.15	25.78	63.92	53.92	-24.77	-28.14
3	0.21800	10.20	24.18	11.75	34.38	21.95	62.89	52.89	-28.51	-30.94
4	0.26429	10.21	20.81	11.29	31.02	21.50	61.30	51.30	-30.28	-29.80
5	0.47000	10.23	34.41	30.15	44.64	40.38	56.51	46.51	-11.87	-6.13
6	0.93111	10.24	22.42	18.91	32.66	29.15	56.00	46.00	-23.34	-16.85

Remarks:

1. Q.P. and AV. are abbreviations of quasi-peak and average individually.
2. The emission levels of other frequencies were very low against the limit.
3. Margin value = Emission level - Limit value
4. Correction factor = Insertion loss + Cable loss
5. Emission Level = Correction Factor + Reading Value.

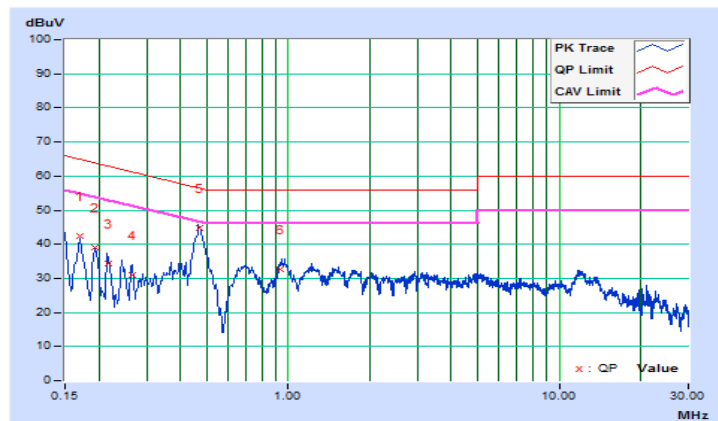

Phase	Line (L)	Detector Function	Quasi-Peak (QP) / Average (AV)
Test Mode	H		

No	Freq. [MHz]	Corr. Factor (dB)	Reading Value [dB (uV)]		Emission Level [dB (uV)]		Limit [dB (uV)]		Margin (dB)	
			Q.P.	AV.	Q.P.	AV.	Q.P.	AV.	Q.P.	AV.
			1	0.16535	10.41	36.21	25.35	46.62	35.76	65.19
2	0.18519	10.42	35.60	23.97	46.02	34.39	64.25	54.25	-18.23	-19.86
3	0.21294	10.44	32.35	19.01	42.79	29.45	63.09	53.09	-20.30	-23.64
4	0.24164	10.45	26.49	12.93	36.94	23.38	62.04	52.04	-25.10	-28.66
5	0.34124	10.49	33.52	31.31	44.01	41.80	59.17	49.17	-15.16	-7.37
6	0.35876	10.49	33.43	27.64	43.92	38.13	58.76	48.76	-14.84	-10.63

Remarks:

1. Q.P. and AV. are abbreviations of quasi-peak and average individually.
2. The emission levels of other frequencies were very low against the limit.
3. Margin value = Emission level - Limit value
4. Correction factor = Insertion loss + Cable loss
5. Emission Level = Correction Factor + Reading Value.

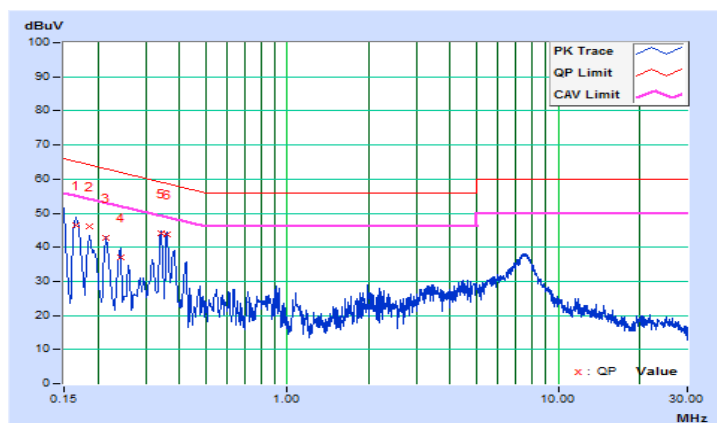

Phase	Neutral (N)	Detector Function	Quasi-Peak (QP) / Average (AV)
Test Mode	H		

No	Freq. [MHz]	Corr. Factor (dB)	Reading Value [dB (uV)]		Emission Level [dB (uV)]		Limit [dB (uV)]		Margin (dB)	
			Q.P.	AV.	Q.P.	AV.	Q.P.	AV.	Q.P.	AV.
			1	0.15000	10.15	40.19	26.01	50.34	36.16	66.00
2	0.16535	10.17	34.99	22.17	45.16	32.34	65.19	55.19	-20.03	-22.85
3	0.18600	10.19	33.60	19.41	43.79	29.60	64.21	54.21	-20.42	-24.61
4	0.21015	10.20	29.17	14.59	39.37	24.79	63.20	53.20	-23.83	-28.41
5	0.37000	10.23	24.50	17.36	34.73	27.59	58.50	48.50	-23.77	-20.91
6	7.67000	10.55	26.11	19.66	36.66	30.21	60.00	50.00	-23.34	-19.79

Remarks:

1. Q.P. and AV. are abbreviations of quasi-peak and average individually.
2. The emission levels of other frequencies were very low against the limit.
3. Margin value = Emission level - Limit value
4. Correction factor = Insertion loss + Cable loss
5. Emission Level = Correction Factor + Reading Value.

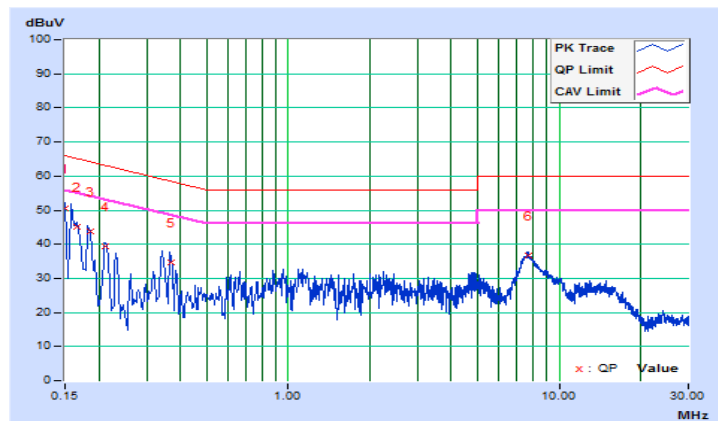

Phase	Line (L)	Detector Function	Quasi-Peak (QP) / Average (AV)
Test Mode	I		

No	Freq. [MHz]	Corr. Factor (dB)	Reading Value [dB (uV)]		Emission Level [dB (uV)]		Limit [dB (uV)]		Margin (dB)	
			Q.P.	AV.	Q.P.	AV.	Q.P.	AV.	Q.P.	AV.
			1	0.15687	10.41	38.07	25.26	48.48	35.67	65.63
2	0.17384	10.42	34.28	21.95	44.70	32.37	64.77	54.77	-20.07	-22.40
3	0.20200	10.43	29.74	17.37	40.17	27.80	63.53	53.53	-23.36	-25.73
4	0.35876	10.49	25.14	18.91	35.63	29.40	58.76	48.76	-23.13	-19.36
5	0.47400	10.50	35.02	30.47	45.52	40.97	56.44	46.44	-10.92	-5.47
6	0.96609	10.46	23.89	19.98	34.35	30.44	56.00	46.00	-21.65	-15.56

Remarks:

1. Q.P. and AV. are abbreviations of quasi-peak and average individually.
2. The emission levels of other frequencies were very low against the limit.
3. Margin value = Emission level - Limit value
4. Correction factor = Insertion loss + Cable loss
5. Emission Level = Correction Factor + Reading Value.

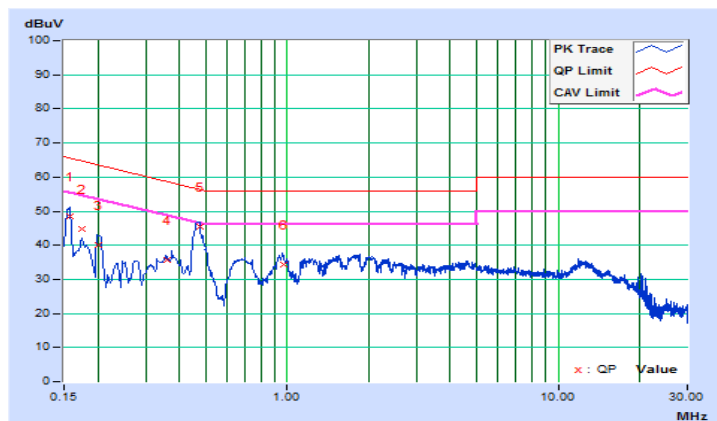

Phase	Neutral (N)	Detector Function	Quasi-Peak (QP) / Average (AV)
Test Mode	I		

No	Freq. [MHz]	Corr. Factor (dB)	Reading Value [dB (uV)]		Emission Level [dB (uV)]		Limit [dB (uV)]		Margin (dB)	
			Q.P.	AV.	Q.P.	AV.	Q.P.	AV.	Q.P.	AV.
			1	0.16932	10.17	32.82	20.03	42.99	30.20	64.99
2	0.19265	10.19	29.85	17.00	40.04	27.19	63.92	53.92	-23.88	-26.73
3	0.21800	10.20	25.81	14.02	36.01	24.22	62.89	52.89	-26.88	-28.67
4	0.39400	10.23	25.75	18.29	35.98	28.52	57.98	47.98	-22.00	-19.46
5	0.46200	10.23	37.62	31.33	47.85	41.56	56.66	46.66	-8.81	-5.10
6	0.93111	10.24	27.36	23.88	37.60	34.12	56.00	46.00	-18.40	-11.88

Remarks:

1. Q.P. and AV. are abbreviations of quasi-peak and average individually.
2. The emission levels of other frequencies were very low against the limit.
3. Margin value = Emission level - Limit value
4. Correction factor = Insertion loss + Cable loss
5. Emission Level = Correction Factor + Reading Value.

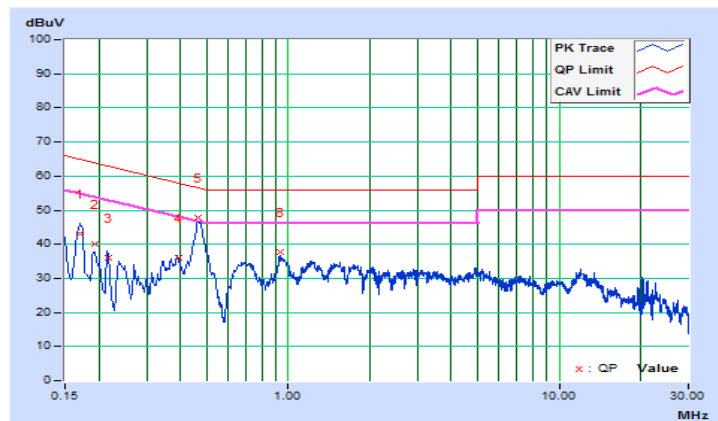

Phase	Line (L)	Detector Function	Quasi-Peak (QP) / Average (AV)
Test Mode	J		

No	Freq. [MHz]	Corr. Factor (dB)	Reading Value [dB (uV)]		Emission Level [dB (uV)]		Limit [dB (uV)]		Margin (dB)	
			Q.P.	AV.	Q.P.	AV.	Q.P.	AV.	Q.P.	AV.
			1	0.16200	10.41	38.11	25.59	48.52	36.00	65.36
2	0.18519	10.42	35.52	23.87	45.94	34.29	64.25	54.25	-18.31	-19.96
3	0.19800	10.43	34.23	22.21	44.66	32.64	63.69	53.69	-19.03	-21.05
4	0.24164	10.45	26.39	12.97	36.84	23.42	62.04	52.04	-25.20	-28.62
5	0.34486	10.49	34.65	28.56	45.14	39.05	59.09	49.09	-13.95	-10.04
6	0.36600	10.50	31.58	28.07	42.08	38.57	58.59	48.59	-16.51	-10.02

Remarks:

1. Q.P. and AV. are abbreviations of quasi-peak and average individually.
2. The emission levels of other frequencies were very low against the limit.
3. Margin value = Emission level - Limit value
4. Correction factor = Insertion loss + Cable loss
5. Emission Level = Correction Factor + Reading Value.

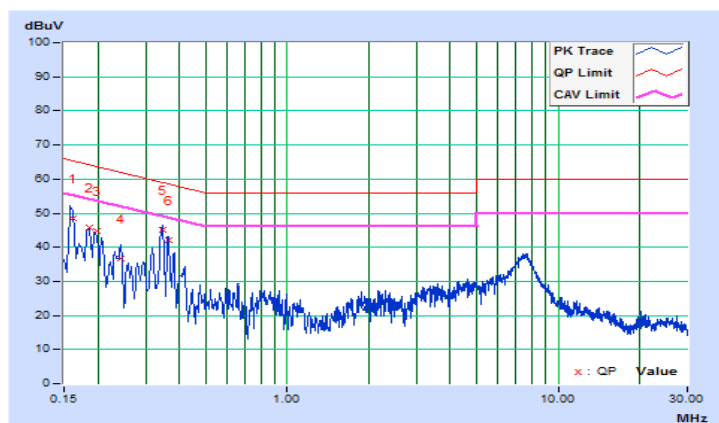

Phase	Neutral (N)	Detector Function	Quasi-Peak (QP) / Average (AV)
Test Mode	J		

No	Freq. [MHz]	Corr. Factor (dB)	Reading Value [dB (uV)]		Emission Level [dB (uV)]		Limit [dB (uV)]		Margin (dB)	
			Q.P.	AV.	Q.P.	AV.	Q.P.	AV.	Q.P.	AV.
			1	0.17157	10.17	38.04	23.46	48.21	33.63	64.88
2	0.19013	10.19	33.62	19.16	43.81	29.35	64.03	54.03	-20.22	-24.68
3	0.21800	10.20	28.73	14.02	38.93	24.22	62.89	52.89	-23.96	-28.67
4	0.34486	10.22	26.31	19.77	36.53	29.99	59.09	49.09	-22.56	-19.10
5	0.36834	10.23	25.73	19.36	35.96	29.59	58.54	48.54	-22.58	-18.95
6	7.57400	10.55	26.65	20.23	37.20	30.78	60.00	50.00	-22.80	-19.22

Remarks:

1. Q.P. and AV. are abbreviations of quasi-peak and average individually.
2. The emission levels of other frequencies were very low against the limit.
3. Margin value = Emission level - Limit value
4. Correction factor = Insertion loss + Cable loss
5. Emission Level = Correction Factor + Reading Value.

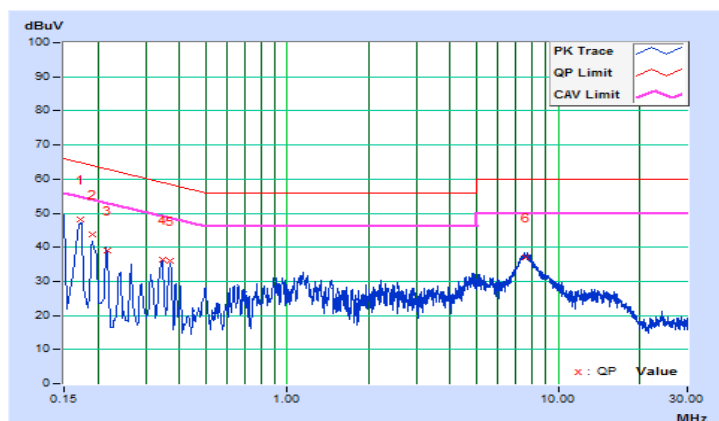

Phase	Line (L)	Detector Function	Quasi-Peak (QP) / Average (AV)
Test Mode	K		

No	Freq. [MHz]	Corr. Factor (dB)	Reading Value [dB (uV)]		Emission Level [dB (uV)]		Limit [dB (uV)]		Margin (dB)	
			Q.P.	AV.	Q.P.	AV.	Q.P.	AV.	Q.P.	AV.
			1	0.15687	10.41	39.37	25.98	49.78	36.39	65.63
2	0.16535	10.41	37.56	23.33	47.97	33.74	65.19	55.19	-17.22	-21.45
3	0.18519	10.42	33.53	21.24	43.95	31.66	64.25	54.25	-20.30	-22.59
4	0.20600	10.43	30.28	17.36	40.71	27.79	63.37	53.37	-22.66	-25.58
5	0.25400	10.45	24.24	15.74	34.69	26.19	61.63	51.63	-26.94	-25.44
6	0.47400	10.50	35.00	30.41	45.50	40.91	56.44	46.44	-10.94	-5.53

Remarks:

1. Q.P. and AV. are abbreviations of quasi-peak and average individually.
2. The emission levels of other frequencies were very low against the limit.
3. Margin value = Emission level - Limit value
4. Correction factor = Insertion loss + Cable loss
5. Emission Level = Correction Factor + Reading Value.

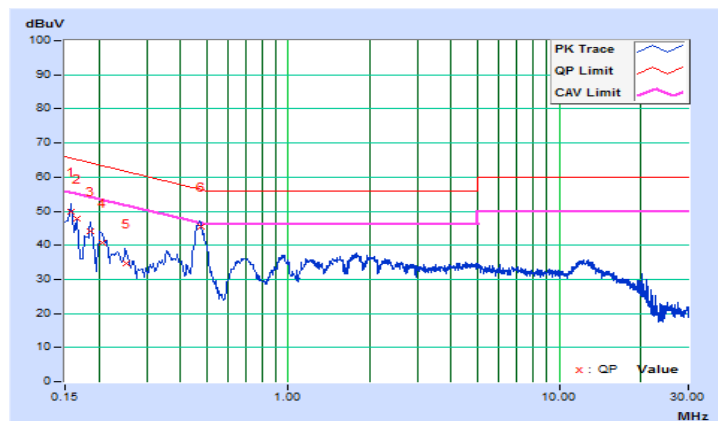

Phase	Neutral (N)	Detector Function	Quasi-Peak (QP) / Average (AV)
Test Mode	K		

No	Freq. [MHz]	Corr. Factor (dB)	Reading Value [dB (uV)]		Emission Level [dB (uV)]		Limit [dB (uV)]		Margin (dB)	
			Q.P.	AV.	Q.P.	AV.	Q.P.	AV.	Q.P.	AV.
			1	0.15400	10.16	39.95	25.66	50.11	35.82	65.78
2	0.16319	10.17	38.51	23.57	48.68	33.74	65.30	55.30	-16.62	-21.56
3	0.17384	10.18	36.09	22.08	46.27	32.26	64.77	54.77	-18.50	-22.51
4	0.19000	10.19	34.00	20.33	44.19	30.52	64.04	54.04	-19.85	-23.52
5	0.23800	10.21	26.89	16.09	37.10	26.30	62.17	52.17	-25.07	-25.87
6	0.46813	10.23	34.79	30.20	45.02	40.43	56.55	46.55	-11.53	-6.12

Remarks:

1. Q.P. and AV. are abbreviations of quasi-peak and average individually.
2. The emission levels of other frequencies were very low against the limit.
3. Margin value = Emission level - Limit value
4. Correction factor = Insertion loss + Cable loss
5. Emission Level = Correction Factor + Reading Value.

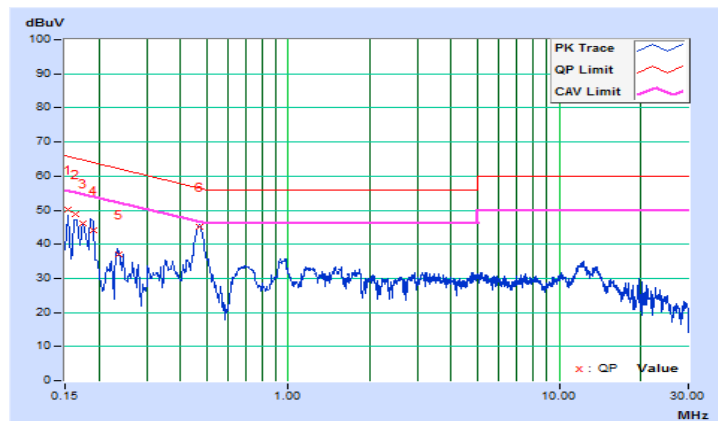

4.3 Transmit Power Measurement

4.3.1 Limits of Transmit Power Measurement

Operation Band	EUT Category		Limit
U-NII-1		Outdoor Access Point	1 Watt (30 dBm) (Max. e.i.r.p \leq 125mW(21 dBm) at any elevation angle above 30 degrees as measured from the horizon)
		Fixed point-to-point Access Point	1 Watt (30 dBm)
		Indoor Access Point	1 Watt (30 dBm)
		Mobile and Portable client device	250mW (24 dBm)
U-NII-2A	√		250mW (24 dBm) or 11 dBm+10 log B*
U-NII-2C	√		250mW (24 dBm) or 11 dBm+10 log B*
U-NII-3	√		1 Watt (30 dBm)

*B is the 26 dB emission bandwidth in megahertz

Per KDB 662911 Method of conducted output power measurement on IEEE 802.11 devices,

Array Gain = 0 dB (i.e., no array gain) for $N_{ANT} \leq 4$;

Array Gain = 0 dB (i.e., no array gain) for channel widths ≥ 40 MHz for any N_{ANT} ;

Array Gain = $5 \log(N_{ANT}/N_{SS})$ dB or 3 dB, whichever is less for 20-MHz channel widths with $N_{ANT} \geq 5$.

For power measurements on all other devices: Array Gain = $10 \log(N_{ANT}/N_{SS})$ dB.

4.3.2 Test Setup

For Power Output

802.11a, 802.11n (HT20), 802.11n (HT40)

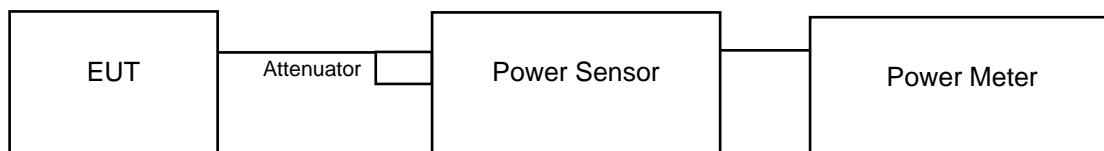

802.11ac (VHT80)

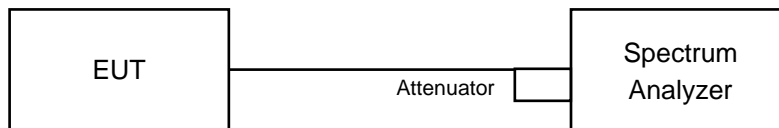

For 26dB Bandwidth

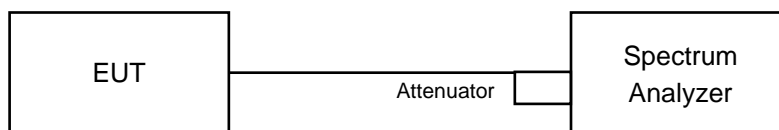

4.3.3 Test Instruments

Refer to section 4.1.2 to get information of above instrument.

4.3.4 Test Procedure

For Average Power Measurement

For 802.11a, 802.11n (HT20), 802.11n (HT40)

Method PM is used to perform output power measurement, trigger and gating function of wide band power meter is enabled to measure max output power of TX on burst. Duty factor is not added to measured value.

For 802.11ac (VHT80)

- a. Set span to encompass the entire 26 dB EBW (or, alternatively, the entire 99% occupied bandwidth) of the signal.
- b. Set sweep trigger to "free run".
- c. Set RBW = 1 MHz.
- d. Set VBW \geq 3 MHz.
- e. Number of points in sweep \geq 2 Span / RBW.
- f. Sweep time \leq (number of points in sweep) * T
- g. Using emission bandwidth to determine the frequency span for integration the channel bandwidth.
- h. Detector = RMS.
- i. Trace mode = max hold.
- j. Allow max hold to run for at least 60 seconds, or longer as needed to allow the trace to stabilize.
- k. Compute power by integrating the spectrum across the EBW (or, alternatively, the entire 99% occupied bandwidth) of the signal using the instrument's band power measurement function with band limits set equal to the EBW (or occupied bandwidth) band edges. If the instrument does not have a band power function, sum the spectrum levels (in power units) at 1 MHz intervals extending across the EBW (or, alternatively, the entire 99% occupied bandwidth) of the spectrum.

For 26dB Bandwidth

- a. Set RBW = approximately 1% of the emission bandwidth.
- b. Set the VBW > RBW.
- c. Detector = Peak.
- d. Trace mode = max hold.
- e. Measure the maximum width of the emission that is 26 dB down from the peak of the emission. Compare this with the RBW setting of the analyzer. Readjust RBW and repeat measurement as needed until the RBW/EBW ratio is approximately 1%.

4.3.5 Deviation from Test Standard

No deviation.

4.3.6 EUT Operating Conditions

The software provided by client to enable the EUT under transmission condition continuously at lowest, middle and highest channel frequencies individually.

4.3.7 Test Result

Test Mode B

Power Output:

CDD Mode

802.11a

Chan.	Freq. (MHz)	Maximum Conducted Power (dBm)		Total Power (mW)	Total Power (dBm)	Power Limit (dBm)	Pass / Fail
		Chain 0	Chain 1				
52	5260	19.75	19.68	187.303	22.73	23.84	Pass
60	5300	19.56	19.48	179.081	22.53	23.84	Pass
64	5320	19.25	18.54	155.590	21.92	23.83	Pass
100	5500	18.53	18.94	149.628	21.75	23.86	Pass
116	5580	19.27	19.08	165.438	22.19	23.86	Pass
140	5700	18.19	17.47	121.764	20.86	23.85	Pass
144	5720 For U-NII-2C	17.88	17.68	119.990	20.79	22.66	Pass
144	5720 For U-NII-3	13.04	12.90	39.635	15.98	30.00	Pass

Note:

For U-NII-2A, U-NII-2C Band:

Chain 0

1. $11\text{dBm} + 10\log (19.82) = 23.97 \text{ dBm} < 24\text{dBm}$
2. $11\text{dBm} + 10\log (19.62) = 23.93 \text{ dBm} < 24\text{dBm}$
3. $11\text{dBm} + 10\log (19.68) = 23.94 \text{ dBm} < 24\text{dBm}$
4. $11\text{dBm} + 10\log (19.55) = 23.91 \text{ dBm} < 24\text{dBm}$
5. $11\text{dBm} + 10\log (19.53) = 23.91 \text{ dBm} < 24\text{dBm}$
6. $11\text{dBm} + 10\log (19.50) = 23.90 \text{ dBm} < 24\text{dBm}$
7. $11\text{dBm} + 10\log (5725.00 - 5710.12) = 22.73 \text{ dBm} < 24\text{dBm}$

Chain 1

1. $11\text{dBm} + 10\log (19.22) = 23.84 \text{ dBm} < 24\text{dBm}$
2. $11\text{dBm} + 10\log (19.21) = 23.84 \text{ dBm} < 24\text{dBm}$
3. $11\text{dBm} + 10\log (19.18) = 23.83 \text{ dBm} < 24\text{dBm}$
4. $11\text{dBm} + 10\log (19.34) = 23.86 \text{ dBm} < 24\text{dBm}$
5. $11\text{dBm} + 10\log (19.31) = 23.86 \text{ dBm} < 24\text{dBm}$
6. $11\text{dBm} + 10\log (19.28) = 23.85 \text{ dBm} < 24\text{dBm}$
7. $11\text{dBm} + 10\log (5725.00 - 5710.34) = 22.66 \text{ dBm} < 24\text{dBm}$

802.11n (HT20)

Chan.	Freq. (MHz)	Maximum Conducted Power (dBm)		Total Power (mW)	Total Power (dBm)	Power Limit (dBm)	Pass / Fail
		Chain 0	Chain 1				
52	5260	19.33	19.29	170.622	22.32	24.00	Pass
60	5300	19.21	19.13	165.214	22.18	24.00	Pass
64	5320	19.26	18.54	155.783	21.93	24.00	Pass
100	5500	18.81	18.61	148.644	21.72	24.00	Pass
116	5580	19.29	19.14	166.953	22.23	24.00	Pass
140	5700	17.73	16.99	109.296	20.39	24.00	Pass
144	5720 For U-NII-2C	17.96	17.55	119.402	20.77	22.82	Pass
144	5720 For U-NII-3	13.29	13.10	41.747	16.21	30.00	Pass

Note:

For U-NII-2A, U-NII-2C Band:

Chain 0

1. $11\text{dBm} + 10\log (20.61) = 24.14 \text{ dBm} > 24\text{dBm}$
2. $11\text{dBm} + 10\log (20.42) = 24.10 \text{ dBm} > 24\text{dBm}$
3. $11\text{dBm} + 10\log (20.82) = 24.18 \text{ dBm} > 24\text{dBm}$
4. $11\text{dBm} + 10\log (20.42) = 24.10 \text{ dBm} > 24\text{dBm}$
5. $11\text{dBm} + 10\log (20.55) = 24.13 \text{ dBm} > 24\text{dBm}$
6. $11\text{dBm} + 10\log (20.62) = 24.14 \text{ dBm} > 24\text{dBm}$
7. $11\text{dBm} + 10\log (5725.00 - 5709.76) = 22.83 \text{ dBm} < 24\text{dBm}$

Chain 1

1. $11\text{dBm} + 10\log (20.44) = 24.10 \text{ dBm} > 24\text{dBm}$
2. $11\text{dBm} + 10\log (20.48) = 24.11 \text{ dBm} > 24\text{dBm}$
3. $11\text{dBm} + 10\log (20.45) = 24.11 \text{ dBm} > 24\text{dBm}$
4. $11\text{dBm} + 10\log (21.21) = 24.27 \text{ dBm} > 24\text{dBm}$
5. $11\text{dBm} + 10\log (20.56) = 24.13 \text{ dBm} > 24\text{dBm}$
6. $11\text{dBm} + 10\log (20.36) = 24.09 \text{ dBm} > 24\text{dBm}$
7. $11\text{dBm} + 10\log (5725.00 - 5709.79) = 22.82 \text{ dBm} < 24\text{dBm}$

802.11n (HT40)

Chan.	Freq. (MHz)	Maximum Conducted Power (dBm)		Total Power (mW)	Total Power (dBm)	Power Limit (dBm)	Pass / Fail
		Chain 0	Chain 1				
54	5270	20.82	20.12	223.583	23.49	24.00	Pass
62	5310	17.90	17.19	114.020	20.57	24.00	Pass
102	5510	16.98	16.89	98.753	19.95	24.00	Pass
110	5550	20.66	20.36	225.056	23.52	24.00	Pass
134	5670	20.48	19.97	210.998	23.24	24.00	Pass
142	5710 For U-NII-2C	19.36	18.68	160.088	22.04	24.00	Pass
142	5710 For U-NII-3	15.61	15.10	68.751	18.37	30.00	Pass

Note:

For U-NII-2A, U-NII-2C Band:

Chain 0

1. $11\text{dBm} + 10\log (40.60) = 27.09 \text{ dBm} > 24\text{dBm}$
2. $11\text{dBm} + 10\log (40.80) = 27.11 \text{ dBm} > 24\text{dBm}$
3. $11\text{dBm} + 10\log (40.69) = 27.09 \text{ dBm} > 24\text{dBm}$
4. $11\text{dBm} + 10\log (40.79) = 27.11 \text{ dBm} > 24\text{dBm}$
5. $11\text{dBm} + 10\log (40.68) = 27.09 \text{ dBm} > 24\text{dBm}$
6. $11\text{dBm} + 10\log (5725.00 - 5682.06) = 27.33 \text{ dBm} > 24\text{dBm}$

Chain 1

1. $11\text{dBm} + 10\log (40.57) = 27.08 \text{ dBm} > 24\text{dBm}$
2. $11\text{dBm} + 10\log (40.45) = 27.07 \text{ dBm} > 24\text{dBm}$
3. $11\text{dBm} + 10\log (40.47) = 27.07 \text{ dBm} > 24\text{dBm}$
4. $11\text{dBm} + 10\log (40.65) = 27.09 \text{ dBm} > 24\text{dBm}$
5. $11\text{dBm} + 10\log (40.49) = 27.07 \text{ dBm} > 24\text{dBm}$
6. $11\text{dBm} + 10\log (5725.00 - 5671.87) = 28.25 \text{ dBm} > 24\text{dBm}$

802.11ac (VHT80)

Chan.	Freq. (MHz)	Maximum Conducted Power (dBm)		Total Power (mW)	Total Power (dBm)	Power Limit (dBm)	Pass / Fail
		Chain 0	Chain 1				
58	5290	16.16	15.69	78.373	18.94	24.00	Pass
106	5530	15.32	15.11	66.475	18.23	24.00	Pass
122	5610	21.03	20.43	237.173	23.75	24.00	Pass
138	5690 For U-NII-2C	19.83	18.55	167.775	22.25	24.00	Pass
138	5690 For U-NII-3	13.14	15.68	57.589	17.60	30.00	Pass

Note:

For U-NII-2A, U-NII-2C Band:

Chain 0

1. $11\text{dBm} + 10\log (83.72) = 30.23 \text{ dBm} > 24\text{dBm}$
2. $11\text{dBm} + 10\log (83.17) = 30.20 \text{ dBm} > 24\text{dBm}$
3. $11\text{dBm} + 10\log (136.90) = 32.36 \text{ dBm} > 24\text{dBm}$
4. $11\text{dBm} + 10\log (5725.00 - 5625.19) = 30.99 \text{ dBm} > 24\text{dBm}$

Chain 1

1. $11\text{dBm} + 10\log (83.89) = 30.24 \text{ dBm} > 24\text{dBm}$
2. $11\text{dBm} + 10\log (83.69) = 30.23 \text{ dBm} > 24\text{dBm}$
3. $11\text{dBm} + 10\log (165.96) = 33.20 \text{ dBm} > 24\text{dBm}$
4. $11\text{dBm} + 10\log (5725.00 - 5616.47) = 31.36 \text{ dBm} > 24\text{dBm}$

Beamforming Mode

802.11n (HT20)

Chan.	Freq. (MHz)	Maximum Conducted Power (dBm)		Total Power (mW)	Total Power (dBm)	Power Limit (dBm)	Pass / Fail
		Chain 0	Chain 1				
52	5260	16.32	16.28	85.310	19.31	21.99	Pass
60	5300	16.20	16.12	82.604	19.17	21.99	Pass
64	5320	16.25	15.53	77.983	18.92	21.99	Pass
100	5500	15.80	15.60	74.302	18.71	21.99	Pass
116	5580	16.28	16.13	83.560	19.22	21.99	Pass
140	5700	14.72	13.98	54.702	17.38	21.99	Pass
144	5720 For U-NII-2C	14.95	14.54	59.704	17.76	20.81	Pass
144	5720 For U-NII-3	10.28	10.09	20.893	13.20	27.99	Pass

Note:

- 5260~5320MHz directional gain = $5\text{dBi} + 10\log(2) = 8.01\text{dBi} > 6\text{dBi}$, so the power limit shall be reduced to $24 - (8.01 - 6) = 21.99\text{dBm}$.
- 5500~5700MHz directional gain = $5\text{dBi} + 10\log(2) = 8.01\text{dBi} > 6\text{dBi}$, so the power limit shall be reduced to $24 - (8.01 - 6) = 21.99\text{dBm}$.
- 5720MHz directional gain = $5\text{dBi} + 10\log(2) = 8.01\text{dBi} > 6\text{dBi}$, so the power limit shall be reduced to $22.82 - (8.01 - 6) = 20.81\text{dBm}$.
- 5745~5825MHz directional gain = $5\text{dBi} + 10\log(2) = 8.01\text{dBi} > 6\text{dBi}$, so the power limit shall be reduced to $30 - (8.01 - 6) = 27.99\text{dBm}$.

For U-NII-2A, U-NII-2C Band:

Chain 0

- $11\text{dBm} + 10\log (20.61) = 24.14 \text{ dBm} > 24\text{dBm}$
- $11\text{dBm} + 10\log (20.42) = 24.10 \text{ dBm} > 24\text{dBm}$
- $11\text{dBm} + 10\log (20.82) = 24.18 \text{ dBm} > 24\text{dBm}$
- $11\text{dBm} + 10\log (20.42) = 24.10 \text{ dBm} > 24\text{dBm}$
- $11\text{dBm} + 10\log (20.55) = 24.13 \text{ dBm} > 24\text{dBm}$
- $11\text{dBm} + 10\log (20.62) = 24.14 \text{ dBm} > 24\text{dBm}$
- $11\text{dBm} + 10\log (5725.00 - 5709.76) = 22.83 \text{ dBm} < 24\text{dBm}$

Chain 1

- $11\text{dBm} + 10\log (20.44) = 24.10 \text{ dBm} > 24\text{dBm}$
- $11\text{dBm} + 10\log (20.48) = 24.11 \text{ dBm} > 24\text{dBm}$
- $11\text{dBm} + 10\log (20.45) = 24.11 \text{ dBm} > 24\text{dBm}$
- $11\text{dBm} + 10\log (21.21) = 24.27 \text{ dBm} > 24\text{dBm}$
- $11\text{dBm} + 10\log (20.56) = 24.13 \text{ dBm} > 24\text{dBm}$
- $11\text{dBm} + 10\log (20.36) = 24.09 \text{ dBm} > 24\text{dBm}$
- $11\text{dBm} + 10\log (5725.00 - 5709.79) = 22.82 \text{ dBm} < 24\text{dBm}$

802.11n (HT40)

Chan.	Freq. (MHz)	Maximum Conducted Power (dBm)		Total Power (mW)	Total Power (dBm)	Power Limit (dBm)	Pass / Fail
		Chain 0	Chain 1				
54	5270	17.81	17.11	111.686	20.48	21.99	Pass
62	5310	14.89	14.18	57.016	17.56	21.99	Pass
102	5510	13.97	13.88	49.431	16.94	21.99	Pass
110	5550	17.65	17.35	112.460	20.51	21.99	Pass
134	5670	17.47	16.96	105.439	20.23	21.99	Pass
142	5710 For U-NII-2C	16.35	15.67	79.983	19.03	21.99	Pass
142	5710 For U-NII-3	12.60	12.09	34.356	15.36	27.99	Pass

Note:

- 5260~5320MHz directional gain = $5\text{dBi} + 10\log(2) = 8.01\text{dBi} > 6\text{dBi}$, so the power limit shall be reduced to $24 - (8.01 - 6) = 21.99\text{dBm}$.
- 5500~5720MHz directional gain = $5\text{dBi} + 10\log(2) = 8.01\text{dBi} > 6\text{dBi}$, so the power limit shall be reduced to $24 - (8.01 - 6) = 21.99\text{dBm}$.
- 5745~5825MHz directional gain = $5\text{dBi} + 10\log(2) = 8.01\text{dBi} > 6\text{dBi}$, so the power limit shall be reduced to $30 - (8.01 - 6) = 27.99\text{dBm}$.

For U-NII-2A, U-NII-2C Band:

Chain 0

- $11\text{dBm} + 10\log(40.60) = 27.09\text{ dBm} > 24\text{dBm}$
- $11\text{dBm} + 10\log(40.80) = 27.11\text{ dBm} > 24\text{dBm}$
- $11\text{dBm} + 10\log(40.69) = 27.09\text{ dBm} > 24\text{dBm}$
- $11\text{dBm} + 10\log(40.79) = 27.11\text{ dBm} > 24\text{dBm}$
- $11\text{dBm} + 10\log(40.68) = 27.09\text{ dBm} > 24\text{dBm}$
- $11\text{dBm} + 10\log(5725.00 - 5682.06) = 27.33\text{ dBm} > 24\text{dBm}$

Chain 1

- $11\text{dBm} + 10\log(40.57) = 27.08\text{ dBm} > 24\text{dBm}$
- $11\text{dBm} + 10\log(40.45) = 27.07\text{ dBm} > 24\text{dBm}$
- $11\text{dBm} + 10\log(40.47) = 27.07\text{ dBm} > 24\text{dBm}$
- $11\text{dBm} + 10\log(40.65) = 27.09\text{ dBm} > 24\text{dBm}$
- $11\text{dBm} + 10\log(40.49) = 27.07\text{ dBm} > 24\text{dBm}$
- $11\text{dBm} + 10\log(5725.00 - 5671.87) = 28.25\text{ dBm} > 24\text{dBm}$

802.11ac (VHT80)

Chan.	Freq. (MHz)	Maximum Conducted Power (dBm)		Total Power (mW)	Total Power (dBm)	Power Limit (dBm)	Pass / Fail
		Chain 0	Chain 1				
58	5290	13.15	12.68	39.174	15.93	21.99	Pass
106	5530	12.31	12.10	33.266	15.22	21.99	Pass
122	5610	18.02	17.42	118.577	20.74	21.99	Pass
138	5690 For U-NII-2C	16.82	15.54	83.946	19.24	21.99	Pass
138	5690 For U-NII-3	10.13	12.67	28.774	14.59	27.99	Pass

Note:

- 5260~5320MHz directional gain = 5dBi + 10log(2) = 8.01dBi > 6dBi, so the power limit shall be reduced to 24-(8.01-6) = 21.99dBm.
- 5500~5720MHz directional gain = 5dBi + 10log(2) = 8.01dBi > 6dBi, so the power limit shall be reduced to 24-(8.01-6) = 21.99dBm.
- 5745~5825MHz directional gain = 5dBi + 10log(2) = 8.01dBi > 6dBi, so the power limit shall be reduced to 30-(8.01-6) = 27.99dBm.

For U-NII-2A, U-NII-2C Band:

Chain 0

- 11dBm + 10log (83.72) = 30.23 dBm > 24dBm
- 11dBm + 10log (83.17) = 30.20 dBm > 24dBm
- 11dBm + 10log (136.90) = 32.36 dBm > 24dBm
- 11dBm + 10log (5725.00 - 5625.19) = 30.99 dBm > 24dBm

Chain 1

- 11dBm + 10log (83.89) = 30.24 dBm > 24dBm
- 11dBm + 10log (83.69) = 30.23 dBm > 24dBm
- 11dBm + 10log (165.96) = 33.20 dBm > 24dBm
- 11dBm + 10log (5725.00 - 5616.47) = 31.36 dBm > 24dBm

26dB Bandwidth:

802.11a

Chan.	Freq. (MHz)	26dBc Bandwidth (MHz)	
		Chain 0	Chain 1
52	5260	19.82	19.22
60	5300	19.62	19.21
64	5320	19.68	19.18
100	5500	19.55	19.34
116	5580	19.53	19.31
140	5700	19.50	19.28
144	5720 For U-NII-2C	14.88	14.66
144	5720 For U-NII-3	4.89	4.87

802.11n (HT20)

Chan.	Freq. (MHz)	26dBc Bandwidth (MHz)	
		Chain 0	Chain 1
52	5260	20.61	20.44
60	5300	20.42	20.48
64	5320	20.82	20.45
100	5500	20.42	21.21
116	5580	20.55	20.56
140	5700	20.62	20.36
144	5720 For U-NII-2C	15.24	15.21
144	5720 For U-NII-3	5.20	5.46

802.11n (HT40)

Chan.	Freq. (MHz)	26dBc Bandwidth (MHz)	
		Chain 0	Chain 1
54	5270	40.60	40.57
62	5310	40.80	40.45
102	5510	40.69	40.47
110	5550	40.79	40.65
134	5670	40.68	40.49
142	5710 For U-NII-2C	42.94	53.13
142	5710 For U-NII-3	18.11	23.30

802.11ac (VHT80)

Chan.	Freq. (MHz)	26dBc Bandwidth (MHz)	
		Chain 0	Chain 1
58	5290	83.72	83.89
106	5530	83.17	83.69
122	5610	136.90	165.96
138	5690 For U-NII-2C	99.81	108.53
138	5690 For U-NII-3	21.39	55.98

Spectrum Plot of Worst Value

802.11a

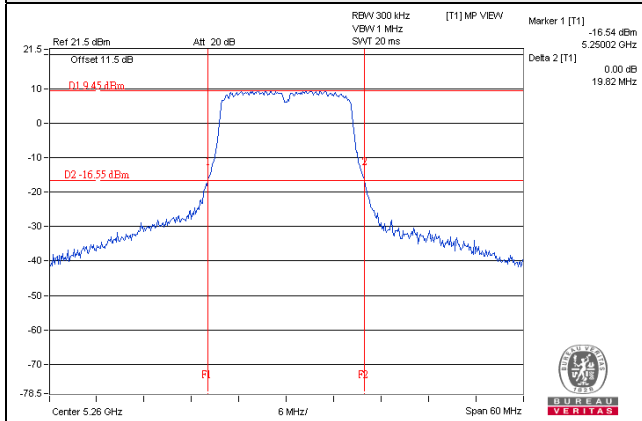

802.11n (HT20)

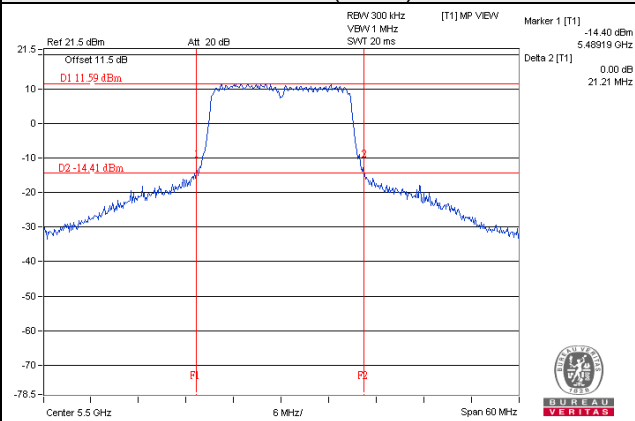

802.11n (HT40)

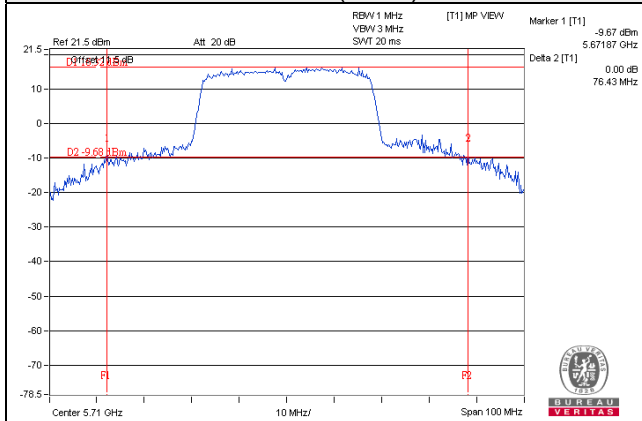

802.11ac (VHT80)

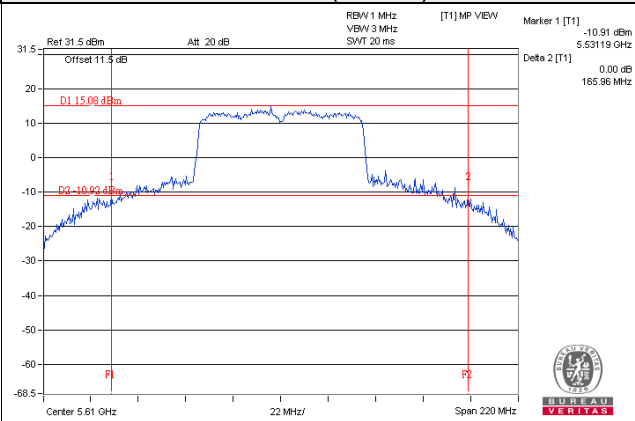

EUT Maximum Conducted Power

CDD Mode

802.11a

Frequency Band (MHz)	Max. Power	
	Output Power (mW)	Output Power (dBm)
5250~5350	187.303	22.73
5470~5725	165.438	22.19

802.11n (HT20)

Frequency Band (MHz)	Max. Power	
	Output Power (mW)	Output Power (dBm)
5250~5350	170.622	22.32
5470~5725	166.953	22.23

802.11n (HT40)

Frequency Band (MHz)	Max. Power	
	Output Power (mW)	Output Power (dBm)
5250~5350	223.583	23.49
5470~5725	225.056	23.52

802.11ac (VHT80)

Frequency Band (MHz)	Max. Power	
	Output Power (mW)	Output Power (dBm)
5250~5350	78.373	18.94
5470~5725	237.173	23.75

Beamforming Mode

802.11n (HT20)

Frequency Band (MHz)	Max. Power	
	Output Power (mW)	Output Power (dBm)
5250~5350	85.310	19.31
5470~5725	83.560	19.22

802.11n (HT40)

Frequency Band (MHz)	Max. Power	
	Output Power (mW)	Output Power (dBm)
5250~5350	111.686	20.48
5470~5725	112.460	20.51

802.11ac (VHT80)

Frequency Band (MHz)	Max. Power	
	Output Power (mW)	Output Power (dBm)
5250~5350	39.174	15.93
5470~5725	118.577	20.74

Test Mode D

Power Output:

CDD Mode

802.11a

Chan.	Freq. (MHz)	Maximum Conducted Power (dBm)		Total Power (mW)	Total Power (dBm)	Power Limit (dBm)	Pass / Fail
		Chain 0	Chain 1				
52	5260	16.68	16.15	87.769	19.43	22.51	Pass
60	5300	16.62	16.33	88.874	19.49	22.53	Pass
64	5320	16.45	16.32	87.012	19.40	22.53	Pass
100	5500	15.51	16.28	78.025	18.92	22.49	Pass
116	5580	15.03	15.12	64.351	18.09	22.55	Pass
140	5700	17.21	16.64	98.734	19.94	22.56	Pass
144	5720 For U-NII-2C	16.21	16.05	82.055	19.14	21.37	Pass
144	5720 For U-NII-3	11.19	10.87	25.370	14.04	28.70	Pass

Note:

- 5260MHz gain = 7.3dBi > 6dBi, so the power limit shall be reduced to 23.81-(7.3-6) = 22.51dBm.
- 5300~5320MHz gain = 7.3dBi > 6dBi, so the power limit shall be reduced to 23.83-(7.3-6) = 22.53dBm.
- 5500MHz gain = 7.3dBi > 6dBi, so the power limit shall be reduced to 23.79-(7.3-6) = 22.49dBm.
- 5580MHz gain = 7.3dBi > 6dBi, so the power limit shall be reduced to 23.85-(7.3-6) = 22.55dBm.
- 5700MHz gain = 7.3dBi > 6dBi, so the power limit shall be reduced to 23.86-(7.3-6) = 22.56dBm.
- 5720MHz gain = 7.3dBi > 6dBi, so the power limit shall be reduced to 22.67-(7.3-6) = 21.37dBm.
- 5745~5825MHz gain = 7.3dBi > 6dBi, so the power limit shall be reduced to 30-(7.3-6) = 28.70dBm.

For U-NII-2A, U-NII-2C Band:

Chain 0

- 11dBm + 10log (19.53) = 23.91 dBm < 24dBm
- 11dBm + 10log (19.55) = 23.91 dBm < 24dBm
- 11dBm + 10log (19.45) = 23.89 dBm < 24dBm
- 11dBm + 10log (19.56) = 23.91 dBm < 24dBm
- 11dBm + 10log (19.56) = 23.91 dBm < 24dBm
- 11dBm + 10log (19.58) = 23.92 dBm < 24dBm
- 11dBm + 10log (5725.00 - 5710.09) = 22.73 dBm < 24dBm

Chain 1

- 11dBm + 10log (19.11) = 23.81 dBm < 24dBm
- 11dBm + 10log (19.18) = 23.83 dBm < 24dBm
- 11dBm + 10log (19.17) = 23.83 dBm < 24dBm
- 11dBm + 10log (19.00) = 23.79 dBm < 24dBm
- 11dBm + 10log (19.29) = 23.85 dBm < 24dBm
- 11dBm + 10log (19.33) = 23.86 dBm < 24dBm
- 11dBm + 10log (5725.00 - 5710.32) = 22.67 dBm < 24dBm

802.11n (HT20)

Chan.	Freq. (MHz)	Maximum Conducted Power (dBm)		Total Power (mW)	Total Power (dBm)	Power Limit (dBm)	Pass / Fail
		Chain 0	Chain 1				
52	5260	16.61	16.11	86.646	19.38	22.70	Pass
60	5300	16.56	16.37	88.641	19.48	22.70	Pass
64	5320	16.42	16.28	86.315	19.36	22.70	Pass
100	5500	15.54	16.19	77.401	18.89	22.70	Pass
116	5580	15.64	15.51	72.207	18.59	22.70	Pass
140	5700	17.71	16.97	108.794	20.37	22.70	Pass
144	5720 For U-NII-2C	16.23	15.83	80.258	19.04	21.55	Pass
144	5720 For U-NII-3	11.54	11.15	27.288	14.36	28.70	Pass

Note:

- 5260~5320MHz gain = 7.3dBi > 6dBi, so the power limit shall be reduced to $24-(7.3-6) = 22.70\text{dBm}$.
- 5500~5700MHz gain = 7.3dBi > 6dBi, so the power limit shall be reduced to $24-(7.3-6) = 22.70\text{dBm}$.
- 5720MHz gain = 7.3dBi > 6dBi, so the power limit shall be reduced to $22.85-(7.3-6) = 21.55\text{dBm}$.
- 5745~5825MHz gain = 7.3dBi > 6dBi, so the power limit shall be reduced to $30-(7.3-6) = 28.70\text{dBm}$.

For U-NII-2A, U-NII-2C Band:

Chain 0

- $11\text{dBm} + 10\log (20.66) = 24.15 \text{ dBm} > 24\text{dBm}$
- $11\text{dBm} + 10\log (20.60) = 24.14 \text{ dBm} > 24\text{dBm}$
- $11\text{dBm} + 10\log (20.60) = 24.14 \text{ dBm} > 24\text{dBm}$
- $11\text{dBm} + 10\log (20.49) = 24.12 \text{ dBm} > 24\text{dBm}$
- $11\text{dBm} + 10\log (20.59) = 24.14 \text{ dBm} > 24\text{dBm}$
- $11\text{dBm} + 10\log (20.47) = 24.11 \text{ dBm} > 24\text{dBm}$
- $11\text{dBm} + 10\log (5725.00 - 5709.63) = 22.87 \text{ dBm} < 24\text{dBm}$

Chain 1

- $11\text{dBm} + 10\log (20.56) = 24.13 \text{ dBm} > 24\text{dBm}$
- $11\text{dBm} + 10\log (20.51) = 24.12 \text{ dBm} > 24\text{dBm}$
- $11\text{dBm} + 10\log (20.45) = 24.11 \text{ dBm} > 24\text{dBm}$
- $11\text{dBm} + 10\log (20.39) = 24.09 \text{ dBm} > 24\text{dBm}$
- $11\text{dBm} + 10\log (20.64) = 24.15 \text{ dBm} > 24\text{dBm}$
- $11\text{dBm} + 10\log (20.57) = 24.13 \text{ dBm} > 24\text{dBm}$
- $11\text{dBm} + 10\log (5725.00 - 5709.70) = 22.85 \text{ dBm} < 24\text{dBm}$

802.11n (HT40)

Chan.	Freq. (MHz)	Maximum Conducted Power (dBm)		Total Power (mW)	Total Power (dBm)	Power Limit (dBm)	Pass / Fail
		Chain 0	Chain 1				
54	5270	19.29	18.77	160.254	22.05	22.70	Pass
62	5310	18.04	17.64	121.756	20.85	22.70	Pass
102	5510	18.06	18.58	136.084	21.34	22.70	Pass
110	5550	18.06	18.27	131.116	21.18	22.70	Pass
134	5670	19.02	18.51	150.757	21.78	22.70	Pass
142	5710 For U-NII-2C	18.92	18.33	146.060	21.65	22.70	Pass
142	5710 For U-NII-3	10.70	10.03	21.818	13.39	28.70	Pass

Note:

- 5260~5320MHz gain = 7.3dBi > 6dBi, so the power limit shall be reduced to 24-(7.3-6) = 22.70dBm.
- 5500~5720MHz gain = 7.3dBi > 6dBi, so the power limit shall be reduced to 24-(7.3-6) = 22.70dBm.
- 5745~5825MHz gain = 7.3dBi > 6dBi, so the power limit shall be reduced to 30-(7.3-6) = 28.70dBm.

For U-NII-2A, U-NII-2C Band:

Chain 0

- 11dBm + 10log (40.90) = 27.12 dBm > 24dBm
- 11dBm + 10log (40.98) = 27.13 dBm > 24dBm
- 11dBm + 10log (41.14) = 27.14 dBm > 24dBm
- 11dBm + 10log (41.13) = 27.14 dBm > 24dBm
- 11dBm + 10log (40.79) = 27.11 dBm > 24dBm
- 11dBm + 10log (5725.00 - 5689.47) = 26.51 dBm > 24dBm

Chain 1

- 11dBm + 10log (40.72) = 27.10 dBm > 24dBm
- 11dBm + 10log (40.55) = 27.08 dBm > 24dBm
- 11dBm + 10log (40.46) = 27.07 dBm > 24dBm
- 11dBm + 10log (40.76) = 27.10 dBm > 24dBm
- 11dBm + 10log (49.40) = 27.94 dBm > 24dBm
- 11dBm + 10log (5725.00 - 5689.52) = 26.50 dBm > 24dBm

802.11ac (VHT80)

Chan.	Freq. (MHz)	Maximum Conducted Power (dBm)		Total Power (mW)	Total Power (dBm)	Power Limit (dBm)	Pass / Fail
		Chain 0	Chain 1				
58	5290	17.39	16.14	95.943	19.82	22.70	Pass
106	5530	16.42	15.99	83.572	19.22	22.70	Pass
122	5610	19.79	19.13	177.126	22.48	22.70	Pass
138	5690 For U-NII-2C	19.15	18.72	156.697	21.95	22.70	Pass
138	5690 For U-NII-3	8.73	8.11	13.935	11.44	28.70	Pass

Note:

- 5260~5320MHz gain = 7.3dBi > 6dBi, so the power limit shall be reduced to $24 - (7.3 - 6) = 22.70\text{dBm}$.
- 5500~5720MHz gain = 7.3dBi > 6dBi, so the power limit shall be reduced to $24 - (7.3 - 6) = 22.70\text{dBm}$.
- 5745~5825MHz gain = 7.3dBi > 6dBi, so the power limit shall be reduced to $30 - (7.3 - 6) = 28.70\text{dBm}$.

For U-NII-2A, U-NII-2C Band:

Chain 0

- $11\text{dBm} + 10\log (84.14) = 30.25 \text{ dBm} > 24\text{dBm}$
- $11\text{dBm} + 10\log (84.10) = 30.25 \text{ dBm} > 24\text{dBm}$
- $11\text{dBm} + 10\log (83.90) = 30.24 \text{ dBm} > 24\text{dBm}$
- $11\text{dBm} + 10\log (5725.00 - 5648.14) = 29.86 \text{ dBm} > 24\text{dBm}$

Chain 1

- $11\text{dBm} + 10\log (83.47) = 30.22 \text{ dBm} > 24\text{dBm}$
- $11\text{dBm} + 10\log (83.56) = 30.22 \text{ dBm} > 24\text{dBm}$
- $11\text{dBm} + 10\log (103.53) = 31.15 \text{ dBm} > 24\text{dBm}$
- $11\text{dBm} + 10\log (5725.00 - 5648.39) = 29.84 \text{ dBm} > 24\text{dBm}$

Beamforming Mode

802.11n (HT20)

Chan.	Freq. (MHz)	Maximum Conducted Power (dBm)		Total Power (mW)	Total Power (dBm)	Power Limit (dBm)	Pass / Fail
		Chain 0	Chain 1				
52	5260	13.60	13.10	43.351	16.37	19.69	Pass
60	5300	13.55	13.36	44.361	16.47	19.69	Pass
64	5320	13.41	13.27	43.152	16.35	19.69	Pass
100	5500	12.53	13.18	38.726	15.88	19.69	Pass
116	5580	12.63	12.50	36.141	15.58	19.69	Pass
140	5700	14.70	13.96	54.450	17.36	19.69	Pass
144	5720 For U-NII-2C	13.22	12.82	40.087	16.03	18.54	Pass
144	5720 For U-NII-3	8.53	8.14	13.646	11.35	25.69	Pass

Note:

- 5260~5320MHz directional gain = $7.3\text{dBi} + 10\log(2) = 10.31\text{dBi} > 6\text{dBi}$, so the power limit shall be reduced to $24 - (10.31 - 6) = 19.69\text{dBm}$.
- 5500~5700MHz directional gain = $7.3\text{dBi} + 10\log(2) = 10.31\text{dBi} > 6\text{dBi}$, so the power limit shall be reduced to $24 - (10.31 - 6) = 19.69\text{dBm}$.
- 5720MHz directional gain = $7.3\text{dBi} + 10\log(2) = 10.31\text{dBi} > 6\text{dBi}$, so the power limit shall be reduced to $22.85 - (10.31 - 6) = 18.54\text{dBm}$.
- 5745~5825MHz directional gain = $7.3\text{dBi} + 10\log(2) = 10.31\text{dBi} > 6\text{dBi}$, so the power limit shall be reduced to $30 - (10.31 - 6) = 25.69\text{dBm}$.

For U-NII-2A, U-NII-2C Band:

Chain 0

- $11\text{dBm} + 10\log (20.66) = 24.15 \text{ dBm} > 24\text{dBm}$
- $11\text{dBm} + 10\log (20.60) = 24.14 \text{ dBm} > 24\text{dBm}$
- $11\text{dBm} + 10\log (20.60) = 24.14 \text{ dBm} > 24\text{dBm}$
- $11\text{dBm} + 10\log (20.49) = 24.12 \text{ dBm} > 24\text{dBm}$
- $11\text{dBm} + 10\log (20.59) = 24.14 \text{ dBm} > 24\text{dBm}$
- $11\text{dBm} + 10\log (20.47) = 24.11 \text{ dBm} > 24\text{dBm}$
- $11\text{dBm} + 10\log (5725.00 - 5709.63) = 22.87 \text{ dBm} < 24\text{dBm}$

Chain 1

- $11\text{dBm} + 10\log (20.56) = 24.13 \text{ dBm} > 24\text{dBm}$
- $11\text{dBm} + 10\log (20.51) = 24.12 \text{ dBm} > 24\text{dBm}$
- $11\text{dBm} + 10\log (20.45) = 24.11 \text{ dBm} > 24\text{dBm}$
- $11\text{dBm} + 10\log (20.39) = 24.09 \text{ dBm} > 24\text{dBm}$
- $11\text{dBm} + 10\log (20.64) = 24.15 \text{ dBm} > 24\text{dBm}$
- $11\text{dBm} + 10\log (20.57) = 24.13 \text{ dBm} > 24\text{dBm}$
- $11\text{dBm} + 10\log (5725.00 - 5709.70) = 22.85 \text{ dBm} < 24\text{dBm}$

802.11n (HT40)

Chan.	Freq. (MHz)	Maximum Conducted Power (dBm)		Total Power (mW)	Total Power (dBm)	Power Limit (dBm)	Pass / Fail
		Chain 0	Chain 1				
54	5270	16.28	15.76	80.168	19.04	19.69	Pass
62	5310	15.03	14.63	60.814	17.84	19.69	Pass
102	5510	15.05	15.57	68.077	18.33	19.69	Pass
110	5550	15.05	15.26	65.615	18.17	19.69	Pass
134	5670	16.01	15.50	75.336	18.77	19.69	Pass
142	5710 For U-NII-2C	15.91	15.32	73.114	18.64	19.69	Pass
142	5710 For U-NII-3	7.69	7.02	10.914	10.38	25.69	Pass

Note:

- 5260~5320MHz directional gain = 7.3dBi + 10log(2) = 10.31dBi > 6dBi, so the power limit shall be reduced to 24-(10.31-6) = 19.69dBm.
- 5500~5720MHz directional gain = 7.3dBi + 10log(2) = 10.31dBi > 6dBi, so the power limit shall be reduced to 24-(10.31-6) = 19.69dBm.
- 5745~5825MHz directional gain = 7.3dBi + 10log(2) = 10.31dBi > 6dBi, so the power limit shall be reduced to 30-(10.31-6) = 25.69dBm.

For U-NII-2A, U-NII-2C Band:

Chain 0

- 11dBm + 10log (40.90) = 27.12 dBm > 24dBm
- 11dBm + 10log (40.98) = 27.13 dBm > 24dBm
- 11dBm + 10log (41.14) = 27.14 dBm > 24dBm
- 11dBm + 10log (41.13) = 27.14 dBm > 24dBm
- 11dBm + 10log (40.79) = 27.11 dBm > 24dBm
- 11dBm + 10log (5725.00 - 5689.47) = 26.51 dBm > 24dBm

Chain 1

- 11dBm + 10log (40.72) = 27.10 dBm > 24dBm
- 11dBm + 10log (40.55) = 27.08 dBm > 24dBm
- 11dBm + 10log (40.46) = 27.07 dBm > 24dBm
- 11dBm + 10log (40.76) = 27.10 dBm > 24dBm
- 11dBm + 10log (49.40) = 27.94 dBm > 24dBm
- 11dBm + 10log (5725.00 - 5689.52) = 26.50 dBm > 24dBm

802.11ac (VHT80)

Chan.	Freq. (MHz)	Maximum Conducted Power (dBm)		Total Power (mW)	Total Power (dBm)	Power Limit (dBm)	Pass / Fail
		Chain 0	Chain 1				
58	5290	14.38	13.13	47.973	16.81	19.69	Pass
106	5530	13.41	12.98	41.783	16.21	19.69	Pass
122	5610	16.78	16.12	88.512	19.47	19.69	Pass
138	5690 For U-NII-2C	16.14	15.71	78.343	18.94	19.69	Pass
138	5690 For U-NII-3	5.72	5.10	6.966	8.43	25.69	Pass

Note:

- 5260~5320MHz directional gain = $7.3\text{dBi} + 10\log(2) = 10.31\text{dBi} > 6\text{dBi}$, so the power limit shall be reduced to $24 - (10.31 - 6) = 19.69\text{dBm}$.
- 5500~5720MHz directional gain = $7.3\text{dBi} + 10\log(2) = 10.31\text{dBi} > 6\text{dBi}$, so the power limit shall be reduced to $24 - (10.31 - 6) = 19.69\text{dBm}$.
- 5745~5825MHz directional gain = $7.3\text{dBi} + 10\log(2) = 10.31\text{dBi} > 6\text{dBi}$, so the power limit shall be reduced to $30 - (10.31 - 6) = 25.69\text{dBm}$.

For U-NII-2A, U-NII-2C Band:

Chain 0

- $11\text{dBm} + 10\log(84.14) = 30.25\text{ dBm} > 24\text{dBm}$
- $11\text{dBm} + 10\log(84.10) = 30.25\text{ dBm} > 24\text{dBm}$
- $11\text{dBm} + 10\log(83.90) = 30.24\text{ dBm} > 24\text{dBm}$
- $11\text{dBm} + 10\log(5725.00 - 5648.14) = 29.86\text{ dBm} > 24\text{dBm}$

Chain 1

- $11\text{dBm} + 10\log(83.47) = 30.22\text{ dBm} > 24\text{dBm}$
- $11\text{dBm} + 10\log(83.56) = 30.22\text{ dBm} > 24\text{dBm}$
- $11\text{dBm} + 10\log(103.53) = 31.15\text{ dBm} > 24\text{dBm}$
- $11\text{dBm} + 10\log(5725.00 - 5648.39) = 29.84\text{ dBm} > 24\text{dBm}$

26dB Bandwidth:

802.11a

Chan.	Freq. (MHz)	26dBc Bandwidth (MHz)	
		Chain 0	Chain 1
52	5260	19.53	19.11
60	5300	19.55	19.18
64	5320	19.45	19.17
100	5500	19.56	19.00
116	5580	19.56	19.29
140	5700	19.58	19.33
144	5720 For U-NII-2C	14.91	14.68
144	5720 For U-NII-3	4.69	4.46

802.11n (HT20)

Chan.	Freq. (MHz)	26dBc Bandwidth (MHz)	
		Chain 0	Chain 1
52	5260	20.66	20.56
60	5300	20.60	20.51
64	5320	20.60	20.45
100	5500	20.49	20.39
116	5580	20.59	20.64
140	5700	20.47	20.57
144	5720 For U-NII-2C	15.37	15.30
144	5720 For U-NII-3	5.22	5.21

802.11n (HT40)

Chan.	Freq. (MHz)	26dBc Bandwidth (MHz)	
		Chain 0	Chain 1
54	5270	40.90	40.72
62	5310	40.98	40.55
102	5510	41.14	40.46
110	5550	41.13	40.76
134	5670	40.79	49.40
142	5710 For U-NII-2C	35.53	35.48
142	5710 For U-NII-3	5.35	5.24

802.11ac (VHT80)

Chan.	Freq. (MHz)	26dBc Bandwidth (MHz)	
		Chain 0	Chain 1
58	5290	84.14	83.47
106	5530	84.10	83.56
122	5610	83.90	103.53
138	5690 For U-NII-2C	76.86	76.61
138	5690 For U-NII-3	6.98	6.66

Spectrum Plot of Worst Value

802.11a

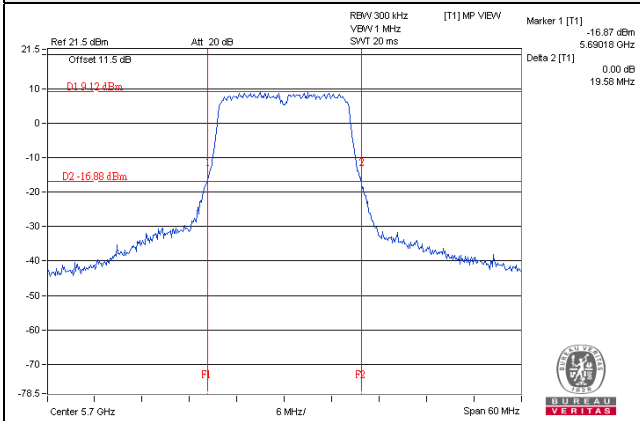

802.11n (HT20)

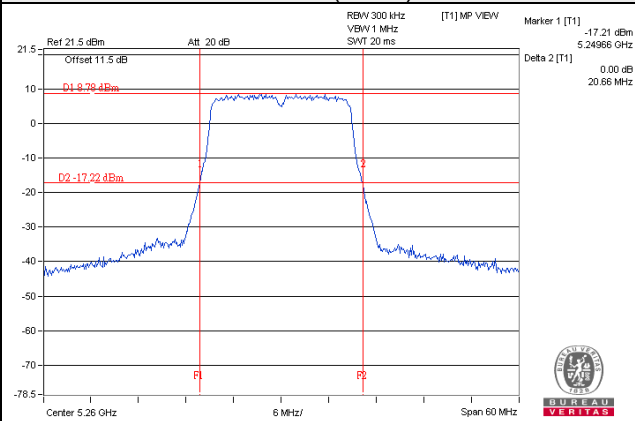

802.11n (HT40)

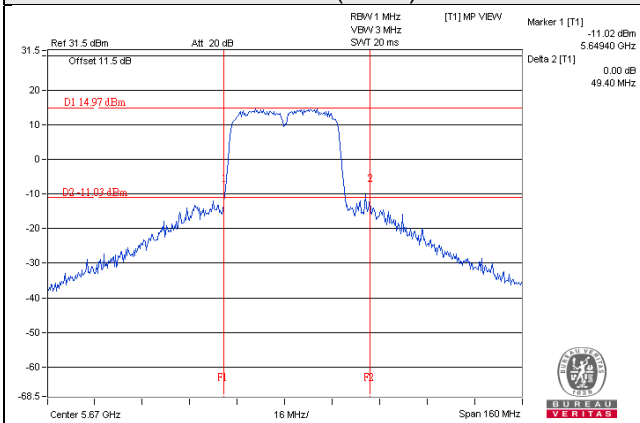

802.11ac (VHT80)

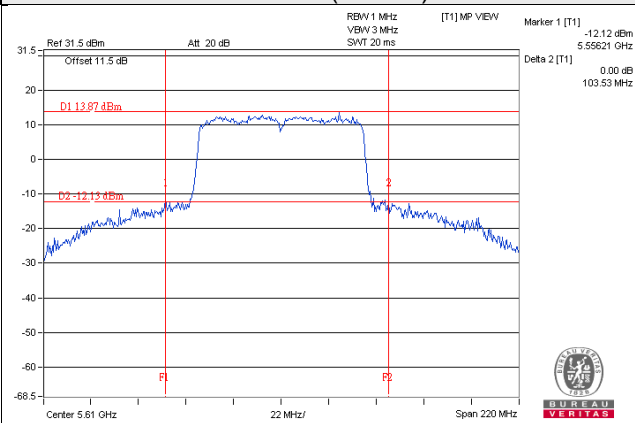

EUT Maximum Conducted Power

CDD Mode

802.11a

Frequency Band (MHz)	Max. Power	
	Output Power (mW)	Output Power (dBm)
5250~5350	88.874	19.49
5470~5725	98.734	19.94

802.11n (HT20)

Frequency Band (MHz)	Max. Power	
	Output Power (mW)	Output Power (dBm)
5250~5350	88.641	19.48
5470~5725	108.794	20.37

802.11n (HT40)

Frequency Band (MHz)	Max. Power	
	Output Power (mW)	Output Power (dBm)
5250~5350	160.254	22.05
5470~5725	150.757	21.78

802.11ac (VHT80)

Frequency Band (MHz)	Max. Power	
	Output Power (mW)	Output Power (dBm)
5250~5350	95.943	19.82
5470~5725	177.126	22.48

Beamforming Mode

802.11n (HT20)

Frequency Band (MHz)	Max. Power	
	Output Power (mW)	Output Power (dBm)
5250~5350	44.361	16.47
5470~5725	54.450	17.36

802.11n (HT40)

Frequency Band (MHz)	Max. Power	
	Output Power (mW)	Output Power (dBm)
5250~5350	80.168	19.04
5470~5725	75.336	18.77

802.11ac (VHT80)

Frequency Band (MHz)	Max. Power	
	Output Power (mW)	Output Power (dBm)
5250~5350	47.973	16.81
5470~5725	88.512	19.47

Test Mode E

Power Output:

CDD Mode

802.11a

Chan.	Freq. (MHz)	Maximum Conducted Power (dBm)		Total Power (mW)	Total Power (dBm)	Power Limit (dBm)	Pass / Fail
		Chain 0	Chain 1				
52	5260	17.22	16.96	102.382	20.10	23.97	Pass
60	5300	17.49	16.89	104.970	20.21	23.99	Pass
64	5320	17.65	17.11	109.614	20.40	23.99	Pass
100	5500	16.02	15.68	76.977	18.86	23.94	Pass
116	5580	15.96	15.51	75.009	18.75	23.88	Pass
140	5700	17.60	16.85	105.961	20.25	23.86	Pass
144	5720 For U-NII-2C	12.68	12.45	82.055	19.14	22.67	Pass
144	5720 For U-NII-3	6.34	6.26	25.370	14.04	30.00	Pass

Note:

For U-NII-2A, U-NII-2C Band:

Chain 0

1. $11\text{dBm} + 10\log (19.80) = 23.97 \text{ dBm} < 24\text{dBm}$
2. $11\text{dBm} + 10\log (19.89) = 23.99 \text{ dBm} < 24\text{dBm}$
3. $11\text{dBm} + 10\log (19.91) = 23.99 \text{ dBm} < 24\text{dBm}$
4. $11\text{dBm} + 10\log (19.69) = 23.94 \text{ dBm} < 24\text{dBm}$
5. $11\text{dBm} + 10\log (19.43) = 23.88 \text{ dBm} < 24\text{dBm}$
6. $11\text{dBm} + 10\log (19.53) = 23.91 \text{ dBm} < 24\text{dBm}$
7. $11\text{dBm} + 10\log (5725.00 - 5710.09) = 22.73 \text{ dBm} < 24\text{dBm}$

Chain 1

1. $11\text{dBm} + 10\log (20.10) = 24.03 \text{ dBm} > 24\text{dBm}$
2. $11\text{dBm} + 10\log (21.07) = 24.24 \text{ dBm} > 24\text{dBm}$
3. $11\text{dBm} + 10\log (20.17) = 24.05 \text{ dBm} > 24\text{dBm}$
4. $11\text{dBm} + 10\log (19.87) = 23.98 \text{ dBm} < 24\text{dBm}$
5. $11\text{dBm} + 10\log (19.42) = 23.88 \text{ dBm} < 24\text{dBm}$
6. $11\text{dBm} + 10\log (19.33) = 23.86 \text{ dBm} < 24\text{dBm}$
7. $11\text{dBm} + 10\log (5725.00 - 5710.32) = 22.67 \text{ dBm} < 24\text{dBm}$

802.11n (HT20)

Chan.	Freq. (MHz)	Maximum Conducted Power (dBm)		Total Power (mW)	Total Power (dBm)	Power Limit (dBm)	Pass / Fail
		Chain 0	Chain 1				
52	5260	18.06	17.55	120.858	20.82	24.00	Pass
60	5300	18.08	17.49	120.374	20.81	24.00	Pass
64	5320	18.10	17.52	121.059	20.83	24.00	Pass
100	5500	16.49	16.17	85.966	19.34	24.00	Pass
116	5580	16.48	15.84	82.834	19.18	24.00	Pass
140	5700	18.69	17.83	134.635	21.29	24.00	Pass
144	5720 For U-NII-2C	16.23	15.83	80.258	19.04	22.85	Pass
144	5720 For U-NII-3	11.54	11.15	27.288	14.36	30.00	Pass

Note:

For U-NII-2A, U-NII-2C Band:

Chain 0

1. $11\text{dBm} + 10\log (20.66) = 24.15 \text{ dBm} > 24\text{dBm}$
2. $11\text{dBm} + 10\log (20.60) = 24.14 \text{ dBm} > 24\text{dBm}$
3. $11\text{dBm} + 10\log (20.60) = 24.14 \text{ dBm} > 24\text{dBm}$
4. $11\text{dBm} + 10\log (20.49) = 24.12 \text{ dBm} > 24\text{dBm}$
5. $11\text{dBm} + 10\log (20.59) = 24.14 \text{ dBm} > 24\text{dBm}$
6. $11\text{dBm} + 10\log (20.47) = 24.11 \text{ dBm} > 24\text{dBm}$
7. $11\text{dBm} + 10\log (5725.00 - 5709.63) = 22.87 \text{ dBm} < 24\text{dBm}$

Chain 1

1. $11\text{dBm} + 10\log (20.56) = 24.13 \text{ dBm} > 24\text{dBm}$
2. $11\text{dBm} + 10\log (20.51) = 24.12 \text{ dBm} > 24\text{dBm}$
3. $11\text{dBm} + 10\log (20.45) = 24.11 \text{ dBm} > 24\text{dBm}$
4. $11\text{dBm} + 10\log (20.39) = 24.09 \text{ dBm} > 24\text{dBm}$
5. $11\text{dBm} + 10\log (20.64) = 24.15 \text{ dBm} > 24\text{dBm}$
6. $11\text{dBm} + 10\log (20.57) = 24.13 \text{ dBm} > 24\text{dBm}$
7. $11\text{dBm} + 10\log (5725.00 - 5709.70) = 22.85 \text{ dBm} < 24\text{dBm}$

802.11n (HT40)

Chan.	Freq. (MHz)	Maximum Conducted Power (dBm)		Total Power (mW)	Total Power (dBm)	Power Limit (dBm)	Pass / Fail
		Chain 0	Chain 1				
54	5270	19.57	19.08	171.483	22.34	24.00	Pass
62	5310	18.04	17.64	121.756	20.85	24.00	Pass
102	5510	17.96	17.88	123.893	20.93	24.00	Pass
110	5550	19.53	19.22	173.303	22.39	24.00	Pass
134	5670	19.55	19.08	171.067	22.33	24.00	Pass
142	5710 For U-NII-2C	18.92	18.33	146.060	21.65	24.00	Pass
142	5710 For U-NII-3	10.70	10.03	21.818	13.39	30.00	Pass

Note:

For U-NII-2A, U-NII-2C Band:

Chain 0

1. $11\text{dBm} + 10\log (40.98) = 27.13 \text{ dBm} > 24\text{dBm}$
2. $11\text{dBm} + 10\log (40.98) = 27.13 \text{ dBm} > 24\text{dBm}$
3. $11\text{dBm} + 10\log (41.05) = 27.13 \text{ dBm} > 24\text{dBm}$
4. $11\text{dBm} + 10\log (41.05) = 27.13 \text{ dBm} > 24\text{dBm}$
5. $11\text{dBm} + 10\log (41.33) = 27.16 \text{ dBm} > 24\text{dBm}$
6. $11\text{dBm} + 10\log (5725.00 - 5689.47) = 26.51 \text{ dBm} > 24\text{dBm}$

Chain 1

1. $11\text{dBm} + 10\log (41.09) = 27.14 \text{ dBm} > 24\text{dBm}$
2. $11\text{dBm} + 10\log (40.55) = 27.08 \text{ dBm} > 24\text{dBm}$
3. $11\text{dBm} + 10\log (40.97) = 27.12 \text{ dBm} > 24\text{dBm}$
4. $11\text{dBm} + 10\log (61.71) = 28.90 \text{ dBm} > 24\text{dBm}$
5. $11\text{dBm} + 10\log (40.86) = 27.11 \text{ dBm} > 24\text{dBm}$
6. $11\text{dBm} + 10\log (5725.00 - 5689.52) = 26.50 \text{ dBm} > 24\text{dBm}$

802.11ac (VHT80)

Chan.	Freq. (MHz)	Maximum Conducted Power (dBm)		Total Power (mW)	Total Power (dBm)	Power Limit (dBm)	Pass / Fail
		Chain 0	Chain 1				
58	5290	17.39	16.14	95.943	19.82	24.00	Pass
106	5530	16.42	15.99	83.572	19.22	24.00	Pass
122	5610	19.79	19.13	177.126	22.48	24.00	Pass
138	5690 For U-NII-2C	19.15	18.72	156.697	21.95	24.00	Pass
138	5690 For U-NII-3	8.73	8.11	13.935	11.44	30.00	Pass

Note:

For U-NII-2A, U-NII-2C Band:

Chain 0

1. $11\text{dBm} + 10\log (84.14) = 30.25 \text{ dBm} > 24\text{dBm}$
2. $11\text{dBm} + 10\log (84.10) = 30.25 \text{ dBm} > 24\text{dBm}$
3. $11\text{dBm} + 10\log (83.90) = 30.24 \text{ dBm} > 24\text{dBm}$
4. $11\text{dBm} + 10\log (5725.00 - 5648.14) = 29.86 \text{ dBm} > 24\text{dBm}$

Chain 1

1. $11\text{dBm} + 10\log (83.47) = 30.22 \text{ dBm} > 24\text{dBm}$
2. $11\text{dBm} + 10\log (83.56) = 30.22 \text{ dBm} > 24\text{dBm}$
3. $11\text{dBm} + 10\log (103.53) = 31.15 \text{ dBm} > 24\text{dBm}$
4. $11\text{dBm} + 10\log (5725.00 - 5648.39) = 29.84 \text{ dBm} > 24\text{dBm}$

Beamforming Mode

802.11n (HT20)

Chan.	Freq. (MHz)	Maximum Conducted Power (dBm)		Total Power (mW)	Total Power (dBm)	Power Limit (dBm)	Pass / Fail
		Chain 0	Chain 1				
52	5260	15.05	14.54	60.395	17.81	20.99	Pass
60	5300	15.07	14.48	60.256	17.80	20.99	Pass
64	5320	15.09	14.51	60.534	17.82	20.99	Pass
100	5500	13.48	13.16	42.954	16.33	20.99	Pass
116	5580	13.47	12.83	41.400	16.17	20.99	Pass
140	5700	15.68	14.82	67.298	18.28	20.99	Pass
144	5720 For U-NII-2C	13.22	12.82	40.087	16.03	19.84	Pass
144	5720 For U-NII-3	8.53	8.14	13.646	11.35	26.99	Pass

Note:

- 5260~5320MHz directional gain = $6\text{dBi} + 10\log(2) = 9.01\text{dBi} > 6\text{dBi}$, so the power limit shall be reduced to $24 - (9.01 - 6) = 20.99\text{dBm}$.
- 5500~5700MHz directional gain = $6\text{dBi} + 10\log(2) = 9.01\text{dBi} > 6\text{dBi}$, so the power limit shall be reduced to $24 - (9.01 - 6) = 20.99\text{dBm}$.
- 5720MHz directional gain = $6\text{dBi} + 10\log(2) = 9.01\text{dBi} > 6\text{dBi}$, so the power limit shall be reduced to $22.85 - (9.01 - 6) = 19.84\text{dBm}$.
- 5745~5825MHz directional gain = $6\text{dBi} + 10\log(2) = 9.01\text{dBi} > 6\text{dBi}$, so the power limit shall be reduced to $30 - (9.01 - 6) = 26.99\text{dBm}$.

For U-NII-2A, U-NII-2C Band:

Chain 0

- $11\text{dBm} + 10\log (20.66) = 24.15 \text{ dBm} > 24\text{dBm}$
- $11\text{dBm} + 10\log (20.60) = 24.14 \text{ dBm} > 24\text{dBm}$
- $11\text{dBm} + 10\log (20.60) = 24.14 \text{ dBm} > 24\text{dBm}$
- $11\text{dBm} + 10\log (20.49) = 24.12 \text{ dBm} > 24\text{dBm}$
- $11\text{dBm} + 10\log (20.59) = 24.14 \text{ dBm} > 24\text{dBm}$
- $11\text{dBm} + 10\log (20.47) = 24.11 \text{ dBm} > 24\text{dBm}$
- $11\text{dBm} + 10\log (5725.00 - 5709.63) = 22.87 \text{ dBm} < 24\text{dBm}$

Chain 1

- $11\text{dBm} + 10\log (20.56) = 24.13 \text{ dBm} > 24\text{dBm}$
- $11\text{dBm} + 10\log (20.51) = 24.12 \text{ dBm} > 24\text{dBm}$
- $11\text{dBm} + 10\log (20.45) = 24.11 \text{ dBm} > 24\text{dBm}$
- $11\text{dBm} + 10\log (20.39) = 24.09 \text{ dBm} > 24\text{dBm}$
- $11\text{dBm} + 10\log (20.64) = 24.15 \text{ dBm} > 24\text{dBm}$
- $11\text{dBm} + 10\log (20.57) = 24.13 \text{ dBm} > 24\text{dBm}$
- $11\text{dBm} + 10\log (5725.00 - 5709.70) = 22.85 \text{ dBm} < 24\text{dBm}$

802.11n (HT40)

Chan.	Freq. (MHz)	Maximum Conducted Power (dBm)		Total Power (mW)	Total Power (dBm)	Power Limit (dBm)	Pass / Fail
		Chain 0	Chain 1				
54	5270	16.56	16.07	85.704	19.33	20.99	Pass
62	5310	15.03	14.63	60.814	17.84	20.99	Pass
102	5510	14.95	14.87	61.944	17.92	20.99	Pass
110	5550	16.52	16.21	86.696	19.38	20.99	Pass
134	5670	16.54	16.07	85.507	19.32	20.99	Pass
142	5710 For U-NII-2C	15.91	15.32	73.114	18.64	20.99	Pass
142	5710 For U-NII-3	7.69	7.02	10.914	10.38	26.99	Pass

Note:

- 5260~5320MHz directional gain = $6\text{dBi} + 10\log(2) = 9.01\text{dBi} > 6\text{dBi}$, so the power limit shall be reduced to $24-(9.01-6) = 20.99\text{dBm}$.
- 5500~5720MHz directional gain = $6\text{dBi} + 10\log(2) = 9.01\text{dBi} > 6\text{dBi}$, so the power limit shall be reduced to $24-(9.01-6) = 20.99\text{dBm}$.
- 5745~5825MHz directional gain = $6\text{dBi} + 10\log(2) = 9.01\text{dBi} > 6\text{dBi}$, so the power limit shall be reduced to $30-(9.01-6) = 26.99\text{dBm}$.

For U-NII-2A, U-NII-2C Band:

Chain 0

- $11\text{dBm} + 10\log(40.98) = 27.13\text{ dBm} > 24\text{dBm}$
- $11\text{dBm} + 10\log(40.98) = 27.13\text{ dBm} > 24\text{dBm}$
- $11\text{dBm} + 10\log(41.05) = 27.13\text{ dBm} > 24\text{dBm}$
- $11\text{dBm} + 10\log(41.05) = 27.13\text{ dBm} > 24\text{dBm}$
- $11\text{dBm} + 10\log(41.33) = 27.16\text{ dBm} > 24\text{dBm}$
- $11\text{dBm} + 10\log(5725.00 - 5689.47) = 26.51\text{ dBm} > 24\text{dBm}$

Chain 1

- $11\text{dBm} + 10\log(41.09) = 27.14\text{ dBm} > 24\text{dBm}$
- $11\text{dBm} + 10\log(40.55) = 27.08\text{ dBm} > 24\text{dBm}$
- $11\text{dBm} + 10\log(40.97) = 27.12\text{ dBm} > 24\text{dBm}$
- $11\text{dBm} + 10\log(61.71) = 28.90\text{ dBm} > 24\text{dBm}$
- $11\text{dBm} + 10\log(40.86) = 27.11\text{ dBm} > 24\text{dBm}$
- $11\text{dBm} + 10\log(5725.00 - 5689.52) = 26.50\text{ dBm} > 24\text{dBm}$

802.11ac (VHT80)

Chan.	Freq. (MHz)	Maximum Conducted Power (dBm)		Total Power (mW)	Total Power (dBm)	Power Limit (dBm)	Pass / Fail
		Chain 0	Chain 1				
58	5290	14.38	13.13	47.973	16.81	20.99	Pass
106	5530	13.41	12.98	41.783	16.21	20.99	Pass
122	5610	16.78	16.12	88.512	19.47	20.99	Pass
138	5690 For U-NII-2C	16.14	15.71	78.343	18.94	20.99	Pass
138	5690 For U-NII-3	5.72	5.10	6.966	8.43	26.99	Pass

Note:

- 5260~5320MHz directional gain = 6dBi + 10log(2) = 9.01dBi > 6dBi, so the power limit shall be reduced to 24-(9.01-6) = 20.99dBm.
- 5500~5720MHz directional gain = 6dBi + 10log(2) = 9.01dBi > 6dBi, so the power limit shall be reduced to 24-(9.01-6) = 20.99dBm.
- 5745~5825MHz directional gain = 6dBi + 10log(2) = 9.01dBi > 6dBi, so the power limit shall be reduced to 30-(9.01-6) = 26.99dBm.

For U-NII-2A, U-NII-2C Band:

Chain 0

- 11dBm + 10log (84.14) = 30.25 dBm > 24dBm
- 11dBm + 10log (84.10) = 30.25 dBm > 24dBm
- 11dBm + 10log (83.90) = 30.24 dBm > 24dBm
- 11dBm + 10log (5725.00 - 5648.14) = 29.86 dBm > 24dBm

Chain 1

- 11dBm + 10log (83.47) = 30.22 dBm > 24dBm
- 11dBm + 10log (83.56) = 30.22 dBm > 24dBm
- 11dBm + 10log (103.53) = 31.15 dBm > 24dBm
- 11dBm + 10log (5725.00 - 5648.39) = 29.84 dBm > 24dBm

26dB Bandwidth:

802.11a

Chan.	Freq. (MHz)	26dBc Bandwidth (MHz)	
		Chain 0	Chain 1
52	5260	19.80	20.10
60	5300	19.89	21.07
64	5320	19.91	20.17
100	5500	19.69	19.87
116	5580	19.43	19.42
140	5700	19.53	19.33
144	5720 For U-NII-2C	14.91	14.68
144	5720 For U-NII-3	4.69	4.46

802.11n (HT20)

Chan.	Freq. (MHz)	26dBc Bandwidth (MHz)	
		Chain 0	Chain 1
52	5260	20.66	20.56
60	5300	20.60	20.51
64	5320	20.60	20.45
100	5500	20.49	20.39
116	5580	20.59	20.64
140	5700	20.47	20.57
144	5720 For U-NII-2C	15.37	15.30
144	5720 For U-NII-3	5.22	5.21

802.11n (HT40)

Chan.	Freq. (MHz)	26dBc Bandwidth (MHz)	
		Chain 0	Chain 1
54	5270	40.98	41.09
62	5310	40.98	40.55
102	5510	41.05	40.97
110	5550	41.05	61.71
134	5670	41.33	40.86
142	5710 For U-NII-2C	35.53	35.48
142	5710 For U-NII-3	5.35	5.24

802.11ac (VHT80)

Chan.	Freq. (MHz)	26dBc Bandwidth (MHz)	
		Chain 0	Chain 1
58	5290	84.14	83.47
106	5530	84.10	83.56
122	5610	83.90	103.53
138	5690 For U-NII-2C	76.86	76.61
138	5690 For U-NII-3	6.98	6.66

Spectrum Plot of Worst Value

802.11a

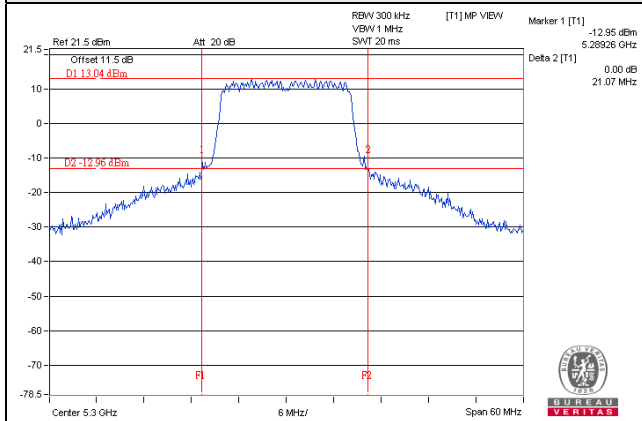

802.11n (HT20)

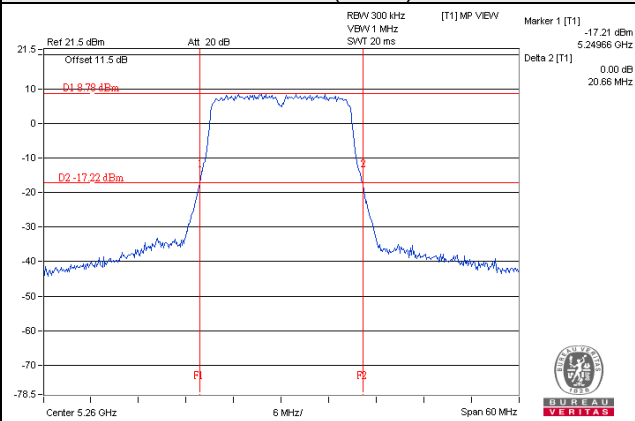

802.11n (HT40)

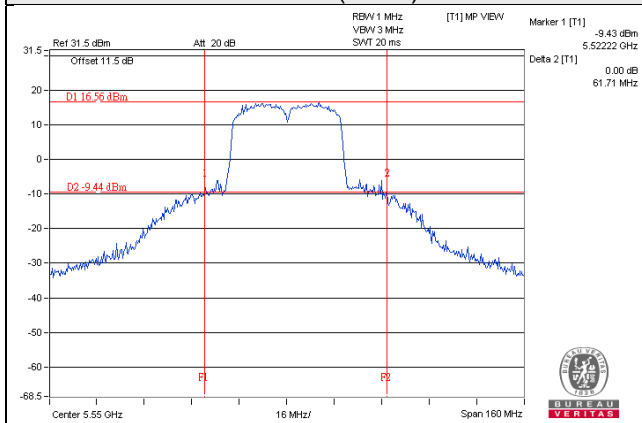

802.11ac (VHT80)

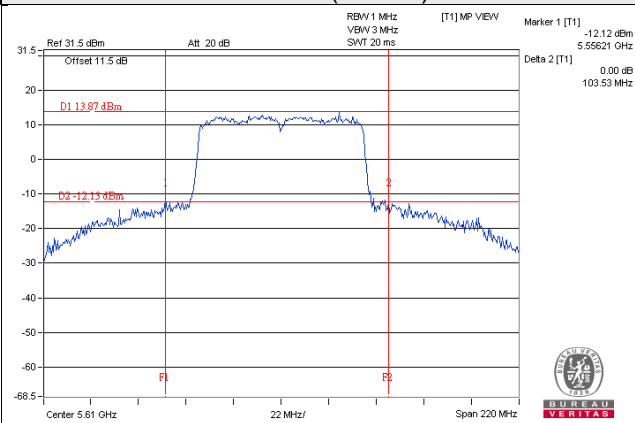

EUT Maximum Conducted Power

CDD Mode

802.11a

Frequency Band (MHz)	Max. Power	
	Output Power (mW)	Output Power (dBm)
5250~5350	109.614	20.40
5470~5725	105.961	20.25

802.11n (HT20)

Frequency Band (MHz)	Max. Power	
	Output Power (mW)	Output Power (dBm)
5250~5350	121.059	20.83
5470~5725	134.635	21.29

802.11n (HT40)

Frequency Band (MHz)	Max. Power	
	Output Power (mW)	Output Power (dBm)
5250~5350	171.483	22.34
5470~5725	173.303	22.39

802.11ac (VHT80)

Frequency Band (MHz)	Max. Power	
	Output Power (mW)	Output Power (dBm)
5250~5350	95.943	19.82
5470~5725	177.126	22.48

Beamforming Mode

802.11n (HT20)

Frequency Band (MHz)	Max. Power	
	Output Power (mW)	Output Power (dBm)
5250~5350	60.534	17.82
5470~5725	67.298	18.28

802.11n (HT40)

Frequency Band (MHz)	Max. Power	
	Output Power (mW)	Output Power (dBm)
5250~5350	85.704	19.33
5470~5725	86.696	19.38

802.11ac (VHT80)

Frequency Band (MHz)	Max. Power	
	Output Power (mW)	Output Power (dBm)
5250~5350	47.973	16.81
5470~5725	88.512	19.47

Test Mode G

Power Output:

CDD Mode

802.11a

Chan.	Freq. (MHz)	Maximum Conducted Power (dBm)		Total Power (mW)	Total Power (dBm)	Power Limit (dBm)	Pass / Fail
		Chain 0	Chain 1				
52	5260	15.46	14.93	66.273	18.21	19.14	Pass
60	5300	15.19	15.18	65.998	18.20	19.15	Pass
64	5320	15.63	15.57	72.617	18.61	19.17	Pass
100	5500	15.25	16.13	74.517	18.72	19.12	Pass
116	5580	15.39	15.52	70.239	18.47	19.17	Pass
140	5700	15.57	14.79	66.188	18.21	19.15	Pass
144	5720 For U-NII-2C	14.69	13.42	51.423	17.11	17.94	Pass
144	5720 For U-NII-3	9.71	8.27	16.068	12.06	25.30	Pass

Note:

- 5260MHz gain = 10.7dBi > 6dBi, so the power limit shall be reduced to 23.84-(10.7-6) = 19.14dBm.
- 5300MHz gain = 10.7dBi > 6dBi, so the power limit shall be reduced to 23.85-(10.7-6) = 19.15dBm.
- 5320MHz gain = 10.7dBi > 6dBi, so the power limit shall be reduced to 23.87-(10.7-6) = 19.17dBm.
- 5500MHz gain = 10.7dBi > 6dBi, so the power limit shall be reduced to 23.82-(10.7-6) = 19.12dBm.
- 5580MHz gain = 10.7dBi > 6dBi, so the power limit shall be reduced to 23.87-(10.7-6) = 19.17dBm.
- 5700MHz gain = 10.7dBi > 6dBi, so the power limit shall be reduced to 23.85-(10.7-6) = 19.15dBm.
- 5720MHz gain = 10.7dBi > 6dBi, so the power limit shall be reduced to 22.64-(10.7-6) = 17.94dBm.
- 5745~5825MHz gain = 10.7dBi > 6dBi, so the power limit shall be reduced to 30-(10.7-6) = 25.30dBm.

For U-NII-2A, U-NII-2C Band:

Chain 0

- 11dBm + 10log (19.48) = 23.90 dBm < 24dBm
- 11dBm + 10log (19.62) = 23.93 dBm < 24dBm
- 11dBm + 10log (19.41) = 23.88 dBm < 24dBm
- 11dBm + 10log (19.46) = 23.89 dBm < 24dBm
- 11dBm + 10log (19.36) = 23.87 dBm < 24dBm
- 11dBm + 10log (19.48) = 23.90 dBm < 24dBm
- 11dBm + 10log (5725.00 - 5710.15) = 22.72 dBm < 24dBm

Chain 1

- 11dBm + 10log (19.24) = 23.84 dBm < 24dBm
- 11dBm + 10log (19.29) = 23.85 dBm < 24dBm
- 11dBm + 10log (19.37) = 23.87 dBm < 24dBm
- 11dBm + 10log (19.14) = 23.82 dBm < 24dBm
- 11dBm + 10log (19.44) = 23.89 dBm < 24dBm
- 11dBm + 10log (19.28) = 23.85 dBm < 24dBm
- 11dBm + 10log (5725.00 - 5710.41) = 22.64 dBm < 24dBm

802.11n (HT20)

Chan.	Freq. (MHz)	Maximum Conducted Power (dBm)		Total Power (mW)	Total Power (dBm)	Power Limit (dBm)	Pass / Fail
		Chain 0	Chain 1				
52	5260	15.93	15.63	75.733	18.79	19.30	Pass
60	5300	15.87	15.81	76.744	18.85	19.30	Pass
64	5320	15.71	15.74	74.736	18.74	19.30	Pass
100	5500	15.39	16.09	75.238	18.76	19.30	Pass
116	5580	15.52	15.47	70.882	18.51	19.30	Pass
140	5700	16.17	15.25	74.897	18.74	19.30	Pass
144	5720 For U-NII-2C	14.64	13.29	50.437	17.03	18.14	Pass
144	5720 For U-NII-3	10.02	8.56	17.224	12.36	25.30	Pass

Note:

- 5260~5320MHz gain = 10.7dBi > 6dBi, so the power limit shall be reduced to 24-(10.7-6) = 19.30dBm.
- 5500~5700MHz gain = 10.7dBi > 6dBi, so the power limit shall be reduced to 24-(10.7-6) = 19.30dBm.
- 5720MHz gain = 10.7dBi > 6dBi, so the power limit shall be reduced to 22.84-(10.7-6) = 18.14dBm.
- 5745~5825MHz gain = 10.7dBi > 6dBi, so the power limit shall be reduced to 30-(10.7-6) = 25.30dBm.

For U-NII-2A, U-NII-2C Band:

Chain 0

- 11dBm + 10log (20.55) = 24.13 dBm > 24dBm
- 11dBm + 10log (20.53) = 24.12 dBm > 24dBm
- 11dBm + 10log (20.54) = 24.13 dBm > 24dBm
- 11dBm + 10log (20.44) = 24.10 dBm > 24dBm
- 11dBm + 10log (20.42) = 24.10 dBm > 24dBm
- 11dBm + 10log (20.33) = 24.08 dBm > 24dBm
- 11dBm + 10log (5725.00 - 5709.74) = 22.84 dBm < 24dBm

Chain 1

- 11dBm + 10log (20.46) = 24.11 dBm > 24dBm
- 11dBm + 10log (20.41) = 24.10 dBm > 24dBm
- 11dBm + 10log (20.57) = 24.13 dBm > 24dBm
- 11dBm + 10log (20.35) = 24.09 dBm > 24dBm
- 11dBm + 10log (20.51) = 24.12 dBm > 24dBm
- 11dBm + 10log (20.48) = 24.11 dBm > 24dBm
- 11dBm + 10log (5725.00 - 5709.67) = 22.86 dBm < 24dBm

802.11n (HT40)

Chan.	Freq. (MHz)	Maximum Conducted Power (dBm)		Total Power (mW)	Total Power (dBm)	Power Limit (dBm)	Pass / Fail
		Chain 0	Chain 1				
54	5270	16.49	15.66	81.379	19.11	19.30	Pass
62	5310	15.58	15.28	69.870	18.44	19.30	Pass
102	5510	16.03	15.68	77.070	18.87	19.30	Pass
110	5550	16.55	15.81	83.293	19.21	19.30	Pass
134	5670	16.36	15.53	78.978	18.98	19.30	Pass
142	5710 For U-NII-2C	15.92	14.81	69.353	18.41	19.30	Pass
142	5710 For U-NII-3	7.56	6.45	10.118	10.05	25.30	Pass

Note:

- 5260~5320MHz gain = 10.7dBi > 6dBi, so the power limit shall be reduced to 24-(10.7-6) = 19.30dBm.
- 5500~5720MHz gain = 10.7dBi > 6dBi, so the power limit shall be reduced to 24-(10.7-6) = 19.30dBm.
- 5745~5825MHz gain = 10.7dBi > 6dBi, so the power limit shall be reduced to 30-(10.7-6) = 25.30dBm.

For U-NII-2A, U-NII-2C Band:

Chain 0

- 11dBm + 10log (40.76) = 27.10 dBm > 24dBm
- 11dBm + 10log (40.73) = 27.10 dBm > 24dBm
- 11dBm + 10log (40.81) = 27.11 dBm > 24dBm
- 11dBm + 10log (40.82) = 27.11 dBm > 24dBm
- 11dBm + 10log (41.05) = 27.13 dBm > 24dBm
- 11dBm + 10log (5725.00 - 5689.52) = 26.50 dBm > 24dBm

Chain 1

- 11dBm + 10log (40.75) = 27.10 dBm > 24dBm
- 11dBm + 10log (40.31) = 27.05 dBm > 24dBm
- 11dBm + 10log (40.29) = 27.05 dBm > 24dBm
- 11dBm + 10log (40.37) = 27.06 dBm > 24dBm
- 11dBm + 10log (40.58) = 27.08 dBm > 24dBm
- 11dBm + 10log (5725.00 - 5689.62) = 26.49 dBm > 24dBm

802.11ac (VHT80)

Chan.	Freq. (MHz)	Maximum Conducted Power (dBm)		Total Power (mW)	Total Power (dBm)	Power Limit (dBm)	Pass / Fail
		Chain 0	Chain 1				
58	5290	16.34	15.34	77.251	18.88	19.30	Pass
106	5530	15.32	15.11	66.475	18.23	19.30	Pass
122	5610	16.45	15.44	79.152	18.98	19.30	Pass
138	5690 For U-NII-2C	16.42	15.21	77.042	18.87	19.30	Pass
138	5690 For U-NII-3	5.87	4.74	6.843	8.35	25.30	Pass

Note:

- 5260~5320MHz gain = 10.7dBi > 6dBi, so the power limit shall be reduced to 24-(10.7-6) = 19.30dBm.
- 5500~5720MHz gain = 10.7dBi > 6dBi, so the power limit shall be reduced to 24-(10.7-6) = 19.30dBm.
- 5745~5825MHz gain = 10.7dBi > 6dBi, so the power limit shall be reduced to 30-(10.7-6) = 25.30dBm.

For U-NII-2A, U-NII-2C Band:

Chain 0

- 11dBm + 10log (83.56) = 30.22 dBm > 24dBm
- 11dBm + 10log (83.92) = 30.24 dBm > 24dBm
- 11dBm + 10log (83.85) = 30.24 dBm > 24dBm
- 11dBm + 10log (5725.00 - 5648.03) = 29.86 dBm > 24dBm

Chain 1

- 11dBm + 10log (83.70) = 30.23 dBm > 24dBm
- 11dBm + 10log (83.78) = 30.23 dBm > 24dBm
- 11dBm + 10log (83.83) = 30.23 dBm > 24dBm
- 11dBm + 10log (5725.00 - 5648.10) = 29.86 dBm > 24dBm

Beamforming Mode

802.11n (HT20)

Chan.	Freq. (MHz)	Maximum Conducted Power (dBm)		Total Power (mW)	Total Power (dBm)	Power Limit (dBm)	Pass / Fail
		Chain 0	Chain 1				
52	5260	15.93	15.63	75.733	18.79	19.30	Pass
60	5300	15.87	15.81	76.744	18.85	19.30	Pass
64	5320	15.71	15.74	74.736	18.74	19.30	Pass
100	5500	15.39	16.09	75.238	18.76	19.30	Pass
116	5580	15.52	15.47	70.882	18.51	19.30	Pass
140	5700	16.17	15.25	74.897	18.74	19.30	Pass
144	5720 For U-NII-2C	14.64	13.29	50.437	17.03	18.14	Pass
144	5720 For U-NII-3	10.02	8.56	17.224	12.36	25.30	Pass

Note:

1. This antenna was cross-polarized antenna.
2. 5260~5320MHz gain = 10.7dBi > 6dBi, so the power limit shall be reduced to $24-(10.7-6) = 19.30\text{dBm}$.
3. 5500~5700MHz gain = 10.7dBi > 6dBi, so the power limit shall be reduced to $24-(10.7-6) = 19.30\text{dBm}$.
4. 5720MHz gain = 10.7dBi > 6dBi, so the power limit shall be reduced to $22.84-(10.7-6) = 18.14\text{dBm}$.
5. 5745~5825MHz gain = 10.7dBi > 6dBi, so the power limit shall be reduced to $30-(10.7-6) = 25.30\text{dBm}$.

For U-NII-2A, U-NII-2C Band:

Chain 0

1. $11\text{dBm} + 10\log (20.55) = 24.13 \text{ dBm} > 24\text{dBm}$
2. $11\text{dBm} + 10\log (20.53) = 24.12 \text{ dBm} > 24\text{dBm}$
3. $11\text{dBm} + 10\log (20.54) = 24.13 \text{ dBm} > 24\text{dBm}$
4. $11\text{dBm} + 10\log (20.44) = 24.10 \text{ dBm} > 24\text{dBm}$
5. $11\text{dBm} + 10\log (20.42) = 24.10 \text{ dBm} > 24\text{dBm}$
6. $11\text{dBm} + 10\log (20.33) = 24.08 \text{ dBm} > 24\text{dBm}$
7. $11\text{dBm} + 10\log (5725.00 - 5709.74) = 22.84 \text{ dBm} < 24\text{dBm}$

Chain 1

1. $11\text{dBm} + 10\log (20.46) = 24.11 \text{ dBm} > 24\text{dBm}$
2. $11\text{dBm} + 10\log (20.41) = 24.10 \text{ dBm} > 24\text{dBm}$
3. $11\text{dBm} + 10\log (20.57) = 24.13 \text{ dBm} > 24\text{dBm}$
4. $11\text{dBm} + 10\log (20.35) = 24.09 \text{ dBm} > 24\text{dBm}$
5. $11\text{dBm} + 10\log (20.51) = 24.12 \text{ dBm} > 24\text{dBm}$
6. $11\text{dBm} + 10\log (20.48) = 24.11 \text{ dBm} > 24\text{dBm}$
7. $11\text{dBm} + 10\log (5725.00 - 5709.67) = 22.86 \text{ dBm} < 24\text{dBm}$

802.11n (HT40)

Chan.	Freq. (MHz)	Maximum Conducted Power (dBm)		Total Power (mW)	Total Power (dBm)	Power Limit (dBm)	Pass / Fail
		Chain 0	Chain 1				
54	5270	16.49	15.66	81.379	19.11	19.30	Pass
62	5310	15.58	15.28	69.870	18.44	19.30	Pass
102	5510	16.03	15.68	77.070	18.87	19.30	Pass
110	5550	16.55	15.81	83.293	19.21	19.30	Pass
134	5670	16.36	15.53	78.978	18.98	19.30	Pass
142	5710 For U-NII-2C	15.92	14.81	69.353	18.41	19.30	Pass
142	5710 For U-NII-3	7.56	6.45	10.118	10.05	25.30	Pass

Note:

1. This antenna was cross-polarized antenn.
2. 5260~5320MHz gain = 10.7dBi > 6dBi, so the power limit shall be reduced to $24 - (10.7 - 6) = 19.30\text{dBm}$.
3. 5500~5720MHz gain = 10.7dBi > 6dBi, so the power limit shall be reduced to $24 - (10.7 - 6) = 19.30\text{dBm}$.
4. 5745~5825MHz gain = 10.7dBi > 6dBi, so the power limit shall be reduced to $30 - (10.7 - 6) = 25.30\text{dBm}$.

For U-NII-2A, U-NII-2C Band:

Chain 0

1. $11\text{dBm} + 10\log (40.76) = 27.10 \text{ dBm} > 24\text{dBm}$
2. $11\text{dBm} + 10\log (40.73) = 27.10 \text{ dBm} > 24\text{dBm}$
3. $11\text{dBm} + 10\log (40.81) = 27.11 \text{ dBm} > 24\text{dBm}$
4. $11\text{dBm} + 10\log (40.82) = 27.11 \text{ dBm} > 24\text{dBm}$
5. $11\text{dBm} + 10\log (41.05) = 27.13 \text{ dBm} > 24\text{dBm}$
6. $11\text{dBm} + 10\log (5725.00 - 5689.52) = 26.50 \text{ dBm} > 24\text{dBm}$

Chain 1

1. $11\text{dBm} + 10\log (40.75) = 27.10 \text{ dBm} > 24\text{dBm}$
2. $11\text{dBm} + 10\log (40.31) = 27.05 \text{ dBm} > 24\text{dBm}$
3. $11\text{dBm} + 10\log (40.29) = 27.05 \text{ dBm} > 24\text{dBm}$
4. $11\text{dBm} + 10\log (40.37) = 27.06 \text{ dBm} > 24\text{dBm}$
5. $11\text{dBm} + 10\log (40.58) = 27.08 \text{ dBm} > 24\text{dBm}$
6. $11\text{dBm} + 10\log (5725.00 - 5689.62) = 26.49 \text{ dBm} > 24\text{dBm}$

802.11ac (VHT80)

Chan.	Freq. (MHz)	Maximum Conducted Power (dBm)		Total Power (mW)	Total Power (dBm)	Power Limit (dBm)	Pass / Fail
		Chain 0	Chain 1				
58	5290	16.34	15.34	77.251	18.88	19.30	Pass
106	5530	15.32	15.11	66.475	18.23	19.30	Pass
122	5610	16.45	15.44	79.152	18.98	19.30	Pass
138	5690 For U-NII-2C	16.42	15.21	77.042	18.87	19.30	Pass
138	5690 For U-NII-3	5.87	4.74	6.843	8.35	25.30	Pass

Note:

1. This antenna was cross-polarized antenna.
2. 5260~5320MHz gain = 10.7dBi > 6dBi, so the power limit shall be reduced to $24 - (10.7 - 6) = 19.30\text{dBm}$.
3. 5500~5720MHz gain = 10.7dBi > 6dBi, so the power limit shall be reduced to $24 - (10.7 - 6) = 19.30\text{dBm}$.
4. 5745~5825MHz gain = 10.7dBi > 6dBi, so the power limit shall be reduced to $30 - (10.7 - 6) = 25.30\text{dBm}$.

For U-NII-2A, U-NII-2C Band:

Chain 0

1. $11\text{dBm} + 10\log (83.56) = 30.22 \text{ dBm} > 24\text{dBm}$
2. $11\text{dBm} + 10\log (83.92) = 30.24 \text{ dBm} > 24\text{dBm}$
3. $11\text{dBm} + 10\log (83.85) = 30.24 \text{ dBm} > 24\text{dBm}$
4. $11\text{dBm} + 10\log (5725.00 - 5648.03) = 29.86 \text{ dBm} > 24\text{dBm}$

Chain 1

1. $11\text{dBm} + 10\log (83.70) = 30.23 \text{ dBm} > 24\text{dBm}$
2. $11\text{dBm} + 10\log (83.78) = 30.23 \text{ dBm} > 24\text{dBm}$
3. $11\text{dBm} + 10\log (83.83) = 30.23 \text{ dBm} > 24\text{dBm}$
4. $11\text{dBm} + 10\log (5725.00 - 5648.10) = 29.86 \text{ dBm} > 24\text{dBm}$

26dB Bandwidth:

802.11a

Chan.	Freq. (MHz)	26dBc Bandwidth (MHz)	
		Chain 0	Chain 1
52	5260	19.48	19.24
60	5300	19.62	19.29
64	5320	19.41	19.37
100	5500	19.46	19.14
116	5580	19.36	19.44
140	5700	19.48	19.28
144	5720 For U-NII-2C	14.85	14.59
144	5720 For U-NII-3	4.81	4.56

802.11n (HT20)

Chan.	Freq. (MHz)	26dBc Bandwidth (MHz)	
		Chain 0	Chain 1
52	5260	20.55	20.46
60	5300	20.53	20.41
64	5320	20.54	20.57
100	5500	20.44	20.35
116	5580	20.42	20.51
140	5700	20.33	20.48
144	5720 For U-NII-2C	15.26	15.33
144	5720 For U-NII-3	5.16	5.23

802.11n (HT40)

Chan.	Freq. (MHz)	26dBc Bandwidth (MHz)	
		Chain 0	Chain 1
54	5270	40.76	40.75
62	5310	40.73	40.31
102	5510	40.81	40.29
110	5550	40.82	40.37
134	5670	41.05	40.58
142	5710 For U-NII-2C	35.48	35.38
142	5710 For U-NII-3	5.18	5.16

802.11ac (VHT80)

Chan.	Freq. (MHz)	26dBc Bandwidth (MHz)	
		Chain 0	Chain 1
58	5290	83.56	83.70
106	5530	83.92	83.78
122	5610	83.85	83.83
138	5690 For U-NII-2C	76.97	76.90
138	5690 For U-NII-3	6.78	6.91

Spectrum Plot of Worst Value

802.11a

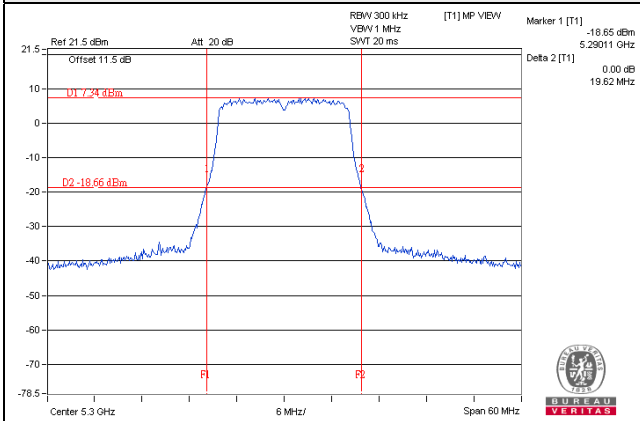

802.11n (HT20)

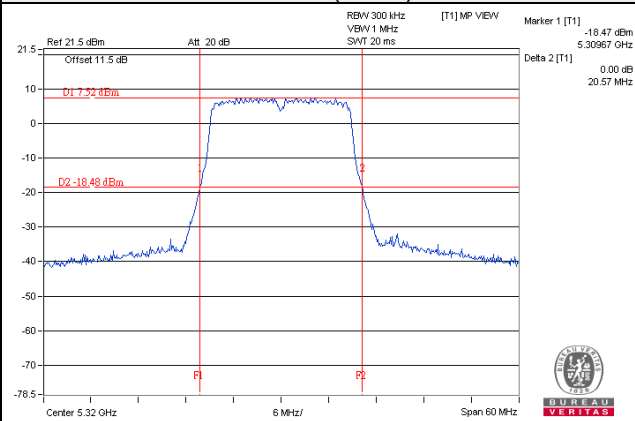

802.11n (HT40)

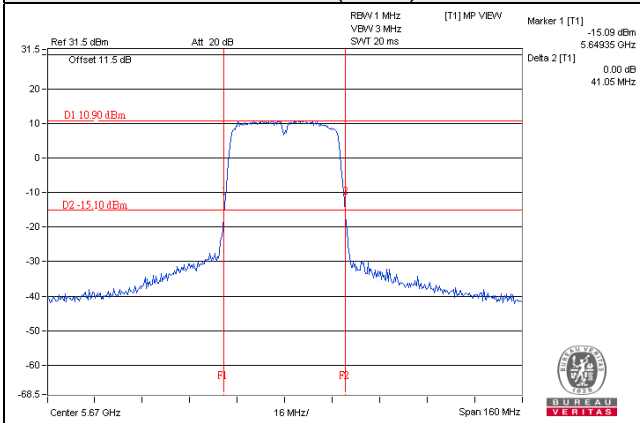

802.11ac (VHT80)

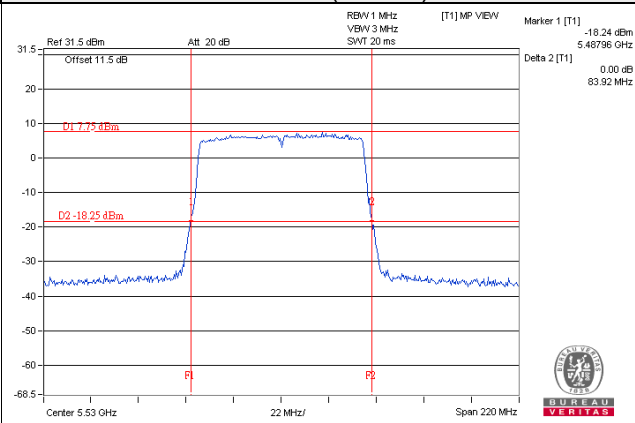

EUT Maximum Conducted Power

CDD Mode

802.11a

Frequency Band (MHz)	Max. Power	
	Output Power (mW)	Output Power (dBm)
5250~5350	72.617	18.61
5470~5725	74.517	18.72

802.11n (HT20)

Frequency Band (MHz)	Max. Power	
	Output Power (mW)	Output Power (dBm)
5250~5350	76.744	18.85
5470~5725	75.238	18.76

802.11n (HT40)

Frequency Band (MHz)	Max. Power	
	Output Power (mW)	Output Power (dBm)
5250~5350	81.379	19.11
5470~5725	83.293	19.21

802.11ac (VHT80)

Frequency Band (MHz)	Max. Power	
	Output Power (mW)	Output Power (dBm)
5250~5350	77.251	18.88
5470~5725	79.152	18.98

Beamforming Mode

802.11n (HT20)

Frequency Band (MHz)	Max. Power	
	Output Power (mW)	Output Power (dBm)
5250~5350	76.744	18.85
5470~5725	75.238	18.76

802.11n (HT40)

Frequency Band (MHz)	Max. Power	
	Output Power (mW)	Output Power (dBm)
5250~5350	81.379	19.11
5470~5725	83.293	19.21

802.11ac (VHT80)

Frequency Band (MHz)	Max. Power	
	Output Power (mW)	Output Power (dBm)
5250~5350	77.251	18.88
5470~5725	79.152	18.98

Test Mode I

Power Output:

CDD Mode

802.11a

Chan.	Freq. (MHz)	Maximum Conducted Power (dBm)		Total Power (mW)	Total Power (dBm)	Power Limit (dBm)	Pass / Fail
		Chain 0	Chain 1				
52	5260	13.69	13.09	43.758	16.41	19.15	Pass
60	5300	13.57	13.29	44.081	16.44	19.14	Pass
64	5320	13.37	13.24	42.813	16.32	19.11	Pass
100	5500	11.93	12.61	33.835	15.29	19.13	Pass
116	5580	11.97	11.94	31.371	14.97	19.15	Pass
140	5700	14.33	13.48	49.386	16.94	19.11	Pass
144	5720 For U-NII-2C	13.04	12.57	38.209	15.82	17.95	Pass
144	5720 For U-NII-3	8.08	7.52	12.076	10.82	25.30	Pass

Note:

- 5260MHz gain = 10.7dBi > 6dBi, so the power limit shall be reduced to 23.85-(10.7-6) = 19.15dBm.
- 5300MHz gain = 10.7dBi > 6dBi, so the power limit shall be reduced to 23.84-(10.7-6) = 19.14dBm.
- 5320MHz gain = 10.7dBi > 6dBi, so the power limit shall be reduced to 23.81-(10.7-6) = 19.11dBm.
- 5500MHz gain = 10.7dBi > 6dBi, so the power limit shall be reduced to 23.83-(10.7-6) = 19.13dBm.
- 5580MHz gain = 10.7dBi > 6dBi, so the power limit shall be reduced to 23.85-(10.7-6) = 19.15dBm.
- 5700MHz gain = 10.7dBi > 6dBi, so the power limit shall be reduced to 23.81-(10.7-6) = 19.11dBm.
- 5720MHz gain = 10.7dBi > 6dBi, so the power limit shall be reduced to 22.65-(10.7-6) = 17.95dBm.
- 5745~5825MHz gain = 10.7dBi > 6dBi, so the power limit shall be reduced to 30-(10.7-6) = 25.30dBm.

For U-NII-2A, U-NII-2C Band:

Chain 0

- 11dBm + 10log (19.57) = 23.92 dBm < 24dBm
- 11dBm + 10log (19.41) = 23.88 dBm < 24dBm
- 11dBm + 10log (19.71) = 23.95 dBm < 24dBm
- 11dBm + 10log (19.69) = 23.94 dBm < 24dBm
- 11dBm + 10log (19.58) = 23.92 dBm < 24dBm
- 11dBm + 10log (19.49) = 23.90 dBm < 24dBm
- 11dBm + 10log (5725.00 - 5710.21) = 22.70 dBm < 24dBm

Chain 1

- 11dBm + 10log (19.26) = 23.85 dBm < 24dBm
- 11dBm + 10log (19.22) = 23.84 dBm < 24dBm
- 11dBm + 10log (19.11) = 23.81 dBm < 24dBm
- 11dBm + 10log (19.20) = 23.83 dBm < 24dBm
- 11dBm + 10log (19.27) = 23.85 dBm < 24dBm
- 11dBm + 10log (19.10) = 23.81 dBm < 24dBm
- 11dBm + 10log (5725.00 - 5710.37) = 22.65 dBm < 24dBm

802.11n (HT20)

Chan.	Freq. (MHz)	Maximum Conducted Power (dBm)		Total Power (mW)	Total Power (dBm)	Power Limit (dBm)	Pass / Fail
		Chain 0	Chain 1				
52	5260	14.14	13.72	49.492	16.95	19.30	Pass
60	5300	13.56	13.18	43.496	16.38	19.30	Pass
64	5320	13.28	13.29	42.611	16.30	19.30	Pass
100	5500	12.44	13.08	37.863	15.78	19.30	Pass
116	5580	12.52	12.45	35.444	15.50	19.30	Pass
140	5700	14.75	14.02	55.089	17.41	19.30	Pass
144	5720 For U-NII-2C	9.75	9.02	37.239	15.71	18.13	Pass
144	5720 For U-NII-3	4.05	3.59	12.499	10.97	25.30	Pass

Note:

- 5260~5320MHz gain = 10.7dBi > 6dBi, so the power limit shall be reduced to 24-(10.7-6) = 19.30dBm.
- 5500~5700MHz gain = 10.7dBi > 6dBi, so the power limit shall be reduced to 24-(10.7-6) = 19.30dBm.
- 5720MHz gain = 10.7dBi > 6dBi, so the power limit shall be reduced to 22.83-(10.7-6) = 18.13dBm.
- 5745~5825MHz gain = 10.7dBi > 6dBi, so the power limit shall be reduced to 30-(10.7-6) = 25.30dBm.

For U-NII-2A, U-NII-2C Band:

Chain 0

- 11dBm + 10log (20.55) = 24.13 dBm > 24dBm
- 11dBm + 10log (20.52) = 24.12 dBm > 24dBm
- 11dBm + 10log (20.48) = 24.11 dBm > 24dBm
- 11dBm + 10log (20.42) = 24.10 dBm > 24dBm
- 11dBm + 10log (20.28) = 24.07 dBm > 24dBm
- 11dBm + 10log (20.42) = 24.10 dBm > 24dBm
- 11dBm + 10log (5725.00 - 5709.73) = 22.84 dBm < 24dBm

Chain 1

- 11dBm + 10log (20.38) = 24.09 dBm > 24dBm
- 11dBm + 10log (20.36) = 24.09 dBm > 24dBm
- 11dBm + 10log (20.38) = 24.09 dBm > 24dBm
- 11dBm + 10log (20.60) = 24.14 dBm > 24dBm
- 11dBm + 10log (20.69) = 24.16 dBm > 24dBm
- 11dBm + 10log (20.39) = 24.09 dBm > 24dBm
- 11dBm + 10log (5725.00 - 5709.76) = 22.83 dBm < 24dBm

802.11n (HT40)

Chan.	Freq. (MHz)	Maximum Conducted Power (dBm)		Total Power (mW)	Total Power (dBm)	Power Limit (dBm)	Pass / Fail
		Chain 0	Chain 1				
54	5270	15.33	15.27	67.770	18.31	19.30	Pass
62	5310	15.02	14.31	58.746	17.69	19.30	Pass
102	5510	14.57	15.27	62.293	17.94	19.30	Pass
110	5550	15.26	15.45	68.649	18.37	19.30	Pass
134	5670	15.27	14.65	62.825	17.98	19.30	Pass
142	5710 For U-NII-2C	15.92	14.80	69.284	18.41	19.30	Pass
142	5710 For U-NII-3	7.58	6.52	10.215	10.09	25.30	Pass

Note:

- 5260~5320MHz gain = 10.7dBi > 6dBi, so the power limit shall be reduced to 24-(10.7-6) = 19.30dBm.
- 5500~5720MHz gain = 10.7dBi > 6dBi, so the power limit shall be reduced to 24-(10.7-6) = 19.30dBm.
- 5745~5825MHz gain = 10.7dBi > 6dBi, so the power limit shall be reduced to 30-(10.7-6) = 25.30dBm.

For U-NII-2A, U-NII-2C Band:

Chain 0

- 11dBm + 10log (40.84) = 27.11 dBm > 24dBm
- 11dBm + 10log (40.88) = 27.12 dBm > 24dBm
- 11dBm + 10log (41.10) = 27.14 dBm > 24dBm
- 11dBm + 10log (40.90) = 27.12 dBm > 24dBm
- 11dBm + 10log (40.82) = 27.11 dBm > 24dBm
- 11dBm + 10log (5725.00 - 5689.36) = 26.52 dBm > 24dBm

Chain 1

- 11dBm + 10log (40.73) = 27.10 dBm > 24dBm
- 11dBm + 10log (41.12) = 27.14 dBm > 24dBm
- 11dBm + 10log (40.62) = 27.09 dBm > 24dBm
- 11dBm + 10log (40.63) = 27.09 dBm > 24dBm
- 11dBm + 10log (40.60) = 27.09 dBm > 24dBm
- 11dBm + 10log (5725.00 - 5689.56) = 26.49 dBm > 24dBm

802.11ac (VHT80)

Chan.	Freq. (MHz)	Maximum Conducted Power (dBm)		Total Power (mW)	Total Power (dBm)	Power Limit (dBm)	Pass / Fail
		Chain 0	Chain 1				
58	5290	14.93	14.26	57.786	17.62	19.30	Pass
106	5530	16.25	15.63	78.729	18.96	19.30	Pass
122	5610	16.45	15.44	79.152	18.98	19.30	Pass
138	5690 For U-NII-2C	16.42	15.22	77.119	18.87	19.30	Pass
138	5690 For U-NII-3	5.88	4.61	6.764	8.30	25.30	Pass

Note:

- 5260~5320MHz gain = 10.7dBi > 6dBi, so the power limit shall be reduced to 24-(10.7-6) = 19.30dBm.
- 5500~5720MHz gain = 10.7dBi > 6dBi, so the power limit shall be reduced to 24-(10.7-6) = 19.30dBm.
- 5745~5825MHz gain = 10.7dBi > 6dBi, so the power limit shall be reduced to 30-(10.7-6) = 25.30dBm.

For U-NII-2A, U-NII-2C Band:

Chain 0

- 11dBm + 10log (83.65) = 30.22 dBm > 24dBm
- 11dBm + 10log (84.50) = 30.27 dBm > 24dBm
- 11dBm + 10log (83.89) = 30.24 dBm > 24dBm
- 11dBm + 10log (5725.00 - 5647.57) = 29.89 dBm > 24dBm

Chain 1

- 11dBm + 10log (82.90) = 30.19 dBm > 24dBm
- 11dBm + 10log (82.96) = 30.19 dBm > 24dBm
- 11dBm + 10log (83.06) = 30.19 dBm > 24dBm
- 11dBm + 10log (5725.00 - 5648.22) = 29.85 dBm > 24dBm

Beamforming Mode

802.11n (HT20)

Chan.	Freq. (MHz)	Maximum Conducted Power (dBm)		Total Power (mW)	Total Power (dBm)	Power Limit (dBm)	Pass / Fail
		Chain 0	Chain 1				
52	5260	11.13	10.71	24.774	13.94	16.29	Pass
60	5300	10.55	10.17	21.727	13.37	16.29	Pass
64	5320	10.27	10.28	21.330	13.29	16.29	Pass
100	5500	9.43	10.07	18.923	12.77	16.29	Pass
116	5580	9.51	9.44	17.742	12.49	16.29	Pass
140	5700	11.74	11.01	27.542	14.40	16.29	Pass
144	5720 For U-NII-2C	6.74	6.01	18.621	12.70	15.12	Pass
144	5720 For U-NII-3	1.04	0.58	6.252	7.96	22.29	Pass

Note:

- 5260~5320MHz directional gain = $10.7\text{dBi} + 10\log(2) = 13.71\text{dBi} > 6\text{dBi}$, so the power limit shall be reduced to $24 - (13.71 - 6) = 16.29\text{dBm}$.
- 5500~5700MHz directional gain = $10.7\text{dBi} + 10\log(2) = 13.71\text{dBi} > 6\text{dBi}$, so the power limit shall be reduced to $24 - (13.71 - 6) = 16.29\text{dBm}$.
- 5720MHz directional gain = $10.7\text{dBi} + 10\log(2) = 13.71\text{dBi} > 6\text{dBi}$, so the power limit shall be reduced to $22.83 - (13.71 - 6) = 15.12\text{dBm}$.
- 5745~5825MHz directional gain = $10.7\text{dBi} + 10\log(2) = 13.71\text{dBi} > 6\text{dBi}$, so the power limit shall be reduced to $30 - (13.71 - 6) = 22.29\text{dBm}$.

For U-NII-2A, U-NII-2C Band:

Chain 0

- $11\text{dBm} + 10\log(20.55) = 24.13\text{ dBm} > 24\text{dBm}$
- $11\text{dBm} + 10\log(20.52) = 24.12\text{ dBm} > 24\text{dBm}$
- $11\text{dBm} + 10\log(20.48) = 24.11\text{ dBm} > 24\text{dBm}$
- $11\text{dBm} + 10\log(20.42) = 24.10\text{ dBm} > 24\text{dBm}$
- $11\text{dBm} + 10\log(20.28) = 24.07\text{ dBm} > 24\text{dBm}$
- $11\text{dBm} + 10\log(20.42) = 24.10\text{ dBm} > 24\text{dBm}$
- $11\text{dBm} + 10\log(5725.00 - 5709.73) = 22.84\text{ dBm} < 24\text{dBm}$

Chain 1

- $11\text{dBm} + 10\log(20.38) = 24.09\text{ dBm} > 24\text{dBm}$
- $11\text{dBm} + 10\log(20.36) = 24.09\text{ dBm} > 24\text{dBm}$
- $11\text{dBm} + 10\log(20.38) = 24.09\text{ dBm} > 24\text{dBm}$
- $11\text{dBm} + 10\log(20.60) = 24.14\text{ dBm} > 24\text{dBm}$
- $11\text{dBm} + 10\log(20.69) = 24.16\text{ dBm} > 24\text{dBm}$
- $11\text{dBm} + 10\log(20.39) = 24.09\text{ dBm} > 24\text{dBm}$
- $11\text{dBm} + 10\log(5725.00 - 5709.76) = 22.83\text{ dBm} < 24\text{dBm}$

802.11n (HT40)

Chan.	Freq. (MHz)	Maximum Conducted Power (dBm)		Total Power (mW)	Total Power (dBm)	Power Limit (dBm)	Pass / Fail
		Chain 0	Chain 1				
54	5270	12.32	12.26	33.884	15.30	16.29	Pass
62	5310	12.01	11.30	29.376	14.68	16.29	Pass
102	5510	11.56	12.26	31.117	14.93	16.29	Pass
110	5550	12.25	12.44	34.356	15.36	16.29	Pass
134	5670	12.26	11.64	31.405	14.97	16.29	Pass
142	5710 For U-NII-2C	12.91	11.79	34.674	15.40	16.29	Pass
142	5710 For U-NII-3	4.57	3.51	5.105	7.08	22.29	Pass

Note:

- 5260~5320MHz directional gain = $10.7\text{dBi} + 10\log(2) = 13.71\text{dBi} > 6\text{dBi}$, so the power limit shall be reduced to $24 - (13.71 - 6) = 16.29\text{dBm}$.
- 5500~5720MHz directional gain = $10.7\text{dBi} + 10\log(2) = 13.71\text{dBi} > 6\text{dBi}$, so the power limit shall be reduced to $24 - (13.71 - 6) = 16.29\text{dBm}$.
- 5745~5825MHz directional gain = $10.7\text{dBi} + 10\log(2) = 13.71\text{dBi} > 6\text{dBi}$, so the power limit shall be reduced to $30 - (13.71 - 6) = 22.29\text{dBm}$.

For U-NII-2A, U-NII-2C Band:

Chain 0

- $11\text{dBm} + 10\log (40.84) = 27.11 \text{ dBm} > 24\text{dBm}$
- $11\text{dBm} + 10\log (40.88) = 27.12 \text{ dBm} > 24\text{dBm}$
- $11\text{dBm} + 10\log (41.10) = 27.14 \text{ dBm} > 24\text{dBm}$
- $11\text{dBm} + 10\log (40.90) = 27.12 \text{ dBm} > 24\text{dBm}$
- $11\text{dBm} + 10\log (40.82) = 27.11 \text{ dBm} > 24\text{dBm}$
- $11\text{dBm} + 10\log (5725.00 - 5689.36) = 26.52 \text{ dBm} > 24\text{dBm}$

Chain 1

- $11\text{dBm} + 10\log (40.73) = 27.10 \text{ dBm} > 24\text{dBm}$
- $11\text{dBm} + 10\log (41.12) = 27.14 \text{ dBm} > 24\text{dBm}$
- $11\text{dBm} + 10\log (40.62) = 27.09 \text{ dBm} > 24\text{dBm}$
- $11\text{dBm} + 10\log (40.63) = 27.09 \text{ dBm} > 24\text{dBm}$
- $11\text{dBm} + 10\log (40.60) = 27.09 \text{ dBm} > 24\text{dBm}$
- $11\text{dBm} + 10\log (5725.00 - 5689.56) = 26.49 \text{ dBm} > 24\text{dBm}$

802.11ac (VHT80)

Chan.	Freq. (MHz)	Maximum Conducted Power (dBm)		Total Power (mW)	Total Power (dBm)	Power Limit (dBm)	Pass / Fail
		Chain 0	Chain 1				
58	5290	11.92	11.25	28.907	14.61	16.29	Pass
106	5530	13.24	12.62	39.355	15.95	16.29	Pass
122	5610	13.44	12.43	39.537	15.97	16.29	Pass
138	5690 For U-NII-2C	13.41	12.21	38.548	15.86	16.29	Pass
138	5690 For U-NII-3	2.87	1.60	3.381	5.29	22.29	Pass

Note:

- 5260~5320MHz directional gain = $10.7\text{dBi} + 10\log(2) = 13.71\text{dBi} > 6\text{dBi}$, so the power limit shall be reduced to $24 - (13.71 - 6) = 16.29\text{dBm}$.
- 5500~5720MHz directional gain = $10.7\text{dBi} + 10\log(2) = 13.71\text{dBi} > 6\text{dBi}$, so the power limit shall be reduced to $24 - (13.71 - 6) = 16.29\text{dBm}$.
- 5745~5825MHz directional gain = $10.7\text{dBi} + 10\log(2) = 13.71\text{dBi} > 6\text{dBi}$, so the power limit shall be reduced to $30 - (13.71 - 6) = 22.29\text{dBm}$.

For U-NII-2A, U-NII-2C Band:

Chain 0

- $11\text{dBm} + 10\log (83.65) = 30.22 \text{ dBm} > 24\text{dBm}$
- $11\text{dBm} + 10\log (84.50) = 30.27 \text{ dBm} > 24\text{dBm}$
- $11\text{dBm} + 10\log (83.89) = 30.24 \text{ dBm} > 24\text{dBm}$
- $11\text{dBm} + 10\log (5725.00 - 5647.57) = 29.89 \text{ dBm} > 24\text{dBm}$

Chain 1

- $11\text{dBm} + 10\log (82.90) = 30.19 \text{ dBm} > 24\text{dBm}$
- $11\text{dBm} + 10\log (82.96) = 30.19 \text{ dBm} > 24\text{dBm}$
- $11\text{dBm} + 10\log (83.06) = 30.19 \text{ dBm} > 24\text{dBm}$
- $11\text{dBm} + 10\log (5725.00 - 5648.22) = 29.85 \text{ dBm} > 24\text{dBm}$

26dB Bandwidth:

802.11a

Chan.	Freq. (MHz)	26dBc Bandwidth (MHz)	
		Chain 0	Chain 1
52	5260	19.57	19.26
60	5300	19.41	19.22
64	5320	19.71	19.11
100	5500	19.69	19.20
116	5580	19.58	19.27
140	5700	19.49	19.10
144	5720 For U-NII-2C	14.79	14.63
144	5720 For U-NII-3	4.72	4.58

802.11n (HT20)

Chan.	Freq. (MHz)	26dBc Bandwidth (MHz)	
		Chain 0	Chain 1
52	5260	20.55	20.38
60	5300	20.52	20.36
64	5320	20.48	20.38
100	5500	20.42	20.60
116	5580	20.28	20.69
140	5700	20.42	20.39
144	5720 For U-NII-2C	15.27	15.24
144	5720 For U-NII-3	5.19	5.05

802.11n (HT40)

Chan.	Freq. (MHz)	26dBc Bandwidth (MHz)	
		Chain 0	Chain 1
54	5270	40.84	40.73
62	5310	40.88	41.12
102	5510	41.10	40.62
110	5550	40.90	40.63
134	5670	40.82	40.60
142	5710 For U-NII-2C	35.64	35.44
142	5710 For U-NII-3	5.23	5.27

802.11ac (VHT80)

Chan.	Freq. (MHz)	26dBc Bandwidth (MHz)	
		Chain 0	Chain 1
58	5290	83.65	82.90
106	5530	84.50	82.96
122	5610	83.89	83.06
138	5690 For U-NII-2C	77.43	76.78
138	5690 For U-NII-3	6.84	6.67

Spectrum Plot of Worst Value

802.11a

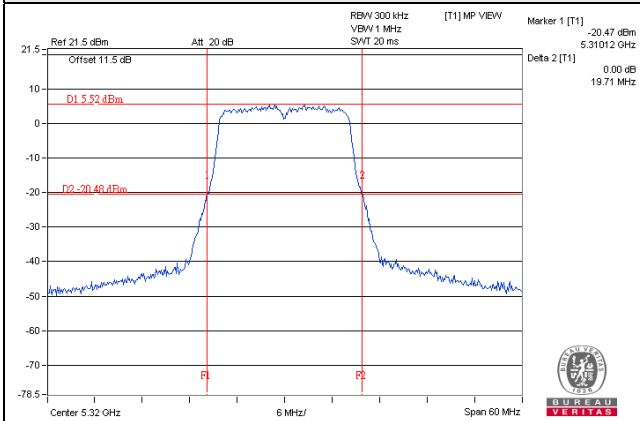

802.11n (HT20)

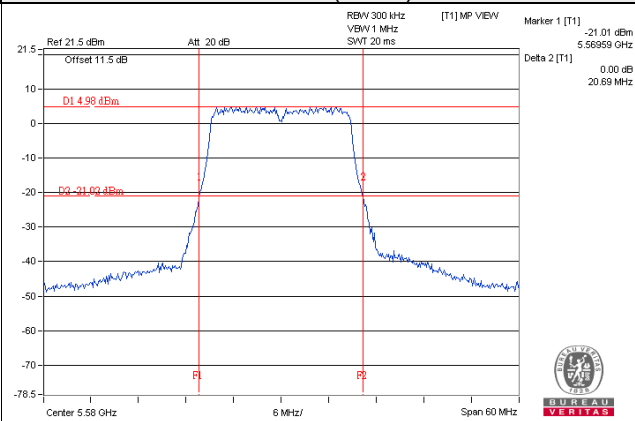

802.11n (HT40)

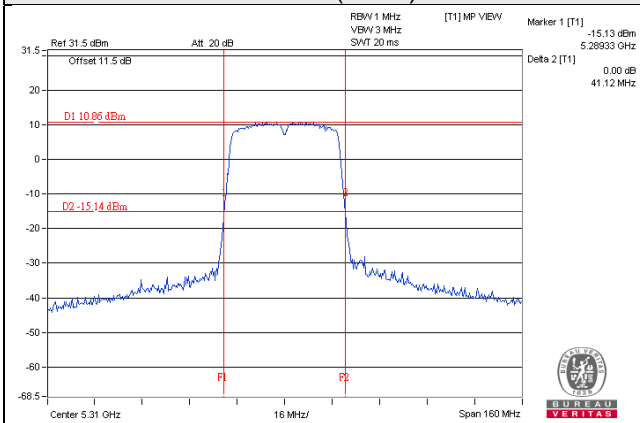

802.11ac (VHT80)

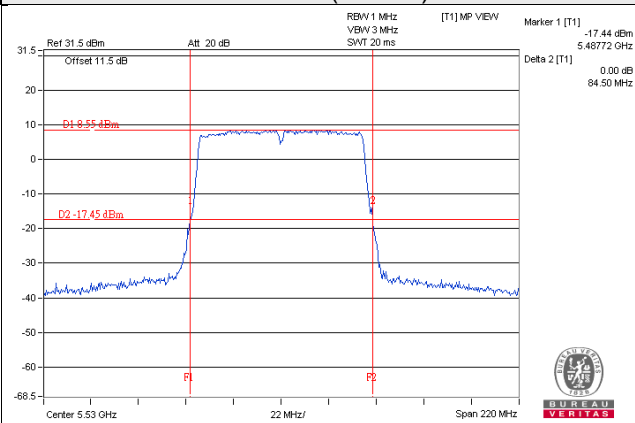

EUT Maximum Conducted Power

CDD Mode

802.11a

Frequency Band (MHz)	Max. Power	
	Output Power (mW)	Output Power (dBm)
5250~5350	44.081	16.44
5470~5725	49.386	16.94

802.11n (HT20)

Frequency Band (MHz)	Max. Power	
	Output Power (mW)	Output Power (dBm)
5250~5350	49.492	16.95
5470~5725	55.089	17.41

802.11n (HT40)

Frequency Band (MHz)	Max. Power	
	Output Power (mW)	Output Power (dBm)
5250~5350	67.770	18.31
5470~5725	69.284	18.41

802.11ac (VHT80)

Frequency Band (MHz)	Max. Power	
	Output Power (mW)	Output Power (dBm)
5250~5350	57.786	17.62
5470~5725	79.152	18.98

Beamforming Mode

802.11n (HT20)

Frequency Band (MHz)	Max. Power	
	Output Power (mW)	Output Power (dBm)
5250~5350	24.774	13.94
5470~5725	27.542	14.40

802.11n (HT40)

Frequency Band (MHz)	Max. Power	
	Output Power (mW)	Output Power (dBm)
5250~5350	33.884	15.30
5470~5725	34.674	15.40

802.11ac (VHT80)

Frequency Band (MHz)	Max. Power	
	Output Power (mW)	Output Power (dBm)
5250~5350	28.907	14.61
5470~5725	39.537	15.97

Test Mode K

Power Output:

CDD Mode

802.11a

Chan.	Freq. (MHz)	Maximum Conducted Power (dBm)		Total Power (mW)	Total Power (dBm)	Power Limit (dBm)	Pass / Fail
		Chain 0	Chain 1				
52	5260	16.95	16.11	90.377	19.56	23.26	Pass
60	5300	16.91	16.02	89.085	19.50	23.22	Pass
64	5320	17.05	16.08	91.250	19.60	23.24	Pass
100	5500	15.22	14.55	61.776	17.91	23.27	Pass
116	5580	15.59	14.81	66.493	18.23	23.25	Pass
140	5700	17.09	16.38	94.619	19.76	23.19	Pass
144	5720 For U-NII-2C	14.25	13.83	50.762	17.06	22.05	Pass
144	5720 For U-NII-3	6.27	6.91	9.145	9.61	29.40	Pass

Note:

- 5260MHz gain = 6.6dBi > 6dBi, so the power limit shall be reduced to 23.86-(6.6-6) = 23.26dBm.
- 5300MHz gain = 6.6dBi > 6dBi, so the power limit shall be reduced to 23.82-(6.6-6) = 23.22dBm.
- 5320MHz gain = 6.6dBi > 6dBi, so the power limit shall be reduced to 23.84-(6.6-6) = 23.24dBm.
- 5500MHz gain = 6.6dBi > 6dBi, so the power limit shall be reduced to 23.87-(6.6-6) = 23.27dBm.
- 5580MHz gain = 6.6dBi > 6dBi, so the power limit shall be reduced to 23.85-(6.6-6) = 23.25dBm.
- 5700MHz gain = 6.6dBi > 6dBi, so the power limit shall be reduced to 23.79-(6.6-6) = 23.19dBm.
- 5720MHz gain = 6.6dBi > 6dBi, so the power limit shall be reduced to 22.65-(6.6-6) = 22.05dBm.
- 5745~5825MHz gain = 6.6dBi > 6dBi, so the power limit shall be reduced to 30-(6.6-6) = 29.40dBm.

For U-NII-2A, U-NII-2C Band:

Chain 0

- 11dBm + 10log (19.65) = 23.93 dBm < 24dBm
- 11dBm + 10log (19.63) = 23.93 dBm < 24dBm
- 11dBm + 10log (19.52) = 23.90 dBm < 24dBm
- 11dBm + 10log (19.65) = 23.93 dBm < 24dBm
- 11dBm + 10log (19.43) = 23.88 dBm < 24dBm
- 11dBm + 10log (19.51) = 23.90 dBm < 24dBm
- 11dBm + 10log (5725.00 - 5710.18) = 22.71 dBm < 24dBm

Chain 1

- 11dBm + 10log (19.31) = 23.86 dBm < 24dBm
- 11dBm + 10log (19.13) = 23.82 dBm < 24dBm
- 11dBm + 10log (19.24) = 23.84 dBm < 24dBm
- 11dBm + 10log (19.38) = 23.87 dBm < 24dBm
- 11dBm + 10log (19.26) = 23.85 dBm < 24dBm
- 11dBm + 10log (19.03) = 23.79 dBm < 24dBm
- 11dBm + 10log (5725.00 - 5710.38) = 22.65 dBm < 24dBm

802.11n (HT20)

Chan.	Freq. (MHz)	Maximum Conducted Power (dBm)		Total Power (mW)	Total Power (dBm)	Power Limit (dBm)	Pass / Fail
		Chain 0	Chain 1				
52	5260	16.92	16.21	90.987	19.59	23.40	Pass
60	5300	16.99	16.15	91.213	19.60	23.40	Pass
64	5320	17.21	16.22	94.481	19.75	23.40	Pass
100	5500	15.41	14.68	64.130	18.07	23.40	Pass
116	5580	16.06	15.31	74.328	18.71	23.40	Pass
140	5700	17.12	16.35	94.675	19.76	23.40	Pass
144	5720 For U-NII-2C	14.62	14.80	59.173	17.72	22.24	Pass
144	5720 For U-NII-3	9.04	8.24	14.685	11.67	29.40	Pass

Note:

- 5260~5320MHz gain = 6.6dBi > 6dBi, so the power limit shall be reduced to 24-(6.6-6) = 23.40dBm.
- 5500~5700MHz gain = 6.6dBi > 6dBi, so the power limit shall be reduced to 24-(6.6-6) = 23.40dBm.
- 5720MHz gain = 6.6dBi > 6dBi, so the power limit shall be reduced to 22.84-(6.6-6) = 22.24dBm.
- 5745~5825MHz gain = 6.6dBi > 6dBi, so the power limit shall be reduced to 30-(6.6-6) = 29.40dBm.

For U-NII-2A, U-NII-2C Band:

Chain 0

- 11dBm + 10log (20.64) = 24.15 dBm > 24dBm
- 11dBm + 10log (20.39) = 24.09 dBm > 24dBm
- 11dBm + 10log (20.53) = 24.12 dBm > 24dBm
- 11dBm + 10log (20.50) = 24.12 dBm > 24dBm
- 11dBm + 10log (20.48) = 24.11 dBm > 24dBm
- 11dBm + 10log (20.55) = 24.13 dBm > 24dBm
- 11dBm + 10log (5725.00 - 5709.74) = 22.84 dBm < 24dBm

Chain 1

- 11dBm + 10log (20.39) = 24.09 dBm > 24dBm
- 11dBm + 10log (20.27) = 24.07 dBm > 24dBm
- 11dBm + 10log (20.44) = 24.10 dBm > 24dBm
- 11dBm + 10log (20.64) = 24.15 dBm > 24dBm
- 11dBm + 10log (20.48) = 24.11 dBm > 24dBm
- 11dBm + 10log (20.53) = 24.12 dBm > 24dBm
- 11dBm + 10log (5725.00 - 5709.66) = 22.86 dBm < 24dBm

802.11n (HT40)

Chan.	Freq. (MHz)	Maximum Conducted Power (dBm)		Total Power (mW)	Total Power (dBm)	Power Limit (dBm)	Pass / Fail
		Chain 0	Chain 1				
54	5270	19.92	19.23	181.928	22.60	23.40	Pass
62	5310	19.47	18.65	161.794	22.09	23.40	Pass
102	5510	17.12	16.35	94.675	19.76	23.40	Pass
110	5550	18.55	17.89	133.132	21.24	23.40	Pass
134	5670	20.22	19.53	194.939	22.90	23.40	Pass
142	5710 For U-NII-2C	17.26	16.66	99.556	19.98	23.40	Pass
142	5710 For U-NII-3	6.75	5.26	8.089	9.08	29.40	Pass

Note:

- 5260~5320MHz gain = 6.6dBi > 6dBi, so the power limit shall be reduced to 24-(6.6-6) = 23.40dBm.
- 5500~5720MHz gain = 6.6dBi > 6dBi, so the power limit shall be reduced to 24-(6.6-6) = 23.40dBm.
- 5745~5825MHz gain = 6.6dBi > 6dBi, so the power limit shall be reduced to 30-(6.6-6) = 29.40dBm.

For U-NII-2A, U-NII-2C Band:

Chain 0

- 11dBm + 10log (41.31) = 27.16 dBm > 24dBm
- 11dBm + 10log (41.00) = 27.13 dBm > 24dBm
- 11dBm + 10log (41.13) = 27.14 dBm > 24dBm
- 11dBm + 10log (41.02) = 27.13 dBm > 24dBm
- 11dBm + 10log (41.32) = 27.16 dBm > 24dBm
- 11dBm + 10log (5725.00 - 5682.18) = 27.32 dBm > 24dBm

Chain 1

- 11dBm + 10log (41.19) = 27.15 dBm > 24dBm
- 11dBm + 10log (41.34) = 27.16 dBm > 24dBm
- 11dBm + 10log (40.98) = 27.13 dBm > 24dBm
- 11dBm + 10log (41.48) = 27.18 dBm > 24dBm
- 11dBm + 10log (57.32) = 28.58 dBm > 24dBm
- 11dBm + 10log (5725.00 - 5686.32) = 26.87 dBm > 24dBm

802.11ac (VHT80)

Chan.	Freq. (MHz)	Maximum Conducted Power (dBm)		Total Power (mW)	Total Power (dBm)	Power Limit (dBm)	Pass / Fail
		Chain 0	Chain 1				
58	5290	17.71	16.96	108.679	20.36	23.40	Pass
106	5530	16.32	15.45	77.930	18.92	23.40	Pass
122	5610	20.31	19.85	204.004	23.10	23.40	Pass
138	5690 For U-NII-2C	16.84	16.27	90.670	19.57	23.40	Pass
138	5690 For U-NII-3	3.57	2.74	4.154	6.18	29.40	Pass

Note:

- 5260~5320MHz gain = 10.7dBi > 6dBi, so the power limit shall be reduced to 24-(10.7-6) = 19.30dBm.
- 5500~5720MHz gain = 10.7dBi > 6dBi, so the power limit shall be reduced to 24-(10.7-6) = 19.30dBm.
- 5745~5825MHz gain = 10.7dBi > 6dBi, so the power limit shall be reduced to 30-(10.7-6) = 25.30dBm.

For U-NII-2A, U-NII-2C Band:

Chain 0

- 11dBm + 10log (84.14) = 30.25 dBm > 24dBm
- 11dBm + 10log (83.57) = 30.22 dBm > 24dBm
- 11dBm + 10log (83.49) = 30.22 dBm > 24dBm
- 11dBm + 10log (5725.00 - 5638.28) = 30.38 dBm > 24dBm

Chain 1

- 11dBm + 10log (83.32) = 30.21 dBm > 24dBm
- 11dBm + 10log (83.39) = 30.21 dBm > 24dBm
- 11dBm + 10log (149.27) = 32.74 dBm > 24dBm
- 11dBm + 10log (5725.00 - 5635.83) = 30.50 dBm > 24dBm

Beamforming Mode

802.11n (HT20)

Chan.	Freq. (MHz)	Maximum Conducted Power (dBm)		Total Power (mW)	Total Power (dBm)	Power Limit (dBm)	Pass / Fail
		Chain 0	Chain 1				
52	5260	13.91	13.20	45.499	16.58	20.39	Pass
60	5300	13.98	13.14	45.604	16.59	20.39	Pass
64	5320	14.20	13.21	47.206	16.74	20.39	Pass
100	5500	12.40	11.67	32.063	15.06	20.39	Pass
116	5580	13.05	12.30	37.154	15.70	20.39	Pass
140	5700	14.11	13.34	47.315	16.75	20.39	Pass
144	5720 For U-NII-2C	11.61	11.79	29.580	14.71	19.23	Pass
144	5720 For U-NII-3	6.03	5.23	7.345	8.66	26.39	Pass

Note:

- 5260~5320MHz directional gain = $6.6\text{dBi} + 10\log(2) = 9.61\text{dBi} > 6\text{dBi}$, so the power limit shall be reduced to $24 - (9.61 - 6) = 20.39\text{dBm}$.
- 5500~5700MHz directional gain = $6.6\text{dBi} + 10\log(2) = 9.61\text{dBi} > 6\text{dBi}$, so the power limit shall be reduced to $24 - (9.61 - 6) = 20.39\text{dBm}$.
- 5720MHz directional gain = $6.6\text{dBi} + 10\log(2) = 9.61\text{dBi} > 6\text{dBi}$, so the power limit shall be reduced to $22.84 - (9.61 - 6) = 19.23\text{dBm}$.
- 5745~5825MHz directional gain = $6.6\text{dBi} + 10\log(2) = 9.61\text{dBi} > 6\text{dBi}$, so the power limit shall be reduced to $30 - (9.61 - 6) = 26.39\text{dBm}$.

For U-NII-2A, U-NII-2C Band:

Chain 0

- $11\text{dBm} + 10\log(20.64) = 24.15\text{ dBm} > 24\text{dBm}$
- $11\text{dBm} + 10\log(20.39) = 24.09\text{ dBm} > 24\text{dBm}$
- $11\text{dBm} + 10\log(20.53) = 24.12\text{ dBm} > 24\text{dBm}$
- $11\text{dBm} + 10\log(20.50) = 24.12\text{ dBm} > 24\text{dBm}$
- $11\text{dBm} + 10\log(20.48) = 24.11\text{ dBm} > 24\text{dBm}$
- $11\text{dBm} + 10\log(20.55) = 24.13\text{ dBm} > 24\text{dBm}$
- $11\text{dBm} + 10\log(5725.00 - 5709.74) = 22.84\text{ dBm} < 24\text{dBm}$

Chain 1

- $11\text{dBm} + 10\log(20.39) = 24.09\text{ dBm} > 24\text{dBm}$
- $11\text{dBm} + 10\log(20.27) = 24.07\text{ dBm} > 24\text{dBm}$
- $11\text{dBm} + 10\log(20.44) = 24.10\text{ dBm} > 24\text{dBm}$
- $11\text{dBm} + 10\log(20.64) = 24.15\text{ dBm} > 24\text{dBm}$
- $11\text{dBm} + 10\log(20.48) = 24.11\text{ dBm} > 24\text{dBm}$
- $11\text{dBm} + 10\log(20.53) = 24.12\text{ dBm} > 24\text{dBm}$
- $11\text{dBm} + 10\log(5725.00 - 5709.66) = 22.86\text{ dBm} < 24\text{dBm}$

802.11n (HT40)

Chan.	Freq. (MHz)	Maximum Conducted Power (dBm)		Total Power (mW)	Total Power (dBm)	Power Limit (dBm)	Pass / Fail
		Chain 0	Chain 1				
54	5270	16.91	16.22	90.991	19.59	20.39	Pass
62	5310	16.46	15.64	80.910	19.08	20.39	Pass
102	5510	14.11	13.34	47.315	16.75	20.39	Pass
110	5550	15.54	14.88	66.527	18.23	20.39	Pass
134	5670	17.21	16.52	97.499	19.89	20.39	Pass
142	5710 For U-NII-2C	14.25	13.65	49.774	16.97	20.39	Pass
142	5710 For U-NII-3	3.74	2.25	4.046	6.07	26.39	Pass

Note:

- 5260~5320MHz directional gain = 6.6dBi + 10log(2) = 9.61dBi > 6dBi, so the power limit shall be reduced to 24-(9.61-6) = 20.39dBm.
- 5500~5720MHz directional gain = 6.6dBi + 10log(2) = 9.61dBi > 6dBi, so the power limit shall be reduced to 24-(9.61-6) = 20.39dBm.
- 5745~5825MHz directional gain = 6.6dBi + 10log(2) = 9.61dBi > 6dBi, so the power limit shall be reduced to 30-(9.61-6) = 26.39dBm.

For U-NII-2A, U-NII-2C Band:

Chain 0

- 11dBm + 10log (41.31) = 27.16 dBm > 24dBm
- 11dBm + 10log (41.00) = 27.13 dBm > 24dBm
- 11dBm + 10log (41.13) = 27.14 dBm > 24dBm
- 11dBm + 10log (41.02) = 27.13 dBm > 24dBm
- 11dBm + 10log (41.32) = 27.16 dBm > 24dBm
- 11dBm + 10log (5725.00 - 5682.18) = 27.32 dBm > 24dBm

Chain 1

- 11dBm + 10log (41.19) = 27.15 dBm > 24dBm
- 11dBm + 10log (41.34) = 27.16 dBm > 24dBm
- 11dBm + 10log (40.98) = 27.13 dBm > 24dBm
- 11dBm + 10log (41.48) = 27.18 dBm > 24dBm
- 11dBm + 10log (57.32) = 28.58 dBm > 24dBm
- 11dBm + 10log (5725.00 - 5686.32) = 26.87 dBm > 24dBm

802.11ac (VHT80)

Chan.	Freq. (MHz)	Maximum Conducted Power (dBm)		Total Power (mW)	Total Power (dBm)	Power Limit (dBm)	Pass / Fail
		Chain 0	Chain 1				
58	5290	14.70	13.95	54.325	17.35	20.39	Pass
106	5530	13.31	12.44	38.994	15.91	20.39	Pass
122	5610	17.30	16.84	102.094	20.09	20.39	Pass
138	5690 For U-NII-2C	13.83	13.26	45.290	16.56	20.39	Pass
138	5690 For U-NII-3	0.56	-0.27	2.075	3.17	26.39	Pass

Note:

- 5260~5320MHz directional gain = 6.6dBi + 10log(2) = 9.61dBi > 6dBi, so the power limit shall be reduced to 24-(9.61-6) = 20.39dBm.
- 5500~5720MHz directional gain = 6.6dBi + 10log(2) = 9.61dBi > 6dBi, so the power limit shall be reduced to 24-(9.61-6) = 20.39dBm.
- 5745~5825MHz directional gain = 6.6dBi + 10log(2) = 9.61dBi > 6dBi, so the power limit shall be reduced to 30-(9.61-6) = 26.39dBm.

For U-NII-2A, U-NII-2C Band:

Chain 0

- 11dBm + 10log (84.14) = 30.25 dBm > 24dBm
- 11dBm + 10log (83.57) = 30.22 dBm > 24dBm
- 11dBm + 10log (83.49) = 30.22 dBm > 24dBm
- 11dBm + 10log (5725.00 - 5638.28) = 30.38 dBm > 24dBm

Chain 1

- 11dBm + 10log (83.32) = 30.21 dBm > 24dBm
- 11dBm + 10log (83.39) = 30.21 dBm > 24dBm
- 11dBm + 10log (149.27) = 32.74 dBm > 24dBm
- 11dBm + 10log (5725.00 - 5635.83) = 30.50 dBm > 24dBm

26dB Bandwidth:

802.11a

Chan.	Freq. (MHz)	26dBc Bandwidth (MHz)	
		Chain 0	Chain 1
52	5260	19.65	19.31
60	5300	19.63	19.13
64	5320	19.52	19.24
100	5500	19.65	19.38
116	5580	19.43	19.26
140	5700	19.51	19.03
144	5720 For U-NII-2C	14.82	14.62
144	5720 For U-NII-3	4.69	4.56

802.11n (HT20)

Chan.	Freq. (MHz)	26dBc Bandwidth (MHz)	
		Chain 0	Chain 1
52	5260	20.64	20.39
60	5300	20.39	20.27
64	5320	20.53	20.44
100	5500	20.50	20.64
116	5580	20.48	20.48
140	5700	20.55	20.53
144	5720 For U-NII-2C	15.26	15.34
144	5720 For U-NII-3	5.17	5.16

802.11n (HT40)

Chan.	Freq. (MHz)	26dBc Bandwidth (MHz)	
		Chain 0	Chain 1
54	5270	41.31	41.19
62	5310	41.00	41.34
102	5510	41.13	40.98
110	5550	41.02	41.48
134	5670	41.32	57.32
142	5710 For U-NII-2C	42.82	38.68
142	5710 For U-NII-3	10.25	17.81

802.11ac (VHT80)

Chan.	Freq. (MHz)	26dBc Bandwidth (MHz)	
		Chain 0	Chain 1
58	5290	84.14	83.32
106	5530	83.57	83.39
122	5610	83.49	149.27
138	5690 For U-NII-2C	86.72	89.17
138	5690 For U-NII-3	7.21	31.62

Spectrum Plot of Worst Value

802.11a

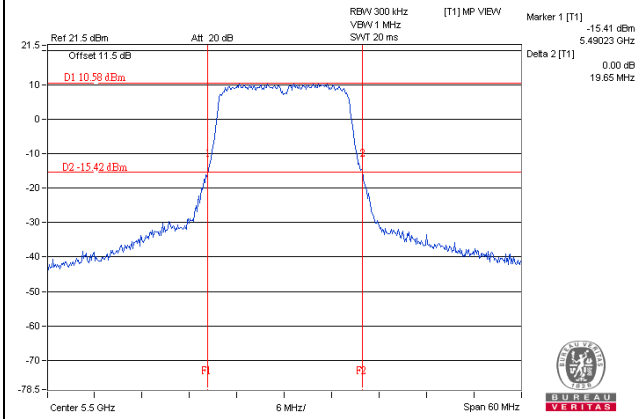

802.11n (HT20)

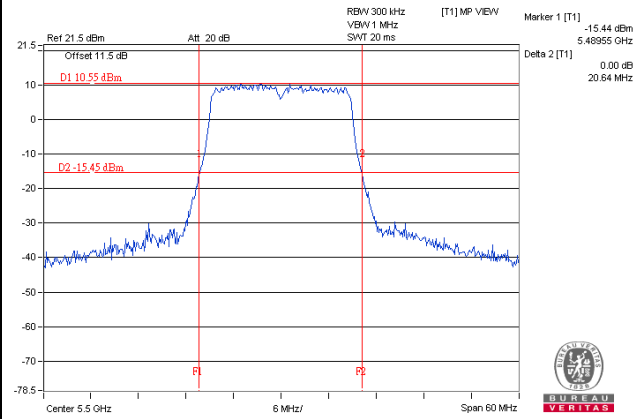

802.11n (HT40)

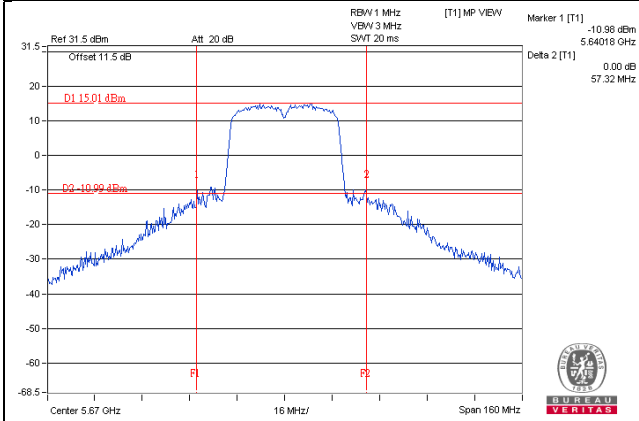

802.11ac (VHT80)

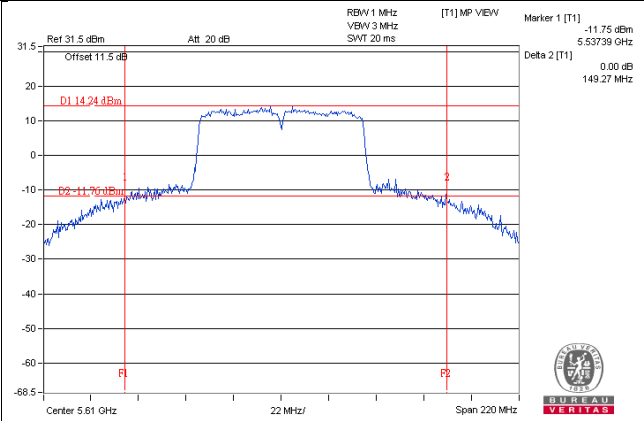

EUT Maximum Conducted Power

CDD Mode

802.11a

Frequency Band (MHz)	Max. Power	
	Output Power (mW)	Output Power (dBm)
5250~5350	91.250	19.60
5470~5725	94.619	19.76

802.11n (HT20)

Frequency Band (MHz)	Max. Power	
	Output Power (mW)	Output Power (dBm)
5250~5350	94.481	19.75
5470~5725	94.675	19.76

802.11n (HT40)

Frequency Band (MHz)	Max. Power	
	Output Power (mW)	Output Power (dBm)
5250~5350	181.928	22.60
5470~5725	194.939	22.90

802.11ac (VHT80)

Frequency Band (MHz)	Max. Power	
	Output Power (mW)	Output Power (dBm)
5250~5350	108.679	20.36
5470~5725	204.004	23.10

Beamforming Mode

802.11n (HT20)

Frequency Band (MHz)	Max. Power	
	Output Power (mW)	Output Power (dBm)
5250~5350	47.206	16.74
5470~5725	47.315	16.75

802.11n (HT40)

Frequency Band (MHz)	Max. Power	
	Output Power (mW)	Output Power (dBm)
5250~5350	90.991	19.59
5470~5725	97.499	19.89

802.11ac (VHT80)

Frequency Band (MHz)	Max. Power	
	Output Power (mW)	Output Power (dBm)
5250~5350	54.325	17.35
5470~5725	102.094	20.09

4.4 Occupied Bandwidth Measurement

4.4.1 Test Setup

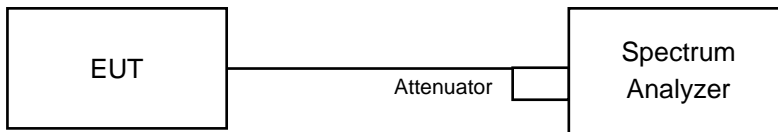

4.4.2 Test Instruments

Refer to section 4.1.2 to get information of above instrument.

4.4.3 Test Procedure

The transmitter output was connected to the spectrum analyzer through an attenuator. The bandwidth of the fundamental frequency was measured by spectrum analyzer with resolution bandwidth in the range of 1% to 5% of the anticipated emission bandwidth, and a video bandwidth at least 3x the resolution bandwidth and set the detector to sampling. The width of a frequency band such that, below the lower and above the upper frequency limits, the mean powers emitted are each equal to a specified percentage 0.5 %of the total mean power of a given emission.

4.4.4 Test Result

Test Mode B

802.11a

Chan.	Freq. (MHz)	Occupied Bandwidth (MHz)	
		Chain 0	Chain 1
52	5260	16.44	16.44
60	5300	16.44	16.44
64	5320	16.44	16.44
100	5500	16.44	16.44
116	5580	16.44	16.44
140	5700	16.44	16.44
144	5720 For U-NII-2C	13.28	13.28
144	5720 For U-NII-3	3.16	3.16

802.11n (HT20)

Chan.	Freq. (MHz)	Occupied Bandwidth (MHz)	
		Chain 0	Chain 1
52	5260	17.64	17.64
60	5300	17.64	17.64
64	5320	17.64	17.64
100	5500	17.64	17.76
116	5580	17.64	17.64
140	5700	17.64	17.64
144	5720 For U-NII-2C	13.88	13.76
144	5720 For U-NII-3	3.76	3.76

802.11n (HT40)

Chan.	Freq. (MHz)	Occupied Bandwidth (MHz)	
		Chain 0	Chain 1
54	5270	36.12	36.12
62	5310	36.12	36.12
102	5510	36.12	36.12
110	5550	36.24	36.12
134	5670	36.24	36.00
142	5710 For U-NII-2C	33.24	33.24
142	5710 For U-NII-3	3.24	3.24

802.11ac (VHT80)

Chan.	Freq. (MHz)	Occupied Bandwidth (MHz)	
		Chain 0	Chain 1
58	5290	75.84	75.84
106	5530	75.84	75.60
122	5610	75.84	76.08
138	5690 For U-NII-2C	73.16	73.16
138	5690 For U-NII-3	2.92	3.16

Spectrum Plot of Worst Value

802.11a

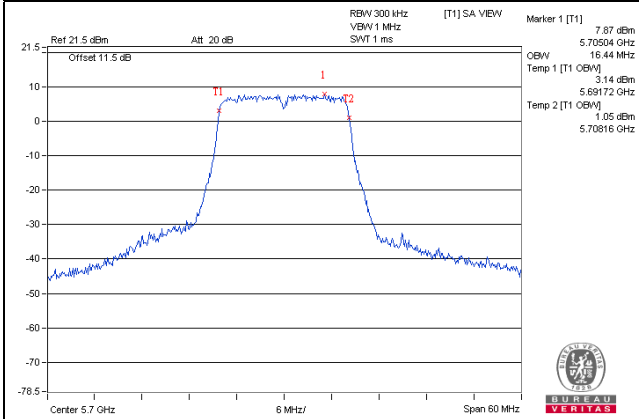

802.11n (HT20)

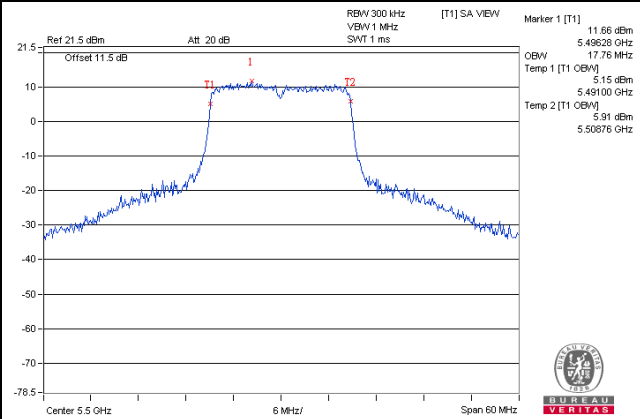

802.11n (HT40)

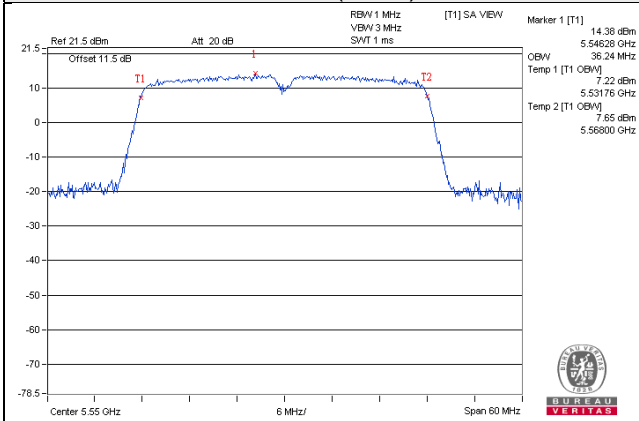

802.11ac (VHT80)

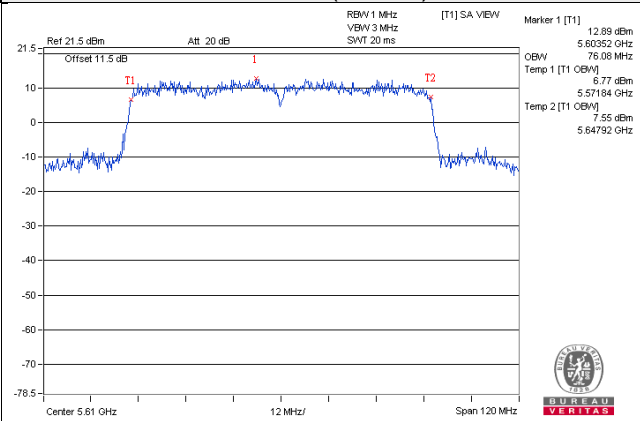

Test Mode D

802.11a

Chan.	Freq. (MHz)	Occupied Bandwidth (MHz)	
		Chain 0	Chain 1
52	5260	16.56	16.56
60	5300	16.56	16.56
64	5320	16.56	16.44
100	5500	16.56	16.56
116	5580	16.56	16.56
140	5700	16.56	16.56
144	5720 For U-NII-2C	13.28	13.28
144	5720 For U-NII-3	3.04	3.04

802.11n (HT20)

Chan.	Freq. (MHz)	Occupied Bandwidth (MHz)	
		Chain 0	Chain 1
52	5260	17.76	17.76
60	5300	17.76	17.76
64	5320	17.76	17.76
100	5500	17.76	17.76
116	5580	17.64	17.76
140	5700	17.76	17.76
144	5720 For U-NII-2C	13.88	13.88
144	5720 For U-NII-3	3.64	3.64

802.11n (HT40)

Chan.	Freq. (MHz)	Occupied Bandwidth (MHz)	
		Chain 0	Chain 1
54	5270	36.24	36.24
62	5310	36.24	36.24
102	5510	36.24	36.24
110	5550	36.24	36.24
134	5670	36.36	36.24
142	5710 For U-NII-2C	33.24	33.24
142	5710 For U-NII-3	3.00	3.00

802.11ac (VHT80)

Chan.	Freq. (MHz)	Occupied Bandwidth (MHz)	
		Chain 0	Chain 1
58	5290	75.60	75.84
106	5530	75.84	75.60
122	5610	75.84	75.84
138	5690 For U-NII-2C	73.16	73.16
138	5690 For U-NII-3	2.92	2.68

Spectrum Plot of Worst Value

802.11a

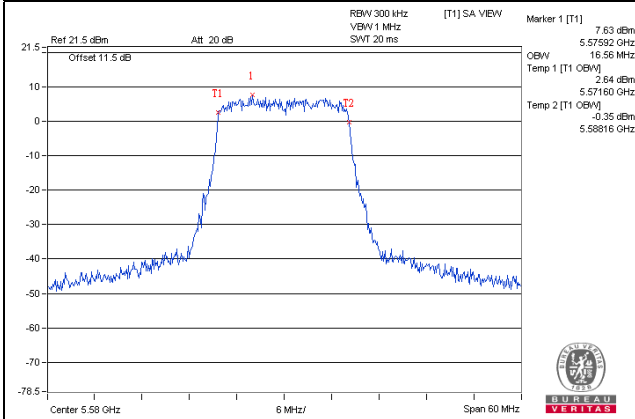

802.11n (HT20)

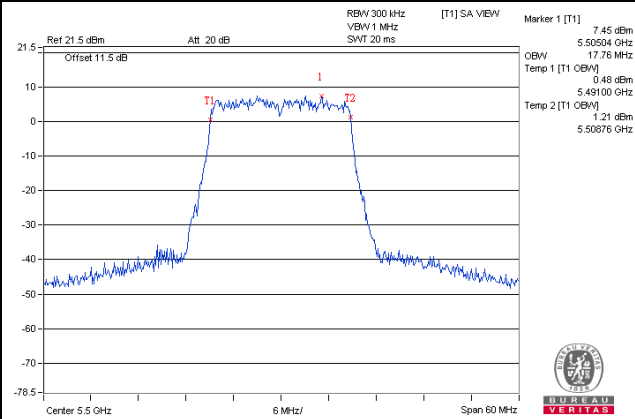

802.11n (HT40)

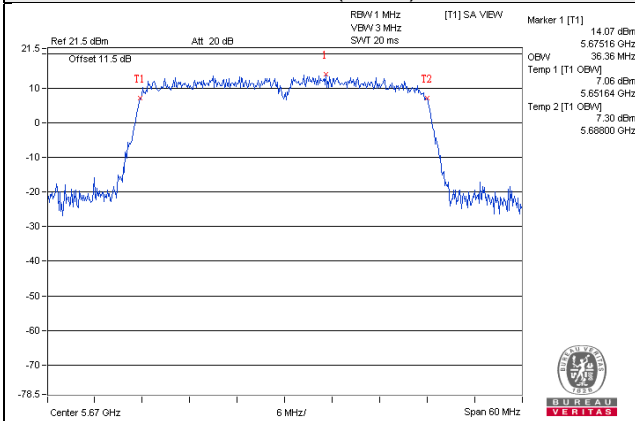

802.11ac (VHT80)

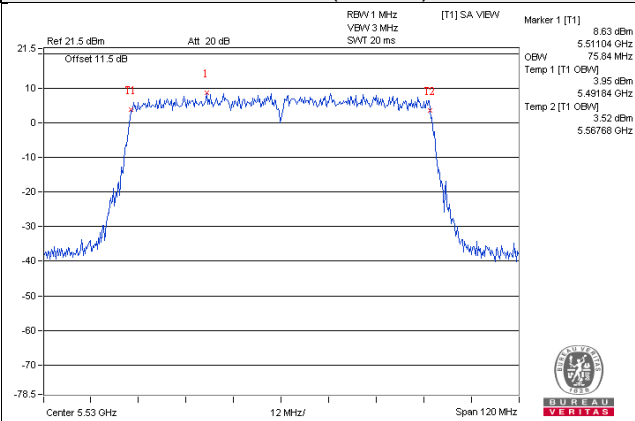

Test Mode E

802.11a

Chan.	Freq. (MHz)	Occupied Bandwidth (MHz)	
		Chain 0	Chain 1
52	5260	16.56	16.56
60	5300	16.56	16.56
64	5320	16.56	16.56
100	5500	16.56	16.56
116	5580	16.56	16.56
140	5700	16.56	16.56
144	5720 For U-NII-2C	13.28	13.28
144	5720 For U-NII-3	3.04	3.04

802.11n (HT20)

Chan.	Freq. (MHz)	Occupied Bandwidth (MHz)	
		Chain 0	Chain 1
52	5260	17.76	17.76
60	5300	17.76	17.76
64	5320	17.76	17.76
100	5500	17.76	17.76
116	5580	17.64	17.76
140	5700	17.76	17.76
144	5720 For U-NII-2C	13.88	13.88
144	5720 For U-NII-3	3.64	3.64

802.11n (HT40)

Chan.	Freq. (MHz)	Occupied Bandwidth (MHz)	
		Chain 0	Chain 1
54	5270	36.24	36.24
62	5310	36.24	36.24
102	5510	36.24	36.24
110	5550	36.24	36.48
134	5670	36.24	36.12
142	5710 For U-NII-2C	33.24	33.24
142	5710 For U-NII-3	3.00	3.00

802.11ac (VHT80)

Chan.	Freq. (MHz)	Occupied Bandwidth (MHz)	
		Chain 0	Chain 1
58	5290	75.60	75.84
106	5530	75.84	75.60
122	5610	75.84	75.84
138	5690 For U-NII-2C	73.16	73.16
138	5690 For U-NII-3	2.92	2.68

Spectrum Plot of Worst Value

802.11a

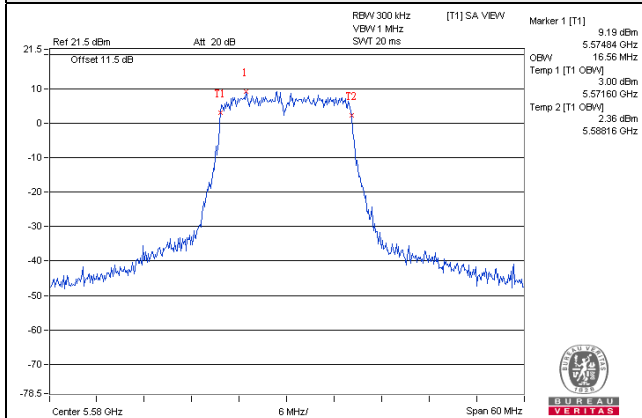

802.11n (HT20)

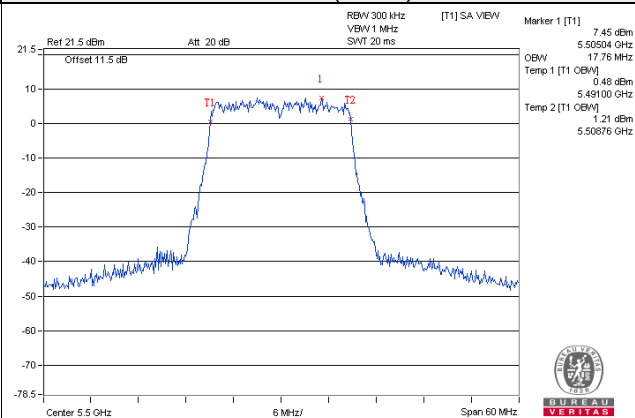

802.11n (HT40)

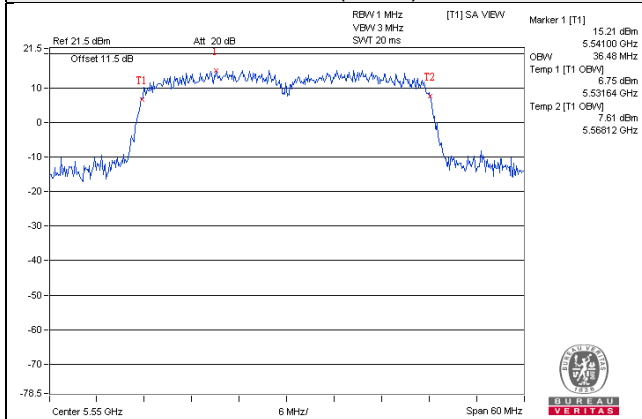

802.11ac (VHT80)

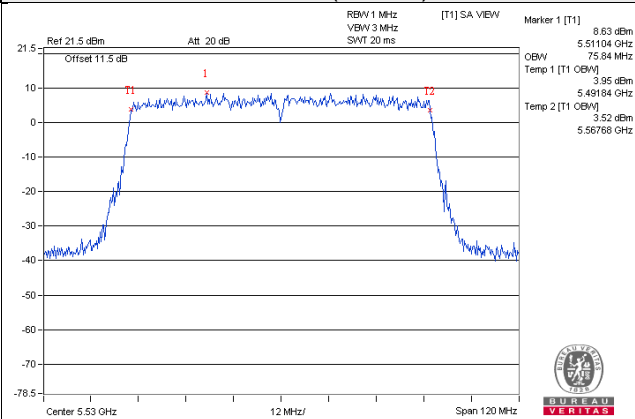

Test Mode G

802.11a

Chan.	Freq. (MHz)	Occupied Bandwidth (MHz)	
		Chain 0	Chain 1
52	5260	16.44	16.44
60	5300	16.44	16.44
64	5320	16.44	16.44
100	5500	16.44	16.44
116	5580	16.44	16.44
140	5700	16.44	16.44
144	5720 For U-NII-2C	13.28	13.28
144	5720 For U-NII-3	3.04	3.04

802.11n (HT20)

Chan.	Freq. (MHz)	Occupied Bandwidth (MHz)	
		Chain 0	Chain 1
52	5260	17.64	17.64
60	5300	17.64	17.64
64	5320	17.64	17.64
100	5500	17.64	17.64
116	5580	17.64	17.76
140	5700	17.64	17.64
144	5720 For U-NII-2C	13.88	13.88
144	5720 For U-NII-3	3.64	3.64

802.11n (HT40)

Chan.	Freq. (MHz)	Occupied Bandwidth (MHz)	
		Chain 0	Chain 1
54	5270	36.12	36.12
62	5310	36.12	36.12
102	5510	36.12	36.12
110	5550	36.24	36.12
134	5670	36.24	36.24
142	5710 For U-NII-2C	33.36	33.24
142	5710 For U-NII-3	3.00	3.00

802.11ac (VHT80)

Chan.	Freq. (MHz)	Occupied Bandwidth (MHz)	
		Chain 0	Chain 1
58	5290	75.84	75.84
106	5530	75.84	75.84
122	5610	76.08	75.84
138	5690 For U-NII-2C	73.16	73.16
138	5690 For U-NII-3	2.68	2.68

Spectrum Plot of Worst Value

802.11a

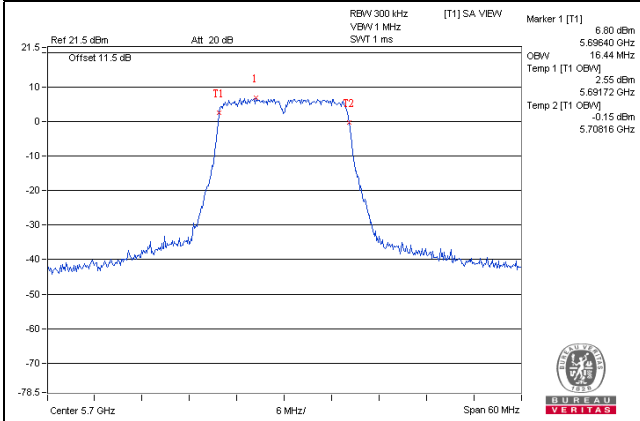

802.11n (HT20)

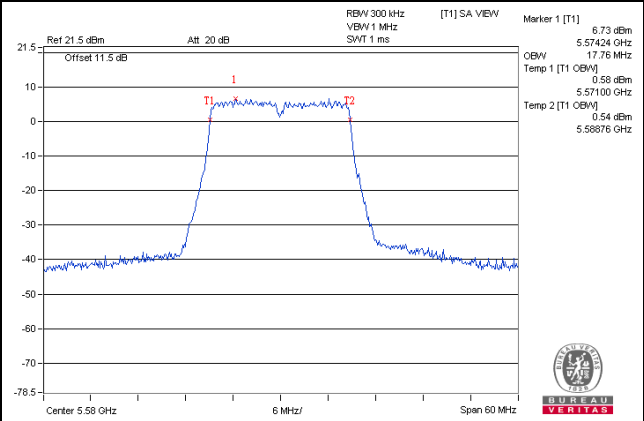

802.11n (HT40)

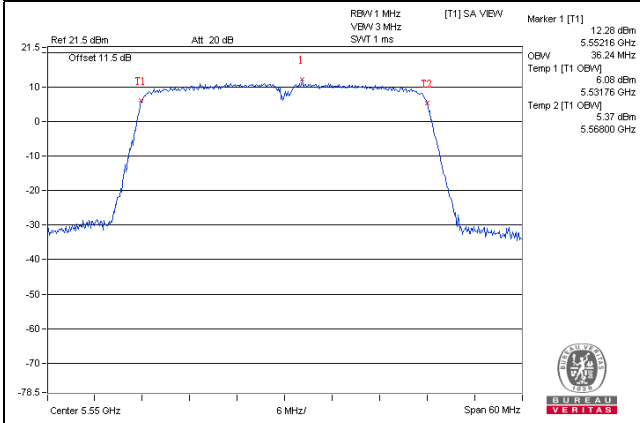

802.11ac (VHT80)

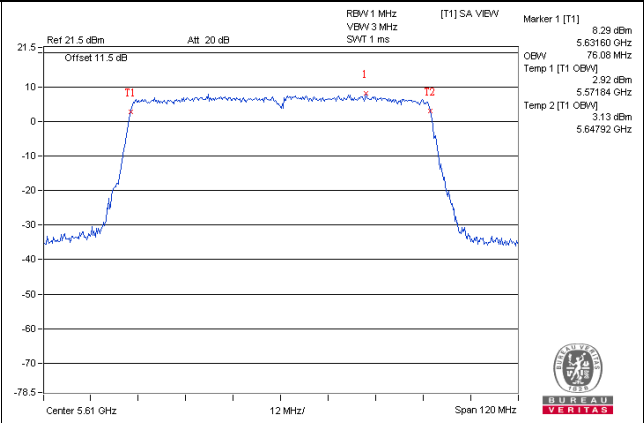

Test Mode I

802.11a

Chan.	Freq. (MHz)	Occupied Bandwidth (MHz)	
		Chain 0	Chain 1
52	5260	16.56	16.56
60	5300	16.56	16.44
64	5320	16.56	16.56
100	5500	16.56	16.56
116	5580	16.56	16.56
140	5700	16.56	16.56
144	5720 For U-NII-2C	13.28	13.28
144	5720 For U-NII-3	3.04	3.04

802.11n (HT20)

Chan.	Freq. (MHz)	Occupied Bandwidth (MHz)	
		Chain 0	Chain 1
52	5260	17.76	17.76
60	5300	17.64	17.76
64	5320	17.76	17.76
100	5500	17.76	17.76
116	5580	17.64	17.76
140	5700	17.76	17.76
144	5720 For U-NII-2C	13.88	13.88
144	5720 For U-NII-3	3.64	3.64

802.11n (HT40)

Chan.	Freq. (MHz)	Occupied Bandwidth (MHz)	
		Chain 0	Chain 1
54	5270	36.24	36.24
62	5310	36.24	36.24
102	5510	36.24	36.24
110	5550	36.24	36.24
134	5670	36.24	36.24
142	5710 For U-NII-2C	33.24	33.24
142	5710 For U-NII-3	3.00	2.88

802.11ac (VHT80)

Chan.	Freq. (MHz)	Occupied Bandwidth (MHz)	
		Chain 0	Chain 1
58	5290	75.84	75.84
106	5530	75.84	76.08
122	5610	75.84	75.84
138	5690 For U-NII-2C	73.16	73.16
138	5690 For U-NII-3	2.68	2.68

Spectrum Plot of Worst Value

802.11a

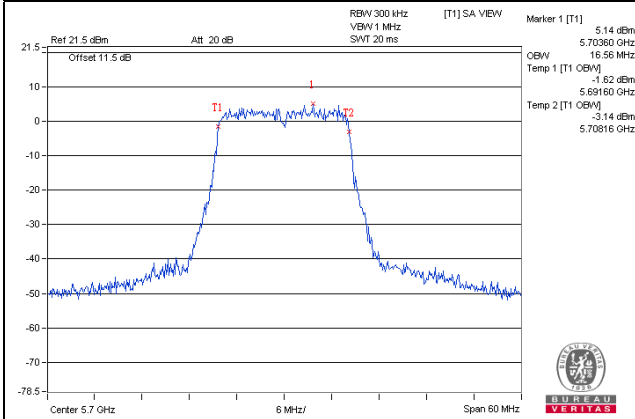

802.11n (HT20)

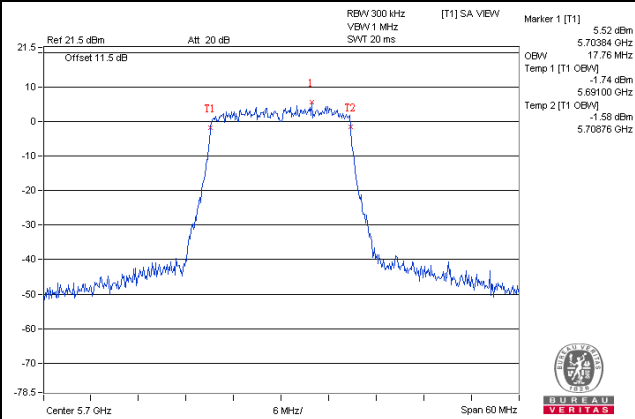

802.11n (HT40)

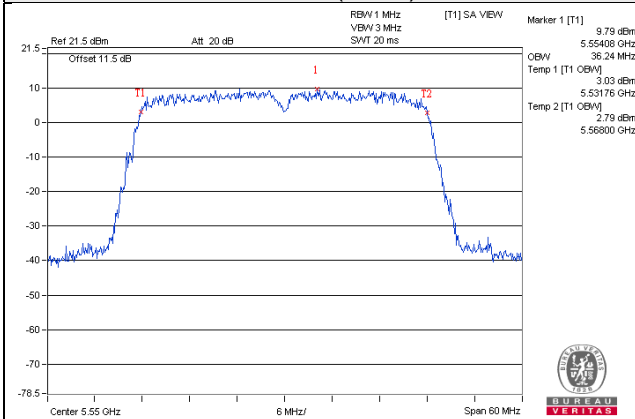

802.11ac (VHT80)

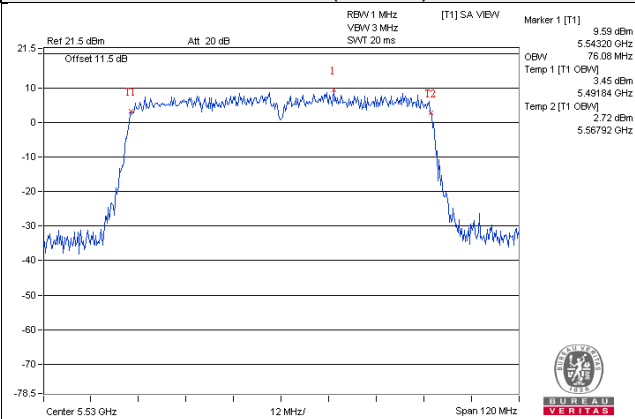

Test Mode K

802.11a

Chan.	Freq. (MHz)	Occupied Bandwidth (MHz)	
		Chain 0	Chain 1
52	5260	16.56	16.44
60	5300	16.56	16.44
64	5320	16.56	16.56
100	5500	16.56	16.56
116	5580	16.56	16.56
140	5700	16.44	16.56
144	5720 For U-NII-2C	13.28	13.28
144	5720 For U-NII-3	3.04	3.04

802.11n (HT20)

Chan.	Freq. (MHz)	Occupied Bandwidth (MHz)	
		Chain 0	Chain 1
52	5260	17.76	17.64
60	5300	17.76	17.64
64	5320	17.76	17.64
100	5500	17.76	17.76
116	5580	17.76	17.76
140	5700	17.76	17.76
144	5720 For U-NII-2C	13.88	13.88
144	5720 For U-NII-3	3.64	3.64

802.11n (HT40)

Chan.	Freq. (MHz)	Occupied Bandwidth (MHz)	
		Chain 0	Chain 1
54	5270	36.24	36.24
62	5310	36.36	36.24
102	5510	36.24	36.24
110	5550	36.24	36.24
134	5670	36.36	36.24
142	5710 For U-NII-2C	33.36	33.36
142	5710 For U-NII-3	3.00	3.00

802.11ac (VHT80)

Chan.	Freq. (MHz)	Occupied Bandwidth (MHz)	
		Chain 0	Chain 1
58	5290	76.08	76.08
106	5530	75.84	75.84
122	5610	75.84	75.84
138	5690 For U-NII-2C	73.16	73.16
138	5690 For U-NII-3	2.68	2.92

Spectrum Plot of Worst Value

802.11a

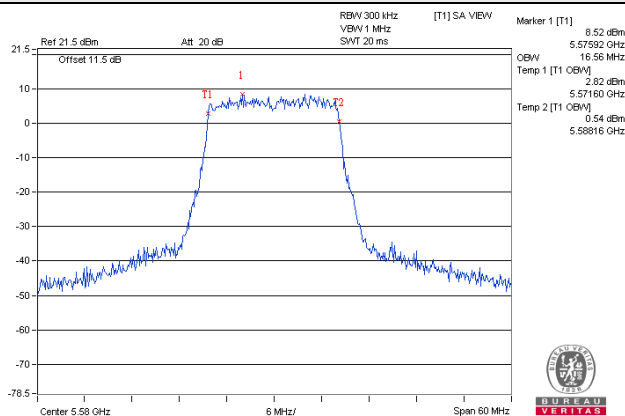

802.11n (HT20)

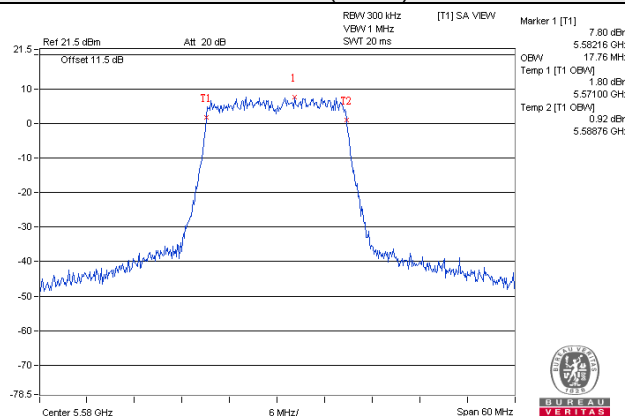

802.11n (HT40)

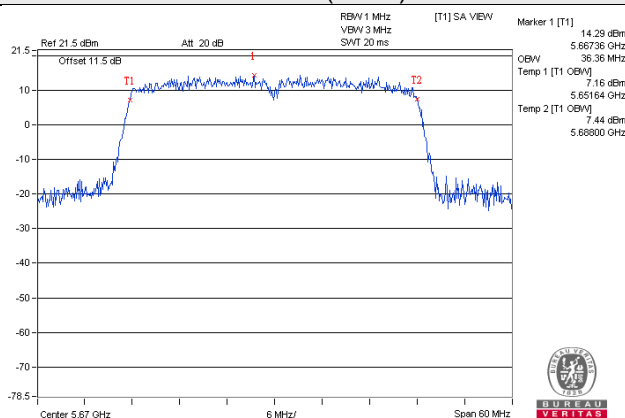

802.11ac (VHT80)

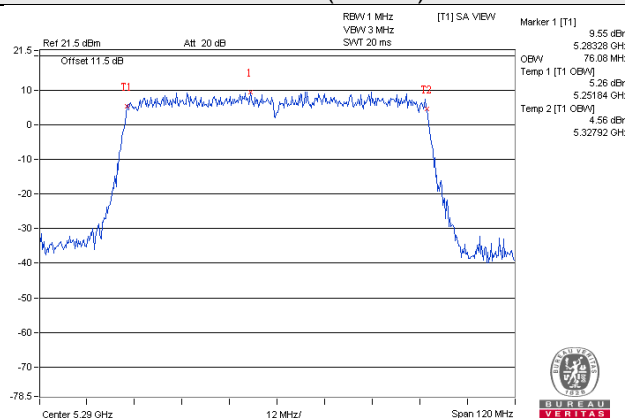

4.5 Peak Power Spectral Density Measurement

4.5.1 Limits of Peak Power Spectral Density Measurement

Operation Band	EUT Category		Limit
U-NII-1		Outdoor Access Point	17dBm/ MHz
		Fixed point-to-point Access Point	
		Indoor Access Point	
		Mobile and Portable client device	11dBm/ MHz
U-NII-2A	√		11dBm/ MHz
U-NII-2C	√		11dBm/ MHz
U-NII-3	√		30dBm/ 500kHz

4.5.2 Test Setup

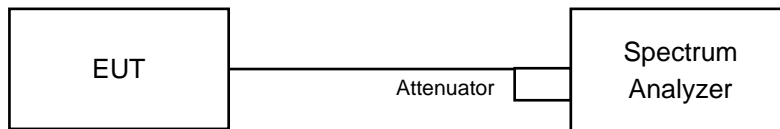

4.5.3 Test Instruments

Refer to section 4.1.2 to get information of above instrument.

4.5.4 Test Procedures

For U-NII-2A, U-NII-2C band:

Duty cycle of test signal is > 98%

Using method SA-1

- Set span to encompass the entire emission bandwidth (EBW) of the signal.
- Set RBW = 1 MHz, Set VBW ≥ 3 MHz, Detector = RMS
- Sweep time = auto, trigger set to “free run”.
- Trace average at least 100 traces in power averaging mode.
- Record the max value

Duty cycle of test signal is < 98%

Using method SA-2

- Set span to encompass the entire emission bandwidth (EBW) of the signal.
- Set RBW = 1MHz, Set VBW ≥ 3 MHz, Detector = RMS
- Set Channel power measure = 1MHz
- Sweep time = auto, trigger set to “free run”.
- Trace average at least 100 traces in power averaging mode.
- Record the max value and add 10 log (1/duty cycle)

For U-NII-3 band:

Duty cycle of test signal is > 98%

- a. Set span to encompass the entire emission bandwidth (EBW) of the signal.
- b. Set RBW = 300 kHz, Set VBW \geq 1 MHz, Detector = RMS
- c. Use the peak marker function to determine the maximum power level in any 300 kHz band segment within the fundamental EBW.
- d. Scale the observed power level to an equivalent value in 500 kHz by adjusting (reducing) the measured power by a bandwidth correction factor (BWCF) where $BWCF = 10\log(500 \text{ kHz}/300\text{kHz})$
- e. Sweep time = auto, trigger set to "free run".
- f. Trace average at least 100 traces in power averaging mode.
- g. Record the max value

Duty cycle of test signal is < 98%

- a. Set span to encompass the entire emission bandwidth (EBW) of the signal.
- b. Set RBW = 300 kHz, Set VBW \geq 1 MHz, Detector = RMS
- c. Use the peak marker function to determine the maximum power level in any 300 kHz band segment within the fundamental EBW.
- d. Scale the observed power level to an equivalent value in 500 kHz by adjusting (reducing) the measured power by a bandwidth correction factor (BWCF) where $BWCF = 10\log(500 \text{ kHz} / 300 \text{ kHz})$
- e. Sweep time = auto, trigger set to "free run".
- f. Trace average at least 100 traces in power averaging mode.
- g. Record the max value and add $10 \log (1/\text{duty cycle})$

4.5.5 Deviation from Test Standard

No deviation.

4.5.6 EUT Operating Conditions

Same as 4.3.6.

4.5.7 Test Results

Test Mode B

For U-NII-2A, U-NII-2C band:

802.11a

Chan.	Freq. (MHz)	PSD w/o Duty Factor (dBm/MHz)		Duty Factor (dB)	Total PSD with Duty Factor (dBm/MHz)	Max. Limit (dBm/MHz)	Pass / Fail
		Chain 0	Chain 1				
52	5260	4.99	5.70	0.19	8.56	8.99	Pass
60	5300	3.57	6.00	0.19	8.15	8.99	Pass
64	5320	4.95	5.68	0.19	8.53	8.99	Pass
100	5500	5.14	5.60	0.19	8.57	8.99	Pass
116	5580	4.92	5.76	0.19	8.56	8.99	Pass
140	5700	3.64	4.31	0.19	7.18	8.99	Pass
144	5720	5.48	5.17	0.19	8.52	8.99	Pass

Note:

- Method 1 of power density measurement of KDB 662911 is using for calculating total power density. Total power density is summing entire spectra across corresponding frequency bins on the various outputs by computer.
- Directional gain = 5dBi + 10log(2) = 8.01dBi > 6dBi, so the power density limit shall be reduced to 11-(8.01-6) = 8.99dBm.
- Refer to section 3.3 for duty cycle spectrum plot.

802.11n (HT20)

Chan.	Freq. (MHz)	PSD w/o Duty Factor (dBm/MHz)		Duty Factor (dB)	Total PSD with Duty Factor (dBm/MHz)	Max. Limit (dBm/MHz)	Pass / Fail
		Chain 0	Chain 1				
52	5260	4.19	6.29	0.09	8.47	8.99	Pass
60	5300	5.70	4.40	0.09	8.20	8.99	Pass
64	5320	3.48	5.43	0.09	7.67	8.99	Pass
100	5500	5.57	5.08	0.09	8.43	8.99	Pass
116	5580	5.83	4.87	0.09	8.48	8.99	Pass
140	5700	3.40	3.34	0.09	6.47	8.99	Pass
144	5720	5.59	5.15	0.09	8.48	8.99	Pass

Note:

- Method 1 of power density measurement of KDB 662911 is using for calculating total power density. Total power density is summing entire spectra across corresponding frequency bins on the various outputs by computer.
- Directional gain = 5dBi + 10log(2) = 8.01dBi > 6dBi, so the power density limit shall be reduced to 11-(8.01-6) = 8.99dBm.
- Refer to section 3.3 for duty cycle spectrum plot.

802.11n (HT40)

Chan.	Freq. (MHz)	PSD w/o Duty Factor (dBm/MHz)		Duty Factor (dB)	Total PSD with Duty Factor (dBm/MHz)	Max. Limit (dBm/MHz)	Pass / Fail
		Chain 0	Chain 1				
54	5270	2.09	4.06	0.19	6.38	8.99	Pass
62	5310	-0.33	0.86	0.19	3.50	8.99	Pass
102	5510	-0.24	0.27	0.19	3.22	8.99	Pass
110	5550	3.95	3.93	0.19	7.14	8.99	Pass
134	5670	3.43	3.66	0.19	6.74	8.99	Pass
142	5710	4.98	4.78	0.19	8.08	8.99	Pass

Note:

1. Method 1 of power density measurement of KDB 662911 is using for calculating total power density. Total power density is summing entire spectra across corresponding frequency bins on the various outputs by computer.
2. Directional gain = $5\text{dBi} + 10\log(2) = 8.01\text{dBi} > 6\text{dBi}$, so the power density limit shall be reduced to $11 - (8.01 - 6) = 8.99\text{dBm}$.
3. Refer to section 3.3 for duty cycle spectrum plot.

802.11ac (VHT80)

Chan.	Freq. (MHz)	PSD w/o Duty Factor (dBm/MHz)		Duty Factor (dB)	Total PSD with Duty Factor (dBm/MHz)	Max. Limit (dBm/MHz)	Pass / Fail
		Chain 0	Chain 1				
58	5290	-5.56	-4.11	0.35	-1.41	8.99	Pass
106	5530	-5.39	-4.72	0.35	-1.68	8.99	Pass
122	5610	2.68	2.48	0.35	5.94	8.99	Pass
138	5690	1.49	1.33	0.35	4.77	8.99	Pass

Note:

1. Method 1 of power density measurement of KDB 662911 is using for calculating total power density. Total power density is summing entire spectra across corresponding frequency bins on the various outputs by computer.
2. Directional gain = $5\text{dBi} + 10\log(2) = 8.01\text{dBi} > 6\text{dBi}$, so the power density limit shall be reduced to $11 - (8.01 - 6) = 8.99\text{dBm}$.
3. Refer to section 3.3 for duty cycle spectrum plot.

Spectrum Plot of Worst Value

802.11a / Chain 1 / CH 60

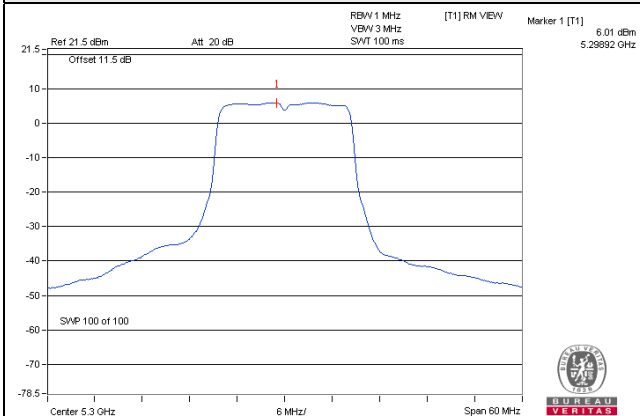

802.11n (HT20) / Chain 1 / CH 52

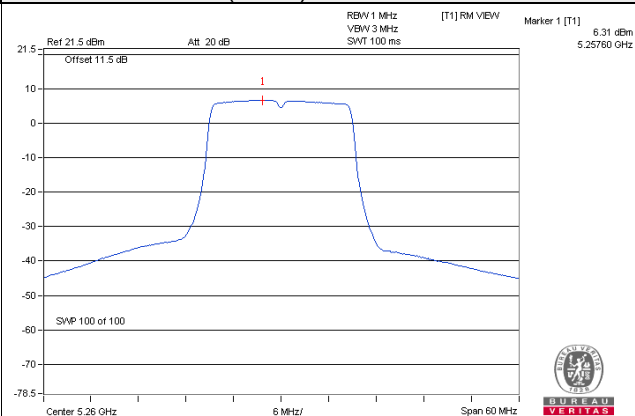

802.11n (HT40) / Chain 0 / CH 142

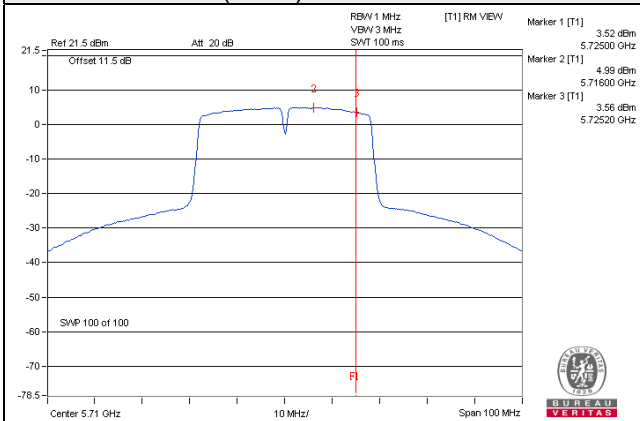

802.11ac (VHT80) / Chain 0 / CH 122

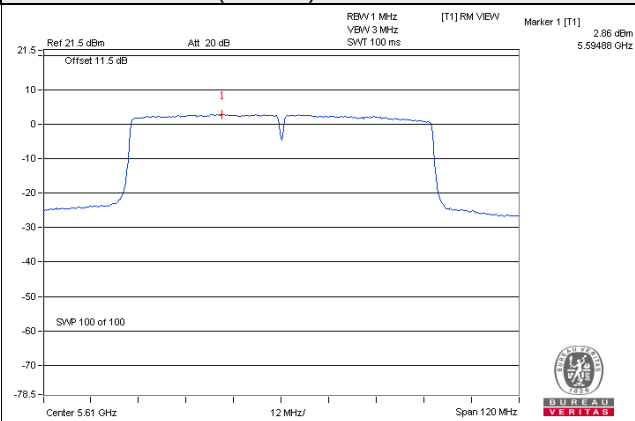

For U-NII-3 band:

802.11a

TX chain	Chan.	Freq. (MHz)	PSD W/O Duty Factor		10 log (N=2) dB	Duty Factor (dB)	Total PSD With Duty Factor (dBm/500kHz)	Limit (dBm/500kHz)	Pass / Fail
			(dBm/300kHz)	(dBm/500kHz)					
0	144	5720	-2.19	0.03	3.01	0.19	3.23	27.99	Pass
1	144	5720	-2.67	-0.45	3.01	0.19	2.75	27.99	Pass

Note:

1. Method 1 of power density measurement of KDB 662911 is using for calculating total power density. Total power density is summing entire spectra across corresponding frequency bins on the various outputs by computer.
2. Directional gain = 5dBi + 10log(2) = 8.01dBi > 6dBi, so the power density limit shall be reduced to 30-(8.01-6) = 27.99dBm.
3. Refer to section 3.3 for duty cycle spectrum plot.

802.11n (HT20)

TX chain	Chan.	Freq. (MHz)	PSD W/O Duty Factor		10 log (N=2) dB	Duty Factor (dB)	Total PSD With Duty Factor (dBm/500kHz)	Limit (dBm/500kHz)	Pass / Fail
			(dBm/300kHz)	(dBm/500kHz)					
0	144	5720	-2.49	-0.27	3.01	0.09	2.83	27.99	Pass
1	144	5720	-2.68	-0.46	3.01	0.09	2.64	27.99	Pass

Note:

1. Method 1 of power density measurement of KDB 662911 is using for calculating total power density. Total power density is summing entire spectra across corresponding frequency bins on the various outputs by computer.
2. Directional gain = 5dBi + 10log(2) = 8.01dBi > 6dBi, so the power density limit shall be reduced to 30-(8.01-6) = 27.99dBm.
3. Refer to section 3.3 for duty cycle spectrum plot.

802.11n (HT40)

TX chain	Chan.	Freq. (MHz)	PSD W/O Duty Factor		10 log (N=2) dB	Duty Factor (dB)	Total PSD With Duty Factor (dBm/500kHz)	Limit (dBm/500kHz)	Pass / Fail
			(dBm/300kHz)	(dBm/500kHz)					
0	142	5710	-4.79	-2.57	3.01	0.19	0.63	27.99	Pass
1	142	5710	-4.75	-2.53	3.01	0.19	0.67	27.99	Pass

Note:

1. Method 1 of power density measurement of KDB 662911 is using for calculating total power density. Total power density is summing entire spectra across corresponding frequency bins on the various outputs by computer.
2. Directional gain = 5dBi + 10log(2) = 8.01dBi > 6dBi, so the power density limit shall be reduced to 30-(8.01-6) = 27.99dBm.
3. Refer to section 3.3 for duty cycle spectrum plot.

802.11ac (VHT80)

TX chain	Chan.	Freq. (MHz)	PSD W/O Duty Factor		10 log (N=2) dB	Duty Factor (dB)	Total PSD With Duty Factor (dBm/500kHz)	Limit (dBm/500kHz)	Pass / Fail
			(dBm/300kHz)	(dBm/500kHz)					
0	138	5690	-7.88	-5.66	3.01	0.35	-2.30	27.99	Pass
1	138	5690	-8.13	-5.91	3.01	0.35	-2.55	27.99	Pass

Note:

1. Method 1 of power density measurement of KDB 662911 is using for calculating total power density. Total power density is summing entire spectra across corresponding frequency bins on the various outputs by computer.
2. Directional gain = 5dBi + 10log(2) = 8.01dBi > 6dBi, so the power density limit shall be reduced to 30-(8.01-6) = 27.99dBm.
3. Refer to section 3.3 for duty cycle spectrum plot.

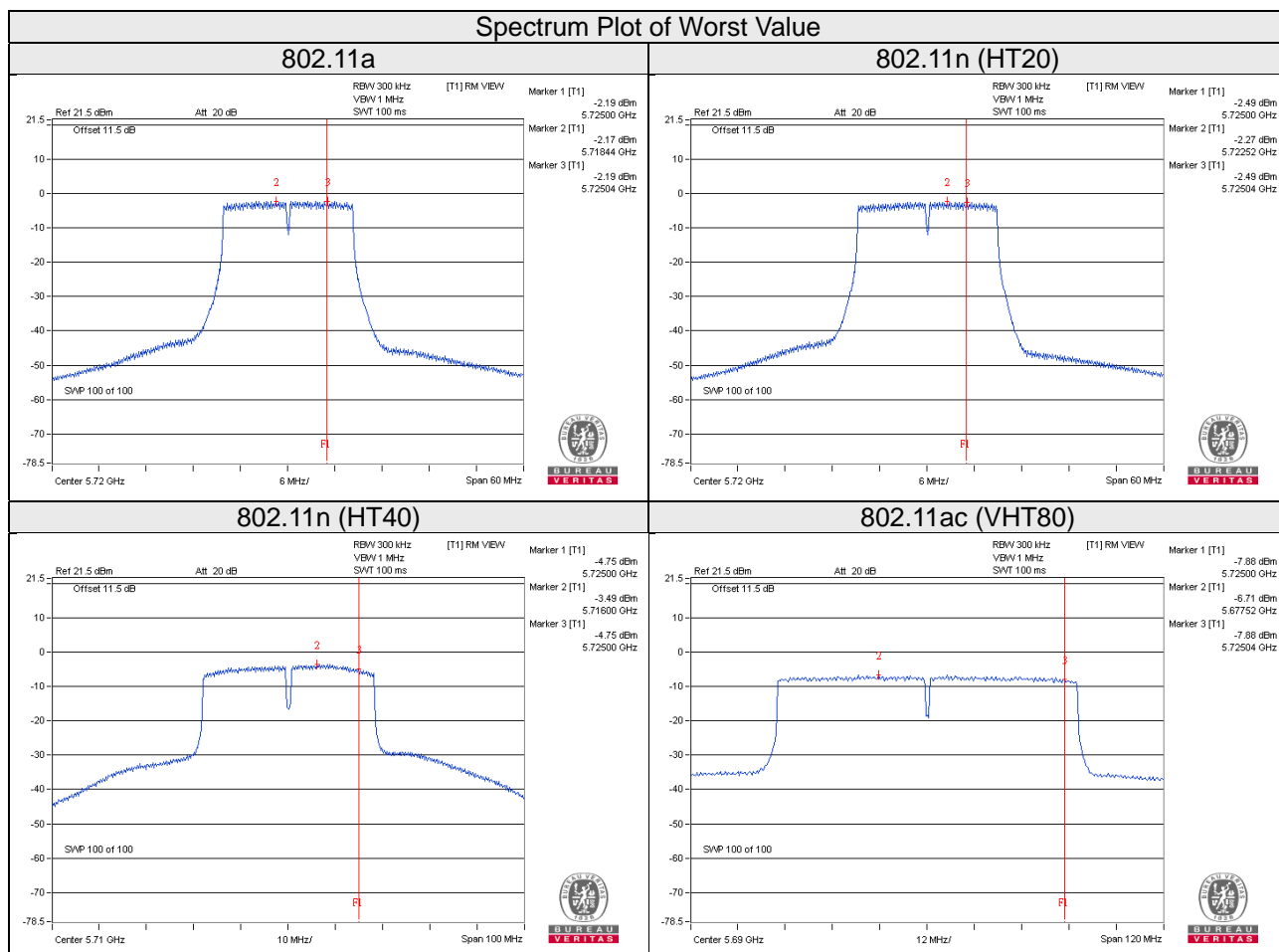

Test Mode D

For U-NII-2A, U-NII-2C band:

802.11a

Chan.	Freq. (MHz)	PSD w/o Duty Factor (dBm/MHz)		Duty Factor (dB)	Total PSD with Duty Factor (dBm/MHz)	Max. Limit (dBm/MHz)	Pass / Fail
		Chain 0	Chain 1				
52	5260	3.65	3.14	0.17	6.58	6.69	Pass
60	5300	3.62	3.33	0.17	6.66	6.69	Pass
64	5320	3.51	3.26	0.17	6.57	6.69	Pass
100	5500	3.00	3.69	0.17	6.54	6.69	Pass
116	5580	2.80	3.41	0.17	6.29	6.69	Pass
140	5700	3.52	3.09	0.17	6.49	6.69	Pass
144	5720	3.39	3.59	0.17	6.67	6.69	Pass

Note:

- Method 1 of power density measurement of KDB 662911 is using for calculating total power density. Total power density is summing entire spectra across corresponding frequency bins on the various outputs by computer.
- Directional gain = $7.3\text{dBi} + 10\log(2) = 10.31\text{dBi} > 6\text{dBi}$, so the power density limit shall be reduced to $11 - (10.31 - 6) = 6.69\text{dBm}$.
- Refer to section 3.3 for duty cycle spectrum plot.

802.11n (HT20)

Chan.	Freq. (MHz)	PSD (dBm/MHz)		Total PSD (dBm/MHz)	Max. Limit (dBm/MHz)	Pass / Fail
		Chain 0	Chain 1			
52	5260	3.23	2.90	6.08	6.69	Pass
60	5300	3.27	3.15	6.22	6.69	Pass
64	5320	3.25	3.20	6.24	6.69	Pass
100	5500	2.97	4.01	6.53	6.69	Pass
116	5580	3.29	2.87	6.10	6.69	Pass
140	5700	3.69	3.00	6.37	6.69	Pass
144	5720	3.20	2.75	5.99	6.69	Pass

Note:

- Method 1 of power density measurement of KDB 662911 is using for calculating total power density. Total power density is summing entire spectra across corresponding frequency bins on the various outputs by computer.
- Directional gain = $7.3\text{dBi} + 10\log(2) = 10.31\text{dBi} > 6\text{dBi}$, so the power density limit shall be reduced to $11 - (10.31 - 6) = 6.69\text{dBm}$.

802.11n (HT40)

Chan.	Freq. (MHz)	PSD w/o Duty Factor (dBm/MHz)		Duty Factor (dB)	Total PSD with Duty Factor (dBm/MHz)	Max. Limit (dBm/MHz)	Pass / Fail
		Chain 0	Chain 1				
54	5270	3.20	3.04	0.18	6.31	6.69	Pass
62	5310	2.73	2.54	0.18	5.82	6.69	Pass
102	5510	2.59	3.65	0.18	6.34	6.69	Pass
110	5550	2.71	3.40	0.18	6.26	6.69	Pass
134	5670	3.15	3.11	0.18	6.32	6.69	Pass
142	5710	3.62	3.16	0.18	6.58	6.69	Pass

Note:

1. Method 1 of power density measurement of KDB 662911 is using for calculating total power density. Total power density is summing entire spectra across corresponding frequency bins on the various outputs by computer.
2. Directional gain = $7.3\text{dBi} + 10\log(2) = 10.31\text{dBi} > 6\text{dBi}$, so the power density limit shall be reduced to $11 - (10.31 - 6) = 6.69\text{dBm}$.
3. Refer to section 3.3 for duty cycle spectrum plot.

802.11ac (VHT80)

Chan.	Freq. (MHz)	PSD w/o Duty Factor (dBm/MHz)		Duty Factor (dB)	Total PSD with Duty Factor (dBm/MHz)	Max. Limit (dBm/MHz)	Pass / Fail
		Chain 0	Chain 1				
58	5290	-1.42	-1.91	0.32	1.67	6.69	Pass
106	5530	-2.02	-1.00	0.32	1.85	6.69	Pass
122	5610	1.28	1.21	0.32	4.58	6.69	Pass
138	5690	0.25	0.17	0.32	3.54	6.69	Pass

Note:

1. Method 1 of power density measurement of KDB 662911 is using for calculating total power density. Total power density is summing entire spectra across corresponding frequency bins on the various outputs by computer.
2. Directional gain = $7.3\text{dBi} + 10\log(2) = 10.31\text{dBi} > 6\text{dBi}$, so the power density limit shall be reduced to $11 - (10.31 - 6) = 6.69\text{dBm}$.
3. Refer to section 3.3 for duty cycle spectrum plot.

Spectrum Plot of Worst Value

802.11a / Chain 1 / CH 100

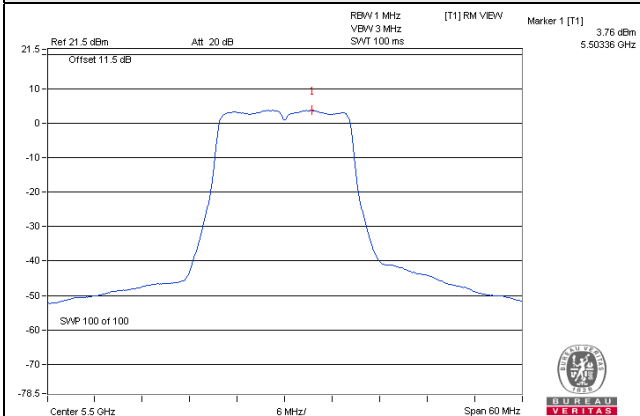

802.11n (HT20) / Chain 1 / CH 100

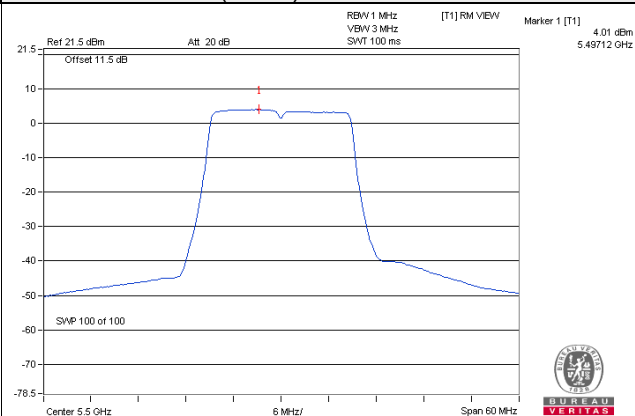

802.11n (HT40) / Chain 1 / CH 102

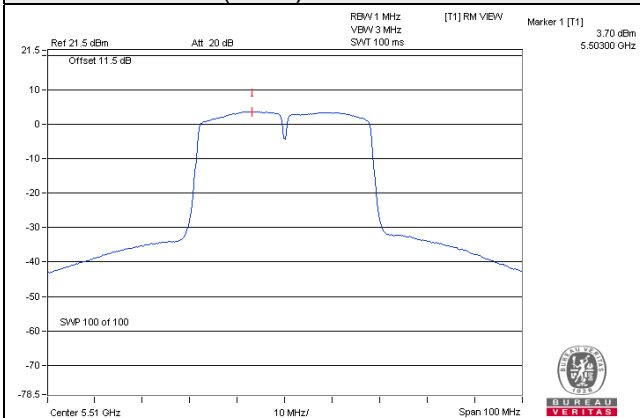

802.11ac (VHT80) / Chain 0 / CH 122

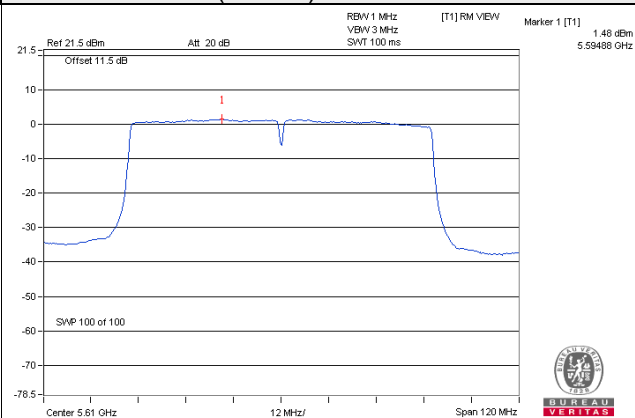

For U-NII-3 band:

802.11a

TX chain	Chan.	Freq. (MHz)	PSD W/O Duty Factor		10 log (N=2) dB	Duty Factor (dB)	Total PSD With Duty Factor (dBm/500kHz)	Limit (dBm/500kHz)	Pass / Fail
			(dBm/300kHz)	(dBm/500kHz)					
0	144	5720	-4.76	-2.54	3.01	0.17	0.64	25.69	Pass
1	144	5720	-4.79	-2.57	3.01	0.17	0.61	25.69	Pass

Note:

- Method 1 of power density measurement of KDB 662911 is using for calculating total power density. Total power density is summing entire spectra across corresponding frequency bins on the various outputs by computer.
- Directional gain = $7.3\text{dBi} + 10\log(2) = 10.31\text{dBi} > 6\text{dBi}$, so the power density limit shall be reduced to $30 - (10.31 - 6) = 25.69\text{dBm}$.
- Refer to section 3.3 for duty cycle spectrum plot.

802.11n (HT20)

TX chain	Chan.	Freq. (MHz)	PSD		10 log (N=2) dB	Total PSD (dBm/500kHz)	Limit (dBm/500kHz)	Pass / Fail
			(dBm/300kHz)	(dBm/500kHz)				
0	144	5720	-4.94	-2.72	3.01	0.29	25.69	Pass
1	144	5720	-5.11	-2.89	3.01	0.12	25.69	Pass

Note:

- Method 1 of power density measurement of KDB 662911 is using for calculating total power density. Total power density is summing entire spectra across corresponding frequency bins on the various outputs by computer.
- Directional gain = $7.3\text{dBi} + 10\log(2) = 10.31\text{dBi} > 6\text{dBi}$, so the power density limit shall be reduced to $30 - (10.31 - 6) = 25.69\text{dBm}$.

802.11n (HT40)

TX chain	Chan.	Freq. (MHz)	PSD W/O Duty Factor		10 log (N=2) dB	Duty Factor (dB)	Total PSD With Duty Factor (dBm/500kHz)	Limit (dBm/500kHz)	Pass / Fail
			(dBm/300kHz)	(dBm/500kHz)					
0	142	5710	-6.53	-4.31	3.01	0.18	-1.12	25.69	Pass
1	142	5710	-6.81	-4.59	3.01	0.18	-1.40	25.69	Pass

Note:

- Method 1 of power density measurement of KDB 662911 is using for calculating total power density. Total power density is summing entire spectra across corresponding frequency bins on the various outputs by computer.
- Directional gain = $7.3\text{dBi} + 10\log(2) = 10.31\text{dBi} > 6\text{dBi}$, so the power density limit shall be reduced to $30 - (10.31 - 6) = 25.69\text{dBm}$.
- Refer to section 3.3 for duty cycle spectrum plot.

802.11ac (VHT80)

TX chain	Chan.	Freq. (MHz)	PSD W/O Duty Factor		10 log (N=2) dB	Duty Factor (dB)	Total PSD With Duty Factor (dBm/500kHz)	Limit (dBm/500kHz)	Pass / Fail
			(dBm/300kHz)	(dBm/500kHz)					
0	138	5690	-9.04	-6.82	3.01	0.32	-3.49	25.69	Pass
1	138	5690	-9.24	-7.02	3.01	0.32	-3.69	25.69	Pass

Note:

1. Method 1 of power density measurement of KDB 662911 is using for calculating total power density. Total power density is summing entire spectra across corresponding frequency bins on the various outputs by computer.
2. Directional gain = $7.3\text{dBi} + 10\log(2) = 10.31\text{dBi} > 6\text{dBi}$, so the power density limit shall be reduced to $30 - (10.31 - 6) = 25.69\text{dBm}$.
3. Refer to section 3.3 for duty cycle spectrum plot.

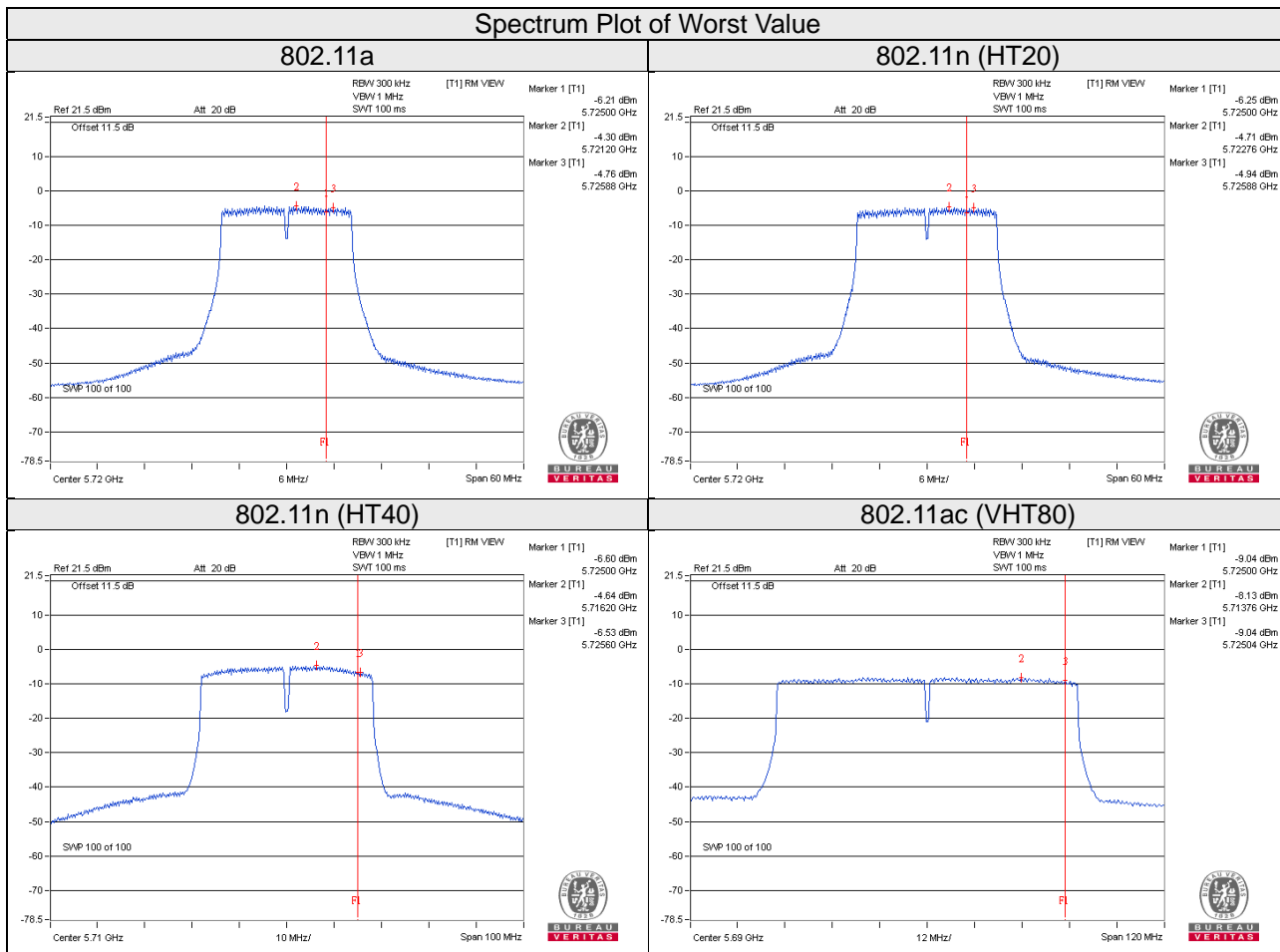

Test Mode E

For U-NII-2A, U-NII-2C band:

802.11a

Chan.	Freq. (MHz)	PSD w/o Duty Factor (dBm/MHz)		Duty Factor (dB)	Total PSD with Duty Factor (dBm/MHz)	Max. Limit (dBm/MHz)	Pass / Fail
		Chain 0	Chain 1				
52	5260	4.67	4.15	0.17	7.60	7.99	Pass
60	5300	4.79	4.26	0.17	7.71	7.99	Pass
64	5320	4.82	4.24	0.17	7.72	7.99	Pass
100	5500	3.94	4.95	0.17	7.65	7.99	Pass
116	5580	4.07	4.68	0.17	7.56	7.99	Pass
140	5700	4.66	4.47	0.17	7.74	7.99	Pass
144	5720	3.39	3.59	0.17	6.67	7.99	Pass

Note:

1. Method 1 of power density measurement of KDB 662911 is using for calculating total power density. Total power density is summing entire spectra across corresponding frequency bins on the various outputs by computer.
2. Directional gain = $6\text{dBi} + 10\log(2) = 9.01\text{dBi} > 6\text{dBi}$, so the power density limit shall be reduced to $11 - (9.01 - 6) = 7.99\text{dBm}$.
3. Refer to section 3.3 for duty cycle spectrum plot.

802.11n (HT20)

Chan.	Freq. (MHz)	PSD (dBm/MHz)		Total PSD (dBm/MHz)	Max. Limit (dBm/MHz)	Pass / Fail
		Chain 0	Chain 1			
52	5260	3.23	2.90	7.58	7.99	Pass
60	5300	3.27	3.15	7.72	7.99	Pass
64	5320	3.25	3.20	7.74	7.99	Pass
100	5500	2.97	4.01	7.53	7.99	Pass
116	5580	3.29	2.87	7.60	7.99	Pass
140	5700	3.69	3.00	7.87	7.99	Pass
144	5720	3.20	2.75	5.99	7.99	Pass

Note:

1. Method 1 of power density measurement of KDB 662911 is using for calculating total power density. Total power density is summing entire spectra across corresponding frequency bins on the various outputs by computer.
2. Directional gain = $6\text{dBi} + 10\log(2) = 9.01\text{dBi} > 6\text{dBi}$, so the power density limit shall be reduced to $11 - (9.01 - 6) = 7.99\text{dBm}$.

802.11n (HT40)

Chan.	Freq. (MHz)	PSD w/o Duty Factor (dBm/MHz)		Duty Factor (dB)	Total PSD with Duty Factor (dBm/MHz)	Max. Limit (dBm/MHz)	Pass / Fail
		Chain 0	Chain 1				
54	5270	3.65	3.36	0.18	7.70	7.99	Pass
62	5310	2.73	2.54	0.18	5.82	7.99	Pass
102	5510	3.09	3.70	0.18	6.59	7.99	Pass
110	5550	4.53	4.95	0.18	7.93	7.99	Pass
134	5670	3.33	3.08	0.18	7.39	7.99	Pass
142	5710	3.62	3.16	0.18	6.58	7.99	Pass

Note:

- Method 1 of power density measurement of KDB 662911 is using for calculating total power density. Total power density is summing entire spectra across corresponding frequency bins on the various outputs by computer.
- Directional gain = $6\text{dBi} + 10\log(2) = 9.01\text{dBi} > 6\text{dBi}$, so the power density limit shall be reduced to $11 - (9.01 - 6) = 7.99\text{dBm}$.
- Refer to section 3.3 for duty cycle spectrum plot.

802.11ac (VHT80)

Chan.	Freq. (MHz)	PSD w/o Duty Factor (dBm/MHz)		Duty Factor (dB)	Total PSD with Duty Factor (dBm/MHz)	Max. Limit (dBm/MHz)	Pass / Fail
		Chain 0	Chain 1				
58	5290	-1.42	-1.91	0.32	1.67	7.99	Pass
106	5530	-2.02	-1.00	0.32	1.85	7.99	Pass
122	5610	1.28	1.21	0.32	4.58	7.99	Pass
138	5690	0.25	0.17	0.32	3.54	7.99	Pass

Note:

- Method 1 of power density measurement of KDB 662911 is using for calculating total power density. Total power density is summing entire spectra across corresponding frequency bins on the various outputs by computer.
- Directional gain = $6\text{dBi} + 10\log(2) = 9.01\text{dBi} > 6\text{dBi}$, so the power density limit shall be reduced to $11 - (9.01 - 6) = 7.99\text{dBm}$.
- Refer to section 3.3 for duty cycle spectrum plot.

Spectrum Plot of Worst Value

802.11a / Chain 1 / CH 100

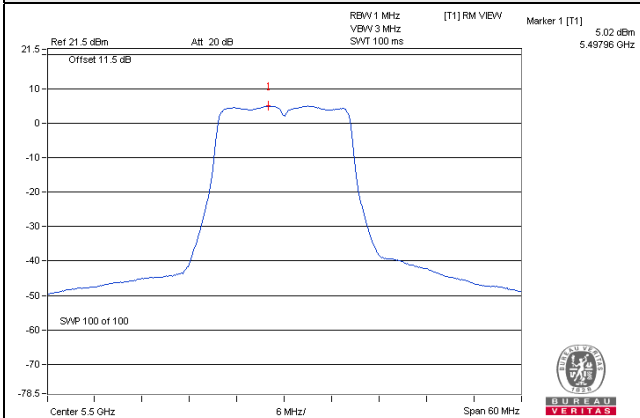

802.11n (HT20) / Chain 1 / CH 100

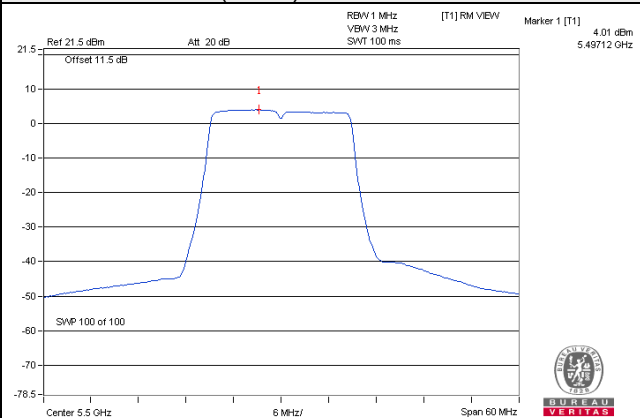

802.11n (HT40) / Chain 1 / CH 110

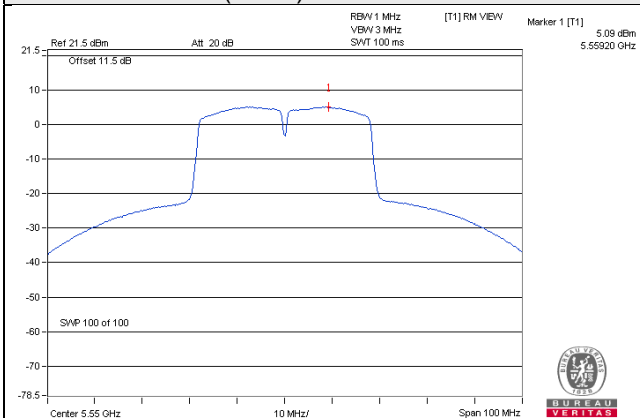

802.11ac (VHT80) / Chain 0 / CH 122

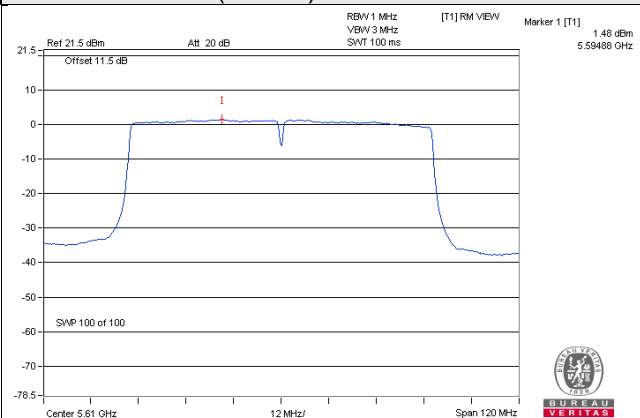

For U-NII-3 band:

802.11a

TX chain	Chan.	Freq. (MHz)	PSD W/O Duty Factor		10 log (N=2) dB	Duty Factor (dB)	Total PSD With Duty Factor (dBm/500kHz)	Limit (dBm/500kHz)	Pass / Fail
			(dBm/300kHz)	(dBm/500kHz)					
0	144	5720	-4.76	-2.54	3.01	0.17	0.64	26.99	Pass
1	144	5720	-4.79	-2.57	3.01	0.17	0.61	26.99	Pass

Note:

1. Method 1 of power density measurement of KDB 662911 is using for calculating total power density. Total power density is summing entire spectra across corresponding frequency bins on the various outputs by computer.
2. Directional gain = 6dBi + 10log(2) = 9.01dBi > 6dBi, so the power density limit shall be reduced to 30-(9.01-6) = 26.99dBm.
3. Refer to section 3.3 for duty cycle spectrum plot.

802.11n (HT20)

TX chain	Chan.	Freq. (MHz)	PSD		10 log (N=2) dB	Total PSD (dBm/500kHz)	Limit (dBm/500kHz)	Pass / Fail
			(dBm/300kHz)	(dBm/500kHz)				
0	144	5720	-4.94	-2.72	3.01	0.29	26.99	Pass
1	144	5720	-5.11	-2.89	3.01	0.12	26.99	Pass

Note:

1. Method 1 of power density measurement of KDB 662911 is using for calculating total power density. Total power density is summing entire spectra across corresponding frequency bins on the various outputs by computer.
2. Directional gain = 6dBi + 10log(2) = 9.01dBi > 6dBi, so the power density limit shall be reduced to 30-(9.01-6) = 26.99dBm.

802.11n (HT40)

TX chain	Chan.	Freq. (MHz)	PSD W/O Duty Factor		10 log (N=2) dB	Duty Factor (dB)	Total PSD With Duty Factor (dBm/500kHz)	Limit (dBm/500kHz)	Pass / Fail
			(dBm/300kHz)	(dBm/500kHz)					
0	142	5710	-6.53	-4.31	3.01	0.18	-1.12	26.99	Pass
1	142	5710	-6.81	-4.59	3.01	0.18	-1.40	26.99	Pass

Note:

1. Method 1 of power density measurement of KDB 662911 is using for calculating total power density. Total power density is summing entire spectra across corresponding frequency bins on the various outputs by computer.
2. Directional gain = 6dBi + 10log(2) = 9.01dBi > 6dBi, so the power density limit shall be reduced to 30-(9.01-6) = 26.99dBm.
3. Refer to section 3.3 for duty cycle spectrum plot.

802.11ac (VHT80)

TX chain	Chan.	Freq. (MHz)	PSD W/O Duty Factor		10 log (N=2) dB	Duty Factor (dB)	Total PSD With Duty Factor (dBm/500kHz)	Limit (dBm/500kHz)	Pass / Fail
			(dBm/300kHz)	(dBm/500kHz)					
0	138	5690	-9.04	-6.82	3.01	0.32	-3.49	26.99	Pass
1	138	5690	-9.24	-7.02	3.01	0.32	-3.69	26.99	Pass

Note:

1. Method 1 of power density measurement of KDB 662911 is using for calculating total power density. Total power density is summing entire spectra across corresponding frequency bins on the various outputs by computer.
2. Directional gain = 6dBi + 10log(2) = 9.01dBi > 6dBi, so the power density limit shall be reduced to 30-(9.01-6) = 26.99dBm.
3. Refer to section 3.3 for duty cycle spectrum plot.

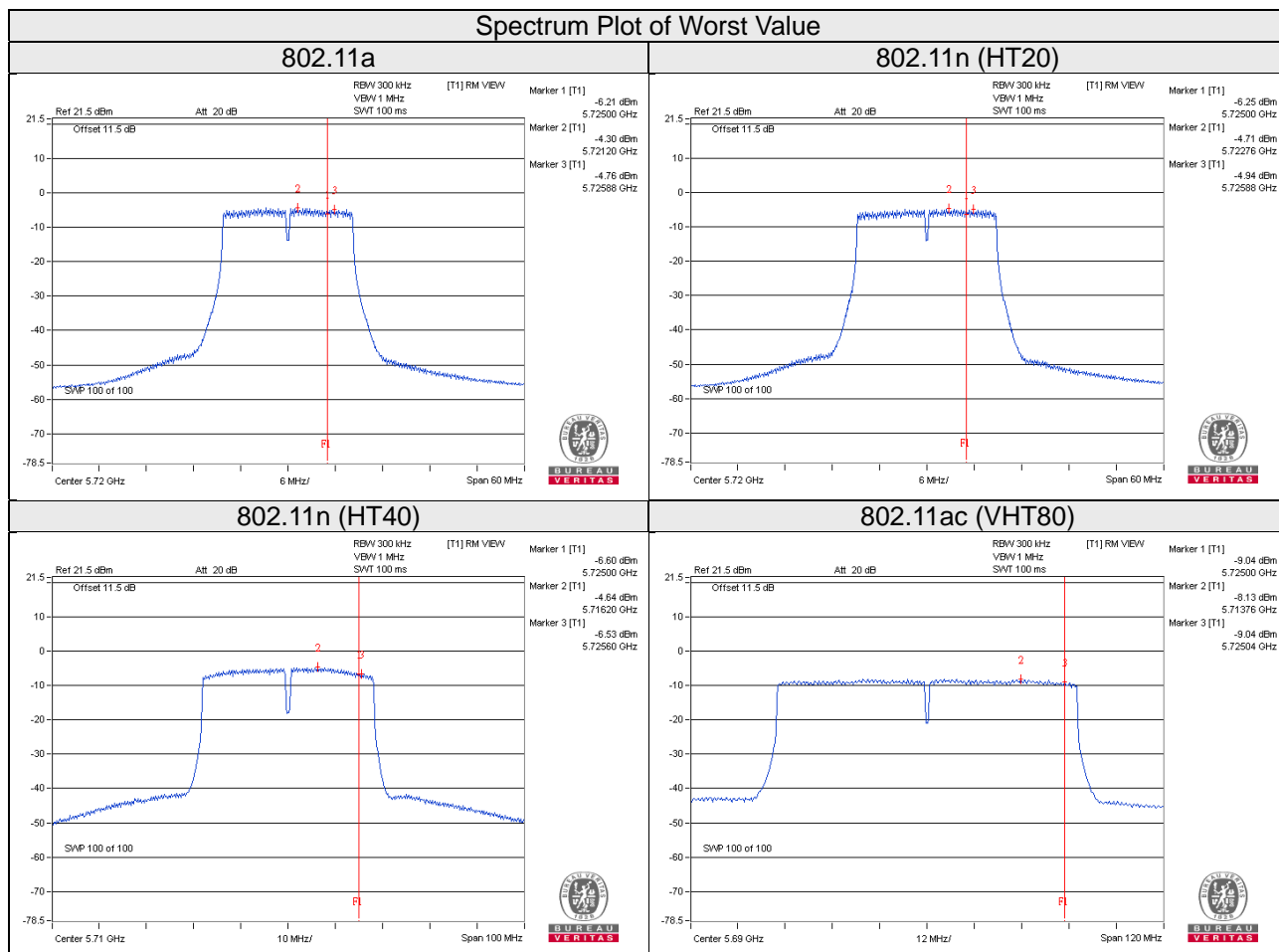

Test Mode G

For U-NII-2A, U-NII-2C band:

802.11a

Chan.	Freq. (MHz)	PSD w/o Duty Factor (dBm/MHz)		Duty Factor (dB)	Total PSD with Duty Factor (dBm/MHz)	Max. Limit (dBm/MHz)	Pass / Fail
		Chain 0	Chain 1				
52	5260	2.81	2.43	0.18	5.82	6.30	Pass
60	5300	2.78	2.58	0.18	5.87	6.30	Pass
64	5320	3.05	2.94	0.18	6.19	6.30	Pass
100	5500	2.25	3.53	0.18	6.13	6.30	Pass
116	5580	2.41	2.87	0.18	5.84	6.30	Pass
140	5700	2.68	2.63	0.18	5.85	6.30	Pass
144	5720	3.10	2.89	0.18	6.19	6.30	Pass

Note:

1. This antenna was cross-polarized antenn.
2. Gain = 10.7dBi > 6dBi, so the power density limit shall be reduced to $11-(10.7-6) = 6.30\text{dBm}$.
3. Refer to section 3.3 for duty cycle spectrum plot.

802.11n (HT20)

Chan.	Freq. (MHz)	PSD (dBm/MHz)		Total PSD (dBm/MHz)	Max. Limit (dBm/MHz)	Pass / Fail
		Chain 0	Chain 1			
52	5260	2.95	2.77	5.87	6.30	Pass
60	5300	2.99	2.95	5.98	6.30	Pass
64	5320	2.84	2.75	5.81	6.30	Pass
100	5500	2.19	3.18	5.73	6.30	Pass
116	5580	2.43	1.88	5.18	6.30	Pass
140	5700	3.06	2.29	5.70	6.30	Pass
144	5720	2.99	2.12	5.59	6.30	Pass

Note:

1. This antenna was cross-polarized antenn.
2. Gain = 10.7dBi > 6dBi, so the power density limit shall be reduced to $11-(10.7-6) = 6.30\text{dBm}$.

802.11n (HT40)

Chan.	Freq. (MHz)	PSD w/o Duty Factor (dBm/MHz)		Duty Factor (dB)	Total PSD with Duty Factor (dBm/MHz)	Max. Limit (dBm/MHz)	Pass / Fail
		Chain 0	Chain 1				
54	5270	1.38	1.31	0.17	4.53	6.30	Pass
62	5310	1.41	1.14	0.17	4.46	6.30	Pass
102	5510	0.58	1.37	0.17	4.18	6.30	Pass
110	5550	1.02	1.54	0.17	4.47	6.30	Pass
134	5670	-0.25	-0.34	0.17	2.89	6.30	Pass
142	5710	-0.15	-0.74	0.17	2.75	6.30	Pass

Note:

1. This antenna was cross-polarized antenn.
2. Gain = 10.7dBi > 6dBi, so the power density limit shall be reduced to $11-(10.7-6) = 6.30\text{dBm}$.
3. Refer to section 3.3 for duty cycle spectrum plot.

802.11ac (VHT80)

Chan.	Freq. (MHz)	PSD w/o Duty Factor (dBm/MHz)		Duty Factor (dB)	Total PSD with Duty Factor (dBm/MHz)	Max. Limit (dBm/MHz)	Pass / Fail
		Chain 0	Chain 1				
58	5290	-2.38	-2.57	0.33	0.87	6.30	Pass
106	5530	-3.77	-3.00	0.33	-0.03	6.30	Pass
122	5610	-2.65	-2.72	0.33	0.66	6.30	Pass
138	5690	-3.32	-3.76	0.33	-0.19	6.30	Pass

Note:

1. This antenna was cross-polarized antenn.
2. Gain = 10.7dBi > 6dBi, so the power density limit shall be reduced to $11-(10.7-6) = 6.30\text{dBm}$.
3. Refer to section 3.3 for duty cycle spectrum plot.

Spectrum Plot of Worst Value

802.11a / Chain 1 / CH 100

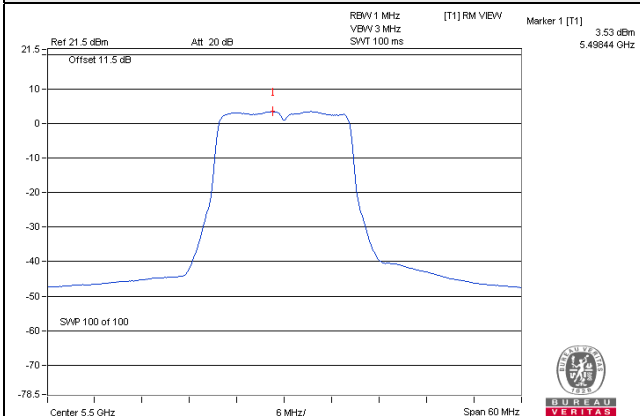

802.11n (HT20) / Chain 1 / CH 100

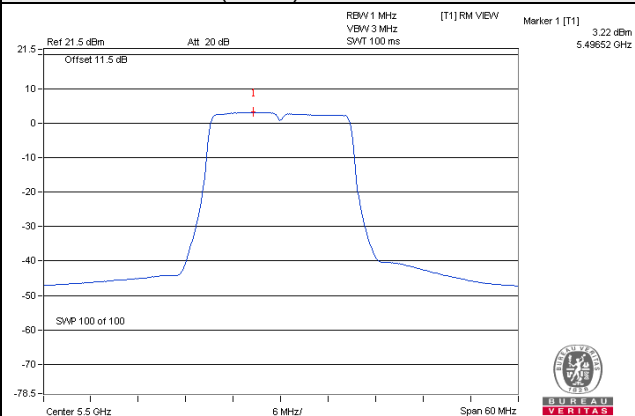

802.11n (HT40) / Chain 1 / CH 110

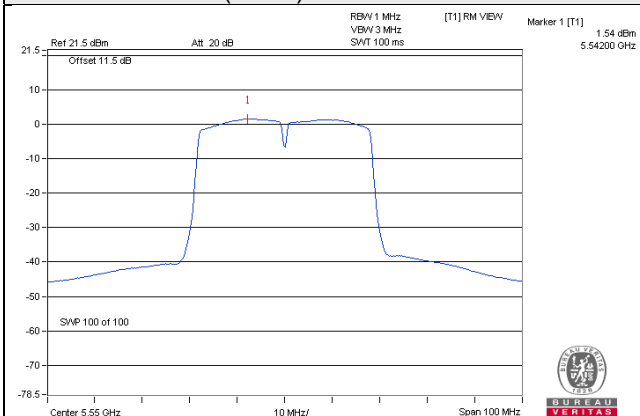

802.11ac (VHT80) / Chain 0 / CH 58

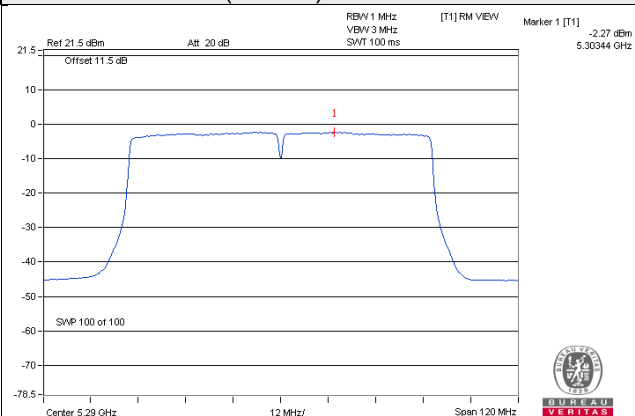

For U-NII-3 band:

802.11a

TX chain	Chan.	Freq. (MHz)	PSD W/O Duty Factor		10 log (N=2) dB	Duty Factor (dB)	Total PSD With Duty Factor (dBm/500kHz)	Limit (dBm/500kHz)	Pass / Fail
			(dBm/300kHz)	(dBm/500kHz)					
0	144	5720	-5.58	-3.36	3.01	0.18	-0.17	25.30	Pass
1	144	5720	-6.02	-3.80	3.01	0.18	-0.61	25.30	Pass

Note:

1. This antenna was cross-polarized antenn.
2. Gain = 10.7dBi > 6dBi, so the power density limit shall be reduced to $30-(10.7-6) = 25.30\text{dBm}$.
3. Refer to section 3.3 for duty cycle spectrum plot.

802.11n (HT20)

TX chain	Chan.	Freq. (MHz)	PSD		10 log (N=2) dB	Total PSD (dBm/500kHz)	Limit (dBm/500kHz)	Pass / Fail
			(dBm/300kHz)	(dBm/500kHz)				
0	144	5720	-5.70	-3.48	3.01	-0.47	25.30	Pass
1	144	5720	-6.20	-3.98	3.01	-0.97	25.30	Pass

Note:

1. This antenna was cross-polarized antenn.
2. Gain = 10.7dBi > 6dBi, so the power density limit shall be reduced to $30-(10.7-6) = 25.30\text{dBm}$.

802.11n (HT40)

TX chain	Chan.	Freq. (MHz)	PSD W/O Duty Factor		10 log (N=2) dB	Duty Factor (dB)	Total PSD With Duty Factor (dBm/500kHz)	Limit (dBm/500kHz)	Pass / Fail
			(dBm/300kHz)	(dBm/500kHz)					
0	142	5710	-10.23	-8.01	3.01	0.17	-4.83	25.30	Pass
1	142	5710	-10.68	-8.46	3.01	0.17	-5.28	25.30	Pass

Note:

1. This antenna was cross-polarized antenn.
2. Gain = 10.7dBi > 6dBi, so the power density limit shall be reduced to $30-(10.7-6) = 25.30\text{dBm}$.
3. Refer to section 3.3 for duty cycle spectrum plot.

802.11ac (VHT80)

TX chain	Chan.	Freq. (MHz)	PSD W/O Duty Factor		10 log (N=2) dB	Duty Factor (dB)	Total PSD With Duty Factor (dBm/500kHz)	Limit (dBm/500kHz)	Pass / Fail
			(dBm/300kHz)	(dBm/500kHz)					
0	138	5690	-12.84	-10.62	3.01	0.33	-7.28	25.30	Pass
1	138	5690	-12.92	-10.70	3.01	0.33	-7.36	25.30	Pass

Note:

1. This antenna was cross-polarized antenn.
2. Gain = 10.7dBi > 6dBi, so the power density limit shall be reduced to $30-(10.7-6) = 25.30\text{dBm}$.
3. Refer to section 3.3 for duty cycle spectrum plot.

Spectrum Plot of Worst Value

802.11a

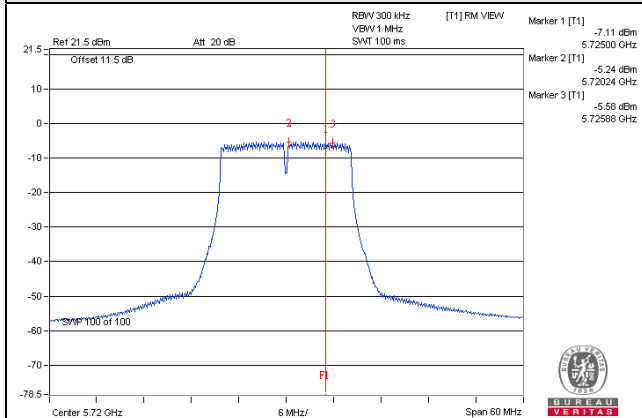

802.11n (HT20)

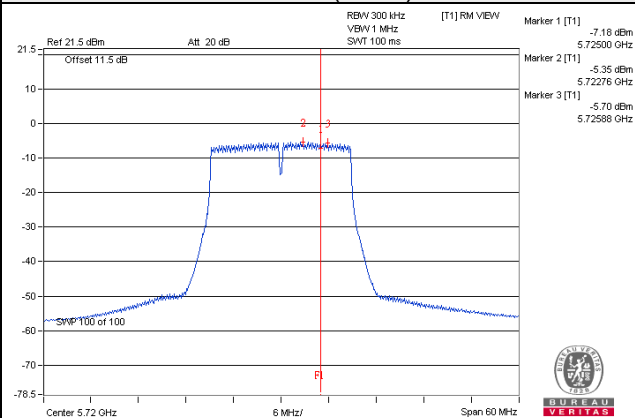

802.11n (HT40)

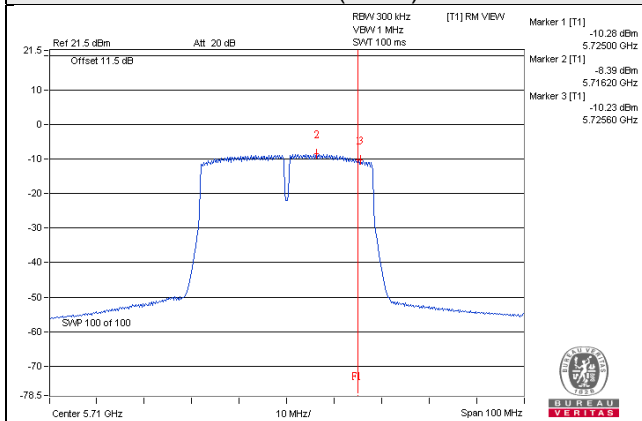

802.11ac (VHT80)

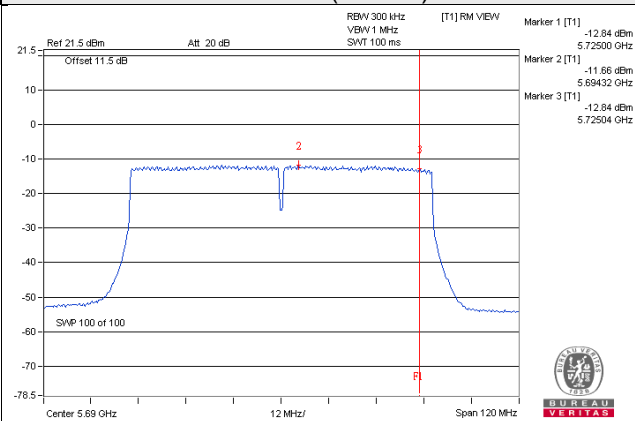

Test Mode I

For U-NII-2A, U-NII-2C band:

802.11a

Chan.	Freq. (MHz)	PSD w/o Duty Factor (dBm/MHz)		Duty Factor (dB)	Total PSD with Duty Factor (dBm/MHz)	Max. Limit (dBm/MHz)	Pass / Fail
		Chain 0	Chain 1				
52	5260	0.11	-0.40	0.21	3.09	3.29	Pass
60	5300	0.25	-0.33	0.21	3.19	3.29	Pass
64	5320	-0.03	-0.27	0.21	3.08	3.29	Pass
100	5500	-0.76	0.11	0.21	2.92	3.29	Pass
116	5580	-0.79	-0.33	0.21	2.67	3.29	Pass
140	5700	-0.05	-0.75	0.21	2.84	3.29	Pass
144	5720	0.06	-0.39	0.21	3.06	3.29	Pass

Note:

1. Method 1 of power density measurement of KDB 662911 is using for calculating total power density. Total power density is summing entire spectra across corresponding frequency bins on the various outputs by computer.
2. Directional gain = $10.7\text{dBi} + 10\log(2) = 13.71\text{dBi} > 6\text{dBi}$, so the power density limit shall be reduced to $11 - (13.71 - 6) = 3.29\text{dBm}$.
3. Refer to section 3.3 for duty cycle spectrum plot.

802.11n (HT20)

Chan.	Freq. (MHz)	PSD (dBm/MHz)		Total PSD (dBm/MHz)	Max. Limit (dBm/MHz)	Pass / Fail
		Chain 0	Chain 1			
52	5260	0.27	-0.10	3.10	3.29	Pass
60	5300	-0.03	-0.55	2.73	3.29	Pass
64	5320	-0.16	-0.45	2.71	3.29	Pass
100	5500	-0.31	0.10	2.91	3.29	Pass
116	5580	0.03	-1.01	2.55	3.29	Pass
140	5700	0.28	-0.65	2.85	3.29	Pass
144	5720	-0.12	-0.87	2.53	3.29	Pass

Note:

1. Method 1 of power density measurement of KDB 662911 is using for calculating total power density. Total power density is summing entire spectra across corresponding frequency bins on the various outputs by computer.
2. Directional gain = $10.7\text{dBi} + 10\log(2) = 13.71\text{dBi} > 6\text{dBi}$, so the power density limit shall be reduced to $11 - (13.71 - 6) = 3.29\text{dBm}$.

802.11n (HT40)

Chan.	Freq. (MHz)	PSD w/o Duty Factor (dBm/MHz)		Duty Factor (dB)	Total PSD with Duty Factor (dBm/MHz)	Max. Limit (dBm/MHz)	Pass / Fail
		Chain 0	Chain 1				
54	5270	-0.03	-0.50	0.15	2.90	3.29	Pass
62	5310	-0.06	-0.47	0.15	2.90	3.29	Pass
102	5510	-0.99	-0.19	0.15	2.59	3.29	Pass
110	5550	-0.66	0.07	0.15	2.88	3.29	Pass
134	5670	-1.40	-1.53	0.15	1.70	3.29	Pass
142	5710	-0.26	-0.76	0.15	2.66	3.29	Pass

Note:

- Method 1 of power density measurement of KDB 662911 is using for calculating total power density. Total power density is summing entire spectra across corresponding frequency bins on the various outputs by computer.
- Directional gain = $10.7\text{dBi} + 10\log(2) = 13.71\text{dBi} > 6\text{dBi}$, so the power density limit shall be reduced to $11 - (13.71 - 6) = 3.29\text{dBm}$.
- Refer to section 3.3 for duty cycle spectrum plot.

802.11ac (VHT80)

Chan.	Freq. (MHz)	PSD w/o Duty Factor (dBm/MHz)		Duty Factor (dB)	Total PSD with Duty Factor (dBm/MHz)	Max. Limit (dBm/MHz)	Pass / Fail
		Chain 0	Chain 1				
58	5290	-3.00	-3.37	0.33	0.16	3.29	Pass
106	5530	-2.73	-1.50	0.33	1.27	3.29	Pass
122	5610	-3.06	-2.57	0.33	0.53	3.29	Pass
138	5690	-3.99	-3.96	0.33	-0.64	3.29	Pass

Note:

- Method 1 of power density measurement of KDB 662911 is using for calculating total power density. Total power density is summing entire spectra across corresponding frequency bins on the various outputs by computer.
- Directional gain = $10.7\text{dBi} + 10\log(2) = 13.71\text{dBi} > 6\text{dBi}$, so the power density limit shall be reduced to $11 - (13.71 - 6) = 3.29\text{dBm}$.
- Refer to section 3.3 for duty cycle spectrum plot.

Spectrum Plot of Worst Value

802.11a / Chain 0 / CH 60

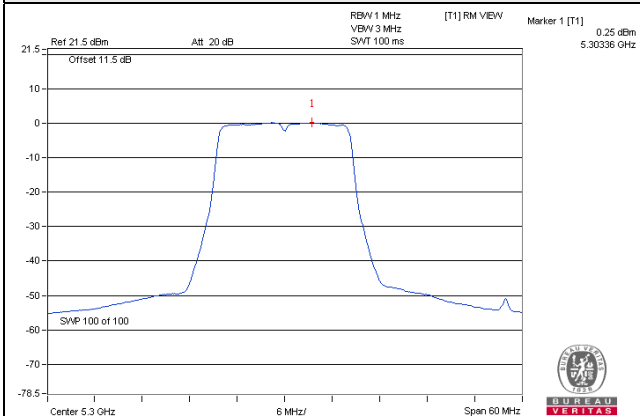

802.11n (HT20) / Chain 0 / CH 140

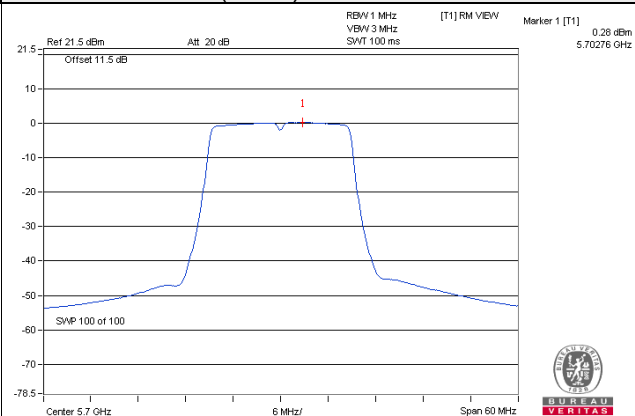

802.11n (HT40) / Chain 1 / CH 110

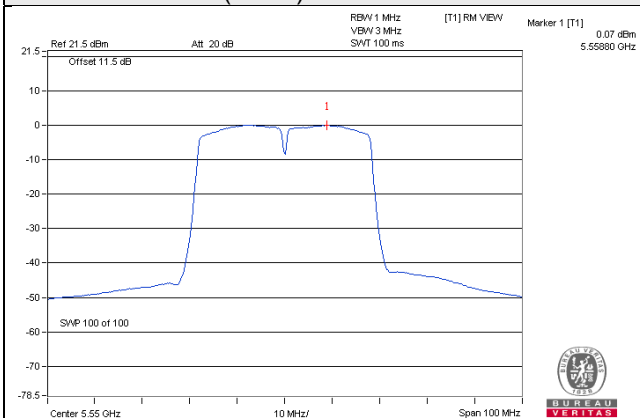

802.11ac (VHT80) / Chain 1 / CH 106

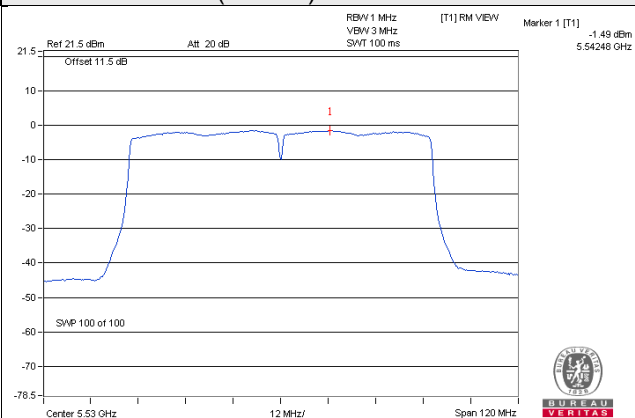

For U-NII-3 band:

802.11a

TX chain	Chan.	Freq. (MHz)	PSD W/O Duty Factor		10 log (N=2) dB	Duty Factor (dB)	Total PSD With Duty Factor (dBm/500kHz)	Limit (dBm/500kHz)	Pass / Fail
			(dBm/300kHz)	(dBm/500kHz)					
0	144	5720	-8.09	-5.87	3.01	0.21	-2.65	22.29	Pass
1	144	5720	-8.63	-6.41	3.01	0.21	-3.19	22.29	Pass

Note:

1. Method 1 of power density measurement of KDB 662911 is using for calculating total power density. Total power density is summing entire spectra across corresponding frequency bins on the various outputs by computer.
2. Directional gain = $10.7\text{dBi} + 10\log(2) = 13.71\text{dBi} > 6\text{dBi}$, so the power density limit shall be reduced to $30 - (13.71 - 6) = 22.29\text{dBm}$.
3. Refer to section 3.3 for duty cycle spectrum plot.

802.11n (HT20)

TX chain	Chan.	Freq. (MHz)	PSD		10 log (N=2) dB	Total PSD (dBm/500kHz)	Limit (dBm/500kHz)	Pass / Fail
			(dBm/300kHz)	(dBm/500kHz)				
0	144	5720	-8.41	-6.19	3.01	-3.18	22.29	Pass
1	144	5720	-8.87	-6.65	3.01	-3.64	22.29	Pass

Note:

1. Method 1 of power density measurement of KDB 662911 is using for calculating total power density. Total power density is summing entire spectra across corresponding frequency bins on the various outputs by computer.
2. Directional gain = $10.7\text{dBi} + 10\log(2) = 13.71\text{dBi} > 6\text{dBi}$, so the power density limit shall be reduced to $30 - (13.71 - 6) = 22.29\text{dBm}$.

802.11n (HT40)

TX chain	Chan.	Freq. (MHz)	PSD W/O Duty Factor		10 log (N=2) dB	Duty Factor (dB)	Total PSD With Duty Factor (dBm/500kHz)	Limit (dBm/500kHz)	Pass / Fail
			(dBm/300kHz)	(dBm/500kHz)					
0	142	5710	-10.43	-8.21	3.01	0.15	-5.05	22.29	Pass
1	142	5710	-10.83	-8.61	3.01	0.15	-5.45	22.29	Pass

Note:

1. Method 1 of power density measurement of KDB 662911 is using for calculating total power density. Total power density is summing entire spectra across corresponding frequency bins on the various outputs by computer.
2. Directional gain = $10.7\text{dBi} + 10\log(2) = 13.71\text{dBi} > 6\text{dBi}$, so the power density limit shall be reduced to $30 - (13.71 - 6) = 22.29\text{dBm}$.
3. Refer to section 3.3 for duty cycle spectrum plot.

802.11ac (VHT80)

TX chain	Chan.	Freq. (MHz)	PSD W/O Duty Factor		10 log (N=2) dB	Duty Factor (dB)	Total PSD With Duty Factor (dBm/500kHz)	Limit (dBm/500kHz)	Pass / Fail
			(dBm/300kHz)	(dBm/500kHz)					
0	138	5690	-13.26	-11.04	3.01	0.33	-7.70	22.29	Pass
1	138	5690	-13.13	-10.91	3.01	0.33	-7.57	22.29	Pass

Note:

- Method 1 of power density measurement of KDB 662911 is using for calculating total power density. Total power density is summing entire spectra across corresponding frequency bins on the various outputs by computer.
- Directional gain = $10.7\text{dBi} + 10\log(2) = 13.71\text{dBi} > 6\text{dBi}$, so the power density limit shall be reduced to $30 - (13.71 - 6) = 22.29\text{dBm}$.
- Refer to section 3.3 for duty cycle spectrum plot.

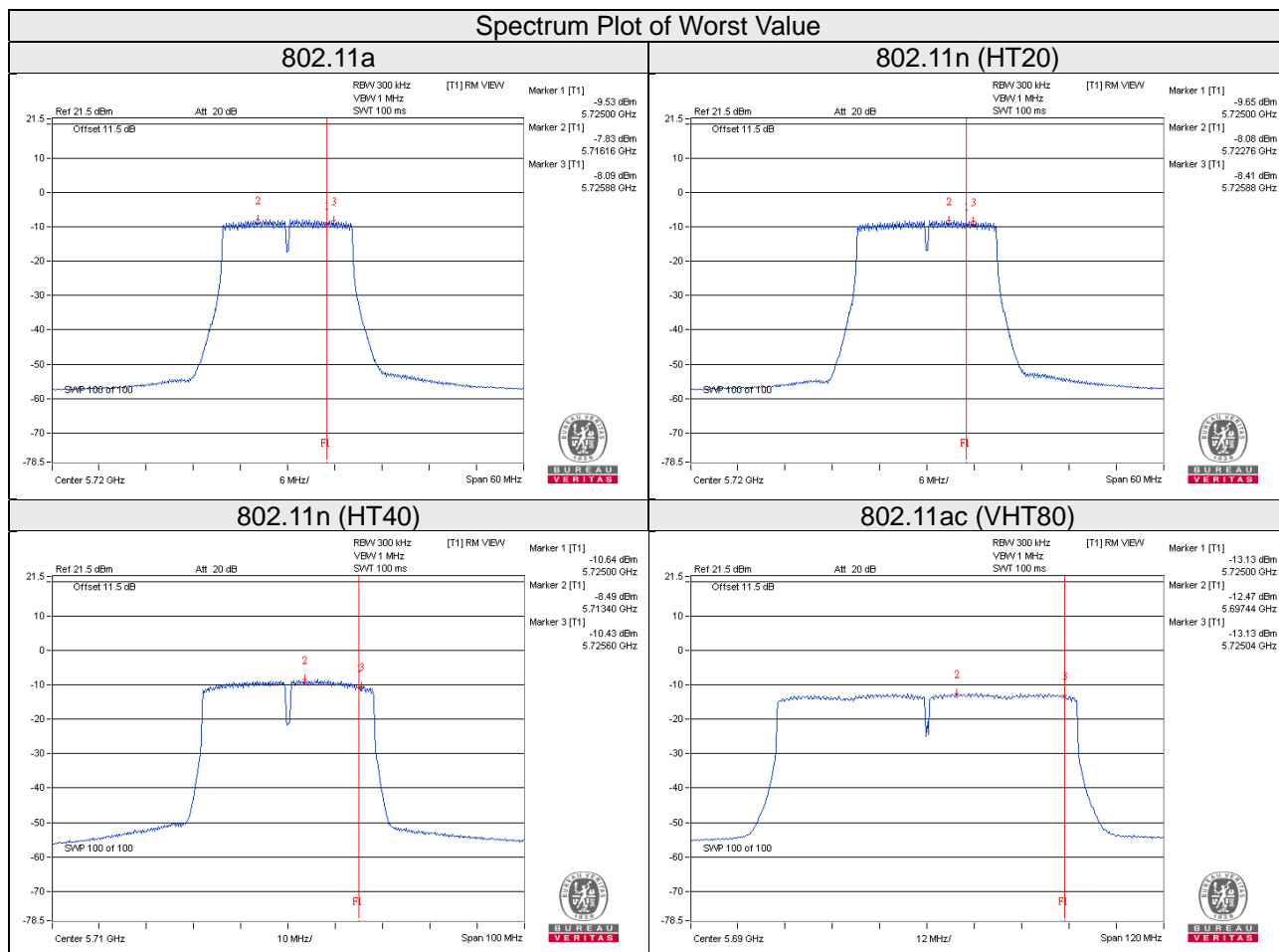

Test Mode K

For U-NII-2A, U-NII-2C band:

802.11a

Chan.	Freq. (MHz)	PSD w/o Duty Factor (dBm/MHz)		Duty Factor (dB)	Total PSD with Duty Factor (dBm/MHz)	Max. Limit (dBm/MHz)	Pass / Fail
		Chain 0	Chain 1				
52	5260	4.35	3.72	0.17	7.23	7.39	Pass
60	5300	4.38	3.92	0.17	7.34	7.39	Pass
64	5320	4.32	3.79	0.17	7.25	7.39	Pass
100	5500	3.53	4.62	0.17	7.29	7.39	Pass
116	5580	3.63	4.38	0.17	7.20	7.39	Pass
140	5700	3.94	3.79	0.17	7.05	7.39	Pass
144	5720	3.80	3.61	0.17	6.89	7.39	Pass

Note:

1. Method 1 of power density measurement of KDB 662911 is using for calculating total power density. Total power density is summing entire spectra across corresponding frequency bins on the various outputs by computer.
2. Directional gain = $6.6\text{dBi} + 10\log(2) = 9.61\text{dBi} > 6\text{dBi}$, so the power density limit shall be reduced to $11 - (9.61 - 6) = 7.39\text{dBm}$.
3. Refer to section 3.3 for duty cycle spectrum plot.

802.11n (HT20)

Chan.	Freq. (MHz)	PSD (dBm/MHz)		Total PSD (dBm/MHz)	Max. Limit (dBm/MHz)	Pass / Fail
		Chain 0	Chain 1			
52	5260	4.10	3.72	6.92	7.39	Pass
60	5300	4.19	3.78	7.00	7.39	Pass
64	5320	4.08	3.86	6.98	7.39	Pass
100	5500	3.59	4.19	6.91	7.39	Pass
116	5580	4.38	3.64	7.04	7.39	Pass
140	5700	3.41	2.59	6.03	7.39	Pass
144	5720	4.18	3.51	6.87	7.39	Pass

Note:

1. Method 1 of power density measurement of KDB 662911 is using for calculating total power density. Total power density is summing entire spectra across corresponding frequency bins on the various outputs by computer.
2. Directional gain = $6.6\text{dBi} + 10\log(2) = 9.61\text{dBi} > 6\text{dBi}$, so the power density limit shall be reduced to $11 - (9.61 - 6) = 7.39\text{dBm}$.

802.11n (HT40)

Chan.	Freq. (MHz)	PSD w/o Duty Factor (dBm/MHz)		Duty Factor (dB)	Total PSD with Duty Factor (dBm/MHz)	Max. Limit (dBm/MHz)	Pass / Fail
		Chain 0	Chain 1				
54	5270	4.27	3.83	0.16	7.22	7.39	Pass
62	5310	4.02	3.39	0.16	6.88	7.39	Pass
102	5510	2.01	3.04	0.16	5.72	7.39	Pass
110	5550	3.56	4.16	0.16	7.04	7.39	Pass
134	5670	3.92	3.63	0.16	6.94	7.39	Pass
142	5710	4.45	3.95	0.16	7.37	7.39	Pass

Note:

1. Method 1 of power density measurement of KDB 662911 is using for calculating total power density. Total power density is summing entire spectra across corresponding frequency bins on the various outputs by computer.
2. Directional gain = $6.6\text{dBi} + 10\log(2) = 9.61\text{dBi} > 6\text{dBi}$, so the power density limit shall be reduced to $11 - (9.61 - 6) = 7.39\text{dBm}$.
3. Refer to section 3.3 for duty cycle spectrum plot.

802.11ac (VHT80)

Chan.	Freq. (MHz)	PSD w/o Duty Factor (dBm/MHz)		Duty Factor (dB)	Total PSD with Duty Factor (dBm/MHz)	Max. Limit (dBm/MHz)	Pass / Fail
		Chain 0	Chain 1				
58	5290	-1.01	-1.85	0.34	1.94	7.39	Pass
106	5530	-2.12	-1.30	0.34	1.66	7.39	Pass
122	5610	1.97	2.14	0.34	5.41	7.39	Pass
138	5690	1.06	0.75	0.34	4.26	7.39	Pass

Note:

1. Method 1 of power density measurement of KDB 662911 is using for calculating total power density. Total power density is summing entire spectra across corresponding frequency bins on the various outputs by computer.
2. Directional gain = $6.6\text{dBi} + 10\log(2) = 9.61\text{dBi} > 6\text{dBi}$, so the power density limit shall be reduced to $11 - (9.61 - 6) = 7.39\text{dBm}$.
3. Refer to section 3.3 for duty cycle spectrum plot.

For U-NII-3 band:

802.11a

TX chain	Chan.	Freq. (MHz)	PSD W/O Duty Factor		10 log (N=2) dB	Duty Factor (dB)	Total PSD With Duty Factor (dBm/500kHz)	Limit (dBm/500kHz)	Pass / Fail
			(dBm/300kHz)	(dBm/500kHz)					
0	144	5720	-4.91	-2.69	3.01	0.17	0.49	26.39	Pass
1	144	5720	-5.01	-2.79	3.01	0.17	0.39	26.39	Pass

Note:

1. Method 1 of power density measurement of KDB 662911 is using for calculating total power density. Total power density is summing entire spectra across corresponding frequency bins on the various outputs by computer.
2. Directional gain = 6.6dBi + 10log(2) = 9.61dBi > 6dBi, so the power density limit shall be reduced to 30-(9.61-6) = 26.39dBm.
3. Refer to section 3.3 for duty cycle spectrum plot.

802.11n (HT20)

TX chain	Chan.	Freq. (MHz)	PSD		10 log (N=2) dB	Total PSD (dBm/500kHz)	Limit (dBm/500kHz)	Pass / Fail
			(dBm/300kHz)	(dBm/500kHz)				
0	144	5720	-4.60	-2.38	3.01	0.63	26.39	Pass
1	144	5720	-4.80	-2.58	3.01	0.43	26.39	Pass

Note:

1. Method 1 of power density measurement of KDB 662911 is using for calculating total power density. Total power density is summing entire spectra across corresponding frequency bins on the various outputs by computer.
2. Directional gain = 6.6dBi + 10log(2) = 9.61dBi > 6dBi, so the power density limit shall be reduced to 30-(9.61-6) = 26.39dBm.

802.11n (HT40)

TX chain	Chan.	Freq. (MHz)	PSD W/O Duty Factor		10 log (N=2) dB	Duty Factor (dB)	Total PSD With Duty Factor (dBm/500kHz)	Limit (dBm/500kHz)	Pass / Fail
			(dBm/300kHz)	(dBm/500kHz)					
0	142	5710	-5.91	-3.69	3.01	0.16	-0.52	26.39	Pass
1	142	5710	-6.24	-4.02	3.01	0.16	-0.85	26.39	Pass

Note:

1. Method 1 of power density measurement of KDB 662911 is using for calculating total power density. Total power density is summing entire spectra across corresponding frequency bins on the various outputs by computer.
2. Directional gain = 6.6dBi + 10log(2) = 9.61dBi > 6dBi, so the power density limit shall be reduced to 30-(9.61-6) = 26.39dBm.
3. Refer to section 3.3 for duty cycle spectrum plot.

802.11ac (VHT80)

TX chain	Chan.	Freq. (MHz)	PSD W/O Duty Factor		10 log (N=2) dB	Duty Factor (dB)	Total PSD With Duty Factor (dBm/500kHz)	Limit (dBm/500kHz)	Pass / Fail
			(dBm/300kHz)	(dBm/500kHz)					
0	138	5690	-8.54	-6.32	3.01	0.34	-2.97	26.39	Pass
1	138	5690	-8.65	-6.43	3.01	0.34	-3.08	26.39	Pass

Note:

- Method 1 of power density measurement of KDB 662911 is using for calculating total power density. Total power density is summing entire spectra across corresponding frequency bins on the various outputs by computer.
- Directional gain = 6.6dBi + 10log(2) = 9.61dBi > 6dBi, so the power density limit shall be reduced to 30-(9.61-6) = 26.39dBm.
- Refer to section 3.3 for duty cycle spectrum plot.

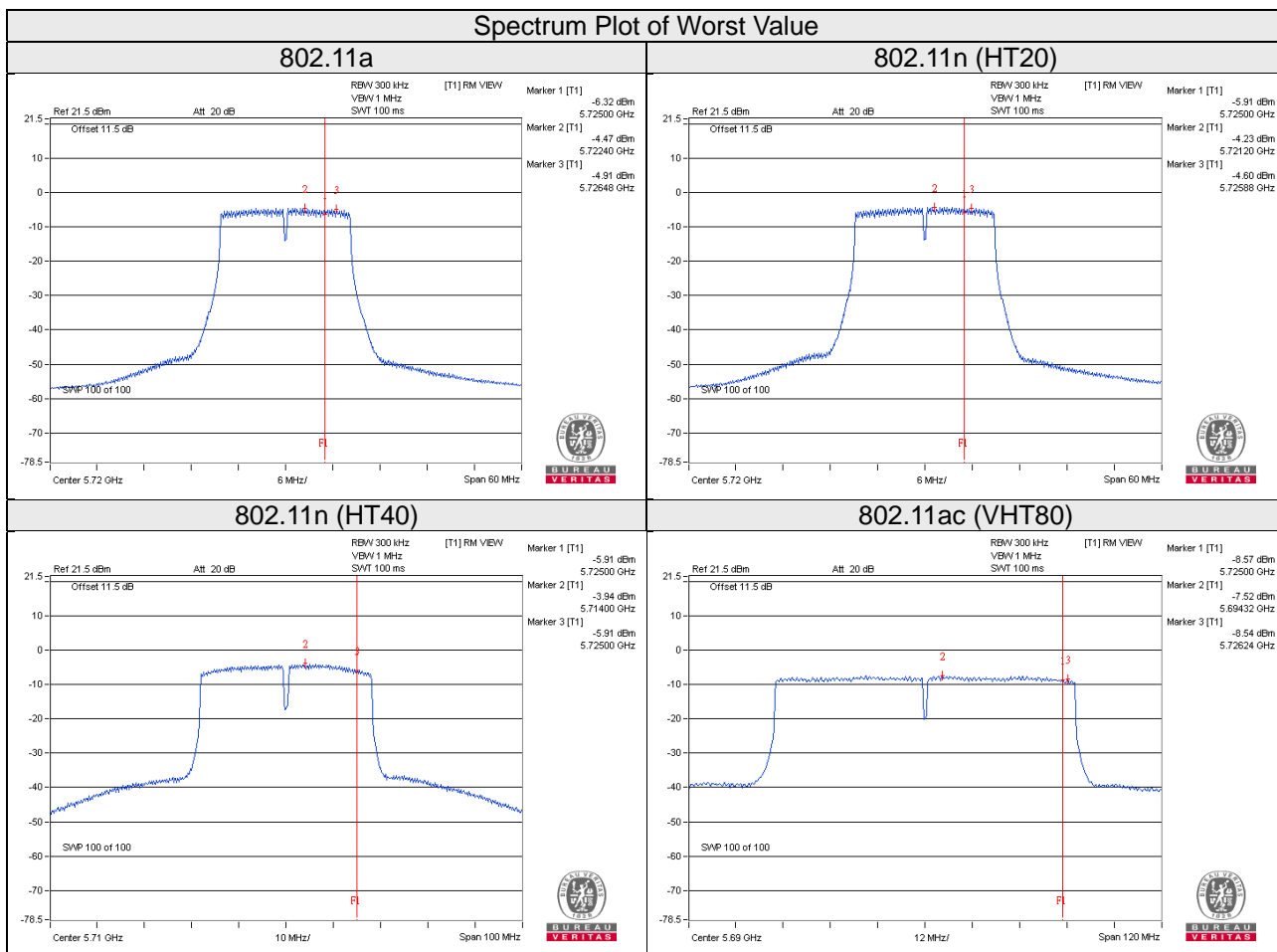

4.6 Frequency Stability

4.6.1 Limits of Frequency Stability Measurement

The frequency of the carrier signal shall be maintained within band of operation

4.6.2 Test Setup

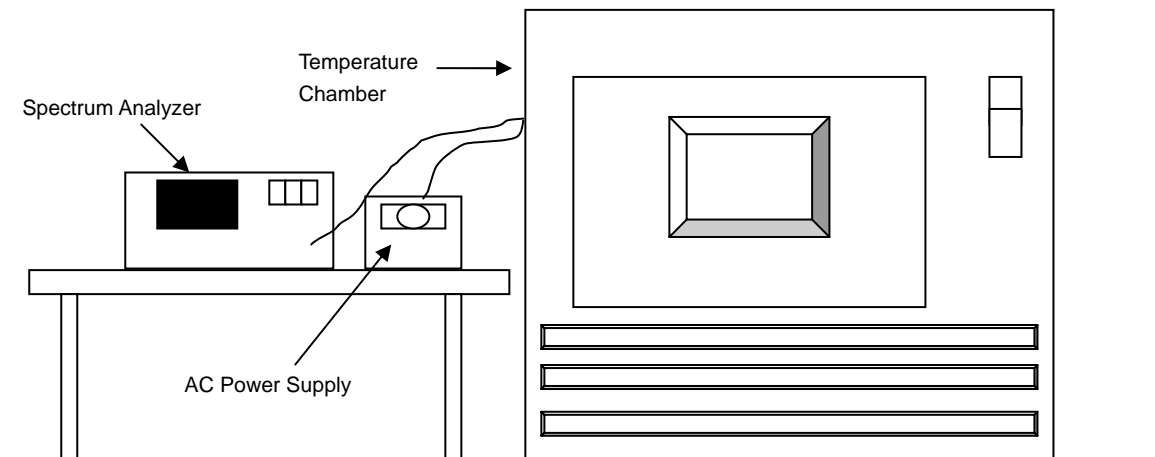

4.6.3 Test Instruments

Refer to section 4.1.2 to get information of above instrument.

4.6.4 Test Procedure

- The EUT was placed inside the environmental test chamber and powered by nominal AC voltage.
- Turn the EUT on and couple its output to a spectrum analyzer.
- Turn the EUT off and set the chamber to the highest temperature specified.
- Allow sufficient time (approximately 30 min) for the temperature of the chamber to stabilize, turn the EUT on and measure the operating frequency after 2, 5, and 10 minutes.
- Repeat step 2 and 3 with the temperature chamber set to the lowest temperature.
- The test chamber was allowed to stabilize at +20 degree C for a minimum of 30 minutes. The supply voltage was then adjusted on the EUT from 85% to 115% and the frequency record.

4.6.5 Deviation from Test Standard

No deviation.

4.6.6 EUT Operating Condition

Set the EUT transmit at un-modulation mode to test frequency stability.

4.6.7 Test Results

Test Mode B

Frequency Stability Versus Temp.									
Operating Frequency: 5700MHz									
Temp. (°C)	Power Supply (Vac)	0 Minute		2 Minute		5 Minute		10 Minute	
		Measured Frequency (MHz)	Frequency Drift (%)	Measured Frequency (MHz)	Frequency Drift (%)	Measured Frequency (MHz)	Frequency Drift (%)	Measured Frequency (MHz)	Frequency Drift (%)
50	120	5699.983	-0.00030	5699.9817	-0.00032	5699.9854	-0.00026	5699.9845	-0.00027
40	120	5700.0119	0.00021	5700.0082	0.00014	5700.013	0.00023	5700.0112	0.00020
30	120	5699.9804	-0.00034	5699.9844	-0.00027	5699.9806	-0.00034	5699.9804	-0.00034
20	120	5700.0032	0.00006	5700.0039	0.00007	5700.0023	0.00004	5700.0025	0.00004
10	120	5699.9706	-0.00052	5699.9726	-0.00048	5699.9753	-0.00043	5699.9736	-0.00046
0	120	5699.9773	-0.00040	5699.9798	-0.00035	5699.9799	-0.00035	5699.9795	-0.00036
-10	120	5700.0189	0.00033	5700.0177	0.00031	5700.0203	0.00036	5700.0223	0.00039
-20	120	5699.9794	-0.00036	5699.9789	-0.00037	5699.9792	-0.00036	5699.9794	-0.00036
-30	120	5700.0108	0.00019	5700.0113	0.00020	5700.0124	0.00022	5700.0103	0.00018

Frequency Stability Versus Voltage									
Operating Frequency: 5700MHz									
Temp. (°C)	Power Supply (Vac)	0 Minute		2 Minute		5 Minute		10 Minute	
		Measured Frequency (MHz)	Frequency Drift (%)	Measured Frequency (MHz)	Frequency Drift (%)	Measured Frequency (MHz)	Frequency Drift (%)	Measured Frequency (MHz)	Frequency Drift (%)
20	138	5700.0021	0.00004	5700.0031	0.00005	5700.0032	0.00006	5700.002	0.00004
	120	5700.0032	0.00006	5700.0039	0.00007	5700.0023	0.00004	5700.0025	0.00004
	102	5700.004	0.00007	5700.0038	0.00007	5700.0027	0.00005	5700.002	0.00004

Test Mode D

Frequency Stability Versus Temp.									
Operating Frequency: 5700MHz									
Temp. (°C)	Power Supply (Vac)	0 Minute		2 Minute		5 Minute		10 Minute	
		Measured Frequency (MHz)	Frequency Drift (%)	Measured Frequency (MHz)	Frequency Drift (%)	Measured Frequency (MHz)	Frequency Drift (%)	Measured Frequency (MHz)	Frequency Drift (%)
50	120	5700.0117	0.00021	5700.0118	0.00021	5700.0158	0.00028	5700.0123	0.00022
40	120	5699.9939	-0.00011	5699.9945	-0.00010	5699.9906	-0.00016	5699.9905	-0.00017
30	120	5700.0076	0.00013	5700.0079	0.00014	5700.0077	0.00014	5700.0067	0.00012
20	120	5699.9787	-0.00037	5699.9803	-0.00035	5699.9803	-0.00035	5699.9801	-0.00035
10	120	5699.9767	-0.00041	5699.9795	-0.00036	5699.9785	-0.00038	5699.9805	-0.00034
0	120	5699.9741	-0.00045	5699.9736	-0.00046	5699.9754	-0.00043	5699.9743	-0.00045
-10	120	5700.0287	0.00050	5700.0267	0.00047	5700.0245	0.00043	5700.0283	0.00050
-20	120	5700.0101	0.00018	5700.0073	0.00013	5700.0072	0.00013	5700.0073	0.00013
-30	120	5700.0231	0.00041	5700.0235	0.00041	5700.0237	0.00042	5700.0228	0.00040

Frequency Stability Versus Voltage									
Operating Frequency: 5700MHz									
Temp. (°C)	Power Supply (Vac)	0 Minute		2 Minute		5 Minute		10 Minute	
		Measured Frequency (MHz)	Frequency Drift (%)	Measured Frequency (MHz)	Frequency Drift (%)	Measured Frequency (MHz)	Frequency Drift (%)	Measured Frequency (MHz)	Frequency Drift (%)
20	138	5699.9791	-0.00037	5699.9807	-0.00034	5699.9793	-0.00036	5699.9801	-0.00035
	120	5699.9787	-0.00037	5699.9803	-0.00035	5699.9803	-0.00035	5699.9801	-0.00035
	102	5699.9797	-0.00036	5699.9803	-0.00035	5699.9797	-0.00036	5699.9796	-0.00036

Test Mode E

Frequency Stability Versus Temp.									
Operating Frequency: 5700MHz									
Temp. (°C)	Power Supply (Vac)	0 Minute		2 Minute		5 Minute		10 Minute	
		Measured Frequency (MHz)	Frequency Drift (%)	Measured Frequency (MHz)	Frequency Drift (%)	Measured Frequency (MHz)	Frequency Drift (%)	Measured Frequency (MHz)	Frequency Drift (%)
50	120	5699.984	-0.00028	5699.987	-0.00023	5699.9821	-0.00031	5699.9827	-0.00030
40	120	5699.9795	-0.00036	5699.9834	-0.00029	5699.9812	-0.00033	5699.9818	-0.00032
30	120	5700.0041	0.00007	5700.0052	0.00009	5700.0029	0.00005	5700.0026	0.00005
20	120	5700.0041	0.00007	5700.0022	0.00004	5700.0012	0.00002	5700.0038	0.00007
10	120	5700.0258	0.00045	5700.0273	0.00048	5700.0243	0.00043	5700.0269	0.00047
0	120	5700.0016	0.00003	5700.0012	0.00002	5700.0026	0.00005	5700.0026	0.00005
-10	120	5700.0282	0.00049	5700.0263	0.00046	5700.0295	0.00052	5700.0285	0.00050
-20	120	5699.9714	-0.00050	5699.9741	-0.00045	5699.9745	-0.00045	5699.9729	-0.00048
-30	120	5699.9911	-0.00016	5699.9876	-0.00022	5699.9883	-0.00021	5699.9916	-0.00015

Frequency Stability Versus Voltage									
Operating Frequency: 5700MHz									
Temp. (°C)	Power Supply (Vac)	0 Minute		2 Minute		5 Minute		10 Minute	
		Measured Frequency (MHz)	Frequency Drift (%)	Measured Frequency (MHz)	Frequency Drift (%)	Measured Frequency (MHz)	Frequency Drift (%)	Measured Frequency (MHz)	Frequency Drift (%)
20	138	5700.0033	0.00006	5700.0025	0.00004	5700.001	0.00002	5700.0047	0.00008
	120	5700.0041	0.00007	5700.0022	0.00004	5700.0012	0.00002	5700.0038	0.00007
	102	5700.0034	0.00006	5700.0017	0.00003	5700.0001	0.00000	5700.0046	0.00008

Test Mode G

Frequency Stability Versus Temp.									
Operating Frequency: 5700MHz									
Temp. (°C)	Power Supply (Vac)	0 Minute		2 Minute		5 Minute		10 Minute	
		Measured Frequency (MHz)	Frequency Drift (%)	Measured Frequency (MHz)	Frequency Drift (%)	Measured Frequency (MHz)	Frequency Drift (%)	Measured Frequency (MHz)	Frequency Drift (%)
50	120	5700.0281	0.00049	5700.0293	0.00051	5700.0248	0.00044	5700.0276	0.00048
40	120	5700.01	0.00018	5700.0093	0.00016	5700.013	0.00023	5700.0135	0.00024
30	120	5700.0073	0.00013	5700.0083	0.00015	5700.0069	0.00012	5700.0076	0.00013
20	120	5700.0143	0.00025	5700.0121	0.00021	5700.0153	0.00027	5700.012	0.00021
10	120	5699.9866	-0.00024	5699.987	-0.00023	5699.988	-0.00021	5699.9879	-0.00021
0	120	5699.99	-0.00018	5699.9916	-0.00015	5699.9907	-0.00016	5699.987	-0.00023
-10	120	5700.0061	0.00011	5700.0068	0.00012	5700.0087	0.00015	5700.0035	0.00006
-20	120	5700.0221	0.00039	5700.0213	0.00037	5700.0188	0.00033	5700.0212	0.00037
-30	120	5700.0198	0.00035	5700.0203	0.00036	5700.0151	0.00026	5700.0168	0.00029

Frequency Stability Versus Voltage									
Operating Frequency: 5700MHz									
Temp. (°C)	Power Supply (Vac)	0 Minute		2 Minute		5 Minute		10 Minute	
		Measured Frequency (MHz)	Frequency Drift (%)	Measured Frequency (MHz)	Frequency Drift (%)	Measured Frequency (MHz)	Frequency Drift (%)	Measured Frequency (MHz)	Frequency Drift (%)
20	138	5700.0148	0.00026	5700.0117	0.00021	5700.0162	0.00028	5700.0129	0.00023
	120	5700.0143	0.00025	5700.0121	0.00021	5700.0153	0.00027	5700.012	0.00021
	102	5700.0137	0.00024	5700.0125	0.00022	5700.016	0.00028	5700.0126	0.00022

Test Mode I

Frequency Stability Versus Temp.									
Operating Frequency: 5700MHz									
Temp. (°C)	Power Supply (Vac)	0 Minute		2 Minute		5 Minute		10 Minute	
		Measured Frequency (MHz)	Frequency Drift (%)	Measured Frequency (MHz)	Frequency Drift (%)	Measured Frequency (MHz)	Frequency Drift (%)	Measured Frequency (MHz)	Frequency Drift (%)
50	120	5700.0138	0.00024	5700.0156	0.00027	5700.0113	0.00020	5700.0129	0.00023
40	120	5699.9921	-0.00014	5699.9902	-0.00017	5699.9912	-0.00015	5699.9906	-0.00016
30	120	5700.0117	0.00021	5700.0118	0.00021	5700.0094	0.00016	5700.0123	0.00022
20	120	5699.9749	-0.00044	5699.976	-0.00042	5699.9744	-0.00045	5699.9761	-0.00042
10	120	5700.0153	0.00027	5700.0174	0.00031	5700.0155	0.00027	5700.0119	0.00021
0	120	5700.0117	0.00021	5700.011	0.00019	5700.0106	0.00019	5700.0131	0.00023
-10	120	5700.0061	0.00011	5700.0061	0.00011	5700.0064	0.00011	5700.0054	0.00009
-20	120	5699.9748	-0.00044	5699.9772	-0.00040	5699.9759	-0.00042	5699.9766	-0.00041
-30	120	5700.0036	0.00006	5700.0017	0.00003	5700.0004	0.00001	5700.0011	0.00002

Frequency Stability Versus Voltage									
Operating Frequency: 5700MHz									
Temp. (°C)	Power Supply (Vac)	0 Minute		2 Minute		5 Minute		10 Minute	
		Measured Frequency (MHz)	Frequency Drift (%)	Measured Frequency (MHz)	Frequency Drift (%)	Measured Frequency (MHz)	Frequency Drift (%)	Measured Frequency (MHz)	Frequency Drift (%)
20	138	5699.9749	-0.00044	5699.9771	-0.00040	5699.9753	-0.00043	5699.9766	-0.00041
	120	5699.9749	-0.00044	5699.976	-0.00042	5699.9744	-0.00045	5699.9761	-0.00042
	102	5699.9744	-0.00045	5699.9756	-0.00043	5699.9746	-0.00045	5699.9759	-0.00042

Test Mode K

Frequency Stability Versus Temp.									
Operating Frequency: 5700MHz									
Temp. (°C)	Power Supply (Vac)	0 Minute		2 Minute		5 Minute		10 Minute	
		Measured Frequency (MHz)	Frequency Drift (%)	Measured Frequency (MHz)	Frequency Drift (%)	Measured Frequency (MHz)	Frequency Drift (%)	Measured Frequency (MHz)	Frequency Drift (%)
50	120	5699.9754	-0.00043	5699.9722	-0.00049	5699.9739	-0.00046	5699.9729	-0.00048
40	120	5700.0107	0.00019	5700.0144	0.00025	5700.0137	0.00024	5700.0123	0.00022
30	120	5699.9906	-0.00016	5699.992	-0.00014	5699.9911	-0.00016	5699.9962	-0.00007
20	120	5699.9961	-0.00007	5699.9992	-0.00001	5699.9983	-0.00003	5699.9949	-0.00009
10	120	5700.0237	0.00042	5700.0233	0.00041	5700.0256	0.00045	5700.0246	0.00043
0	120	5699.9735	-0.00046	5699.9781	-0.00038	5699.9773	-0.00040	5699.975	-0.00044
-10	120	5699.9798	-0.00035	5699.9827	-0.00030	5699.9799	-0.00035	5699.9836	-0.00029
-20	120	5700.0149	0.00026	5700.0124	0.00022	5700.0153	0.00027	5700.0117	0.00021
-30	120	5699.983	-0.00030	5699.9816	-0.00032	5699.981	-0.00033	5699.9838	-0.00028

Frequency Stability Versus Voltage									
Operating Frequency: 5700MHz									
Temp. (°C)	Power Supply (Vac)	0 Minute		2 Minute		5 Minute		10 Minute	
		Measured Frequency (MHz)	Frequency Drift (%)	Measured Frequency (MHz)	Frequency Drift (%)	Measured Frequency (MHz)	Frequency Drift (%)	Measured Frequency (MHz)	Frequency Drift (%)
20	138	5699.9963	-0.00006	5699.9983	-0.00003	5699.9976	-0.00004	5699.9956	-0.00008
	120	5699.9961	-0.00007	5699.9992	-0.00001	5699.9983	-0.00003	5699.9949	-0.00009
	102	5699.9952	-0.00008	5699.9988	-0.00002	5699.9976	-0.00004	5699.9954	-0.00008

4.7 6dB Bandwidth Measurement

4.7.1 Limits of 6dB Bandwidth Measurement

The minimum of 6dB Bandwidth Measurement is 0.5MHz.

4.7.2 Test Setup

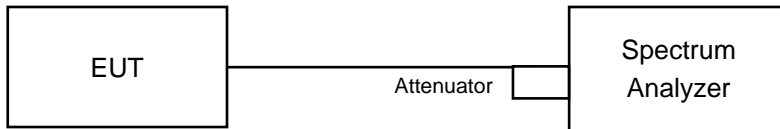

4.7.3 Test Instruments

Refer to section 4.1.2 to get information of above instrument.

4.7.4 Test Procedure

Measurement Procedure REF

- Set resolution bandwidth (RBW) = 100kHz
- Set the video bandwidth (VBW) $\geq 3 \times$ RBW, Detector = Peak.
- Trace mode = max hold.
- Sweep = auto couple.
- Measure the maximum width of the emission that is constrained by the frequencies associated with the two amplitude points (upper and lower) that are attenuated by 6 dB relative to the maximum level measured in the fundamental emission

4.7.5 Deviation from Test Standard

No deviation.

4.7.6 EUT Operating Condition

The software provided by client to enable the EUT under transmission condition continuously at lowest, middle and highest channel frequencies individually.

4.7.7 Test Results

Test Mode B

802.11a

Channel	Frequency (MHz)	6dB Bandwidth (MHz)		Minimum Limit (MHz)	Pass / Fail
		Chain 0	Chain 1		
144	5720 For U-NII-3	3.22	3.22	0.5	Pass

802.11n (HT20)

Channel	Frequency (MHz)	6dB Bandwidth (MHz)		Minimum Limit (MHz)	Pass / Fail
		Chain 0	Chain 1		
144	5720 For U-NII-3	3.84	3.85	0.5	Pass

802.11n (HT40)

Channel	Frequency (MHz)	6dB Bandwidth (MHz)		Minimum Limit (MHz)	Pass / Fail
		Chain 0	Chain 1		
142	5710 For U-NII-3	2.87	3.20	0.5	Pass

802.11ac (VHT80)

Channel	Frequency (MHz)	6dB Bandwidth (MHz)		Minimum Limit (MHz)	Pass / Fail
		Chain 0	Chain 1		
138	5690 For U-NII-3	3.25	3.20	0.5	Pass

Spectrum Plot of Worst Value

802.11a

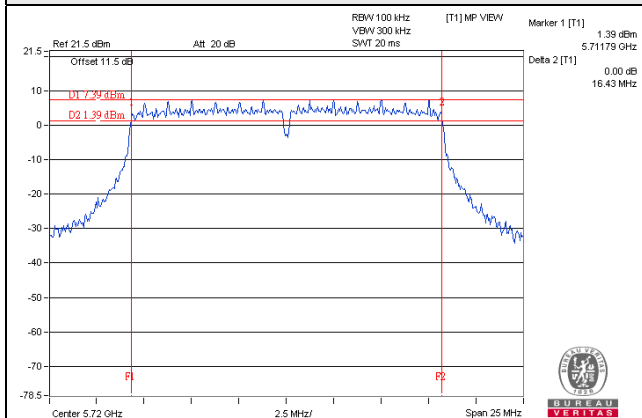

802.11n (HT20)

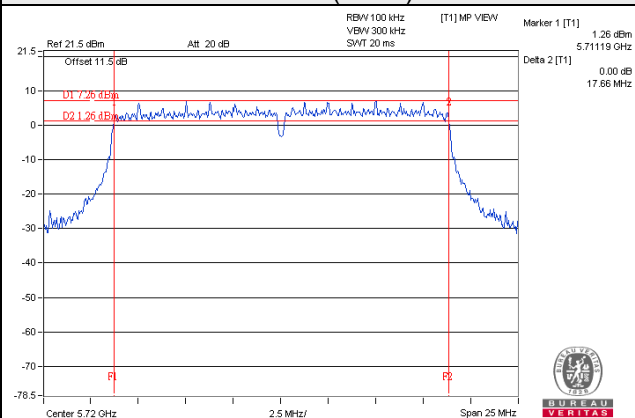

802.11n (HT40)

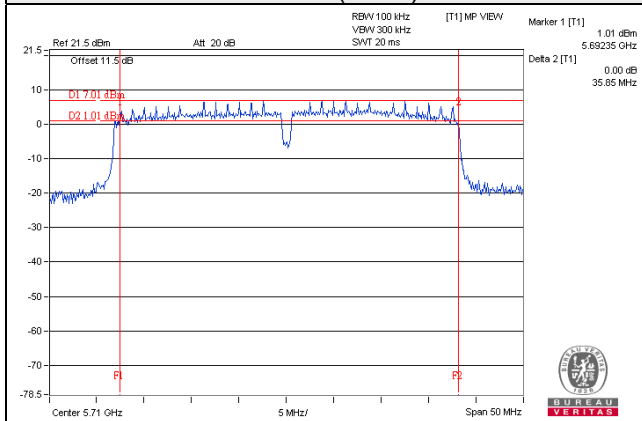

802.11ac (VHT80)

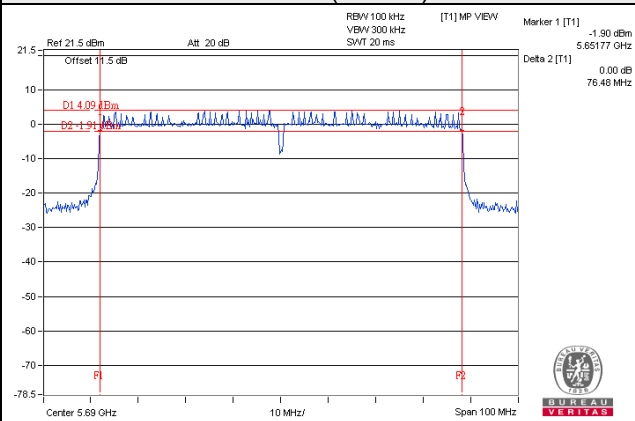

Note:

For CH144 (UNII-3 Band): The 6dB bandwidth above 5725MHz = Marker 1 + Delta 2 - 5725MHz

For CH142 (UNII-3 Band): The 6dB bandwidth above 5725MHz = Marker 1 + Delta 2 - 5725MHz

For CH138 (UNII-3 Band): The 6dB bandwidth above 5725MHz = Marker 1 + Delta 2 - 5725MHz

Test Mode D

802.11a

Channel	Frequency (MHz)	6dB Bandwidth (MHz)		Minimum Limit (MHz)	Pass / Fail
		Chain 0	Chain 1		
144	5720 For U-NII-3	3.12	3.13	0.5	Pass

802.11n (HT20)

Channel	Frequency (MHz)	6dB Bandwidth (MHz)		Minimum Limit (MHz)	Pass / Fail
		Chain 0	Chain 1		
144	5720 For U-NII-3	3.76	3.75	0.5	Pass

802.11n (HT40)

Channel	Frequency (MHz)	6dB Bandwidth (MHz)		Minimum Limit (MHz)	Pass / Fail
		Chain 0	Chain 1		
142	5710 For U-NII-3	3.10	2.73	0.5	Pass

802.11ac (VHT80)

Channel	Frequency (MHz)	6dB Bandwidth (MHz)		Minimum Limit (MHz)	Pass / Fail
		Chain 0	Chain 1		
138	5690 For U-NII-3	3.23	3.22	0.5	Pass

Spectrum Plot of Worst Value

802.11a

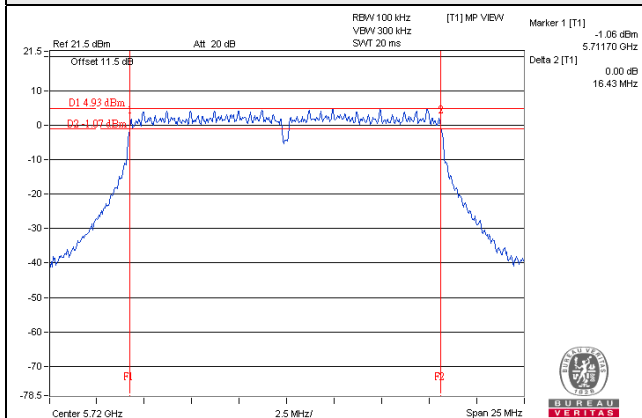

802.11n (HT20)

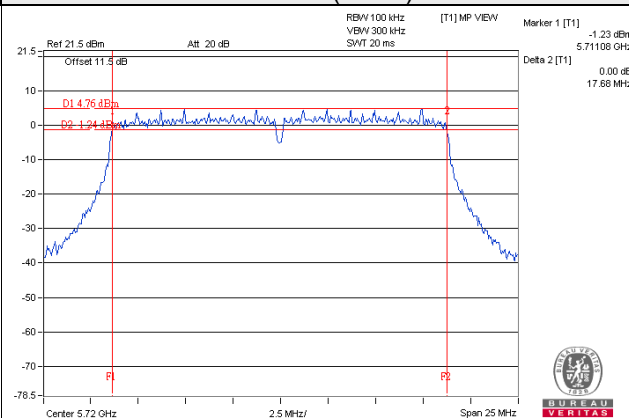

802.11n (HT40)

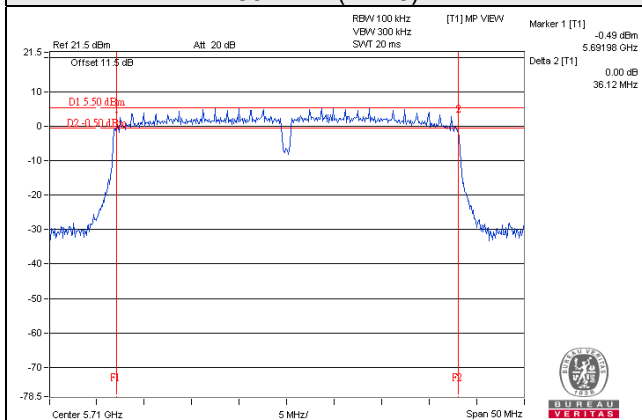

802.11ac (VHT80)

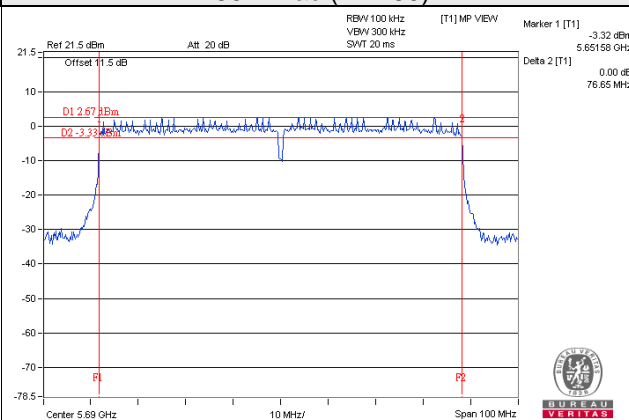

Note:

For CH144 (UNII-3 Band): The 6dB bandwidth above 5725MHz = Marker 1 + Delta 2 - 5725MHz

For CH142 (UNII-3 Band): The 6dB bandwidth above 5725MHz = Marker 1 + Delta 2 - 5725MHz

For CH138 (UNII-3 Band): The 6dB bandwidth above 5725MHz = Marker 1 + Delta 2 - 5725MHz

Test Mode E

802.11a

Channel	Frequency (MHz)	6dB Bandwidth (MHz)		Minimum Limit (MHz)	Pass / Fail
		Chain 0	Chain 1		
144	5720 For U-NII-3	3.12	3.13	0.5	Pass

802.11n (HT20)

Channel	Frequency (MHz)	6dB Bandwidth (MHz)		Minimum Limit (MHz)	Pass / Fail
		Chain 0	Chain 1		
144	5720 For U-NII-3	3.76	3.75	0.5	Pass

802.11n (HT40)

Channel	Frequency (MHz)	6dB Bandwidth (MHz)		Minimum Limit (MHz)	Pass / Fail
		Chain 0	Chain 1		
142	5710 For U-NII-3	3.10	2.73	0.5	Pass

802.11ac (VHT80)

Channel	Frequency (MHz)	6dB Bandwidth (MHz)		Minimum Limit (MHz)	Pass / Fail
		Chain 0	Chain 1		
138	5690 For U-NII-3	3.23	3.22	0.5	Pass

Spectrum Plot of Worst Value

802.11a

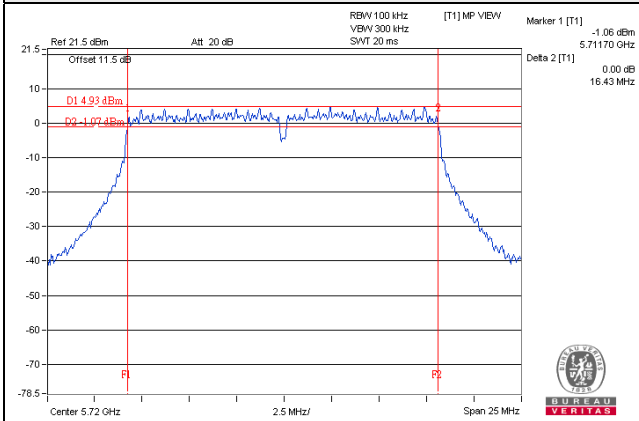

802.11n (HT20)

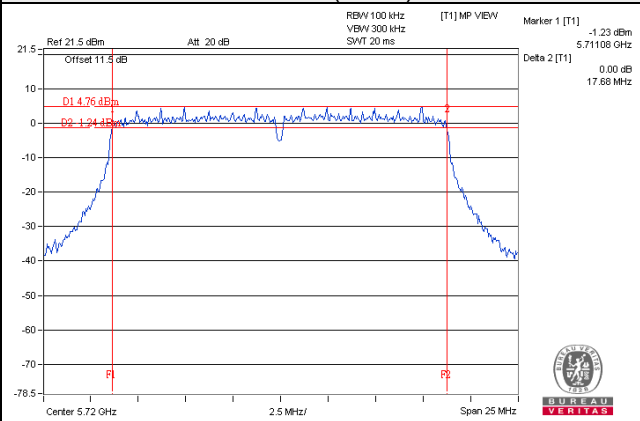

802.11n (HT40)

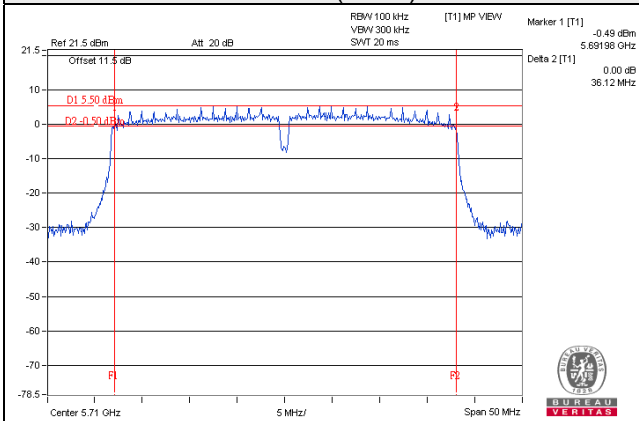

802.11ac (VHT80)

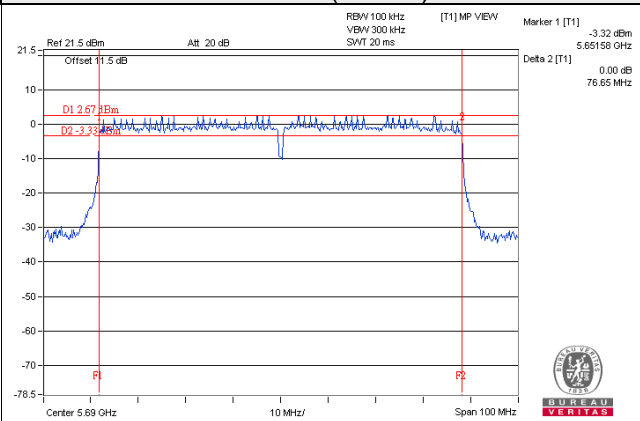

Note:

For CH144 (UNII-3 Band): The 6dB bandwidth above 5725MHz = Marker 1 + Delta 2 - 5725MHz

For CH142 (UNII-3 Band): The 6dB bandwidth above 5725MHz = Marker 1 + Delta 2 - 5725MHz

For CH138 (UNII-3 Band): The 6dB bandwidth above 5725MHz = Marker 1 + Delta 2 - 5725MHz

Test Mode G

802.11a

Channel	Frequency (MHz)	6dB Bandwidth (MHz)		Minimum Limit (MHz)	Pass / Fail
		Chain 0	Chain 1		
144	5720 For U-NII-3	3.12	3.14	0.5	Pass

802.11n (HT20)

Channel	Frequency (MHz)	6dB Bandwidth (MHz)		Minimum Limit (MHz)	Pass / Fail
		Chain 0	Chain 1		
144	5720 For U-NII-3	3.75	3.76	0.5	Pass

802.11n (HT40)

Channel	Frequency (MHz)	6dB Bandwidth (MHz)		Minimum Limit (MHz)	Pass / Fail
		Chain 0	Chain 1		
142	5710 For U-NII-3	2.81	3.10	0.5	Pass

802.11ac (VHT80)

Channel	Frequency (MHz)	6dB Bandwidth (MHz)		Minimum Limit (MHz)	Pass / Fail
		Chain 0	Chain 1		
138	5690 For U-NII-3	3.22	3.22	0.5	Pass

Spectrum Plot of Worst Value

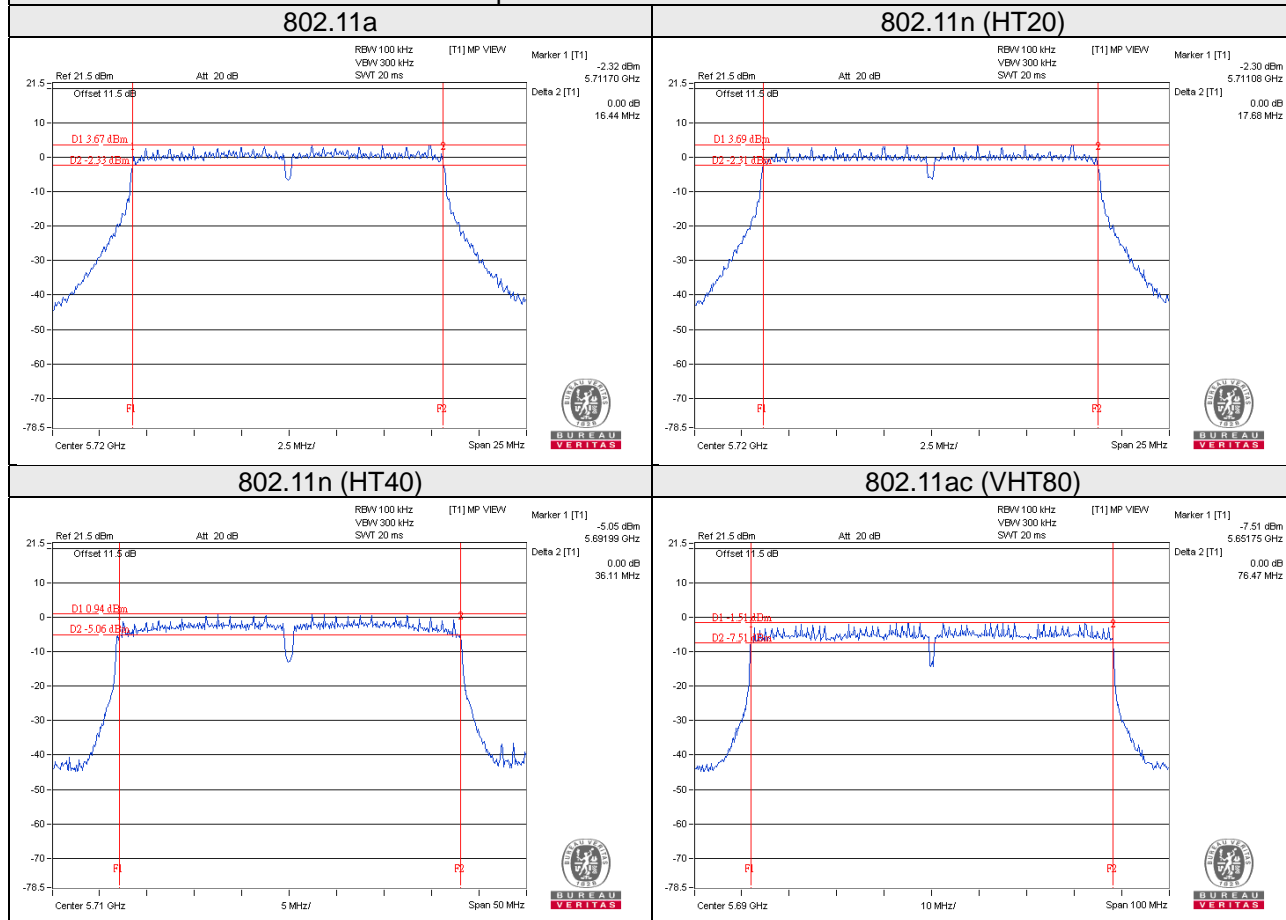

Note:

For CH144 (UNII-3 Band): The 6dB bandwidth above 5725MHz = Marker 1 + Delta 2 - 5725MHz

For CH142 (UNII-3 Band): The 6dB bandwidth above 5725MHz = Marker 1 + Delta 2 - 5725MHz

For CH138 (UNII-3 Band): The 6dB bandwidth above 5725MHz = Marker 1 + Delta 2 - 5725MHz

Test Mode I

802.11a

Channel	Frequency (MHz)	6dB Bandwidth (MHz)		Minimum Limit (MHz)	Pass / Fail
		Chain 0	Chain 1		
144	5720 For U-NII-3	3.12	3.13	0.5	Pass

802.11n (HT20)

Channel	Frequency (MHz)	6dB Bandwidth (MHz)		Minimum Limit (MHz)	Pass / Fail
		Chain 0	Chain 1		
144	5720 For U-NII-3	3.76	3.76	0.5	Pass

802.11n (HT40)

Channel	Frequency (MHz)	6dB Bandwidth (MHz)		Minimum Limit (MHz)	Pass / Fail
		Chain 0	Chain 1		
142	5710 For U-NII-3	3.10	2.72	0.5	Pass

802.11ac (VHT80)

Channel	Frequency (MHz)	6dB Bandwidth (MHz)		Minimum Limit (MHz)	Pass / Fail
		Chain 0	Chain 1		
138	5690 For U-NII-3	3.22	3.22	0.5	Pass

Spectrum Plot of Worst Value

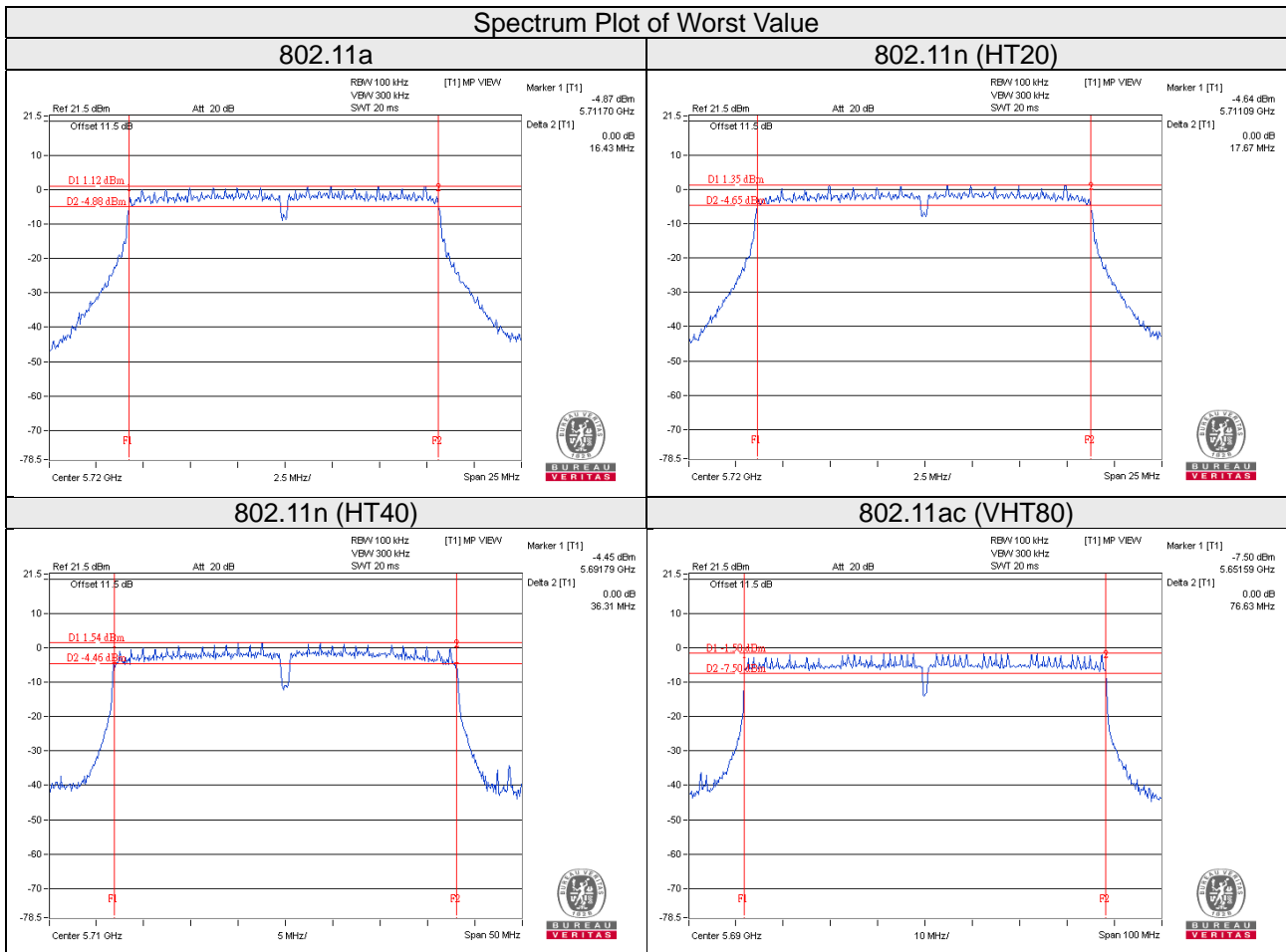

Note:

For CH144 (UNII-3 Band): The 6dB bandwidth above 5725MHz = Marker 1 + Delta 2 - 5725MHz

For CH142 (UNII-3 Band): The 6dB bandwidth above 5725MHz = Marker 1 + Delta 2 - 5725MHz

For CH138 (UNII-3 Band): The 6dB bandwidth above 5725MHz = Marker 1 + Delta 2 - 5725MHz

Test Mode K

802.11a

Channel	Frequency (MHz)	6dB Bandwidth (MHz)		Minimum Limit (MHz)	Pass / Fail
		Chain 0	Chain 1		
144	5720 For U-NII-3	3.12	3.13	0.5	Pass

802.11n (HT20)

Channel	Frequency (MHz)	6dB Bandwidth (MHz)		Minimum Limit (MHz)	Pass / Fail
		Chain 0	Chain 1		
144	5720 For U-NII-3	3.76	3.77	0.5	Pass

802.11n (HT40)

Channel	Frequency (MHz)	6dB Bandwidth (MHz)		Minimum Limit (MHz)	Pass / Fail
		Chain 0	Chain 1		
142	5710 For U-NII-3	3.10	2.79	0.5	Pass

802.11ac (VHT80)

Channel	Frequency (MHz)	6dB Bandwidth (MHz)		Minimum Limit (MHz)	Pass / Fail
		Chain 0	Chain 1		
138	5690 For U-NII-3	3.22	3.20	0.5	Pass

Spectrum Plot of Worst Value

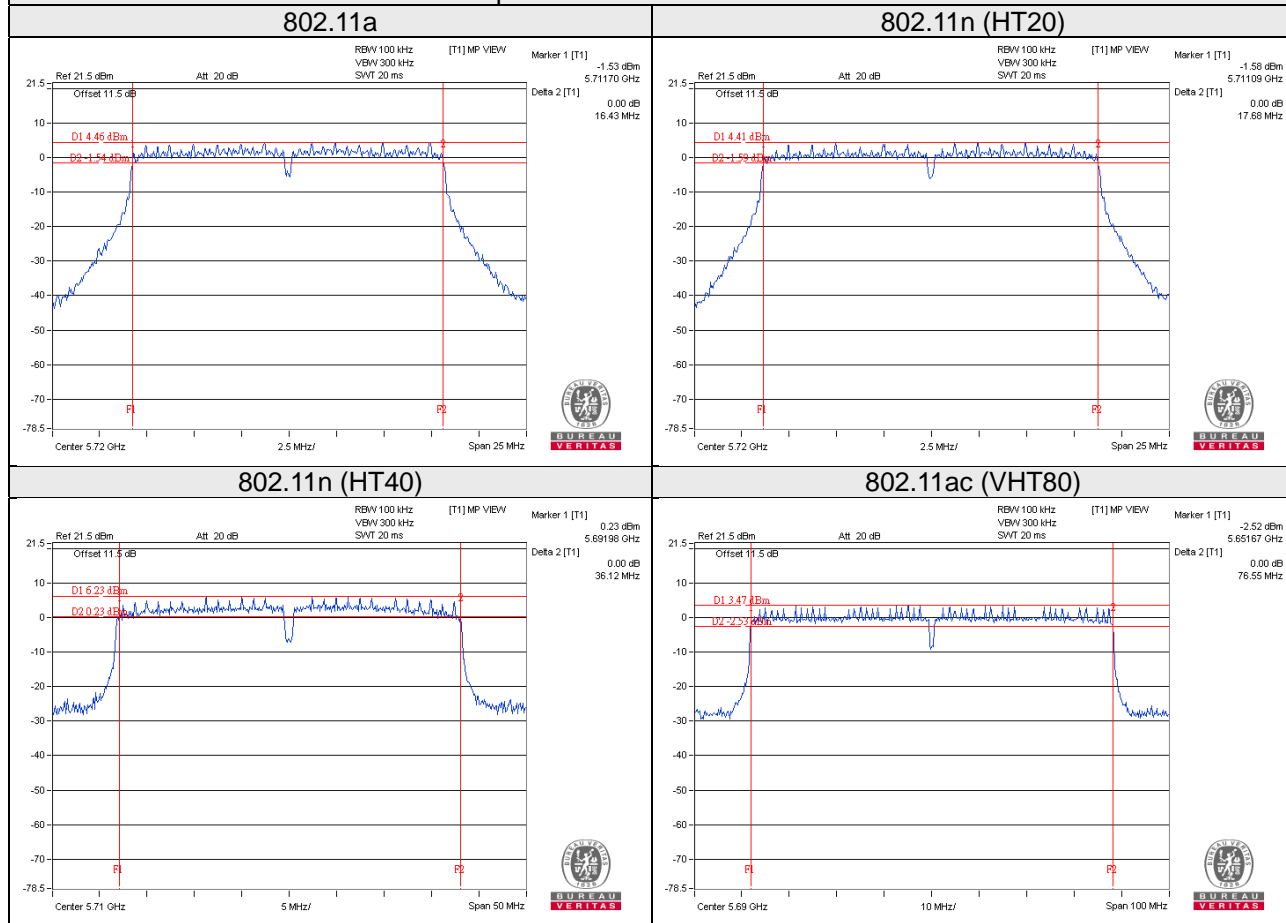

Note:

For CH144 (UNII-3 Band): The 6dB bandwidth above 5725MHz = Marker 1 + Delta 2 - 5725MHz

For CH142 (UNII-3 Band): The 6dB bandwidth above 5725MHz = Marker 1 + Delta 2 - 5725MHz

For CH138 (UNII-3 Band): The 6dB bandwidth above 5725MHz = Marker 1 + Delta 2 - 5725MHz

5 Pictures of Test Arrangements

Please refer to the attached file (Test Setup Photo).

Appendix – Information on the Testing Laboratories

We, Bureau Veritas Consumer Products Services (H.K.) Ltd., Taoyuan Branch, were founded in 1988 to provide our best service in EMC, Radio, Telecom and Safety consultation. Our laboratories are FCC recognized accredited test firms and accredited and approved according to ISO/IEC 17025.

If you have any comments, please feel free to contact us at the following:

Linko EMC/RF Lab

Tel: 886-2-26052180

Fax: 886-2-26051924

Hsin Chu EMC/RF/Telecom Lab

Tel: 886-3-6668565

Fax: 886-3-6668323

Hwa Ya EMC/RF/Safety

Tel: 886-3-3183232

Fax: 886-3-3270892

Email: service.adt@tw.bureauveritas.com

Web Site: www.bureauveritas-adt.com

The address and road map of all our labs can be found in our web site also.

--- END ---