

FCC Test Report

Report No.: RF170609C20-2

FCC ID: QXO-AP3915E

Test Model: AP3915e

Series Model: AP7632 (refer to item 3.1 for more details)

Received Date: Jun. 09, 2017

Test Date: Jul. 18 ~ Jul. 20, 2017

Issued Date: Aug. 09, 2017

Applicant: Extreme Networks, Inc.

Address: 6480 VIA DEL ORO SAN JOSE CA 95119 USA

Issued By: Bureau Veritas Consumer Products Services (H.K.) Ltd., Taoyuan Branch

Lab Address: No. 47-2, 14th Ling, Chia Pau Vil., Lin Kou Dist., New Taipei City, Taiwan (R.O.C.)

Test Location: No. 19, Hwa Ya 2nd Rd., Wen Hwa Vil., Kwei Shan Dist., Taoyuan City 33383, TAIWAN (R.O.C.)



This report is for your exclusive use. Any copying or replication of this report to or for any other person or entity, or use of our name or trademark, is permitted only with our prior written permission. This report sets forth our findings solely with respect to the test samples identified herein. The results set forth in this report are not indicative or representative of the quality or characteristics of the lot from which a test sample was taken or any similar or identical product specifically and expressly noted. Our report includes all of the tests requested by you and the results thereof based upon the information that you provided to us. You have 60 days from date of issuance of this report to notify us of any material error or omission caused by our negligence, provided, however, that such notice shall be in writing and shall specifically address the issue you wish to raise. A failure to raise such issue within the prescribed time shall constitute your unqualified acceptance of the completeness of this report, the tests conducted and the correctness of the report contents. Unless specific mention, the uncertainty of measurement has been explicitly taken into account to declare the compliance or non-compliance to the specification. This report should not be used by the client to claim product certification, approval, or endorsement by TAF or any government agencies.

Table of Contents

Release Control Record	4
1 Certificate of Conformity	5
2 Summary of Test Results	6
2.1 Measurement Uncertainty.....	6
2.2 Modification Record.....	6
3 General Information	7
3.1 General Description of EUT.....	7
3.2 Description of Test Modes.....	8
3.2.1 Test Mode Applicability and Tested Channel Detail.....	9
3.3 Duty Cycle of Test Signal.....	10
3.4 Description of Support Units.....	10
3.4.1 Configuration of System under Test.....	11
3.5 General Description of Applied Standards.....	12
4 Test Types and Results	13
4.1 Radiated Emission and Bandedge Measurement.....	13
4.1.1 Limits of Radiated Emission and Bandedge Measurement.....	13
4.1.2 Test Instruments.....	14
4.1.3 Test Procedures.....	15
4.1.4 Deviation from Test Standard.....	15
4.1.5 Test Setup.....	16
4.1.6 EUT Operating Conditions.....	17
4.1.7 Test Results.....	18
4.2 Conducted Emission Measurement.....	28
4.2.1 Limits of Conducted Emission Measurement.....	28
4.2.2 Test Instruments.....	28
4.2.3 Test Procedures.....	29
4.2.4 Deviation from Test Standard.....	29
4.2.5 Test Setup.....	29
4.2.6 EUT Operating Conditions.....	29
4.2.7 Test Results.....	30
4.3 6dB Bandwidth Measurement.....	38
4.3.1 Limits of 6dB Bandwidth Measurement.....	38
4.3.2 Test Setup.....	38
4.3.3 Test Instruments.....	38
4.3.4 Test Procedure.....	38
4.3.5 Deviation from Test Standard.....	38
4.3.6 EUT Operating Conditions.....	38
4.3.7 Test Result.....	39
4.4 Conducted Output Power Measurement.....	40
4.4.1 Limits of Conducted Output Power Measurement.....	40
4.4.2 Test Setup.....	40
4.4.3 Test Instruments.....	40
4.4.4 Test Procedures.....	40
4.4.5 Deviation from Test Standard.....	40
4.4.6 EUT Operating Conditions.....	40
4.4.7 Test Results.....	40
4.5 Power Spectral Density Measurement.....	41
4.5.1 Limits of Power Spectral Density Measurement.....	41
4.5.2 Test Setup.....	41
4.5.3 Test Instruments.....	41
4.5.4 Test Procedure.....	41
4.5.5 Deviation from Test Standard.....	41
4.5.6 EUT Operating Condition.....	41

4.5.7 Test Results	42
4.6 Conducted Out of Band Emission Measurement.....	43
4.6.1 Limits of Conducted Out of Band Emission Measurement	43
4.6.2 Test Setup.....	43
4.6.3 Test Instruments	43
4.6.4 Test Procedure	43
4.6.5 Deviation from Test Standard	43
4.6.6 EUT Operating Condition	43
4.6.7 Test Results	43
5 Pictures of Test Arrangements.....	45
Appendix – Information on the Testing Laboratories	46

Release Control Record

Issue No.	Description	Date Issued
RF170609C20-2	Original release.	Aug. 09, 2017

1 Certificate of Conformity

Product: Wireless 802.11 a/ac+b/g/n Indoor Access Point

Brand: Extreme Networks

Test Model: AP3915e

Series Model: AP7632 (refer to item 3.1 for more details)

Sample Status: Engineering sample

Applicant: Extreme Networks, Inc.

Test Date: Jul. 18 ~ Jul. 20, 2017

Standards: 47 CFR FCC Part 15, Subpart C (Section 15.247)
ANSI C63.10:2013

The above equipment has been tested by **Bureau Veritas Consumer Products Services (H.K.) Ltd., Taoyuan Branch**, and found compliance with the requirement of the above standards. The test record, data evaluation & Equipment Under Test (EUT) configurations represented herein are true and accurate accounts of the measurements of the sample's EMC characteristics under the conditions specified in this report.

Prepared by : Celine Chou , **Date:** Aug. 09, 2017
Celine Chou / Specialist

Approved by : Ken Liu , **Date:** Aug. 09, 2017
Ken Liu / Senior Manager

2 Summary of Test Results

47 CFR FCC Part 15, Subpart C (Section 15.247)			
FCC Clause	Test Item	Result	Remarks
15.207	AC Power Conducted Emission	Pass	Meet the requirement of limit. Minimum passing margin is -2.58dB at 0.47185MHz.
15.205 / 15.209 / 15.247(d)	Radiated Emissions and Band Edge Measurement	Pass	Meet the requirement of limit. Minimum passing margin is -1.7dB at 45.45MHz.
15.247(d)	Antenna Port Emission	Pass	Meet the requirement of limit.
15.247(a)(2)	6dB bandwidth	Pass	Meet the requirement of limit.
15.247(b)	Conducted power	Pass	Meet the requirement of limit.
15.247(e)	Power Spectral Density	Pass	Meet the requirement of limit.
15.203	Antenna Requirement	Pass	Antenna connectors are N Male and Fixed N-Male Std polarity not a standard connector.

2.1 Measurement Uncertainty

Where relevant, the following measurement uncertainty levels have been estimated for tests performed on the EUT as specified in CISPR 16-4-2:

Measurement	Frequency	Expanded Uncertainty (k=2) (\pm)
Conducted Emissions at mains ports	150kHz ~ 30MHz	2.94 dB
Radiated Emissions up to 1 GHz	30MHz ~ 200MHz	3.86 dB
	200MHz ~ 1000MHz	3.87 dB
Radiated Emissions above 1 GHz	1GHz ~ 18GHz	2.29 dB
	18GHz ~ 40GHz	2.29 dB

2.2 Modification Record

There were no modifications required for compliance.

3 General Information

3.1 General Description of EUT

Product	Wireless 802.11 a/ac+b/g/n Indoor Access Point
Brand	Extreme Networks
Test Model	AP3915e
Series Model	AP7632
Model Difference	Refer to note for more details
Sample Status	Engineering sample
Power Supply Rating	12Vdc from adapter 54Vdc from POE
Modulation Type	GFSK
Transfer Rate	1Mbps
Operating Frequency	2402 ~ 2480MHz
Number of Channel	40
Channel Spacing	2MHz
Output Power	ML-2499-HPA8-01 and ML-2452-PNA7-01R Ant.: 1.259mW
Antenna Type	Refer to Note
Antenna Connector	Refer to Note
Accessory Device	NA
Cable Supplied	NA

Note:

1. All models are listed as below. Model: AP3915e was chosen for final test.

Brand	Model	Difference
Extreme Networks	AP3915e	All models are electrically identical, only the cover printing is different.
	AP7632	

2. The EUT consumes power from the following adapter and POE. (Support unit only)

Adapter	
Brand	Powertron Electronics Corp.
Model	PA1024-120IB200
Input Power	100-240Vac, 50-60Hz, 0.6A.
Output Power	12Vdc, 2A, 24W Max
Power Line	1.5m power cable with one core attached on adapter

POE	
Brand	EnGenius
Model	EPA5006GP
Input Power	100-240Vac, 50-60Hz, 0.8A
Output Power	54Vdc, 0.6A Pin 4, 5: 54Vdc Pin 7, 8: Return

3. The following antennas were provided to the EUT.

No.	Function	Type	Manufacturer/ Vendor	Model	Gain (dBi)		Connector
					2.4GHz Band	5GHz Band	
1	WLAN	Dipole	Wha Yu	ML-2452-APA2-01	3.17	4.85	RP-SMA Male
2	WLAN	Dipole	Wha Yu	ML-2452-APA2-02	3	5	RP-SMA Male
3	WLAN	Dipole	Laird	ML-2452-HPA5-036	3	5	RP-SMA Male
4	WLAN	Dipole	Laird	ML-2452-HPAG4A6-01	4	7.3	N Male
5	WLAN	Dipole	Ventev	ML-2452-HPA6M4-S36	6.0	6.0	RP-SMA
6	WLAN	Panel	Laird	ML-2452-PNL9M3-036	11.0	10.7	RP-SMA Male
7	WLAN	Panel	Laird	ML-2452-PNL6M3-N36	6	6	N Male
8	WLAN	Panel	Laird	ML-2452-PNA5-01R	5.5	6	N Male
9	WLAN & BT LE & Zigbee	Panel	Laird	ML-2452-PNA7-01R	7.8	10.7	N Male
10	WLAN	Patch	Laird	ML-2452-PTA2M2-036	4	5	RP-SMA Male
11	WLAN	Patch	Laird	ML-2452-PTA4M4-036	5	6.6	RP-SMA Male
12	BT LE & Zigbee	Omni	Laird	ML-2499-HPA8-01	8	-	Fixed N-Male Std polarity

* ML-2452-PNL9M3-036 Ant. was cross-polarized antenna.

4. Power Setting as below.

ML-2499-HPA8-01 and ML-2452-PNA7-01R Ant. (same power setting):

	Power Setting
CH 0	Default
CH 19	Default
CH 39	Default

- 2.4GHz & 5GHz & BT LE or 2.4GHz & 5GHz & Zigbee technology can transmit at same time. BT LE and Zigbee cannot transmit simultaneously.
- Spurious emission of the simultaneous operation (2.4GHz & 5GHz & BT LE or 2.4GHz & 5GHz & Zigbee) has been evaluated and no non-compliance was found.

3.2 Description of Test Modes

40 channels are provided to this EUT:

Channel	Freq. (MHz)	Channel	Freq. (MHz)	Channel	Freq. (MHz)	Channel	Freq. (MHz)
0	2402	10	2422	20	2442	30	2462
1	2404	11	2424	21	2444	31	2464
2	2406	12	2426	22	2446	32	2466
3	2408	13	2428	23	2448	33	2468
4	2410	14	2430	24	2450	34	2470
5	2412	15	2432	25	2452	35	2472
6	2414	16	2434	26	2454	36	2474
7	2416	17	2436	27	2456	37	2476
8	2418	18	2438	28	2458	38	2478
9	2420	19	2440	29	2460	39	2480

3.2.1 Test Mode Applicability and Tested Channel Detail

EUT Configure Mode	Applicable to				Description
	RE \geq 1G	RE<1G	PLC	APCM	
A	-	√	√	-	EUT with ML-2499-HPA8-01 Ant. power by adapter
B	√	√	√	√	EUT with ML-2499-HPA8-01 Ant. power by POE
C	-	√	√	-	EUT with ML-2452-PNA7-01R Ant. power by adapter
D	√	√	√	-	EUT with ML-2452-PNA7-01R Ant. power by POE

Where RE \geq 1G: Radiated Emission above 1GHz & Bandedge Measurement
 RE<1G: Radiated Emission below 1GHz
 PLC: Power Line Conducted Emission
 APCM: Antenna Port Conducted Measurement

Note:

1. The EUT had been pre-tested on the positioned of each 3 axis. The worst case was found when positioned on **Z-plane**.
2. "-" means no effect.

Radiated Emission Test (Above 1GHz):

- Pre-Scan has been conducted to determine the worst-case mode from all possible combinations between available modulations, data rates and antenna ports (if EUT with antenna diversity architecture).
- Following channel(s) was (were) selected for the final test as listed below.

EUT Configure Mode	Available Channel	Tested Channel	Modulation Type	Data Rate (Mbps)
B ,D	0 to 39	0, 19, 39	GFSK	1

Radiated Emission Test (Below 1GHz):

- Pre-Scan has been conducted to determine the worst-case mode from all possible combinations between available modulations, data rates and antenna ports (if EUT with antenna diversity architecture).
- Following channel(s) was (were) selected for the final test as listed below.

EUT Configure Mode	Available Channel	Tested Channel	Modulation Type	Data Rate (Mbps)
A, B, C, D	0 to 39	0	GFSK	1

Power Line Conducted Emission Test:

- Pre-Scan has been conducted to determine the worst-case mode from all possible combinations between available modulations, data rates and antenna ports (if EUT with antenna diversity architecture).
- Following channel(s) was (were) selected for the final test as listed below.

EUT Configure Mode	Available Channel	Tested Channel	Modulation Type	Data Rate (Mbps)
A, B, C, D	0 to 39	0	GFSK	1

Antenna Port Conducted Measurement:

- This item includes all test value of each mode, but only includes spectrum plot of worst value of each mode.
- Pre-Scan has been conducted to determine the worst-case mode from all possible combinations between available modulations, data rates and antenna ports (if EUT with antenna diversity architecture).
- Following channel(s) was (were) selected for the final test as listed below.

EUT Configure Mode	Available Channel	Tested Channel	Modulation Type	Data Rate (Mbps)
B	0 to 39	0, 19, 39	GFSK	1

Test Condition:

Applicable to	Environmental Conditions	Input Power (System)	Tested by
RE≥1G	23 deg. C, 64% RH	120Vac, 60Hz	Jones Chang
RE<1G	23 deg. C, 64% RH	120Vac, 60Hz 54Vdc	Jones Chang
PLC	25 deg. C, 75% RH	120Vac, 60Hz 54Vdc	Luis Lee
APCM	25 deg. C, 60% RH	120Vac, 60Hz	Frank Liu

3.3 Duty Cycle of Test Signal

Duty cycle of test signal is < 98%, duty factor is required.

Duty cycle = 0.397/0.684 = 0.580, Duty factor = 10 * log(1/0.580) = 2.36,

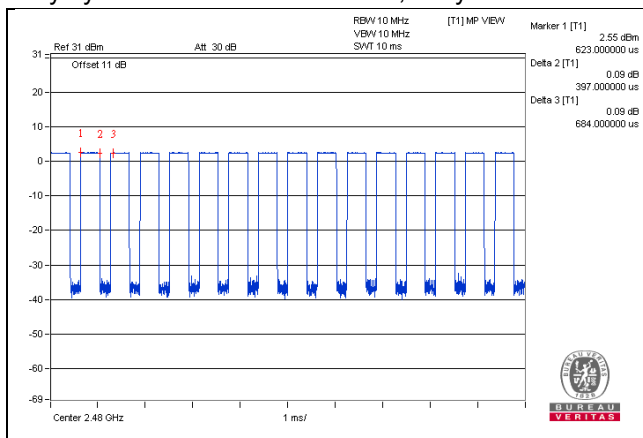

3.4 Description of Support Units

The EUT has been tested as an independent unit together with other necessary accessories or support units. The following support units or accessories were used to form a representative test configuration during the tests.

ID	Product	Brand	Model No.	Serial No.	FCC ID	Remarks
A.	Notebook	DELL	E5410	1HC2XM1	FCC DoC Approved	-
B.	USB Flash	HP	v250W	10	FCC DoC Approved	-
C.	Adapter	Powertron Electronics Corp.	PA1024-120IB200	NA	NA	Provided by manufacturer
D.	POE	EnGenius	EPA5006GP	NA	NA	Provided by manufacturer

Note:

1. All power cords of the above support units are non-shielded (1.8m).
2. Item A acted as a communication partner to transfer data.

ID	Descriptions	Qty.	Length (m)	Shielding (Yes/No)	Cores (Qty.)	Remarks
1.	RJ45, Cat5e	1	3	N	0	-
2.	RJ45, Cat5e	1	1.8	N	0	-
3.	Console cable	1	1	N	0	Provided by manufacturer
4.	Power cable	1	1.5	N	1	Provided by manufacturer

Note: The core(s) is(are) originally attached to the cable(s).

3.4.1 Configuration of System under Test

Adapter Mode

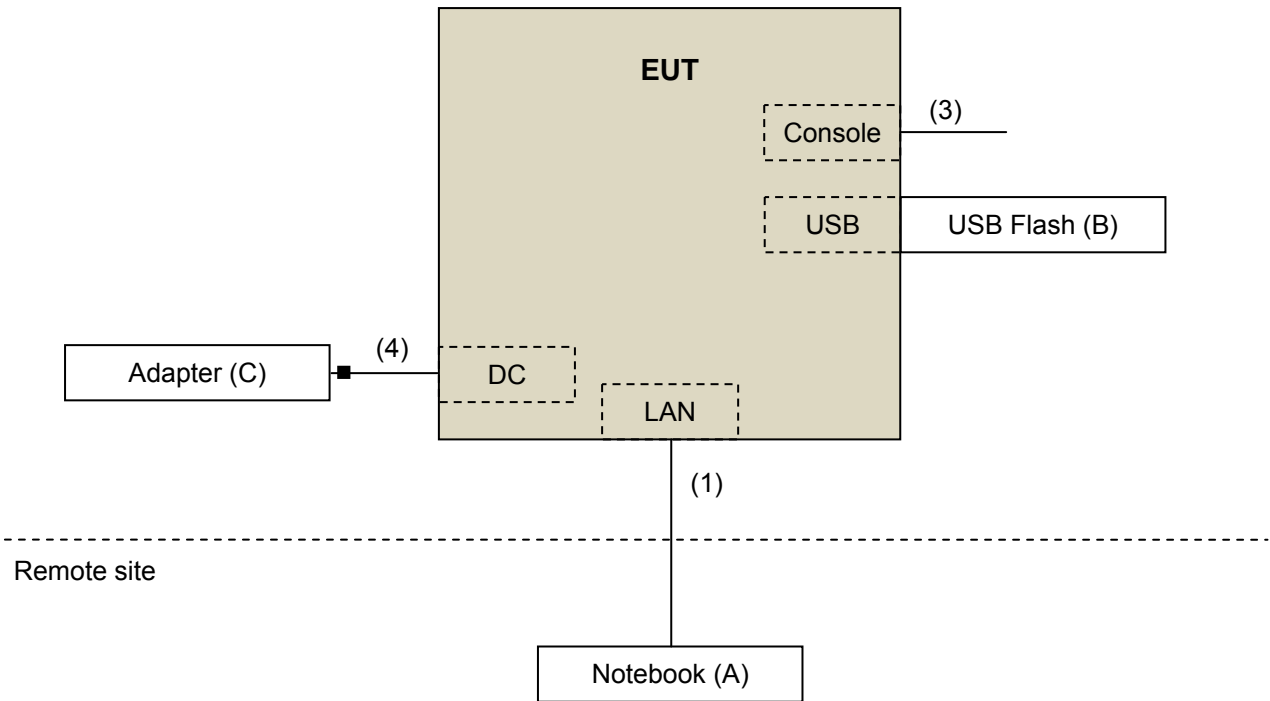

POE Mode

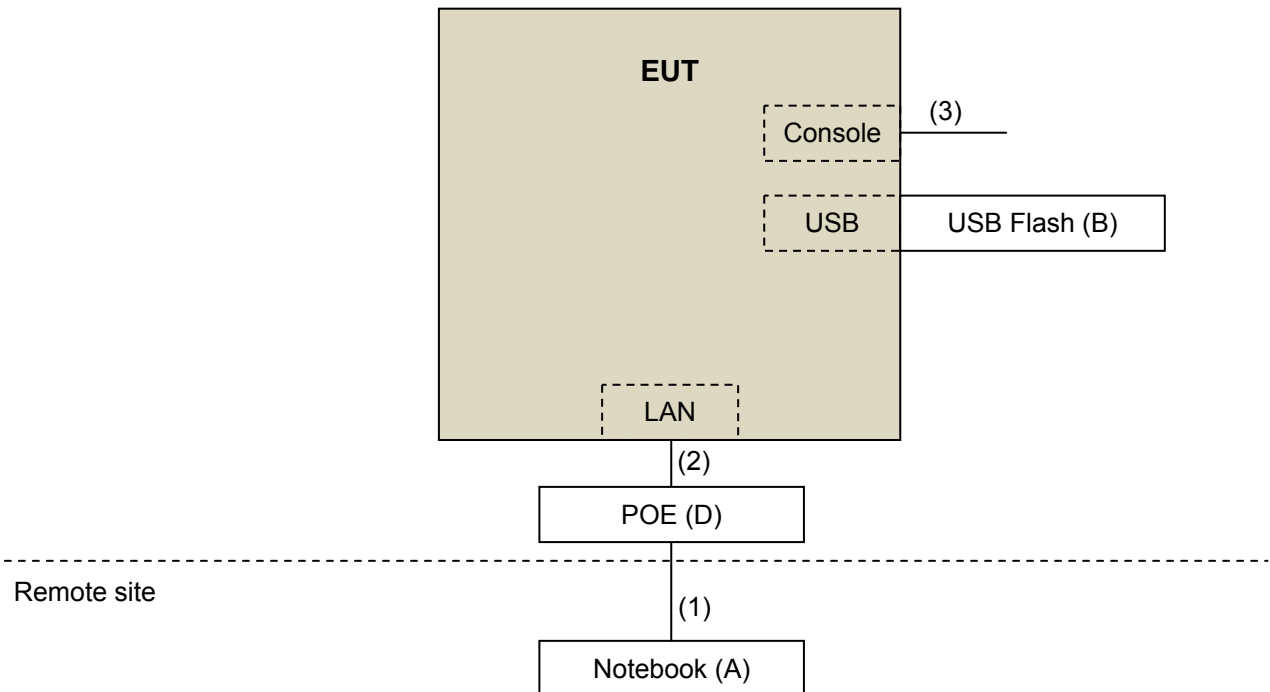

3.5 General Description of Applied Standards

The EUT is a RF Product. According to the specifications of the manufacturer, it must comply with the requirements of the following standards:

FCC Part 15, Subpart C (15.247)

KDB 558074 D01 DTS Meas Guidance v04

ANSI C63.10-2013

All test items have been performed and recorded as per the above standards.

Note: The EUT has been verified to comply with the requirements of FCC Part 15, Subpart B, Class B (DoC).
The test report has been issued separately.

4 Test Types and Results

4.1 Radiated Emission and Bandedge Measurement

4.1.1 Limits of Radiated Emission and Bandedge Measurement

Radiated emissions which fall in the restricted bands must comply with the radiated emission limits specified as below table. Other emissions shall be at least 30dB below the highest level of the desired power:

Frequencies (MHz)	Field Strength (microvolts/meter)	Measurement Distance (meters)
0.009 ~ 0.490	2400/F(kHz)	300
0.490 ~ 1.705	24000/F(kHz)	30
1.705 ~ 30.0	30	30
30 ~ 88	100	3
88 ~ 216	150	3
216 ~ 960	200	3
Above 960	500	3

Note:

1. The lower limit shall apply at the transition frequencies.
2. Emission level (dBuV/m) = 20 log Emission level (uV/m).
3. For frequencies above 1000MHz, the field strength limits are based on average detector, however, the peak field strength of any emission shall not exceed the maximum permitted average limits, specified above by more than 30dB under any condition of modulation.

4.1.2 Test Instruments

Description & Manufacturer	Model No.	Serial No.	Cal. Date	Cal. Due
Test Receiver ROHDE & SCHWARZ	ESIB7	100187	May 02, 2017	May 01, 2018
Spectrum Analyzer ROHDE & SCHWARZ	FSP40	100041	Nov. 16, 2016	Nov. 15, 2017
BILOG Antenna SCHWARZBECK	VULB9168	9168-171	Dec. 28, 2016	Dec. 27, 2017
HORN Antenna SCHWARZBECK	9120D	209	Dec. 27, 2016	Dec. 26, 2017
HORN Antenna SCHWARZBECK	BBHA 9170	BBHA9170241	Dec. 14, 2016	Dec. 13, 2017
Loop Antenna	EM-6879	269	Aug. 11, 2016	Aug. 10, 2017
Preamplifier Agilent	8447D	2944A10738	Aug. 22, 2016	Aug. 21, 2017
Preamplifier Agilent	8449B	3008A01922	Sep. 18, 2016	Sep. 17, 2017
RF signal cable HUBER+SUHNER	SUCOFLEX 104	Cable-CH3-03 (214378)	Aug. 22, 2016	Aug. 21, 2017
RF signal cable HUBER+SUHNER	SUCOFLEX 106	Cable-CH3-03 (309224+12738)	Aug. 22, 2016	Aug. 21, 2017
Software BV ADT	ADT_Radiated_ V7.6.15.9.4	NA	NA	NA
Antenna Tower inn-co GmbH	MA 4000	013303	NA	NA
Antenna Tower Controller BV ADT	AT100	AT93021702	NA	NA
Turn Table BV ADT	TT100	TT93021702	NA	NA
Turn Table Controller BV ADT	SC100	SC93021702	NA	NA
High Speed Peak Power Meter	ML2495A	0824012	Aug. 11, 2016	Aug. 10, 2017
Power Sensor	MA2411B	0738171	Aug. 11, 2016	Aug. 10, 2017

- Note:
1. The calibration interval of the above test instruments is 12 months and the calibrations are traceable to NML/ROC and NIST/USA.
 2. The test was performed in HwaYa Chamber 3.
 3. The horn antenna and preamplifier (model: 8449B) are used only for the measurement of emission frequency above 1GHz if tested.
 4. The FCC Designation Number is TW0003. The number will be varied with the Lab location and scope as attached.
 5. The IC Site Registration No. is IC 7450F-3.

4.1.3 Test Procedures

For Radiated emission below 30MHz

- a. The EUT was placed on the top of a rotating table 0.8 meters above the ground at a 3 meter chamber room. The table was rotated 360 degrees to determine the position of the highest radiation.
- b. The EUT was set 3 meters away from the interference-receiving antenna, which was mounted on the top of a variable-height antenna tower.
- c. Both X and Y axes of the antenna are set to make the measurement.
- d. For each suspected emission, the EUT was arranged to its worst case and the rotatable table was turned from 0 degrees to 360 degrees to find the maximum reading.
- e. The test-receiver system was set to Quasi-Peak Detect Function and Specified Bandwidth with Maximum Hold Mode.

Note:

1. The resolution bandwidth and video bandwidth of test receiver/spectrum analyzer is 9kHz at frequency below 30MHz.

For Radiated emission above 30MHz

- a. The EUT was placed on the top of a rotating table 0.8 meters (for 30MHz ~ 1GHz) / 1.5 meters (for above 1GHz) above the ground at 3 meter chamber room for test. The table was rotated 360 degrees to determine the position of the highest radiation.
- b. The EUT was set 3 meters away from the interference-receiving antenna, which was mounted on the top of a variable-height antenna tower.
- c. The height of antenna is varied from one meter to four meters above the ground to determine the maximum value of the field strength. Both horizontal and vertical polarizations of the antenna are set to make the measurement.
- d. For each suspected emission, the EUT was arranged to its worst case and then the antenna was tuned to heights from 1 meter to 4 meters and the rotatable table was turned from 0 degrees to 360 degrees to find the maximum reading.
- e. The test-receiver system was set to quasi-peak detect function and specified bandwidth with maximum hold mode when the test frequency is below 1 GHz.
- f. The test-receiver system was set to peak and average detect function and specified bandwidth with maximum hold mode when the test frequency is above 1 GHz. If the peak reading value also meets average limit, measurement with the average detector is unnecessary.

Note:

1. The resolution bandwidth and video bandwidth of test receiver/spectrum analyzer is 120kHz for Quasi-peak detection (QP) at frequency below 1GHz.
2. The resolution bandwidth of test receiver/spectrum analyzer is 1 MHz and the video bandwidth is 3 MHz for Peak detection (PK) at frequency above 1GHz.
3. The resolution bandwidth of test receiver/spectrum analyzer is 1 MHz and the video bandwidth is $\geq 1/T$ (Duty cycle < 98%) or 10 Hz (Duty cycle $\geq 98\%$) for Peak detection at frequency above 1GHz.
4. All modes of operation were investigated and the worst-case emissions are reported.

4.1.4 Deviation from Test Standard

No deviation.

4.1.5 Test Setup

For Radiated emission below 30MHz

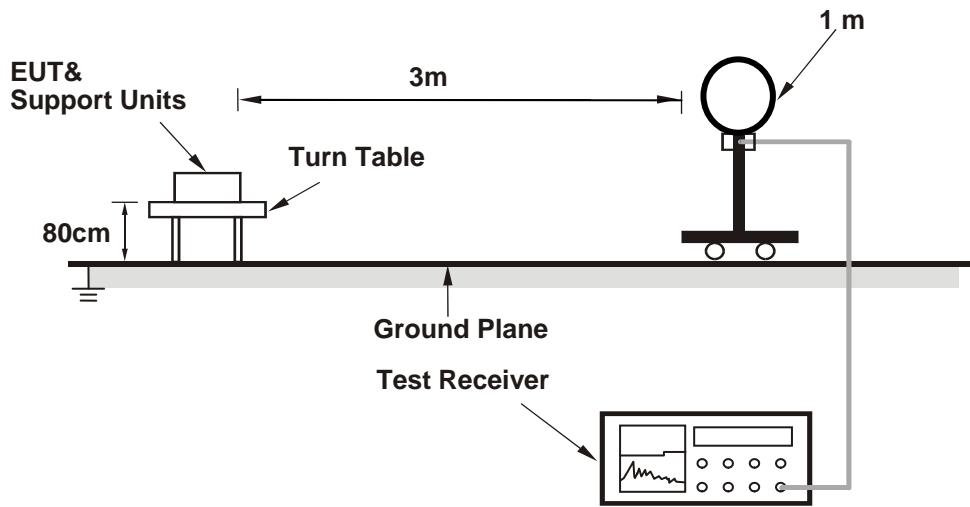

For Radiated emission 30MHz to 1GHz

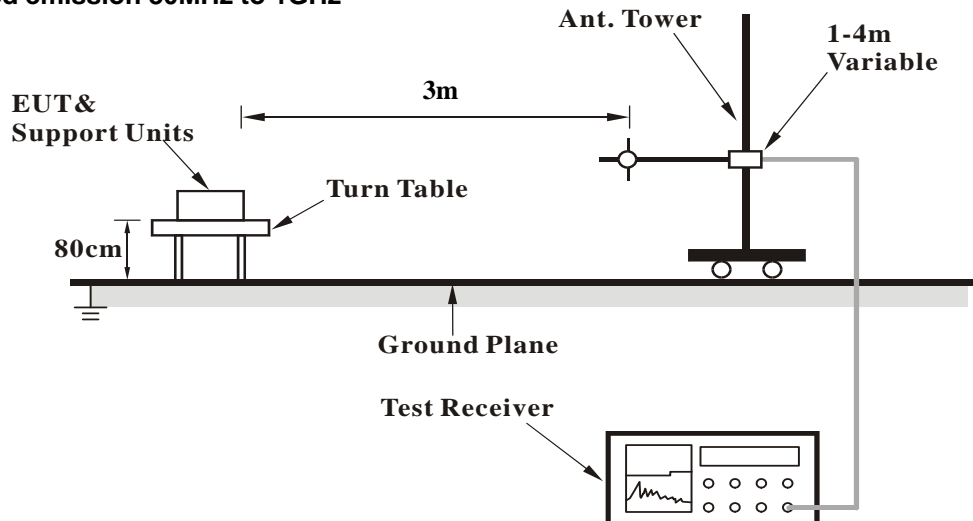

For Radiated emission above 1GHz

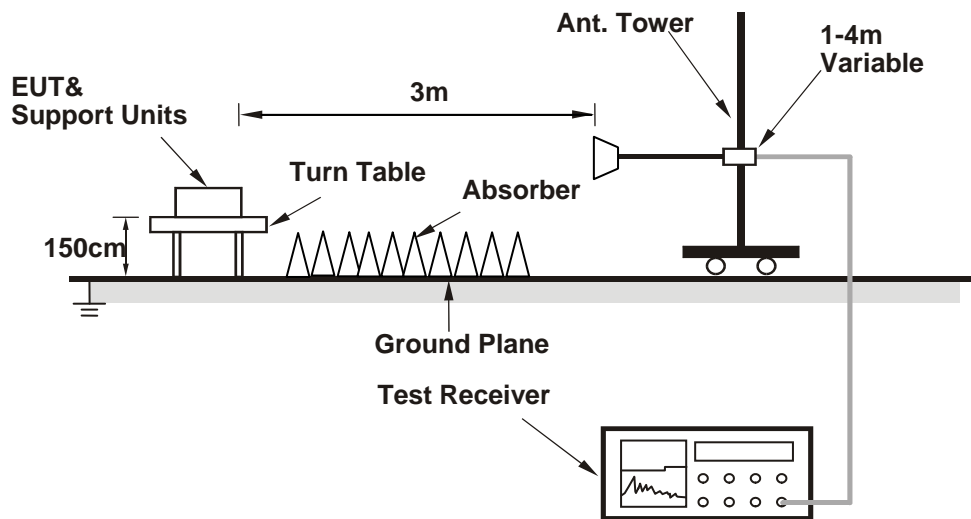

For the actual test configuration, please refer to the attached file (Test Setup Photo).

4.1.6 EUT Operating Conditions

- a. Placed the EUT on the testing table.
- b. Prepared a notebook to act as a communication partner and placed it outside of testing area.
- c. The communication partner connected with EUT via a RJ45 cable and ran a test program (provided by manufacturer) to enable EUT under transmission condition continuously at specific channel frequency.
- d. The communication partner sent data to EUT by command "PING".

4.1.7 Test Results

Above 1GHz Data:

Test Mode B

CHANNEL	TX Channel 0	DETECTOR	Peak (PK)
FREQUENCY RANGE	1GHz ~ 25GHz	FUNCTION	Average (AV)

ANTENNA POLARITY & TEST DISTANCE: HORIZONTAL AT 3 M								
NO.	FREQ. (MHz)	EMISSION LEVEL (dBuV/m)	LIMIT (dBuV/m)	MARGIN (dB)	ANTENNA HEIGHT (m)	TABLE ANGLE (Degree)	RAW VALUE (dBuV)	CORRECTION FACTOR (dB/m)
1	2390.00	54.1 PK	74.0	-19.9	1.51 H	48	23.1	31.0
2	2390.00	43.3 AV	54.0	-10.7	1.51 H	48	12.3	31.0
3	*2402.00	89.1 PK			1.51 H	48	57.9	31.2
4	*2402.00	85.0 AV			1.51 H	48	53.8	31.2
5	4804.00	46.0 PK	74.0	-28.0	1.69 H	287	45.6	0.4
6	4804.00	34.4 AV	54.0	-19.6	1.69 H	287	34.0	0.4
ANTENNA POLARITY & TEST DISTANCE: VERTICAL AT 3 M								
NO.	FREQ. (MHz)	EMISSION LEVEL (dBuV/m)	LIMIT (dBuV/m)	MARGIN (dB)	ANTENNA HEIGHT (m)	TABLE ANGLE (Degree)	RAW VALUE (dBuV)	CORRECTION FACTOR (dB/m)
1	2390.00	54.0 PK	74.0	-20.0	1.61 V	346	23.0	31.0
2	2390.00	43.2 AV	54.0	-10.8	1.61 V	346	12.2	31.0
3	*2402.00	101.1 PK			1.61 V	346	69.9	31.2
4	*2402.00	96.4 AV			1.61 V	346	65.2	31.2
5	4804.00	45.7 PK	74.0	-28.3	1.80 V	41	45.3	0.4
6	4804.00	32.9 AV	54.0	-21.1	1.80 V	41	32.5	0.4

Remarks:

1. Emission Level(dBuV/m) = Raw Value(dBuV) + Correction Factor(dB/m)
2. Correction Factor(dB/m) = Antenna Factor(dB/m) + Cable Factor(dB) – Pre-Amplifier Factor(dB)
3. The other emission levels were very low against the limit.
4. Margin value = Emission Level – Limit value
5. " * ": Fundamental frequency.

CHANNEL	TX Channel 19	DETECTOR FUNCTION	Peak (PK)
FREQUENCY RANGE	1GHz ~ 25GHz		Average (AV)

ANTENNA POLARITY & TEST DISTANCE: HORIZONTAL AT 3 M

NO.	FREQ. (MHz)	EMISSION LEVEL (dBuV/m)	LIMIT (dBuV/m)	MARGIN (dB)	ANTENNA HEIGHT (m)	TABLE ANGLE (Degree)	RAW VALUE (dBuV)	CORRECTION FACTOR (dB/m)
1	*2440.00	88.3 PK			1.60 H	56	57.0	31.3
2	*2440.00	84.8 AV			1.60 H	56	53.5	31.3
3	4880.00	45.5 PK	74.0	-28.5	1.33 H	359	44.9	0.6
4	4880.00	32.7 AV	54.0	-21.3	1.33 H	359	32.1	0.6

ANTENNA POLARITY & TEST DISTANCE: VERTICAL AT 3 M

NO.	FREQ. (MHz)	EMISSION LEVEL (dBuV/m)	LIMIT (dBuV/m)	MARGIN (dB)	ANTENNA HEIGHT (m)	TABLE ANGLE (Degree)	RAW VALUE (dBuV)	CORRECTION FACTOR (dB/m)
1	*2440.00	100.9 PK			1.64 V	350	69.6	31.3
2	*2440.00	96.4 AV			1.64 V	350	65.1	31.3
3	4880.00	46.9 PK	74.0	-27.1	1.88 V	222	46.3	0.6
4	4880.00	34.5 AV	54.0	-19.5	1.88 V	222	33.9	0.6

Remarks:

1. Emission Level(dBuV/m) = Raw Value(dBuV) + Correction Factor(dB/m)
2. Correction Factor(dB/m) = Antenna Factor(dB/m) + Cable Factor(dB) – Pre-Amplifier Factor(dB)
3. The other emission levels were very low against the limit.
4. Margin value = Emission Level – Limit value
5. " * ": Fundamental frequency.

CHANNEL	TX Channel 39	DETECTOR FUNCTION	Peak (PK)
FREQUENCY RANGE	1GHz ~ 25GHz		Average (AV)

ANTENNA POLARITY & TEST DISTANCE: HORIZONTAL AT 3 M								
NO.	FREQ. (MHz)	EMISSION LEVEL (dBuV/m)	LIMIT (dBuV/m)	MARGIN (dB)	ANTENNA HEIGHT (m)	TABLE ANGLE (Degree)	RAW VALUE (dBuV)	CORRECTION FACTOR (dB/m)
1	*2480.00	90.0 PK			1.54 H	54	58.5	31.5
2	*2480.00	86.0 AV			1.54 H	54	54.5	31.5
3	2483.50	59.8 PK	74.0	-14.2	1.54 H	54	28.3	31.5
4	2483.50	44.9 AV	54.0	-9.1	1.54 H	54	13.4	31.5
5	4960.00	46.0 PK	74.0	-28.0	1.69 H	123	45.2	0.8
6	4960.00	33.5 AV	54.0	-20.5	1.69 H	123	32.7	0.8
ANTENNA POLARITY & TEST DISTANCE: VERTICAL AT 3 M								
NO.	FREQ. (MHz)	EMISSION LEVEL (dBuV/m)	LIMIT (dBuV/m)	MARGIN (dB)	ANTENNA HEIGHT (m)	TABLE ANGLE (Degree)	RAW VALUE (dBuV)	CORRECTION FACTOR (dB/m)
1	*2480.00	102.3 PK			1.61 V	352	70.8	31.5
2	*2480.00	97.4 AV			1.61 V	352	65.9	31.5
3	2483.50	70.6 PK	74.0	-3.4	1.61 V	352	39.1	31.5
4	2483.50	47.2 AV	54.0	-6.8	1.61 V	352	15.7	31.5
5	4960.00	47.3 PK	74.0	-26.7	1.95 V	243	46.5	0.8
6	4960.00	34.7 AV	54.0	-19.3	1.95 V	243	33.9	0.8

Remarks:

1. Emission Level(dBuV/m) = Raw Value(dBuV) + Correction Factor(dB/m)
2. Correction Factor(dB/m) = Antenna Factor(dB/m) + Cable Factor(dB) – Pre-Amplifier Factor(dB)
3. The other emission levels were very low against the limit.
4. Margin value = Emission Level – Limit value
5. " * ": Fundamental frequency.

Test Mode D

CHANNEL	TX Channel 0	DETECTOR	Peak (PK)
FREQUENCY RANGE	1GHz ~ 25GHz	FUNCTION	Average (AV)

ANTENNA POLARITY & TEST DISTANCE: HORIZONTAL AT 3 M

NO.	FREQ. (MHz)	EMISSION LEVEL (dBuV/m)	LIMIT (dBuV/m)	MARGIN (dB)	ANTENNA HEIGHT (m)	TABLE ANGLE (Degree)	RAW VALUE (dBuV)	CORRECTION FACTOR (dB/m)
1	2390.00	55.7 PK	74.0	-18.3	1.58 H	129	24.7	31.0
2	2390.00	43.6 AV	54.0	-10.4	1.58 H	129	12.6	31.0
3	*2402.00	101.9 PK			1.50 H	14	70.7	31.2
4	*2402.00	97.3 AV			1.50 H	14	66.1	31.2
5	4804.00	45.7 PK	74.0	-28.3	2.49 H	28	45.3	0.4
6	4804.00	32.5 AV	54.0	-21.5	2.49 H	28	32.1	0.4

ANTENNA POLARITY & TEST DISTANCE: VERTICAL AT 3 M

NO.	FREQ. (MHz)	EMISSION LEVEL (dBuV/m)	LIMIT (dBuV/m)	MARGIN (dB)	ANTENNA HEIGHT (m)	TABLE ANGLE (Degree)	RAW VALUE (dBuV)	CORRECTION FACTOR (dB/m)
1	2390.00	54.0 PK	74.0	-20.0	2.37 V	239	23.0	31.0
2	2390.00	43.1 AV	54.0	-10.9	2.37 V	239	12.1	31.0
3	*2402.00	91.5 PK			2.37 V	239	60.3	31.2
4	*2402.00	87.4 AV			2.37 V	239	56.2	31.2
5	4804.00	45.8 PK	74.0	-28.2	1.92 V	32	45.4	0.4
6	4804.00	33.4 AV	54.0	-20.6	1.92 V	32	33.0	0.4

Remarks:

1. Emission Level(dBuV/m) = Raw Value(dBuV) + Correction Factor(dB/m)
2. Correction Factor(dB/m) = Antenna Factor(dB/m) + Cable Factor(dB) – Pre-Amplifier Factor(dB)
3. The other emission levels were very low against the limit.
4. Margin value = Emission Level – Limit value
5. " * ": Fundamental frequency.

CHANNEL	TX Channel 19	DETECTOR FUNCTION	Peak (PK)
FREQUENCY RANGE	1GHz ~ 25GHz		Average (AV)

ANTENNA POLARITY & TEST DISTANCE: HORIZONTAL AT 3 M

NO.	FREQ. (MHz)	EMISSION LEVEL (dBuV/m)	LIMIT (dBuV/m)	MARGIN (dB)	ANTENNA HEIGHT (m)	TABLE ANGLE (Degree)	RAW VALUE (dBuV)	CORRECTION FACTOR (dB/m)
1	*2440.00	102.1 PK			1.37 H	0	70.8	31.3
2	*2440.00	97.8 AV			1.37 H	0	66.5	31.3
3	4880.00	48.0 PK	74.0	-26.0	1.32 H	350	47.4	0.6
4	4880.00	35.0 AV	54.0	-19.0	1.32 H	350	34.4	0.6

ANTENNA POLARITY & TEST DISTANCE: VERTICAL AT 3 M

NO.	FREQ. (MHz)	EMISSION LEVEL (dBuV/m)	LIMIT (dBuV/m)	MARGIN (dB)	ANTENNA HEIGHT (m)	TABLE ANGLE (Degree)	RAW VALUE (dBuV)	CORRECTION FACTOR (dB/m)
1	*2440.00	88.1 PK			1.98 V	240	56.8	31.3
2	*2440.00	84.1 AV			1.98 V	240	52.8	31.3
3	4880.00	46.1 PK	74.0	-27.9	1.56 V	56	45.5	0.6
4	4880.00	33.3 AV	54.0	-20.7	1.56 V	56	32.7	0.6

Remarks:

1. Emission Level(dBuV/m) = Raw Value(dBuV) + Correction Factor(dB/m)
2. Correction Factor(dB/m) = Antenna Factor(dB/m) + Cable Factor(dB) – Pre-Amplifier Factor(dB)
3. The other emission levels were very low against the limit.
4. Margin value = Emission Level – Limit value
5. " * ": Fundamental frequency.

CHANNEL	TX Channel 39	DETECTOR FUNCTION	Peak (PK)
FREQUENCY RANGE	1GHz ~ 25GHz		Average (AV)

ANTENNA POLARITY & TEST DISTANCE: HORIZONTAL AT 3 M								
NO.	FREQ. (MHz)	EMISSION LEVEL (dBuV/m)	LIMIT (dBuV/m)	MARGIN (dB)	ANTENNA HEIGHT (m)	TABLE ANGLE (Degree)	RAW VALUE (dBuV)	CORRECTION FACTOR (dB/m)
1	*2480.00	102.3 PK			1.36 H	7	70.8	31.5
2	*2480.00	97.6 AV			1.36 H	7	66.1	31.5
3	2483.50	70.5 PK	74.0	-3.5	1.36 H	7	39.0	31.5
4	2483.50	47.8 AV	54.0	-6.2	1.36 H	7	16.3	31.5
5	4960.00	48.4 PK	74.0	-25.6	1.40 H	341	47.6	0.8
6	4960.00	35.8 AV	54.0	-18.2	1.40 H	341	35.0	0.8

ANTENNA POLARITY & TEST DISTANCE: VERTICAL AT 3 M								
NO.	FREQ. (MHz)	EMISSION LEVEL (dBuV/m)	LIMIT (dBuV/m)	MARGIN (dB)	ANTENNA HEIGHT (m)	TABLE ANGLE (Degree)	RAW VALUE (dBuV)	CORRECTION FACTOR (dB/m)
1	*2480.00	90.8 PK			1.98 V	273	59.3	31.5
2	*2480.00	87.0 AV			1.98 V	273	55.5	31.5
3	2483.50	60.4 PK	74.0	-13.6	1.98 V	273	28.9	31.5
4	2483.50	43.9 AV	54.0	-10.1	1.98 V	273	12.4	31.5
5	4960.00	46.9 PK	74.0	-27.1	2.45 V	89	46.1	0.8
6	4960.00	33.3 AV	54.0	-20.7	2.45 V	89	32.5	0.8

Remarks:

1. Emission Level(dBuV/m) = Raw Value(dBuV) + Correction Factor(dB/m)
2. Correction Factor(dB/m) = Antenna Factor(dB/m) + Cable Factor(dB) – Pre-Amplifier Factor(dB)
3. The other emission levels were very low against the limit.
4. Margin value = Emission Level – Limit value
5. " * ": Fundamental frequency.

Below 1GHz worst-case data:

CHANNEL	TX Channel 0	DETECTOR FUNCTION	Quasi-Peak (QP)
FREQUENCY RANGE	9kHz ~ 1GHz		
TEST MODE	A		

ANTENNA POLARITY & TEST DISTANCE: HORIZONTAL AT 3 M

NO.	FREQ. (MHz)	EMISSION LEVEL (dBuV/m)	LIMIT (dBuV/m)	MARGIN (dB)	ANTENNA HEIGHT (m)	TABLE ANGLE (Degree)	RAW VALUE (dBuV)	CORRECTION FACTOR (dB/m)
1	57.12	27.2 QP	40.0	-12.8	2.00 H	120	41.8	-14.6
2	70.73	29.7 QP	40.0	-10.3	2.00 H	222	46.1	-16.4
3	154.33	31.6 QP	43.5	-11.9	2.00 H	85	45.3	-13.7
4	389.59	29.4 QP	46.0	-16.6	2.00 H	248	39.6	-10.2
5	506.25	35.1 QP	46.0	-10.9	1.51 H	118	42.7	-7.6
6	935.94	34.5 QP	46.0	-11.5	2.00 H	21	33.6	0.9

ANTENNA POLARITY & TEST DISTANCE: VERTICAL AT 3 M

NO.	FREQ. (MHz)	EMISSION LEVEL (dBuV/m)	LIMIT (dBuV/m)	MARGIN (dB)	ANTENNA HEIGHT (m)	TABLE ANGLE (Degree)	RAW VALUE (dBuV)	CORRECTION FACTOR (dB/m)
1	49.34	35.5 QP	40.0	-4.5	1.00 V	76	49.8	-14.3
2	68.79	37.1 QP	40.0	-2.9	1.00 V	12	53.2	-16.1
3	125.17	31.8 QP	43.5	-11.7	1.00 V	183	47.6	-15.8
4	249.60	29.0 QP	46.0	-17.0	1.00 V	67	43.0	-14.0
5	370.15	28.8 QP	46.0	-17.2	1.00 V	150	39.4	-10.6
6	502.36	36.4 QP	46.0	-9.6	1.50 V	155	44.1	-7.7

Remarks:

1. Emission Level(dBuV/m) = Raw Value(dBuV) + Correction Factor(dB/m)
2. Correction Factor(dB/m) = Antenna Factor(dB/m) + Cable Factor(dB) – Pre-Amplifier Factor(dB)
3. The other emission levels were very low against the limit.
4. Margin value = Emission Level – Limit value

CHANNEL	TX Channel 0	DETECTOR FUNCTION	Quasi-Peak (QP)
FREQUENCY RANGE	9kHz ~ 1GHz		
TEST MODE	B		

ANTENNA POLARITY & TEST DISTANCE: HORIZONTAL AT 3 M

NO.	FREQ. (MHz)	EMISSION LEVEL (dBuV/m)	LIMIT (dBuV/m)	MARGIN (dB)	ANTENNA HEIGHT (m)	TABLE ANGLE (Degree)	RAW VALUE (dBuV)	CORRECTION FACTOR (dB/m)
1	70.73	28.8 QP	40.0	-11.2	2.00 H	250	45.2	-16.4
2	103.78	27.1 QP	43.5	-16.4	2.00 H	247	45.1	-18.0
3	162.11	30.4 QP	43.5	-13.1	1.50 H	87	44.1	-13.7
4	397.37	26.2 QP	46.0	-19.8	1.01 H	129	36.4	-10.2
5	500.42	29.9 QP	46.0	-16.1	2.00 H	113	37.8	-7.9
6	933.99	33.2 QP	46.0	-12.8	2.00 H	322	32.1	1.1

ANTENNA POLARITY & TEST DISTANCE: VERTICAL AT 3 M

NO.	FREQ. (MHz)	EMISSION LEVEL (dBuV/m)	LIMIT (dBuV/m)	MARGIN (dB)	ANTENNA HEIGHT (m)	TABLE ANGLE (Degree)	RAW VALUE (dBuV)	CORRECTION FACTOR (dB/m)
1	45.45	38.3 QP	40.0	-1.7	1.50 V	16	53.0	-14.7
2	70.73	37.3 QP	40.0	-2.7	1.00 V	5	53.7	-16.4
3	105.73	29.0 QP	43.5	-14.5	1.00 V	276	46.7	-17.7
4	150.45	32.6 QP	43.5	-10.9	1.99 V	15	46.5	-13.9
5	500.42	30.5 QP	46.0	-15.5	1.00 V	164	38.4	-7.9
6	745.40	44.1 QP	46.0	-1.9	1.99 V	15	46.4	-2.3
7	937.88	33.8 QP	46.0	-12.2	1.99 V	15	32.7	1.1

Remarks:

1. Emission Level(dBuV/m) = Raw Value(dBuV) + Correction Factor(dB/m)
2. Correction Factor(dB/m) = Antenna Factor(dB/m) + Cable Factor(dB) – Pre-Amplifier Factor(dB)
3. The other emission levels were very low against the limit.
4. Margin value = Emission Level – Limit value

CHANNEL	TX Channel 0	DETECTOR FUNCTION	Quasi-Peak (QP)
FREQUENCY RANGE	9kHz ~ 1GHz		
TEST MODE	C		

ANTENNA POLARITY & TEST DISTANCE: HORIZONTAL AT 3 M

NO.	FREQ. (MHz)	EMISSION LEVEL (dBuV/m)	LIMIT (dBuV/m)	MARGIN (dB)	ANTENNA HEIGHT (m)	TABLE ANGLE (Degree)	RAW VALUE (dBuV)	CORRECTION FACTOR (dB/m)
1	70.73	30.0 QP	40.0	-10.0	2.00 H	224	46.4	-16.4
2	152.39	31.5 QP	43.5	-12.0	2.00 H	99	45.3	-13.8
3	389.59	29.8 QP	46.0	-16.2	2.00 H	241	40.0	-10.2
4	504.31	34.9 QP	46.0	-11.1	1.50 H	128	42.6	-7.7
5	737.62	31.4 QP	46.0	-14.6	1.50 H	264	34.0	-2.6
6	935.94	34.5 QP	46.0	-11.5	1.50 H	40	33.6	0.9

ANTENNA POLARITY & TEST DISTANCE: VERTICAL AT 3 M

NO.	FREQ. (MHz)	EMISSION LEVEL (dBuV/m)	LIMIT (dBuV/m)	MARGIN (dB)	ANTENNA HEIGHT (m)	TABLE ANGLE (Degree)	RAW VALUE (dBuV)	CORRECTION FACTOR (dB/m)
1	49.34	36.1 QP	40.0	-3.9	1.00 V	0	50.4	-14.3
2	66.84	36.3 QP	40.0	-3.7	1.00 V	332	52.2	-15.9
3	125.17	31.9 QP	43.5	-11.6	1.00 V	145	47.7	-15.8
4	267.10	28.6 QP	46.0	-17.4	1.00 V	46	41.8	-13.2
5	405.15	28.9 QP	46.0	-17.1	1.00 V	2	39.0	-10.1
6	506.25	35.8 QP	46.0	-10.2	1.00 V	172	43.4	-7.6

Remarks:

1. Emission Level(dBuV/m) = Raw Value(dBuV) + Correction Factor(dB/m)
2. Correction Factor(dB/m) = Antenna Factor(dB/m) + Cable Factor(dB) – Pre-Amplifier Factor(dB)
3. The other emission levels were very low against the limit.
4. Margin value = Emission Level – Limit value

CHANNEL	TX Channel 0	DETECTOR FUNCTION	Quasi-Peak (QP)
FREQUENCY RANGE	9kHz ~ 1GHz		
TEST MODE	D		

ANTENNA POLARITY & TEST DISTANCE: HORIZONTAL AT 3 M

NO.	FREQ. (MHz)	EMISSION LEVEL (dBuV/m)	LIMIT (dBuV/m)	MARGIN (dB)	ANTENNA HEIGHT (m)	TABLE ANGLE (Degree)	RAW VALUE (dBuV)	CORRECTION FACTOR (dB/m)
1	70.73	32.1 QP	40.0	-7.9	2.00 H	233	48.5	-16.4
2	101.84	25.7 QP	43.5	-17.8	2.00 H	85	43.9	-18.2
3	154.33	30.8 QP	43.5	-12.7	2.00 H	111	44.5	-13.7
4	395.43	29.9 QP	46.0	-16.1	2.00 H	193	40.0	-10.1
5	506.25	31.8 QP	46.0	-14.2	1.50 H	125	39.4	-7.6
6	935.94	33.2 QP	46.0	-12.8	1.00 H	324	32.3	0.9

ANTENNA POLARITY & TEST DISTANCE: VERTICAL AT 3 M

NO.	FREQ. (MHz)	EMISSION LEVEL (dBuV/m)	LIMIT (dBuV/m)	MARGIN (dB)	ANTENNA HEIGHT (m)	TABLE ANGLE (Degree)	RAW VALUE (dBuV)	CORRECTION FACTOR (dB/m)
1	45.45	36.3 QP	40.0	-3.7	1.00 V	75	51.0	-14.7
2	68.79	37.0 QP	40.0	-3.0	1.00 V	33	53.1	-16.1
3	152.39	26.5 QP	43.5	-17.0	1.00 V	192	40.3	-13.8
4	395.43	29.3 QP	46.0	-16.7	1.00 V	359	39.4	-10.1
5	506.25	34.4 QP	46.0	-11.6	1.00 V	161	42.0	-7.6
6	937.88	34.1 QP	46.0	-11.9	1.50 V	186	33.0	1.1

Remarks:

1. Emission Level(dBuV/m) = Raw Value(dBuV) + Correction Factor(dB/m)
2. Correction Factor(dB/m) = Antenna Factor(dB/m) + Cable Factor(dB) – Pre-Amplifier Factor(dB)
3. The other emission levels were very low against the limit.
4. Margin value = Emission Level – Limit value

4.2 Conducted Emission Measurement

4.2.1 Limits of Conducted Emission Measurement

Frequency (MHz)	Conducted Limit (dBUV)	
	Quasi-peak	Average
0.15 - 0.5	66 - 56	56 - 46
0.50 - 5.0	56	46
5.0 - 30.0	60	50

Note: 1. The lower limit shall apply at the transition frequencies.
 2. The limit decreases in line with the logarithm of the frequency in the range of 0.15 to 0.50MHz.

4.2.2 Test Instruments

Description & Manufacturer	Model No.	Serial No.	Cal. Date	Cal. Due
Test Receiver ROHDE & SCHWARZ	ESCI	100613	Nov. 21, 2016	Nov. 20, 2017
RF signal cable (with 10dB PAD) Woken	5D-FB	Cable-cond1-01	Dec. 22, 2016	Dec. 21, 2017
LISN ROHDE & SCHWARZ (EUT)	ESH3-Z5	835239/001	Mar. 10, 2017	Mar. 09, 2018
LISN ROHDE & SCHWARZ (Peripheral)	ESH3-Z5	100311	Jul. 28, 2016	Jul. 27, 2017
Software ADT	BV ADT_Cond_ V7.3.7.3	NA	NA	NA

Note: 1. The calibration interval of the above test instruments is 12 months and the calibrations are traceable to NML/ROC and NIST/USA.
 2. The test was performed in HwaYa Shielded Room 1.
 3. The VCCI Site Registration No. is C-2040.

4.2.3 Test Procedures

- The EUT was placed 0.4 meters from the conducting wall of the shielded room with EUT being connected to the power mains through a line impedance stabilization network (LISN). Other support units were connected to the power mains through another LISN. The two LISNs provide 50 ohm/ 50uH of coupling impedance for the measuring instrument.
- Both lines of the power mains connected to the EUT were checked for maximum conducted interference.
- The frequency range from 150kHz to 30MHz was searched. Emission levels under (Limit - 20dB) was not recorded.

Note: The resolution bandwidth and video bandwidth of test receiver is 9kHz for quasi-peak detection (QP) and average detection (AV) at frequency 0.15MHz-30MHz.

4.2.4 Deviation from Test Standard

No deviation.

4.2.5 Test Setup

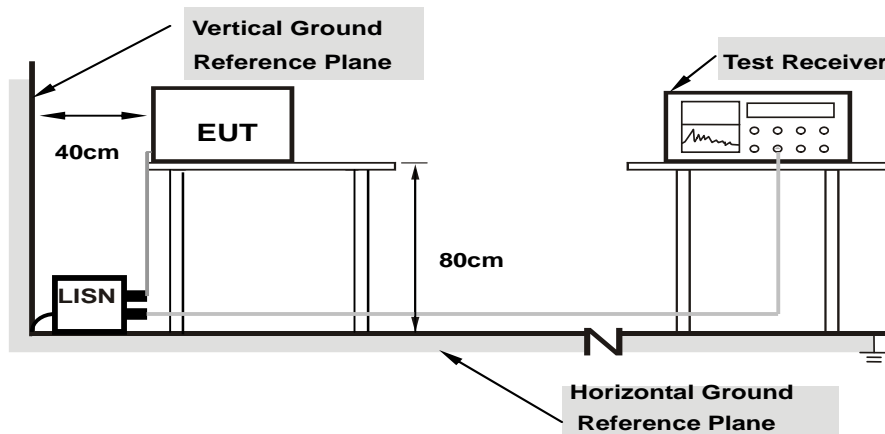

Note: 1.Support units were connected to second LISN.

For the actual test configuration, please refer to the attached file (Test Setup Photo).

4.2.6 EUT Operating Conditions

Same as 4.1.6.

4.2.7 Test Results

Phase	Line (L)	Detector Function	Quasi-Peak (QP) / Average (AV)
Test Mode	A		

No	Freq. [MHz]	Corr. Factor (dB)	Reading Value [dB (uV)]		Emission Level [dB (uV)]		Limit [dB (uV)]		Margin (dB)	
			Q.P.	AV.	Q.P.	AV.	Q.P.	AV.	Q.P.	AV.
			1	0.16932	10.41	36.34	25.44	46.75	35.85	64.99
2	0.19013	10.43	32.33	22.97	42.76	33.40	64.03	54.03	-21.27	-20.63
3	0.31200	10.47	29.15	27.70	39.62	38.17	59.92	49.92	-20.30	-11.75
4	0.33800	10.49	34.18	31.08	44.67	41.57	59.25	49.25	-14.58	-7.68
5	0.35407	10.49	33.24	28.06	43.73	38.55	58.87	48.87	-15.14	-10.32
6	7.56181	10.80	22.96	16.72	33.76	27.52	60.00	50.00	-26.24	-22.48

Remarks:

1. Q.P. and AV. are abbreviations of quasi-peak and average individually.
2. The emission levels of other frequencies were very low against the limit.
3. Margin value = Emission level - Limit value
4. Correction factor = Insertion loss + Cable loss
5. Emission Level = Correction Factor + Reading Value.

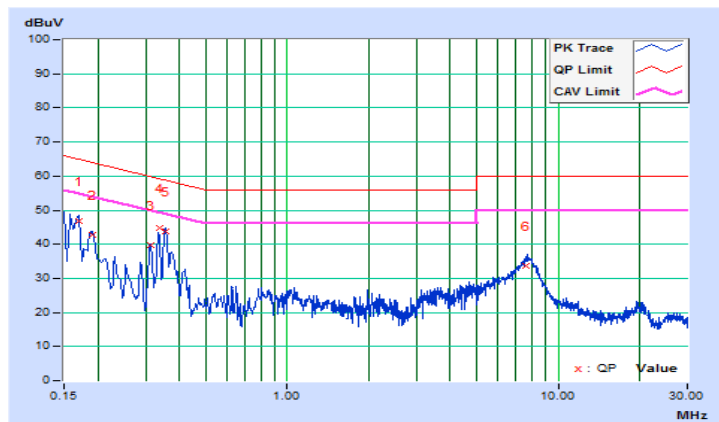

Phase	Neutral (N)	Detector Function	Quasi-Peak (QP) / Average (AV)
Test Mode	A		

No	Freq. [MHz]	Corr. Factor (dB)	Reading Value [dB (uV)]		Emission Level [dB (uV)]		Limit [dB (uV)]		Margin (dB)	
			Q.P.	AV.	Q.P.	AV.	Q.P.	AV.	Q.P.	AV.
			1	0.16105	10.16	31.19	18.22	41.35	28.38	65.41
2	0.17400	10.18	30.18	18.05	40.36	28.23	64.77	54.77	-24.41	-26.54
3	0.20523	10.20	24.04	11.68	34.24	21.88	63.40	53.40	-29.16	-31.52
4	0.22152	10.20	23.26	10.52	33.46	20.72	62.76	52.76	-29.30	-32.04
5	0.24164	10.21	22.01	8.89	32.22	19.10	62.04	52.04	-29.82	-32.94
6	7.67800	10.55	23.44	17.30	33.99	27.85	60.00	50.00	-26.01	-22.15

Remarks:

1. Q.P. and AV. are abbreviations of quasi-peak and average individually.
2. The emission levels of other frequencies were very low against the limit.
3. Margin value = Emission level - Limit value
4. Correction factor = Insertion loss + Cable loss
5. Emission Level = Correction Factor + Reading Value.

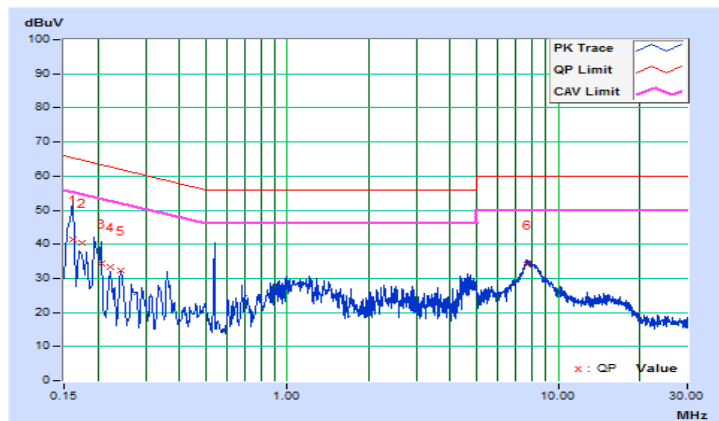

Phase	Line (L)	Detector Function	Quasi-Peak (QP) / Average (AV)
Test Mode	B		

No	Freq. [MHz]	Corr. Factor (dB)	Reading Value [dB (uV)]		Emission Level [dB (uV)]		Limit [dB (uV)]		Margin (dB)	
			Q.P.	AV.	Q.P.	AV.	Q.P.	AV.	Q.P.	AV.
			1	0.16535	10.41	36.24	22.45	46.65	32.86	65.19
2	0.17384	10.42	34.02	21.73	44.44	32.15	64.77	54.77	-20.33	-22.62
3	0.21800	10.44	26.53	15.39	36.97	25.83	62.89	52.89	-25.92	-27.06
4	0.24485	10.45	23.97	14.09	34.42	24.54	61.93	51.93	-27.51	-27.39
5	0.46813	10.50	35.52	31.02	46.02	41.52	56.55	46.55	-10.53	-5.03
6	0.93111	10.47	24.27	20.95	34.74	31.42	56.00	46.00	-21.26	-14.58

Remarks:

1. Q.P. and AV. are abbreviations of quasi-peak and average individually.
2. The emission levels of other frequencies were very low against the limit.
3. Margin value = Emission level - Limit value
4. Correction factor = Insertion loss + Cable loss
5. Emission Level = Correction Factor + Reading Value.

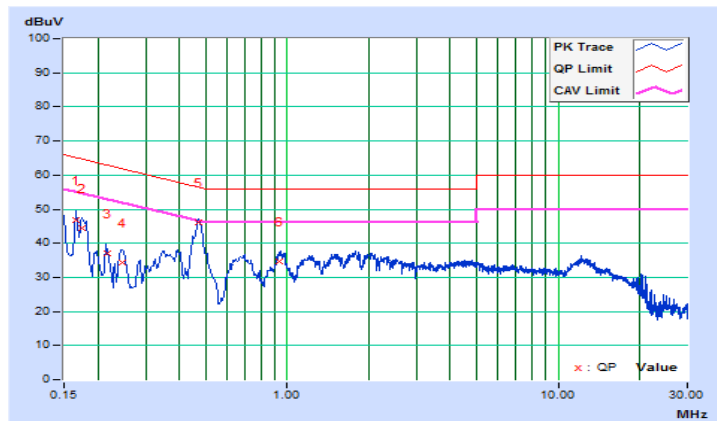

Phase	Neutral (N)	Detector Function	Quasi-Peak (QP) / Average (AV)
Test Mode	B		

No	Freq. [MHz]	Corr. Factor (dB)	Reading Value [dB (uV)]		Emission Level [dB (uV)]		Limit [dB (uV)]		Margin (dB)	
			Q.P.	AV.	Q.P.	AV.	Q.P.	AV.	Q.P.	AV.
			1	0.16200	10.17	34.85	21.39	45.02	31.56	65.36
2	0.17615	10.18	32.06	19.17	42.24	29.35	64.67	54.67	-22.43	-25.32
3	0.19013	10.19	30.11	16.89	40.30	27.08	64.03	54.03	-23.73	-26.95
4	0.20523	10.20	27.11	12.69	37.31	22.89	63.40	53.40	-26.09	-30.51
5	0.47000	10.23	35.61	31.33	45.84	41.56	56.51	46.51	-10.67	-4.95
6	0.94594	10.24	24.05	21.01	34.29	31.25	56.00	46.00	-21.71	-14.75

Remarks:

1. Q.P. and AV. are abbreviations of quasi-peak and average individually.
2. The emission levels of other frequencies were very low against the limit.
3. Margin value = Emission level - Limit value
4. Correction factor = Insertion loss + Cable loss
5. Emission Level = Correction Factor + Reading Value.

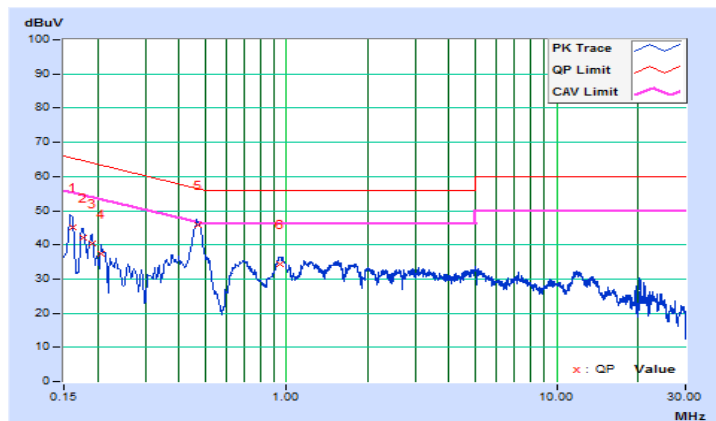

Phase	Line (L)	Detector Function	Quasi-Peak (QP) / Average (AV)
Test Mode	C		

No	Freq. [MHz]	Corr. Factor (dB)	Reading Value [dB (uV)]		Emission Level [dB (uV)]		Limit [dB (uV)]		Margin (dB)	
			Q.P.	AV.	Q.P.	AV.	Q.P.	AV.	Q.P.	AV.
			1	0.16105	10.41	41.19	26.77	51.60	37.18	65.41
2	0.18600	10.42	35.95	23.85	46.37	34.27	64.21	54.21	-17.84	-19.94
3	0.22200	10.44	32.45	18.51	42.89	28.95	62.74	52.74	-19.85	-23.79
4	0.34600	10.49	34.50	28.47	44.99	38.96	59.06	49.06	-14.07	-10.10
5	0.36834	10.50	31.53	27.31	42.03	37.81	58.54	48.54	-16.51	-10.73
6	7.48254	10.80	25.47	19.11	36.27	29.91	60.00	50.00	-23.73	-20.09

Remarks:

1. Q.P. and AV. are abbreviations of quasi-peak and average individually.
2. The emission levels of other frequencies were very low against the limit.
3. Margin value = Emission level - Limit value
4. Correction factor = Insertion loss + Cable loss
5. Emission Level = Correction Factor + Reading Value.

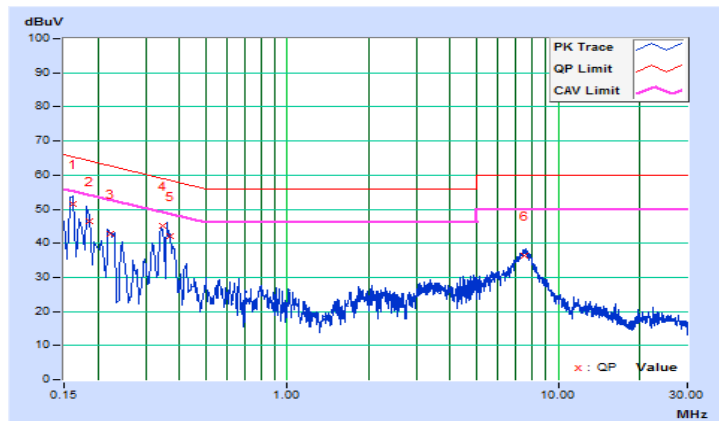

Phase	Neutral (N)	Detector Function	Quasi-Peak (QP) / Average (AV)
Test Mode	C		

No	Freq. [MHz]	Corr. Factor (dB)	Reading Value [dB (uV)]		Emission Level [dB (uV)]		Limit [dB (uV)]		Margin (dB)	
			Q.P.	AV.	Q.P.	AV.	Q.P.	AV.	Q.P.	AV.
			1	0.16932	10.17	38.78	24.49	48.95	34.66	64.99
2	0.19013	10.19	34.77	19.60	44.96	29.79	64.03	54.03	-19.07	-24.24
3	0.21015	10.20	30.17	15.35	40.37	25.55	63.20	53.20	-22.83	-27.65
4	0.34486	10.22	26.15	20.91	36.37	31.13	59.09	49.09	-22.72	-17.96
5	0.37000	10.23	25.82	18.48	36.05	28.71	58.50	48.50	-22.45	-19.79
6	7.59000	10.55	26.61	20.23	37.16	30.78	60.00	50.00	-22.84	-19.22

Remarks:

1. Q.P. and AV. are abbreviations of quasi-peak and average individually.
2. The emission levels of other frequencies were very low against the limit.
3. Margin value = Emission level - Limit value
4. Correction factor = Insertion loss + Cable loss
5. Emission Level = Correction Factor + Reading Value.

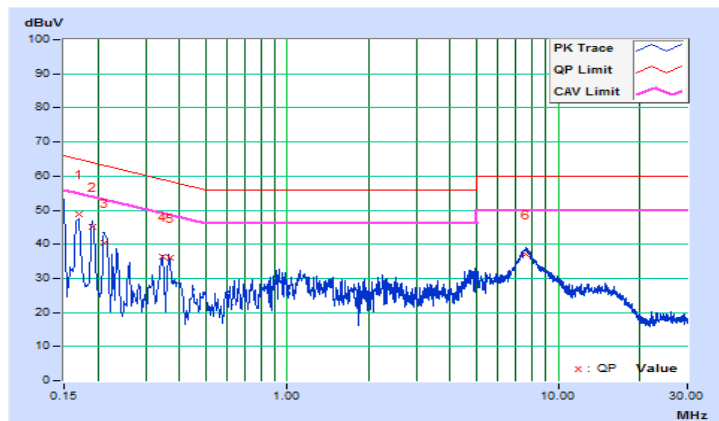

Phase	Line (L)	Detector Function	Quasi-Peak (QP) / Average (AV)
Test Mode	D		

No	Freq. [MHz]	Corr. Factor (dB)	Reading Value [dB (uV)]		Emission Level [dB (uV)]		Limit [dB (uV)]		Margin (dB)	
			Q.P.	AV.	Q.P.	AV.	Q.P.	AV.	Q.P.	AV.
			1	0.15400	10.41	37.68	25.10	48.09	35.51	65.78
2	0.16932	10.41	34.30	21.48	44.71	31.89	64.99	54.99	-20.28	-23.10
3	0.19013	10.43	31.63	19.72	42.06	30.15	64.03	54.03	-21.97	-23.88
4	0.22387	10.44	26.06	14.56	36.50	25.00	62.67	52.67	-26.17	-27.67
5	0.47434	10.50	35.00	30.39	45.50	40.89	56.44	46.44	-10.94	-5.55
6	0.95345	10.46	24.19	20.98	34.65	31.44	56.00	46.00	-21.35	-14.56

Remarks:

1. Q.P. and AV. are abbreviations of quasi-peak and average individually.
2. The emission levels of other frequencies were very low against the limit.
3. Margin value = Emission level - Limit value
4. Correction factor = Insertion loss + Cable loss
5. Emission Level = Correction Factor + Reading Value.

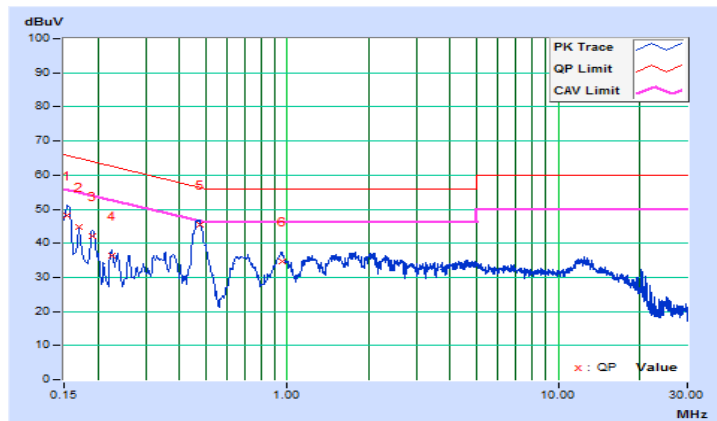

Phase	Neutral (N)	Detector Function	Quasi-Peak (QP) / Average (AV)
Test Mode	D		

No	Freq. [MHz]	Corr. Factor (dB)	Reading Value [dB (uV)]		Emission Level [dB (uV)]		Limit [dB (uV)]		Margin (dB)	
			Q.P.	AV.	Q.P.	AV.	Q.P.	AV.	Q.P.	AV.
			1	0.15687	10.16	35.85	23.26	46.01	33.42	65.63
2	0.17384	10.18	32.21	20.04	42.39	30.22	64.77	54.77	-22.38	-24.55
3	0.19265	10.19	28.60	16.53	38.79	26.72	63.92	53.92	-25.13	-27.20
4	0.34943	10.22	25.01	17.96	35.23	28.18	58.98	48.98	-23.75	-20.80
5	0.47185	10.23	38.02	33.67	48.25	43.90	56.48	46.48	-8.23	-2.58
6	0.94200	10.24	27.03	23.34	37.27	33.58	56.00	46.00	-18.73	-12.42

Remarks:

1. Q.P. and AV. are abbreviations of quasi-peak and average individually.
2. The emission levels of other frequencies were very low against the limit.
3. Margin value = Emission level - Limit value
4. Correction factor = Insertion loss + Cable loss
5. Emission Level = Correction Factor + Reading Value.

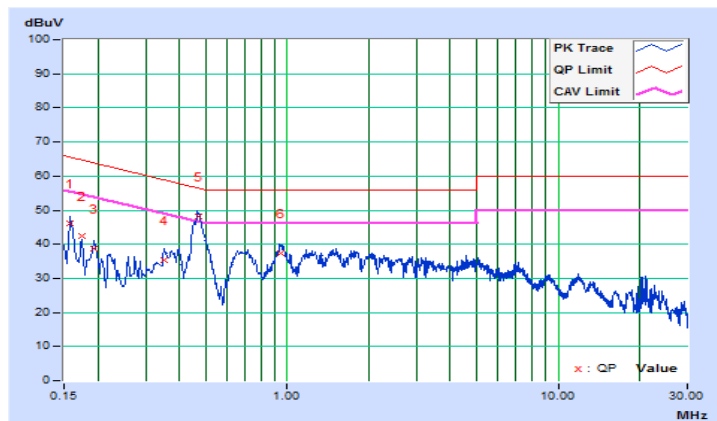

4.3 6dB Bandwidth Measurement

4.3.1 Limits of 6dB Bandwidth Measurement

The minimum of 6dB Bandwidth Measurement is 0.5 MHz.

4.3.2 Test Setup

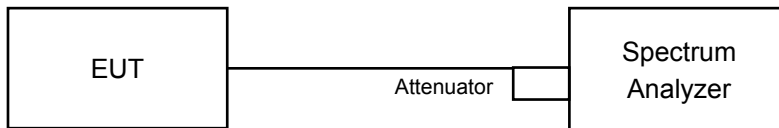

4.3.3 Test Instruments

Refer to section 4.1.2 to get information of above instrument.

4.3.4 Test Procedure

- Set resolution bandwidth (RBW) = 100kHz.
- Set the video bandwidth (VBW) $\geq 3 \times$ RBW, Detector = average.
- Trace mode = max hold.
- Sweep = auto couple.
- Measure the maximum width of the emission that is constrained by the frequencies associated with the two amplitude points (upper and lower) that are attenuated by 6 dB relative to the maximum level measured in the fundamental emission.

4.3.5 Deviation from Test Standard

No deviation.

4.3.6 EUT Operating Conditions

The software provided by client to enable the EUT under transmission condition continuously at lowest, middle and highest channel frequencies individually.

4.4 Conducted Output Power Measurement

4.4.1 Limits of Conducted Output Power Measurement

For systems using digital modulation in the 2400–2483.5 MHz bands: 1 Watt (30dBm)

4.4.2 Test Setup

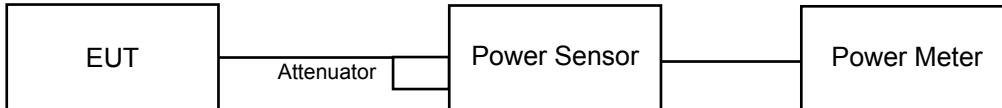

4.4.3 Test Instruments

Refer to section 4.1.2 to get information of above instrument.

4.4.4 Test Procedures

An average power sensor was used on the output port of the EUT. A power meter was used to read the response of the average power sensor. Record the power level.

4.4.5 Deviation from Test Standard

No deviation.

4.4.6 EUT Operating Conditions

Same as item 4.3.6.

4.4.7 Test Results

Channel	Frequency (MHz)	Average Power (mW)	Average Power (dBm)	Limit (dBm)	Pass / Fail
0	2402	1.259	1.00	28.00	Pass
19	2440	1.140	0.57	28.00	Pass
39	2480	1.175	0.70	28.00	Pass

Note: Gain = 8dBi > 6dBi, so the power limit shall be reduced to 30-(8-6) = 28.00dBm.

4.5 Power Spectral Density Measurement

4.5.1 Limits of Power Spectral Density Measurement

The Maximum of Power Spectral Density Measurement is 8dBm.

4.5.2 Test Setup

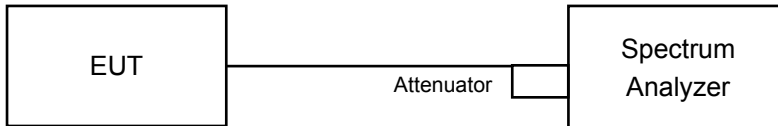

4.5.3 Test Instruments

Refer to section 4.1.2 to get information of above instrument.

4.5.4 Test Procedure

- a. Measure the duty cycle (x).
- b. Set instrument center frequency to DTS channel center frequency.
- c. Set span to at least 1.5 times the OBW.
- d. Set RBW to: $3 \text{ kHz} \leq \text{RBW} \leq 100 \text{ kHz}$.
- e. Set VBW $\geq 3 \times \text{RBW}$.
- f. Detector = power averaging (RMS) or sample detector (when RMS not available).
- g. Ensure that the number of measurement points in the sweep $\geq 2 \times \text{span}/\text{RBW}$.
- h. Sweep time = auto couple.
- i. Do not use sweep triggering. Allow sweep to "free run".
- j. Employ trace averaging (RMS) mode over a minimum of 100 traces.
- k. Use the peak marker function to determine the maximum amplitude level.
- l. Add $10 \log (1/x)$, where x is the duty cycle measured in step (a), to the measured PSD to compute the average PSD during the actual transmission time.

4.5.5 Deviation from Test Standard

No deviation.

4.5.6 EUT Operating Condition

Same as item 4.3.6

4.5.7 Test Results

Channel	Frequency (MHz)	PSD w/o Duty Factor (dBm/10kHz)	Duty Factor (dB)	Total PSD With Duty Factor (dBm/10kHz)	Limit (dBm/3kHz)	Pass / Fail
0	2402	-21.79	2.36	-19.43	6.00	Pass
19	2440	-22.51	2.36	-20.15	6.00	Pass
39	2480	-20.57	2.36	-18.21	6.00	Pass

Note:

- Gain = 8dBi > 6dBi, so the power density limit shall be reduced to $8 - (8 - 6) = 6.00$ dBm.
- Refer to section 3.3 for duty cycle spectrum plot.

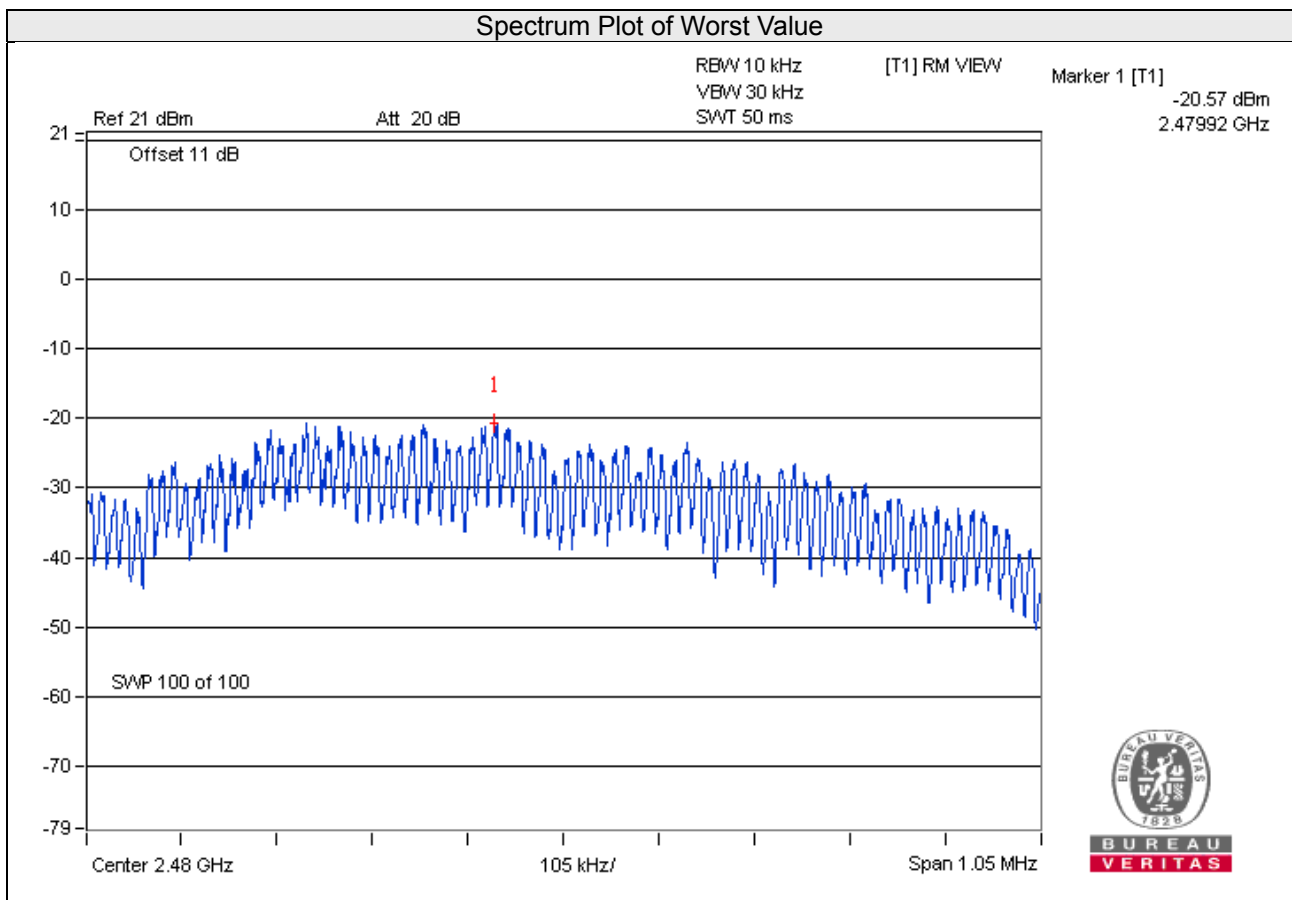

4.6 Conducted Out of Band Emission Measurement

4.6.1 Limits of Conducted Out of Band Emission Measurement

Below 30dB of the highest emission level of operating band (in 100kHz Resolution Bandwidth).

4.6.2 Test Setup

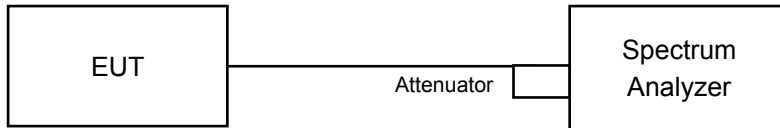

4.6.3 Test Instruments

Refer to section 4.1.2 to get information of above instrument.

4.6.4 Test Procedure

MEASUREMENT PROCEDURE REF

- Set the RBW = 100 kHz.
- Set the VBW \geq 300 kHz.
- Detector = average.
- Sweep time = auto couple.
- Trace mode = max hold.
- Allow trace to fully stabilize.
- Use the peak marker function to determine the maximum power level in any 100 kHz band segment within the fundamental EBW.

MEASUREMENT PROCEDURE OOBE

- Set RBW = 100 kHz.
- Set VBW \geq 300 kHz.
- Detector = average.
- Sweep = auto couple.
- Trace Mode = max hold.
- Allow trace to fully stabilize.
- Use the peak marker function to determine the maximum amplitude level.

4.6.5 Deviation from Test Standard

No deviation.

4.6.6 EUT Operating Condition

Same as item 4.3.6

4.6.7 Test Results

The conducted emission test is performed on each TX port of operating mode without summing or adding 10log (N) since the limit is relative emission limit.

The spectrum plots are attached on the following pages. D1 line indicates the highest level, and D2 line indicates the 30dB offset below D1. It shows compliance with the requirement.

CH 0

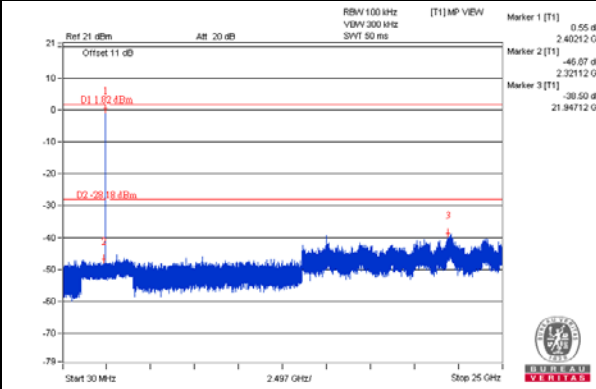
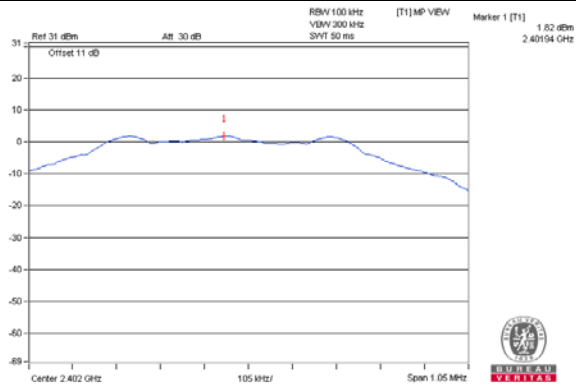

CH 19

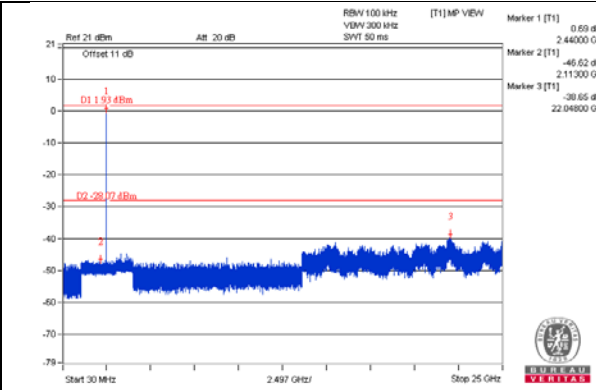
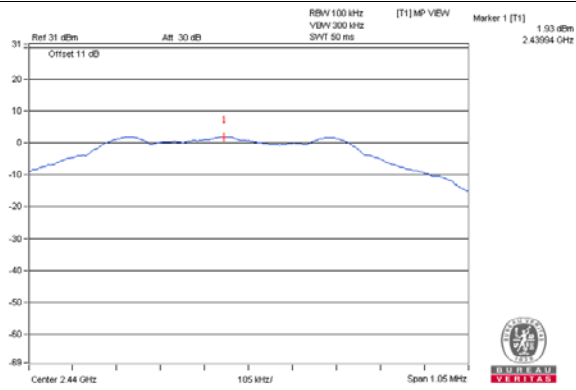

CH 39

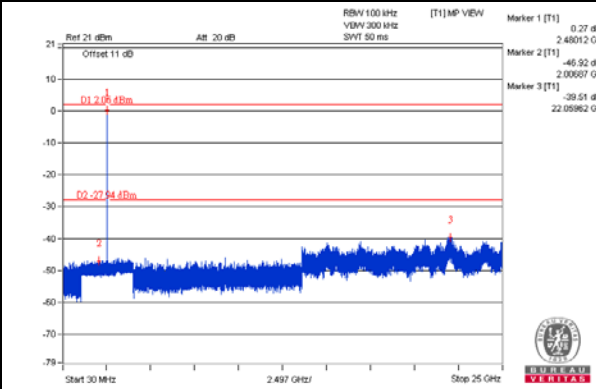
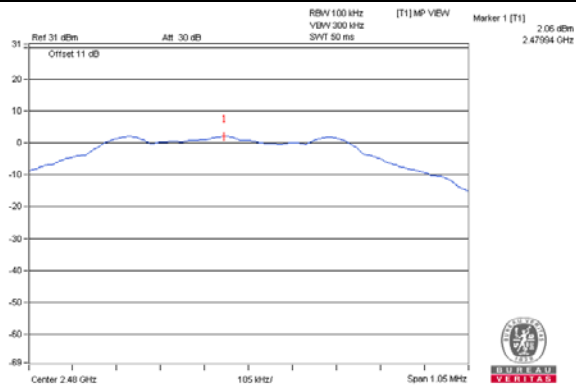

CH 0 Band edge

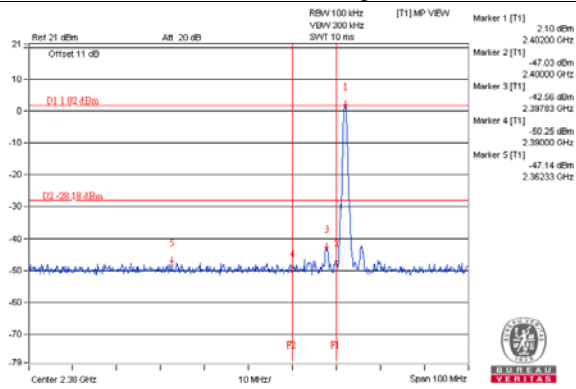

CH 39 Band edge

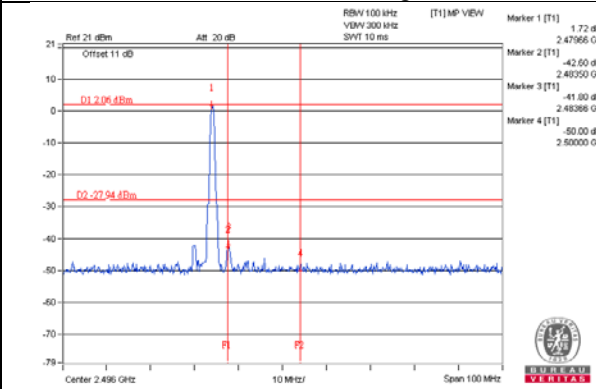

5 Pictures of Test Arrangements

Please refer to the attached file (Test Setup Photo).

Appendix – Information on the Testing Laboratories

We, Bureau Veritas Consumer Products Services (H.K.) Ltd., Taoyuan Branch, were founded in 1988 to provide our best service in EMC, Radio, Telecom and Safety consultation. Our laboratories are FCC recognized accredited test firms and accredited and approved according to ISO/IEC 17025.

If you have any comments, please feel free to contact us at the following:

Linko EMC/RF Lab

Tel: 886-2-26052180

Fax: 886-2-26051924

Hsin Chu EMC/RF/Telecom Lab

Tel: 886-3-6668565

Fax: 886-3-6668323

Hwa Ya EMC/RF/Safety Lab

Tel: 886-3-3183232

Fax: 886-3-3270892

Email: service.adt@tw.bureauveritas.com

Web Site: www.bureauveritas-adt.com

The address and road map of all our labs can be found in our web site also.

--- END ---