



A D T

FCC TEST REPORT (CO-LOCATED)

REPORT NO.: RF120720C10F-2
MODEL NO.: WS-AP3715i
FCC ID: QXO-AP3715I
RECEIVED: Jul. 16, 2012
TESTED: Aug. 27, 2012 ~ Jan. 21, 2013
ISSUED: Apr. 26, 2013

APPLICANT: Enterasys Networks, Inc.

ADDRESS: 9 Northeastern Blvd. Salem, NH 03079

ISSUED BY: Bureau Veritas Consumer Products Services
(H.K.) Ltd., Taoyuan Branch

LAB ADDRESS: No. 47, 14th Ling, Chia Pau Vil., Lin Kou Dist.,
New Taipei City, Taiwan, R.O.C.

TEST LOCATION: No. 19, Hwa Ya 2nd Rd, Wen Hwa Tsuen, Kwei
Shan Hsiang, Taoyuan Hsien 333, Taiwan, R.O.C.

This report should not be used by the client to claim product certification, approval, or endorsement by TAF or any government agencies.



This report is for your exclusive use. Any copying or replication of this report to or for any other person or entity, or use of our name or trademark, is permitted only with our prior written permission. This report sets forth our findings solely with respect to the test samples identified herein. The results set forth in this report are not indicative or representative of the quality or characteristics of the lot from which a test sample was taken or any similar or identical product unless specifically and expressly noted. Our report includes all of the tests requested by you and the results thereof based upon the information that you provided to us. You have 60 days from date of issuance of this report to notify us of any material error or omission caused by our negligence, provided, however, that such notice shall be in writing and shall specifically address the issue you wish to raise. A failure to raise such issue within the prescribed time shall constitute your unqualified acceptance of the completeness of this report, the tests conducted and the correctness of the report contents. Unless specific mention, the uncertainty of measurement has been explicitly taken into account to declare the compliance or non-compliance to the specification.



A D T

TABLE OF CONTENTS

RELEASE CONTROL RECORD.....	3
1. CERTIFICATION.....	4
2. SUMMARY OF TEST RESULTS.....	5
2.1 MEASUREMENT UNCERTAINTY.....	5
3. GENERAL INFORMATION.....	6
3.1 GENERAL DESCRIPTION OF EUT.....	6
3.2 DESCRIPTION OF TEST MODES.....	8
3.2.1 TEST MODE APPLICABILITY AND TESTED CHANNEL DETAIL.....	10
3.3 DESCRIPTION OF SUPPORT UNITS.....	12
3.3.1 CONFIGURATION OF SYSTEM UNDER TEST.....	12
3.4 GENERAL DESCRIPTION OF APPLIED STANDARDS.....	13
4. TEST TYPES AND RESULTS.....	14
4.1 RADIATED EMISSION AND BANDEDGE MEASUREMENT.....	14
4.1.1 LIMITS OF RADIATED EMISSION AND BANDEDGE MEASUREMENT.....	14
4.1.2 LIMITS OF UNWANTED EMISSION OUT OF THE RESTRICTED BANDS.....	14
4.1.3 TEST INSTRUMENTS.....	15
4.1.4 TEST PROCEDURES.....	16
4.1.5 DEVIATION FROM TEST STANDARD.....	16
4.1.6 TEST SETUP.....	17
4.1.7 EUT OPERATING CONDITIONS.....	17
4.1.8 TEST RESULTS.....	18
4.2 CONDUCTED EMISSION MEASUREMENT.....	24
4.2.1 LIMITS OF CONDUCTED EMISSION MEASUREMENT.....	24
4.2.2 TEST INSTRUMENTS.....	24
4.2.3 TEST PROCEDURES.....	25
4.2.4 DEVIATION FROM TEST STANDARD.....	25
4.2.5 TEST SETUP.....	26
4.2.6 EUT OPERATING CONDITIONS.....	26
4.2.7 TEST RESULTS.....	27
5. PHOTOGRAPHS OF THE TEST CONFIGURATION.....	31
6. INFORMATION ON THE TESTING LABORATORIES.....	32
7. APPENDIX A - MODIFICATIONS RECORDERS FOR ENGINEERING CHANGES TO THE EUT BY THE LAB.....	33



A D T

RELEASE CONTROL RECORD

ISSUE NO.	REASON FOR CHANGE	DATE ISSUED
RF120720C10F-2	Original release	Apr. 26, 2013



A D T

1. CERTIFICATION

PRODUCT: Wireless 802.11abgn Access Point
MODEL NO.: WS-AP3715i
BRAND: Enterasys
APPLICANT: Enterasys Networks, Inc.
TESTED: Aug. 27, 2012 ~ Jan. 21, 2013
TEST SAMPLE: ENGINEERING SAMPLE
STANDARDS: **FCC Part 15, Subpart C (Section 15.247)**
FCC Part 15, Subpart E (Section 15.407)
ANSI C63.10-2009

The above equipment (model: WS-AP3715i) has been tested by **Bureau Veritas Consumer Products Services (H.K.) Ltd., Taoyuan Branch**, and found compliance with the requirement of the above standards. The test record, data evaluation & Equipment Under Test (EUT) configurations represented herein are true and accurate accounts of the measurements of the sample's EMC characteristics under the conditions specified in this report.

PREPARED BY : Ivy Lin , **DATE** : Apr. 26, 2013
Ivy Lin / Specialist

APPROVED BY : Ken Liu , **DATE** : Apr. 26, 2013
Ken Liu / Senior Manager



A D T

2. SUMMARY OF TEST RESULTS

The EUT has been tested according to the following specifications:

APPLIED STANDARD: FCC PART 15, SUBPART C (SECTION 15.247) FCC PART 15, SUBPART E (SECTION 15.407)			
STANDARD SECTION	TEST TYPE AND LIMIT	RESULT	REMARK
15.207 15.407(b)(5)	AC Power Conducted Emission	PASS	Meet the requirement of limit. Minimum passing margin is -9.28dB at 0.51682MHz.
15.247(d) 15.407(b/1/2/3) (b)(5)	Radiated Emissions	PASS	Meet the requirement of limit. Minimum passing margin is -0.6dB at 5725.00MHz.

2.1 MEASUREMENT UNCERTAINTY

Where relevant, the following measurement uncertainty levels have been estimated for tests performed on the EUT as specified in CISPR 16-4-2:

MEASUREMENT	FREQUENCY	UNCERTAINTY
Conducted emissions	9kHz~30MHz	2.44 dB
Radiated emissions	30MHz ~ 200MHz	3.34 dB
	200MHz ~1000MHz	3.35 dB
	1GHz ~ 18GHz	2.26 dB
	18GHz ~ 40GHz	1.94 dB

This uncertainty represents an expanded uncertainty expressed at approximately the 95% confidence level using a coverage factor of $k = 2$.



3. GENERAL INFORMATION

3.1 GENERAL DESCRIPTION OF EUT

EUT	Wireless 802.11abgn Access Point
MODEL NO.	WS-AP3715i
POWER SUPPLY	5Vdc (host equipment)
MODULATION TYPE	CCK, DQPSK, DBPSK for DSSS 64QAM, 16QAM, QPSK, BPSK for OFDM
MODULATION TECHNOLOGY	DSSS, OFDM
TRANSFER RATE	802.11b: 11.0/ 5.5/ 2.0/ 1.0Mbps 802.11g: 54.0/ 48.0/ 36.0/ 24.0/ 18.0/ 12.0/ 9.0/ 6.0Mbps 802.11a: 54.0/ 48.0/ 36.0/ 24.0/ 18.0/ 12.0/ 9.0/ 6.0Mbps 802.11n: up to 450.0Mbps
OPERATING FREQUENCY	2.4GHz: 2412 ~ 2462MHz 5.0GHz: 5180 ~ 5240MHz, 5745 ~ 5825MHz
NUMBER OF CHANNEL	2.4GHz: 11 for 802.11b, 802.11g, 802.11n (20MHz) 7 for 802.11n (40MHz) 5.0GHz: 5180 ~ 5240MHz: 4 for 802.11a, 802.11n (20MHz) 2 for 802.11n (40MHz) 5745 ~ 5825MHz: 5 for 802.11a, 802.11n (20MHz) 2 for 802.11n (40MHz)
OUTPUT POWER	241.28mW for 2412 ~ 2462MHz 26.36mW for 5180 ~ 5240MHz 143.70mW for 5745 ~ 5825MHz
ANTENNA TYPE	Refer to Note as below
ANTENNA CONNECTOR	Refer to Note as below
DATA CABLE	N/A
I/O PORTS	N/A
ACCESSORY DEVICES	N/A



A D T

NOTE:

1. The EUT incorporates a MIMO function. Physically, the EUT provides three completed transmitters and three receivers.

MODULATION MODE	TX FUNCTION
802.11b	3TX
802.11g	3TX
802.11a	1TX/ 3TX
802.11n (20MHz)	3TX
802.11n (40MHz)	3TX

2. The following antenna type is provided to the EUT.

ANTENNA TYPE	ANTENNA CONNECTOR	ANTENNA GAIN (dBi)	
		2.4GHz BAND	5GHz BAND
PIFA	IPEX	5	6

3. The above EUT information is declared by manufacturer and for more detailed features description, please refer to the manufacturer's specifications or user's manual.

3.2 DESCRIPTION OF TEST MODES

FOR 2.4GHz:

11 channels are provided for 802.11b, 802.11g and 802.11n (20MHz):

CHANNEL	FREQUENCY	CHANNEL	FREQUENCY
1	2412MHz	7	2442MHz
2	2417MHz	8	2447MHz
3	2422MHz	9	2452MHz
4	2427MHz	10	2457MHz
5	2432MHz	11	2462MHz
6	2437MHz		

7 channels are provided for 802.11n (40MHz):

CHANNEL	FREQUENCY	CHANNEL	FREQUENCY
3	2422MHz	7	2442MHz
4	2427MHz	8	2447MHz
5	2432MHz	9	2452MHz
6	2437MHz		

FOR 5180 ~ 5240MHz

4 channels are provided for 802.11a, 802.11n (20MHz):

CHANNEL	FREQUENCY	CHANNEL	FREQUENCY
36	5180MHz	44	5220MHz
40	5200MHz	48	5240MHz

2 channels are provided for 802.11n (40MHz):

CHANNEL	FREQUENCY	CHANNEL	FREQUENCY
38	5190MHz	46	5230MHz



A D T

FOR 5745 ~ 5825MHz:

5 channels are provided for 802.11a, 802.11n (20MHz):

CHANNEL	FREQUENCY	CHANNEL	FREQUENCY
149	5745MHz	161	5805MHz
153	5765MHz	165	5825MHz
157	5785MHz		

2 channels are provided for 802.11n (40MHz):

CHANNEL	FREQUENCY	CHANNEL	FREQUENCY
151	5755MHz	159	5795MHz



A D T

3.2.1 TEST MODE APPLICABILITY AND TESTED CHANNEL DETAIL

EUT CONFIGURE MODE	APPLICABLE TO			DESCRIPTION
	RE \geq 1G	RE $<$ 1G	PLC	
-	√	√	√	-

Where RE \geq 1G: Radiated Emission above 1GHz

NOTE:

The EUT had been pre-tested on the positioned of each 3 axis. The worst case was found when positioned on **X-plane**.

RADIATED EMISSION TEST (ABOVE 1GHz):

- Pre-Scan has been conducted to determine the worst-case mode from all possible combinations between available modulations, data rates and antenna ports (if EUT with antenna diversity architecture).
- Following channel(s) was (were) selected for the final test as listed below.

EUT CONFIGURE MODE	MODE	FREQ. RANGE (MHz)	AVAILABLE CHANNEL	TESTED CHANNEL	MODULATION TECHNOLOGY	MODULATION TYPE	DATA RATE (Mbps)
-	802.11n (20MHz)	2412~2462	1 to 11	6 + 46	OFDM	BPSK	7.2
	+802.11an(40MHz)	5180~5240	36 to 48		OFDM	BPSK	15.0
-	802.11n (20MHz)	2412~2462	1 to 11	6 + 149	OFDM	BPSK	7.2
	+802.11an(20MHz)	5745~5825	149 to 165		OFDM	BPSK	15.0

RADIATED EMISSION TEST (BELOW 1GHz):

- Pre-Scan has been conducted to determine the worst-case mode from all possible combinations between available modulations, data rates and antenna ports (if EUT with antenna diversity architecture).
- Following channel(s) was (were) selected for the final test as listed below.

EUT CONFIGURE MODE	MODE	FREQ. RANGE (MHz)	AVAILABLE CHANNEL	TESTED CHANNEL	MODULATION TECHNOLOGY	MODULATION TYPE	DATA RATE (Mbps)
-	802.11n (20MHz)	2412~2462	1 to 11	6 + 46	OFDM	BPSK	7.2
	+802.11an(40MHz)	5180~5240	36 to 48		OFDM	BPSK	15.0
-	802.11n (20MHz)	2412~2462	1 to 11	6 + 149	OFDM	BPSK	7.2
	+802.11an(20MHz)	5745~5825	149 to 165		OFDM	BPSK	15.0



A D T

CONDUCTED EMISSION TEST:

- Pre-Scan has been conducted to determine the worst-case mode from all possible combinations between available modulations, data rates and antenna ports (if EUT with antenna diversity architecture).
- Following channel(s) was (were) selected for the final test as listed below.

EUT CONFIGURE MODE	MODE	FREQ. RANGE (MHz)	AVAILABLE CHANNEL	TESTED CHANNEL	MODULATION TECHNOLOGY	MODULATION TYPE	DATA RATE (Mbps)
-	802.11n (20MHz)	2412~2462	1 to 11	6 + 46	OFDM	BPSK	7.2
	+802.11an(40MHz)	5180~5240	36 to 48		OFDM	BPSK	15.0
-	802.11n (20MHz)	2412~2462	1 to 11	6 + 149	OFDM	BPSK	7.2
	+802.11an(20MHz)	5745~5825	149 to 165		OFDM	BPSK	15.0

TEST CONDITION:

APPLICABLE TO	ENVIRONMENTAL CONDITIONS	INPUT POWER (SYSTEM)	TESTED BY
RE \geq 1G	25deg. C, 65%RH	120Vac, 60Hz	Haru Yang
RE<1G	25deg. C, 65%RH	120Vac, 60Hz	Antony Lee
PLC	24deg. C, 64%RH	120Vac, 60Hz	Match Tsui

3.3 DESCRIPTION OF SUPPORT UNITS

The EUT has been tested as an independent unit together with other necessary accessories or support units. The following support units or accessories were used to form a representative test configuration during the tests.

NO.	PRODUCT	BRAND	MODEL NO.	SERIAL NO.	FCC ID
1	NOTEBOOK	DELL	E5420	33MLMQ1	NA
2	CONVERTIBLE BOARD	NA	NA	NA	NA

NO.	SIGNAL CABLE DESCRIPTION OF THE ABOVE SUPPORT UNITS
1	NA
2	NA

NOTE: All power cords of the above support units are non shielded (1.8m).

3.3.1 CONFIGURATION OF SYSTEM UNDER TEST

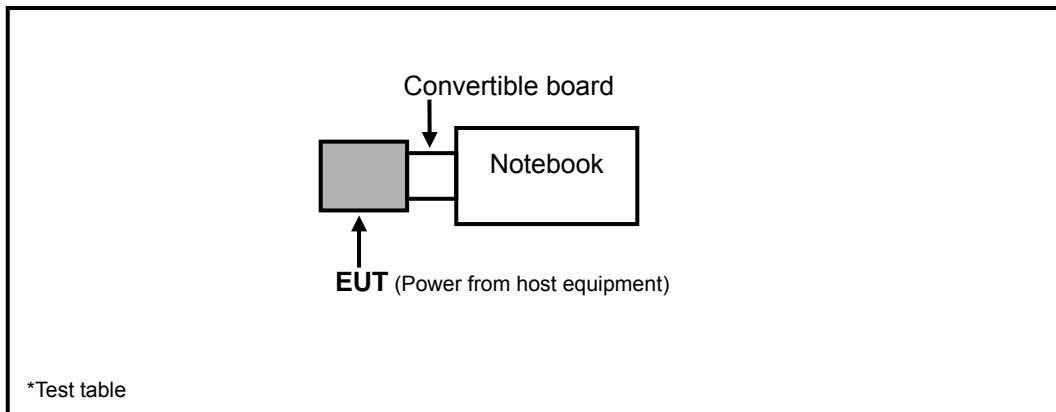



A D T

3.4 GENERAL DESCRIPTION OF APPLIED STANDARDS

The EUT is a RF Product. According to the specifications of the manufacturer, it must comply with the requirements of the following standards:

FCC Part 15, Subpart C (Section 15.247)

FCC Part 15, Subpart E (Section 15.407)

ANSI C63.10-2009

All test items have been performed and recorded as per the above standards.



A D T

4. TEST TYPES AND RESULTS

4.1 RADIATED EMISSION AND BANDEDGE MEASUREMENT

4.1.1 LIMITS OF RADIATED EMISSION AND BANDEDGE MEASUREMENT

Radiated emissions which fall in the restricted bands must comply with the radiated emission limits specified as below table. Other emissions shall be at least 30dB below the highest level of the desired power:

FREQUENCIES (MHz)	FIELD STRENGTH (microvolts/meter)	MEASUREMENT DISTANCE (meters)
0.009 ~ 0.490	2400/F(kHz)	300
0.490 ~ 1.705	24000/F(kHz)	30
1.705 ~ 30.0	30	30
30 ~ 88	100	3
88 ~ 216	150	3
216 ~ 960	200	3
Above 960	500	3

NOTE:

1. The lower limit shall apply at the transition frequencies.
2. Emission level (dBuV/m) = 20 log Emission level (uV/m).
3. For frequencies above 1000MHz, the field strength limits are based on average detector, however, the peak field strength of any emission shall not exceed the maximum permitted average limits, specified above by more than 20dB under any condition of modulation.

4.1.2 LIMITS OF UNWANTED EMISSION OUT OF THE RESTRICTED BANDS

FREQUENCIES (MHz)	EIRP LIMIT (dBm)	EQUIVALENT FIELD STRENGTH AT 3m (dBµV/m) *NOTE 3
	PK	PK
5150 ~ 5250	-27	68.3
5250 ~ 5350	-27	68.3
5470 ~ 5725	-27	68.3

NOTE:

The following formula is used to convert the equipment isotropic radiated power (eirp) to field strength:

$$E = \frac{1000000\sqrt{30P}}{3} \mu\text{V/m, where P is the eirp (Watts).}$$



A D T

4.1.3 TEST INSTRUMENTS

Test Date: Aug. 27 ~ Sep. 20, 2012

DESCRIPTION & MANUFACTURER	MODEL NO.	SERIAL NO.	DATE OF CALIBRATION	DUE DATE OF CALIBRATION
Test Receiver ROHDE & SCHWARZ	ESIB7	100212	Aug. 06, 2012	Aug. 05, 2013
Spectrum Analyzer ROHDE & SCHWARZ	FSP40	100039	Feb. 03, 2012	Feb. 02, 2013
BILOG Antenna SCHWARZBECK	VULB9168	9168-160	Apr. 06, 2012	Apr. 05, 2013
HORN Antenna SCHWARZBECK	BBHA 9120D	9120D-408	Jan. 05, 2012	Jan. 04, 2013
HORN Antenna SCHWARZBECK	BBHA 9170	148	Jul. 11, 2012	Jul. 10, 2013
Preamplifier Agilent	8447D	2944A10633	Oct. 29, 2011	Oct. 28, 2012
Preamplifier Agilent	8449B	3008A01964	Oct. 29, 2011	Oct. 28, 2012
RF signal cable HUBER+SUHNNER	SUCOFLEX 104	250723/4	Aug. 28, 2012	Aug. 27, 2013
RF signal cable HUBER+SUHNNER	SUCOFLEX 104	295012/4	Nov. 03, 2011	Nov. 02, 2012
Software ADT.	ADT_Radiated_ V7.6.15.9.2	NA	NA	NA
Antenna Tower inn-co GmbH	MA 4000	013303	NA	NA
Antenna Tower Controller inn-co GmbH	CO2000	017303	NA	NA
Turn Table ADT.	TT100	TT93021703	NA	NA
Turn Table Controller ADT.	SC100	SC93021703	NA	NA
26GHz ~ 40GHz Amplifier	EM26400	815221	Oct. 29, 2011	Oct. 28, 2012

- NOTE:**
1. The calibration interval of the above test instruments is 12 months and the calibrations are traceable to NML/ROC and NIST/USA.
 2. The test was performed in HwaYa Chamber 3.
 3. The horn antenna and HP preamplifier (model: 8449B) are used only for the measurement of emission frequency above 1GHz if tested.
 4. The FCC Site Registration No. is 988962.
 5. The IC Site Registration No. is IC 7450F-3.



A D T

4.1.4 TEST PROCEDURES

- a. The EUT was placed on the top of a rotating table 0.8 meters above the ground at a 3 meters semi-anechoic chamber. The table was rotated 360 degrees to determine the position of the highest radiation.
- b. The EUT was set 3 meters away from the interference-receiving antenna, which was mounted on the top of a variable-height antenna tower.
- c. The antenna is a broadband antenna, and its height is varied from one meter to four meters above the ground to determine the maximum value of the field strength. Both horizontal and vertical polarizations of the antenna are set to make the measurement.
- d. For each suspected emission, the EUT was arranged to its worst case and then the antenna was tuned to heights from 1 meter to 4 meters and the rotatable table was turned from 0 degrees to 360 degrees to find the maximum reading.
- e. The test-receiver system was set to Peak Detect Function and Specified Bandwidth with Maximum Hold Mode.
- f. If the emission level of the EUT in peak mode was lower than the limit specified, then testing could be stopped and the peak values of the EUT would be reported. Otherwise the emissions would be re-tested one by one using peak, quasi-peak or average method as specified and then reported in a data sheet.

NOTE:

1. The resolution bandwidth and video bandwidth of test receiver/spectrum analyzer is 120kHz for Quasi-peak detection at frequency below 1GHz.
2. The resolution bandwidth of test receiver/spectrum analyzer is 100kHz and video bandwidth is 300kHz for Peak detection at frequency above 1GHz.
3. The resolution bandwidth of test receiver/spectrum analyzer is 1MHz and the video bandwidth is 1kHz for Average detection (AV) at frequency above 1GHz.
4. All modes of operation were investigated and the worst-case emissions are reported.

4.1.5 DEVIATION FROM TEST STANDARD

No deviation.

4.1.6 TEST SETUP

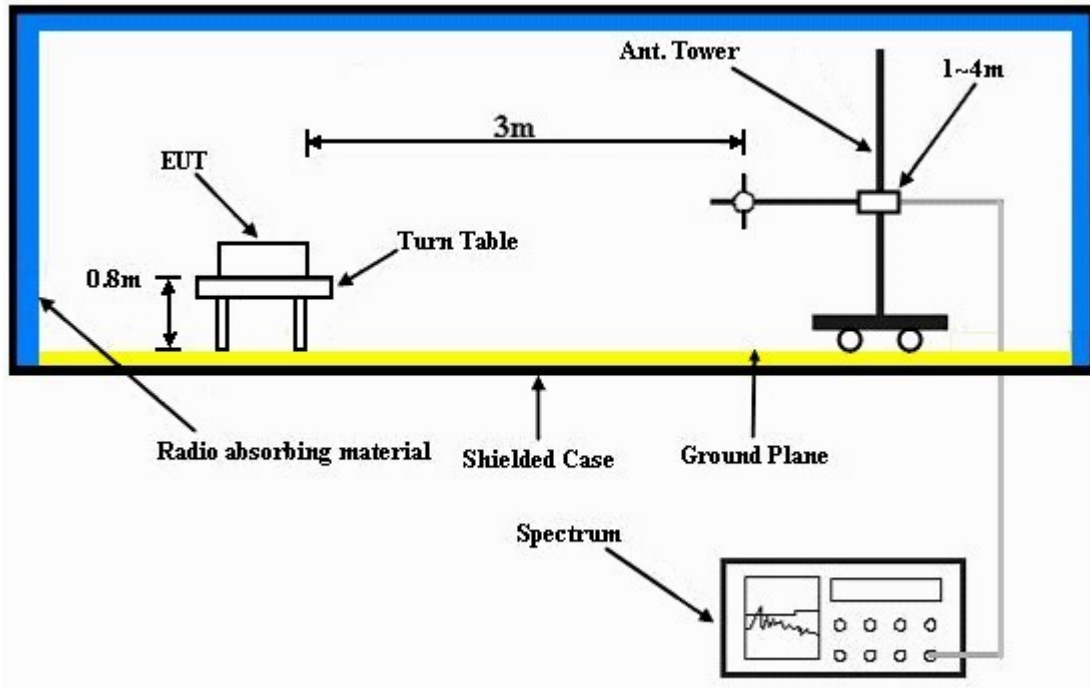

For the actual test configuration, please refer to the attached file (Test Setup Photo).

4.1.7 EUT OPERATING CONDITIONS

- Plugged the EUT into notebook via external board and placed them on the testing table.
- The notebook system ran a test program (provided by manufacturer) to enable EUT under transmission condition continuously at specific channel frequency.
- The necessary accessories enable the system in full functions.



A D T

4.1.8 TEST RESULTS

Above 1GHz data

802.11n (20MHz) + 802.11an (40MHz)

EUT TEST CONDITION		MEASUREMENT DETAIL	
CHANNEL	CH 6 + CH 46	FREQUENCY RANGE	1 ~ 25GHz
INPUT POWER (SYSTEM)	120Vac, 60Hz	DETECTOR FUNCTION	Peak (PK) Average (AV)
ENVIRONMENTAL CONDITIONS	25deg. C, 65%RH	TESTED BY	Haru Yang

ANTENNA POLARITY & TEST DISTANCE: HORIZONTAL AT 3 M								
NO.	FREQ. (MHz)	EMISSION LEVEL (dBuV/m)	LIMIT (dBuV/m)	MARGIN (dB)	ANTENNA HEIGHT (m)	TABLE ANGLE (Degree)	RAW VALUE (dBuV)	CORRECTION FACTOR (dB/m)
1	*2437.00	113.7 PK			1.01 H	351	82.30	31.40
2	*2437.00	104.2 AV			1.01 H	351	72.80	31.40
3	2500.00	61.1 PK	74.0	-12.9	1.38 H	2	29.50	31.60
4	2500.00	49.5 AV	54.0	-4.5	1.38 H	2	17.90	31.60
5	4874.00	55.1 PK	74.0	-18.9	1.15 H	21	17.80	37.30
6	4874.00	43.6 AV	54.0	-10.4	1.15 H	21	6.30	37.30
7	5000.00	56.6 PK	74.0	-17.4	1.43 H	288	19.00	37.60
8	5000.00	45.1 AV	54.0	-8.9	1.43 H	288	7.50	37.60
9	5150.00	56.1 PK	74.0	-17.9	1.00 H	323	18.20	37.90
10	5150.00	44.0 AV	54.0	-10.0	1.00 H	323	6.10	37.90
11	*5230.00	95.8 PK			1.00 H	323	57.80	38.00
12	*5230.00	86.9 AV			1.00 H	323	48.90	38.00
13	5360.00	56.1 PK	74.0	-17.9	1.00 H	178	17.90	38.20
14	5360.00	46.8 AV	54.0	-7.2	1.00 H	178	8.60	38.20
15	#10460.00	56.9 PK	68.3	-11.4	1.00 H	27	8.00	48.90

- REMARKS:**
1. Emission level (dBuV/m) = Raw Value (dBuV) + Correction Factor (dB/m).
 2. Correction Factor (dB/m) = Antenna Factor (dB/m) + Cable Factor (dB).
 3. The other emission levels were very low against the limit.
 4. Margin value = Emission level – Limit value.
 5. “ * “: Fundamental frequency.
 6. The limit value is defined as per 15.247.
 7. “#”:The radiated frequency is out the restricted band.



A D T

EUT TEST CONDITION		MEASUREMENT DETAIL	
CHANNEL	CH 6 + CH 46	FREQUENCY RANGE	1 ~ 25GHz
INPUT POWER (SYSTEM)	120Vac, 60Hz	DETECTOR FUNCTION	Peak (PK) Average (AV)
ENVIRONMENTAL CONDITIONS	25deg. C, 65%RH hPa	TESTED BY	Haru Yang

ANTENNA POLARITY & TEST DISTANCE: VERTICAL AT 3 M								
NO.	FREQ. (MHz)	EMISSION LEVEL (dBuV/m)	LIMIT (dBuV/m)	MARGIN (dB)	ANTENNA HEIGHT (m)	TABLE ANGLE (Degree)	RAW VALUE (dBuV)	CORRECTION FACTOR (dB/m)
1	*2437.00	112.3 PK			1.16 V	349	80.90	31.40
2	*2437.00	102.1 AV			1.16 V	349	70.70	31.40
3	2500.00	61.3 PK	74.0	-12.7	1.16 V	329	29.70	31.60
4	2500.00	53.0 AV	54.0	-1.0	1.16 V	329	21.40	31.60
5	4874.00	55.5 PK	74.0	-18.5	1.12 V	256	18.20	37.30
6	4874.00	42.6 AV	54.0	-11.4	1.12 V	256	5.30	37.30
7	5000.00	56.0 PK	74.0	-18.0	1.08 V	322	18.40	37.60
8	5000.00	45.1 AV	54.0	-8.9	1.08 V	322	7.50	37.60
9	5150.00	56.6 PK	74.0	-17.4	1.04 V	325	18.70	37.90
10	5150.00	43.9 AV	54.0	-10.1	1.04 V	325	6.00	37.90
11	*5230.00	97.5 PK			1.04 V	325	59.50	38.00
12	*5230.00	88.6 AV			1.04 V	325	50.60	38.00
13	5360.00	55.7 PK	74.0	-18.3	1.00 V	15	17.50	38.20
14	5360.00	45.0 AV	54.0	-9.0	1.00 V	15	6.80	38.20
15	#10460.00	57.4 PK	68.3	-10.9	1.00 V	355	8.50	

- REMARKS:**
1. Emission level (dBuV/m) = Raw Value (dBuV) + Correction Factor (dB/m).
 2. Correction Factor (dB/m) = Antenna Factor (dB/m) + Cable Factor (dB).
 3. The other emission levels were very low against the limit.
 4. Margin value = Emission level – Limit value.
 5. “ * “: Fundamental frequency.
 6. The limit value is defined as per 15.247.
 7. “#”:The radiated frequency is out the restricted band.



A D T

802.11n (20MHz) + 802.11an (20MHz)

EUT TEST CONDITION		MEASUREMENT DETAIL	
CHANNEL	CH 6 + CH 149	FREQUENCY RANGE	1 ~ 25GHz
INPUT POWER (SYSTEM)	120Vac, 60Hz	DETECTOR FUNCTION	Peak (PK) Average (AV)
ENVIRONMENTAL CONDITIONS	25deg. C, 65%RH	TESTED BY	Haru Yang

ANTENNA POLARITY & TEST DISTANCE: HORIZONTAL AT 3 M								
NO.	FREQ. (MHz)	EMISSION LEVEL (dBuV/m)	LIMIT (dBuV/m)	MARGIN (dB)	ANTENNA HEIGHT (m)	TABLE ANGLE (Degree)	RAW VALUE (dBuV)	CORRECTION FACTOR (dB/m)
1	*2437.00	117.4 PK			1.02 H	355	86.00	31.40
2	*2437.00	107.7 AV			1.02 H	355	76.30	31.40
3	2500.00	60.6 PK	74.0	-13.4	1.38 H	3	29.00	31.60
4	2500.00	50.3 AV	54.0	-3.7	1.38 H	3	18.70	31.60
5	4874.00	56.0 PK	74.0	-18.0	1.14 H	6	18.70	37.30
6	4874.00	43.2 AV	54.0	-10.8	1.14 H	6	5.90	37.30
7	5000.00	58.8 PK	74.0	-15.2	1.43 H	286	21.20	37.60
8	5000.00	48.6 AV	54.0	-5.4	1.43 H	286	11.00	37.60
9	5360.00	56.9 PK	74.0	-17.1	1.00 H	164	18.70	38.20
10	5360.00	47.3 AV	54.0	-6.7	1.00 H	164	9.10	38.20
11	#5725.00	81.2 PK	83.6	-2.4	1.18 H	49	42.20	39.00
12	#5725.00	68.3 AV	70.7	-2.4	1.18 H	49	29.30	39.00
13	*5745.00	113.6 PK			1.21 H	328	74.60	39.00
14	*5745.00	100.7 AV			1.21 H	328	61.70	39.00
15	11490.00	59.2 PK	74.0	-14.8	1.00 H	10	8.90	50.30
16	11490.00	47.4 AV	54.0	-6.6	1.00 H	10	-2.90	50.30

- REMARKS:**
1. Emission level (dBuV/m) = Raw Value (dBuV) + Correction Factor (dB/m).
 2. Correction Factor (dB/m) = Antenna Factor (dB/m) + Cable Factor (dB).
 3. The other emission levels were very low against the limit.
 4. Margin value = Emission level – Limit value.
 5. “ * “: Fundamental frequency.
 6. The limit value is defined as per 15.247.
 7. "#":The radiated frequency is out the restricted band.



A D T

EUT TEST CONDITION		MEASUREMENT DETAIL	
CHANNEL	CH 6 + CH 149	FREQUENCY RANGE	1 ~ 25GHz
INPUT POWER (SYSTEM)	120Vac, 60Hz	DETECTOR FUNCTION	Peak (PK) Average (AV)
ENVIRONMENTAL CONDITIONS	25deg. C, 65%RH	TESTED BY	Haru Yang

ANTENNA POLARITY & TEST DISTANCE: VERTICAL AT 3 M								
NO.	FREQ. (MHz)	EMISSION LEVEL (dBuV/m)	LIMIT (dBuV/m)	MARGIN (dB)	ANTENNA HEIGHT (m)	TABLE ANGLE (Degree)	RAW VALUE (dBuV)	CORRECTION FACTOR (dB/m)
1	*2437.00	111.4 PK			1.17 V	345	80.00	31.40
2	*2437.00	101.8 AV			1.17 V	345	70.40	31.40
3	2500.00	62.0 PK	74.0	-12.0	1.19 V	349	30.40	31.60
4	2500.00	52.9 AV	54.0	-1.1	1.19 V	349	21.30	31.60
5	4874.00	55.9 PK	74.0	-18.1	1.11 V	243	18.60	37.30
6	4874.00	42.9 AV	54.0	-11.1	1.11 V	243	5.60	37.30
7	5000.00	59.6 PK	74.0	-14.4	1.20 V	5	22.00	37.60
8	5000.00	50.4 AV	54.0	-3.6	1.20 V	5	12.80	37.60
9	5360.00	58.0 PK	74.0	-16.0	1.00 V	11	19.80	38.20
10	5360.00	46.3 AV	54.0	-7.7	1.00 V	11	8.10	38.20
11	#5725.00	82.6 PK	83.2	-0.6	1.03 V	338	43.60	39.00
12	#5725.00	70.5 AV	71.1	-0.6	1.03 V	338	31.50	39.00
13	*5745.00	113.2 PK			1.03 V	327	74.20	39.00
14	*5745.00	101.1 AV			1.03 V	327	62.10	39.00
15	11490.00	59.4 PK	74.0	-14.6	1.00 V	351	9.10	50.30
16	11490.00	47.1 AV	54.0	-6.9	1.00 V	351	-3.20	50.30

- REMARKS:**
1. Emission level (dBuV/m) = Raw Value (dBuV) + Correction Factor (dB/m).
 2. Correction Factor (dB/m) = Antenna Factor (dB/m) + Cable Factor (dB).
 3. The other emission levels were very low against the limit.
 4. Margin value = Emission level – Limit value.
 5. “ * “: Fundamental frequency.
 6. The limit value is defined as per 15.247.
 7. "#": The radiated frequency is out the restricted band.



A D T

802.11n (20MHz) + 802.11an (40MHz)

EUT TEST CONDITION		MEASUREMENT DETAIL	
CHANNEL	CH 6 + CH 46	FREQUENCY RANGE	Below 1000MHz
INPUT POWER (SYSTEM)	120Vac, 60Hz	DETECTOR FUNCTION	Quasi-Peak
ENVIRONMENTAL CONDITIONS	25deg. C, 65%RH	TESTED BY	Antony Lee

ANTENNA POLARITY & TEST DISTANCE: HORIZONTAL AT 3 M								
NO.	FREQ. (MHz)	EMISSION LEVEL (dBuV/m)	LIMIT (dBuV/m)	MARGIN (dB)	ANTENNA HEIGHT (m)	TABLE ANGLE (Degree)	RAW VALUE (dBuV)	CORRECTION FACTOR (dB/m)
1	159.87	38.1 QP	43.5	-5.4	1.51 H	23	24.00	14.10
2	200.02	35.8 QP	43.5	-7.7	1.00 H	255	24.80	11.00
3	302.51	43.1 QP	46.0	-2.9	1.25 H	37	28.10	15.00
4	666.58	35.9 QP	46.0	-10.1	1.00 H	74	13.20	22.70
5	700.51	40.2 QP	46.0	-5.8	1.00 H	199	17.20	23.00
6	898.02	41.2 QP	46.0	-4.8	1.47 H	58	14.40	26.80
ANTENNA POLARITY & TEST DISTANCE: VERTICAL AT 3 M								
NO.	FREQ. (MHz)	EMISSION LEVEL (dBuV/m)	LIMIT (dBuV/m)	MARGIN (dB)	ANTENNA HEIGHT (m)	TABLE ANGLE (Degree)	RAW VALUE (dBuV)	CORRECTION FACTOR (dB/m)
1	100.08	33.6 QP	43.5	-9.9	1.75 V	69	24.20	9.40
2	157.03	30.2 QP	43.5	-13.3	1.25 V	157	16.10	14.10
3	320.25	38.4 QP	46.0	-7.6	1.50 V	117	22.90	15.50
4	336.02	32.4 QP	46.0	-13.6	1.50 V	17	16.50	15.90
5	700.01	37.6 QP	46.0	-8.4	1.25 V	302	14.60	23.00
6	899.25	37.4 QP	46.0	-8.6	1.50 V	59	10.60	26.80

REMARKS:

1. Emission level (dBuV/m) = Raw Value (dBuV) + Correction Factor (dB/m).
2. Correction Factor (dB/m) = Antenna Factor (dB/m) + Cable Factor (dB).
3. The other emission levels were very low against the limit.
4. Margin value = Emission level – Limit value.



A D T

802.11n (20MHz) + 802.11an (20MHz)

EUT TEST CONDITION		MEASUREMENT DETAIL	
CHANNEL	CH 6 + CH 149	FREQUENCY RANGE	Below 1000MHz
INPUT POWER (SYSTEM)	120Vac, 60Hz	DETECTOR FUNCTION	Quasi-Peak
ENVIRONMENTAL CONDITIONS	25deg. C, 65%RH	TESTED BY	Antony Lee

ANTENNA POLARITY & TEST DISTANCE: HORIZONTAL AT 3 M								
NO.	FREQ. (MHz)	EMISSION LEVEL (dBuV/m)	LIMIT (dBuV/m)	MARGIN (dB)	ANTENNA HEIGHT (m)	TABLE ANGLE (Degree)	RAW VALUE (dBuV)	CORRECTION FACTOR (dB/m)
1	163.05	37.6 QP	43.5	-5.9	1.50 H	26	23.70	13.90
2	200.36	34.8 QP	43.5	-8.7	1.00 H	336	23.80	11.00
3	302.52	42.6 QP	46.0	-3.4	1.25 H	36	27.60	15.00
4	666.02	35.8 QP	46.0	-10.2	1.50 H	159	13.10	22.70
5	701.85	40.6 QP	46.0	-5.4	1.75 H	198	17.60	23.00
6	899.02	41.6 QP	46.0	-4.4	1.51 H	82	14.80	26.80

ANTENNA POLARITY & TEST DISTANCE: VERTICAL AT 3 M								
NO.	FREQ. (MHz)	EMISSION LEVEL (dBuV/m)	LIMIT (dBuV/m)	MARGIN (dB)	ANTENNA HEIGHT (m)	TABLE ANGLE (Degree)	RAW VALUE (dBuV)	CORRECTION FACTOR (dB/m)
1	102.35	33.8 QP	43.5	-9.7	1.00 V	59	24.10	9.70
2	168.03	30.6 QP	43.5	-12.9	1.00 V	157	17.00	13.60
3	299.63	38.4 QP	46.0	-7.6	1.50 V	204	23.50	14.90
4	343.02	30.6 QP	46.0	-15.4	1.50 V	36	14.50	16.10
5	700.02	37.5 QP	46.0	-8.5	1.00 V	258	14.50	23.00
6	900.02	37.5 QP	46.0	-8.5	1.50 V	215	10.70	26.80

REMARKS:

1. Emission level (dBuV/m) = Raw Value (dBuV) + Correction Factor (dB/m).
2. Correction Factor (dB/m) = Antenna Factor (dB/m) + Cable Factor (dB).
3. The other emission levels were very low against the limit.
4. Margin value = Emission level – Limit value.



ADT

4.2 CONDUCTED EMISSION MEASUREMENT

4.2.1 LIMITS OF CONDUCTED EMISSION MEASUREMENT

FREQUENCY OF EMISSION (MHz)	CONDUCTED LIMIT (dB μ V)	
	Quasi-peak	Average
0.15-0.5	66 to 56	56 to 46
0.5-5	56	46
5-30	60	50

- NOTE:**
1. The lower limit shall apply at the transition frequencies.
 2. The limit decreases in line with the logarithm of the frequency in the range of 0.15 to 0.50 MHz.
 3. All emanations from a class A/B digital device or system, including any network of conductors and apparatus connected thereto, shall not exceed the level of field strengths specified above.

4.2.2 TEST INSTRUMENTS

Test Date: Jan. 19 ~ Jan. 21, 2013

DESCRIPTION & MANUFACTURER	MODEL NO.	SERIAL NO.	DATE OF CALIBRATION	DUE DATE OF CALIBRATION
Test Receiver ROHDE & SCHWARZ	ESCS30	100288	Nov. 09, 2012	Nov. 08, 2013
RF signal cable Woken	5D-FB	Cable-HYCO2-01	Dec. 28, 2012	Dec. 27, 2013
LISN ROHDE & SCHWARZ (EUT)	ESH2-Z5	100100	Dec. 21, 2012	Dec. 20, 2013
LISN ROHDE & SCHWARZ (Peripheral)	ESH3-Z5	100311	Jul. 06, 2012	Jul. 05, 2013
Software ADT	BV ADT_Cond_ V7.3.7.3	NA	NA	NA

- NOTE:**
1. The calibration interval of the above test instruments is 12 months and the calibrations are traceable to NML/ROC and NIST/USA.
 2. The test was performed in HwaYa Shielded Room 2.
 3. The VCCI Site Registration No. is C-2047.



A D T

4.2.3 TEST PROCEDURES

- a. The EUT was placed 0.4 meters from the conducting wall of the shielded room with EUT being connected to the power mains through a line impedance stabilization network (LISN). Other support units were connected to the power mains through another LISN. The two LISNs provide 50 ohm/ 50uH of coupling impedance for the measuring instrument.
- b. Both lines of the power mains connected to the EUT were checked for maximum conducted interference.
- c. The frequency range from 150kHz to 30MHz was searched. Emission levels under (Limit - 20dB) was not recorded.

NOTE: All modes of operation were investigated and the worst-case emissions are reported.

4.2.4 DEVIATION FROM TEST STANDARD

No deviation.

4.2.5 TEST SETUP

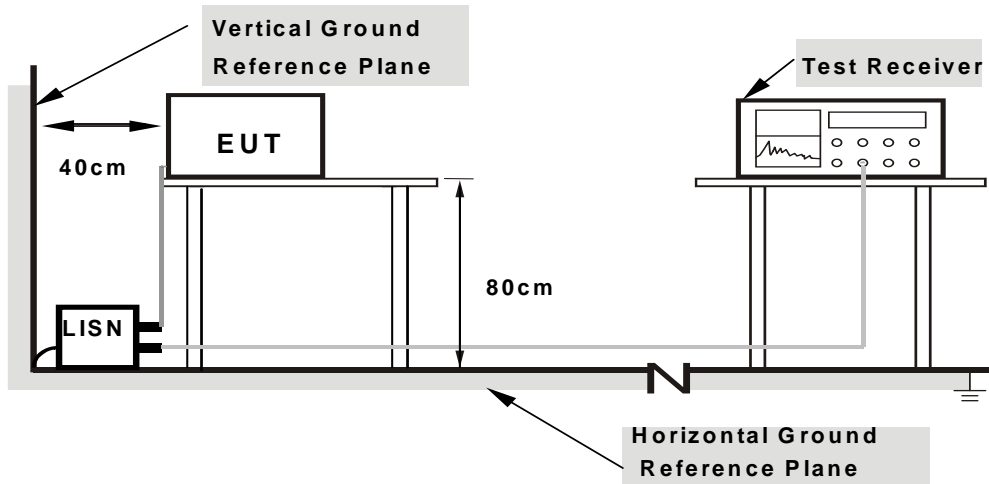

- Note:**
1. Support units were connected to second LISN.
 2. Both of LISNs (AMN) are 80 cm from EUT and at least 80 from other units and other metal planes

For the actual test configuration, please refer to the attached file (Test Setup Photo).

4.2.6 EUT OPERATING CONDITIONS

Same as 4.1.6.



A D T

4.2.7 TEST RESULTS

For 2.4GHz band + 5GHz Band 1

CONDUCTED WORST-CASE DATA: 802.11n (20MHz) + 802.11an (40MHz)

CHANNEL	CH 6 + CH 46	6dB BANDWIDTH	9kHz
PHASE	Line 1		

No	Freq. [MHz]	Corr. Factor (dB)	Reading Value [dB (uV)]		Emission Level [dB (uV)]		Limit [dB (uV)]		Margin (dB)	
			Q.P.	AV.	Q.P.	AV.	Q.P.	AV.	Q.P.	AV.
			1	0.16247	0.17	33.57	16.27	33.74	16.44	65.34
2	0.51428	0.22	36.14	31.07	36.36	31.29	56.00	46.00	-19.64	-14.71
3	0.64624	0.23	28.11	19.24	28.34	19.47	56.00	46.00	-27.66	-26.53
4	1.55558	0.28	25.07	23.11	25.35	23.39	56.00	46.00	-30.65	-22.61
5	11.42593	0.47	22.00	14.09	22.47	14.56	60.00	50.00	-37.53	-35.44
6	20.39571	0.68	43.07	37.57	43.75	38.25	60.00	50.00	-16.25	-11.75

REMARKS:

1. Q.P. and AV. are abbreviations of quasi-peak and average individually.
2. The emission levels of other frequencies were very low against the limit.
3. Margin value = Emission level - Limit value
4. Correction factor = Insertion loss + Cable loss
5. Emission Level = Correction Factor + Reading Value.

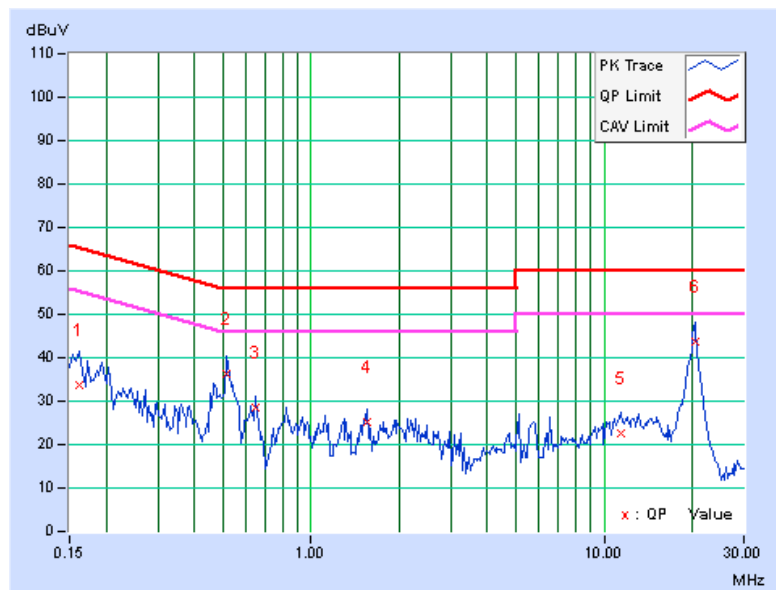

CHANNEL	CH 6 + CH 46	6dB BANDWIDTH	9kHz
PHASE	Line 2		

No	Freq.	Corr. Factor	Reading Value		Emission Level		Limit		Margin	
	[MHz]		[dB (uV)]		[dB (uV)]		[dB (uV)]		(dB)	
			Q.P.	AV.	Q.P.	AV.	Q.P.	AV.	Q.P.	AV.
1	0.16991	0.16	34.50	24.65	34.66	24.81	64.96	54.96	-30.31	-30.16
2	0.51682	0.21	38.25	36.51	38.46	36.72	56.00	46.00	-17.54	-9.28
3	0.78742	0.24	21.14	15.27	21.38	15.51	56.00	46.00	-34.62	-30.49
4	2.17217	0.30	22.41	18.27	22.71	18.57	56.00	46.00	-33.29	-27.43
5	10.41118	0.50	22.04	14.07	22.54	14.57	60.00	50.00	-37.46	-35.43
6	20.25638	0.77	43.24	37.17	44.01	37.94	60.00	50.00	-15.99	-12.06

REMARKS:

1. Q.P. and AV. are abbreviations of quasi-peak and average individually.
2. The emission levels of other frequencies were very low against the limit.
3. Margin value = Emission level - Limit value
4. Correction factor = Insertion loss + Cable loss
5. Emission Level = Correction Factor + Reading Value.

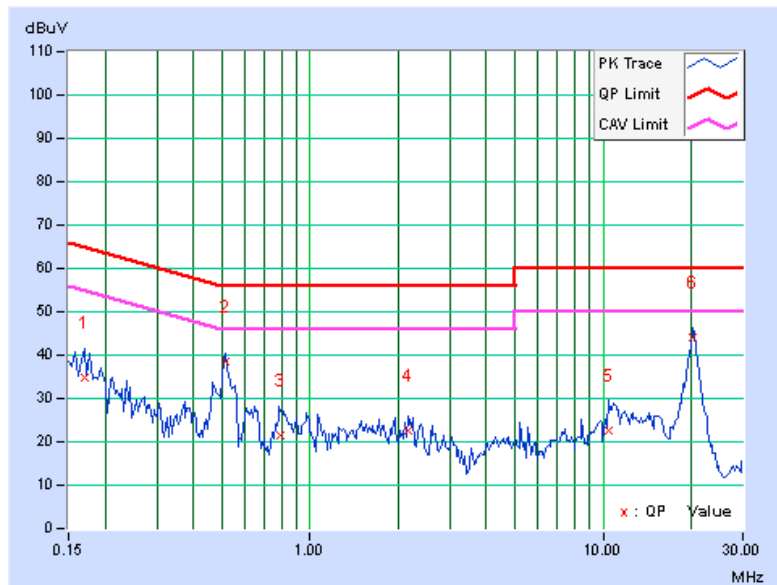

For 2.4GHz band + 5GHz Band 4

802.11n (20MHz) + 802.11an (20MHz)

CHANNEL	CH 6 + CH 149	6dB BANDWIDTH	9kHz
PHASE	Line 1		

No	Freq. [MHz]	Corr. Factor (dB)	Reading Value [dB (uV)]		Emission Level [dB (uV)]		Limit [dB (uV)]		Margin (dB)	
			Q.P.	AV.	Q.P.	AV.	Q.P.	AV.	Q.P.	AV.
			1	0.15447	0.17	38.17	20.82	38.34	20.99	65.76
2	0.51885	0.22	38.01	36.44	38.23	36.66	56.00	46.00	-17.77	-9.34
3	0.61527	0.23	23.28	20.14	23.51	20.37	56.00	46.00	-32.49	-25.63
4	1.72385	0.28	22.36	17.74	22.64	18.02	56.00	46.00	-33.36	-27.98
5	10.94974	0.46	20.45	14.39	20.91	14.85	60.00	50.00	-39.09	-35.15
6	20.39489	0.68	43.04	38.44	43.72	39.12	60.00	50.00	-16.28	-10.88

REMARKS:

1. Q.P. and AV. are abbreviations of quasi-peak and average individually.
2. The emission levels of other frequencies were very low against the limit.
3. Margin value = Emission level - Limit value
4. Correction factor = Insertion loss + Cable loss
5. Emission Level = Correction Factor + Reading Value.

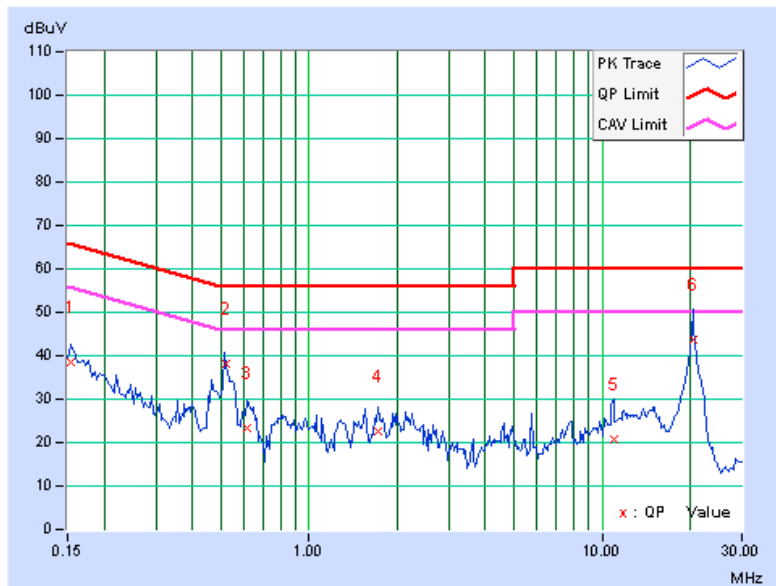



A D T

CHANNEL	CH 6 + CH 149	6dB BANDWIDTH	9kHz
PHASE	Line 2		

No	Freq. [MHz]	Corr. Factor (dB)	Reading Value [dB (uV)]		Emission Level [dB (uV)]		Limit [dB (uV)]		Margin (dB)	
			Q.P.	AV.	Q.P.	AV.	Q.P.	AV.	Q.P.	AV.
			1	0.15687	0.16	31.41	18.62	31.57	18.78	65.63
2	0.51827	0.21	37.47	36.27	37.68	36.48	56.00	46.00	-18.32	-9.52
3	0.81627	0.24	21.36	18.14	21.60	18.38	56.00	46.00	-34.40	-27.62
4	1.29178	0.27	22.07	16.35	22.34	16.62	56.00	46.00	-33.66	-29.38
5	1.83682	0.29	19.54	13.92	19.83	14.21	56.00	46.00	-36.17	-31.79
6	20.23559	0.77	42.47	36.09	43.24	36.86	60.00	50.00	-16.76	-13.14

REMARKS:

1. Q.P. and AV. are abbreviations of quasi-peak and average individually.
2. The emission levels of other frequencies were very low against the limit.
3. Margin value = Emission level - Limit value
4. Correction factor = Insertion loss + Cable loss
5. Emission Level = Correction Factor + Reading Value.

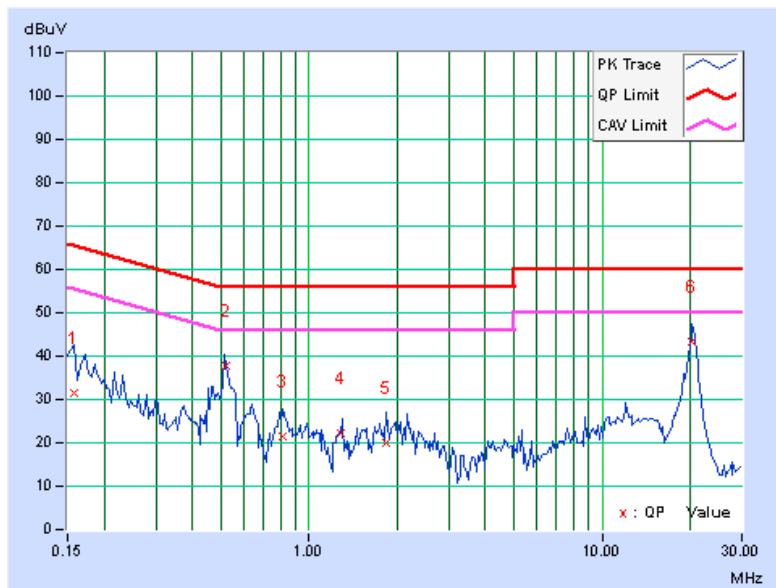



A D T

5. PHOTOGRAPHS OF THE TEST CONFIGURATION

Please refer to the attached file (Test Setup Photo).



A D T

6. INFORMATION ON THE TESTING LABORATORIES

We, Bureau Veritas Consumer Products Services (H.K.) Ltd., Taoyuan Branch, were founded in 1988 to provide our best service in EMC, Radio, Telecom and Safety consultation. Our laboratories are accredited and approved according to ISO/IEC 17025.

If you have any comments, please feel free to contact us at the following:

Linko EMC/RF Lab

Tel: 886-2-26052180

Fax: 886-2-26051924

Hsin Chu EMC/RF Lab

Tel: 886-3-5935343

Fax: 886-3-5935342

Hwa Ya EMC/RF/Safety/Telecom Lab

Tel: 886-3-3183232

Fax: 886-3-3270892

Email: service.adt@tw.bureauveritas.com

Web Site: www.bureauveritas-adt.com

The address and road map of all our labs can be found in our web site also.



A D T

7. APPENDIX A - MODIFICATIONS RECORDERS FOR ENGINEERING CHANGES TO THE EUT BY THE LAB

No modifications were made to the EUT by the lab during the test.

---END---