

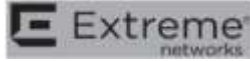

FCC Test Report

FCC ID : QXO-AP360
Equipment : Wireless Access Point
Brand Name :  Extreme networks or Extreme Networks
Model Name : AP360i, AP360e
Applicant : Extreme Networks, Inc.
6480 Via Del Oro, San Jose, CA 95119, United States
Manufacturer : Extreme Networks, Inc.
6480 Via Del Oro, San Jose, CA 95119, United States
Standard : 47 CFR FCC Part 15.407

The product was received on Nov. 27, 2019, and testing was started from Jan. 23, 2020 and completed on Mar. 07, 2020. We, SPORTON INTERNATIONAL INC. EMC & Wireless Communications Laboratory, would like to declare that the tested sample has been evaluated in accordance with the procedures given in ANSI C63.10-2013 and shown compliance with the applicable technical standards.

The report must not be used by the client to claim product certification, approval, or endorsement by TAF or any agency of government.

The test results in this report apply exclusively to the tested model / sample. Without written approval of SPORTON INTERNATIONAL INC. EMC & Wireless Communications Laboratory, the test report shall not be reproduced except in full.



Approved by: Allen Lin

SPORTON INTERNATIONAL INC. EMC & Wireless Communications Laboratory

No. 52, Huaya 1st Rd., Guishan Dist., Taoyuan City, Taiwan (R.O.C.)



Table of Contents

HISTORY OF THIS TEST REPORT3

SUMMARY OF TEST RESULT4

1 GENERAL DESCRIPTION5

1.1 Information.....5

1.2 Testing Applied Standards11

1.3 Testing Location Information11

1.4 Measurement Uncertainty11

2 TEST CONFIGURATION OF EUT.....12

2.1 Test Condition12

2.2 Test Channel Mode12

2.3 The Worst Case Measurement Configuration.....31

2.4 Support Equipment.....33

2.5 Test Setup Diagram35

3 TRANSMITTER TEST RESULT38

3.1 AC Power-line Conducted Emissions38

3.2 Emission Bandwidth40

3.3 Maximum Conducted Output Power41

3.4 Peak Power Spectral Density.....43

3.5 Unwanted Emissions.....45

4 TEST EQUIPMENT AND CALIBRATION DATA.....49

APPENDIX A. TEST RESULTS OF AC POWER-LINE CONDUCTED EMISSIONS

APPENDIX B. TEST RESULTS OF EMISSION BANDWIDTH

**APPENDIX C. TEST RESULTS OF MAXIMUM CONDUCTED OUTPUT POWER AND
MAX. E.I.R.P. AT ANY ELEVATION ANGLE ABOVE 30 DEGREES**

APPENDIX D. TEST RESULTS OF PEAK POWER SPECTRAL DENSITY

APPENDIX E. TEST RESULTS OF UNWANTED EMISSIONS

APPENDIX F. TEST PHOTOS

PHOTOGRAPHS OF EUT V01



Summary of Test Result

Report Clause	Ref. Std. Clause	Test Items	Result (PASS/FAIL)	Remark
1.1.2	15.203	Antenna Requirement	PASS	-
3.1	15.207	AC Power-line Conducted Emissions	PASS	-
3.2	15.407(a)	Emission Bandwidth	PASS	-
3.3	15.407(a)	Maximum Conducted Output Power	PASS	-
3.4	15.407(a)	Peak Power Spectral Density	PASS	-
3.5	15.407(b)	Unwanted Emissions	PASS	-

Declaration of Conformity:
The test results with all measurement uncertainty excluded are presented in accordance with the regulation limits or requirements declared by manufacturers.
Comments and explanations:
None

Reviewed by: Sam Tsai
Report Producer: Ann Hou



1 General Description

1.1 Information

1.1.1 RF General Information

Frequency Range (MHz)	IEEE Std. 802.11	Ch. Frequency (MHz)	Channel Number
5150-5250	a, n (HT20), ac (VHT20), ax (HEW20)	5180-5240	36-48 [4]
5725-5850		5745-5825	149-165 [5]
5150-5250	n (HT40), ac (VHT40), ax (HEW40)	5190-5230	38-46 [2]
5725-5850		5755-5795	151-159 [2]
5150-5250	ac (VHT80), ax (HEW80)	5210	42 [1]
5725-5850		5775	155 [1]

Non-Beamforming

Band	Mode	BWch (MHz)	Nant
5.15-5.25GHz	802.11a	20	1TX
5.725-5.85GHz	802.11a	20	1TX
5.15-5.25GHz	802.11ac VHT20	20	1TX
5.725-5.85GHz	802.11ac VHT20	20	1TX
5.15-5.25GHz	802.11ac VHT40	40	1TX
5.725-5.85GHz	802.11ac VHT40	40	1TX
5.15-5.25GHz	802.11ac VHT80	80	1TX
5.725-5.85GHz	802.11ac VHT80	80	1TX
5.15-5.25GHz	802.11ax HEW20	20	1TX
5.725-5.85GHz	802.11ax HEW20	20	1TX
5.15-5.25GHz	802.11ax HEW40	40	1TX
5.725-5.85GHz	802.11ax HEW40	40	1TX
5.15-5.25GHz	802.11ax HEW80	80	1TX
5.725-5.85GHz	802.11ax HEW80	80	1TX
5.15-5.25GHz	802.11a	20	2TX
5.725-5.85GHz	802.11a	20	2TX
5.15-5.25GHz	802.11ac VHT20	20	2TX
5.725-5.85GHz	802.11ac VHT20	20	2TX
5.15-5.25GHz	802.11ac VHT40	40	2TX
5.725-5.85GHz	802.11ac VHT40	40	2TX
5.15-5.25GHz	802.11ac VHT80	80	2TX



Band	Mode	BWch (MHz)	Nant
5.725-5.85GHz	802.11ac VHT80	80	2TX
5.15-5.25GHz	802.11ax HEW20	20	2TX
5.725-5.85GHz	802.11ax HEW20	20	2TX
5.15-5.25GHz	802.11ax HEW40	40	2TX
5.725-5.85GHz	802.11ax HEW40	40	2TX
5.15-5.25GHz	802.11ax HEW80	80	2TX
5.725-5.85GHz	802.11ax HEW80	80	2TX

Beamforming

Band	Mode	BWch (MHz)	Nant
5.15-5.25GHz	802.11ac VHT20-BF	20	2TX
5.725-5.85GHz	802.11ac VHT20-BF	20	2TX
5.15-5.25GHz	802.11ac VHT40-BF	40	2TX
5.725-5.85GHz	802.11ac VHT40-BF	40	2TX
5.15-5.25GHz	802.11ac VHT80-BF	80	2TX
5.725-5.85GHz	802.11ac VHT80-BF	80	2TX
5.15-5.25GHz	802.11ax HEW20-BF	20	2TX
5.725-5.85GHz	802.11ax HEW20-BF	20	2TX
5.15-5.25GHz	802.11ax HEW40-BF	40	2TX
5.725-5.85GHz	802.11ax HEW40-BF	40	2TX
5.15-5.25GHz	802.11ax HEW80-BF	80	2TX
5.725-5.85GHz	802.11ax HEW80-BF	80	2TX

Note:

- ♦ 11a, HT20 and HT40 use a combination of OFDM-BPSK, QPSK, 16QAM, 64QAM modulation.
- ♦ VHT20, VHT40, VHT80 use a combination of OFDM-BPSK, QPSK, 16QAM, 64QAM, 256QAM modulation.
- ♦ HEW20, HEW40, HEW80 use a combination of OFDMA-BPSK, QPSK, 16QAM, 64QAM, 256QAM, 1024QAM modulation.
- ♦ BWch is the nominal channel bandwidth.
- ♦ The resource unit of HEW 20, HEW 40, HEW 80 only support full loading.

1.1.2 Antenna Information

(AP360i) Internal Antenna

Ant.	Brand	Model Number (P/N)	Antenna Type	Connector	Antenna Gain (dBi)			Remark
					2.4GHz	5GHz	BLE/Thread	
1	Senao	5718A0490300	PIFA	IPEX	4.53	4.8	-	Radio 1
2	Senao	5718A0491300	PIFA	IPEX	4.3	5.09	-	Radio 1
3	Senao	5718A0492300	PIFA	IPEX	-	4.94	-	Radio 2
4	Senao	5718A0493300	PIFA	IPEX	-	5.1	-	Radio 2
5	Senao	5718A0494300	PIFA	IPEX	-	-	4.99	Radio 3

(AP360e) External Antenna

Group	Brand	Model Number (P/N)	Antenna Type	Connector	Antenna Gain (dBi)			
					2.4GHz	5GHz	Angle above 30 degrees	BLE/Thread
1	Extreme	ML-2452-APA2-01	Omni	Reverse SMA	3.17	4.85	-	-
2	Extreme	ML-2452-HPA5-036	Omni	Reverse SMA	3.9	5.7	-	-
3	Extreme	ML-2452-HPAG4A6-01	Omni	N-type	4	7.3	-	-
4	Extreme	ML-2452-PTA4M4-036	Omni	Reverse SMA	5	6.6	-	-
5	Extreme	ML-2452-HPAG5A8-01	Omni	N-type	5	8	-6.05	-
6	Extreme	30724 WS-AO-DQ04360N	Omni	N-type	5.5	6	-	-
7	Extreme	AI-DQ04360S	Omni	Reverse SMA	5.5	6	-	-
8	Extreme	ML-2452-PNA5-01R	Panel	N-type	4.5	5	-	-
9	Extreme	ML-2452-SEC6M4-036, WS-AI-DQ05120 (30702)	Panel	Reverse SMA	6.92	7.23	-	-
10	Extreme	30705 WS-AI-DE07025	Panel	Reverse SMA	7.5	6.5	-	-
11	Extreme	ML-2452-PNA7-01R	Panel 1	N-type	7.8	10.7	7.9	7.8
12	Extreme	30707 WS-AI-DE10055	Panel 2	Reverse SMA	10.5	7.5	-	-
13	Extreme	ML-2452-APA2-02	Omni	Reverse SMA	3.17	4.85	-	-
14	Extreme	ML-2499-HPA8-01	Dipole	N-type	-	-	-	8

Note 1: Group 5, 11 and 12 were measured during the test for WLAN 2.4G Mode.

Note 2: Group 11 and 14 were measured during the test for Bluetooth/Thread Mode.



Note 3: Group 5 and 11 were measured during the test for WLAN 5G Mode.

For 2.4GHz function:

For IEEE 802.11 b/g/n/ac/ax mode (1TX/1RX)
 Only port 1 can be used as transmitting/receiving antenna.
 For IEEE 802.11 b/g/n/ac/ax mode (2TX/2RX)
 Port 1 and port 2 could transmit/receive simultaneously.

For BT function:

For IEEE 802.15.1 Bluetooth mode (1TX/1RX)
 Only port 1 can be used as transmitting/receiving antenna.

For Thread function:

For IEEE 802.15.4 Thread mode (1TX/1RX)
 Only port 1 can be used as transmitting/receiving antenna.

For 5GHz function:

For IEEE 802.11 a/n/ac/ax mode (1TX/1RX)
 Only port 1 can be used as transmitting/receiving antenna.
 For IEEE 802.11 a/n/ac/ax mode (2TX/2RX)
 Port 1 and port 2 could transmit/receive simultaneously.

1.1.3 EUT Information

Operational Condition			
EUT Power Type	From PoE		
EUT Function	<input checked="" type="checkbox"/>	Outdoor AP	<input type="checkbox"/> Indoor AP
	<input type="checkbox"/>	Fixed P2P AP	<input type="checkbox"/> Outdoor/Indoor Client
Beamforming Function	<input checked="" type="checkbox"/>	With beamforming	<input type="checkbox"/> Without beamforming
Type of EUT			
<input checked="" type="checkbox"/>	Stand-alone		
<input type="checkbox"/>	Combined (EUT where the radio part is fully integrated within another device)		
	Combined Equipment - Brand Name / Model No.: ...		
<input type="checkbox"/>	Plug-in radio (EUT intended for a variety of host systems)		
	Host System - Brand Name / Model No.:		
<input type="checkbox"/>	Other:		

1.1.4 Table for Multiple Listing

Sample Number	Model Name	Description
1	AP360i	The "i" in AP360i indicates that it comes with internal antennas and the "e" in AP360e indicates that the access point comes with external antenna connectors.
2	AP360e	



1.1.5 Mode Test Duty Cycle

Non-Beamforming

Sample 1 & 2_Radio 1_1T1S

Mode	DC	DCF(dB)	T(s)	VBW(Hz) ≥ 1/T
802.11a_Nss1,(6Mbps)_1TX	0.951	0.22	2.067m	1k
802.11ac VHT20_Nss1,(MCS0)_1TX	0.986	0.06	1.932m	10
802.11ac VHT40_Nss1,(MCS0)_1TX	0.972	0.12	955.938u	3k
802.11ac VHT80_Nss1,(MCS0)_1TX	0.945	0.25	463.75u	3k
802.11ax HEW20_Nss1,(MCS0)_1TX	0.981	0.08	1.49m	10
802.11ax HEW40_Nss1,(MCS0)_1TX	0.964	0.16	774.375u	3k
802.11ax HEW80_Nss1,(MCS0)_1TX	0.931	0.31	404.688u	3k

Note. If DC < 0.98, the DCF was added while measuring Output power and PSD.

Sample 1 & 2_Radio 2_1T1S

Mode	DC	DCF(dB)	T(s)	VBW(Hz) ≥ 1/T
802.11a_Nss1,(6Mbps)_1TX	0.952	0.21	2.067m	1k
802.11ac VHT20_Nss1,(MCS0)_1TX	0.987	0.06	1.932m	10
802.11ac VHT40_Nss1,(MCS0)_1TX	0.972	0.12	955.938u	3k
802.11ac VHT80_Nss1,(MCS0)_1TX	0.945	0.25	463.75u	3k
802.11ax HEW20_Nss1,(MCS0)_1TX	0.981	0.08	1.49m	10
802.11ax HEW40_Nss1,(MCS0)_1TX	0.964	0.16	774.375u	3k
802.11ax HEW80_Nss1,(MCS0)_1TX	0.931	0.31	404.688u	3k

Note. If DC < 0.98, the DCF was added while measuring Output power and PSD.

Sample 1 & 2_Radio 1_2T2S

Mode	DC	DCF(dB)	T(s)	VBW(Hz) ≥ 1/T
802.11a_Nss1,(6Mbps)_2TX	0.951	0.22	2.066m	1k
802.11ac VHT20_Nss2,(MCS0)_2TX	0.986	0.06	1.93m	10
802.11ac VHT40_Nss2,(MCS0)_2TX	0.972	0.12	954.688u	3k
802.11ac VHT80_Nss2,(MCS0)_2TX	0.944	0.25	462.5u	3k
802.11ax HEW20_Nss2,(MCS0)_2TX	0.98	0.09	1.489m	10
802.11ax HEW40_Nss2,(MCS0)_2TX	0.964	0.16	775u	3k
802.11ax HEW80_Nss2,(MCS0)_2TX	0.93	0.32	403.125u	3k

Note. If DC < 0.98, the DCF was added while measuring Output power and PSD.



Sample 1 & 2_Radio 2_2T2S

Mode	DC	DCF(dB)	T(s)	VBW(Hz) ≥ 1/T
802.11a_Nss1,(6Mbps)_2TX	0.951	0.22	2.066m	1k
802.11ac VHT20_Nss2,(MCS0)_2TX	0.972	0.12	990.625u	3k
802.11ac VHT40_Nss2,(MCS0)_2TX	0.948	0.23	501.563u	3k
802.11ac VHT80_Nss2,(MCS0)_2TX	0.903	0.44	257.813u	10k
802.11ax HEW20_Nss2,(MCS0)_2TX	0.964	0.16	781.25u	3k
802.11ax HEW40_Nss2,(MCS0)_2TX	0.932	0.31	423.438u	3k
802.11ax HEW80_Nss2,(MCS0)_2TX	0.892	0.5	242.187u	10k

Note. If DC < 0.98, the DCF was added while measuring Output power and PSD.

Beamforming

Sample 1 & 2_Radio 1

Mode	DC	DCF(dB)	T(s)	VBW(Hz) ≥ 1/T
802.11ac VHT20-BF_Nss1,(MCS0)_2TX	0.911	0.4	1.948m	1k
802.11ac VHT40-BF_Nss1,(MCS0)_2TX	0.914	0.39	2.796m	1k
802.11ac VHT80-BF_Nss1,(MCS0)_2TX	0.91	0.41	3.43m	300
802.11ax HEW20-BF_Nss1,(MCS0)_2TX	0.882	0.55	1.501m	1k
802.11ax HEW40-BF_Nss1,(MCS0)_2TX	0.887	0.52	2.222m	1k
802.11ax HEW80-BF_Nss1,(MCS0)_2TX	0.883	0.54	3.844m	300

Note. If DC < 0.98, the DCF was added while measuring Output power and PSD.

Sample 1 & 2_Radio 2

Mode	DC	DCF(dB)	T(s)	VBW(Hz) ≥ 1/T
802.11ac VHT20-BF_Nss1,(MCS0)_2TX	0.962	0.17	2.073m	1k
802.11ac VHT40-BF_Nss1,(MCS0)_2TX	0.963	0.16	2.073m	1k
802.11ac VHT80-BF_Nss1,(MCS0)_2TX	0.979	0.09	2.074m	1k
802.11ax HEW20-BF_Nss1,(MCS0)_2TX	0.868	0.61	1.501m	1k
802.11ax HEW40-BF_Nss1,(MCS0)_2TX	0.868	0.61	1.501m	1k
802.11ax HEW80-BF_Nss1,(MCS0)_2TX	0.874	0.58	3.842m	300

Note. If DC < 0.98, the DCF was added while measuring Output power and PSD.

1.2 Testing Applied Standards

According to the specifications of the manufacturer, the EUT must comply with the requirements of the following standards:

- ◆ 47 CFR FCC Part 15
- ◆ ANSI C63.10-2013
- ◆ KDB 789033 D02 v02r01
- ◆ KDB 662911 D01 v02r01
- ◆ KDB 414788 D01 v01r01

1.3 Testing Location Information

Testing Location		
<input checked="" type="checkbox"/>	HWA YA	ADD : No. 52, Huaya 1st Rd., Guishan Dist., Taoyuan City, Taiwan (R.O.C.) TEL : 886-3-327-3456 FAX : 886-3-327-0973
Test site Designation No. TW1190 with FCC.		
<input type="checkbox"/>	JHUBEI	ADD : No.8, Ln. 724, Bo'ai St., Zhubei City, Hsinchu County, Taiwan (R.O.C.) TEL : 886-3-656-9065 FAX : 886-3-656-9085
Test site Designation No. TW0006 with FCC.		
<input type="checkbox"/>	Wen Shan	ADD : No.14-1, Ln. 19, Wen 33rd St., Guishan Dist., Taoyuan City 333, Taiwan (R.O.C.) TEL : 886-3-318-0787 FAX : 886-3-318-0287
Test site Designation No. TW1097 with FCC.		

Test Condition	Test Site No.	Test Engineer	Test Environment	Test Date
AC Conduction	CO04-HY	Edward	20.3~21.9°C / 55~69%	07/Mar/2020
RF Conducted	TH01-HY	Barry	25.7~26.3°C / 60~66%	31/Jan/2020~ 05/Mar/2020
Radiated	03CH02-HY	Daniel	22.1~24.6°C / 40~55%	23/Jan/2020~ 26/Feb/2020

1.4 Measurement Uncertainty

ISO/IEC 17025 requires that an estimate of the measurement uncertainties associated with the emissions test results be included in the report. The measurement uncertainties given below are based on a 95% confidence level (based on a coverage factor (k=2))

Test Items	Uncertainty	Remark
Conducted Emission (150kHz ~ 30MHz)	0.9 dB	Confidence levels of 95%
Radiated Emission (9kHz ~ 30MHz)	2.4 dB	Confidence levels of 95%
Radiated Emission (30MHz ~ 1,000MHz)	3.7 dB	Confidence levels of 95%
Radiated Emission (1GHz ~ 18GHz)	3.6 dB	Confidence levels of 95%
Radiated Emission (18GHz ~ 40GHz)	3.5 dB	Confidence levels of 95%
Conducted Emission	1.0 dB	Confidence levels of 95%
Temperature	0.41 °C	Confidence levels of 95%
Humidity	3.4 %	Confidence levels of 95%



2 Test Configuration of EUT

2.1 Test Condition

Condition Item	Abbreviation/Remark	Remark
TnomVnom	Tnom	20°C
	Vnom	120V

2.2 Test Channel Mode

Test Software Version	accessMTool_REL_3_1_0_1 (Non-Beamforming) CMD (Beamforming)

Non-Beamforming Sample 1_Radio 1_1T1S

Mode	Power Setting
802.11a_Nss1,(6Mbps)_1TX	-
5180MHz	16.75
5200MHz	16.75
5240MHz	16.75
5745MHz	24
5785MHz	18.75
5825MHz	19
802.11ac VHT20_Nss1,(MCS0)_1TX	-
5180MHz	16.75
5200MHz	16.75
5240MHz	16.75
5745MHz	24
5785MHz	18.75
5825MHz	18.5
802.11ac VHT40_Nss1,(MCS0)_1TX	-
5190MHz	16.25
5230MHz	16.25
5755MHz	24
5795MHz	24
802.11ac VHT80_Nss1,(MCS0)_1TX	-
5210MHz	16.75
5775MHz	22
802.11ax HEW20_Nss1,(MCS0)_1TX	-
5180MHz	16.75
5200MHz	16.75
5240MHz	16.75
5745MHz	24



Mode	Power Setting
5785MHz	18.75
5825MHz	18.5
802.11ax HEW40_Nss1,(MCS0)_1TX	-
5190MHz	16.25
5230MHz	16.25
5755MHz	24
5795MHz	24
802.11ax HEW80_Nss1,(MCS0)_1TX	-
5210MHz	16.75
5775MHz	22



Sample 1_Radio 1_2T2S

Mode	Power Setting
802.11a_Nss1,(6Mbps)_2TX	-
5180MHz	14
5200MHz	14
5240MHz	14
5745MHz	20.5
5785MHz	15.5
5825MHz	14.25
802.11ac VHT20_Nss2,(MCS0)_2TX	-
5180MHz	14
5200MHz	14
5240MHz	14
5745MHz	19
5785MHz	16.75
5825MHz	15.5
802.11ac VHT40_Nss2,(MCS0)_2TX	-
5190MHz	14
5230MHz	14
5755MHz	21.25
5795MHz	18.25
802.11ac VHT80_Nss2,(MCS0)_2TX	-
5210MHz	14
5775MHz	20.75
802.11ax HEW20_Nss2,(MCS0)_2TX	-
5180MHz	14
5200MHz	14
5240MHz	14
5745MHz	19
5785MHz	16.75
5825MHz	15.5
802.11ax HEW40_Nss2,(MCS0)_2TX	-
5190MHz	14
5230MHz	14
5755MHz	21.25
5795MHz	18.25
802.11ax HEW80_Nss2,(MCS0)_2TX	-
5210MHz	14
5775MHz	20.75



Sample 1_Radio 2_1T1S

Mode	Power Setting
802.11a_Nss1,(6Mbps)_1TX	-
5180MHz	16
5200MHz	16
5240MHz	16
5745MHz	24
5785MHz	24
5825MHz	24
802.11ac VHT20_Nss1,(MCS0)_1TX	-
5180MHz	15.75
5200MHz	15.75
5240MHz	15.75
5745MHz	24
5785MHz	24
5825MHz	24
802.11ac VHT40_Nss1,(MCS0)_1TX	-
5190MHz	15.75
5230MHz	15.5
5755MHz	24
5795MHz	24
802.11ac VHT80_Nss1,(MCS0)_1TX	-
5210MHz	15.75
5775MHz	22.25
802.11ax HEW20_Nss1,(MCS0)_1TX	-
5180MHz	15.75
5200MHz	15.75
5240MHz	15.75
5745MHz	24
5785MHz	24
5825MHz	24
802.11ax HEW40_Nss1,(MCS0)_1TX	-
5190MHz	15.75
5230MHz	15.5
5755MHz	24
5795MHz	24
802.11ax HEW80_Nss1,(MCS0)_1TX	-
5210MHz	15.75
5775MHz	22.25



Sample 1_Radio 2_2T2S

Mode	Power Setting
802.11a_Nss1,(6Mbps)_2TX	-
5180MHz	13.25
5200MHz	13.25
5240MHz	13.25
5745MHz	24
5785MHz	24
5825MHz	24
802.11ac VHT20_Nss2,(MCS0)_2TX	-
5180MHz	13.25
5200MHz	13.25
5240MHz	13.25
5745MHz	24
5785MHz	24
5825MHz	24
802.11ac VHT40_Nss2,(MCS0)_2TX	-
5190MHz	13
5230MHz	13
5755MHz	23.5
5795MHz	24
802.11ac VHT80_Nss2,(MCS0)_2TX	-
5210MHz	13.25
5775MHz	21
802.11ax HEW20_Nss2,(MCS0)_2TX	-
5180MHz	13.25
5200MHz	13.25
5240MHz	13.25
5745MHz	24
5785MHz	24
5825MHz	24
802.11ax HEW40_Nss2,(MCS0)_2TX	-
5190MHz	13
5230MHz	13
5755MHz	23.5
5795MHz	24
802.11ax HEW80_Nss2,(MCS0)_2TX	-
5210MHz	13.25
5775MHz	21



Sample 2_Radio 1_Omni_1T1S

Mode	Power Setting
802.11a_Nss1,(6Mbps)_1TX	-
5180MHz	19.75
5200MHz	24
5240MHz	24
5745MHz	21.25
5785MHz	24
5825MHz	24
802.11ac VHT20_Nss1,(MCS0)_1TX	-
5180MHz	18.5
5200MHz	22.5
5240MHz	24
5745MHz	24
5785MHz	24
5825MHz	24
802.11ac VHT40_Nss1,(MCS0)_1TX	-
5190MHz	16.25
5230MHz	20.75
5755MHz	21.25
5795MHz	22.5
802.11ac VHT80_Nss1,(MCS0)_1TX	-
5210MHz	16.25
5775MHz	17.75
802.11ax HEW20_Nss1,(MCS0)_1TX	-
5180MHz	18.5
5200MHz	22.5
5240MHz	24
5745MHz	24
5785MHz	24
5825MHz	24
802.11ax HEW40_Nss1,(MCS0)_1TX	-
5190MHz	16.25
5230MHz	20.75
5755MHz	21.25
5795MHz	22.5
802.11ax HEW80_Nss1,(MCS0)_1TX	-
5210MHz	16.25
5775MHz	17.75



Sample 2_Radio 1_Omni_2T2S

Mode	Power Setting
802.11a_Nss1,(6Mbps)_2TX	-
5180MHz	17
5200MHz	22
5240MHz	21.75
5745MHz	20.5
5785MHz	17.5
5825MHz	14
802.11ac VHT20_Nss2,(MCS0)_2TX	-
5180MHz	17
5200MHz	21.25
5240MHz	23.5
5745MHz	21.5
5785MHz	19.5
5825MHz	14
802.11ac VHT40_Nss2,(MCS0)_2TX	-
5190MHz	15
5230MHz	19.5
5755MHz	19.5
5795MHz	20.75
802.11ac VHT80_Nss2,(MCS0)_2TX	-
5210MHz	14.5
5775MHz	17.5
802.11ax HEW20_Nss2,(MCS0)_2TX	-
5180MHz	17
5200MHz	21.25
5240MHz	23.5
5745MHz	21.5
5785MHz	19.5
5825MHz	14
802.11ax HEW40_Nss2,(MCS0)_2TX	-
5190MHz	15
5230MHz	19.5
5755MHz	19.5
5795MHz	20.75
802.11ax HEW80_Nss2,(MCS0)_2TX	-
5210MHz	14.5
5775MHz	17.5



Sample 2_Radio 2_Omni_1T1S

Mode	Power Setting
802.11a_Nss1,(6Mbps)_1TX	-
5180MHz	18.5
5200MHz	23
5240MHz	23.5
5745MHz	22.5
5785MHz	22.25
5825MHz	22.25
802.11ac VHT20_Nss1,(MCS0)_1TX	-
5180MHz	17.75
5200MHz	22.25
5240MHz	23.25
5745MHz	22.75
5785MHz	21.5
5825MHz	21.5
802.11ac VHT40_Nss1,(MCS0)_1TX	-
5190MHz	15.75
5230MHz	20
5755MHz	24
5795MHz	23.5
802.11ac VHT80_Nss1,(MCS0)_1TX	-
5210MHz	15.5
5775MHz	19.5
802.11ax HEW20_Nss1,(MCS0)_1TX	-
5180MHz	17.75
5200MHz	22.25
5240MHz	23.25
5745MHz	22.75
5785MHz	21.5
5825MHz	21.5
802.11ax HEW40_Nss1,(MCS0)_1TX	-
5190MHz	15.75
5230MHz	20
5755MHz	24
5795MHz	23.5
802.11ax HEW80_Nss1,(MCS0)_1TX	-
5210MHz	15.5
5775MHz	19.5



Sample 2_Radio 2_Omni_2T2S

Mode	Power Setting
802.11a_Nss1,(6Mbps)_2TX	-
5180MHz	17.5
5200MHz	21.75
5240MHz	23.5
5745MHz	22.5
5785MHz	24
5825MHz	23.25
802.11ac VHT20_Nss2,(MCS0)_2TX	-
5180MHz	17
5200MHz	21.5
5240MHz	23.5
5745MHz	22.5
5785MHz	22.25
5825MHz	24
802.11ac VHT40_Nss2,(MCS0)_2TX	-
5190MHz	15.25
5230MHz	20.25
5755MHz	21.75
5795MHz	23
802.11ac VHT80_Nss2,(MCS0)_2TX	-
5210MHz	14
5775MHz	18.5
802.11ax HEW20_Nss2,(MCS0)_2TX	-
5180MHz	17
5200MHz	21.5
5240MHz	23.5
5745MHz	22.5
5785MHz	22.25
5825MHz	24
802.11ax HEW40_Nss2,(MCS0)_2TX	-
5190MHz	15.25
5230MHz	20.25
5755MHz	21.75
5795MHz	23
802.11ax HEW80_Nss2,(MCS0)_2TX	-
5210MHz	14
5775MHz	18.5



Sample 2_Radio 1_Panel 1_1T1S

Mode	Power Setting
802.11a_Nss1,(6Mbps)_1TX	-
5180MHz	19.5
5200MHz	23.75
5240MHz	24
5745MHz	22.75
5785MHz	24
5825MHz	24
802.11ac VHT20_Nss1,(MCS0)_1TX	-
5180MHz	18.25
5200MHz	22.75
5240MHz	24
5745MHz	21.75
5785MHz	24
5825MHz	24
802.11ac VHT40_Nss1,(MCS0)_1TX	-
5190MHz	16.5
5230MHz	21
5755MHz	21.5
5795MHz	22.75
802.11ac VHT80_Nss1,(MCS0)_1TX	-
5210MHz	16.25
5775MHz	17.75
802.11ax HEW20_Nss1,(MCS0)_1TX	-
5180MHz	18.25
5200MHz	22.75
5240MHz	24
5745MHz	21.75
5785MHz	24
5825MHz	24
802.11ax HEW40_Nss1,(MCS0)_1TX	-
5190MHz	16.5
5230MHz	21
5755MHz	21.5
5795MHz	22.75
802.11ax HEW80_Nss1,(MCS0)_1TX	-
5210MHz	16.25
5775MHz	17.75



Sample 2_Radio 1_Panel 1_2T2S

Mode	Power Setting
802.11a_Nss1,(6Mbps)_2TX	-
5180MHz	16
5200MHz	19.75
5240MHz	19.75
5745MHz	22
5785MHz	22
5825MHz	15.5
802.11ac VHT20_Nss2,(MCS0)_2TX	-
5180MHz	17.25
5200MHz	21.25
5240MHz	22
5745MHz	21.75
5785MHz	21.75
5825MHz	16.25
802.11ac VHT40_Nss2,(MCS0)_2TX	-
5190MHz	15.25
5230MHz	19.75
5755MHz	21
5795MHz	21
802.11ac VHT80_Nss2,(MCS0)_2TX	-
5210MHz	14.25
5775MHz	17.75
802.11ax HEW20_Nss2,(MCS0)_2TX	-
5180MHz	17.25
5200MHz	21.25
5240MHz	22
5745MHz	21.75
5785MHz	21.75
5825MHz	16.25
802.11ax HEW40_Nss2,(MCS0)_2TX	-
5190MHz	15.25
5230MHz	19.75
5755MHz	21
5795MHz	21
802.11ax HEW80_Nss2,(MCS0)_2TX	-
5210MHz	14.25
5775MHz	17.75



Sample 2_Radio 2_Panel 1_1T1S

Mode	Power Setting
802.11a_Nss1,(6Mbps)_1TX	-
5180MHz	18.75
5200MHz	23.5
5240MHz	23.25
5745MHz	23
5785MHz	24
5825MHz	23.25
802.11ac VHT20_Nss1,(MCS0)_1TX	-
5180MHz	17.75
5200MHz	22.75
5240MHz	23
5745MHz	23.25
5785MHz	23
5825MHz	24
802.11ac VHT40_Nss1,(MCS0)_1TX	-
5190MHz	16.25
5230MHz	21
5755MHz	23.5
5795MHz	24
802.11ac VHT80_Nss1,(MCS0)_1TX	-
5210MHz	16.25
5775MHz	20.25
802.11ax HEW20_Nss1,(MCS0)_1TX	-
5180MHz	17.75
5200MHz	22.75
5240MHz	23
5745MHz	23.25
5785MHz	23
5825MHz	24
802.11ax HEW40_Nss1,(MCS0)_1TX	-
5190MHz	16.25
5230MHz	21
5755MHz	23.5
5795MHz	24
802.11ax HEW80_Nss1,(MCS0)_1TX	-
5210MHz	16.25
5775MHz	20.25



Sample 2_Radio 2_Panel 1_2T2S

Mode	Power Setting
802.11a_Nss1,(6Mbps)_2TX	-
5180MHz	16
5200MHz	19.25
5240MHz	19.25
5745MHz	21.75
5785MHz	20.25
5825MHz	21.25
802.11ac VHT20_Nss2,(MCS0)_2TX	-
5180MHz	16.75
5200MHz	21
5240MHz	21.5
5745MHz	21.75
5785MHz	21.75
5825MHz	22
802.11ac VHT40_Nss2,(MCS0)_2TX	-
5190MHz	15
5230MHz	20.25
5755MHz	21.75
5795MHz	22.25
802.11ac VHT80_Nss2,(MCS0)_2TX	-
5210MHz	14
5775MHz	18.75
802.11ax HEW20_Nss2,(MCS0)_2TX	-
5180MHz	16.75
5200MHz	21
5240MHz	21.5
5745MHz	21.75
5785MHz	21.75
5825MHz	22
802.11ax HEW40_Nss2,(MCS0)_2TX	-
5190MHz	15
5230MHz	20.25
5755MHz	21.75
5795MHz	22.25
802.11ax HEW80_Nss2,(MCS0)_2TX	-
5210MHz	14
5775MHz	18.75



Beamforming
Sample 1_Radio 1

Mode	Power Setting
802.11ac VHT20-BF_Nss1,(MCS0)_2TX	-
5180MHz	12.5
5200MHz	12.5
5240MHz	12.5
5745MHz	22.25
5785MHz	15.75
5825MHz	13.25
802.11ac VHT40-BF_Nss1,(MCS0)_2TX	-
5190MHz	12.5
5230MHz	12.25
5755MHz	22.5
5795MHz	22
802.11ac VHT80-BF_Nss1,(MCS0)_2TX	-
5210MHz	12.5
5775MHz	22
802.11ax HEW20-BF_Nss1,(MCS0)_2TX	-
5180MHz	12.5
5200MHz	12.5
5240MHz	12.5
5745MHz	18.25
5785MHz	15.75
5825MHz	13.25
802.11ax HEW40-BF_Nss1,(MCS0)_2TX	-
5190MHz	12.5
5230MHz	12.5
5755MHz	22.5
5795MHz	22
802.11ax HEW80-BF_Nss1,(MCS0)_2TX	-
5210MHz	12.5
5775MHz	22



Sample 1_Radio 2

Mode	Power Setting
802.11ac VHT20-BF_Nss1,(MCS0)_2TX	-
5180MHz	13.75
5200MHz	13.75
5240MHz	13.5
5745MHz	22.25
5785MHz	22.5
5825MHz	22
802.11ac VHT40-BF_Nss1,(MCS0)_2TX	-
5190MHz	13.5
5230MHz	13.5
5755MHz	23.5
5795MHz	24
802.11ac VHT80-BF_Nss1,(MCS0)_2TX	-
5210MHz	13.5
5775MHz	21.5
802.11ax HEW20-BF_Nss1,(MCS0)_2TX	-
5180MHz	13.75
5200MHz	13.75
5240MHz	13.5
5745MHz	22.25
5785MHz	22.5
5825MHz	22
802.11ax HEW40-BF_Nss1,(MCS0)_2TX	-
5190MHz	13.5
5230MHz	13.5
5755MHz	23.5
5795MHz	24
802.11ax HEW80-BF_Nss1,(MCS0)_2TX	-
5210MHz	13.5
5775MHz	21.5



Sample 2_Radio 1_Omni

Mode	Power Setting
802.11ac VHT20-BF_Nss1,(MCS0)_2TX	-
5180MHz	17.5
5200MHz	21.25
5240MHz	21.5
5745MHz	21.5
5785MHz	21.5
5825MHz	14.75
802.11ac VHT40-BF_Nss1,(MCS0)_2TX	-
5190MHz	14.25
5230MHz	19.5
5755MHz	20.5
5795MHz	21.75
802.11ac VHT80-BF_Nss1,(MCS0)_2TX	-
5210MHz	14.5
5775MHz	17.25
802.11ax HEW20-BF_Nss1,(MCS0)_2TX	17.5
5180MHz	21.25
5200MHz	21.5
5240MHz	21.5
5745MHz	21.5
5785MHz	14.75
5825MHz	-
802.11ax HEW40-BF_Nss1,(MCS0)_2TX	14.25
5190MHz	19.5
5230MHz	20.5
5755MHz	21.75
5795MHz	-
802.11ax HEW80-BF_Nss1,(MCS0)_2TX	14.5
5210MHz	17.25
5775MHz	17.5



Sample 2_Radio 2_Omni

Mode	Power Setting
802.11ac VHT20-BF_Nss1,(MCS0)_2TX	-
5180MHz	7.25
5200MHz	7.25
5240MHz	7.25
5745MHz	20.5
5785MHz	22.25
5825MHz	22.75
802.11ac VHT40-BF_Nss1,(MCS0)_2TX	-
5190MHz	7.25
5230MHz	7.25
5755MHz	21.75
5795MHz	22.75
802.11ac VHT80-BF_Nss1,(MCS0)_2TX	-
5210MHz	7.25
5775MHz	18.25
802.11ax HEW20-BF_Nss1,(MCS0)_2TX	-
5180MHz	7.25
5200MHz	7.25
5240MHz	7.25
5745MHz	20.5
5785MHz	22.25
5825MHz	22.75
802.11ax HEW40-BF_Nss1,(MCS0)_2TX	-
5190MHz	7.25
5230MHz	7.25
5755MHz	21.75
5795MHz	22.75
802.11ax HEW80-BF_Nss1,(MCS0)_2TX	-
5210MHz	7.25
5775MHz	18.25



Sample 2_Radio 1_Panel 1

Mode	Power Setting
802.11ac VHT20-BF_Nss1,(MCS0)_2TX	-
5180MHz	10
5200MHz	10
5240MHz	10
5745MHz	19
5785MHz	14.25
5825MHz	12
802.11ac VHT40-BF_Nss1,(MCS0)_2TX	-
5190MHz	9.75
5230MHz	9.75
5755MHz	18.75
5795MHz	16
802.11ac VHT80-BF_Nss1,(MCS0)_2TX	-
5210MHz	9.75
5775MHz	16.75
802.11ax HEW20-BF_Nss1,(MCS0)_2TX	-
5180MHz	10
5200MHz	10
5240MHz	10
5745MHz	19
5785MHz	14.25
5825MHz	12
802.11ax HEW40-BF_Nss1,(MCS0)_2TX	-
5190MHz	9.75
5230MHz	9.75
5755MHz	18.75
5795MHz	16
802.11ax HEW80-BF_Nss1,(MCS0)_2TX	-
5210MHz	9.75
5775MHz	16.75



Sample 2_Radio 2_Panel 1



Mode	Power Setting
802.11ac VHT20-BF_Nss1,(MCS0)_2TX	-
5180MHz	10
5200MHz	10.25
5240MHz	10
5745MHz	18.5
5785MHz	19
5825MHz	18.5
802.11ac VHT40-BF_Nss1,(MCS0)_2TX	-
5190MHz	10
5230MHz	10
5755MHz	19.5
5795MHz	19.75
802.11ac VHT80-BF_Nss1,(MCS0)_2TX	-
5210MHz	10
5775MHz	17.25
802.11ax HEW20-BF_Nss1,(MCS0)_2TX	-
5180MHz	10
5200MHz	10.25
5240MHz	10
5745MHz	18.5
5785MHz	19
5825MHz	18.5
802.11ax HEW40-BF_Nss1,(MCS0)_2TX	-
5190MHz	10
5230MHz	10
5755MHz	19.5
5795MHz	19.75
802.11ax HEW80-BF_Nss1,(MCS0)_2TX	-
5210MHz	10
5775MHz	17.25

2.3 The Worst Case Measurement Configuration

The Worst Case Mode for Following Conformance Tests	
Tests Item	AC power-line conducted emissions
Condition	AC power-line conducted measurement for line and neutral
Operating Mode	CTX
1	PoE mode (Non-Beamforming_Sample 1_Radio 1)
2	PoE mode (Non-Beamforming_Sample 1_Radio 2)
3	PoE mode (Non-Beamforming_Sample 2_Radio 1)
4	PoE mode (Non-Beamforming_Sample 2_Radio 2)
5	PoE mode (Beamforming_Sample 1_Radio 1)
6	PoE mode (Beamforming_Sample 1_Radio 2)
7	PoE mode (Beamforming_Sample 2_Radio 1)
8	PoE mode (Beamforming_Sample 2_Radio 2)

The Worst Case Mode for Following Conformance Tests	
Tests Item	Emission Bandwidth Maximum Conducted Output Power Peak Power Spectral Density
Test Condition	Conducted measurement at transmit chains

The Worst Case Mode for Following Conformance Tests	
Tests Item	Unwanted Emissions
Test Condition	Radiated measurement If EUT consist of multiple antenna assembly (multiple antenna are used in EUT regardless of spatial multiplexing MIMO configuration), the radiated test should be performed with highest antenna gain of each antenna type.
Operating Mode < 1GHz	CTX
1	PoE mode (Non-Beamforming_Sample 1_Radio 1_1T1S)
2	PoE mode (Non-Beamforming_Sample 1_Radio 1_2T2S)
3	PoE mode (Non-Beamforming_Sample 1_Radio 2_1T1S)
4	PoE mode (Non-Beamforming_Sample 1_Radio 2_2T2S)
5	PoE mode (Non-Beamforming_Sample 2_Radio 1_Omni_1T1S)
6	PoE mode (Non-Beamforming_Sample 2_Radio 1_Omni_2T2S)
7	PoE mode (Non-Beamforming_Sample 2_Radio 1_Panel 1_1T1S)
8	PoE mode (Non-Beamforming_Sample 2_Radio 1_Panel 1_2T2S)
9	PoE mode (Non-Beamforming_Sample 2_Radio 2_Omni_1T1S)
10	PoE mode (Non-Beamforming_Sample 2_Radio 2_Omni_2T2S)

11	PoE mode (Non-Beamforming_Sample 2_Radio 2_Panel 1_1T1S)		
12	PoE mode (Non-Beamforming_Sample 2_Radio 2_Panel 1_2T2S)		
13	PoE mode (Beamforming_Sample 1_Radio 1_2T1S)		
14	PoE mode (Beamforming_Sample 1_Radio 2_2T1S)		
15	PoE mode (Beamforming_Sample 2_Radio 1_Omni_2T1S)		
16	PoE mode (Beamforming_Sample 2_Radio 1_Panel 1_2T1S)		
17	PoE mode (Beamforming_Sample 2_Radio 2_Omni_2T1S)		
18	PoE mode (Beamforming_Sample 2_Radio 2_Panel 1_2T1S)		
Operating Mode > 1GHz	CTX		
Orthogonal Planes of EUT	X Plane	Y Plane	Z Plane
			
Worst Planes of EUT	V (Sample 2_Panel 1)	V (Sample 1,Sample 2_Omni)	

The Worst Case Mode for Following Conformance Tests	
Tests Item	Simultaneous Transmission Analysis
Operating Mode	CTX
1	Radio 1(WLAN 2.4GHz)+Radio 2(WLAN 5GHz)+Bluetooth
2	Radio 1(WLAN 2.4GHz)+Radio 2(WLAN 5GHz)+Thread
3	Radio 1(WLAN 5GHz)+Radio 2(WLAN 5GHz)+Bluetooth
4	Radio 1(WLAN 5GHz)+Radio 2(WLAN 5GHz)+Thread
Refer to Sporton Test Report No.: FA992618 for Co-location RF Exposure Evaluation.	

2.4 Support Equipment

Support Equipment – AC Conduction (Non- Beamforming)					
No.	Equipment	Brand Name	Model Name	FCC ID	Remark
1	RJ45 Cable	Power Sync	CAT-6E-10	-	-
2	PoE	EnGenius	EPA5006GP	-	-
3	AC Power Cable	Power sync	PW-GPC180-3	-	-

Note 1: Support equipment No. 2 was provided by customer.

Support Equipment – AC Conduction (Beamforming)					
No.	Equipment	Brand Name	Model Name	FCC ID	Remark
1	RJ45 Cable	Power Sync	CAT-6E-01	-	-
2	PoE	EnGenius	EPA5006GP	-	-
3	AC Power Cable	Power sync	PW-GPC180-3	-	-
4	PoE	EnGenius	EPA5006GP	-	Remote
5	AC Power Cable	-	-	-	Remote
6	Notebook	DELL	PP13S	-	Remote
7	RJ45 Cable	Power Sync	CAT-6E-01	-	Remote
8	Adapter for NB	DELL	AA90PM111	-	Remote
9	AC Power Cable for NB	Power sync	PW-GPC180-3	-	Remote

Note 1: Support equipment No. 2, 4, 5 was provided by customer.

Support Equipment – Conducted					
No.	Equipment	Brand Name	Model Name	FCC ID	Remark
1	Notebook	DELL	PP13S	DoC	-
2	Adapter for NB	DELL	AA90PM111	DoC	-
3	Notebook	DELL	PP13S	DoC	-
4	Adapter for NB	DELL	AA90PM111	DoC	-
5	PoE	EnGenius	EPA5006GP	-	Note 1

Note 1: Support equipment No. 5 was provided by customer.



Support Equipment – Radiated (Non- Beamforming)					
No.	Equipment	Brand Name	Model Name	FCC ID	Remark
1	RJ45 Cable	Power Sync	CAT-6E-10	-	-

Support Equipment – Radiated (Beamforming)					
No.	Equipment	Brand Name	Model Name	FCC ID	Remark
1	RJ45 Cable	Power Sync	CAT-6E-10	-	-
2	PoE	EnGenius	EPA5006GP	-	Remote
3	PoE	EnGenius	EPA5006GP	-	Remote
4	AC Power Cable	-	-	-	Remote
5	Notebook	Dell	PP13S	-	Remote
6	RJ45 Cable	Power Sync	CAT-6E-01	-	Remote
7	Adapter for NB	Dell	AA90PM111	-	Remote

Note 1: Support equipment No. 2, 3, 4 was provided by customer.

2.5 Test Setup Diagram

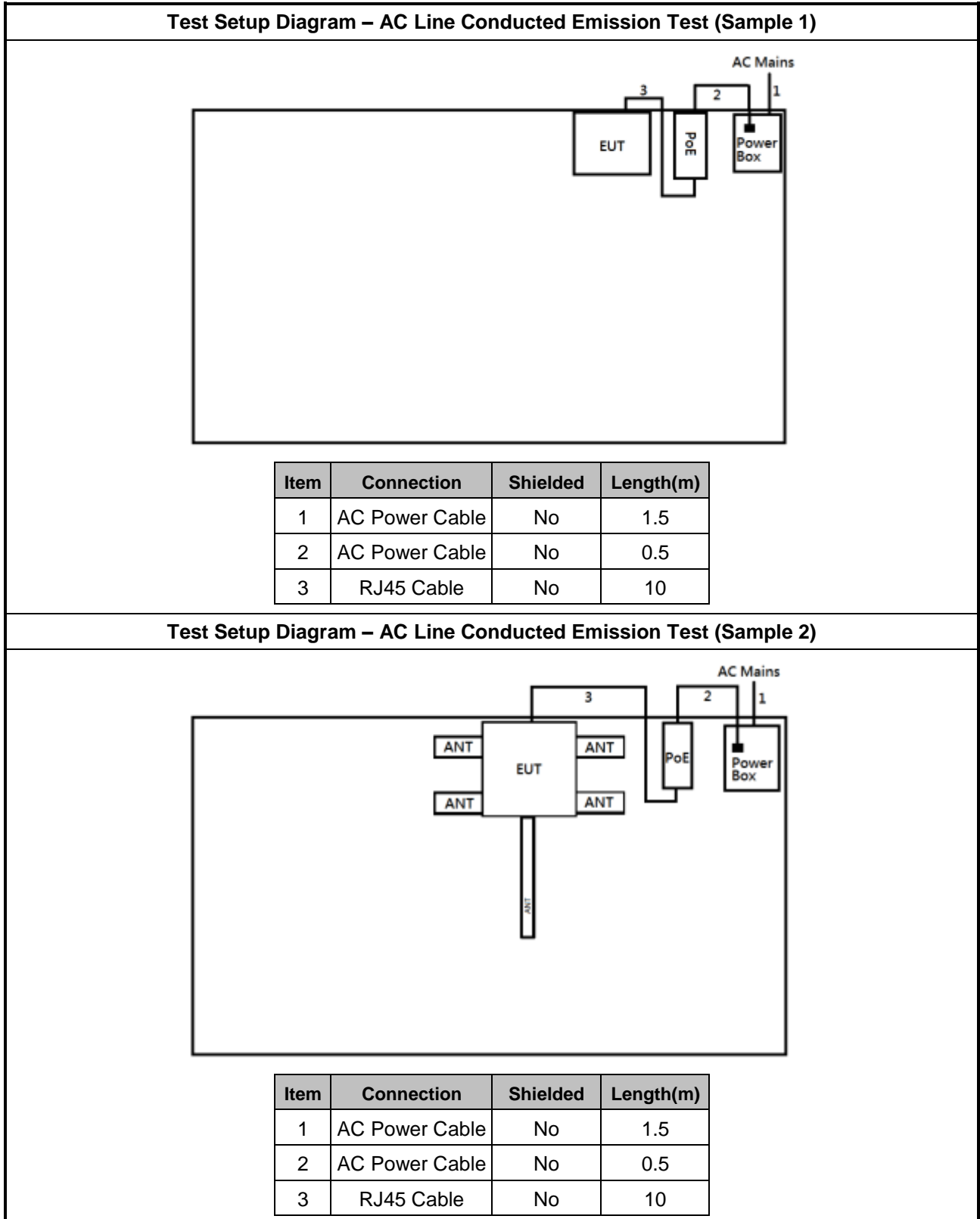

Test Setup Diagram - Radiated Test (Sample 1)

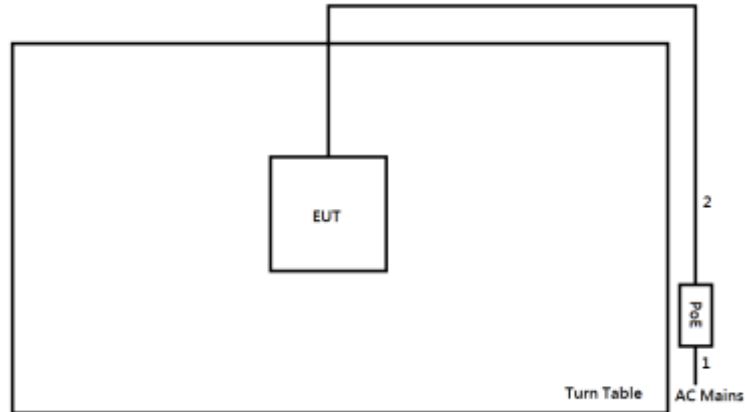

Item	Connection	Shielded	Length(m)
1	AC Power Cable	No	0.5
2	RJ45 Cable	No	10

Test Setup Diagram - Radiated Test (Sample 2_Omni)

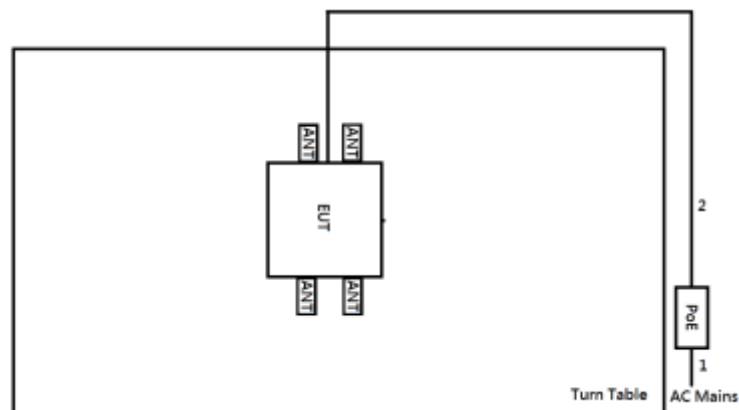

Item	Connection	Shielded	Length(m)
1	AC Power Cable	No	0.5
2	RJ45 Cable	No	10

Test Setup Diagram - Radiated Test (Sample 2_Panel 1)

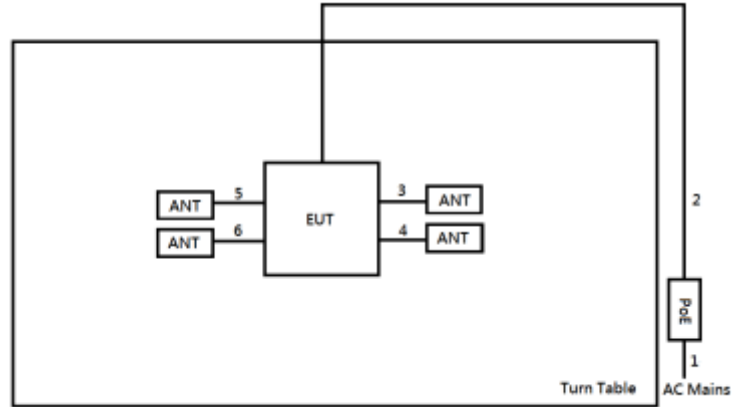

Item	Connection	Shielded	Length(m)
1	AC Power Cable	No	0.5
2	RJ45 Cable	No	10
3	Antenna Cable	No	0.3
4	Antenna Cable	No	0.3
5	Antenna Cable	No	0.3
6	Antenna Cable	No	0.3



3 Transmitter Test Result

3.1 AC Power-line Conducted Emissions

3.1.1 AC Power-line Conducted Emissions Limit

AC Power-line Conducted Emissions Limit		
Frequency Emission (MHz)	Quasi-Peak	Average
0.15-0.5	66 - 56 *	56 - 46 *
0.5-5	56	46
5-30	60	50

Note 1: * Decreases with the logarithm of the frequency.

3.1.2 Measuring Instruments

Refer a test equipment and calibration data table in this test report.

3.1.3 Test Procedures

Test Method
<input checked="" type="checkbox"/> Refer as ANSI C63.10-2013, clause 6.2 for AC power-line conducted emissions.

3.1.4 Test Setup

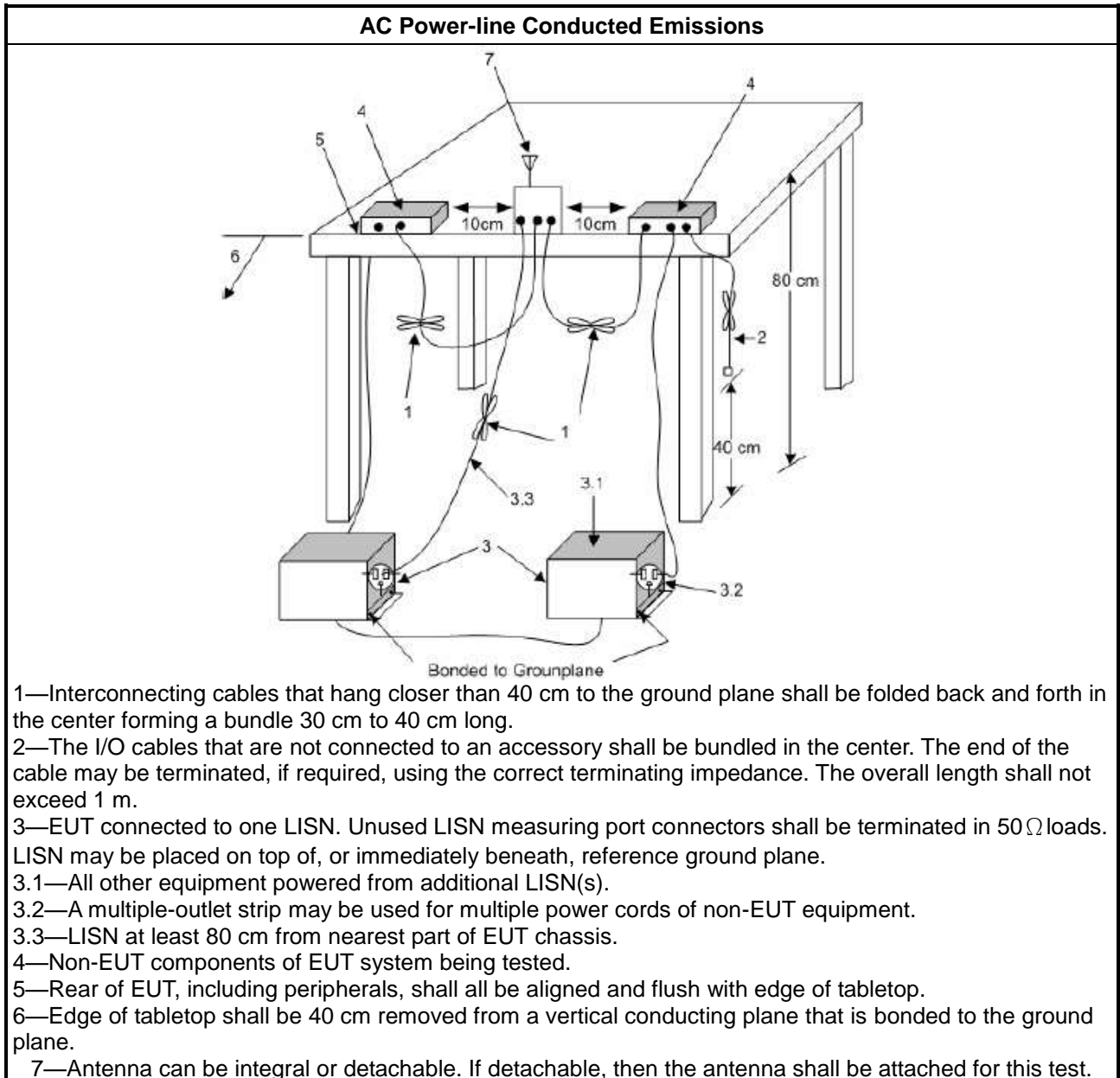

3.1.5 Test Result of AC Power-line Conducted Emissions

Refer as Appendix A

3.2 Emission Bandwidth

3.2.1 Emission Bandwidth Limit

Emission Bandwidth Limit	
UNII Devices	
<input checked="" type="checkbox"/>	For the 5.15-5.25 GHz band, N/A
<input type="checkbox"/>	For the 5.25-5.35 GHz band, N/A
<input type="checkbox"/>	For the 5.47-5.725 GHz band, N/A
<input checked="" type="checkbox"/>	For the 5.725-5.85 GHz band, 6 dB emission bandwidth \geq 500kHz.

3.2.2 Measuring Instruments

Refer a test equipment and calibration data table in this test report.

3.2.3 Test Procedures

Test Method	
<ul style="list-style-type: none"> ▪ For the emission bandwidth shall be measured using one of the options below: 	
<input checked="" type="checkbox"/>	Refer as KDB 789033, clause C for EBW and clause D for OBW measurement.
<input type="checkbox"/>	Refer as ANSI C63.10, clause 6.9.3 for occupied bandwidth testing.
<input type="checkbox"/>	Refer as IC RSS-Gen, clause 6.7 for bandwidth testing.

3.2.4 Test Setup

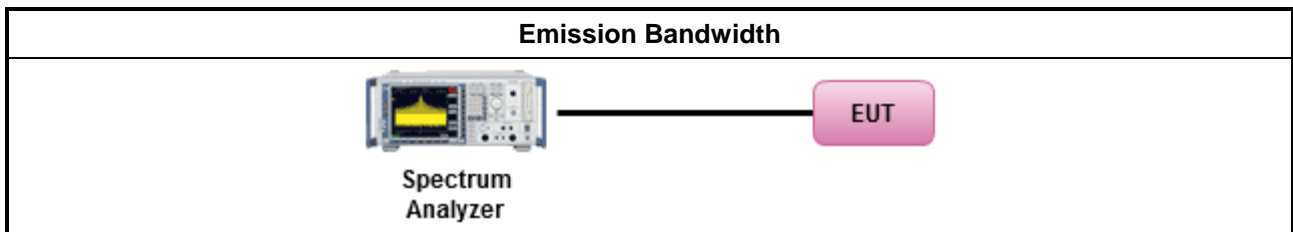

3.2.5 Test Result of Emission Bandwidth

Refer as Appendix B

3.3 Maximum Conducted Output Power

3.3.1 Maximum Conducted Output Power Limit

Maximum Conducted Output Power Limit	
UNII Devices	
<input checked="" type="checkbox"/> For the 5.15-5.25 GHz band:	
	<ul style="list-style-type: none"> ▪ Outdoor AP: the maximum conducted output power (P_{Out}) shall not exceed the lesser of 1 W. If $G_{TX} > 6$ dBi, then $P_{Out} = 30 - (G_{TX} - 6)$. e.i.r.p. at any elevation angle above 30 degrees $\leq 125mW$ [21dBm] ▪ Indoor AP: the maximum conducted output power (P_{Out}) shall not exceed the lesser of 1 W. If $G_{TX} > 6$ dBi, then $P_{Out} = 30 - (G_{TX} - 6)$ ▪ Point-to-point AP: the maximum conducted output power (P_{Out}) shall not exceed the lesser of 1 W. If $G_{TX} > 23$ dBi, then $P_{Out} = 30 - (G_{TX} - 23)$. ▪ Mobile or Portable Client: the maximum conducted output power (P_{Out}) shall not exceed the lesser of 250 mW. If $G_{TX} > 6$ dBi, then $P_{Out} = 24 - (G_{TX} - 6)$.
<input type="checkbox"/> For the 5.25-5.35 GHz band, the maximum conducted output power (P_{Out}) shall not exceed the lesser of 250 mW or 11 dBm + 10 log B, where B is the 26 dB emission bandwidth in MHz. If $G_{TX} > 6$ dBi, then $P_{Out} = 24 - (G_{TX} - 6)$.	
<input type="checkbox"/> For the 5.47-5.725 GHz band, the maximum conducted output power (P_{Out}) shall not exceed the lesser of 250 mW or 11 dBm + 10 log B, where B is the 26 dB emission bandwidth in MHz. If $G_{TX} > 6$ dBi, then $P_{Out} = 24 - (G_{TX} - 6)$.	
<input checked="" type="checkbox"/> For the 5.725-5.85 GHz band:	
	<ul style="list-style-type: none"> ▪ Point-to-multipoint systems (P2M): the maximum conducted output power (P_{Out}) shall not exceed the lesser of 1 W. If $G_{TX} > 6$ dBi, then $P_{Out} = 30 - (G_{TX} - 6)$. ▪ Point-to-point systems (P2P): the maximum conducted output power (P_{Out}) shall not exceed the lesser of 1 W.
P_{Out} = maximum conducted output power in dBm, G_{TX} = the maximum transmitting antenna directional gain in dBi.	

3.3.2 Measuring Instruments

Refer a test equipment and calibration data table in this test report.

3.3.3 Test Procedures

Test Method	
<ul style="list-style-type: none"> Maximum Conducted Output Power 	
	Duty cycle $\geq 98\%$
<input type="checkbox"/>	Refer as KDB 789033, clause E Method SA-2 (spectral trace averaging).
	Duty cycle $< 98\%$
<input type="checkbox"/>	Refer as KDB 789033, clause E Method SA-2 Alt. (RMS detection with slow sweep speed)
	Wideband RF power meter and average over on/off periods with duty factor
<input checked="" type="checkbox"/>	Refer as KDB 789033, clause E Method PM (using an RF average power meter).
<ul style="list-style-type: none"> For conducted measurement. 	
	<ul style="list-style-type: none"> If the EUT supports multiple transmit chains using options given below: Refer as KDB 662911, In-band power measurements. Using the measure-and-sum approach, measured all transmit ports individually. Sum the power (in linear power units e.g., mW) of all ports for each individual sample and save them.
	<ul style="list-style-type: none"> If multiple transmit chains, EIRP calculation could be following as methods: $P_{total} = P_1 + P_2 + \dots + P_n$ (calculated in linear unit [mW] and transfer to log unit [dBm]) $EIRP_{total} = P_{total} + DG$

3.3.4 Test Setup

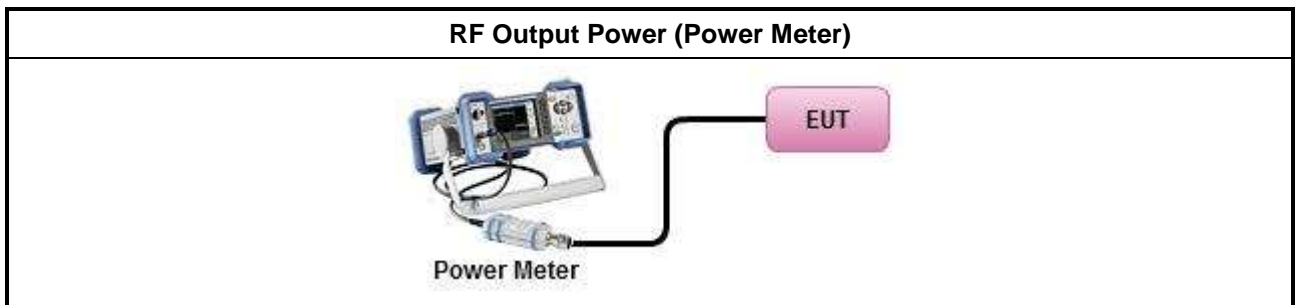

3.3.5 Test Result of Maximum Conducted Output Power

Refer as Appendix C

3.4 Peak Power Spectral Density

3.4.1 Peak Power Spectral Density Limit

Peak Power Spectral Density Limit	
UNII Devices	
<input checked="" type="checkbox"/> For the 5.15-5.25 GHz band:	
	<ul style="list-style-type: none"> ▪ Outdoor AP: the peak power spectral density (PPSD) shall not exceed the lesser of 17dBm/MHz. If $G_{TX} > 6$ dBi, then $P_{Out} = 17 - (G_{TX} - 6)$. ▪ Indoor AP: the peak power spectral density (PPSD) shall not exceed the lesser of 17dBm/MHz. If $G_{TX} > 6$ dBi, then $P_{Out} = 17 - (G_{TX} - 6)$. ▪ Point-to-point AP: the peak power spectral density (PPSD) shall not exceed the lesser of 17dBm/MHz. If $G_{TX} > 23$ dBi, then $P_{Out} = 17 - (G_{TX} - 23)$. ▪ Mobile or Portable Client: the peak power spectral density (PPSD) ≤ 11 dBm/MHz. If $G_{TX} > 6$ dBi, then $PPSD = 11 - (G_{TX} - 6)$.
<input type="checkbox"/> For the 5.25-5.35 GHz band, the peak power spectral density (PPSD) ≤ 11 dBm/MHz. If $G_{TX} > 6$ dBi, then $PPSD = 11 - (G_{TX} - 6)$.	
<input type="checkbox"/> For the 5.47-5.725 GHz band, the peak power spectral density (PPSD) ≤ 11 dBm/MHz. If $G_{TX} > 6$ dBi, then $PPSD = 11 - (G_{TX} - 6)$.	
<input checked="" type="checkbox"/> For the 5.725-5.85 GHz band:	
	<ul style="list-style-type: none"> ▪ Point-to-multipoint systems (P2M): the peak power spectral density (PPSD) ≤ 30 dBm/500kHz. If $G_{TX} > 6$ dBi, then $PPSD = 30 - (G_{TX} - 6)$. ▪ Point-to-point systems (P2P): the peak power spectral density (PPSD) ≤ 30 dBm/500kHz.
<p>PPSD = peak power spectral density that he same method as used to determine the conducted output power shall be used to determine the power spectral density. And power spectral density in dBm/MHz</p> <p>G_{TX} = the maximum transmitting antenna directional gain in dBi.</p>	

3.4.2 Measuring Instruments

Refer a test equipment and calibration data table in this test report.

3.4.3 Test Procedures

Test Method	
<ul style="list-style-type: none"> ▪ Peak power spectral density procedures that the same method as used to determine the conducted output power shall be used to determine the peak power spectral density and use the peak search function on the spectrum analyzer to find the peak of the spectrum. For the peak power spectral density shall be measured using below options: 	
<input type="checkbox"/>	Refer as KDB 789033, F)5) power spectral density can be measured using resolution bandwidths < 1 MHz provided that the results are integrated over 1 MHz bandwidth
Duty cycle ≥ 98%	
<input checked="" type="checkbox"/>	Refer as KDB 789033, clause E Method SA-2 (spectral trace averaging).
Duty cycle < 98%	
<input checked="" type="checkbox"/>	Refer as KDB 789033, clause E Method SA-2 Alt. (RMS detection with slow sweep speed)
<ul style="list-style-type: none"> ▪ For conducted measurement. 	
<ul style="list-style-type: none"> ▪ If the EUT supports multiple transmit chains using options given below: <ul style="list-style-type: none"> ▪ Measure and sum the spectra across the outputs. Refer as KDB 662911, In-band power spectral density (PSD). Sample all transmit ports simultaneously using a spectrum analyzer for each transmit port. Where the trace bin-by-bin of each transmit port summing can be performed. (i.e., in the first spectral bin of output 1 is summed with that in the first spectral bin of output 2 and that from the first spectral bin of output 3, and so on up to the NTX output to obtain the value for the first frequency bin of the summed spectrum.). Add up the amplitude (power) values for the different transmit chains and use this as the new data trace. ▪ If multiple transmit chains, EIRP PPSD calculation could be following as methods: $PPSD_{total} = PPSD_1 + PPSD_2 + \dots + PPSD_n$ (calculated in linear unit [mW] and transfer to log unit [dBm]) $EIRP_{total} = PPSD_{total} + DG$ 	

3.4.4 Test Setup

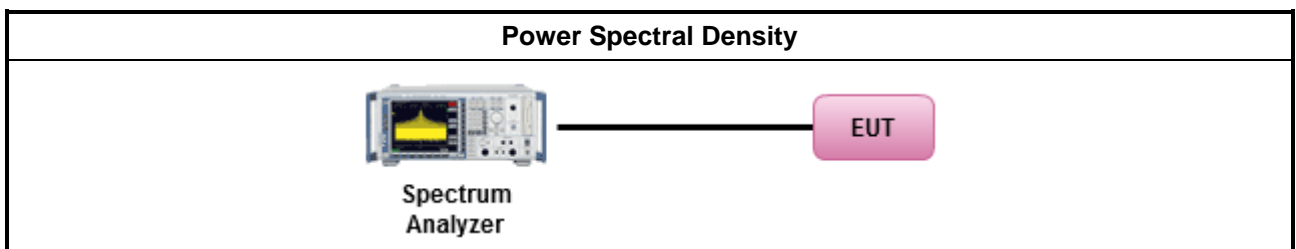

3.4.5 Test Result of Peak Power Spectral Density

Refer as Appendix D

3.5 Unwanted Emissions

3.5.1 Transmitter Radiated Unwanted Emissions Limit

Unwanted emissions below 1 GHz and restricted band emissions above 1GHz limit			
Frequency Range (MHz)	Field Strength (uV/m)	Field Strength (dBuV/m)	Measure Distance (m)
0.009~0.490	2400/F(kHz)	48.5 - 13.8	300
0.490~1.705	24000/F(kHz)	33.8 - 23	30
1.705~30.0	30	29	30
30~88	100	40	3
88~216	150	43.5	3
216~960	200	46	3
Above 960	500	54	3

Note 1: Test distance for frequencies at or above 30 MHz, measurements may be performed at a distance other than the limit distance provided they are not performed in the near field and the emissions to be measured can be detected by the measurement equipment. When performing measurements at a distance other than that specified, the results shall be extrapolated to the specified distance using an extrapolation factor of 20 dB/decade (inverse of linear distance for field-strength measurements, inverse of linear distance-squared for power-density measurements).

Note 2: Test distance for frequencies at below 30 MHz, measurements may be performed at a distance closer than the EUT limit distance; however, an attempt should be made to avoid making measurements in the near field. When performing measurements below 30 MHz at a closer distance than the limit distance, the results shall be extrapolated to the specified distance by either making measurements at a minimum of two or more distances on at least one radial to determine the proper extrapolation factor or by using the square of an inverse linear distance extrapolation factor (40 dB/decade). The test report shall specify the extrapolation method used to determine compliance of the EUT.

Note 3: Using the distance of 1m during the test for above 18 GHz, and the test value to correct for the distance factor at 3m.

Un-restricted band emissions above 1GHz Limit	
Operating Band	Limit
5.15 - 5.25 GHz	e.i.r.p. -27 dBm [68.2 dBuV/m@3m]
5.25 - 5.35 GHz	e.i.r.p. -27 dBm [68.2 dBuV/m@3m]
5.47 - 5.725 GHz	e.i.r.p. -27 dBm [68.2 dBuV/m@3m]
5.725 - 5.85 GHz	5.650-5700 GHz: e.i.r.p. -27 ~ 10 dBm [68.2 ~ 105.2 dBuV/m@3m] 5.700-5720 GHz: e.i.r.p. 10 ~ 15.6 dBm [105.2 ~ 110.8 dBuV/m@3m] 5.720-5725 GHz: e.i.r.p. 15.6 ~ 27 dBm [110.8 ~ 122.2 dBuV/m@3m] 5.850-5.855 GHz: e.i.r.p. 27 ~ 15.6 dBm [122.2 ~ 110.8 dBuV/m@3m] 5.855-5.875 GHz: e.i.r.p. 15.6 ~ 10 dBm [110.8 ~ 105.2 dBuV/m@3m] 5.875-5.925 GHz: e.i.r.p. 10 ~ -27 dBm [105.2 ~ 68.2dBuV/m@3m] Other un-restricted band: e.i.r.p. -27 dBm [68.2 dBuV/m@3m]

Note 1: Measurements may be performed at a distance other than the limit distance provided they are not performed in the near field and the emissions to be measured can be detected by the measurement equipment. When performing measurements at a distance other than that specified, the results shall be extrapolated to the specified distance using an extrapolation factor of 20 dB/decade (inverse of linear distance for field-strength measurements, inverse of linear distance-squared for power-density measurements).

3.5.2 Measuring Instruments

Refer a test equipment and calibration data table in this test report.

3.5.3 Test Procedures

Test Method	
<ul style="list-style-type: none"> ▪ Measurements may be performed at a distance other than the limit distance provided they are not performed in the near field and the emissions to be measured can be detected by the measurement equipment. Measurements shall not be performed at a distance greater than 30 m for frequencies above 30 MHz, unless it can be further demonstrated that measurements at a distance of 30 m or less are impractical. When performing measurements at a distance other than that specified, the results shall be extrapolated to the specified distance using an extrapolation factor of 20 dB/decade (inverse of linear distance for field-strength measurements, inverse of linear distance-squared for power-density measurements). 	
<ul style="list-style-type: none"> ▪ The average emission levels shall be measured in [duty cycle \geq 98 or duty factor]. 	
<ul style="list-style-type: none"> ▪ For the transmitter unwanted emissions shall be measured using following options below: 	
	<ul style="list-style-type: none"> ▪ Refer as KDB 789033, clause G)2) for unwanted emissions into non-restricted bands.
	<ul style="list-style-type: none"> ▪ Refer as KDB 789033, clause G)1) for unwanted emissions into restricted bands.
<input checked="" type="checkbox"/>	Refer as KDB 789033, G)6) Method VB (ANSI C63.10, clause 4.1.4.2.3), Reduced VBW.
<input checked="" type="checkbox"/>	Refer as KDB 789033, clause G)5) (ANSI C63.10, clause 4.1.4.2.2), measurement procedure peak limit.
<ul style="list-style-type: none"> ▪ For radiated measurement. 	
	<ul style="list-style-type: none"> ▪ Refer as ANSI C63.10, clause 6.4 for radiated emissions below 30 MHz and test distance is 3m.
	<ul style="list-style-type: none"> ▪ Refer as ANSI C63.10, clause 6.5 for radiated emissions 30 MHz to 1 GHz and test distance is 3m.
	<ul style="list-style-type: none"> ▪ Refer as ANSI C63.10, clause 6.6 for radiated emissions above 1GHz.
<ul style="list-style-type: none"> ▪ The any unwanted emissions level shall not exceed the fundamental emission level. 	
<ul style="list-style-type: none"> ▪ All amplitude of spurious emissions that are attenuated by more than 20 dB below the permissible value has no need to be reported. 	
<ul style="list-style-type: none"> ▪ Use the following spectrum analyzer settings: 	
	<ul style="list-style-type: none"> ▪ Set RBW=100 kHz for $f < 1$ GHz; VBW=3 * RBW; Sweep = auto; Detector function = peak; Trace = max hold.
	<ul style="list-style-type: none"> ▪ Set RBW = 1 MHz, VBW= 3MHz for $f \geq 1$ GHz for peak measurement. For average measurement, refer as 1.1.4.
<ul style="list-style-type: none"> ▪ KDB 414788 Open-Field Test Sites and Chamber Correlation Justification. 	
	<ul style="list-style-type: none"> ▪ Based on FCC 15.31 (f) (2): measurements may be performed at a distance closer than that specified in regulations; however, an attempt should be made to avoid making measurements in the near field.
	<ul style="list-style-type: none"> ▪ Open-field site and chamber correlation testing had been performed and chamber measured test result is the worst case test result.

3.5.4 Test Setup

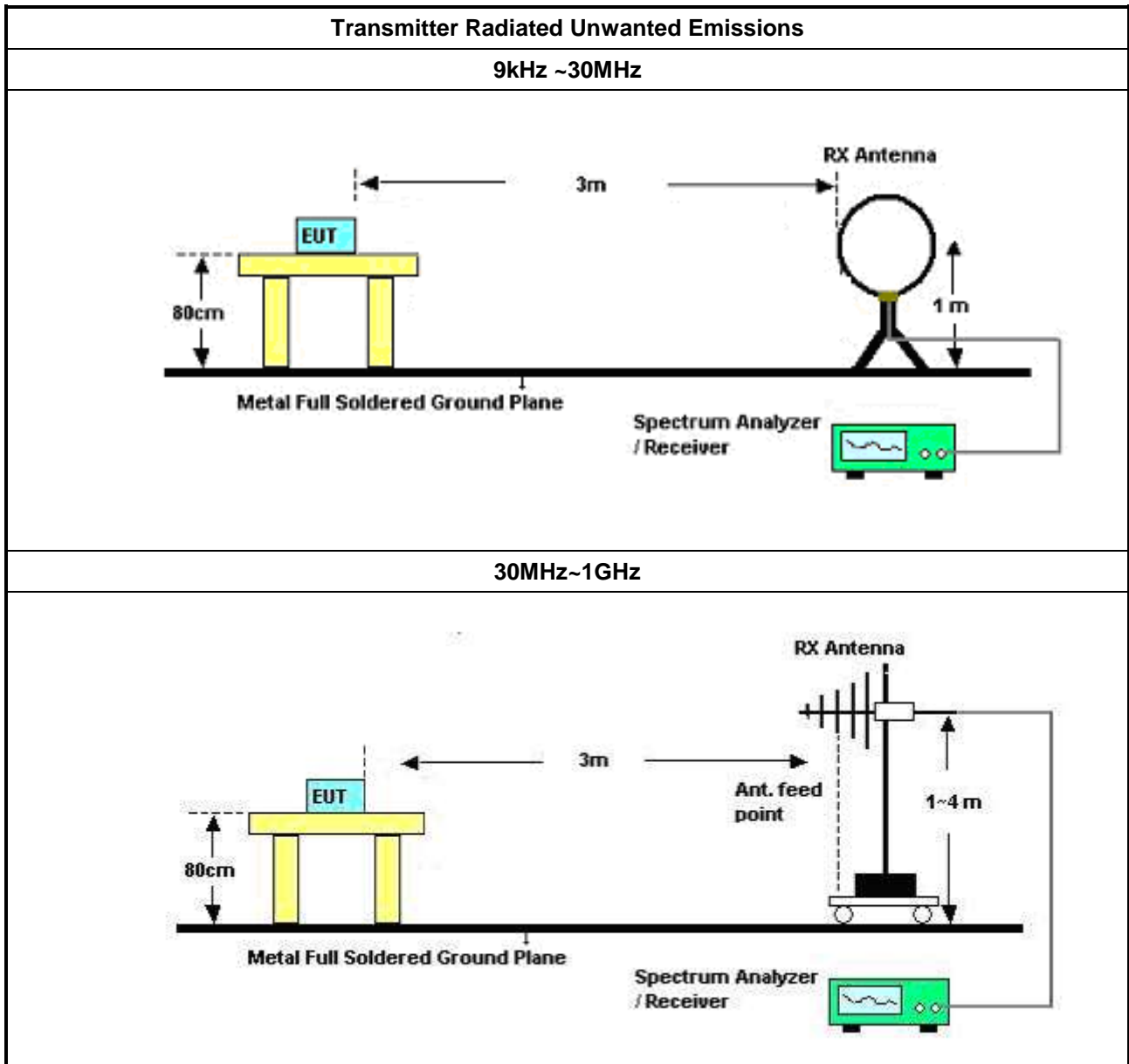

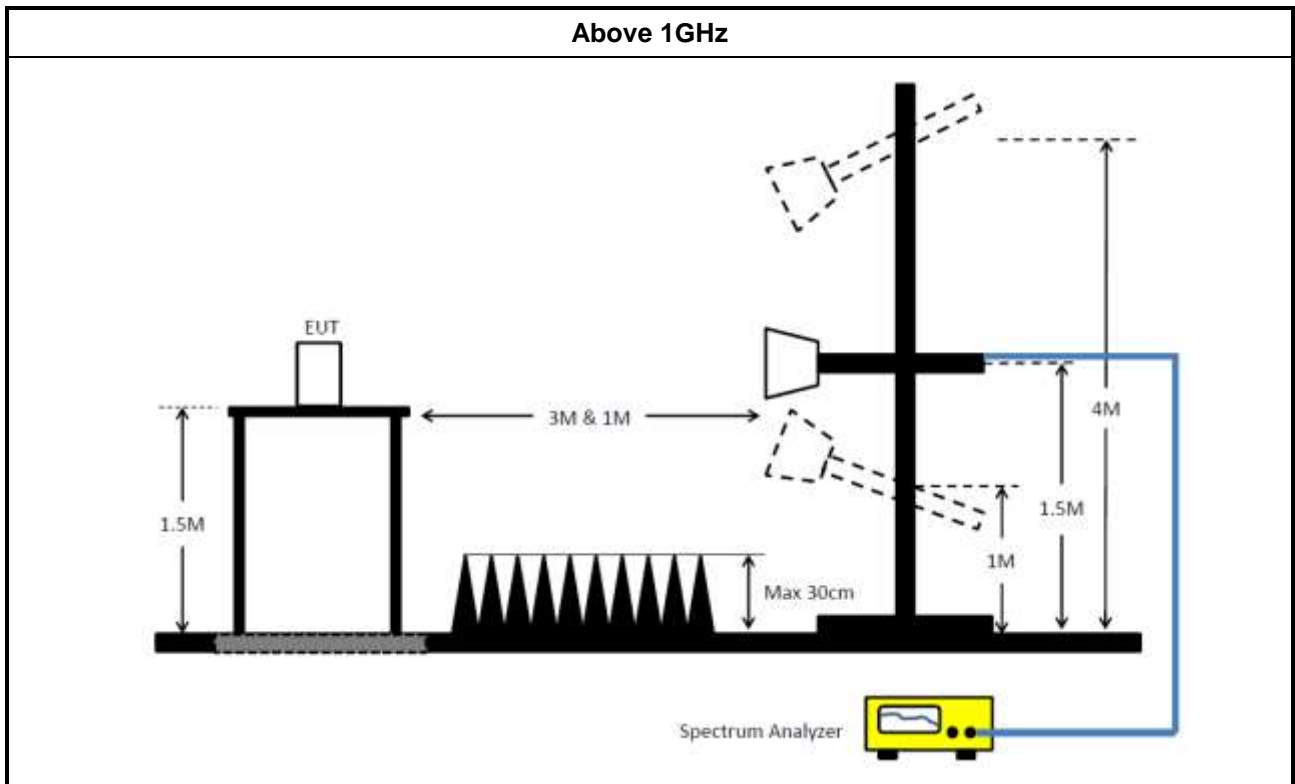

3.5.5 Transmitter Unwanted Emissions (Below 30MHz)

The amplitude of spurious emissions which are attenuated by more than 20dB below the permissible value has no need to be reported.

3.5.6 Test Result of Transmitter Unwanted Emissions

Refer as Appendix E

4 Test Equipment and Calibration Data

Instrument for AC Conduction

Instrument	Manufacturer	Model No.	Serial No.	Spec.	Calibration Date	Calibration Due Date
EMC Receiver	R&S	ESR3	102052	9kHz ~ 3.6GHz	09/Apr/2019	08/Apr/2020
LISN	R&S	ENV216	101295	9kHz ~ 30MHz	04/Nov/2019	05/Nov/2020
RF Cable-CON	MTJ	RG142	CB002-CO	9kHz ~ 200MHz	12/Sep/2019	11/Sep/2020
AC POWER	APC	AFC-11005G	F310050055	47Hz~63Hz 5~300V	NCR	NCR
Impuls Begrenzer Pulse Limiter	SCHWARZBECK	VTSD 9561-F	9561-F041	9 kHz ~ 30 MHz	24/Sep/2019	23/Sep/2020

NCR : Non-Calibration Require

Instrument for Conducted Test

Instrument	Manufacturer	Model No.	Serial No.	Spec.	Calibration Date	Calibration Due Date
Spectrum Analyzer	R&S	FSV 40	101013	10Hz~40GHz	13/Mar/2019	12/Mar/2020
Pulse Power Sensor	Anritsu	MA2411B	1027452	300MHz ~ 40GHz	14/Mar/2019	13/Mar/2020
Power Meter	Anritsu	ML2495A	1124009	300MHz ~ 40GHz	14/Mar/2019	13/Mar/2020
SMB100A Signal Generator	R&S	SMB100A03	181147	100kHz~40GHz	12/Nov/2018	10/Nov/2020

Instrument for Radiated Test

Instrument	Manufacturer	Model No.	Serial No.	Spec.	Calibration Date	Calibration Due Date
3m Semi Anechoic Chamber	SIDT FRANKONIA	SAC-3M	03CH02-HY	30MHz ~ 1GHz 3m	29/Aug/2019	28/Aug/2020
3m Semi Anechoic Chamber	SIDT FRANKONIA	SAC-3M	03CH02-HY	1GHz ~ 18GHz 3m	29/Aug/2019	28/Aug/2020
Amplifier	Agilent	8447D	2944A11149	100kHz ~ 1.3GHz	02/Jul/2019	01/Jul/2020
Microwave Preamplifier	Agilent	8449B	3008A02373	1GHz ~ 26.5GHz	16/Oct/2019	15/Oct/2020
Signal Analyzer	R&S	FSV40	101500	10Hz ~ 40 GHz	15/ Aug/2019	14/ Aug /2020
EMI Test Receiver	R&S	ESR3	102052	9kHz ~ 3.6GHz	09/Apr/2019	08/Apr/2020
RF Cable-R03m	Jye Bao	RG142	CB017	9kHz ~ 1GHz	26/Mar/2019	25/Mar/2020
RF Cable-high 6m	SUHNER	SUCOFLEX104	10567868 / SN805193/4	1GHz~40GHz	09/Apr/2019	08/Apr/2020
RF Cable-high 7m	SUHNER	SUCOFLEX104	10567868 / SN805192/4	1GHz~40GHz	09/Apr/2019	08/Apr/2020
Bilog Antenna & 5dB Attenuator	SCHAFFNER / MTJ	CBL 6112B / MTJ6102-05	2723 / 2	30MHz ~ 1GHz	11/Oct/2019	10/Oct/2020
Broadband Horn Antenna	SCHWARZBECK	BBHA 9170	BBHA9170339	18GHz ~ 40GHz	19/Apr/2019	18/Apr/2020
Preamplifier	MITEQ	TTA1840-35-HG	1864481	18GHz ~ 40GHz	05/Aug/2019	04/Aug/2020
Double Ridged Guide Horn Antenna	SCHWARZBECK	BBHA 9120 D	BBHA 9120 D 01543	1GHz ~ 18GHz	03/Jun/2019	02/Jun/2020



AC Power-line Conducted Emissions_ Non Beamforming_Sample 1_Radio1

Appendix A.1

AC Power-line Conducted Emissions Result

Operating Mode	1	Power Phase	Neutral
Operating Function	Non Beamforming ; Sample 1 ; PoE mode ; Radio1 WIFI 5G TX		

07/03/2020

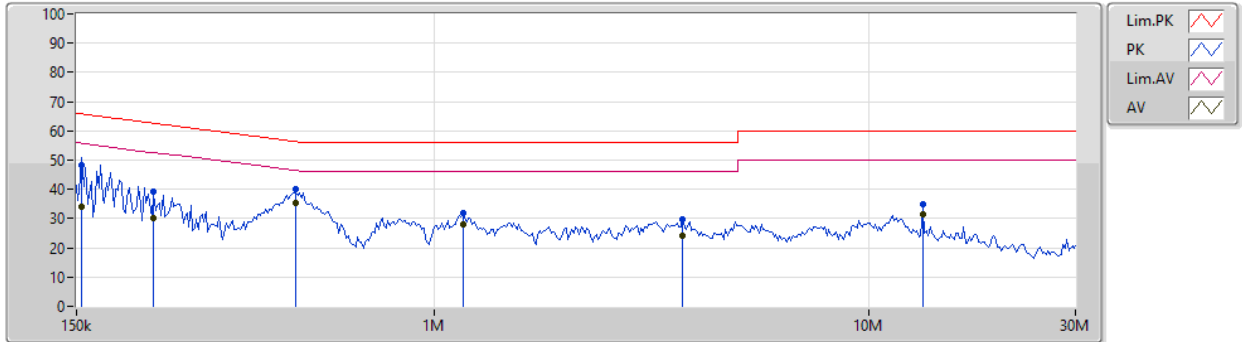

Type	Freq (Hz)	Level (dBuV)	Limit (dBuV)	Margin (dB)	Factor (dB)	Condition	Comment	Raw (dBuV)	LISN (dB)	CL (dB)	AT (dB)
QP	154.545k	48.12	65.75	-17.63	19.63	Neutral	-	28.49	9.65	0.11	9.87
AV	154.545k	33.89	55.75	-21.86	19.63	Neutral	-	14.26	9.65	0.11	9.87
QP	225.563k	39.03	62.62	-23.59	19.63	Neutral	-	19.40	9.64	0.12	9.87
AV	225.563k	30.14	52.62	-22.48	19.63	Neutral	-	10.51	9.64	0.12	9.87
QP	480.498k	40.02	56.33	-16.31	19.63	Neutral	-	20.39	9.63	0.13	9.87
AV	480.498k	35.46	46.33	-10.87	19.63	Neutral	"Worst"	15.83	9.63	0.13	9.87
QP	1.165M	31.78	56.00	-24.22	19.63	Neutral	-	12.15	9.63	0.12	9.88
AV	1.165M	28.12	46.00	-17.88	19.63	Neutral	-	8.49	9.63	0.12	9.88
QP	3.732M	29.72	56.00	-26.28	19.72	Neutral	-	10.00	9.66	0.18	9.88
AV	3.732M	24.22	46.00	-21.78	19.72	Neutral	-	4.50	9.66	0.18	9.88
QP	13.336M	34.75	60.00	-25.25	19.89	Neutral	-	14.86	9.71	0.30	9.88
AV	13.336M	31.61	50.00	-18.39	19.89	Neutral	-	11.72	9.71	0.30	9.88



AC Power-line Conducted Emissions_
Non Beamforming_Sample 1_Radio1

Appendix A.1

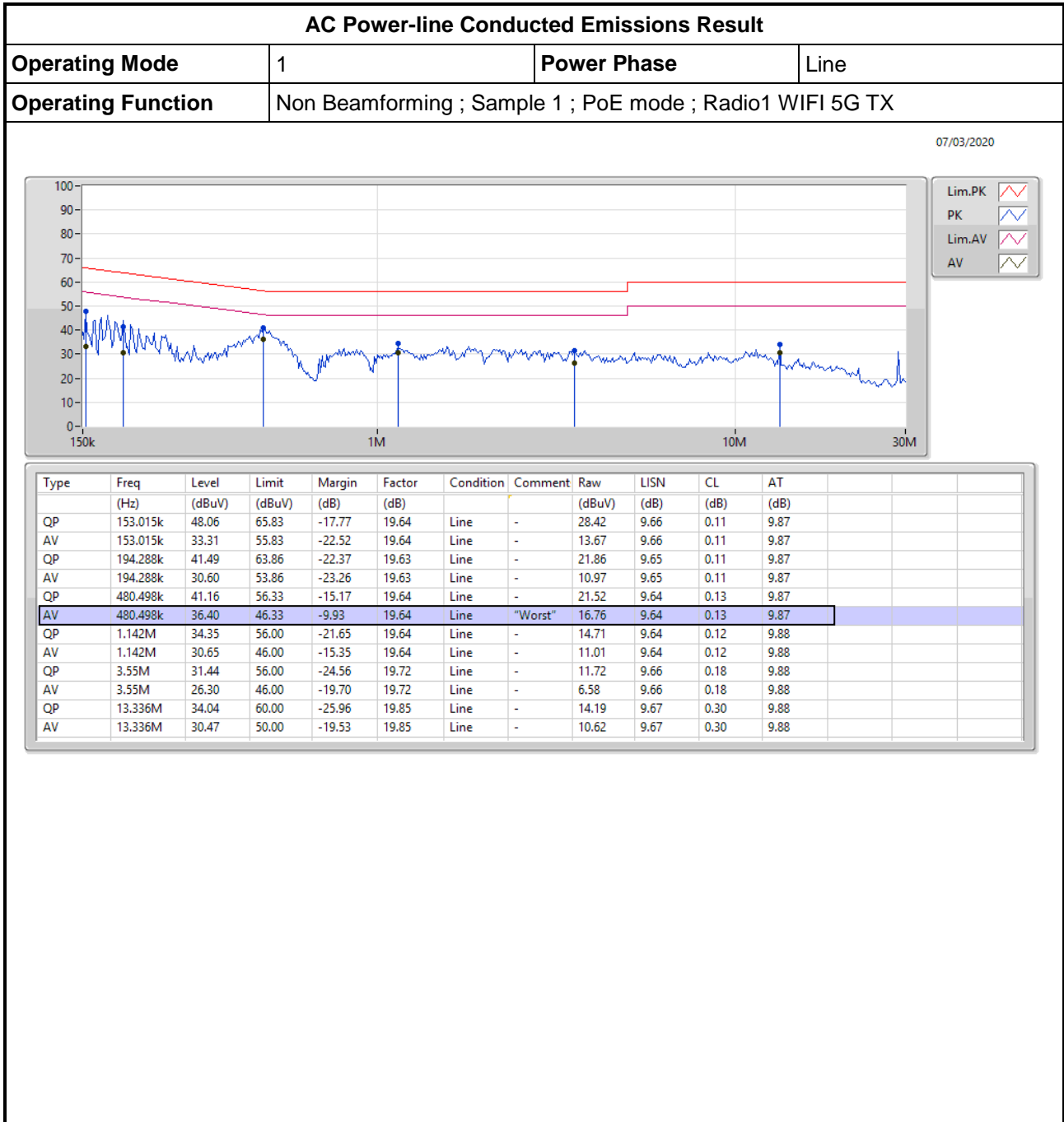



AC Power-line Conducted Emissions_ Non Beamforming_Sample 1_Radio2

Appendix A.2

AC Power-line Conducted Emissions Result

Operating Mode	2	Power Phase	Neutral
Operating Function	Non Beamforming ; Sample 1 ; PoE mode ; Radio2 WIFI 5G TX		

07/03/2020

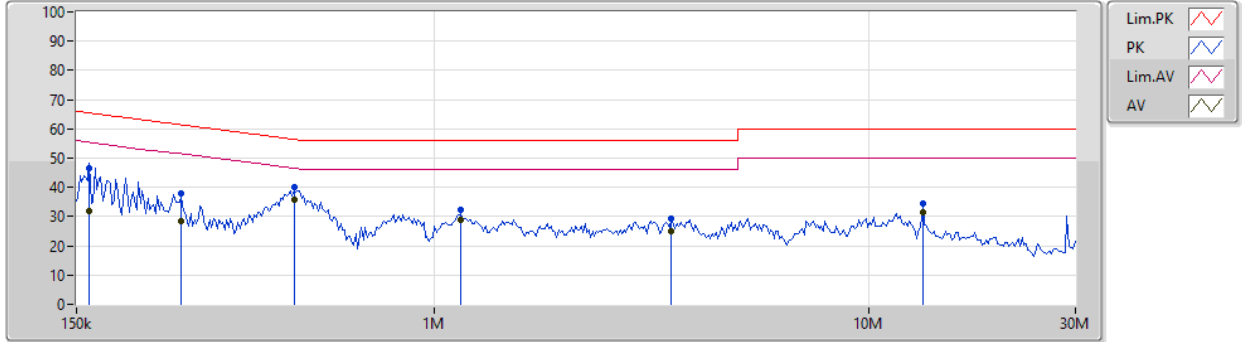

Type	Freq (Hz)	Level (dBuV)	Limit (dBuV)	Margin (dB)	Factor (dB)	Condition	Comment	Raw (dBuV)	LISN (dB)	CL (dB)	AT (dB)
QP	160.82k	46.39	65.43	-19.04	19.63	Neutral	-	26.76	9.65	0.11	9.87
AV	160.82k	31.74	55.43	-23.69	19.63	Neutral	-	12.11	9.65	0.11	9.87
QP	261.871k	38.03	61.37	-23.34	19.63	Neutral	-	18.40	9.64	0.12	9.87
AV	261.871k	28.33	51.37	-23.04	19.63	Neutral	-	8.70	9.64	0.12	9.87
QP	475.741k	40.13	56.42	-16.29	19.63	Neutral	-	20.50	9.63	0.13	9.87
AV	475.741k	35.67	46.42	-10.75	19.63	Neutral	"Worst"	16.04	9.63	0.13	9.87
QP	1.153M	32.18	56.00	-23.82	19.63	Neutral	-	12.55	9.63	0.12	9.88
AV	1.153M	28.90	46.00	-17.10	19.63	Neutral	-	9.27	9.63	0.12	9.88
QP	3.515M	29.37	56.00	-26.63	19.72	Neutral	-	9.65	9.66	0.18	9.88
AV	3.515M	24.95	46.00	-21.05	19.72	Neutral	-	5.23	9.66	0.18	9.88
QP	13.336M	34.49	60.00	-25.51	19.89	Neutral	-	14.60	9.71	0.30	9.88
AV	13.336M	31.41	50.00	-18.59	19.89	Neutral	-	11.52	9.71	0.30	9.88



AC Power-line Conducted Emissions_ Non Beamforming_Sample 1_Radio2

Appendix A.2

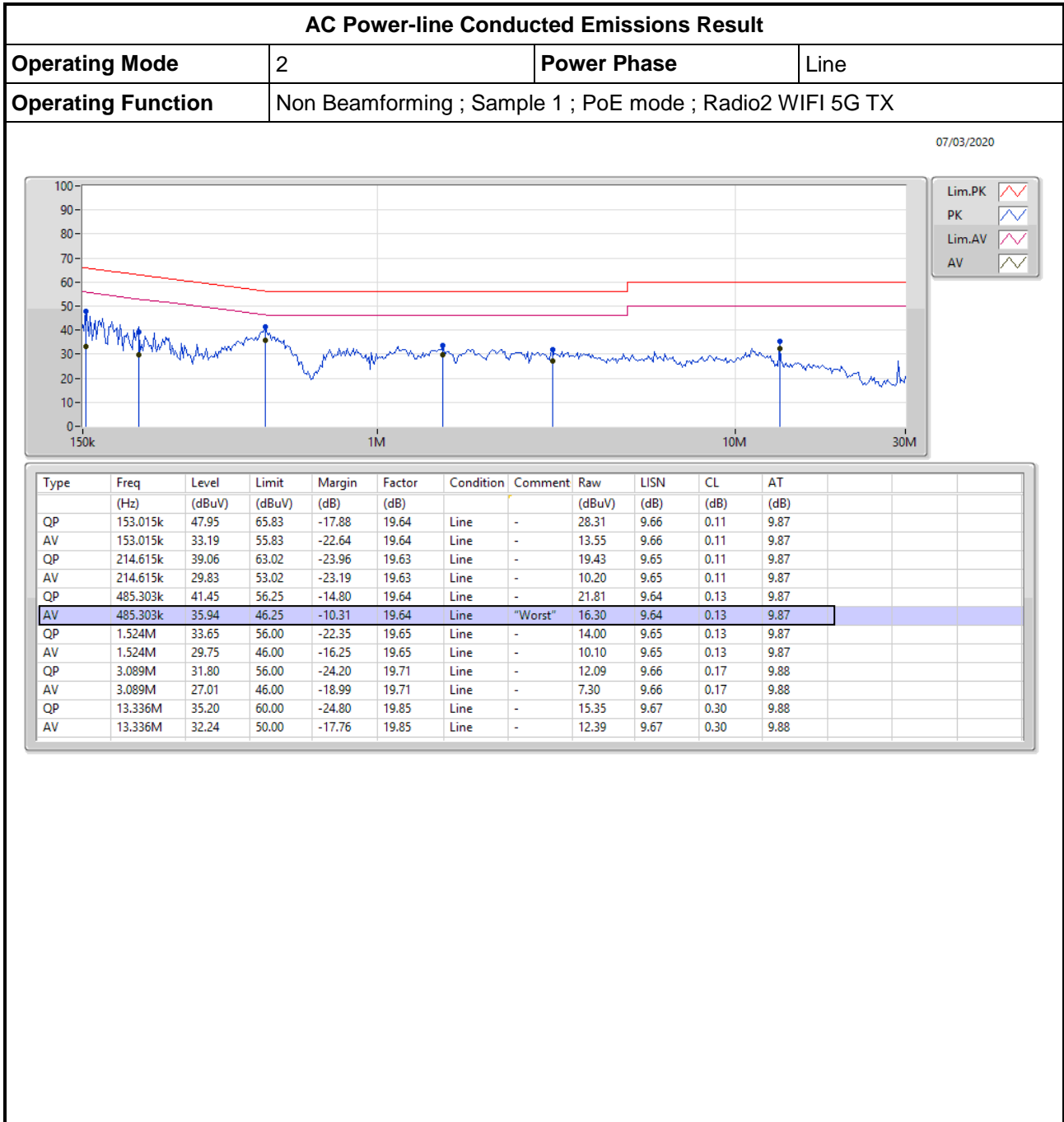



AC Power-line Conducted Emissions_
Non Beamforming_Sample 2_Radio1

Appendix A.3

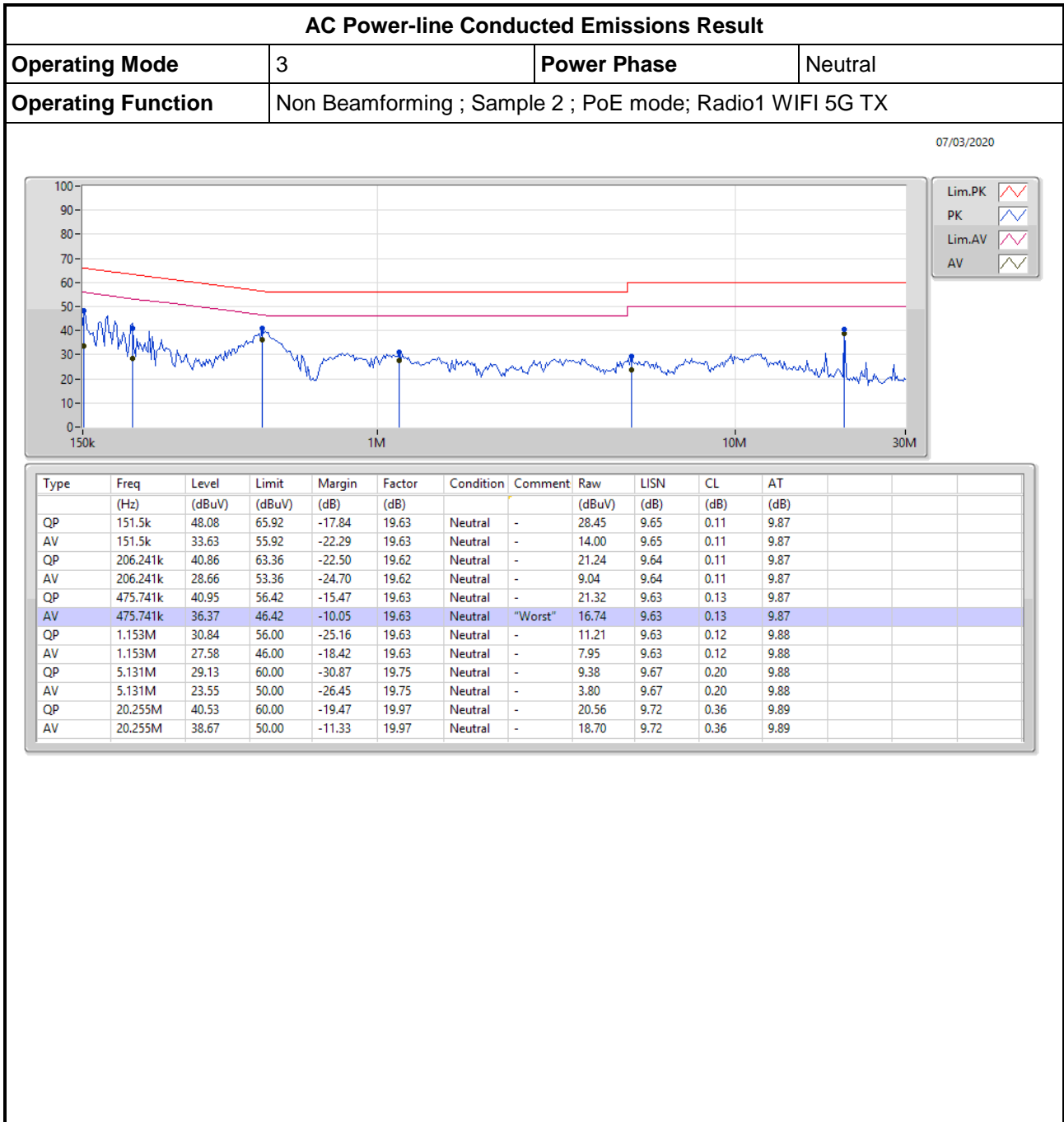



AC Power-line Conducted Emissions_
Non Beamforming_Sample 2_Radio1

Appendix A.3

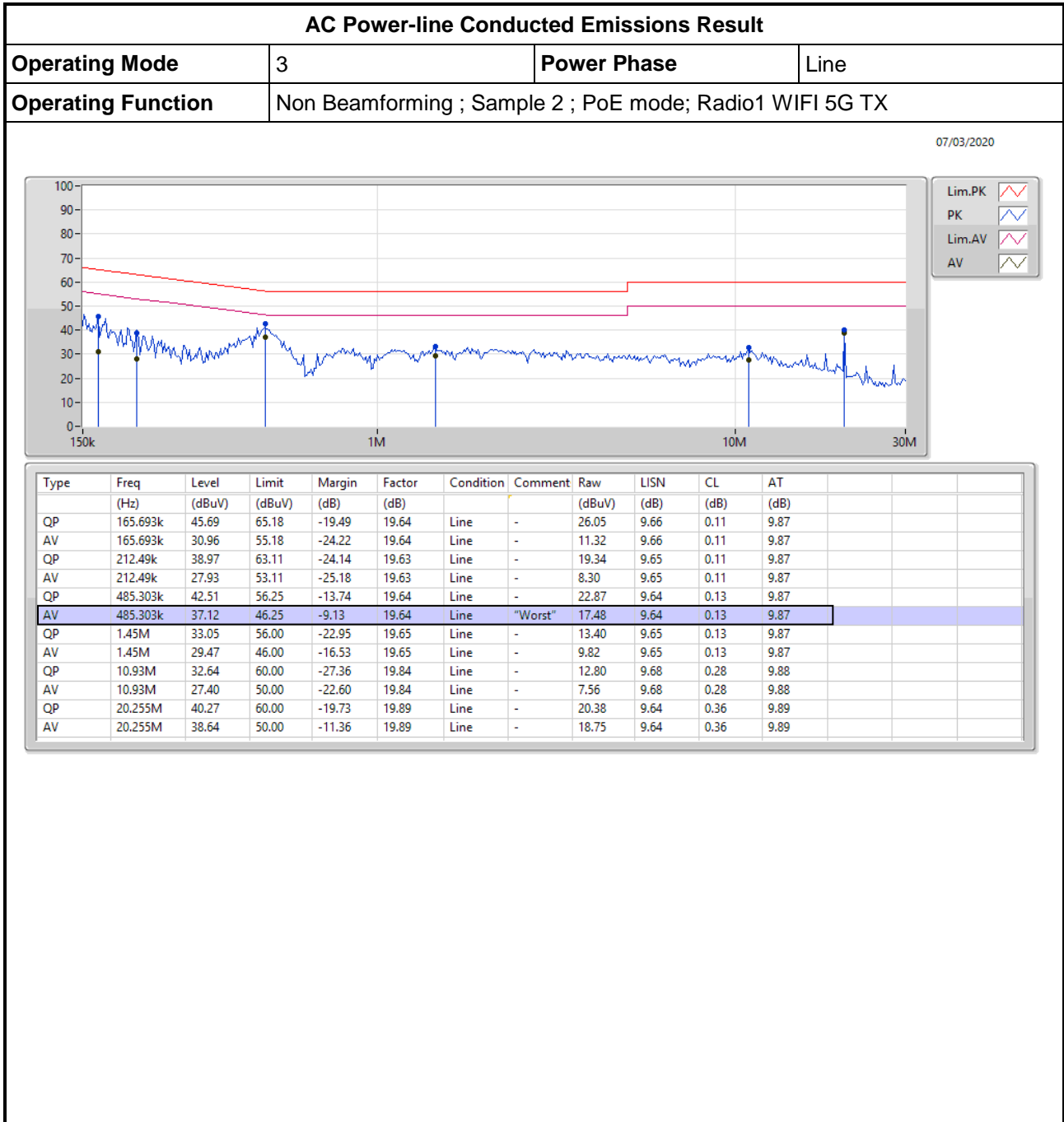



AC Power-line Conducted Emissions_
Non Beamforming_Sample 2_Radio2

Appendix A.4

AC Power-line Conducted Emissions Result

Operating Mode	4	Power Phase	Neutral
Operating Function	Non Beamforming ; Sample 2 ; PoE mode ; Radio2 WIFI 5G TX		

07/03/2020

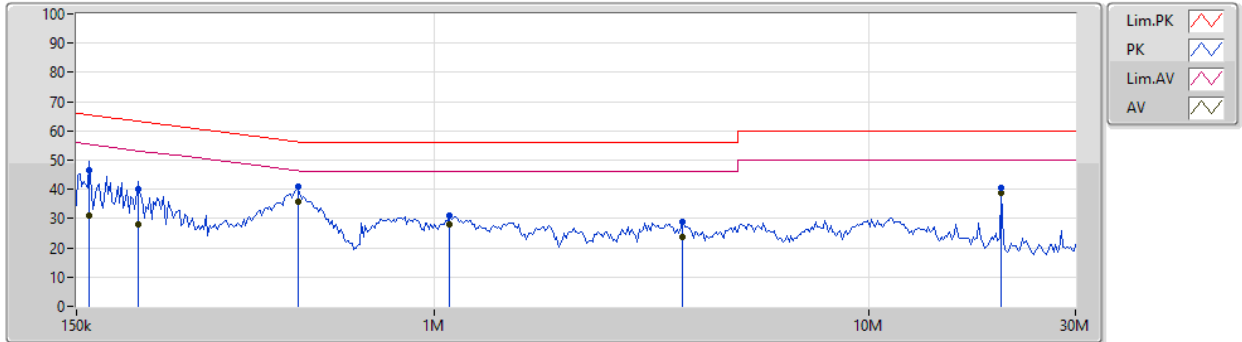

Type	Freq (Hz)	Level (dBuV)	Limit (dBuV)	Margin (dB)	Factor (dB)	Condition	Comment	Raw (dBuV)	LISN (dB)	CL (dB)	AT (dB)
QP	160.82k	46.56	65.43	-18.87	19.63	Neutral	-	26.93	9.65	0.11	9.87
AV	160.82k	31.23	55.43	-24.20	19.63	Neutral	-	11.60	9.65	0.11	9.87
QP	208.304k	40.28	63.27	-22.99	19.62	Neutral	-	20.66	9.64	0.11	9.87
AV	208.304k	28.09	53.27	-25.18	19.62	Neutral	-	8.47	9.64	0.11	9.87
QP	485.303k	41.07	56.25	-15.18	19.63	Neutral	-	21.44	9.63	0.13	9.87
AV	485.303k	35.80	46.25	-10.45	19.63	Neutral	"Worst"	16.17	9.63	0.13	9.87
QP	1.087M	31.19	56.00	-24.81	19.62	Neutral	-	11.57	9.63	0.11	9.88
AV	1.087M	27.84	46.00	-18.16	19.62	Neutral	-	8.22	9.63	0.11	9.88
QP	3.732M	28.69	56.00	-27.31	19.72	Neutral	-	8.97	9.66	0.18	9.88
AV	3.732M	23.70	46.00	-22.30	19.72	Neutral	-	3.98	9.66	0.18	9.88
QP	20.255M	40.43	60.00	-19.57	19.97	Neutral	-	20.46	9.72	0.36	9.89
AV	20.255M	38.61	50.00	-11.39	19.97	Neutral	-	18.64	9.72	0.36	9.89



AC Power-line Conducted Emissions_
Non Beamforming_Sample 2_Radio2

Appendix A.4

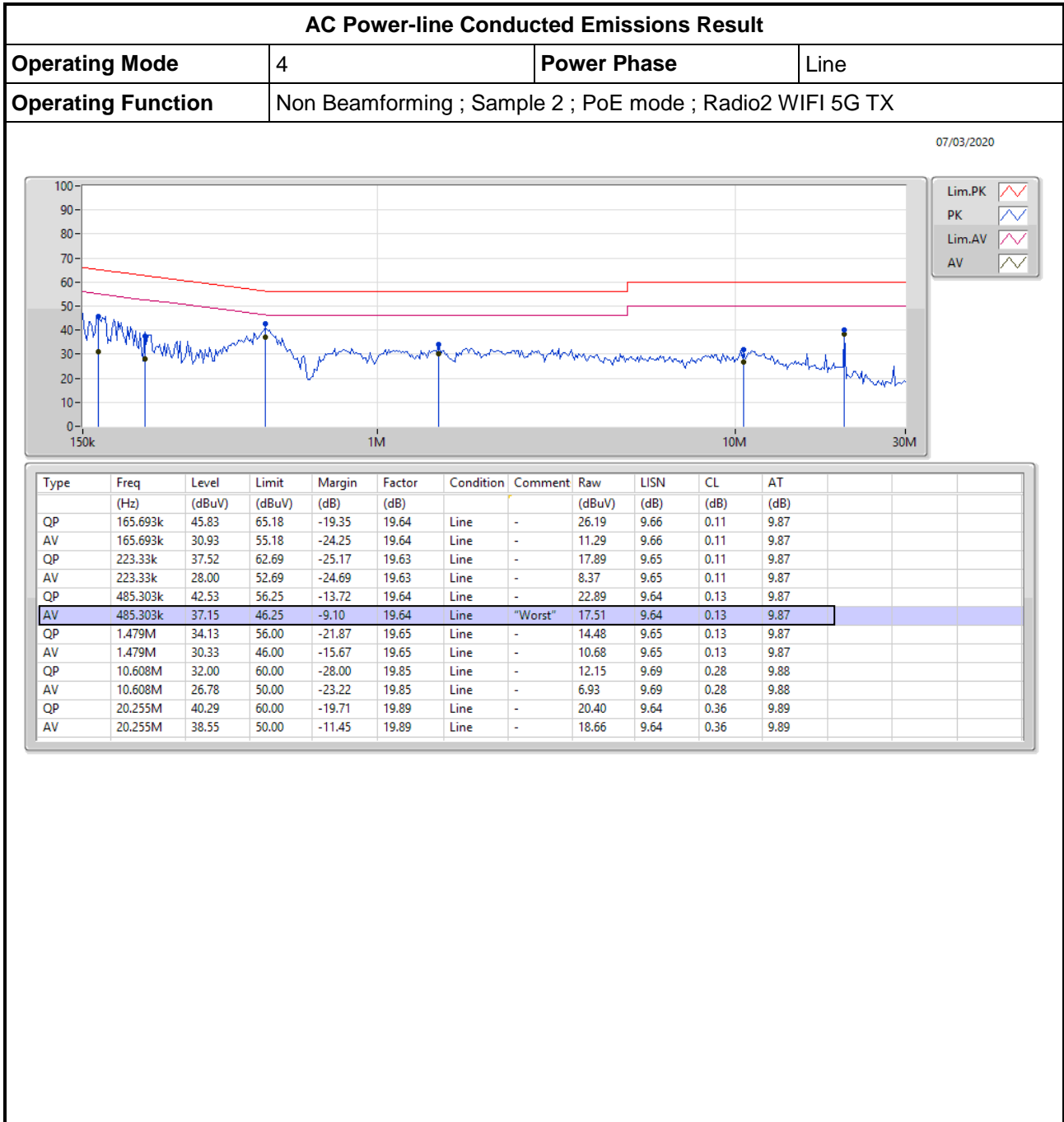



AC Power-line Conducted Emissions_
Beamforming_Sample 1_Radio1

Appendix A.5

AC Power-line Conducted Emissions Result

Operating Mode	5	Power Phase	Neutral
Operating Function	Beamforming ; Sample 1 ; PoE mode; Radio1 WIFI 5G TX		

07/03/2020

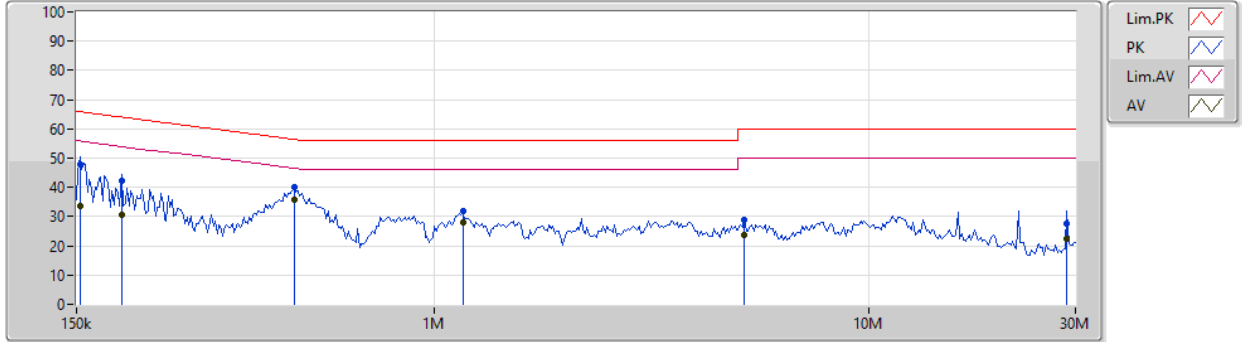

Type	Freq (Hz)	Level (dBuV)	Limit (dBuV)	Margin (dB)	Factor (dB)	Condition	Comment	Raw (dBuV)	LISN (dB)	CL (dB)	AT (dB)
QP	153.015k	47.74	65.83	-18.09	19.63	Neutral	-	28.11	9.65	0.11	9.87
AV	153.015k	33.77	55.83	-22.06	19.63	Neutral	-	14.14	9.65	0.11	9.87
QP	190.46k	42.06	64.01	-21.95	19.62	Neutral	-	22.44	9.64	0.11	9.87
AV	190.46k	30.43	54.01	-23.58	19.62	Neutral	-	10.81	9.64	0.11	9.87
QP	475.741k	40.11	56.42	-16.31	19.63	Neutral	-	20.48	9.63	0.13	9.87
AV	475.741k	35.64	46.42	-10.78	19.63	Neutral	"Worst"	16.01	9.63	0.13	9.87
QP	1.165M	31.72	56.00	-24.28	19.63	Neutral	-	12.09	9.63	0.12	9.88
AV	1.165M	28.08	46.00	-17.92	19.63	Neutral	-	8.45	9.63	0.12	9.88
QP	5.182M	28.82	60.00	-31.18	19.75	Neutral	-	9.07	9.67	0.20	9.88
AV	5.182M	23.81	50.00	-26.19	19.75	Neutral	-	4.06	9.67	0.20	9.88
QP	28.693M	27.58	60.00	-32.42	19.99	Neutral	-	7.59	9.67	0.44	9.88
AV	28.693M	22.23	50.00	-27.77	19.99	Neutral	-	2.24	9.67	0.44	9.88



AC Power-line Conducted Emissions_ Beamforming_Sample 1_Radio1

Appendix A.5

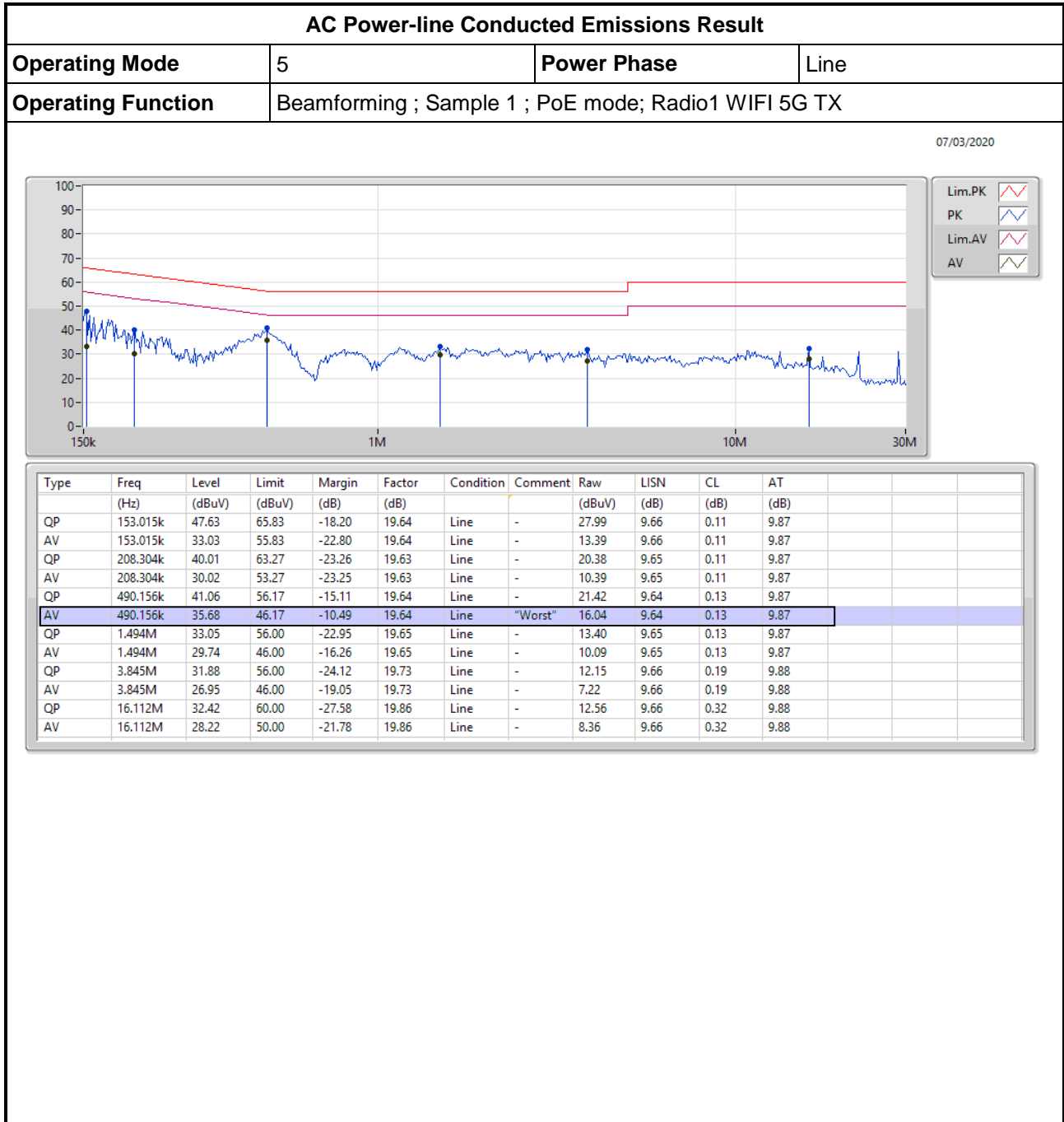



AC Power-line Conducted Emissions_
Beamforming_Sample 1_Radio2

Appendix A.6

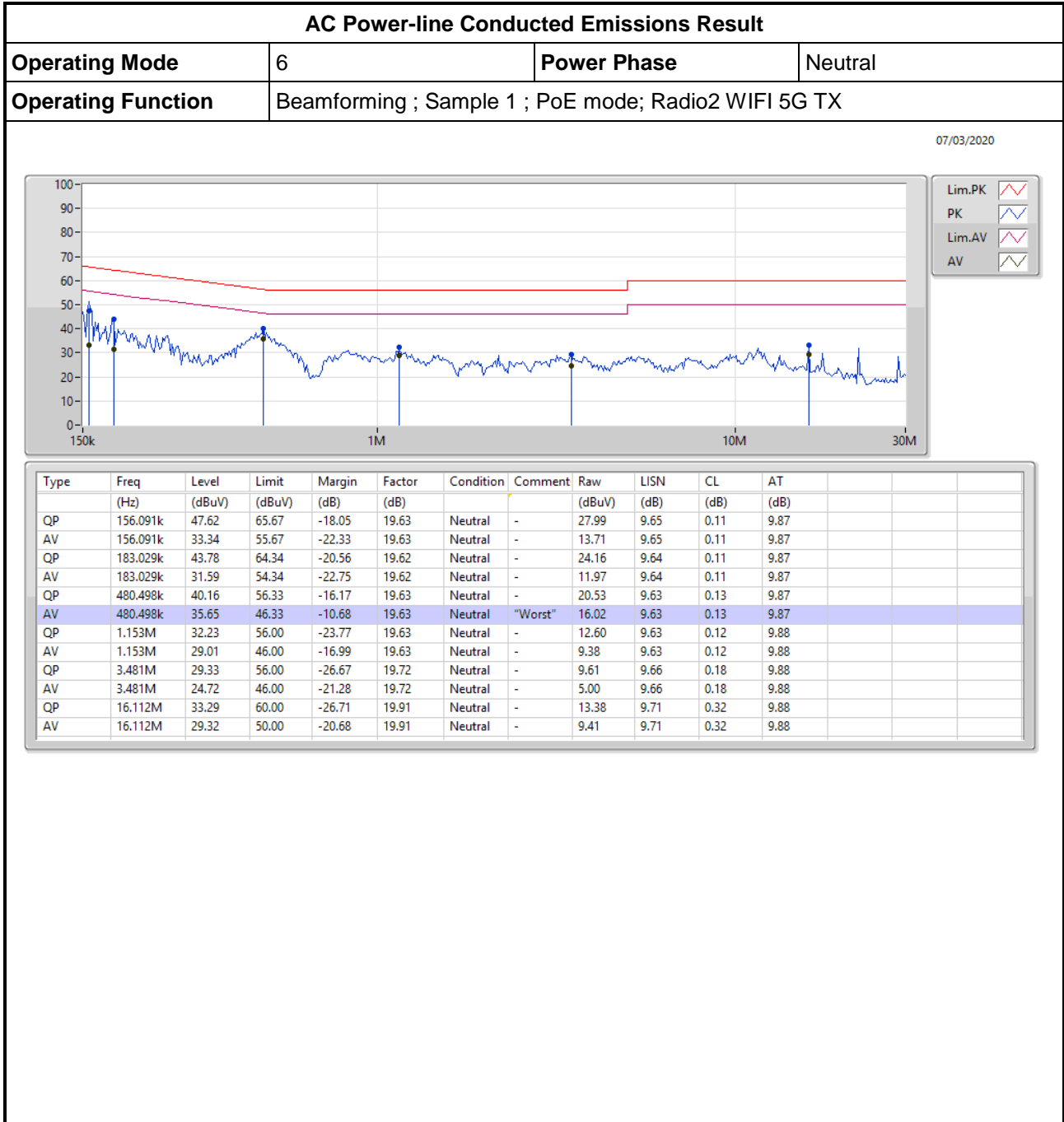



AC Power-line Conducted Emissions_
Beamforming_Sample 1_Radio2

Appendix A.6

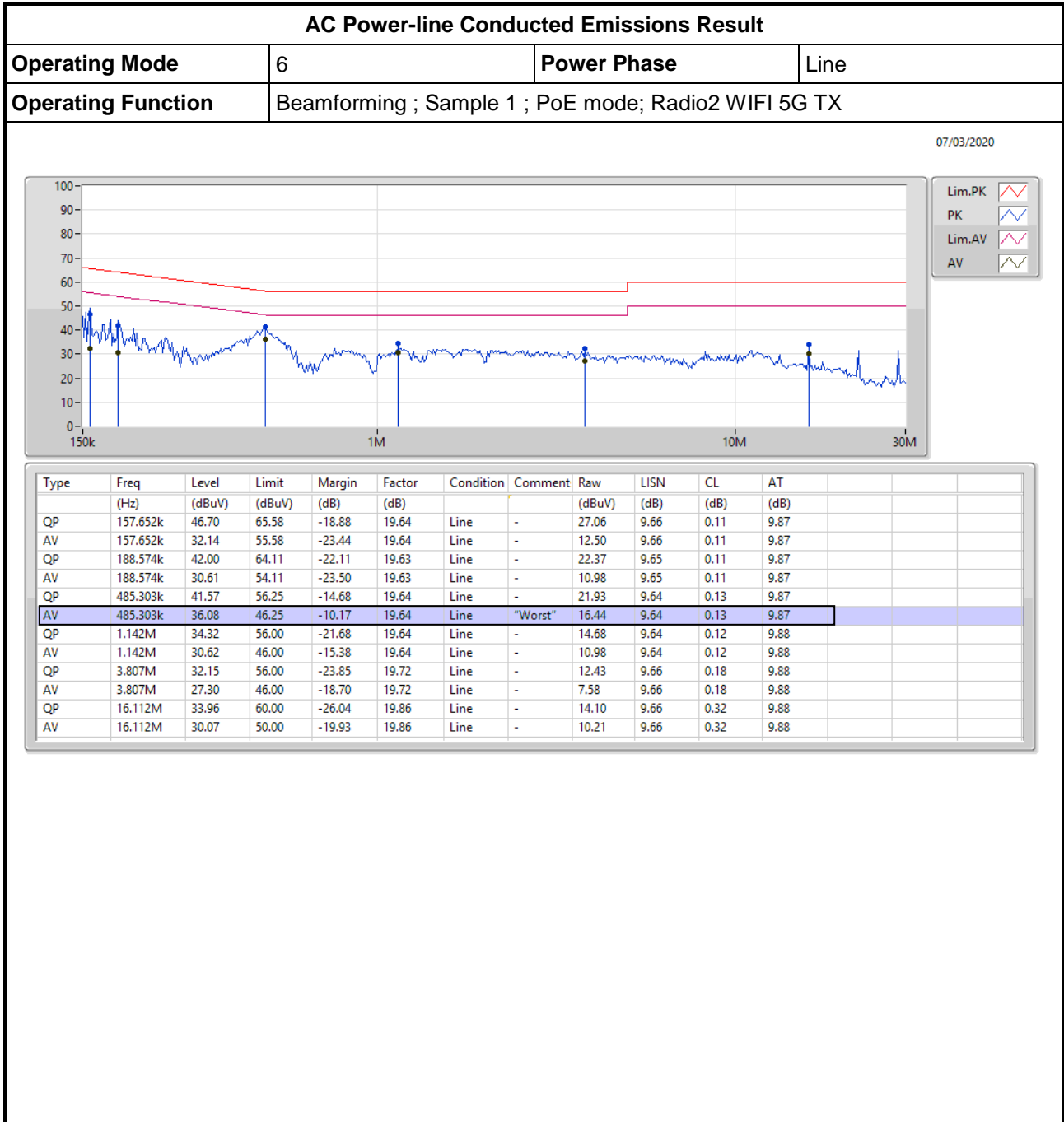



AC Power-line Conducted Emissions_ Beamforming_Sample 2_Radio1

Appendix A.7

AC Power-line Conducted Emissions Result

Operating Mode	7	Power Phase	Neutral
Operating Function	Beamforming ; Sample 2 ; PoE mode; Radio1 WIFI 5G TX		

07/03/2020

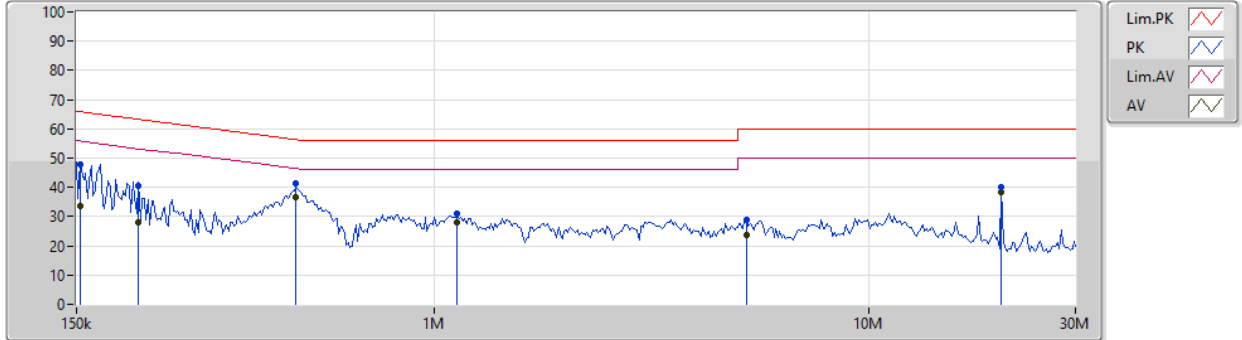

Type	Freq (Hz)	Level (dBuV)	Limit (dBuV)	Margin (dB)	Factor (dB)	Condition	Comment	Raw (dBuV)	LISN (dB)	CL (dB)	AT (dB)
QP	153.015k	47.88	65.83	-17.95	19.63	Neutral	-	28.25	9.65	0.11	9.87
AV	153.015k	33.59	55.83	-22.24	19.63	Neutral	-	13.96	9.65	0.11	9.87
QP	208.304k	40.31	63.27	-22.96	19.62	Neutral	-	20.69	9.64	0.11	9.87
AV	208.304k	28.03	53.27	-25.24	19.62	Neutral	-	8.41	9.64	0.11	9.87
QP	480.498k	41.19	56.33	-15.14	19.63	Neutral	-	21.56	9.63	0.13	9.87
AV	480.498k	36.64	46.33	-9.69	19.63	Neutral	"Worst"	17.01	9.63	0.13	9.87
QP	1.131M	31.24	56.00	-24.76	19.63	Neutral	-	11.61	9.63	0.12	9.88
AV	1.131M	27.91	46.00	-18.09	19.63	Neutral	-	8.28	9.63	0.12	9.88
QP	5.234M	28.97	60.00	-31.03	19.75	Neutral	-	9.22	9.67	0.20	9.88
AV	5.234M	23.51	50.00	-26.49	19.75	Neutral	-	3.76	9.67	0.20	9.88
QP	20.255M	40.21	60.00	-19.79	19.97	Neutral	-	20.24	9.72	0.36	9.89
AV	20.255M	38.18	50.00	-11.82	19.97	Neutral	-	18.21	9.72	0.36	9.89



AC Power-line Conducted Emissions_
Beamforming_Sample 2_Radio1

Appendix A.7

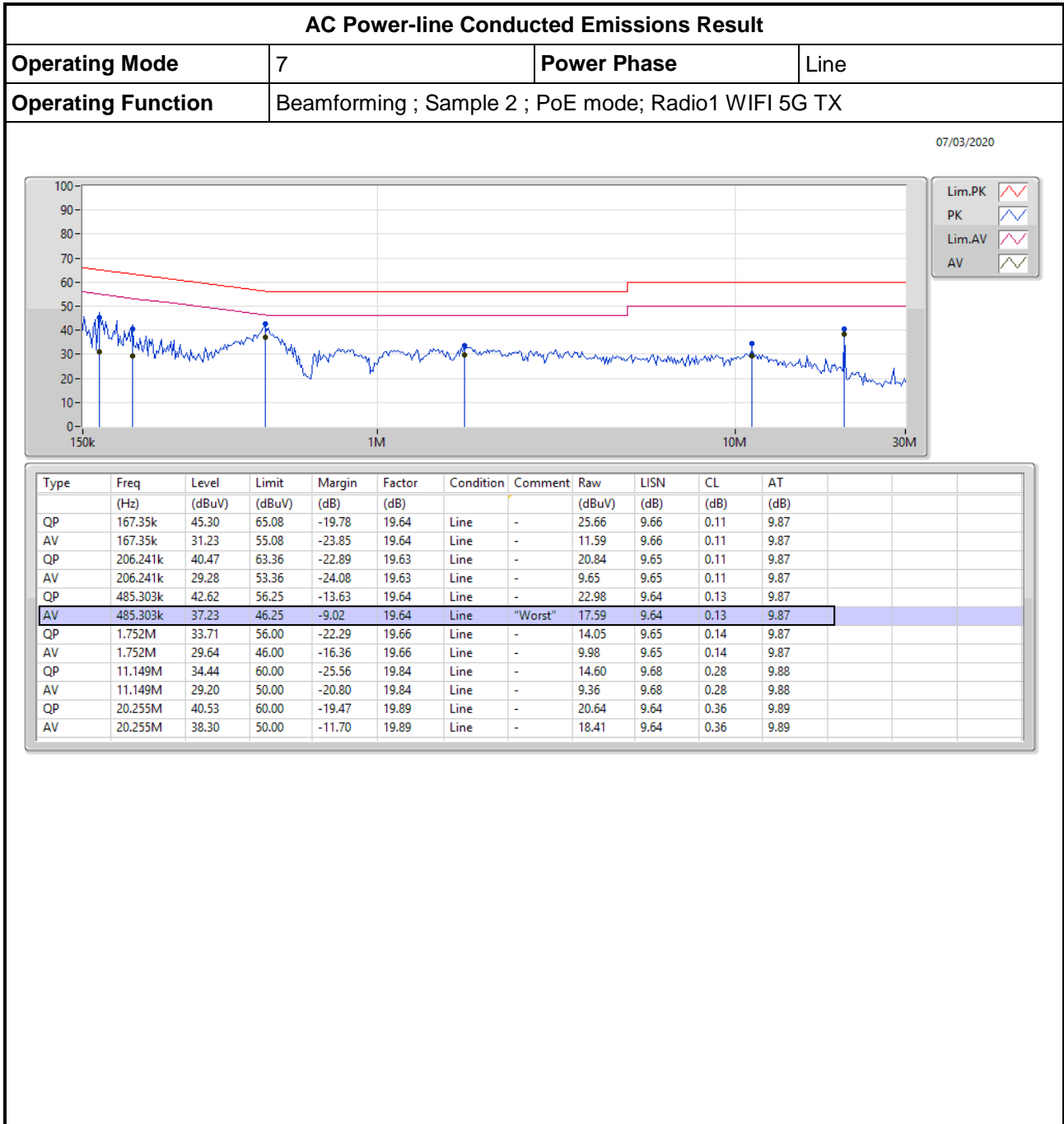



AC Power-line Conducted Emissions
Beamforming Sample 2 Radio2

Appendix A.8

AC Power-line Conducted Emissions Result

Operating Mode	8	Power Phase	Neutral
Operating Function	Beamforming ; Sample 2 ; PoE mode; Radio2 WIFI 5G TX		

07/03/2020

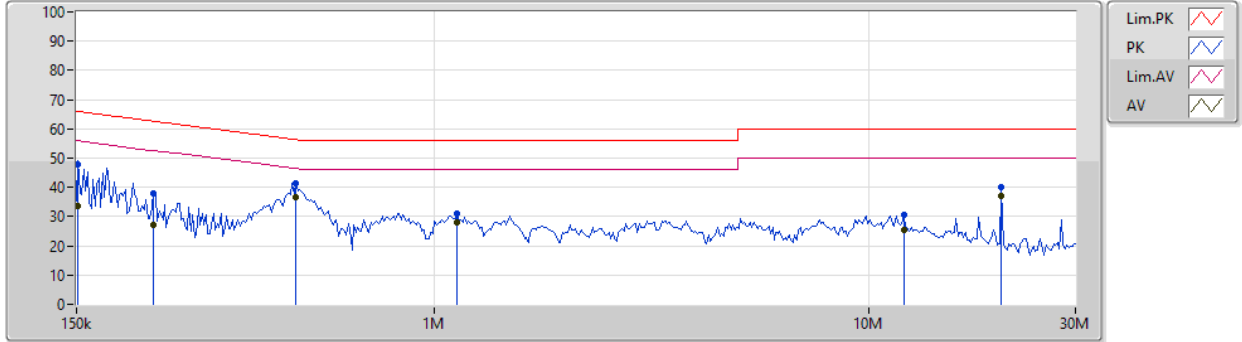

Type	Freq (Hz)	Level (dBuV)	Limit (dBuV)	Margin (dB)	Factor (dB)	Condition	Comment	Raw (dBuV)	LISN (dB)	CL (dB)	AT (dB)
QP	151.5k	48.04	65.92	-17.88	19.63	Neutral	-	28.41	9.65	0.11	9.87
AV	151.5k	33.52	55.92	-22.40	19.63	Neutral	-	13.89	9.65	0.11	9.87
QP	225.563k	37.77	62.62	-24.85	19.63	Neutral	-	18.14	9.64	0.12	9.87
AV	225.563k	27.30	52.62	-25.32	19.63	Neutral	-	7.67	9.64	0.12	9.87
QP	480.498k	41.28	56.33	-15.05	19.63	Neutral	-	21.65	9.63	0.13	9.87
AV	480.498k	36.66	46.33	-9.67	19.63	Neutral	"Worst"	17.03	9.63	0.13	9.87
QP	1.131M	31.16	56.00	-24.84	19.63	Neutral	-	11.53	9.63	0.12	9.88
AV	1.131M	27.84	46.00	-18.16	19.63	Neutral	-	8.21	9.63	0.12	9.88
QP	12.073M	30.49	60.00	-29.51	19.88	Neutral	-	10.61	9.71	0.29	9.88
AV	12.073M	25.47	50.00	-24.53	19.88	Neutral	-	5.59	9.71	0.29	9.88
QP	20.255M	40.17	60.00	-19.83	19.97	Neutral	-	20.20	9.72	0.36	9.89
AV	20.255M	36.98	50.00	-13.02	19.97	Neutral	-	17.01	9.72	0.36	9.89



AC Power-line Conducted Emissions
Beamforming_Sample 2_Radio2

Appendix A.8

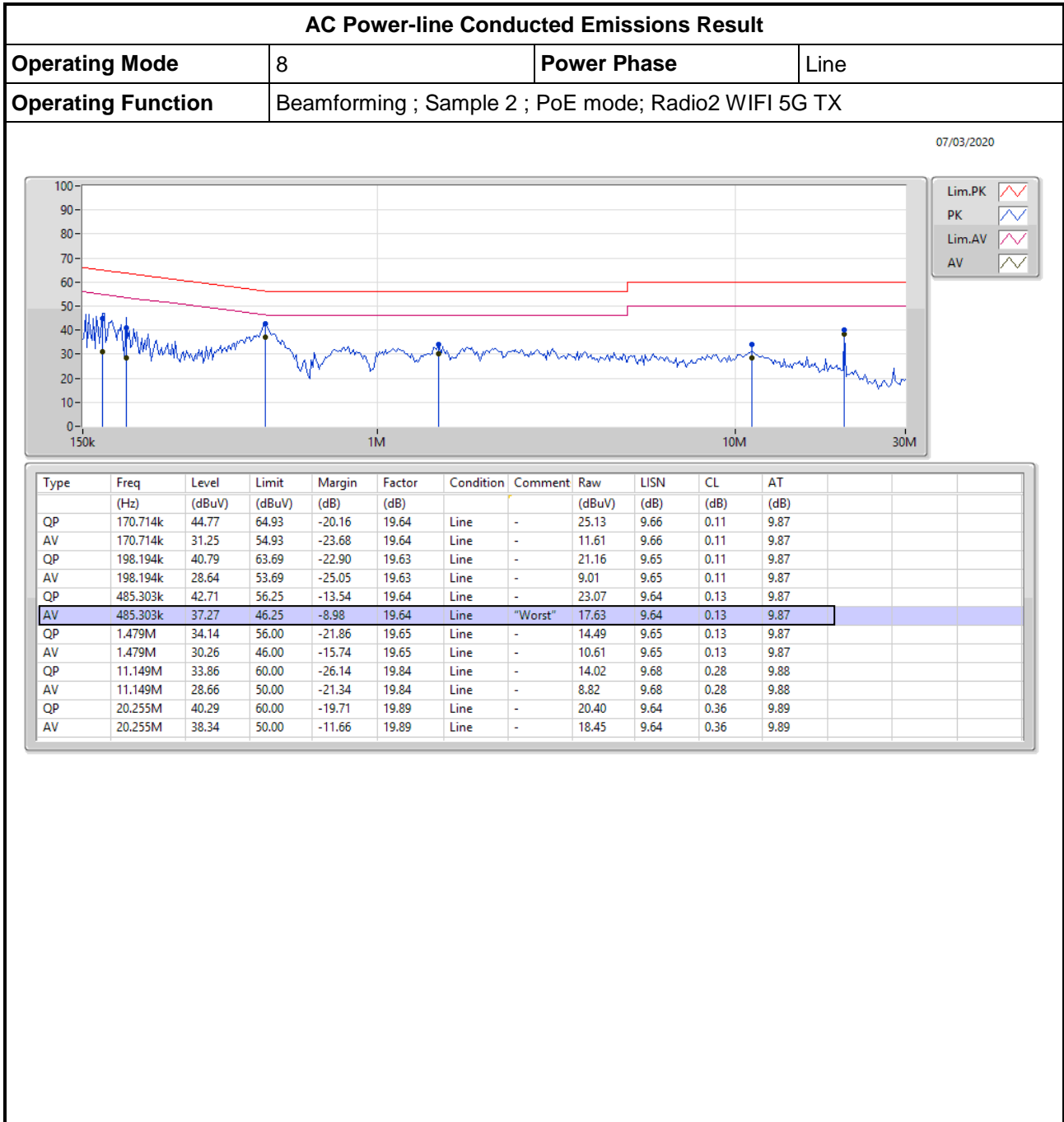



Summary

Mode	Max-N dB (Hz)	Max-OBW (Hz)	ITU-Code	Min-N dB (Hz)	Min-OBW (Hz)
5.15-5.25GHz	-	-	-	-	-
802.11a_Nss1,(6Mbps)_1TX	21.36M	16.792M	16M8D1D	21.3M	16.762M
802.11ac VHT20_Nss1,(MCS0)_1TX	21.57M	17.871M	17M9D1D	21.51M	17.841M
802.11ac VHT40_Nss1,(MCS0)_1TX	40.44M	36.462M	36M5D1D	40.38M	36.462M
802.11ac VHT80_Nss1,(MCS0)_1TX	82.08M	75.682M	75M7D1D	82.08M	75.682M
802.11ax HEW20_Nss1,(MCS0)_1TX	21.48M	19.01M	19M0D1D	21.36M	19.01M
802.11ax HEW40_Nss1,(MCS0)_1TX	40.14M	37.541M	37M5D1D	40.02M	37.481M
802.11ax HEW80_Nss1,(MCS0)_1TX	82.08M	77.121M	77M1D1D	82.08M	77.121M
5.725-5.85GHz	-	-	-	-	-
802.11a_Nss1,(6Mbps)_1TX	16.38M	24.858M	24M9D1D	16.32M	16.792M
802.11ac VHT20_Nss1,(MCS0)_1TX	17.58M	24.828M	24M8D1D	17.55M	17.871M
802.11ac VHT40_Nss1,(MCS0)_1TX	36.3M	55.592M	55M6D1D	36.06M	54.273M
802.11ac VHT80_Nss1,(MCS0)_1TX	75.12M	77.121M	77M1D1D	75.12M	77.121M
802.11ax HEW20_Nss1,(MCS0)_1TX	18.99M	26.297M	26M3D1D	18.87M	19.04M
802.11ax HEW40_Nss1,(MCS0)_1TX	37.5M	51.754M	51M8D1D	36.72M	48.216M
802.11ax HEW80_Nss1,(MCS0)_1TX	75.96M	78.201M	78M2D1D	75.96M	78.201M

Max-N dB = Maximum 6dB down bandwidth for 5.725-5.85GHz band / Maximum 26dB down bandwidth for other band;

Max-OBW = Maximum 99% occupied bandwidth;

Min-N dB = Minimum 6dB down bandwidth for 5.725-5.85GHz band / Maximum 26dB down bandwidth for other band;

Min-OBW = Minimum 99% occupied bandwidth;



Result

Mode	Result	Limit (Hz)	Port 1-N dB (Hz)	Port 1-OBW (Hz)
802.11a_Nss1,(6Mbps)_1TX	-	-	-	-
5180MHz_TnomVnom	Pass	Inf	21.36M	16.762M
5200MHz_TnomVnom	Pass	Inf	21.33M	16.792M
5240MHz_TnomVnom	Pass	Inf	21.3M	16.762M
5745MHz_TnomVnom	Pass	500k	16.32M	24.858M
5785MHz_TnomVnom	Pass	500k	16.38M	16.792M
5825MHz_TnomVnom	Pass	500k	16.35M	16.852M
802.11ac VHT20_Nss1,(MCS0)_1TX	-	-	-	-
5180MHz_TnomVnom	Pass	Inf	21.51M	17.841M
5200MHz_TnomVnom	Pass	Inf	21.57M	17.841M
5240MHz_TnomVnom	Pass	Inf	21.57M	17.871M
5745MHz_TnomVnom	Pass	500k	17.55M	24.828M
5785MHz_TnomVnom	Pass	500k	17.58M	17.871M
5825MHz_TnomVnom	Pass	500k	17.58M	17.871M
802.11ac VHT40_Nss1,(MCS0)_1TX	-	-	-	-
5190MHz_TnomVnom	Pass	Inf	40.44M	36.462M
5230MHz_TnomVnom	Pass	Inf	40.38M	36.462M
5755MHz_TnomVnom	Pass	500k	36.3M	55.592M
5795MHz_TnomVnom	Pass	500k	36.06M	54.273M
802.11ac VHT80_Nss1,(MCS0)_1TX	-	-	-	-
5210MHz_TnomVnom	Pass	Inf	82.08M	75.682M
5775MHz_TnomVnom	Pass	500k	75.12M	77.121M
802.11ax HEW20_Nss1,(MCS0)_1TX	-	-	-	-
5180MHz_TnomVnom	Pass	Inf	21.48M	19.01M
5200MHz_TnomVnom	Pass	Inf	21.36M	19.01M
5240MHz_TnomVnom	Pass	Inf	21.39M	19.01M
5745MHz_TnomVnom	Pass	500k	18.87M	26.297M
5785MHz_TnomVnom	Pass	500k	18.99M	19.04M
5825MHz_TnomVnom	Pass	500k	18.96M	19.04M
802.11ax HEW40_Nss1,(MCS0)_1TX	-	-	-	-
5190MHz_TnomVnom	Pass	Inf	40.14M	37.541M
5230MHz_TnomVnom	Pass	Inf	40.02M	37.481M
5755MHz_TnomVnom	Pass	500k	36.72M	51.754M
5795MHz_TnomVnom	Pass	500k	37.5M	48.216M
802.11ax HEW80_Nss1,(MCS0)_1TX	-	-	-	-
5210MHz_TnomVnom	Pass	Inf	82.08M	77.121M
5775MHz_TnomVnom	Pass	500k	75.96M	78.201M

Port X-N dB = Port X 6dB down bandwidth for 5.725-5.85GHz band / 26dB down bandwidth for other band
Port X-OBW = Port X 99% occupied bandwidth;

802.11a_Nss1,(6Mbps)_1TX

EBW

5180MHz

01/02/2020

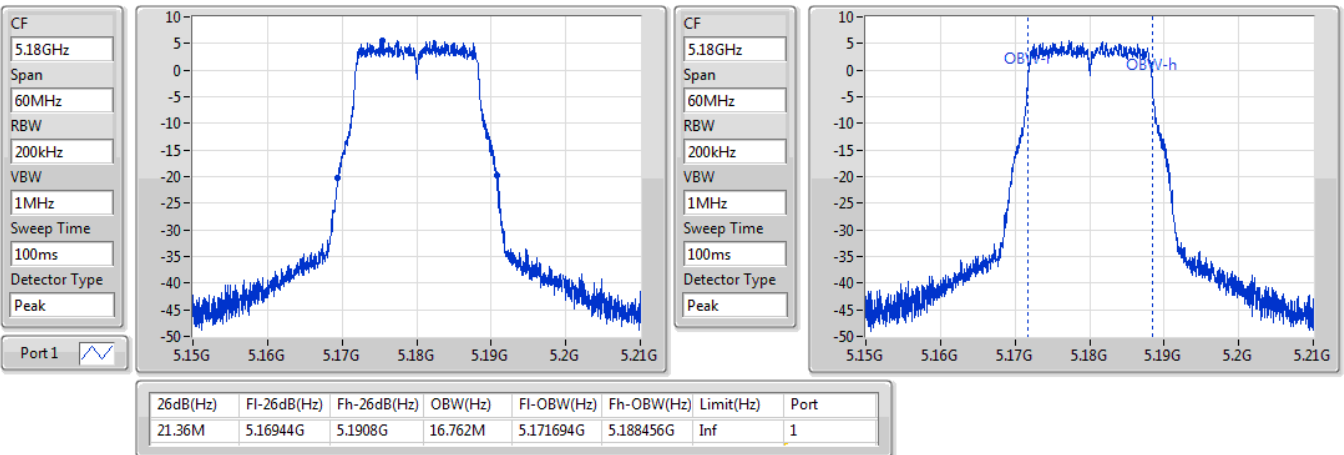

802.11a_Nss1,(6Mbps)_1TX

EBW

5200MHz

01/02/2020

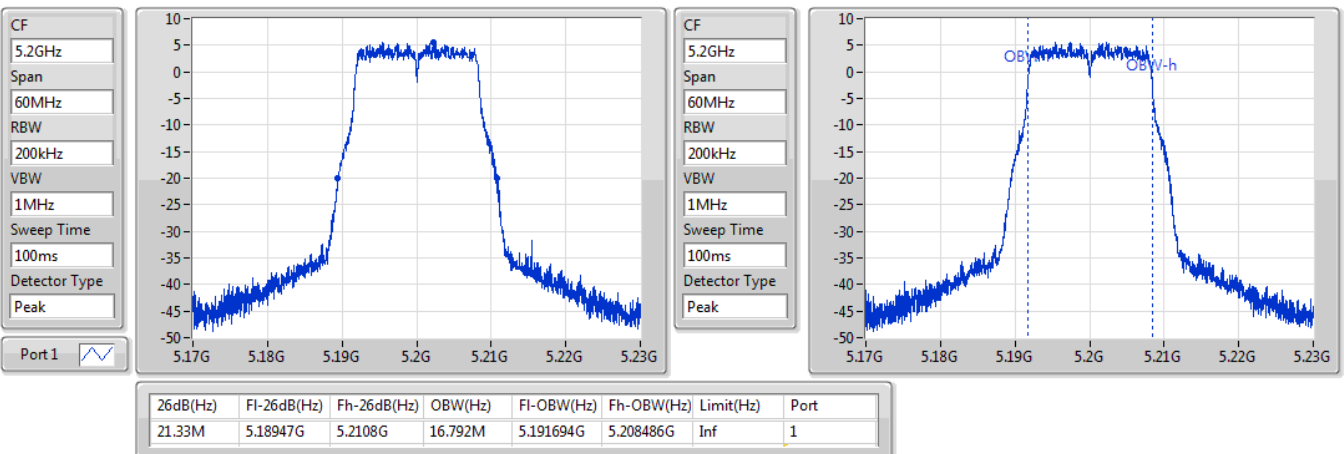

802.11a_Nss1,(6Mbps)_1TX

EBW

5240MHz

01/02/2020

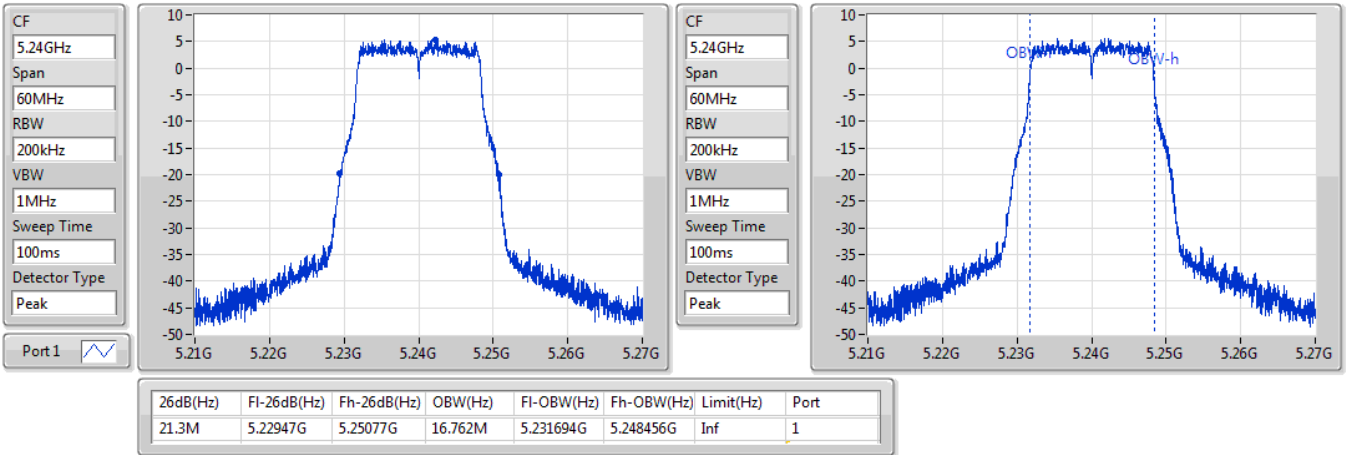

802.11a_Nss1,(6Mbps)_1TX

EBW

5745MHz

31/01/2020

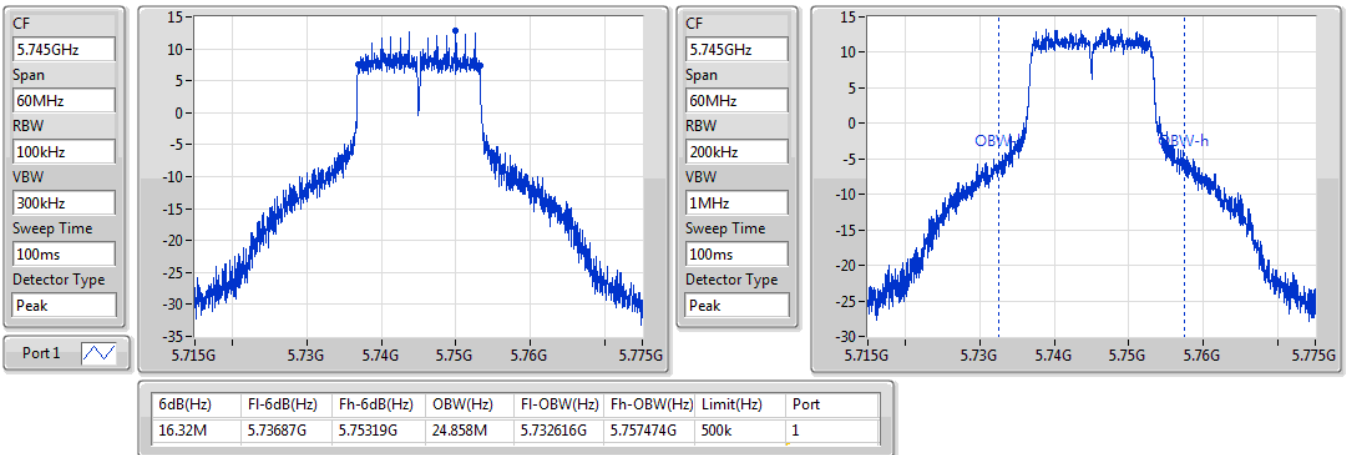

802.11a_Nss1,(6Mbps)_1TX

EBW

5785MHz

31/01/2020

CF
5.785GHz
Span
60MHz
RBW
100kHz
VBW
300kHz
Sweep Time
100ms
Detector Type
Peak
Port 1

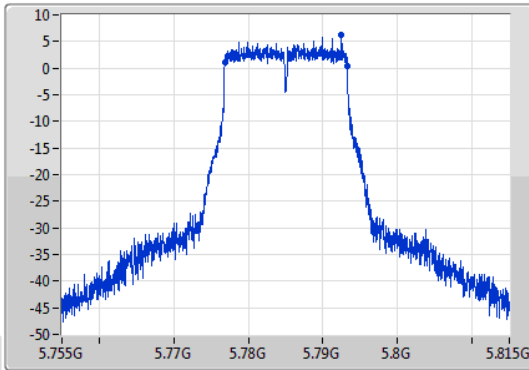

CF
5.785GHz
Span
60MHz
RBW
200kHz
VBW
1MHz
Sweep Time
100ms
Detector Type
Peak

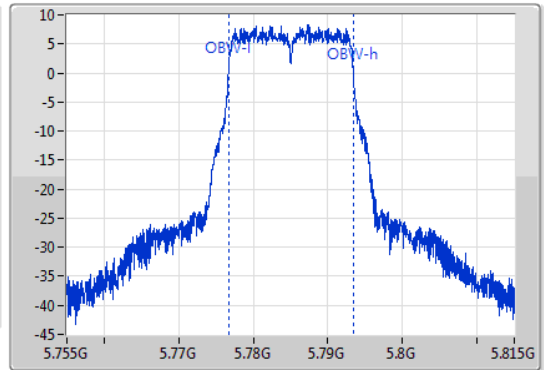

6dB(Hz)	Fl-6dB(Hz)	Fh-6dB(Hz)	OBW(Hz)	Fl-OBW(Hz)	Fh-OBW(Hz)	Limit(Hz)	Port
16.38M	5.77684G	5.79322G	16.792M	5.776664G	5.793456G	500k	1

802.11a_Nss1,(6Mbps)_1TX

EBW

5825MHz

31/01/2020

CF
5.825GHz
Span
60MHz
RBW
100kHz
VBW
300kHz
Sweep Time
100ms
Detector Type
Peak
Port 1

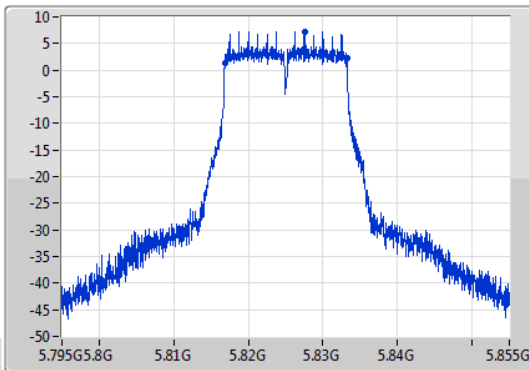

CF
5.825GHz
Span
60MHz
RBW
200kHz
VBW
1MHz
Sweep Time
100ms
Detector Type
Peak

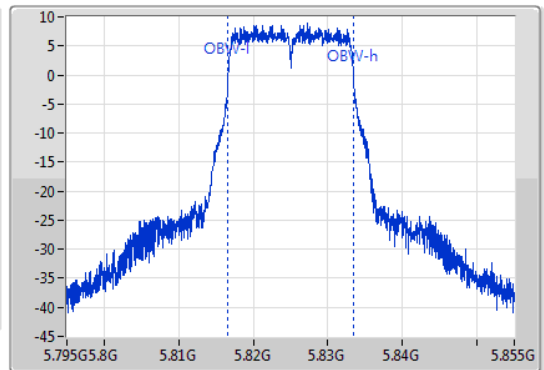

6dB(Hz)	Fl-6dB(Hz)	Fh-6dB(Hz)	OBW(Hz)	Fl-OBW(Hz)	Fh-OBW(Hz)	Limit(Hz)	Port
16.35M	5.81684G	5.83319G	16.852M	5.816634G	5.833486G	500k	1

802.11ac VHT20_Nss1,(MCS0)_1TX

EBW

5180MHz

07/02/2020

CF
5.18GHz
Span
60MHz
RBW
200kHz
VBW
1MHz
Sweep Time
100ms
Detector Type
Peak
Port 1

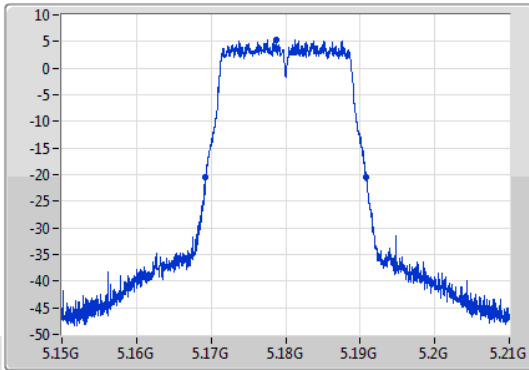

CF
5.18GHz
Span
60MHz
RBW
200kHz
VBW
1MHz
Sweep Time
100ms
Detector Type
Peak

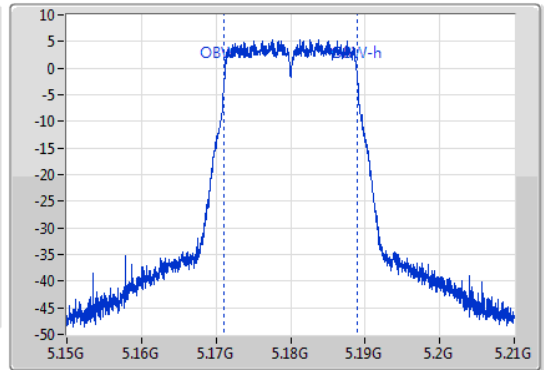

26dB(Hz)	Fl-26dB(Hz)	Fh-26dB(Hz)	OBW(Hz)	Fl-OBW(Hz)	Fh-OBW(Hz)	Limit(Hz)	Port
21.51M	5.16929G	5.1908G	17.841M	5.171124G	5.188966G	Inf	1

802.11ac VHT20_Nss1,(MCS0)_1TX

EBW

5200MHz

07/02/2020

CF
5.2GHz
Span
60MHz
RBW
200kHz
VBW
1MHz
Sweep Time
100ms
Detector Type
Peak
Port 1

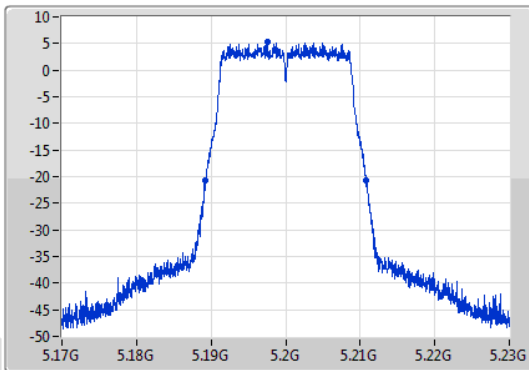

CF
5.2GHz
Span
60MHz
RBW
200kHz
VBW
1MHz
Sweep Time
100ms
Detector Type
Peak

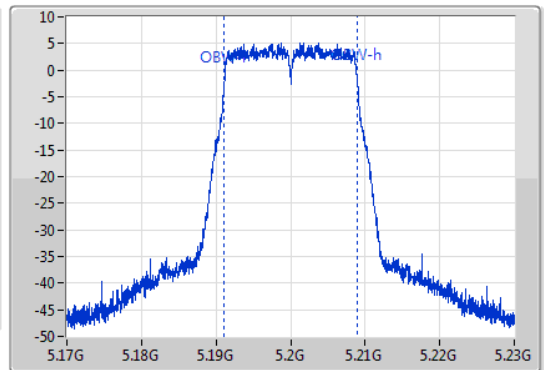

26dB(Hz)	Fl-26dB(Hz)	Fh-26dB(Hz)	OBW(Hz)	Fl-OBW(Hz)	Fh-OBW(Hz)	Limit(Hz)	Port
21.57M	5.18926G	5.21083G	17.841M	5.191124G	5.208966G	Inf	1

802.11ac VHT20_Nss1,(MCS0)_1TX

EBW

5240MHz

07/02/2020

CF
5.24GHz
Span
60MHz
RBW
200kHz
VBW
1MHz
Sweep Time
100ms
Detector Type
Peak
Port 1

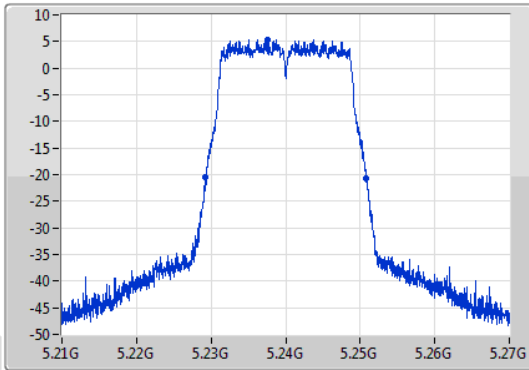

CF
5.24GHz
Span
60MHz
RBW
200kHz
VBW
1MHz
Sweep Time
100ms
Detector Type
Peak

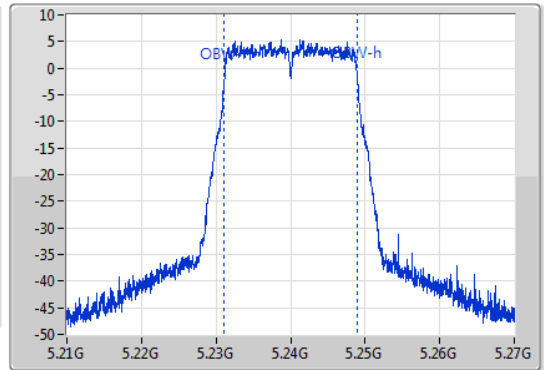

26dB(Hz)	Fl-26dB(Hz)	Fh-26dB(Hz)	OBW(Hz)	Fl-OBW(Hz)	Fh-OBW(Hz)	Limit(Hz)	Port
21.57M	5.22926G	5.25083G	17.871M	5.231094G	5.248966G	Inf	1

802.11ac VHT20_Nss1,(MCS0)_1TX

EBW

5745MHz

31/01/2020

CF
5.745GHz
Span
60MHz
RBW
100kHz
VBW
300kHz
Sweep Time
100ms
Detector Type
Peak
Port 1

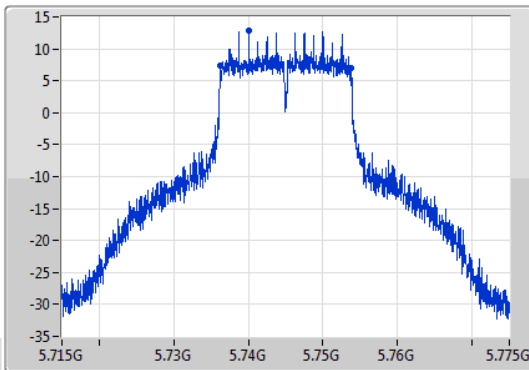

CF
5.745GHz
Span
60MHz
RBW
200kHz
VBW
1MHz
Sweep Time
100ms
Detector Type
Peak

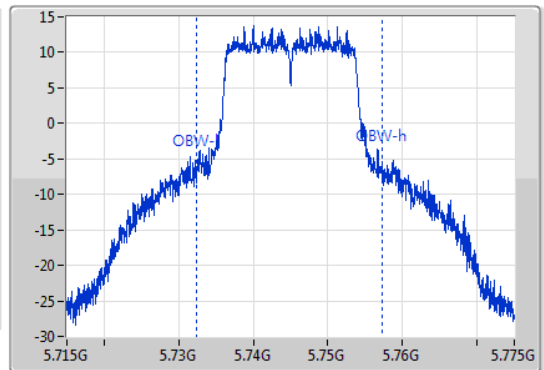

6dB(Hz)	Fl-6dB(Hz)	Fh-6dB(Hz)	OBW(Hz)	Fl-OBW(Hz)	Fh-OBW(Hz)	Limit(Hz)	Port
17.55M	5.73624G	5.75379G	24.828M	5.732436G	5.757264G	500k	1

802.11ac VHT20_Nss1,(MCS0)_1TX

EBW

5785MHz

31/01/2020

CF
5.785GHz
Span
60MHz
RBW
100kHz
VBW
300kHz
Sweep Time
100ms
Detector Type
Peak
Port 1

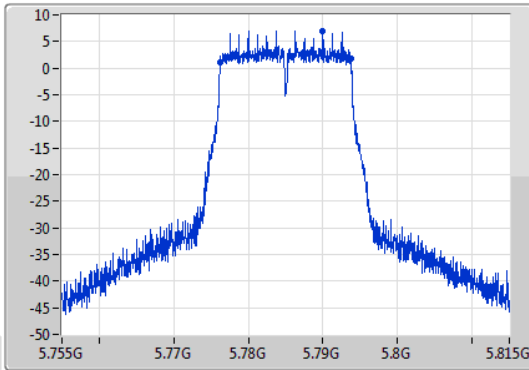

CF
5.785GHz
Span
60MHz
RBW
200kHz
VBW
1MHz
Sweep Time
100ms
Detector Type
Peak

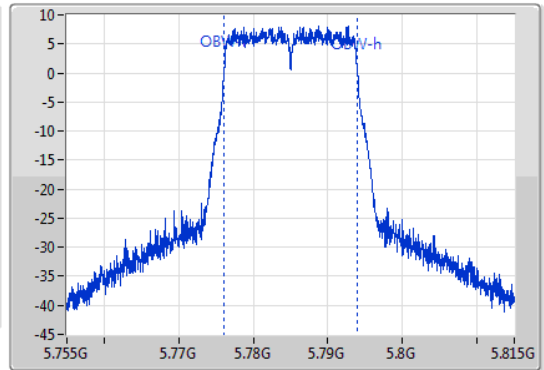

6dB(Hz)	Fl-6dB(Hz)	Fh-6dB(Hz)	OBW(Hz)	Fl-OBW(Hz)	Fh-OBW(Hz)	Limit(Hz)	Port
17.58M	5.77621G	5.79379G	17.871M	5.776094G	5.793966G	500k	1

802.11ac VHT20_Nss1,(MCS0)_1TX

EBW

5825MHz

31/01/2020

CF
5.825GHz
Span
60MHz
RBW
100kHz
VBW
300kHz
Sweep Time
100ms
Detector Type
Peak
Port 1

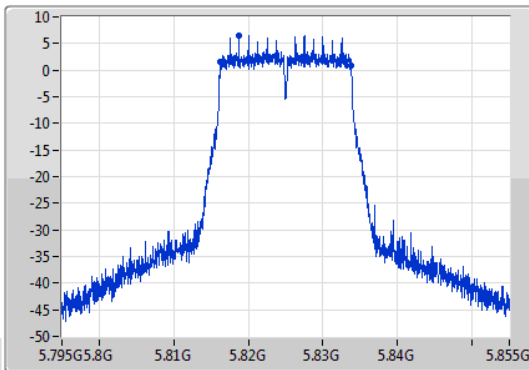

CF
5.825GHz
Span
60MHz
RBW
200kHz
VBW
1MHz
Sweep Time
100ms
Detector Type
Peak

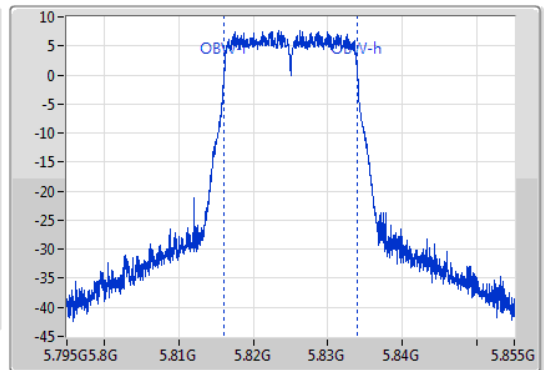

6dB(Hz)	Fl-6dB(Hz)	Fh-6dB(Hz)	OBW(Hz)	Fl-OBW(Hz)	Fh-OBW(Hz)	Limit(Hz)	Port
17.58M	5.81624G	5.83382G	17.871M	5.816094G	5.833966G	500k	1

802.11ac VHT40_Nss1,(MCS0)_1TX

EBW

5190MHz

01/02/2020

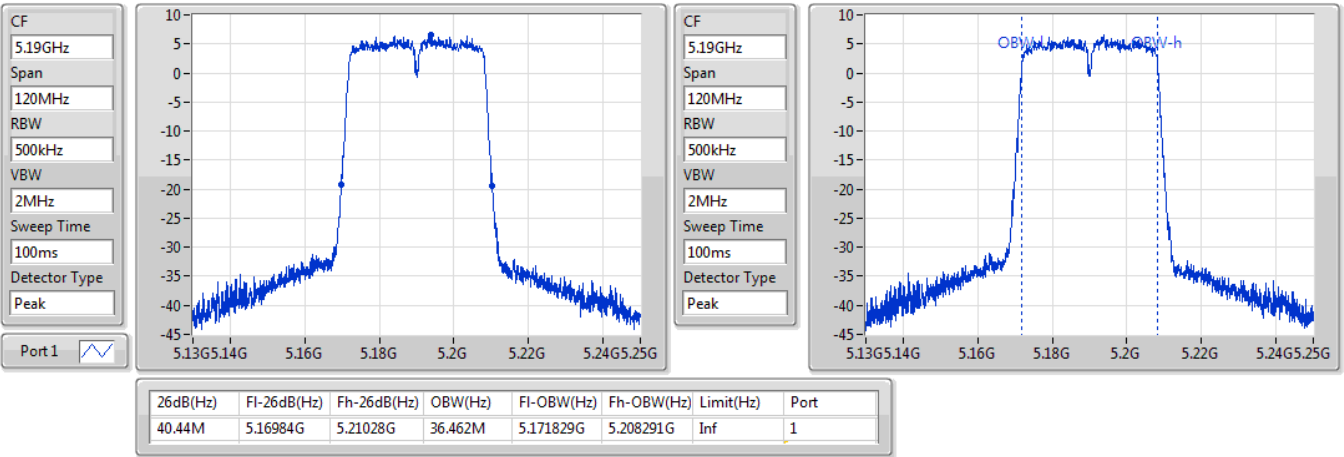

802.11ac VHT40_Nss1,(MCS0)_1TX

EBW

5230MHz

01/02/2020

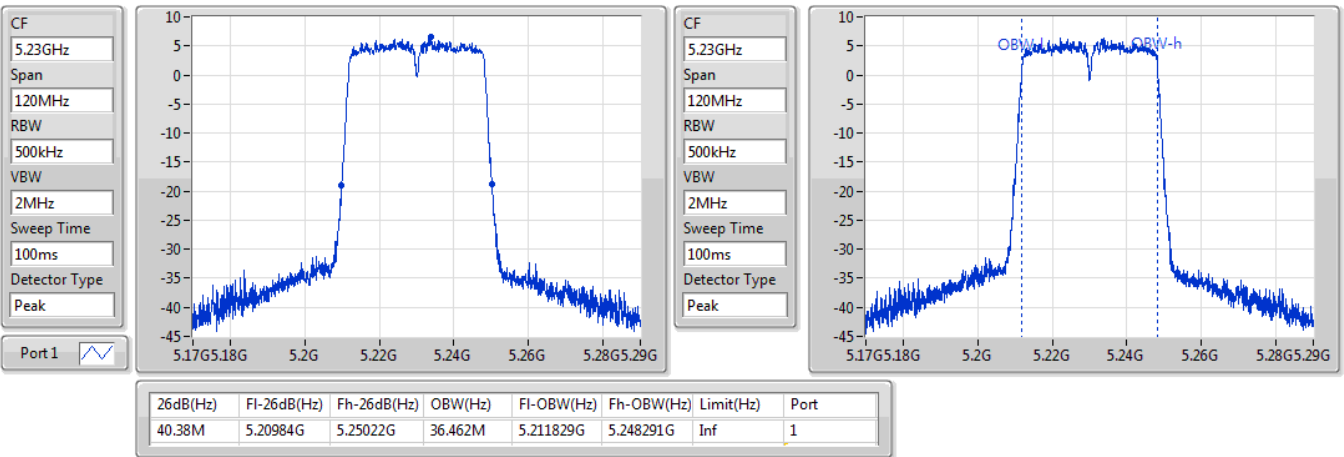

802.11ac VHT40_Nss1,(MCS0)_1TX

EBW

5755MHz

31/01/2020

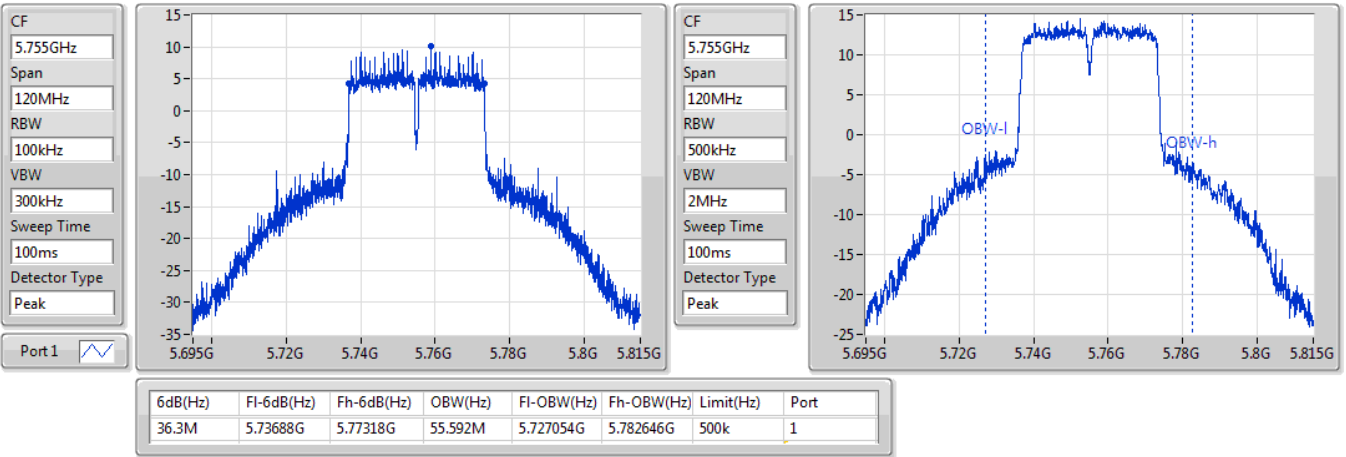

802.11ac VHT40_Nss1,(MCS0)_1TX

EBW

5795MHz

31/01/2020

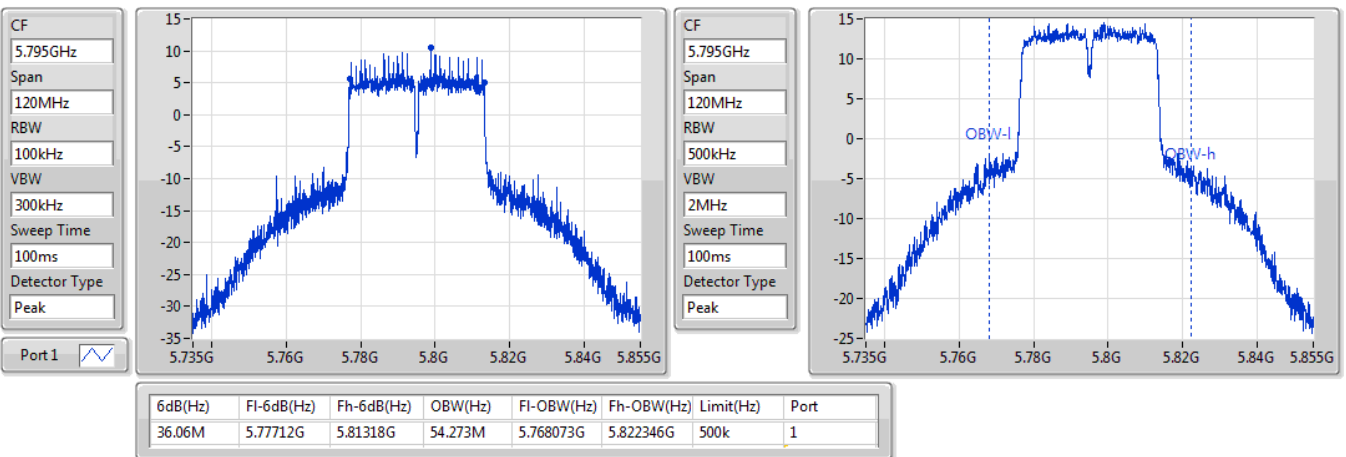

802.11ac VHT80_Nss1,(MCS0)_1TX

EBW

5210MHz

01/02/2020

CF
5.21GHz
Span
240MHz
RBW
1MHz
VBW
3MHz
Sweep Time
100ms
Detector Type
Peak
Port 1

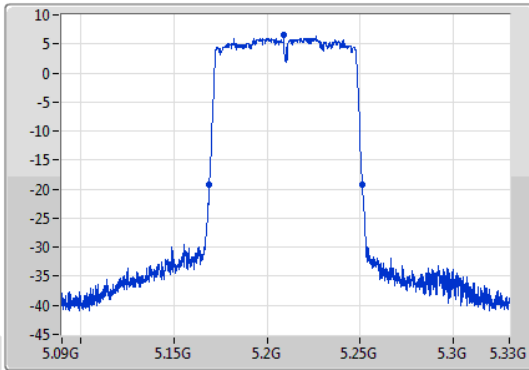

CF
5.21GHz
Span
240MHz
RBW
1MHz
VBW
3MHz
Sweep Time
100ms
Detector Type
Peak

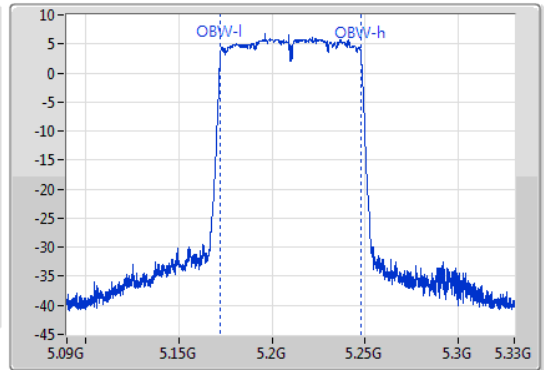

26dB(Hz)	Fl-26dB(Hz)	Fh-26dB(Hz)	OBW(Hz)	Fl-OBW(Hz)	Fh-OBW(Hz)	Limit(Hz)	Port
82.08M	5.16908G	5.25116G	75.682M	5.172219G	5.247901G	Inf	1

802.11ac VHT80_Nss1,(MCS0)_1TX

EBW

5775MHz

31/01/2020

CF
5.775GHz
Span
240MHz
RBW
100kHz
VBW
300kHz
Sweep Time
100ms
Detector Type
Peak
Port 1

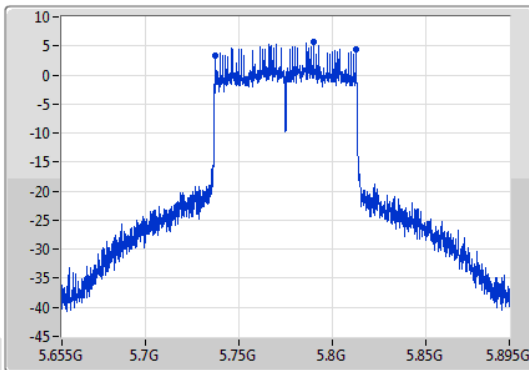

CF
5.775GHz
Span
240MHz
RBW
1MHz
VBW
3MHz
Sweep Time
100ms
Detector Type
Peak

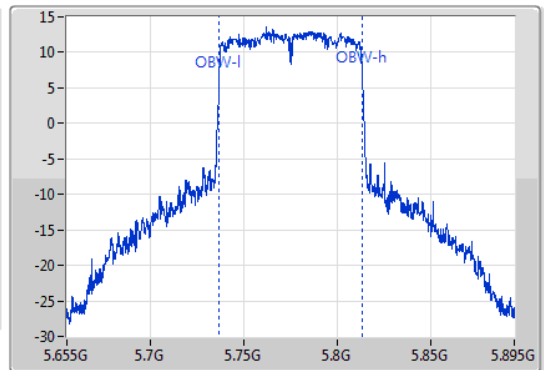

6dB(Hz)	Fl-6dB(Hz)	Fh-6dB(Hz)	OBW(Hz)	Fl-OBW(Hz)	Fh-OBW(Hz)	Limit(Hz)	Port
75.12M	5.73744G	5.81256G	77.121M	5.736499G	5.813621G	500k	1

802.11ax HEW20_Nss1,(MCS0)_1TX

EBW

5180MHz

01/02/2020

CF
5.18GHz
Span
60MHz
RBW
200kHz
VBW
1MHz
Sweep Time
100ms
Detector Type
Peak
Port 1

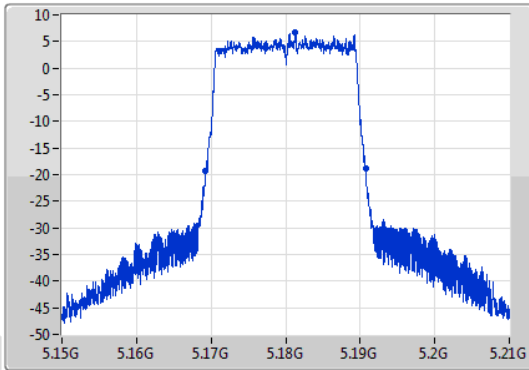

CF
5.18GHz
Span
60MHz
RBW
200kHz
VBW
1MHz
Sweep Time
100ms
Detector Type
Peak

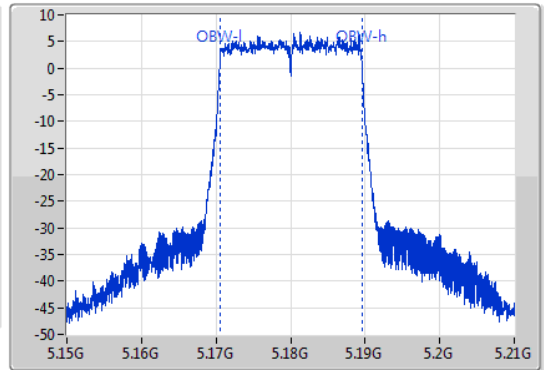

26dB(Hz)	Fl-26dB(Hz)	Fh-26dB(Hz)	OBW(Hz)	Fl-OBW(Hz)	Fh-OBW(Hz)	Limit(Hz)	Port
21.48M	5.16929G	5.19077G	19.01M	5.170525G	5.189535G	Inf	1

802.11ax HEW20_Nss1,(MCS0)_1TX

EBW

5200MHz

01/02/2020

CF
5.2GHz
Span
60MHz
RBW
200kHz
VBW
1MHz
Sweep Time
100ms
Detector Type
Peak
Port 1

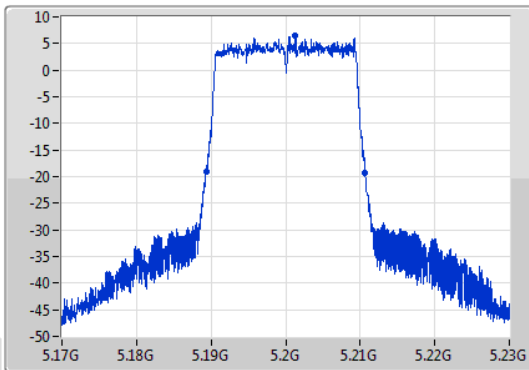

CF
5.2GHz
Span
60MHz
RBW
200kHz
VBW
1MHz
Sweep Time
100ms
Detector Type
Peak

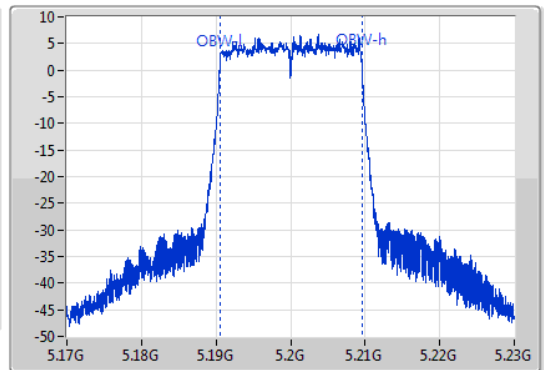

26dB(Hz)	Fl-26dB(Hz)	Fh-26dB(Hz)	OBW(Hz)	Fl-OBW(Hz)	Fh-OBW(Hz)	Limit(Hz)	Port
21.36M	5.18932G	5.21068G	19.01M	5.190525G	5.209535G	Inf	1

802.11ax HEW20_Nss1,(MCS0)_1TX

EBW

5240MHz

01/02/2020

CF
5.24GHz
Span
60MHz
RBW
200kHz
VBW
1MHz
Sweep Time
100ms
Detector Type
Peak
Port 1

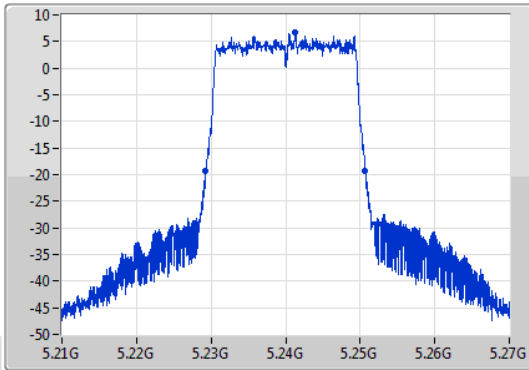

CF
5.24GHz
Span
60MHz
RBW
200kHz
VBW
1MHz
Sweep Time
100ms
Detector Type
Peak

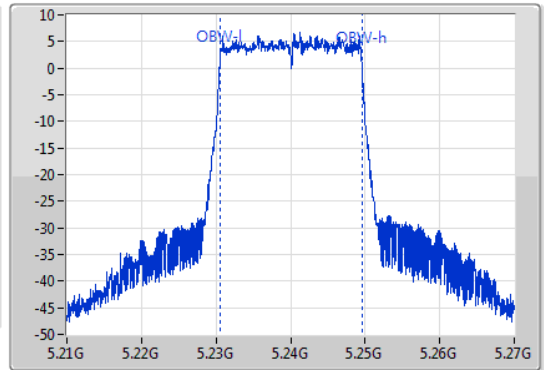

26dB(Hz)	Fl-26dB(Hz)	Fh-26dB(Hz)	OBW(Hz)	Fl-OBW(Hz)	Fh-OBW(Hz)	Limit(Hz)	Port
21.39M	5.22929G	5.25068G	19.01M	5.230525G	5.249535G	Inf	1

802.11ax HEW20_Nss1,(MCS0)_1TX

EBW

5745MHz

31/01/2020

CF
5.745GHz
Span
60MHz
RBW
100kHz
VBW
300kHz
Sweep Time
100ms
Detector Type
Peak
Port 1

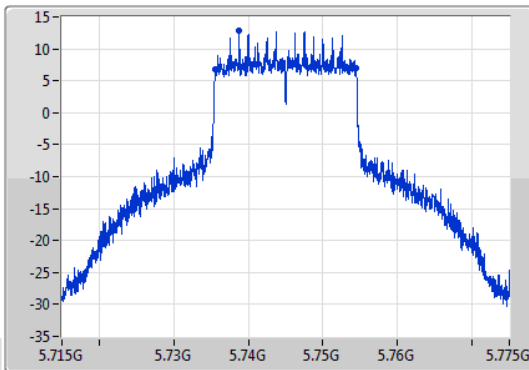

CF
5.745GHz
Span
60MHz
RBW
200kHz
VBW
1MHz
Sweep Time
100ms
Detector Type
Peak

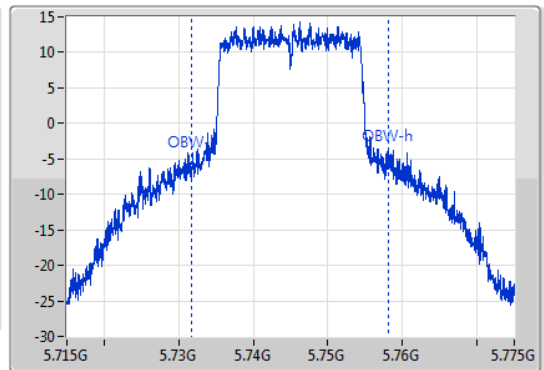

6dB(Hz)	Fl-6dB(Hz)	Fh-6dB(Hz)	OBW(Hz)	Fl-OBW(Hz)	Fh-OBW(Hz)	Limit(Hz)	Port
18.87M	5.73558G	5.75445G	26.297M	5.731777G	5.758073G	500k	1

802.11ax HEW20_Nss1,(MCS0)_1TX

EBW

5785MHz

31/01/2020

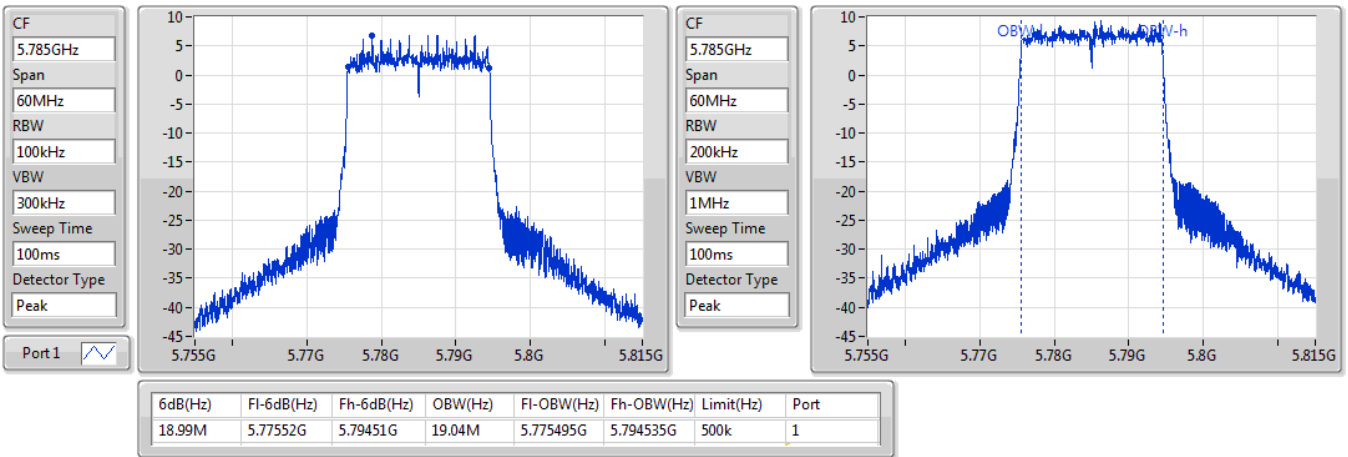

802.11ax HEW20_Nss1,(MCS0)_1TX

EBW

5825MHz

31/01/2020

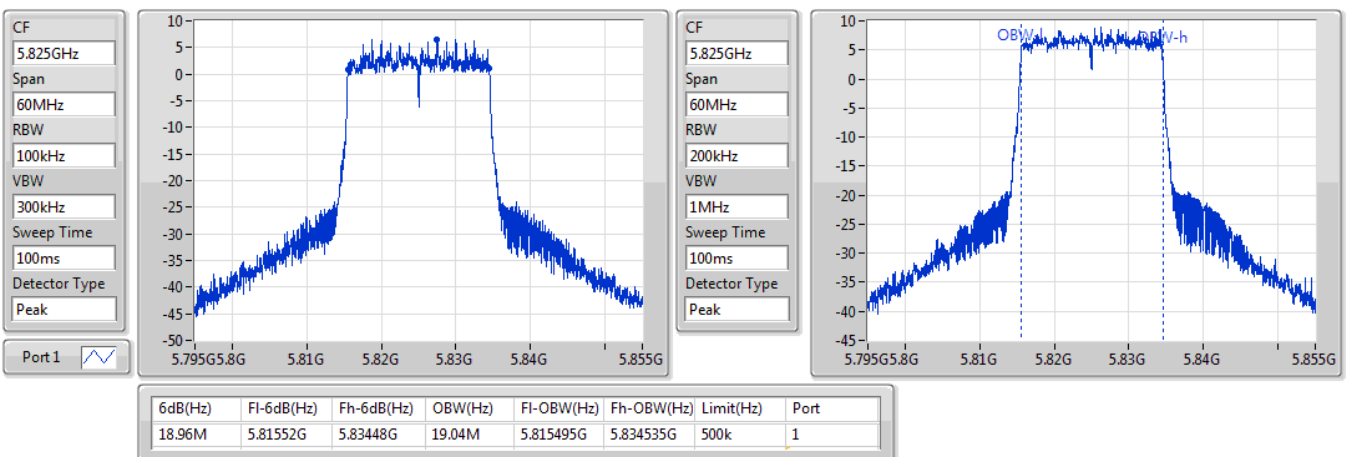

802.11ax HEW40_Nss1,(MCS0)_1TX

EBW

5190MHz

01/02/2020

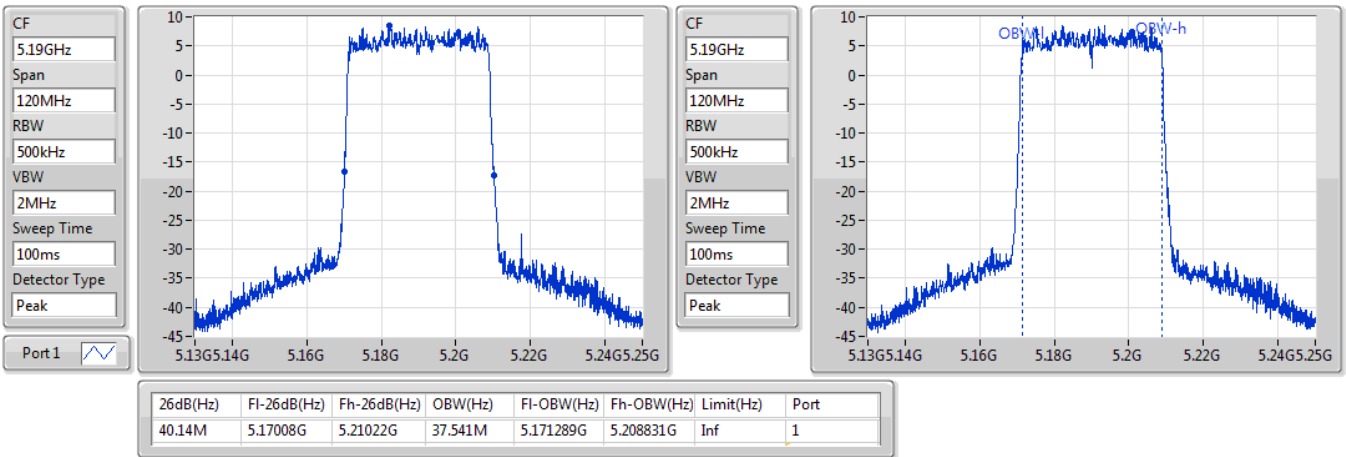

802.11ax HEW40_Nss1,(MCS0)_1TX

EBW

5230MHz

01/02/2020

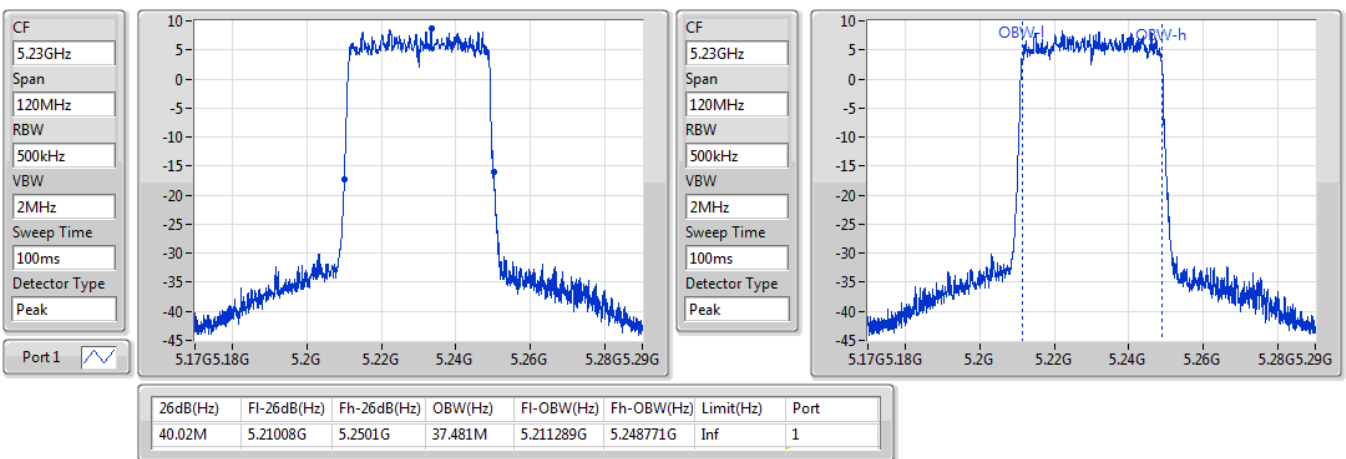

802.11ax HEW40_Nss1,(MCS0)_1TX

EBW

5755MHz

31/01/2020

CF
5.755GHz
Span
120MHz
RBW
100kHz
VBW
300kHz
Sweep Time
100ms
Detector Type
Peak
Port 1

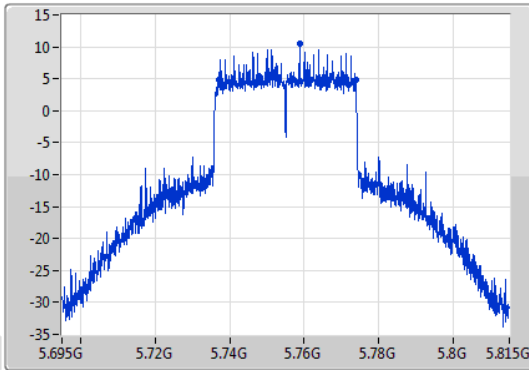

CF
5.755GHz
Span
120MHz
RBW
500kHz
VBW
2MHz
Sweep Time
100ms
Detector Type
Peak

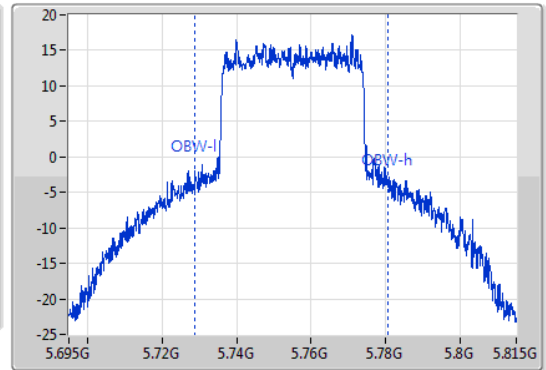

6dB(Hz)	Fl-6dB(Hz)	Fh-6dB(Hz)	OBW(Hz)	Fl-OBW(Hz)	Fh-OBW(Hz)	Limit(Hz)	Port
36.72M	5.737G	5.77372G	51.754M	5.728913G	5.780667G	500k	1

802.11ax HEW40_Nss1,(MCS0)_1TX

EBW

5795MHz

31/01/2020

CF
5.795GHz
Span
120MHz
RBW
100kHz
VBW
300kHz
Sweep Time
100ms
Detector Type
Peak
Port 1

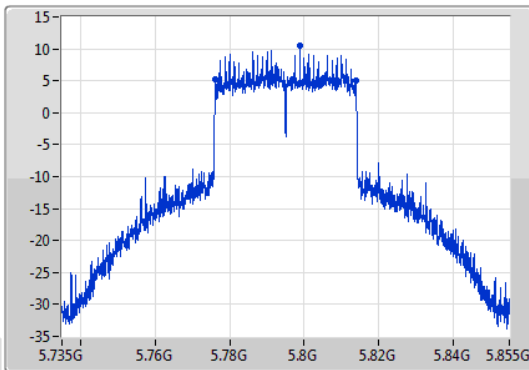

CF
5.795GHz
Span
120MHz
RBW
500kHz
VBW
2MHz
Sweep Time
100ms
Detector Type
Peak

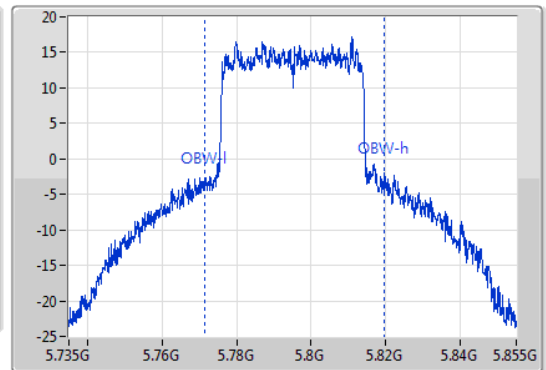

6dB(Hz)	Fl-6dB(Hz)	Fh-6dB(Hz)	OBW(Hz)	Fl-OBW(Hz)	Fh-OBW(Hz)	Limit(Hz)	Port
37.5M	5.77622G	5.81372G	48.216M	5.771312G	5.819528G	500k	1

802.11ax HEW80_Nss1,(MCS0)_1TX

EBW

5210MHz

01/02/2020

CF
5.21GHz
Span
240MHz
RBW
1MHz
VBW
3MHz
Sweep Time
100ms
Detector Type
Peak
Port 1

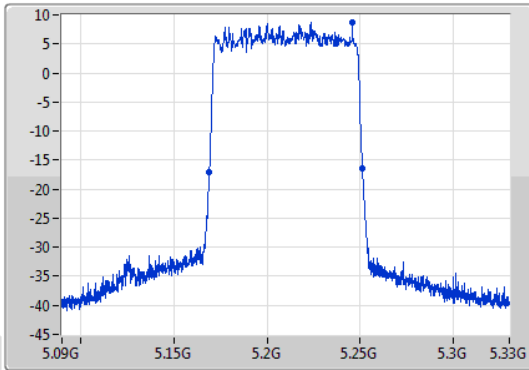

CF
5.21GHz
Span
240MHz
RBW
1MHz
VBW
3MHz
Sweep Time
100ms
Detector Type
Peak

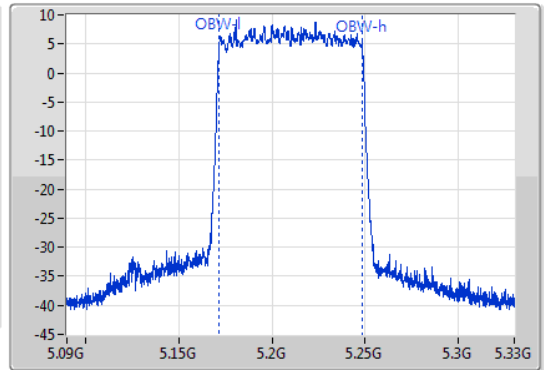

26dB(Hz)	Fl-26dB(Hz)	Fh-26dB(Hz)	OBW(Hz)	Fl-OBW(Hz)	Fh-OBW(Hz)	Limit(Hz)	Port
82.08M	5.16908G	5.25116G	77.121M	5.171499G	5.248621G	Inf	1

802.11ax HEW80_Nss1,(MCS0)_1TX

EBW

5775MHz

31/01/2020

CF
5.775GHz
Span
240MHz
RBW
100kHz
VBW
300kHz
Sweep Time
100ms
Detector Type
Peak
Port 1

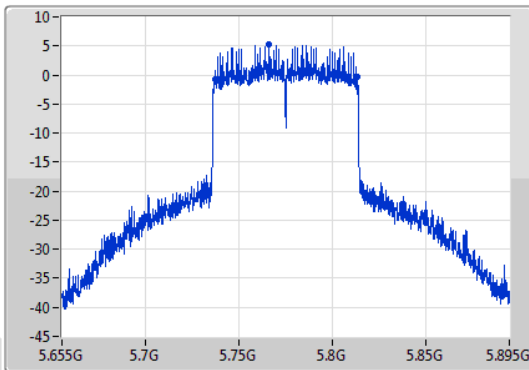

CF
5.775GHz
Span
240MHz
RBW
1MHz
VBW
3MHz
Sweep Time
100ms
Detector Type
Peak

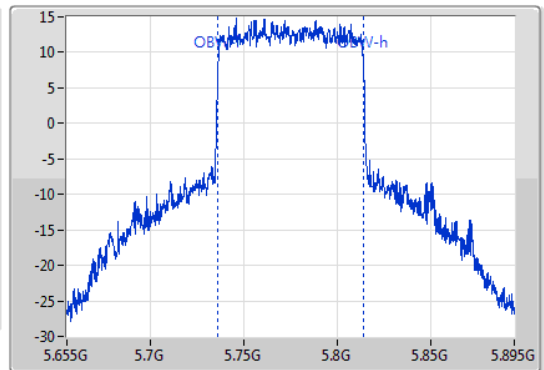

6dB(Hz)	Fl-6dB(Hz)	Fh-6dB(Hz)	OBW(Hz)	Fl-OBW(Hz)	Fh-OBW(Hz)	Limit(Hz)	Port
75.96M	5.7372G	5.81316G	78.201M	5.736019G	5.81422G	500k	1



Summary

Mode	Max-N dB (Hz)	Max-OBW (Hz)	ITU-Code	Min-N dB (Hz)	Min-OBW (Hz)
5.15-5.25GHz	-	-	-	-	-
802.11a_Nss1,(6Mbps)_2TX	21.24M	16.762M	16M8D1D	21.06M	16.642M
802.11ac VHT20_Nss2,(MCS0)_2TX	21.6M	17.871M	17M9D1D	21.3M	17.781M
802.11ac VHT40_Nss2,(MCS0)_2TX	40.2M	36.402M	36M4D1D	39.78M	36.342M
802.11ac VHT80_Nss2,(MCS0)_2TX	81.72M	75.802M	75M8D1D	81.6M	75.802M
802.11ax HEW20_Nss2,(MCS0)_2TX	21.57M	19.04M	19M0D1D	21.39M	19.01M
802.11ax HEW40_Nss2,(MCS0)_2TX	40.14M	37.601M	37M6D1D	40.02M	37.541M
802.11ax HEW80_Nss2,(MCS0)_2TX	81.24M	77.001M	77M0D1D	81.24M	77.001M
5.725-5.85GHz	-	-	-	-	-
802.11a_Nss1,(6Mbps)_2TX	16.38M	17.151M	17M2D1D	16.32M	16.642M
802.11ac VHT20_Nss2,(MCS0)_2TX	17.58M	17.961M	18M0D1D	17.55M	17.781M
802.11ac VHT40_Nss2,(MCS0)_2TX	36.3M	37.121M	37M1D1D	36.3M	36.342M
802.11ac VHT80_Nss2,(MCS0)_2TX	75.72M	76.522M	76M5D1D	75.6M	76.402M
802.11ax HEW20_Nss2,(MCS0)_2TX	18.96M	19.1M	19M1D1D	18.84M	19.04M
802.11ax HEW40_Nss2,(MCS0)_2TX	37.5M	38.081M	38M1D1D	36.96M	37.601M
802.11ax HEW80_Nss2,(MCS0)_2TX	76.8M	77.601M	77M6D1D	75.24M	77.601M

Max-N dB = Maximum 6dB down bandwidth for 5.725-5.85GHz band / Maximum 26dB down bandwidth for other band;

Max-OBW = Maximum 99% occupied bandwidth;

Min-N dB = Minimum 6dB down bandwidth for 5.725-5.85GHz band / Maximum 26dB down bandwidth for other band;

Min-OBW = Minimum 99% occupied bandwidth;



Result

Mode	Result	Limit (Hz)	Port 1-N dB (Hz)	Port 1-OBW (Hz)	Port 2-N dB (Hz)	Port 2-OBW (Hz)
802.11a_Nss1,(6Mbps)_2TX	-	-	-	-	-	-
5180MHz	Pass	Inf	21.24M	16.732M	21.06M	16.642M
5200MHz	Pass	Inf	21.24M	16.762M	21.06M	16.642M
5240MHz	Pass	Inf	21.21M	16.762M	21.09M	16.642M
5745MHz	Pass	500k	16.32M	17.031M	16.35M	17.151M
5785MHz	Pass	500k	16.38M	16.762M	16.35M	16.672M
5825MHz	Pass	500k	16.35M	16.762M	16.32M	16.642M
802.11ac VHT20_Nss2,(MCS0)_2TX	-	-	-	-	-	-
5180MHz	Pass	Inf	21.54M	17.871M	21.39M	17.781M
5200MHz	Pass	Inf	21.6M	17.871M	21.3M	17.781M
5240MHz	Pass	Inf	21.54M	17.871M	21.42M	17.781M
5745MHz	Pass	500k	17.58M	17.961M	17.58M	17.871M
5785MHz	Pass	500k	17.55M	17.871M	17.58M	17.781M
5825MHz	Pass	500k	17.58M	17.901M	17.58M	17.781M
802.11ac VHT40_Nss2,(MCS0)_2TX	-	-	-	-	-	-
5190MHz	Pass	Inf	39.78M	36.402M	39.9M	36.342M
5230MHz	Pass	Inf	40.2M	36.402M	39.78M	36.342M
5755MHz	Pass	500k	36.3M	37.121M	36.3M	36.582M
5795MHz	Pass	500k	36.3M	36.462M	36.3M	36.342M
802.11ac VHT80_Nss2,(MCS0)_2TX	-	-	-	-	-	-
5210MHz	Pass	Inf	81.72M	75.802M	81.6M	75.802M
5775MHz	Pass	500k	75.6M	76.402M	75.72M	76.522M
802.11ax HEW20_Nss2,(MCS0)_2TX	-	-	-	-	-	-
5180MHz	Pass	Inf	21.57M	19.01M	21.39M	19.04M
5200MHz	Pass	Inf	21.51M	19.01M	21.39M	19.04M
5240MHz	Pass	Inf	21.57M	19.04M	21.39M	19.04M
5745MHz	Pass	500k	18.96M	19.04M	18.93M	19.1M
5785MHz	Pass	500k	18.96M	19.04M	18.87M	19.04M
5825MHz	Pass	500k	18.96M	19.04M	18.84M	19.04M
802.11ax HEW40_Nss2,(MCS0)_2TX	-	-	-	-	-	-
5190MHz	Pass	Inf	40.02M	37.601M	40.08M	37.541M
5230MHz	Pass	Inf	40.02M	37.601M	40.14M	37.541M
5755MHz	Pass	500k	37.5M	38.081M	37.02M	37.961M
5795MHz	Pass	500k	37.5M	37.721M	36.96M	37.601M
802.11ax HEW80_Nss2,(MCS0)_2TX	-	-	-	-	-	-
5210MHz	Pass	Inf	81.24M	77.001M	81.24M	77.001M
5775MHz	Pass	500k	76.8M	77.601M	75.24M	77.601M

Port X-N dB = Port X 6dB down bandwidth for 5.725-5.85GHz band / 26dB down bandwidth for other band
Port X-OBW = Port X 99% occupied bandwidth;

802.11a_Nss1,(6Mbps)_2TX

EBW

5180MHz

03/02/2020

CF
5.18GHz
Span
60MHz
RBW
200kHz
VBW
1MHz
Sweep Time
100ms
Detector Type
Peak

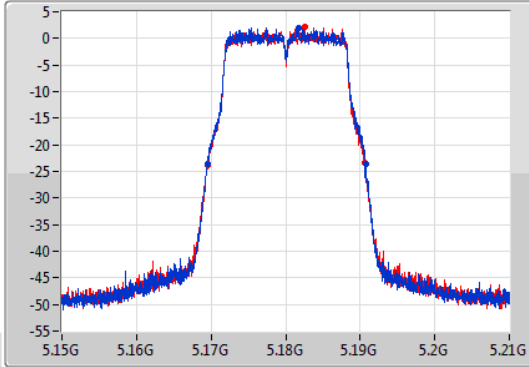

CF
5.18GHz
Span
60MHz
RBW
200kHz
VBW
1MHz
Sweep Time
100ms
Detector Type
Peak

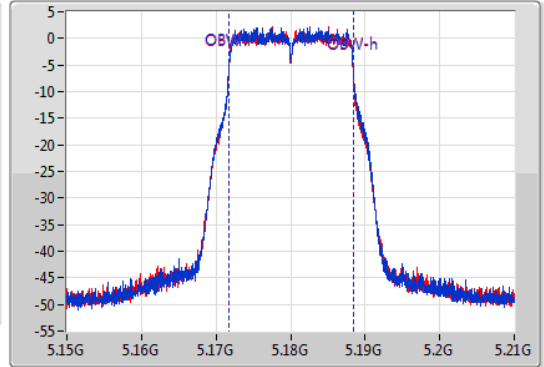

26dB(Hz)	Fl-26dB(Hz)	Fh-26dB(Hz)	OBW(Hz)	Fl-OBW(Hz)	Fh-OBW(Hz)	Limit(Hz)	Port
21.24M	5.1695G	5.19074G	16.732M	5.171724G	5.188456G	Inf	1
21.06M	5.16953G	5.19059G	16.642M	5.171724G	5.188366G	Inf	2

802.11a_Nss1,(6Mbps)_2TX

EBW

5200MHz

03/02/2020

CF
5.2GHz
Span
60MHz
RBW
200kHz
VBW
1MHz
Sweep Time
100ms
Detector Type
Peak

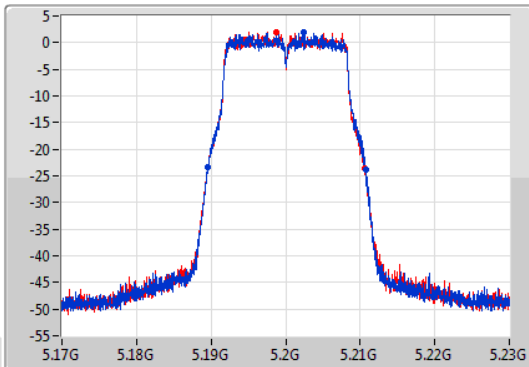

CF
5.2GHz
Span
60MHz
RBW
200kHz
VBW
1MHz
Sweep Time
100ms
Detector Type
Peak

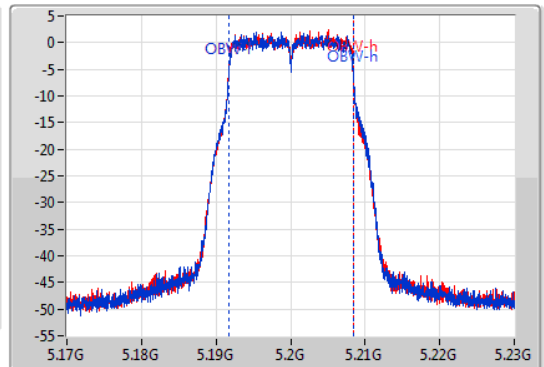

26dB(Hz)	Fl-26dB(Hz)	Fh-26dB(Hz)	OBW(Hz)	Fl-OBW(Hz)	Fh-OBW(Hz)	Limit(Hz)	Port
21.24M	5.18953G	5.21077G	16.762M	5.191694G	5.208456G	Inf	1
21.06M	5.18953G	5.21059G	16.642M	5.191724G	5.208366G	Inf	2

802.11a_Nss1,(6Mbps)_2TX

EBW

5240MHz

03/02/2020

CF
5.24GHz
Span
60MHz
RBW
200kHz
VBW
1MHz
Sweep Time
100ms
Detector Type
Peak

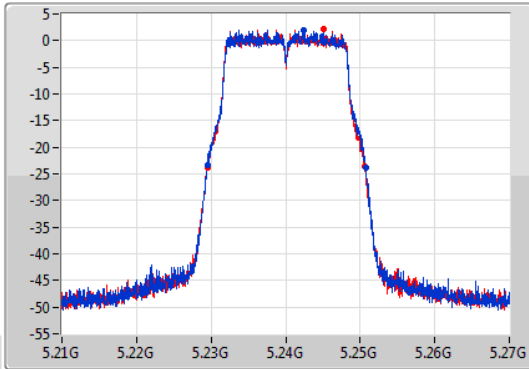

CF
5.24GHz
Span
60MHz
RBW
200kHz
VBW
1MHz
Sweep Time
100ms
Detector Type
Peak

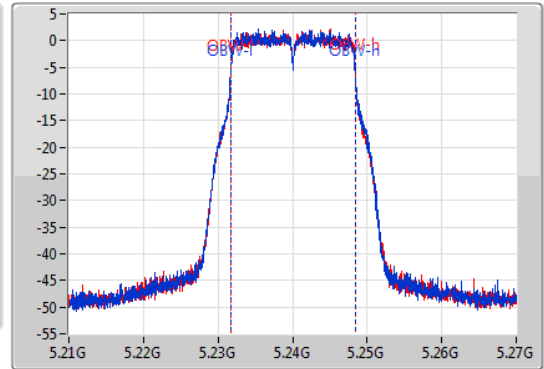

6dB(Hz)	Fl-26dB(Hz)	Fh-26dB(Hz)	OBW(Hz)	Fl-OBW(Hz)	Fh-OBW(Hz)	Limit(Hz)	Port
21.21M	5.22953G	5.25074G	16.762M	5.231694G	5.248456G	Inf	1
21.09M	5.2295G	5.25059G	16.642M	5.231724G	5.248366G	Inf	2

802.11a_Nss1,(6Mbps)_2TX

EBW

5745MHz

03/02/2020

CF
5.745GHz
Span
60MHz
RBW
100kHz
VBW
300kHz
Sweep Time
100ms
Detector Type
Peak

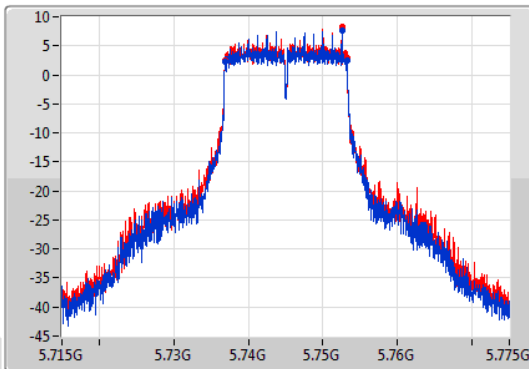

CF
5.745GHz
Span
60MHz
RBW
200kHz
VBW
1MHz
Sweep Time
100ms
Detector Type
Peak

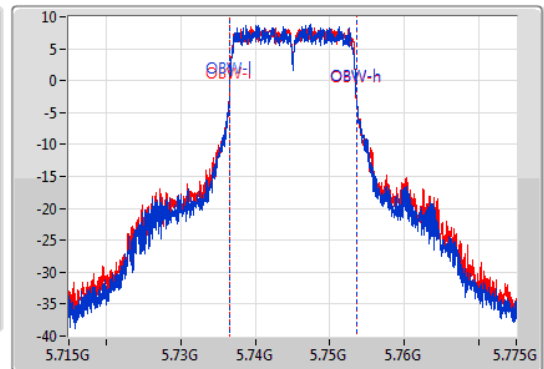

6dB(Hz)	Fl-6dB(Hz)	Fh-6dB(Hz)	OBW(Hz)	Fl-OBW(Hz)	Fh-OBW(Hz)	Limit(Hz)	Port
16.32M	5.73687G	5.75319G	17.031M	5.736574G	5.753606G	500k	1
16.35M	5.73687G	5.75322G	17.151M	5.736484G	5.753636G	500k	2

802.11a_Nss1,(6Mbps)_2TX

EBW

5785MHz

03/02/2020

CF
5.785GHz
Span
60MHz
RBW
100kHz
VBW
300kHz
Sweep Time
100ms
Detector Type
Peak

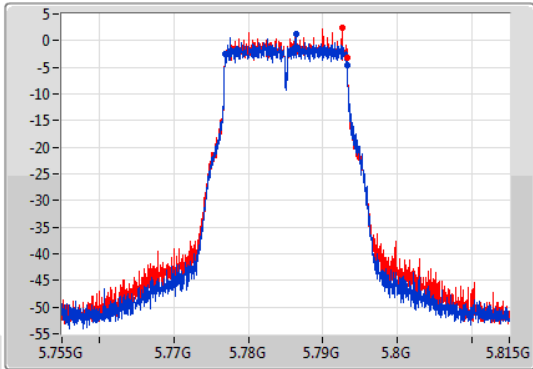

CF
5.785GHz
Span
60MHz
RBW
200kHz
VBW
1MHz
Sweep Time
100ms
Detector Type
Peak

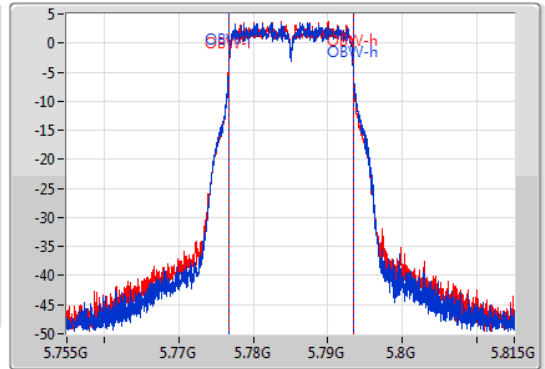

6dB(Hz)	Fl-6dB(Hz)	Fh-6dB(Hz)	OBW(Hz)	Fl-OBW(Hz)	Fh-OBW(Hz)	Limit(Hz)	Port
16.38M	5.77687G	5.79325G	16.762M	5.776694G	5.793456G	500k	1
16.35M	5.77687G	5.79322G	16.672M	5.776694G	5.793366G	500k	2

802.11a_Nss1,(6Mbps)_2TX

EBW

5825MHz

03/02/2020

CF
5.825GHz
Span
60MHz
RBW
100kHz
VBW
300kHz
Sweep Time
100ms
Detector Type
Peak

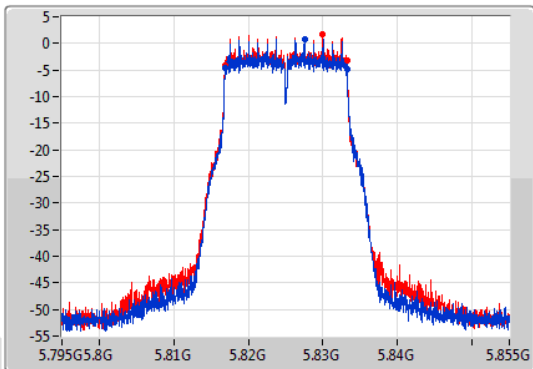

CF
5.825GHz
Span
60MHz
RBW
200kHz
VBW
1MHz
Sweep Time
100ms
Detector Type
Peak

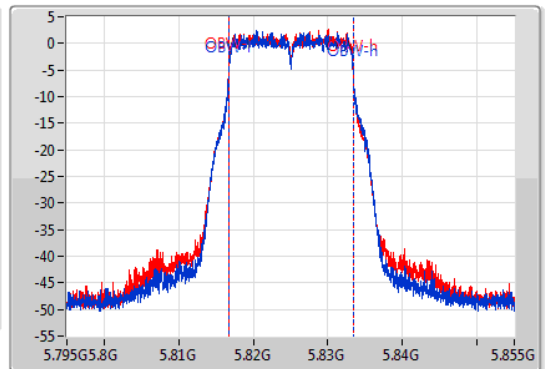

6dB(Hz)	Fl-6dB(Hz)	Fh-6dB(Hz)	OBW(Hz)	Fl-OBW(Hz)	Fh-OBW(Hz)	Limit(Hz)	Port
16.35M	5.81687G	5.83322G	16.762M	5.816694G	5.833456G	500k	1
16.32M	5.81687G	5.83319G	16.642M	5.816724G	5.833366G	500k	2

802.11ac VHT20_Nss2,(MCS0)_2TX

EBW

5180MHz

03/02/2020

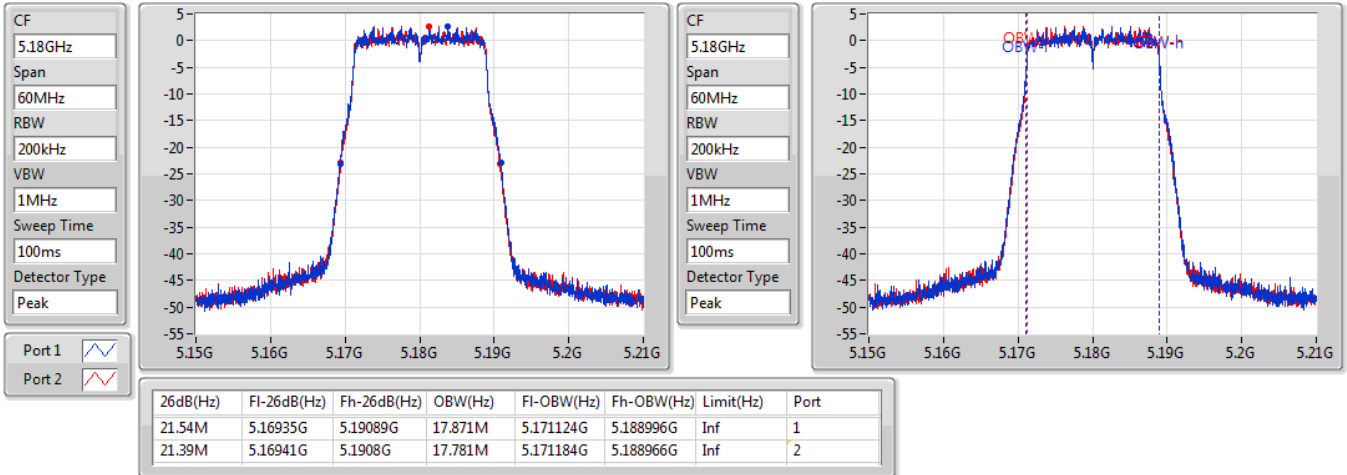

802.11ac VHT20_Nss2,(MCS0)_2TX

EBW

5200MHz

03/02/2020

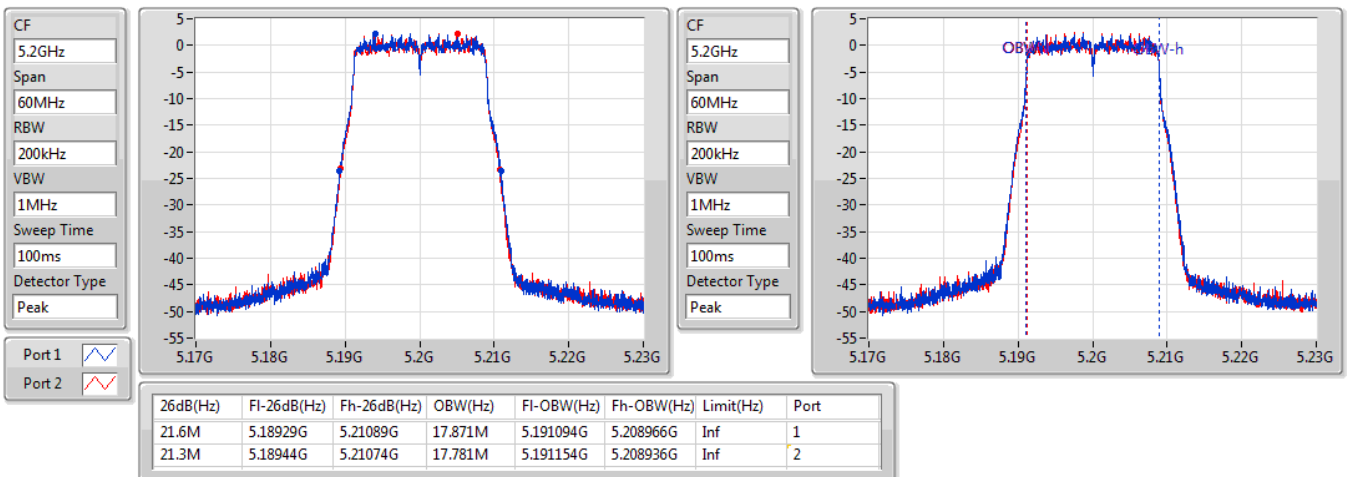

802.11ac VHT20_Nss2,(MCS0)_2TX

EBW

5240MHz

03/02/2020

CF
5.24GHz
Span
60MHz
RBW
200kHz
VBW
1MHz
Sweep Time
100ms
Detector Type
Peak

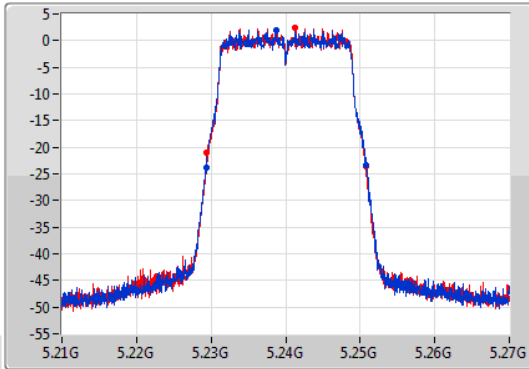

CF
5.24GHz
Span
60MHz
RBW
200kHz
VBW
1MHz
Sweep Time
100ms
Detector Type
Peak

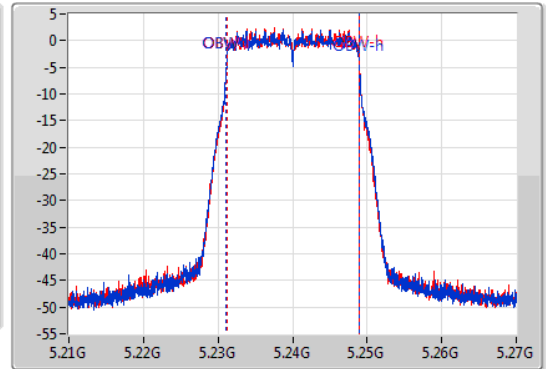

26dB(Hz)	Fl-26dB(Hz)	Fh-26dB(Hz)	OBW(Hz)	Fl-OBW(Hz)	Fh-OBW(Hz)	Limit(Hz)	Port
21.54M	5.22932G	5.25086G	17.871M	5.231094G	5.248966G	Inf	1
21.42M	5.22938G	5.2508G	17.781M	5.231154G	5.248936G	Inf	2

802.11ac VHT20_Nss2,(MCS0)_2TX

EBW

5745MHz

03/02/2020

CF
5.745GHz
Span
60MHz
RBW
100kHz
VBW
300kHz
Sweep Time
100ms
Detector Type
Peak

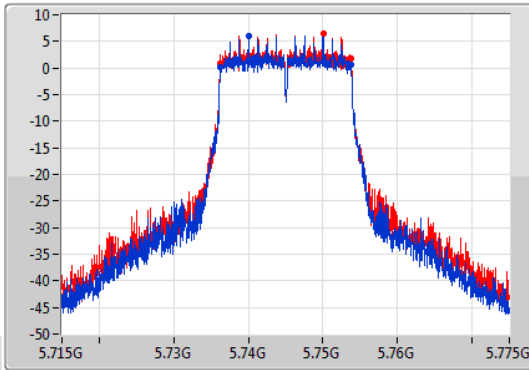

CF
5.745GHz
Span
60MHz
RBW
200kHz
VBW
1MHz
Sweep Time
100ms
Detector Type
Peak

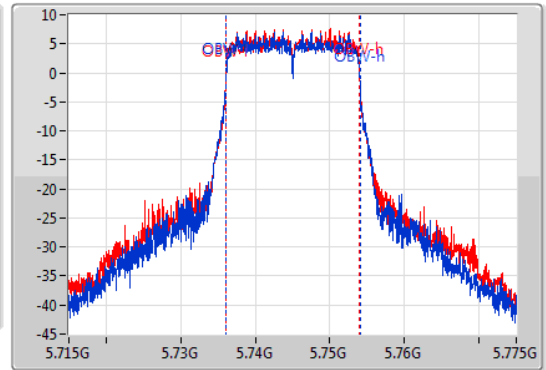

6dB(Hz)	Fl-6dB(Hz)	Fh-6dB(Hz)	OBW(Hz)	Fl-OBW(Hz)	Fh-OBW(Hz)	Limit(Hz)	Port
17.58M	5.73624G	5.75382G	17.961M	5.736064G	5.754025G	500k	1
17.58M	5.73624G	5.75382G	17.871M	5.736094G	5.753966G	500k	2

802.11ac VHT20_Nss2,(MCS0)_2TX

EBW

5785MHz

03/02/2020

CF
5.785GHz
Span
60MHz
RBW
100kHz
VBW
300kHz
Sweep Time
100ms
Detector Type
Peak

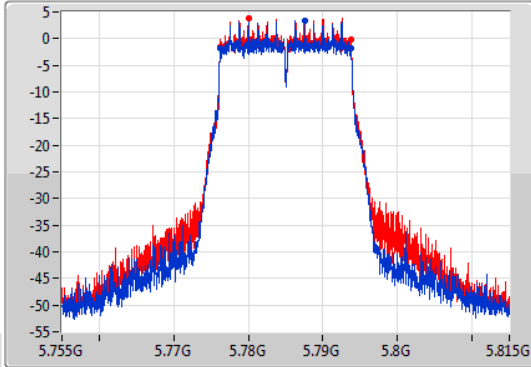

CF
5.785GHz
Span
60MHz
RBW
200kHz
VBW
1MHz
Sweep Time
100ms
Detector Type
Peak

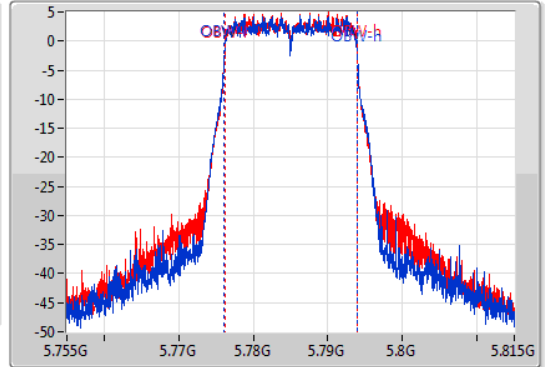

6dB(Hz)	Fl-6dB(Hz)	Fh-6dB(Hz)	OBW(Hz)	Fl-OBW(Hz)	Fh-OBW(Hz)	Limit(Hz)	Port
17.55M	5.77627G	5.79382G	17.871M	5.776094G	5.793966G	500k	1
17.58M	5.77624G	5.79382G	17.781M	5.776154G	5.793936G	500k	2

802.11ac VHT20_Nss2,(MCS0)_2TX

EBW

5825MHz

03/02/2020

CF
5.825GHz
Span
60MHz
RBW
100kHz
VBW
300kHz
Sweep Time
100ms
Detector Type
Peak

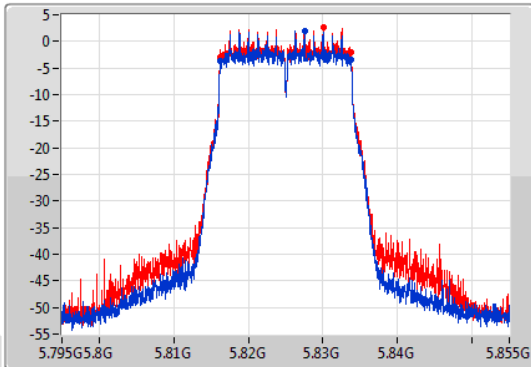

CF
5.825GHz
Span
60MHz
RBW
200kHz
VBW
1MHz
Sweep Time
100ms
Detector Type
Peak

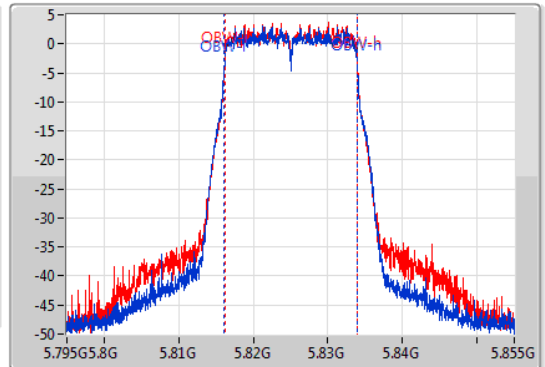

6dB(Hz)	Fl-6dB(Hz)	Fh-6dB(Hz)	OBW(Hz)	Fl-OBW(Hz)	Fh-OBW(Hz)	Limit(Hz)	Port
17.58M	5.81624G	5.83382G	17.901M	5.816064G	5.833966G	500k	1
17.58M	5.81624G	5.83382G	17.781M	5.816154G	5.833936G	500k	2

802.11ac VHT40_Nss2,(MCS0)_2TX

EBW

5190MHz

03/02/2020

CF
5.19GHz
Span
120MHz
RBW
500kHz
VBW
2MHz
Sweep Time
100ms
Detector Type
Peak

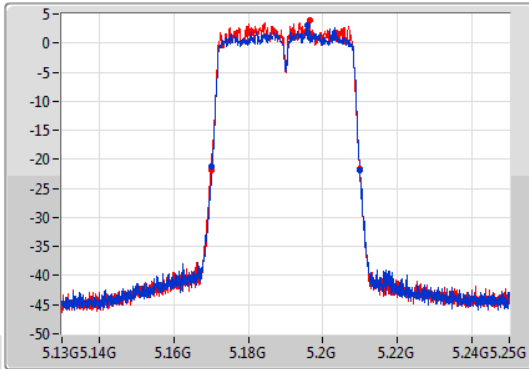

CF
5.19GHz
Span
120MHz
RBW
500kHz
VBW
2MHz
Sweep Time
100ms
Detector Type
Peak

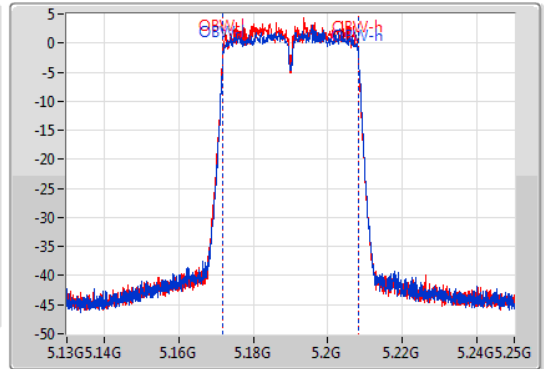

26dB(Hz)	Fl-26dB(Hz)	Fh-26dB(Hz)	OBW(Hz)	Fl-OBW(Hz)	Fh-OBW(Hz)	Limit(Hz)	Port
39.78M	5.17014G	5.20992G	36.402M	5.171889G	5.208291G	Inf	1
39.9M	5.16996G	5.20986G	36.342M	5.171829G	5.208171G	Inf	2

802.11ac VHT40_Nss2,(MCS0)_2TX

EBW

5230MHz

03/02/2020

CF
5.23GHz
Span
120MHz
RBW
500kHz
VBW
2MHz
Sweep Time
100ms
Detector Type
Peak

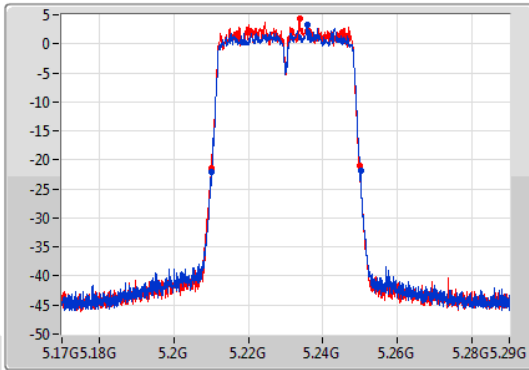

CF
5.23GHz
Span
120MHz
RBW
500kHz
VBW
2MHz
Sweep Time
100ms
Detector Type
Peak

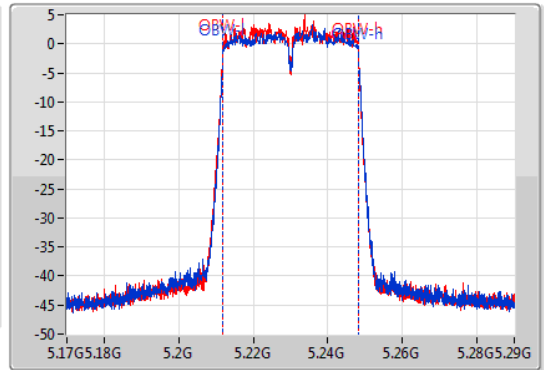

26dB(Hz)	Fl-26dB(Hz)	Fh-26dB(Hz)	OBW(Hz)	Fl-OBW(Hz)	Fh-OBW(Hz)	Limit(Hz)	Port
40.2M	5.21002G	5.25022G	36.402M	5.211889G	5.248291G	Inf	1
39.78M	5.21002G	5.2498G	36.342M	5.211829G	5.248171G	Inf	2

802.11ac VHT40_Nss2,(MCS0)_2TX

EBW

5755MHz

03/02/2020

CF
5.755GHz

Span
120MHz

RBW
100kHz

VBW
300kHz

Sweep Time
100ms

Detector Type
Peak

Port 1

Port 2

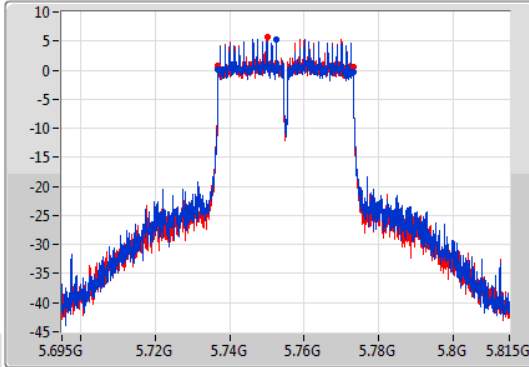

CF
5.755GHz

Span
120MHz

RBW
500kHz

VBW
2MHz

Sweep Time
100ms

Detector Type
Peak

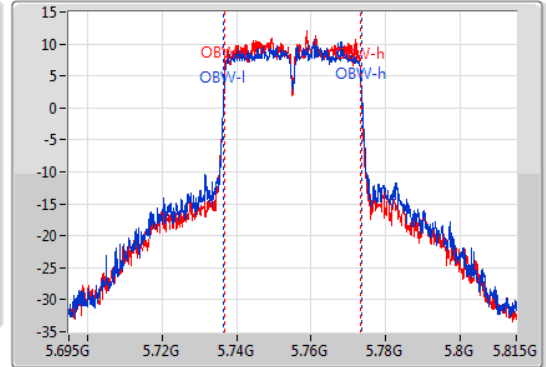

6dB(Hz)	Fl-6dB(Hz)	Fh-6dB(Hz)	OBW(Hz)	Fl-OBW(Hz)	Fh-OBW(Hz)	Limit(Hz)	Port
36.3M	5.73688G	5.77318G	37.121M	5.736529G	5.773651G	500k	1
36.3M	5.73688G	5.77318G	36.582M	5.736709G	5.773291G	500k	2

802.11ac VHT40_Nss2,(MCS0)_2TX

EBW

5795MHz

03/02/2020

CF
5.795GHz

Span
120MHz

RBW
100kHz

VBW
300kHz

Sweep Time
100ms

Detector Type
Peak

Port 1

Port 2

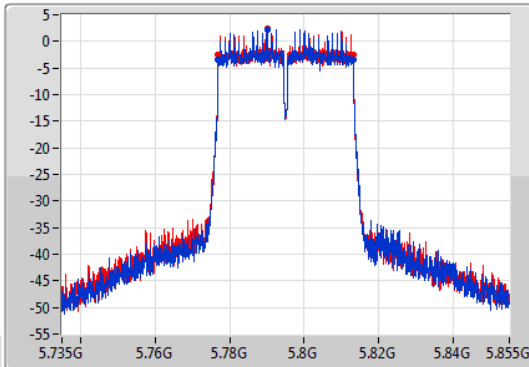

CF
5.795GHz

Span
120MHz

RBW
500kHz

VBW
2MHz

Sweep Time
100ms

Detector Type
Peak

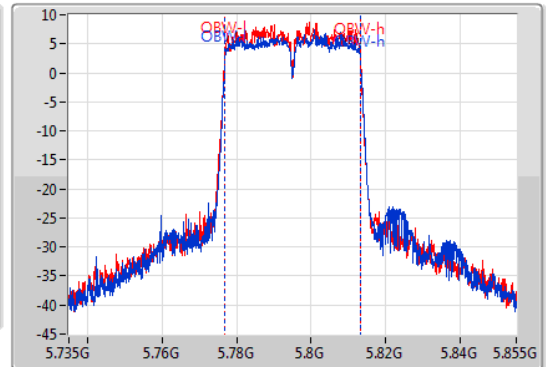

6dB(Hz)	Fl-6dB(Hz)	Fh-6dB(Hz)	OBW(Hz)	Fl-OBW(Hz)	Fh-OBW(Hz)	Limit(Hz)	Port
36.3M	5.77688G	5.81318G	36.462M	5.776829G	5.813291G	500k	1
36.3M	5.77688G	5.81318G	36.342M	5.776829G	5.813171G	500k	2

802.11ac VHT80_Nss2,(MCS0)_2TX

EBW

5210MHz

03/02/2020

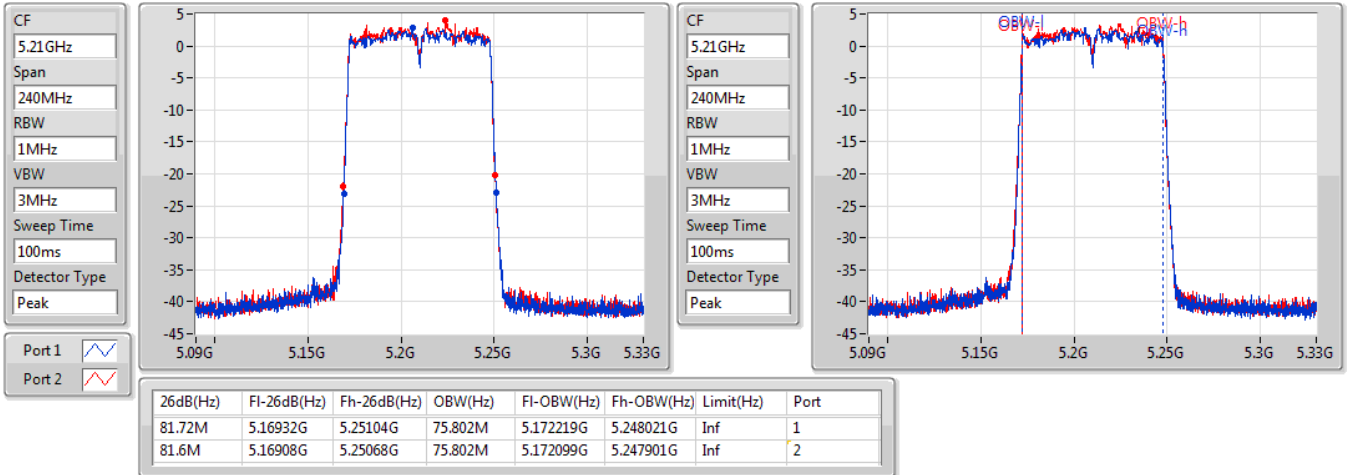

802.11ac VHT80_Nss2,(MCS0)_2TX

EBW

5775MHz

03/02/2020

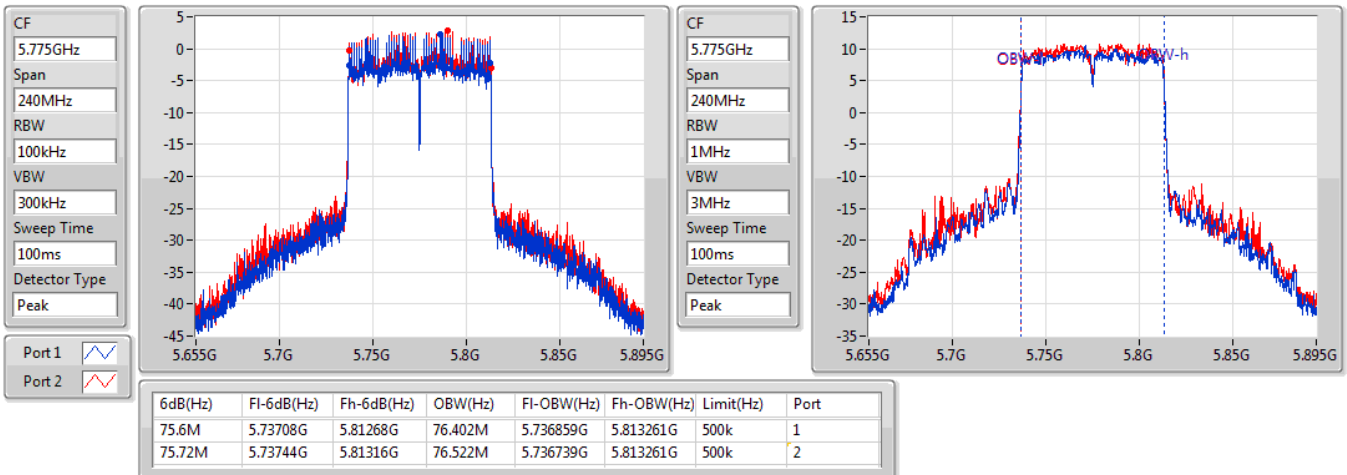

802.11ax HEW20_Nss2,(MCS0)_2TX

EBW

5180MHz

03/02/2020

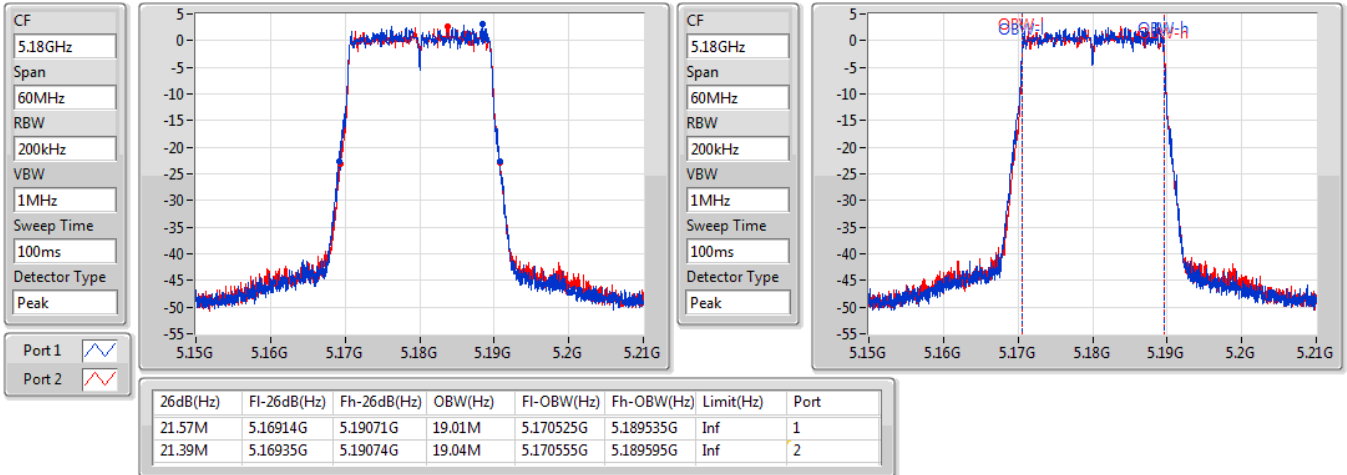

802.11ax HEW20_Nss2,(MCS0)_2TX

EBW

5200MHz

03/02/2020

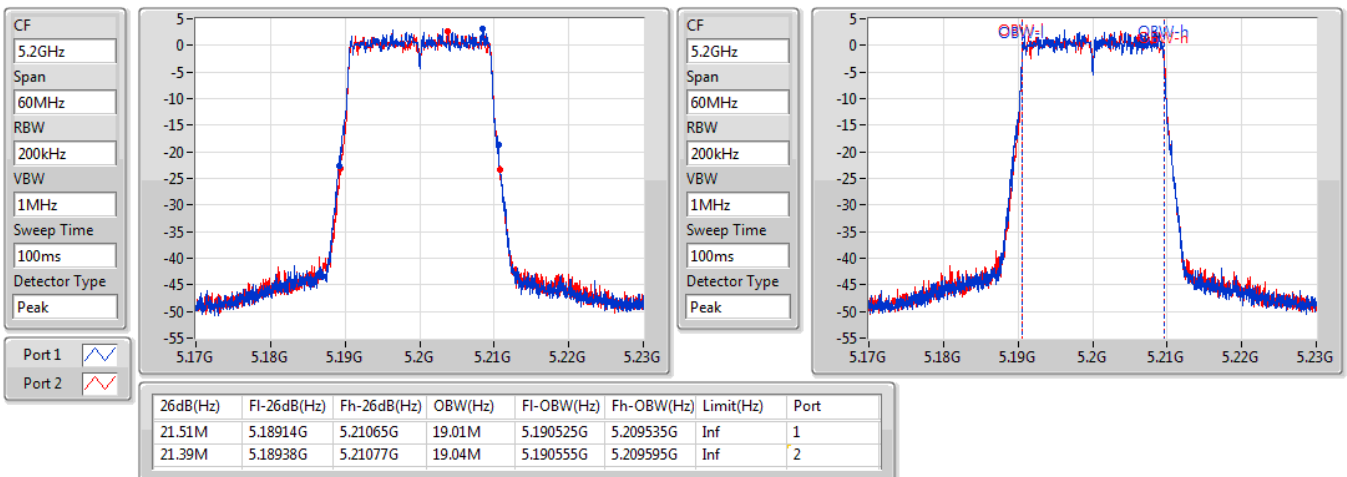

802.11ax HEW20_Nss2,(MCS0)_2TX

EBW

5240MHz

03/02/2020

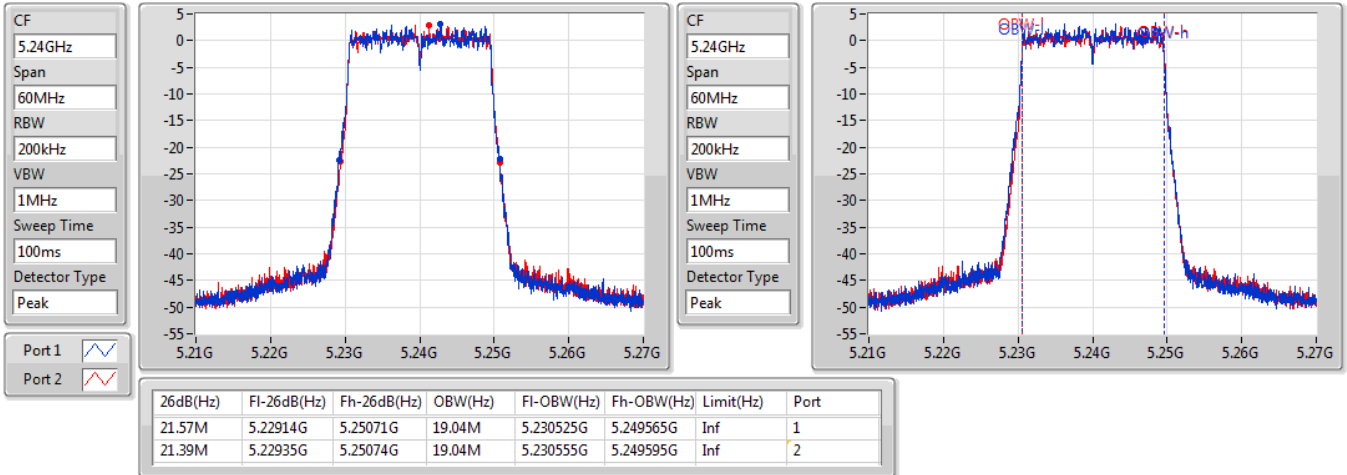

802.11ax HEW20_Nss2,(MCS0)_2TX

EBW

5745MHz

03/02/2020

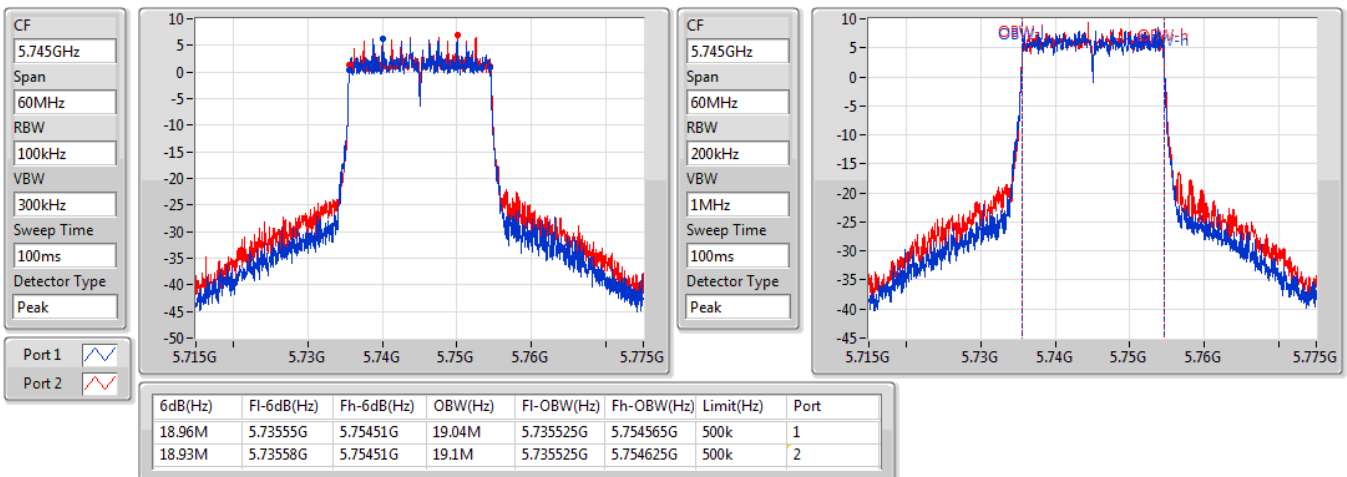

802.11ax HEW20_Nss2,(MCS0)_2TX

EBW

5785MHz

03/02/2020

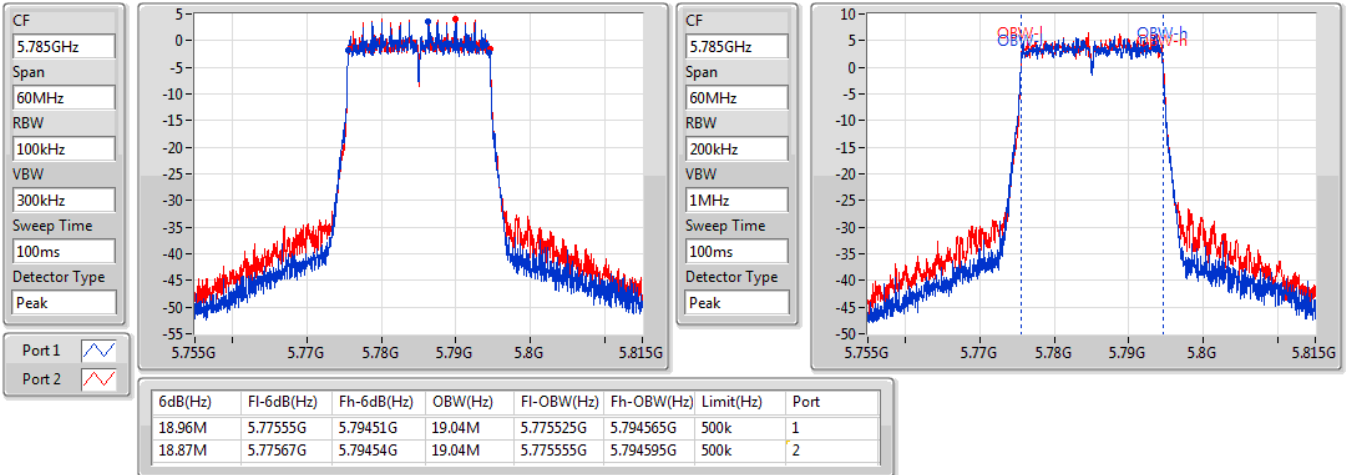

802.11ax HEW20_Nss2,(MCS0)_2TX

EBW

5825MHz

03/02/2020

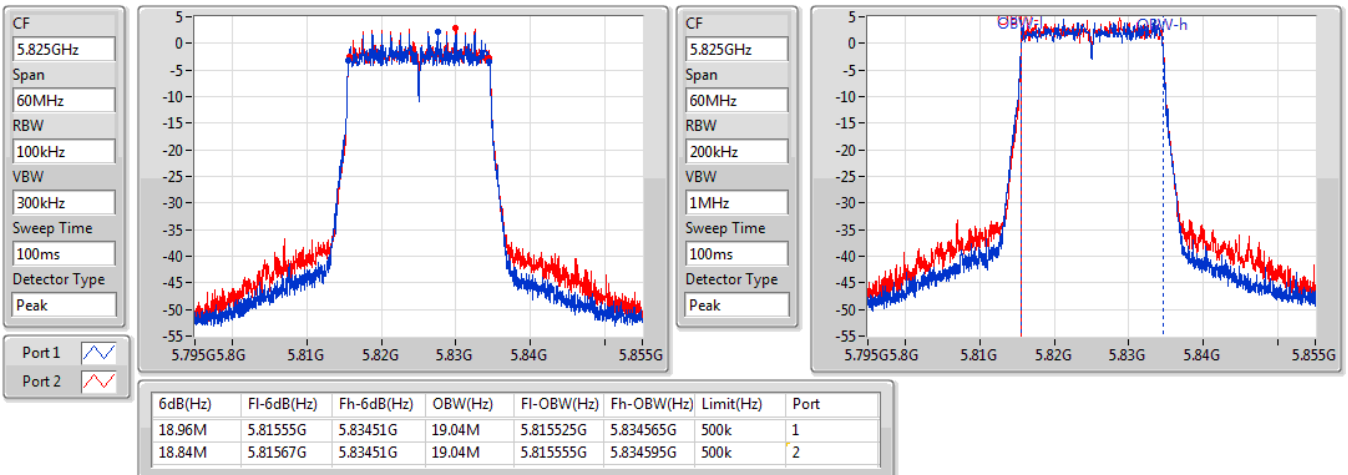

802.11ax HEW40_Nss2,(MCS0)_2TX

EBW

5190MHz

03/02/2020

CF
5.19GHz
Span
120MHz
RBW
500kHz
VBW
2MHz
Sweep Time
100ms
Detector Type
Peak

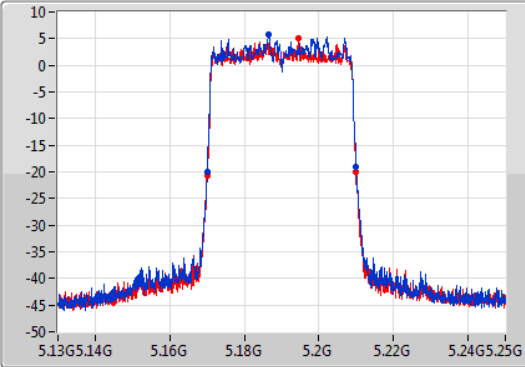

CF
5.19GHz
Span
120MHz
RBW
500kHz
VBW
2MHz
Sweep Time
100ms
Detector Type
Peak

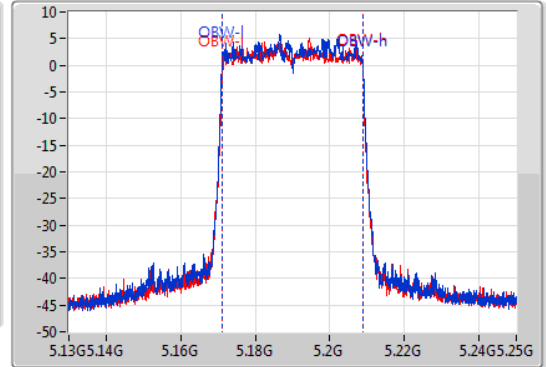

26dB(Hz)	Fl-26dB(Hz)	Fh-26dB(Hz)	OBW(Hz)	Fl-OBW(Hz)	Fh-OBW(Hz)	Limit(Hz)	Port
40.02M	5.17002G	5.21004G	37.601M	5.171169G	5.208771G	Inf	1
40.08M	5.16996G	5.21004G	37.541M	5.171229G	5.208771G	Inf	2

802.11ax HEW40_Nss2,(MCS0)_2TX

EBW

5230MHz

03/02/2020

CF
5.23GHz
Span
120MHz
RBW
500kHz
VBW
2MHz
Sweep Time
100ms
Detector Type
Peak

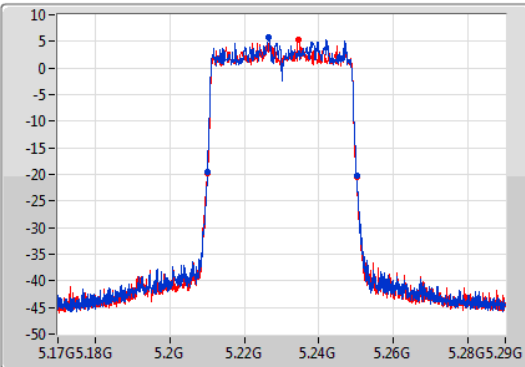

CF
5.23GHz
Span
120MHz
RBW
500kHz
VBW
2MHz
Sweep Time
100ms
Detector Type
Peak

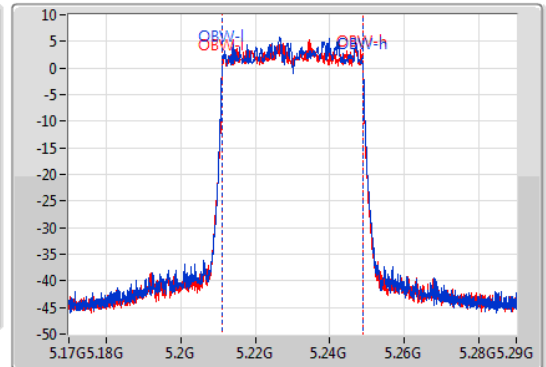

26dB(Hz)	Fl-26dB(Hz)	Fh-26dB(Hz)	OBW(Hz)	Fl-OBW(Hz)	Fh-OBW(Hz)	Limit(Hz)	Port
40.02M	5.21008G	5.2501G	37.601M	5.211169G	5.248771G	Inf	1
40.14M	5.20996G	5.2501G	37.541M	5.211229G	5.248771G	Inf	2

802.11ax HEW40_Nss2,(MCS0)_2TX

EBW

5755MHz

03/02/2020

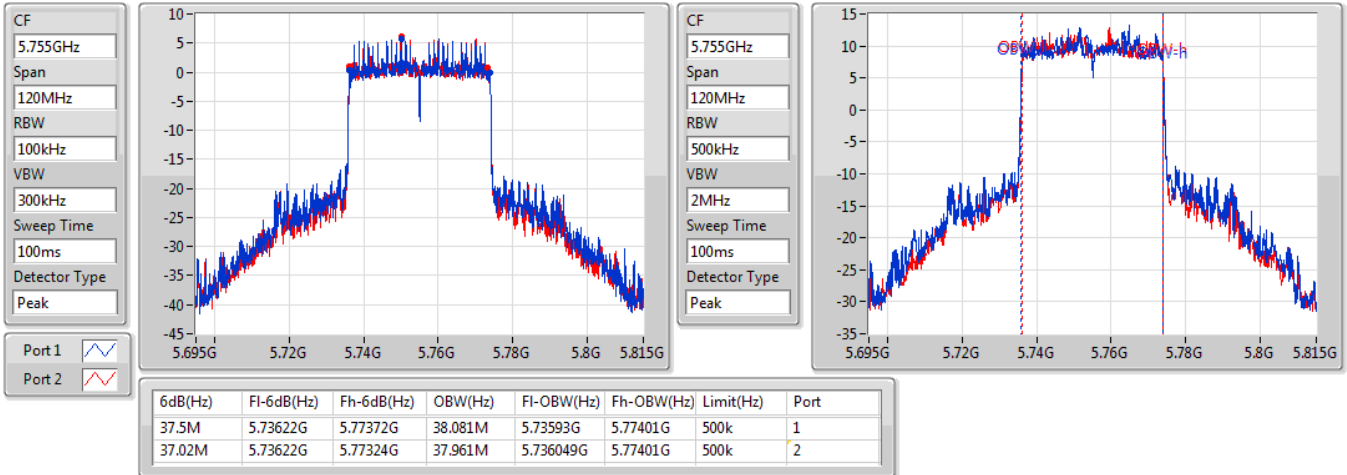

802.11ax HEW40_Nss2,(MCS0)_2TX

EBW

5795MHz

03/02/2020

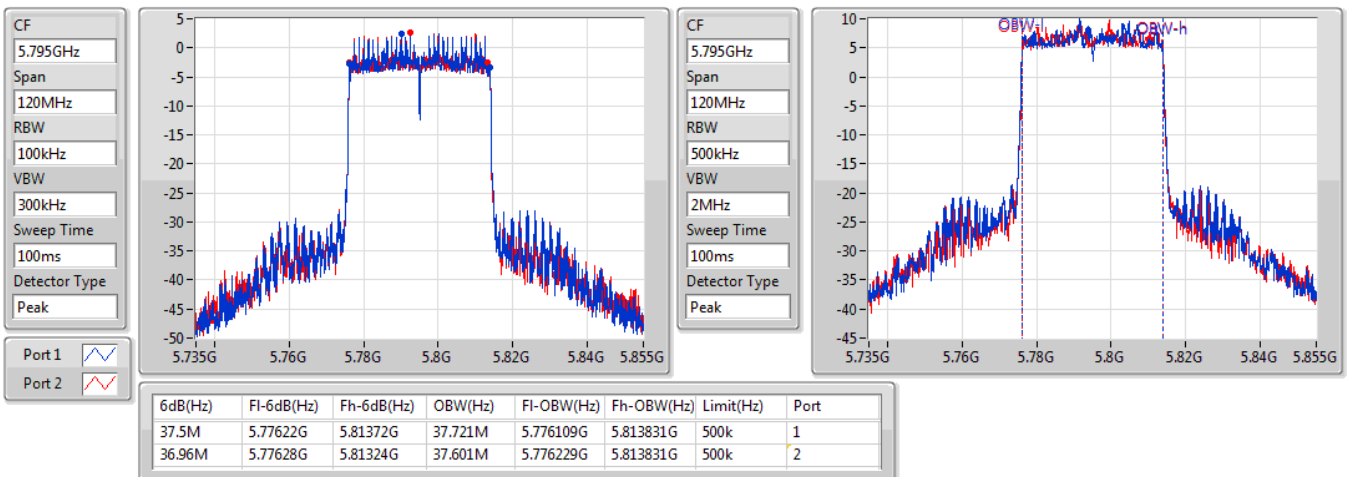

802.11ax HEW80_Nss2,(MCS0)_2TX

EBW

5210MHz

03/02/2020

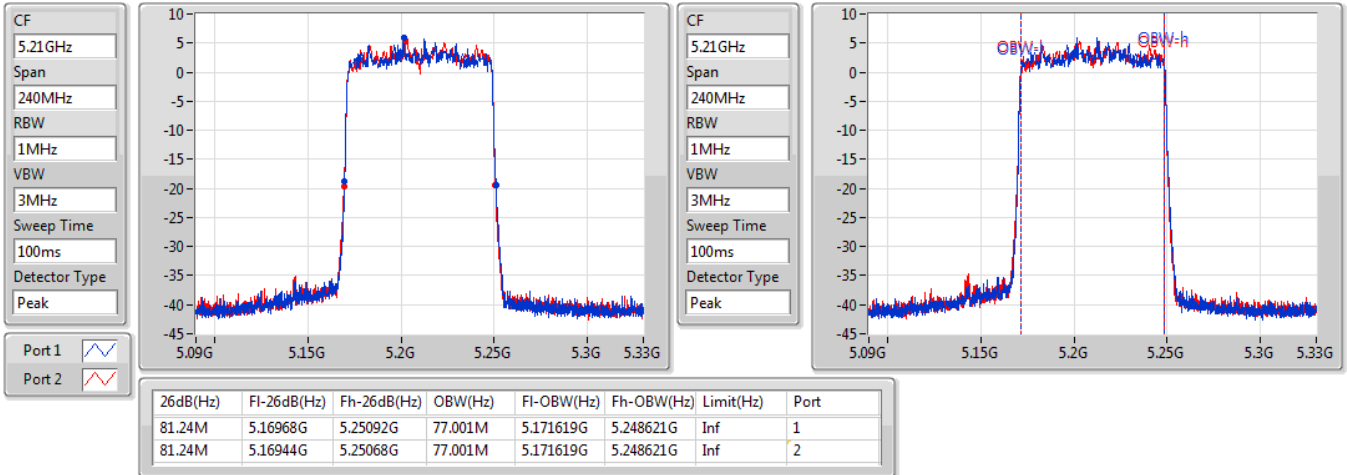

802.11ax HEW80_Nss2,(MCS0)_2TX

EBW

5775MHz

03/02/2020

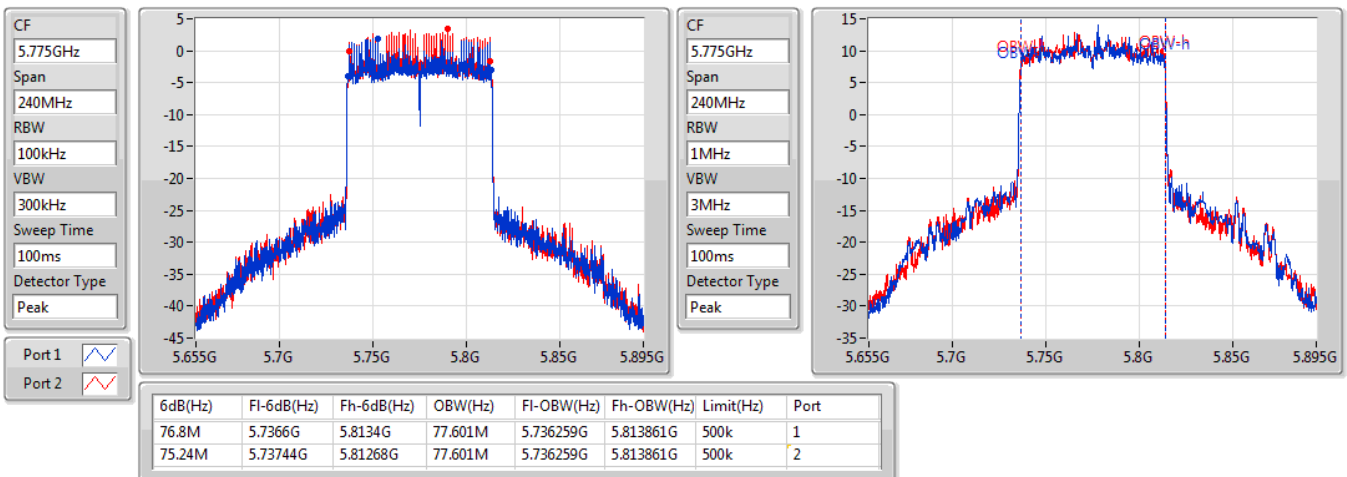



Summary

Mode	Max-N dB (Hz)	Max-OBW (Hz)	ITU-Code	Min-N dB (Hz)	Min-OBW (Hz)
5.15-5.25GHz	-	-	-	-	-
802.11a_Nss1,(6Mbps)_1TX	21.21M	16.762M	16M8D1D	21.12M	16.732M
802.11ac VHT20_Nss1,(MCS0)_1TX	21.54M	17.871M	17M9D1D	21.48M	17.871M
802.11ac VHT40_Nss1,(MCS0)_1TX	40.2M	36.402M	36M4D1D	40.2M	36.402M
802.11ac VHT80_Nss1,(MCS0)_1TX	81.84M	75.682M	75M7D1D	81.84M	75.682M
802.11ax HEW20_Nss1,(MCS0)_1TX	21.45M	19.01M	19M0D1D	21.36M	19.01M
802.11ax HEW40_Nss1,(MCS0)_1TX	40.14M	37.601M	37M6D1D	40.08M	37.541M
802.11ax HEW80_Nss1,(MCS0)_1TX	81.84M	77.121M	77M1D1D	81.84M	77.121M
5.725-5.85GHz	-	-	-	-	-
802.11a_Nss1,(6Mbps)_1TX	16.29M	26.057M	26M1D1D	16.29M	23.628M
802.11ac VHT20_Nss1,(MCS0)_1TX	17.55M	27.226M	27M2D1D	17.52M	24.348M
802.11ac VHT40_Nss1,(MCS0)_1TX	36.3M	54.693M	54M7D1D	36.3M	51.874M
802.11ac VHT80_Nss1,(MCS0)_1TX	75.48M	77.601M	77M6D1D	75.48M	77.601M
802.11ax HEW20_Nss1,(MCS0)_1TX	18.87M	27.916M	27M9D1D	18.78M	25.157M
802.11ax HEW40_Nss1,(MCS0)_1TX	36.9M	56.132M	56M1D1D	36.78M	45.637M
802.11ax HEW80_Nss1,(MCS0)_1TX	76.68M	78.561M	78M6D1D	76.68M	78.561M

Max-N dB = Maximum 6dB down bandwidth for 5.725-5.85GHz band / Maximum 26dB down bandwidth for other band;

Max-OBW = Maximum 99% occupied bandwidth;

Min-N dB = Minimum 6dB down bandwidth for 5.725-5.85GHz band / Maximum 26dB down bandwidth for other band;

Min-OBW = Minimum 99% occupied bandwidth;



Result

Mode	Result	Limit (Hz)	Port 1-N dB (Hz)	Port 1-OBW (Hz)
802.11a_Nss1,(6Mbps)_1TX	-	-	-	-
5180MHz	Pass	Inf	21.18M	16.732M
5200MHz	Pass	Inf	21.21M	16.762M
5240MHz	Pass	Inf	21.12M	16.732M
5745MHz	Pass	500k	16.29M	23.628M
5785MHz	Pass	500k	16.29M	24.978M
5825MHz	Pass	500k	16.29M	26.057M
802.11ac VHT20_Nss1,(MCS0)_1TX	-	-	-	-
5180MHz	Pass	Inf	21.48M	17.871M
5200MHz	Pass	Inf	21.48M	17.871M
5240MHz	Pass	Inf	21.54M	17.871M
5745MHz	Pass	500k	17.55M	24.348M
5785MHz	Pass	500k	17.52M	26.117M
5825MHz	Pass	500k	17.55M	27.226M
802.11ac VHT40_Nss1,(MCS0)_1TX	-	-	-	-
5190MHz	Pass	Inf	40.2M	36.402M
5230MHz	Pass	Inf	40.2M	36.402M
5755MHz	Pass	500k	36.3M	51.874M
5795MHz	Pass	500k	36.3M	54.693M
802.11ac VHT80_Nss1,(MCS0)_1TX	-	-	-	-
5210MHz	Pass	Inf	81.84M	75.682M
5775MHz	Pass	500k	75.48M	77.601M
802.11ax HEW20_Nss1,(MCS0)_1TX	-	-	-	-
5180MHz	Pass	Inf	21.36M	19.01M
5200MHz	Pass	Inf	21.42M	19.01M
5240MHz	Pass	Inf	21.45M	19.01M
5745MHz	Pass	500k	18.87M	25.157M
5785MHz	Pass	500k	18.78M	26.897M
5825MHz	Pass	500k	18.84M	27.916M
802.11ax HEW40_Nss1,(MCS0)_1TX	-	-	-	-
5190MHz	Pass	Inf	40.14M	37.541M
5230MHz	Pass	Inf	40.08M	37.601M
5755MHz	Pass	500k	36.78M	45.637M
5795MHz	Pass	500k	36.9M	56.132M
802.11ax HEW80_Nss1,(MCS0)_1TX	-	-	-	-
5210MHz	Pass	Inf	81.84M	77.121M
5775MHz	Pass	500k	76.68M	78.561M

Port X-N dB = Port X 6dB down bandwidth for 5.725-5.85GHz band / 26dB down bandwidth for other band
Port X-OBW = Port X 99% occupied bandwidth;

802.11a_Nss1,(6Mbps)_1TX

EBW

5180MHz

06/02/2020

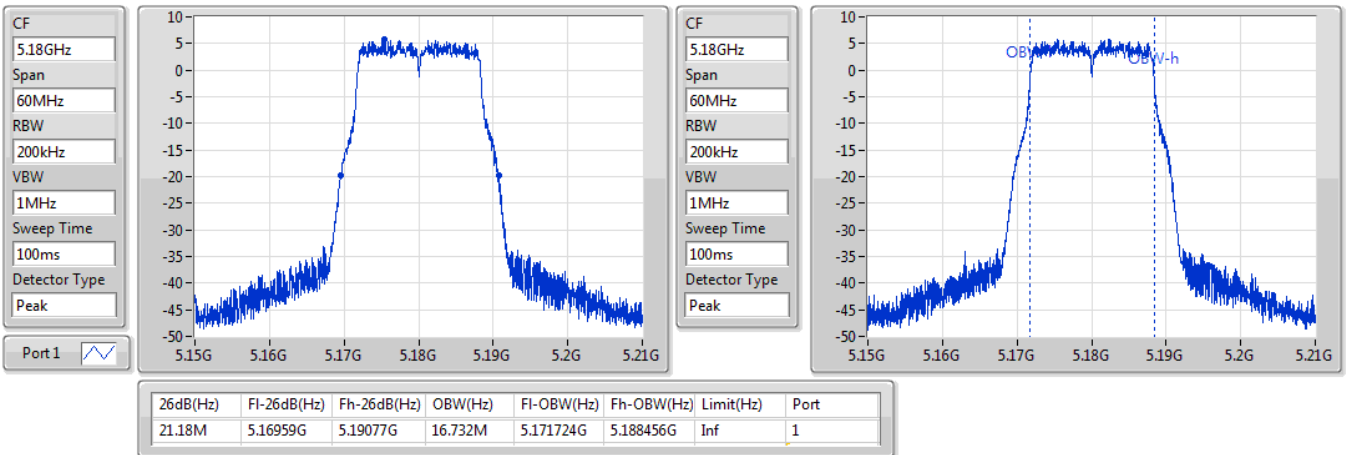

802.11a_Nss1,(6Mbps)_1TX

EBW

5200MHz

06/02/2020

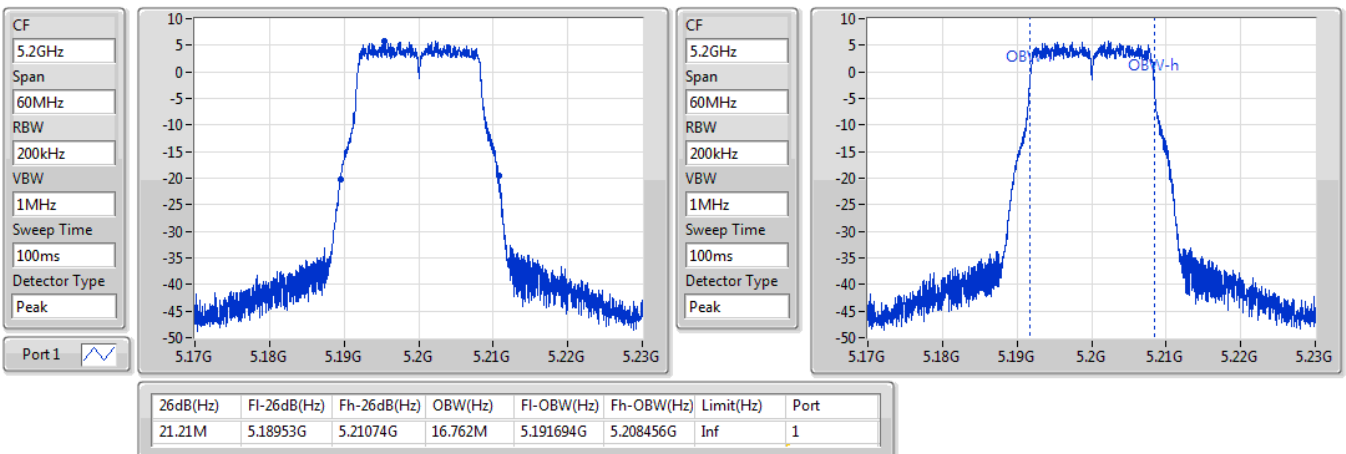

802.11a_Nss1,(6Mbps)_1TX

EBW

5240MHz

06/02/2020

CF
5.24GHz
Span
60MHz
RBW
200kHz
VBW
1MHz
Sweep Time
100ms
Detector Type
Peak
Port 1

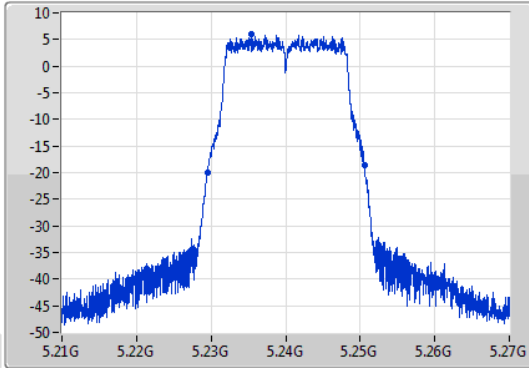

CF
5.24GHz
Span
60MHz
RBW
200kHz
VBW
1MHz
Sweep Time
100ms
Detector Type
Peak

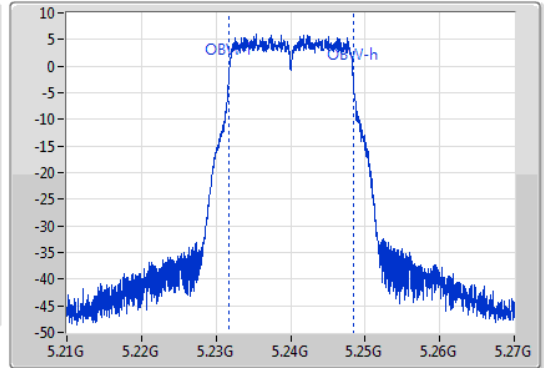

26dB(Hz)	Fl-26dB(Hz)	Fh-26dB(Hz)	OBW(Hz)	Fl-OBW(Hz)	Fh-OBW(Hz)	Limit(Hz)	Port
21.12M	5.22953G	5.25065G	16.732M	5.231724G	5.248456G	Inf	1

802.11a_Nss1,(6Mbps)_1TX

EBW

5745MHz

04/02/2020

CF
5.745GHz
Span
60MHz
RBW
100kHz
VBW
300kHz
Sweep Time
100ms
Detector Type
Peak
Port 1

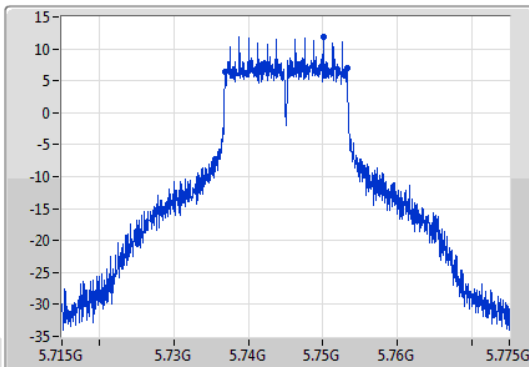

CF
5.745GHz
Span
60MHz
RBW
200kHz
VBW
1MHz
Sweep Time
100ms
Detector Type
Peak

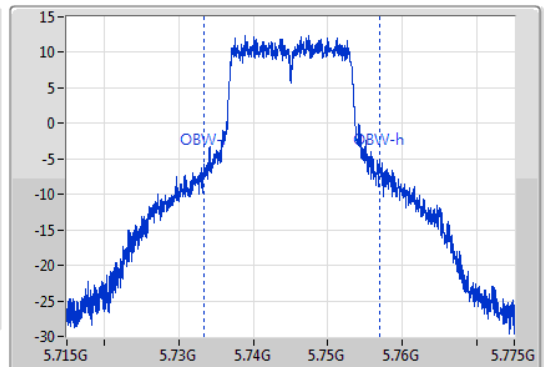

6dB(Hz)	Fl-6dB(Hz)	Fh-6dB(Hz)	OBW(Hz)	Fl-OBW(Hz)	Fh-OBW(Hz)	Limit(Hz)	Port
16.29M	5.7369G	5.75319G	23.628M	5.733396G	5.757024G	500k	1

802.11a_Nss1,(6Mbps)_1TX

EBW

5785MHz

04/02/2020

CF
5.785GHz
Span
60MHz
RBW
100kHz
VBW
300kHz
Sweep Time
100ms
Detector Type
Peak
Port 1

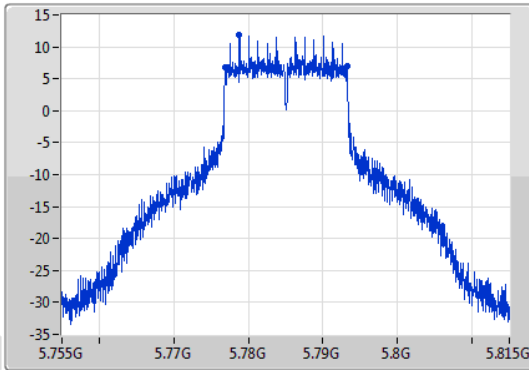

CF
5.785GHz
Span
60MHz
RBW
200kHz
VBW
1MHz
Sweep Time
100ms
Detector Type
Peak

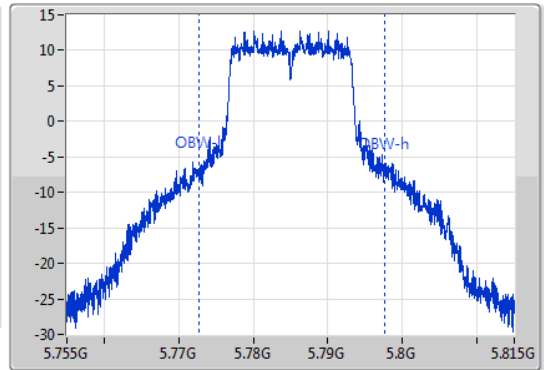

6dB(Hz)	Fl-6dB(Hz)	Fh-6dB(Hz)	OBW(Hz)	Fl-OBW(Hz)	Fh-OBW(Hz)	Limit(Hz)	Port
16.29M	5.7769G	5.79319G	24.978M	5.772706G	5.797684G	500k	1

802.11a_Nss1,(6Mbps)_1TX

EBW

5825MHz

04/02/2020

CF
5.825GHz
Span
60MHz
RBW
100kHz
VBW
300kHz
Sweep Time
100ms
Detector Type
Peak
Port 1

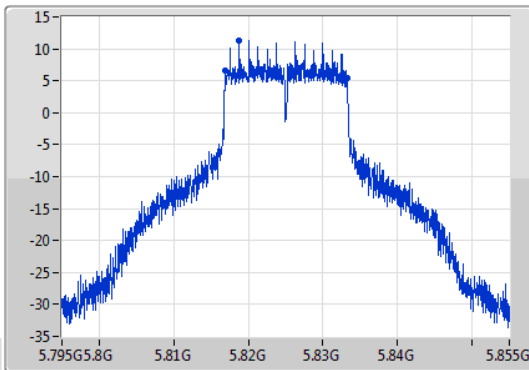

CF
5.825GHz
Span
60MHz
RBW
200kHz
VBW
1MHz
Sweep Time
100ms
Detector Type
Peak

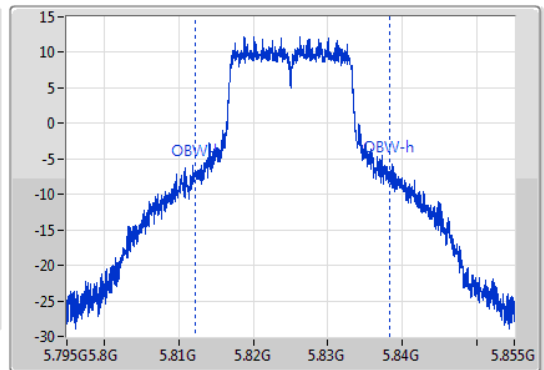

6dB(Hz)	Fl-6dB(Hz)	Fh-6dB(Hz)	OBW(Hz)	Fl-OBW(Hz)	Fh-OBW(Hz)	Limit(Hz)	Port
16.29M	5.8169G	5.83319G	26.057M	5.812166G	5.838223G	500k	1

802.11ac VHT20_Nss1,(MCS0)_1TX

EBW

5180MHz

06/02/2020

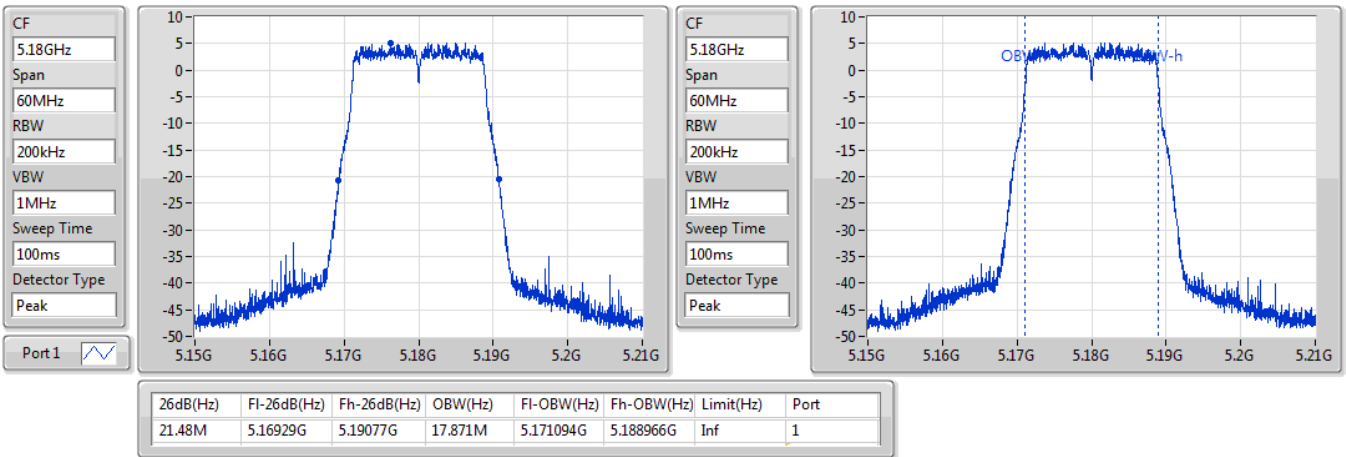

802.11ac VHT20_Nss1,(MCS0)_1TX

EBW

5200MHz

06/02/2020

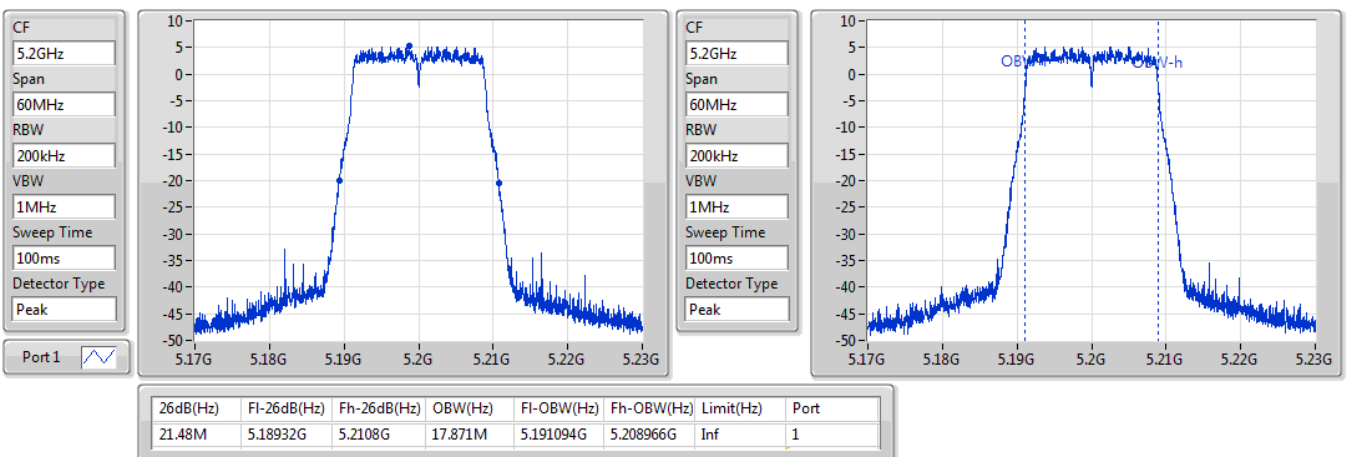

802.11ac VHT20_Nss1,(MCS0)_1TX

EBW

5240MHz

06/02/2020

CF
5.24GHz
Span
60MHz
RBW
200kHz
VBW
1MHz
Sweep Time
100ms
Detector Type
Peak
Port 1

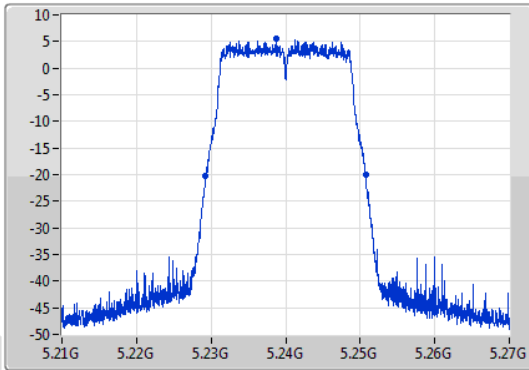

CF
5.24GHz
Span
60MHz
RBW
200kHz
VBW
1MHz
Sweep Time
100ms
Detector Type
Peak

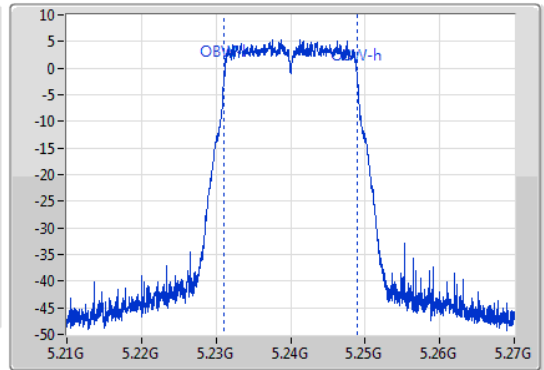

26dB(Hz)	Fl-26dB(Hz)	Fh-26dB(Hz)	OBW(Hz)	Fl-OBW(Hz)	Fh-OBW(Hz)	Limit(Hz)	Port
21.54M	5.22926G	5.2508G	17.871M	5.231094G	5.248966G	Inf	1

802.11ac VHT20_Nss1,(MCS0)_1TX

EBW

5745MHz

05/02/2020

CF
5.745GHz
Span
60MHz
RBW
100kHz
VBW
300kHz
Sweep Time
100ms
Detector Type
Peak
Port 1

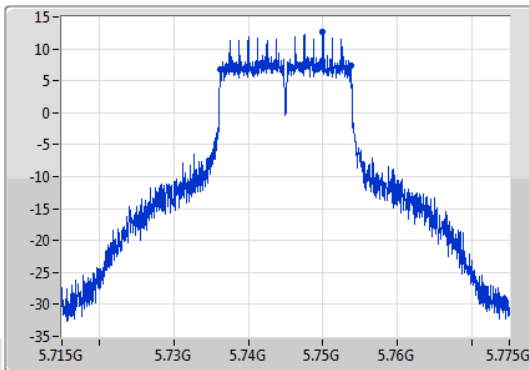

CF
5.745GHz
Span
60MHz
RBW
200kHz
VBW
1MHz
Sweep Time
100ms
Detector Type
Peak

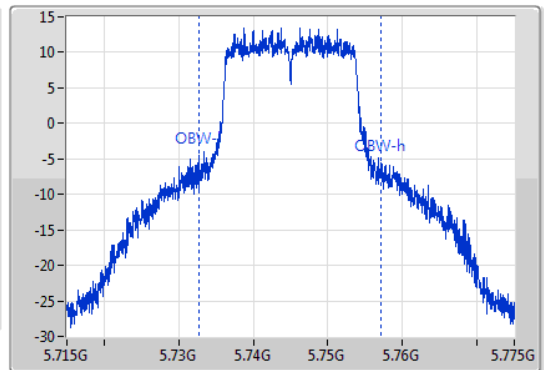

6dB(Hz)	Fl-6dB(Hz)	Fh-6dB(Hz)	OBW(Hz)	Fl-OBW(Hz)	Fh-OBW(Hz)	Limit(Hz)	Port
17.55M	5.73621G	5.75376G	24.348M	5.732796G	5.757144G	500k	1

802.11ac VHT20_Nss1,(MCS0)_1TX

EBW

5785MHz

05/02/2020

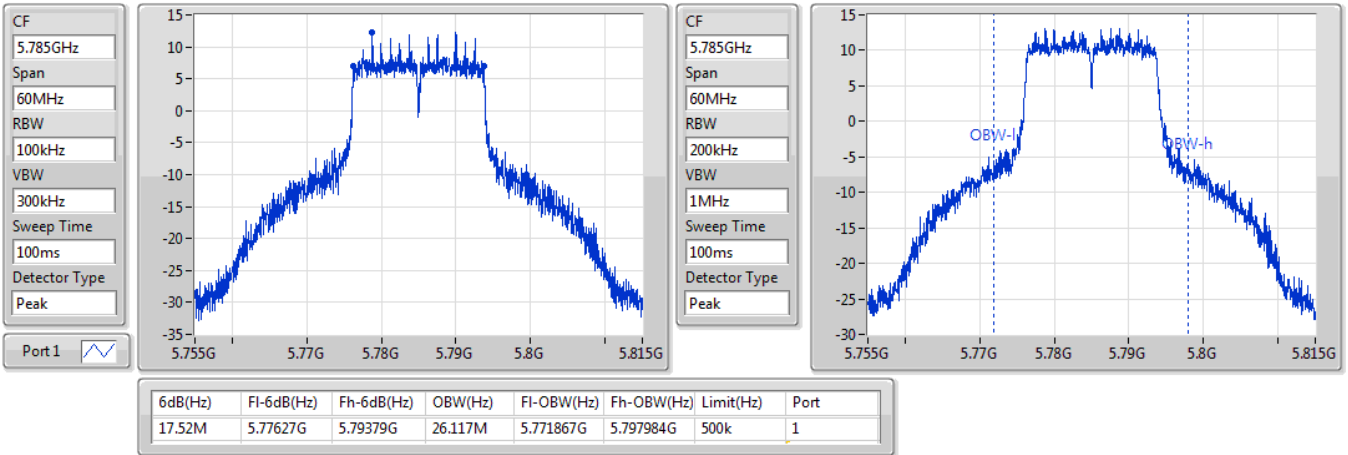

802.11ac VHT20_Nss1,(MCS0)_1TX

EBW

5825MHz

05/02/2020

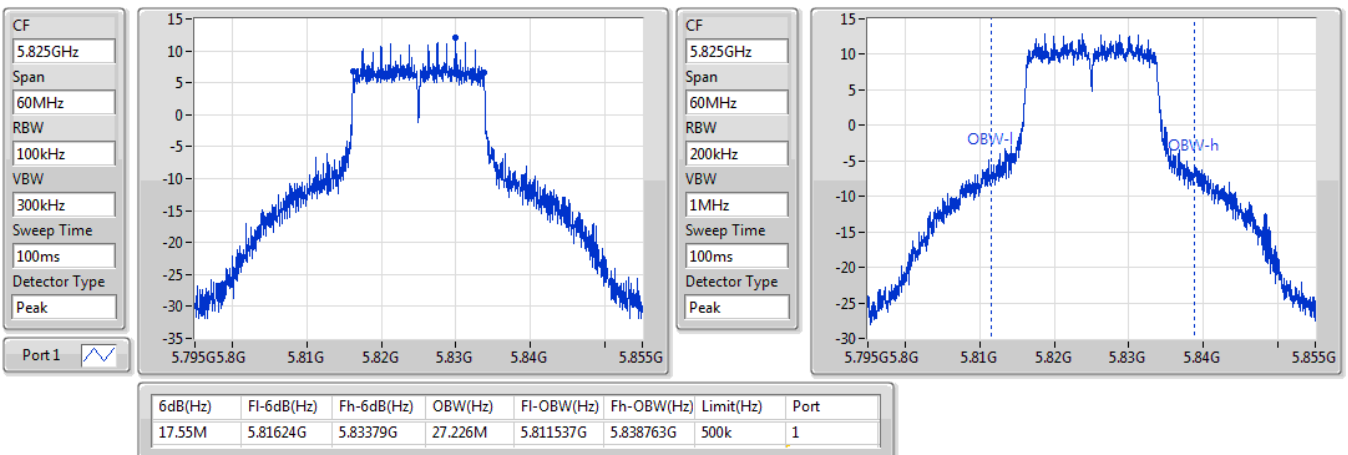

802.11ac VHT40_Nss1,(MCS0)_1TX

EBW

5190MHz

06/02/2020

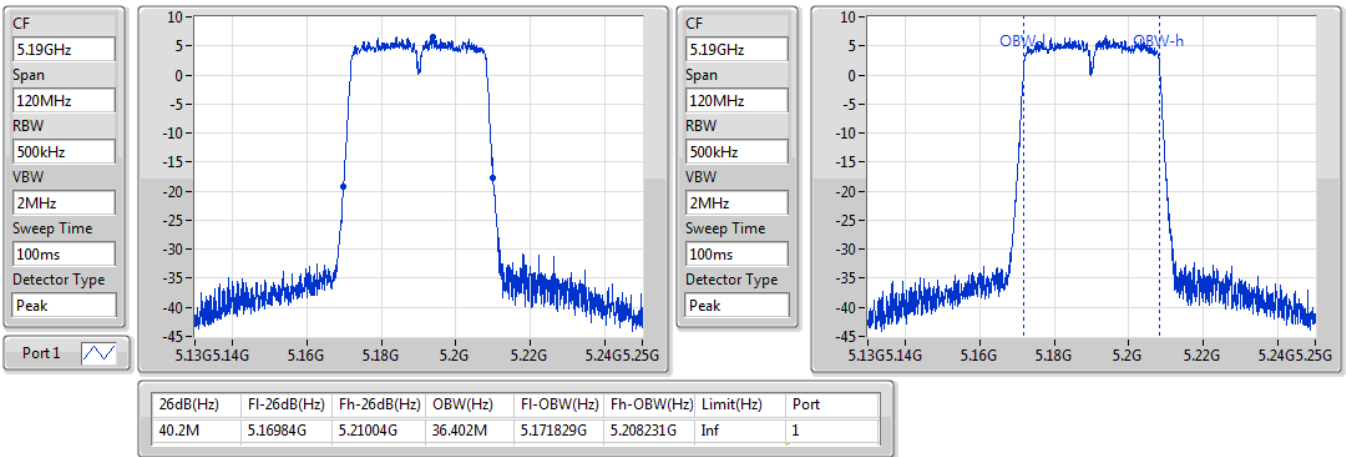

802.11ac VHT40_Nss1,(MCS0)_1TX

EBW

5230MHz

06/02/2020

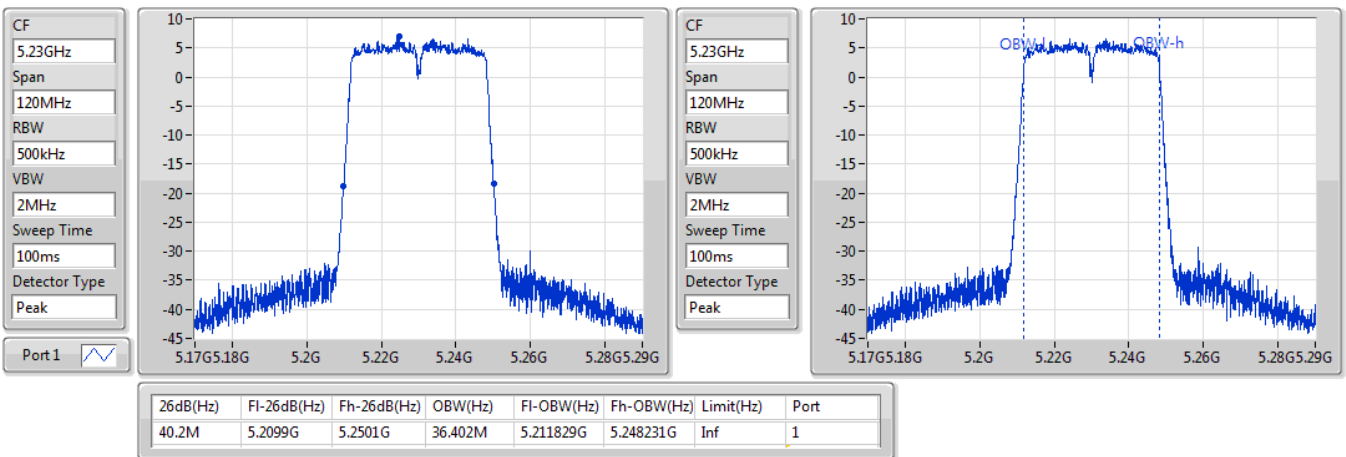

802.11ac VHT40_Nss1,(MCS0)_1TX

EBW

5755MHz

05/02/2020

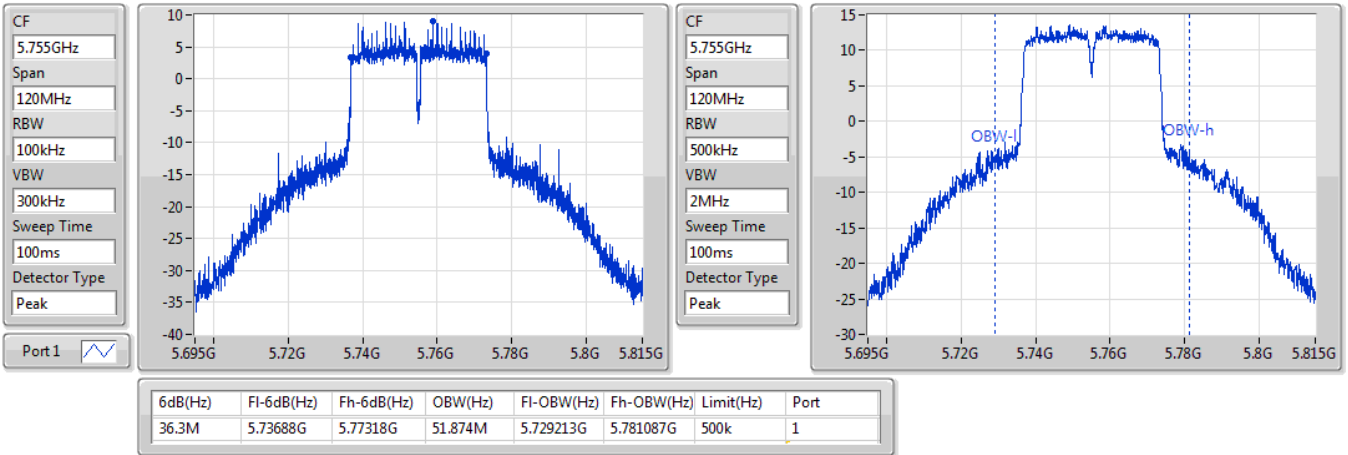

802.11ac VHT40_Nss1,(MCS0)_1TX

EBW

5795MHz

05/02/2020

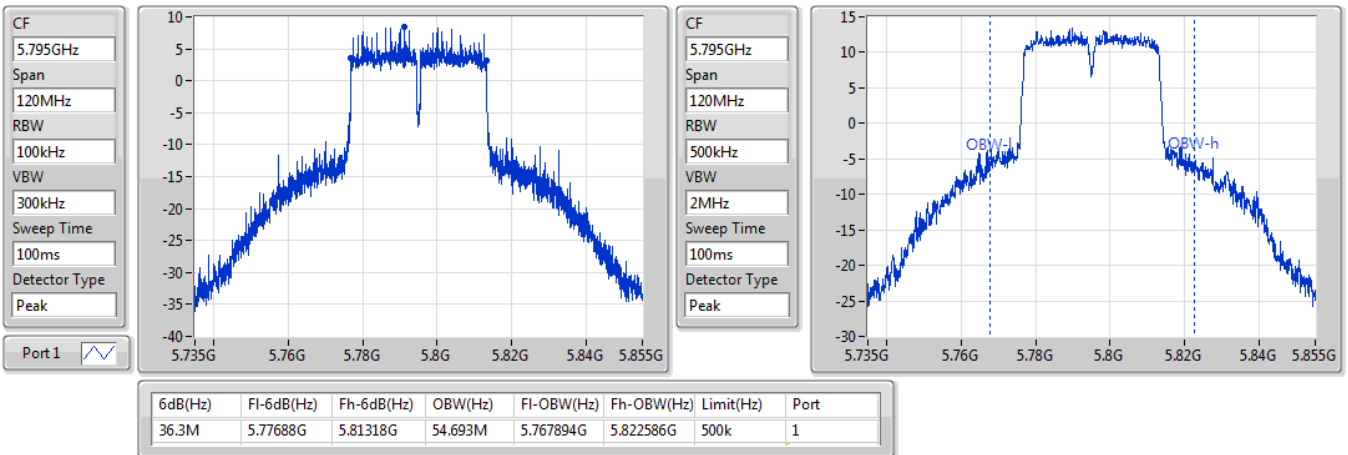

802.11ac VHT80_Nss1,(MCS0)_1TX

EBW

5210MHz

06/02/2020

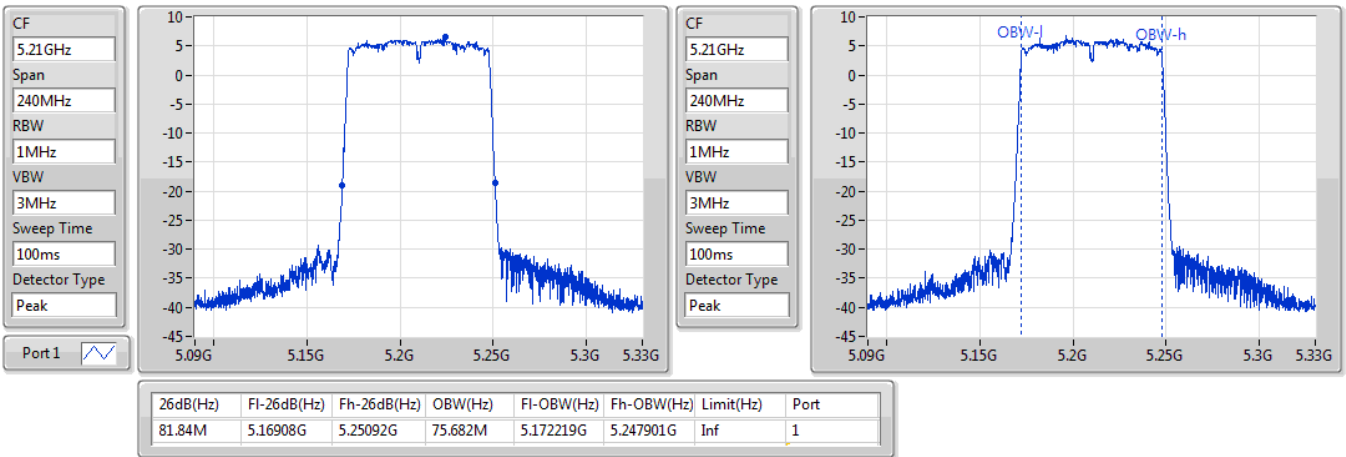

802.11ac VHT80_Nss1,(MCS0)_1TX

EBW

5775MHz

05/02/2020

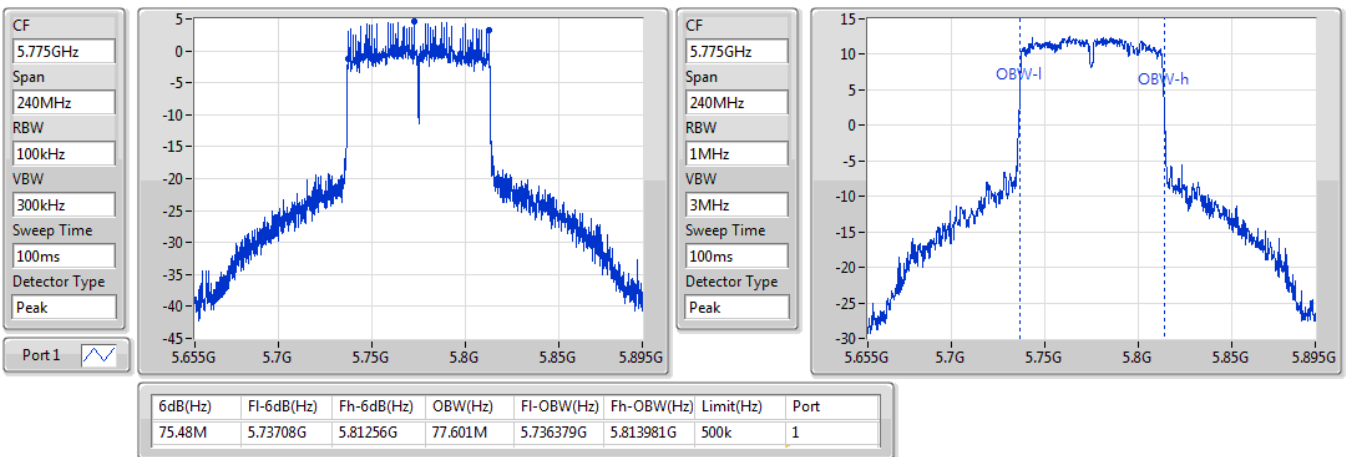

802.11ax HEW20_Nss1,(MCS0)_1TX

EBW

5180MHz

06/02/2020

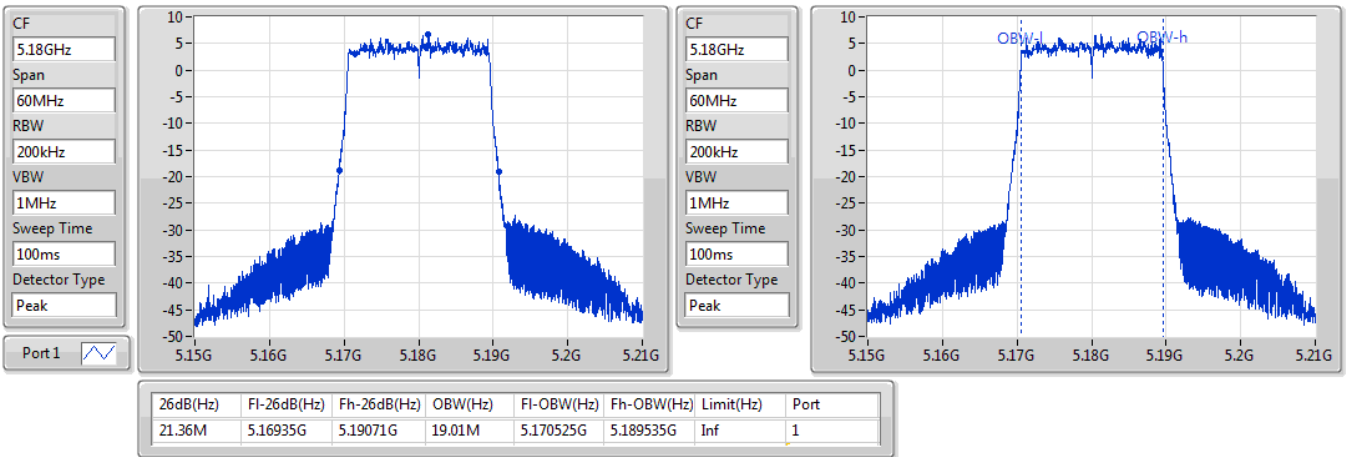

802.11ax HEW20_Nss1,(MCS0)_1TX

EBW

5200MHz

06/02/2020

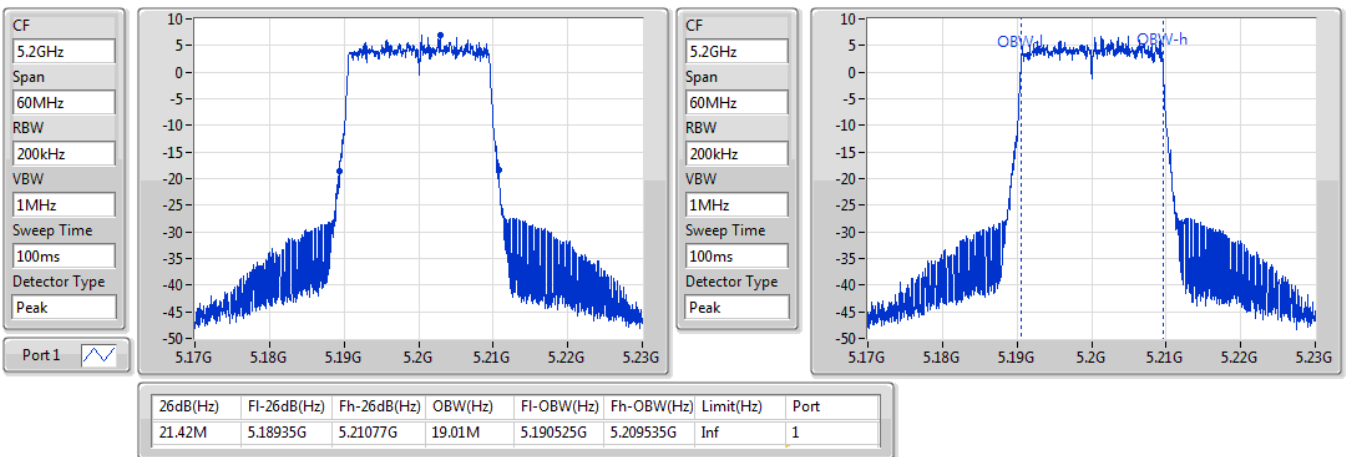

802.11ax HEW20_Nss1,(MCS0)_1TX

EBW

5240MHz

06/02/2020

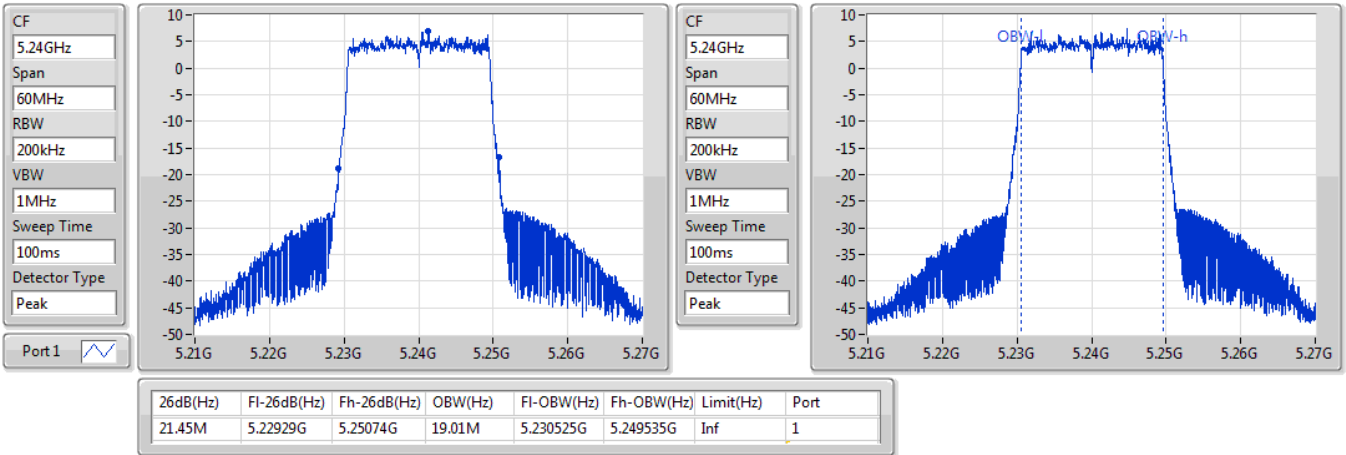

802.11ax HEW20_Nss1,(MCS0)_1TX

EBW

5745MHz

05/02/2020

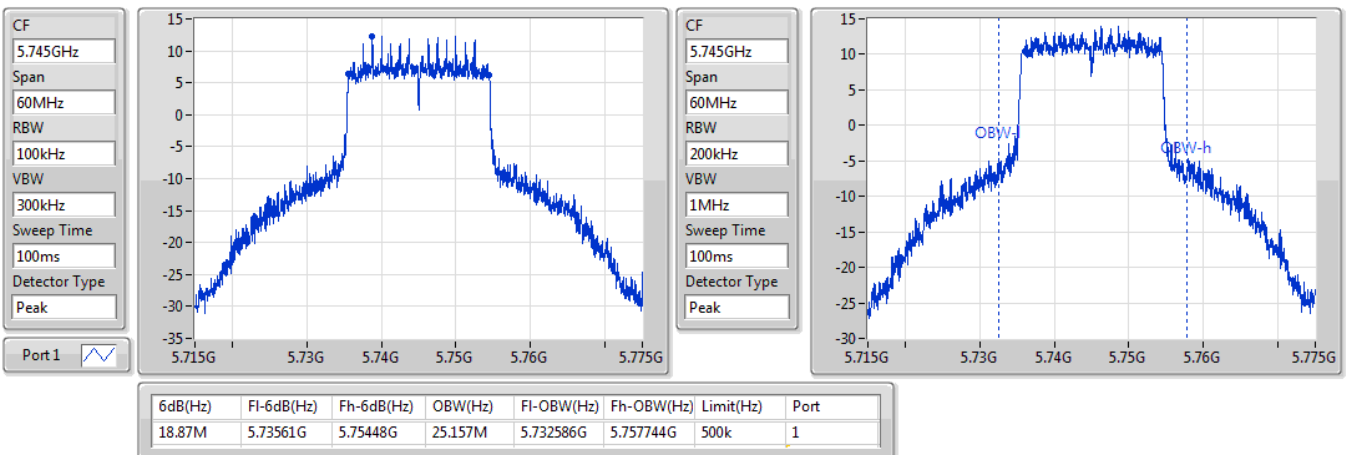

802.11ax HEW20_Nss1,(MCS0)_1TX

EBW

5785MHz

05/02/2020

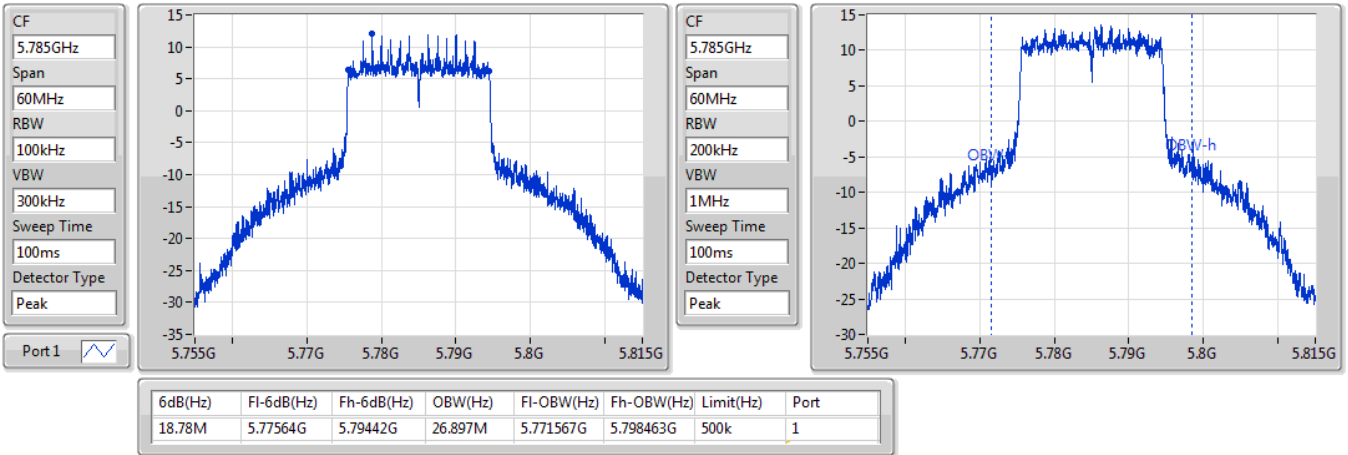

802.11ax HEW20_Nss1,(MCS0)_1TX

EBW

5825MHz

05/02/2020

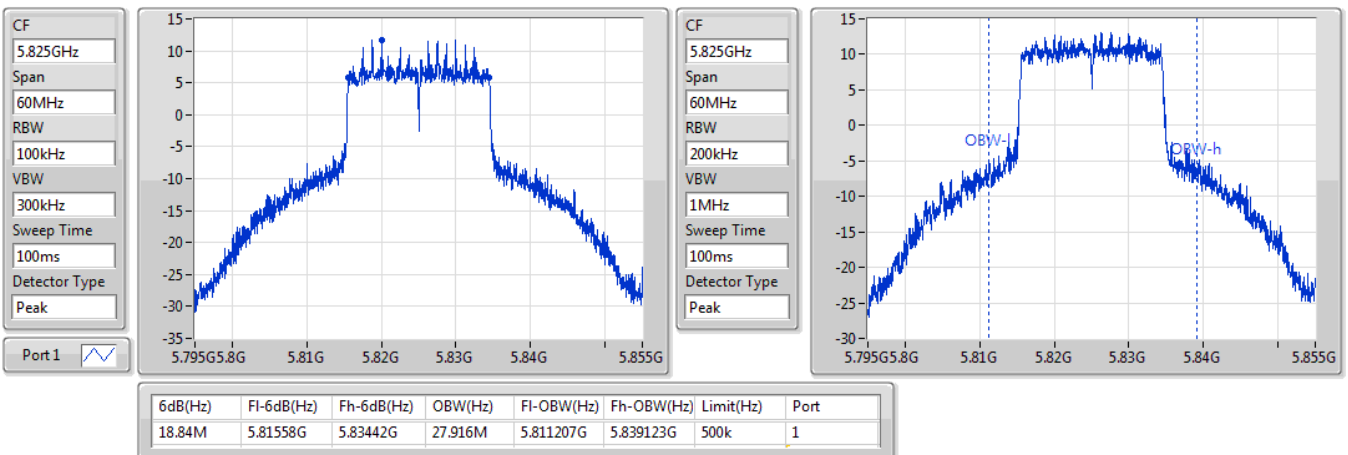

802.11ax HEW40_Nss1,(MCS0)_1TX

EBW

5190MHz

06/02/2020

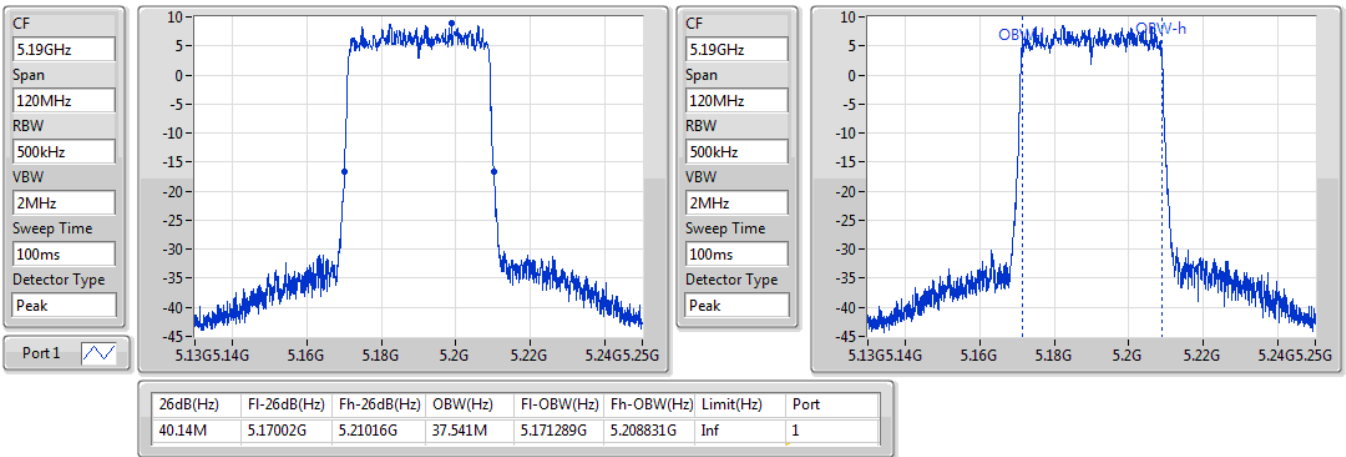

802.11ax HEW40_Nss1,(MCS0)_1TX

EBW

5230MHz

06/02/2020

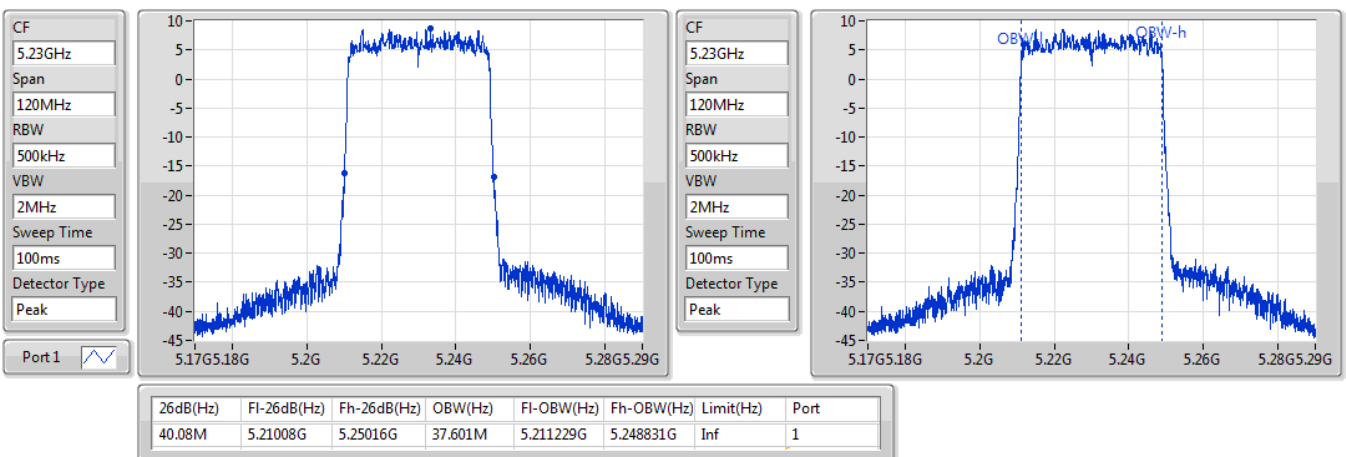

802.11ax HEW40_Nss1,(MCS0)_1TX

EBW

5755MHz

05/02/2020

CF
5.755GHz
Span
120MHz
RBW
100kHz
VBW
300kHz
Sweep Time
100ms
Detector Type
Peak
Port 1

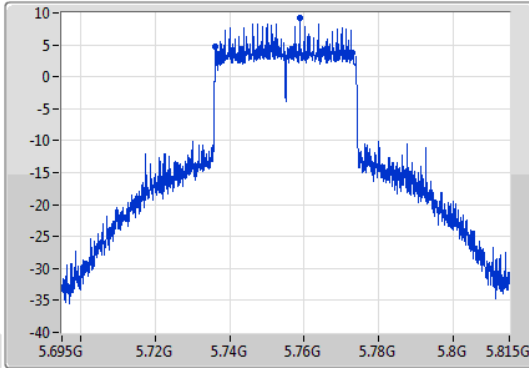

CF
5.755GHz
Span
120MHz
RBW
500kHz
VBW
2MHz
Sweep Time
100ms
Detector Type
Peak

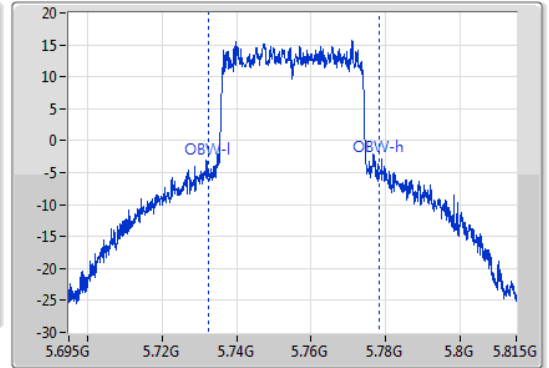

6dB(Hz)	Fl-6dB(Hz)	Fh-6dB(Hz)	OBW(Hz)	Fl-OBW(Hz)	Fh-OBW(Hz)	Limit(Hz)	Port
36.78M	5.73622G	5.773G	45.637M	5.732511G	5.778148G	500k	1

802.11ax HEW40_Nss1,(MCS0)_1TX

EBW

5795MHz

05/02/2020

CF
5.795GHz
Span
120MHz
RBW
100kHz
VBW
300kHz
Sweep Time
100ms
Detector Type
Peak
Port 1

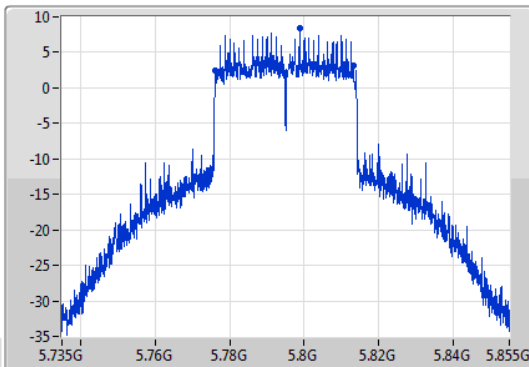

CF
5.795GHz
Span
120MHz
RBW
500kHz
VBW
2MHz
Sweep Time
100ms
Detector Type
Peak

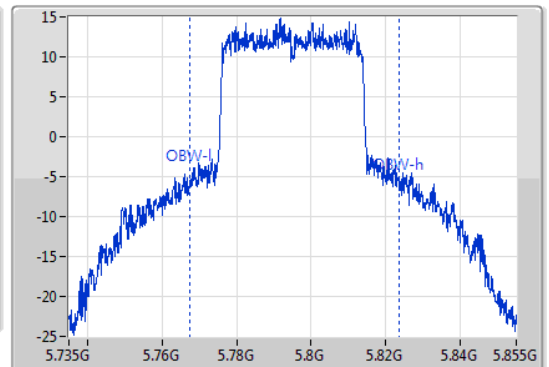

6dB(Hz)	Fl-6dB(Hz)	Fh-6dB(Hz)	OBW(Hz)	Fl-OBW(Hz)	Fh-OBW(Hz)	Limit(Hz)	Port
36.9M	5.77628G	5.81318G	56.132M	5.767534G	5.823666G	500k	1

802.11ax HEW80_Nss1,(MCS0)_1TX

EBW

5210MHz

06/02/2020

CF
5.21GHz
Span
240MHz
RBW
1MHz
VBW
3MHz
Sweep Time
100ms
Detector Type
Peak
Port 1

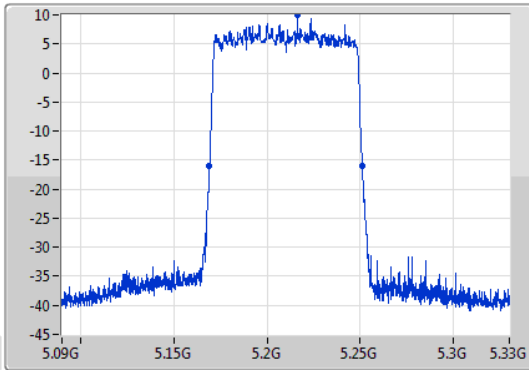

CF
5.21GHz
Span
240MHz
RBW
1MHz
VBW
3MHz
Sweep Time
100ms
Detector Type
Peak

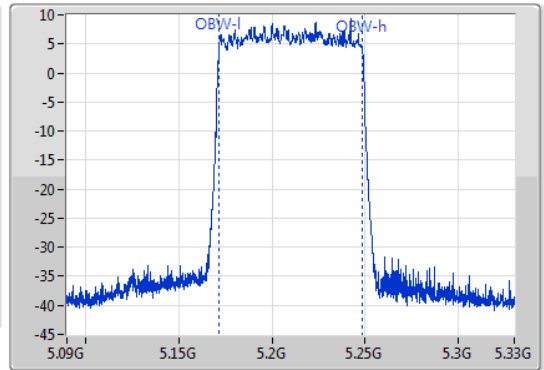

26dB(Hz)	Fl-26dB(Hz)	Fh-26dB(Hz)	OBW(Hz)	Fl-OBW(Hz)	Fh-OBW(Hz)	Limit(Hz)	Port
81.84M	5.1692G	5.25104G	77.121M	5.171499G	5.248621G	Inf	1

802.11ax HEW80_Nss1,(MCS0)_1TX

EBW

5775MHz

05/02/2020

CF
5.775GHz
Span
240MHz
RBW
100kHz
VBW
300kHz
Sweep Time
100ms
Detector Type
Peak
Port 1

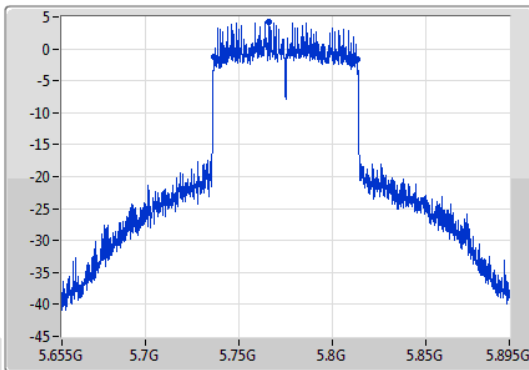

CF
5.775GHz
Span
240MHz
RBW
1MHz
VBW
3MHz
Sweep Time
100ms
Detector Type
Peak

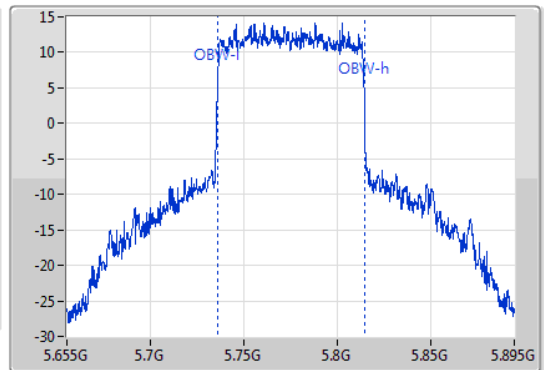

6dB(Hz)	Fl-6dB(Hz)	Fh-6dB(Hz)	OBW(Hz)	Fl-OBW(Hz)	Fh-OBW(Hz)	Limit(Hz)	Port
76.68M	5.73648G	5.81316G	78.561M	5.7359G	5.81446G	500k	1



Summary

Mode	Max-N dB (Hz)	Max-OBW (Hz)	ITU-Code	Min-N dB (Hz)	Min-OBW (Hz)
5.15-5.25GHz	-	-	-	-	-
802.11a_Nss1,(6Mbps)_2TX	21.3M	16.732M	16M7D1D	21M	16.642M
802.11ac VHT20_Nss2,(MCS0)_2TX	21.63M	17.871M	17M9D1D	21.33M	17.751M
802.11ac VHT40_Nss2,(MCS0)_2TX	39.96M	36.402M	36M4D1D	39.78M	36.282M
802.11ac VHT80_Nss2,(MCS0)_2TX	81.84M	75.802M	75M8D1D	81.24M	75.802M
802.11ax HEW20_Nss2,(MCS0)_2TX	21.72M	19.04M	19M0D1D	21.3M	19.01M
802.11ax HEW40_Nss2,(MCS0)_2TX	40.14M	37.601M	37M6D1D	39.9M	37.541M
802.11ax HEW80_Nss2,(MCS0)_2TX	81.36M	77.121M	77M1D1D	81.36M	77.001M
5.725-5.85GHz	-	-	-	-	-
802.11a_Nss1,(6Mbps)_2TX	16.35M	25.997M	26M0D1D	16.29M	21.379M
802.11ac VHT20_Nss2,(MCS0)_2TX	17.58M	26.987M	27M0D1D	17.55M	22.339M
802.11ac VHT40_Nss2,(MCS0)_2TX	36.36M	54.273M	54M3D1D	36.24M	37.541M
802.11ac VHT80_Nss2,(MCS0)_2TX	75.48M	76.642M	76M6D1D	75.36M	76.162M
802.11ax HEW20_Nss2,(MCS0)_2TX	18.9M	27.406M	27M4D1D	18.63M	22.549M
802.11ax HEW40_Nss2,(MCS0)_2TX	37.68M	50.795M	50M8D1D	37.02M	38.501M
802.11ax HEW80_Nss2,(MCS0)_2TX	76.68M	77.601M	77M6D1D	75.72M	77.361M

Max-N dB = Maximum 6dB down bandwidth for 5.725-5.85GHz band / Maximum 26dB down bandwidth for other band;

Max-OBW = Maximum 99% occupied bandwidth;

Min-N dB = Minimum 6dB down bandwidth for 5.725-5.85GHz band / Maximum 26dB down bandwidth for other band;

Min-OBW = Minimum 99% occupied bandwidth;



Result

Mode	Result	Limit (Hz)	Port 1-N dB (Hz)	Port 1-OBW (Hz)	Port 2-N dB (Hz)	Port 2-OBW (Hz)
802.11a_Nss1,(6Mbps)_2TX	-	-	-	-	-	-
5180MHz	Pass	Inf	21.3M	16.732M	21.15M	16.642M
5200MHz	Pass	Inf	21.18M	16.732M	21M	16.642M
5240MHz	Pass	Inf	21.24M	16.732M	21.15M	16.642M
5745MHz	Pass	500k	16.35M	24.438M	16.35M	21.379M
5785MHz	Pass	500k	16.32M	25.187M	16.29M	22.459M
5825MHz	Pass	500k	16.29M	25.997M	16.32M	23.328M
802.11ac_VHT20_Nss2,(MCS0)_2TX	-	-	-	-	-	-
5180MHz	Pass	Inf	21.57M	17.841M	21.39M	17.781M
5200MHz	Pass	Inf	21.6M	17.871M	21.33M	17.751M
5240MHz	Pass	Inf	21.63M	17.871M	21.33M	17.781M
5745MHz	Pass	500k	17.58M	24.168M	17.58M	22.339M
5785MHz	Pass	500k	17.55M	25.997M	17.58M	23.718M
5825MHz	Pass	500k	17.58M	26.987M	17.55M	24.918M
802.11ac_VHT40_Nss2,(MCS0)_2TX	-	-	-	-	-	-
5190MHz	Pass	Inf	39.96M	36.402M	39.9M	36.282M
5230MHz	Pass	Inf	39.78M	36.402M	39.78M	36.282M
5755MHz	Pass	500k	36.3M	47.376M	36.36M	37.541M
5795MHz	Pass	500k	36.24M	54.273M	36.3M	41.379M
802.11ac_VHT80_Nss2,(MCS0)_2TX	-	-	-	-	-	-
5210MHz	Pass	Inf	81.84M	75.802M	81.24M	75.802M
5775MHz	Pass	500k	75.48M	76.642M	75.36M	76.162M
802.11ax_HEW20_Nss2,(MCS0)_2TX	-	-	-	-	-	-
5180MHz	Pass	Inf	21.72M	19.01M	21.39M	19.04M
5200MHz	Pass	Inf	21.48M	19.04M	21.42M	19.04M
5240MHz	Pass	Inf	21.66M	19.04M	21.3M	19.04M
5745MHz	Pass	500k	18.81M	24.018M	18.75M	22.549M
5785MHz	Pass	500k	18.9M	25.187M	18.75M	23.418M
5825MHz	Pass	500k	18.84M	27.406M	18.63M	23.628M
802.11ax_HEW40_Nss2,(MCS0)_2TX	-	-	-	-	-	-
5190MHz	Pass	Inf	40.14M	37.601M	39.96M	37.541M
5230MHz	Pass	Inf	39.96M	37.601M	39.9M	37.541M
5755MHz	Pass	500k	37.68M	43.418M	37.02M	38.501M
5795MHz	Pass	500k	37.62M	50.795M	37.02M	41.439M
802.11ax_HEW80_Nss2,(MCS0)_2TX	-	-	-	-	-	-
5210MHz	Pass	Inf	81.36M	77.121M	81.36M	77.001M
5775MHz	Pass	500k	76.68M	77.601M	75.72M	77.361M

Port X-N dB = Port X 6dB down bandwidth for 5.725-5.85GHz band / 26dB down bandwidth for other band
Port X-OBW = Port X 99% occupied bandwidth;



802.11a_Nss1,(6Mbps)_2TX

EBW

5180MHz

06/02/2020

CF
5.18GHz
Span
60MHz
RBW
200kHz
VBW
1MHz
Sweep Time
100ms
Detector Type
Peak

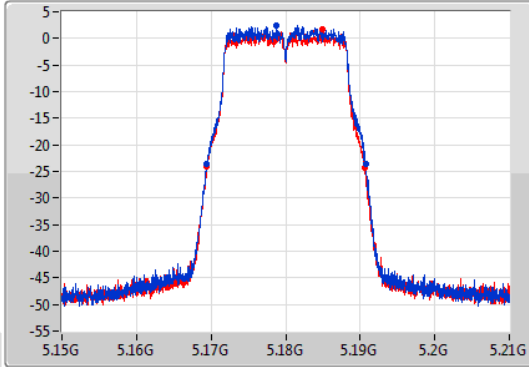

CF
5.18GHz
Span
60MHz
RBW
200kHz
VBW
1MHz
Sweep Time
100ms
Detector Type
Peak

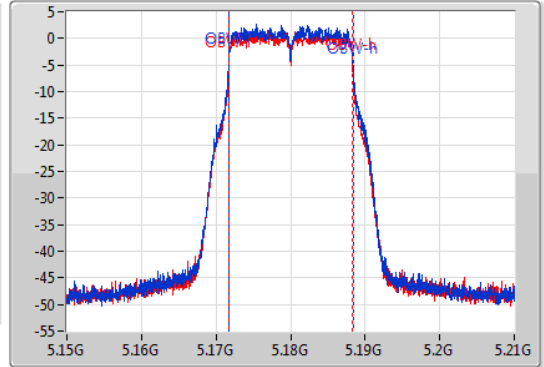

26dB(Hz)	Fl-26dB(Hz)	Fh-26dB(Hz)	OBW(Hz)	Fl-OBW(Hz)	Fh-OBW(Hz)	Limit(Hz)	Port
21.3M	5.16947G	5.19077G	16.732M	5.171694G	5.188426G	Inf	1
21.15M	5.16944G	5.19059G	16.642M	5.171694G	5.188336G	Inf	2

802.11a_Nss1,(6Mbps)_2TX

EBW

5200MHz

06/02/2020

CF
5.2GHz
Span
60MHz
RBW
200kHz
VBW
1MHz
Sweep Time
100ms
Detector Type
Peak

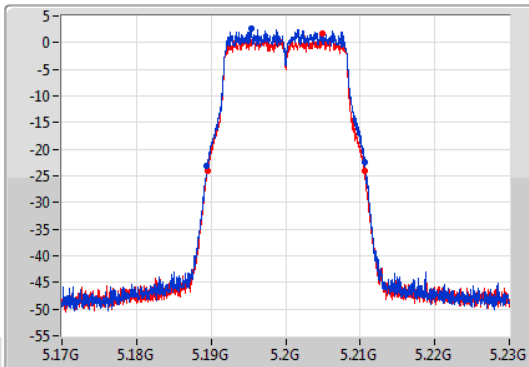

CF
5.2GHz
Span
60MHz
RBW
200kHz
VBW
1MHz
Sweep Time
100ms
Detector Type
Peak

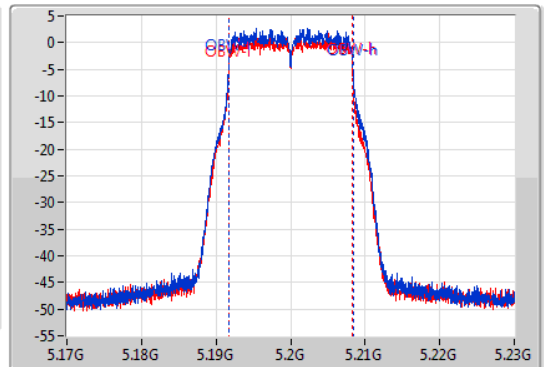

26dB(Hz)	Fl-26dB(Hz)	Fh-26dB(Hz)	OBW(Hz)	Fl-OBW(Hz)	Fh-OBW(Hz)	Limit(Hz)	Port
21.18M	5.18947G	5.21065G	16.732M	5.191694G	5.208426G	Inf	1
21M	5.18953G	5.21053G	16.642M	5.191694G	5.208336G	Inf	2

802.11a_Nss1,(6Mbps)_2TX

EBW

5240MHz

06/02/2020

CF
5.24GHz
Span
60MHz
RBW
200kHz
VBW
1MHz
Sweep Time
100ms
Detector Type
Peak

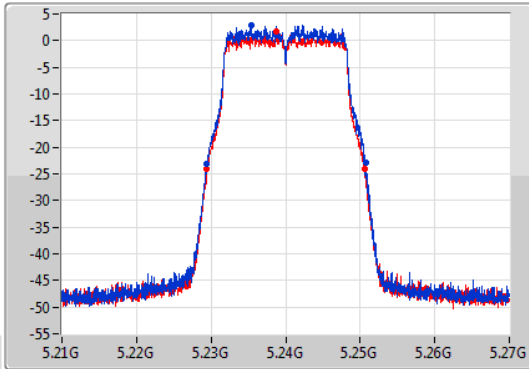

CF
5.24GHz
Span
60MHz
RBW
200kHz
VBW
1MHz
Sweep Time
100ms
Detector Type
Peak

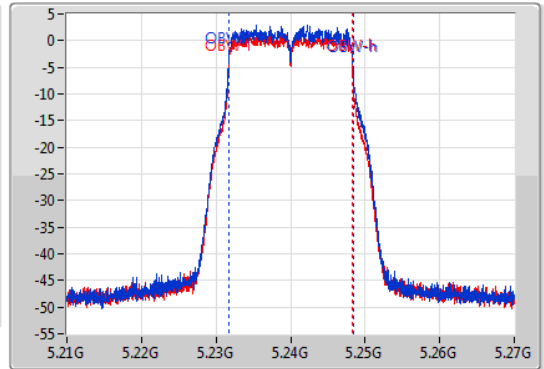

26dB(Hz)	Fl-26dB(Hz)	Fh-26dB(Hz)	OBW(Hz)	Fl-OBW(Hz)	Fh-OBW(Hz)	Limit(Hz)	Port
21.24M	5.22947G	5.25071G	16.732M	5.231694G	5.248426G	Inf	1
21.15M	5.22944G	5.25059G	16.642M	5.231694G	5.248336G	Inf	2

802.11a_Nss1,(6Mbps)_2TX

EBW

5745MHz

06/02/2020

CF
5.745GHz
Span
60MHz
RBW
100kHz
VBW
300kHz
Sweep Time
100ms
Detector Type
Peak

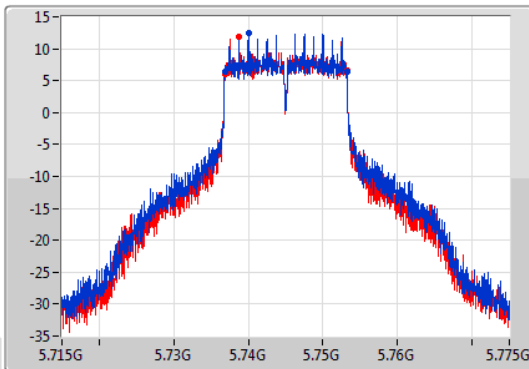

CF
5.745GHz
Span
60MHz
RBW
200kHz
VBW
1MHz
Sweep Time
100ms
Detector Type
Peak

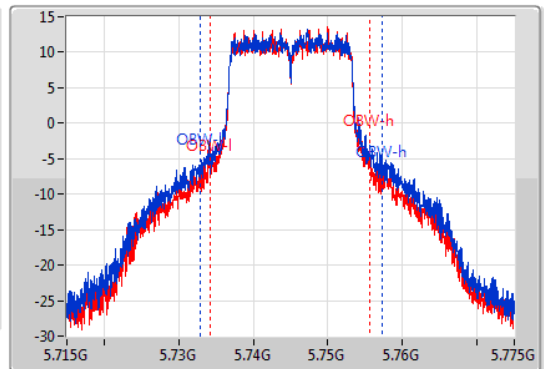

6dB(Hz)	Fl-6dB(Hz)	Fh-6dB(Hz)	OBW(Hz)	Fl-OBW(Hz)	Fh-OBW(Hz)	Limit(Hz)	Port
16.35M	5.73684G	5.75319G	24.438M	5.732916G	5.757354G	500k	1
16.35M	5.73684G	5.75319G	21.379M	5.734295G	5.755675G	500k	2

802.11a_Nss1,(6Mbps)_2TX

EBW

5785MHz

06/02/2020

CF
5.785GHz
Span
60MHz
RBW
100kHz
VBW
300kHz
Sweep Time
100ms
Detector Type
Peak

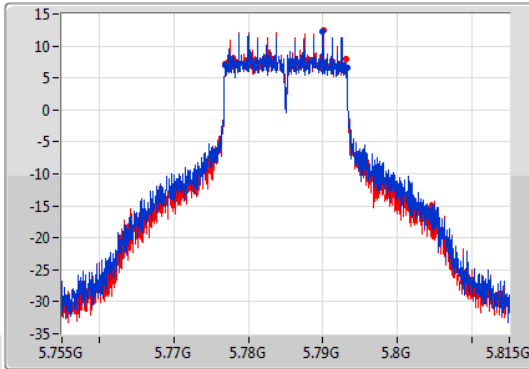

CF
5.785GHz
Span
60MHz
RBW
200kHz
VBW
1MHz
Sweep Time
100ms
Detector Type
Peak

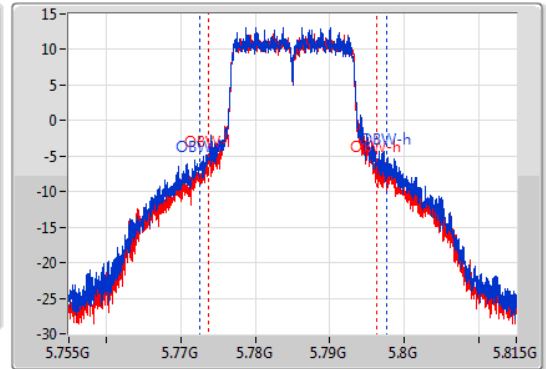

6dB(Hz)	Fl-6dB(Hz)	Fh-6dB(Hz)	OBW(Hz)	Fl-OBW(Hz)	Fh-OBW(Hz)	Limit(Hz)	Port
16.32M	5.77687G	5.79319G	25.187M	5.772466G	5.797654G	500k	1
16.29M	5.77687G	5.79316G	22.459M	5.773786G	5.796244G	500k	2

802.11a_Nss1,(6Mbps)_2TX

EBW

5825MHz

06/02/2020

CF
5.825GHz
Span
60MHz
RBW
100kHz
VBW
300kHz
Sweep Time
100ms
Detector Type
Peak

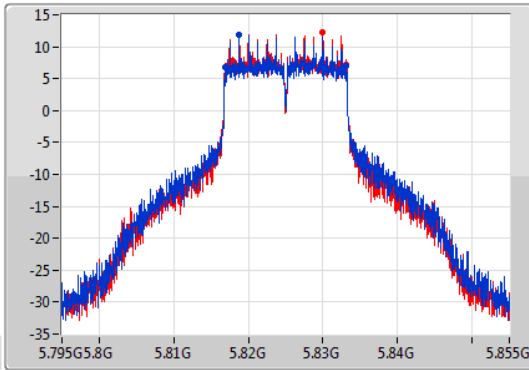

CF
5.825GHz
Span
60MHz
RBW
200kHz
VBW
1MHz
Sweep Time
100ms
Detector Type
Peak

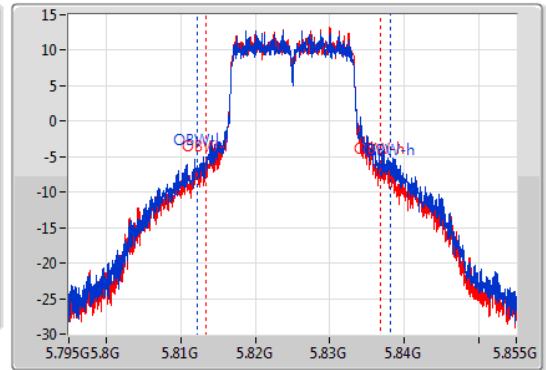

6dB(Hz)	Fl-6dB(Hz)	Fh-6dB(Hz)	OBW(Hz)	Fl-OBW(Hz)	Fh-OBW(Hz)	Limit(Hz)	Port
16.29M	5.81687G	5.83316G	25.997M	5.812196G	5.838193G	500k	1
16.32M	5.81684G	5.83316G	23.328M	5.813396G	5.836724G	500k	2

802.11ac VHT20_Nss2,(MCS0)_2TX

EBW

5180MHz

06/02/2020

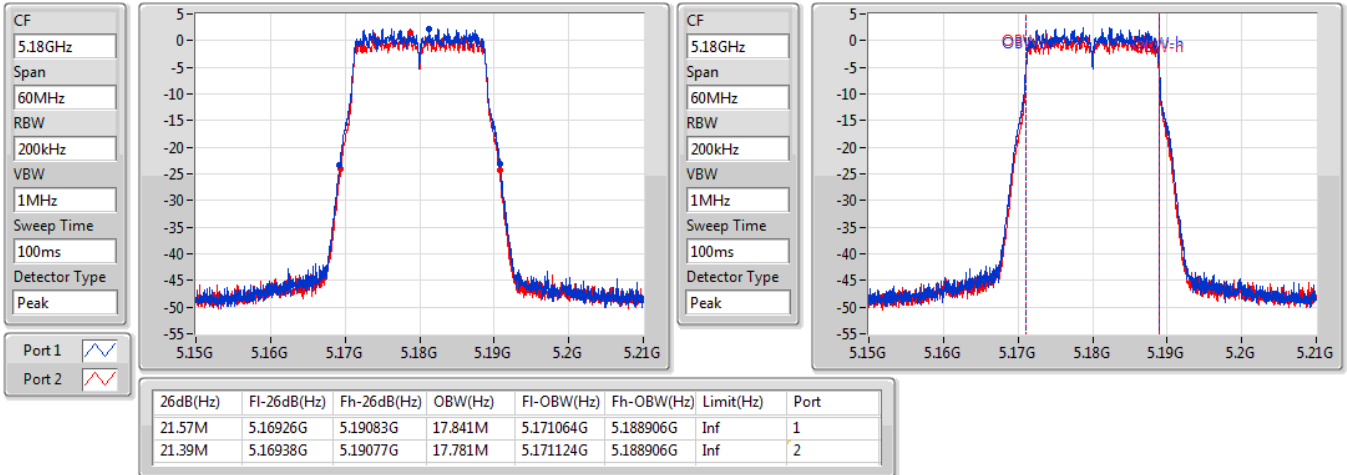

802.11ac VHT20_Nss2,(MCS0)_2TX

EBW

5200MHz

06/02/2020

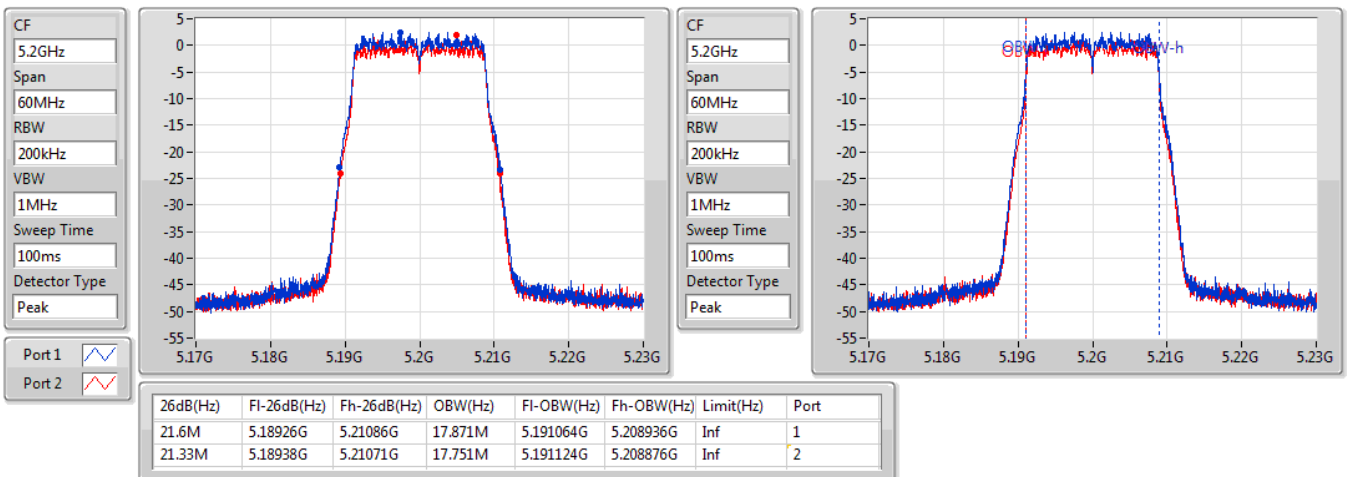

802.11ac VHT20_Nss2,(MCS0)_2TX

EBW

5240MHz

06/02/2020

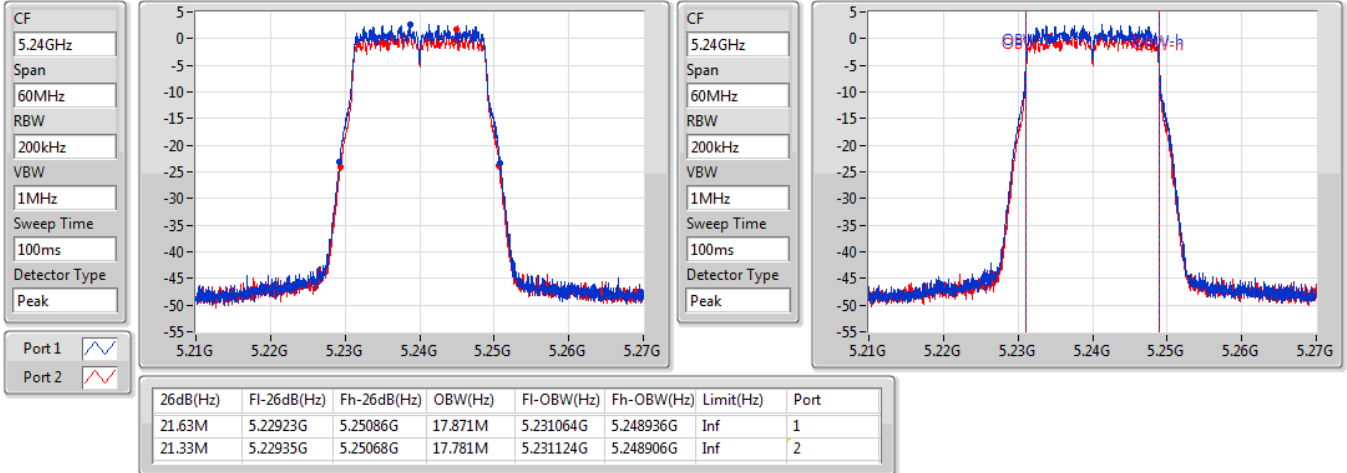

802.11ac VHT20_Nss2,(MCS0)_2TX

EBW

5745MHz

06/02/2020

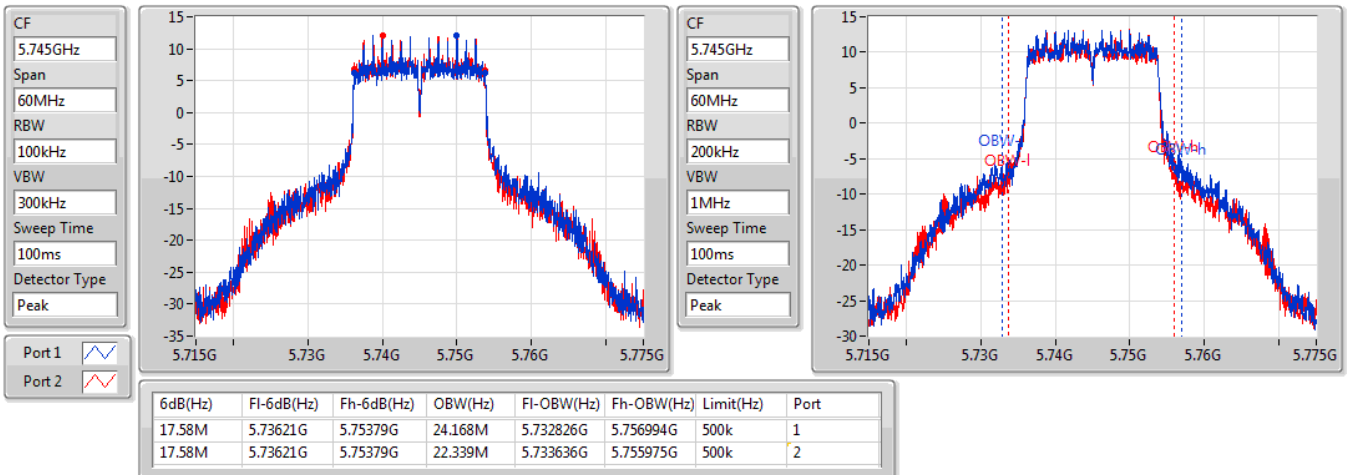

802.11ac VHT20_Nss2,(MCS0)_2TX

EBW

5785MHz

06/02/2020

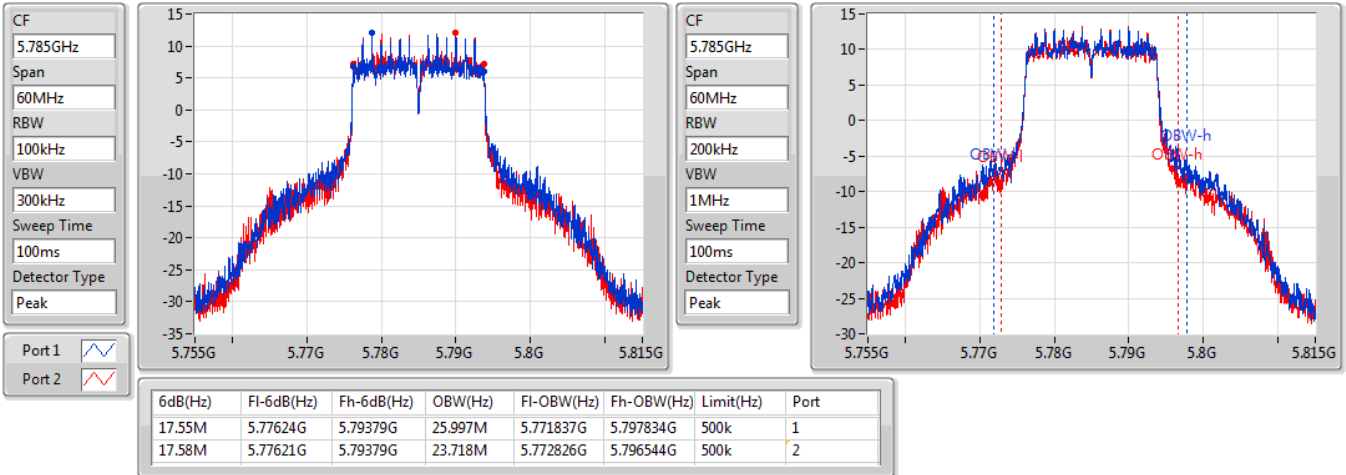

802.11ac VHT20_Nss2,(MCS0)_2TX

EBW

5825MHz

06/02/2020

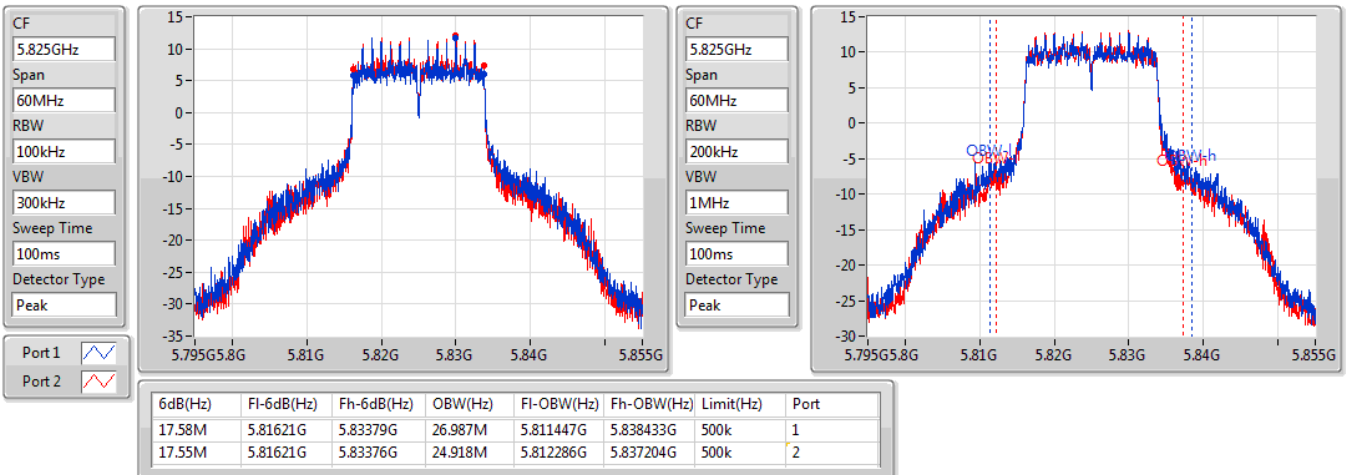

802.11ac VHT40_Nss2,(MCS0)_2TX

EBW

5190MHz

06/02/2020

CF
5.19GHz
Span
120MHz
RBW
500kHz
VBW
2MHz
Sweep Time
100ms
Detector Type
Peak

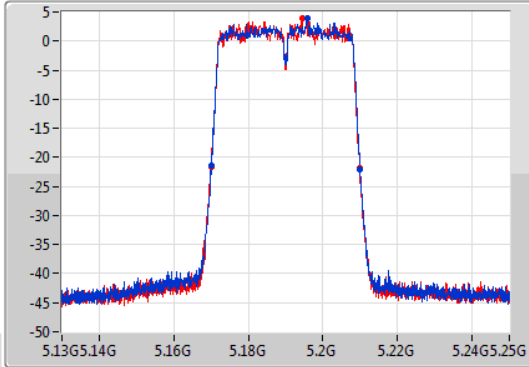

CF
5.19GHz
Span
120MHz
RBW
500kHz
VBW
2MHz
Sweep Time
100ms
Detector Type
Peak

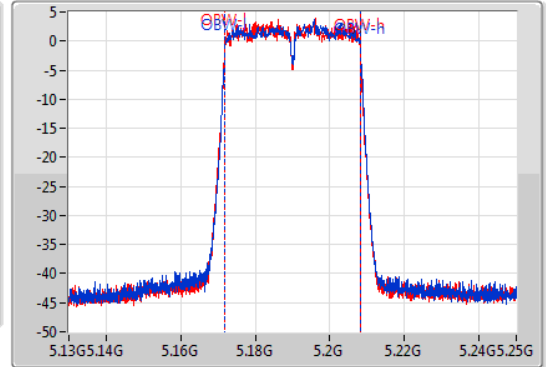

26dB(Hz)	Fl-26dB(Hz)	Fh-26dB(Hz)	OBW(Hz)	Fl-OBW(Hz)	Fh-OBW(Hz)	Limit(Hz)	Port
39.96M	5.16996G	5.20992G	36.402M	5.171829G	5.208231G	Inf	1
39.9M	5.16996G	5.20986G	36.282M	5.171829G	5.208111G	Inf	2

802.11ac VHT40_Nss2,(MCS0)_2TX

EBW

5230MHz

06/02/2020

CF
5.23GHz
Span
120MHz
RBW
500kHz
VBW
2MHz
Sweep Time
100ms
Detector Type
Peak

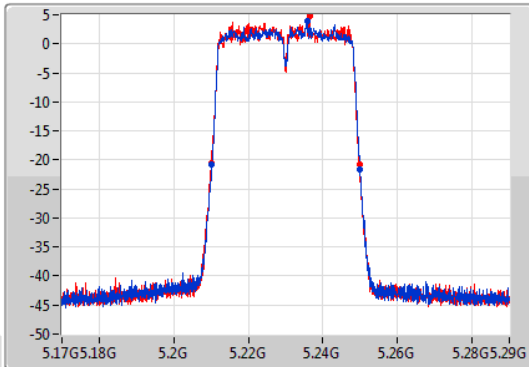

CF
5.23GHz
Span
120MHz
RBW
500kHz
VBW
2MHz
Sweep Time
100ms
Detector Type
Peak

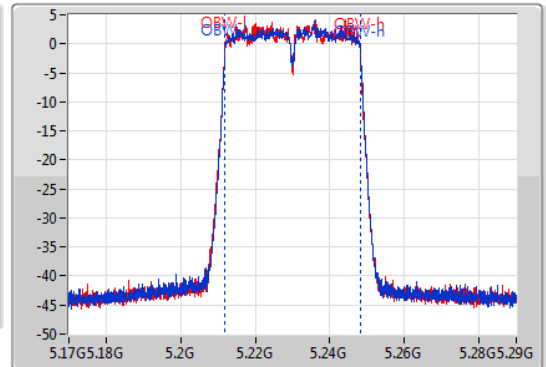

26dB(Hz)	Fl-26dB(Hz)	Fh-26dB(Hz)	OBW(Hz)	Fl-OBW(Hz)	Fh-OBW(Hz)	Limit(Hz)	Port
39.78M	5.21014G	5.24992G	36.402M	5.211829G	5.248231G	Inf	1
39.78M	5.21002G	5.2498G	36.282M	5.211829G	5.248111G	Inf	2

802.11ac VHT40_Nss2,(MCS0)_2TX

EBW

5755MHz

06/02/2020

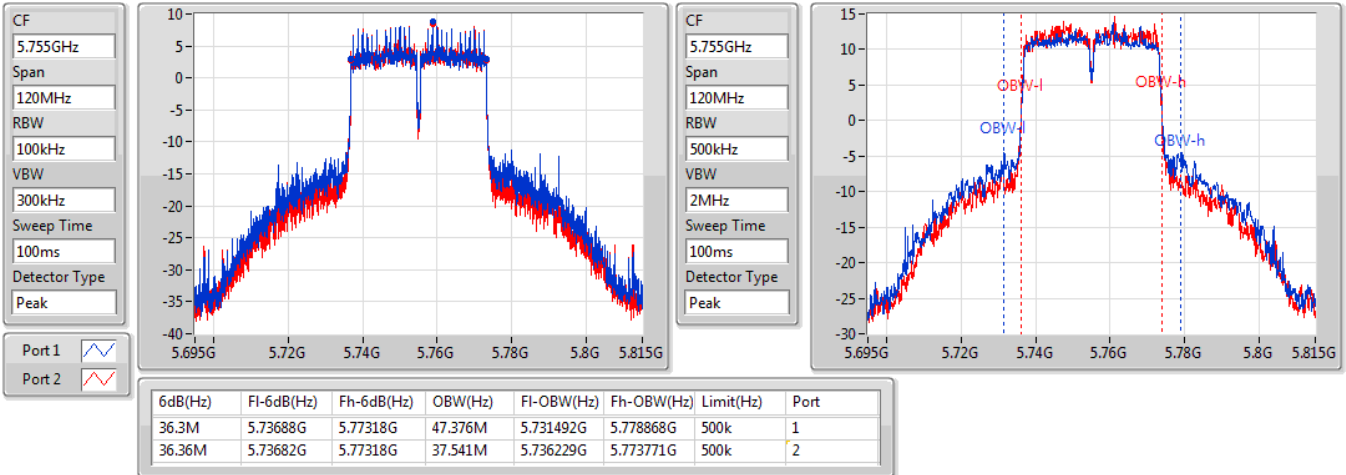

802.11ac VHT40_Nss2,(MCS0)_2TX

EBW

5795MHz

06/02/2020

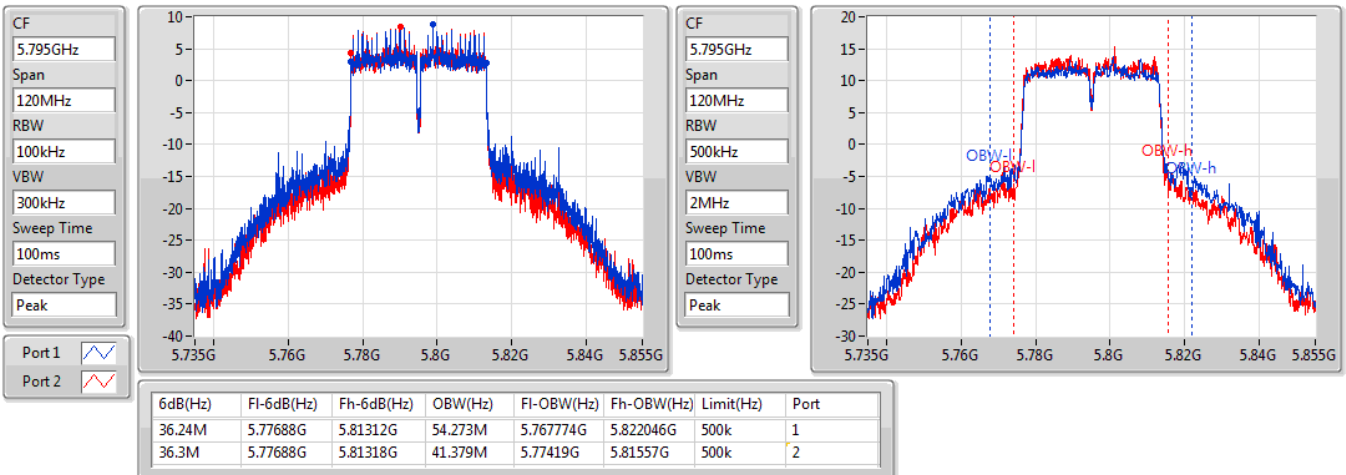

802.11ac VHT80_Nss2,(MCS0)_2TX

EBW

5210MHz

06/02/2020

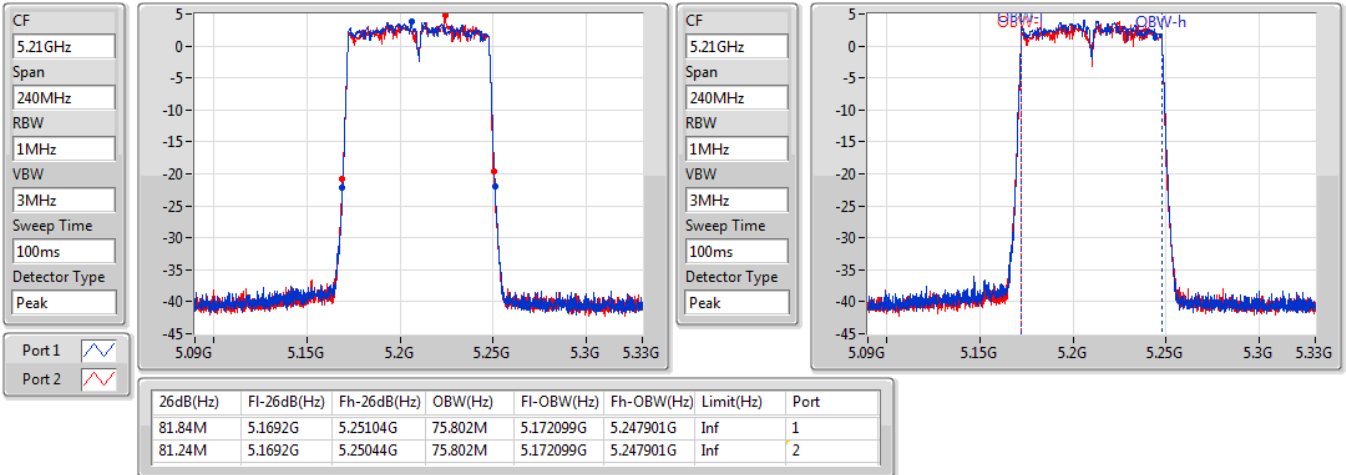

802.11ac VHT80_Nss2,(MCS0)_2TX

EBW

5775MHz

06/02/2020

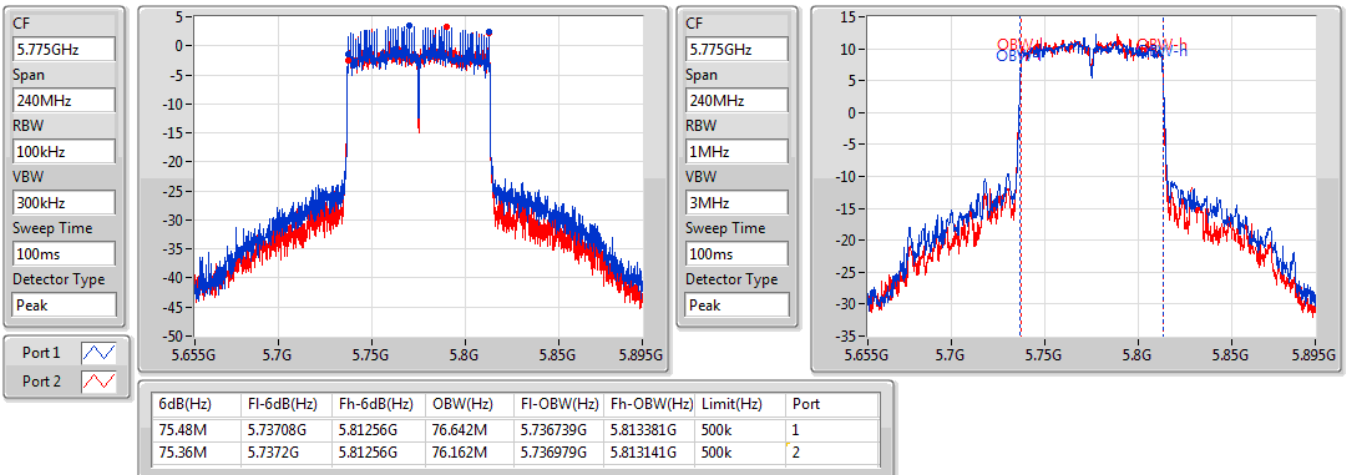

802.11ax HEW20_Nss2,(MCS0)_2TX

EBW

5180MHz

06/02/2020

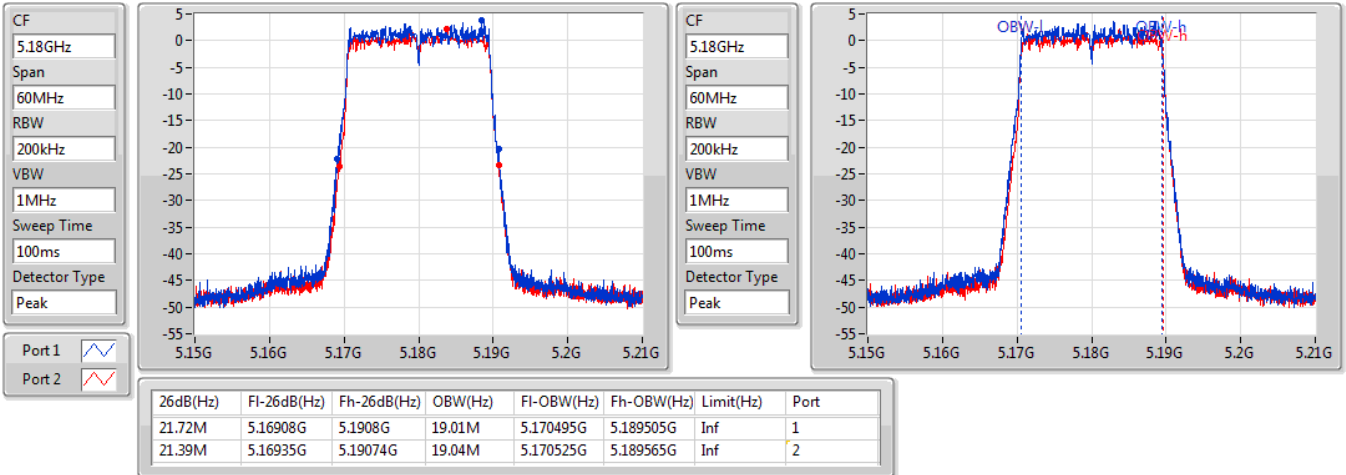

802.11ax HEW20_Nss2,(MCS0)_2TX

EBW

5200MHz

06/02/2020

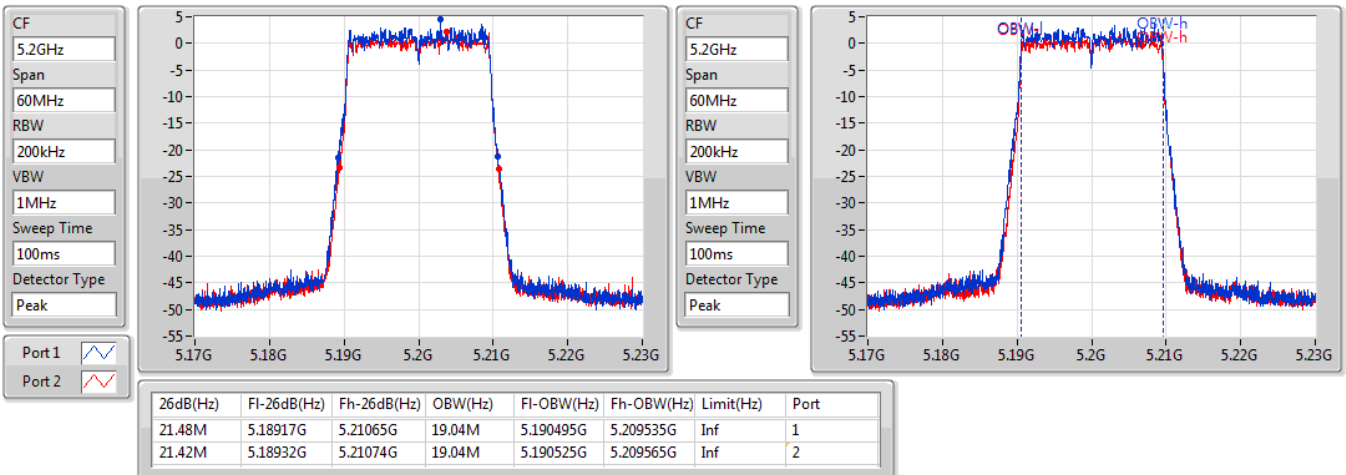

802.11ax HEW20_Nss2,(MCS0)_2TX

EBW

5240MHz

06/02/2020

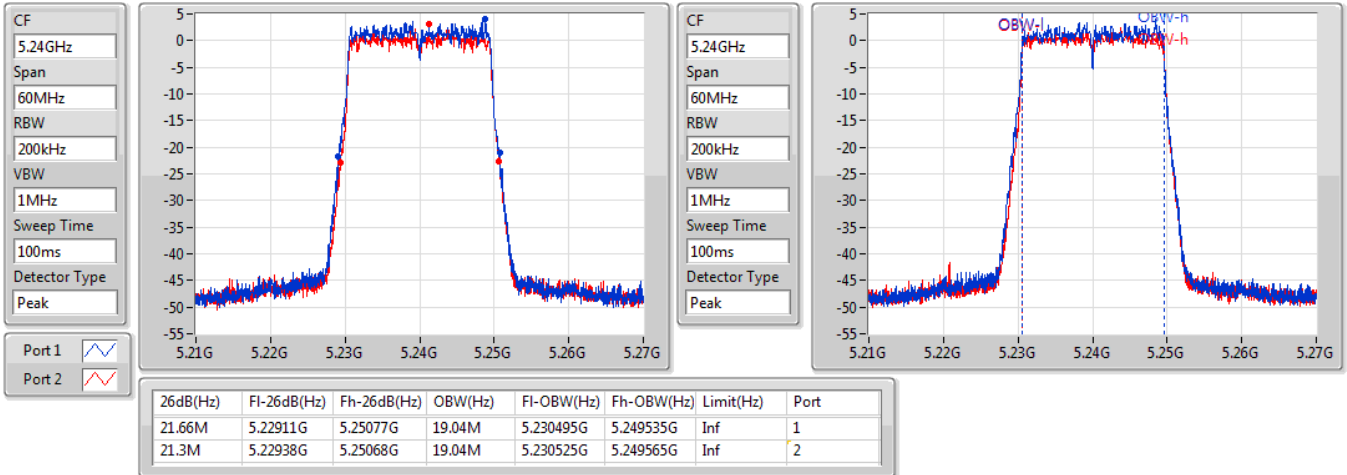

802.11ax HEW20_Nss2,(MCS0)_2TX

EBW

5745MHz

06/02/2020

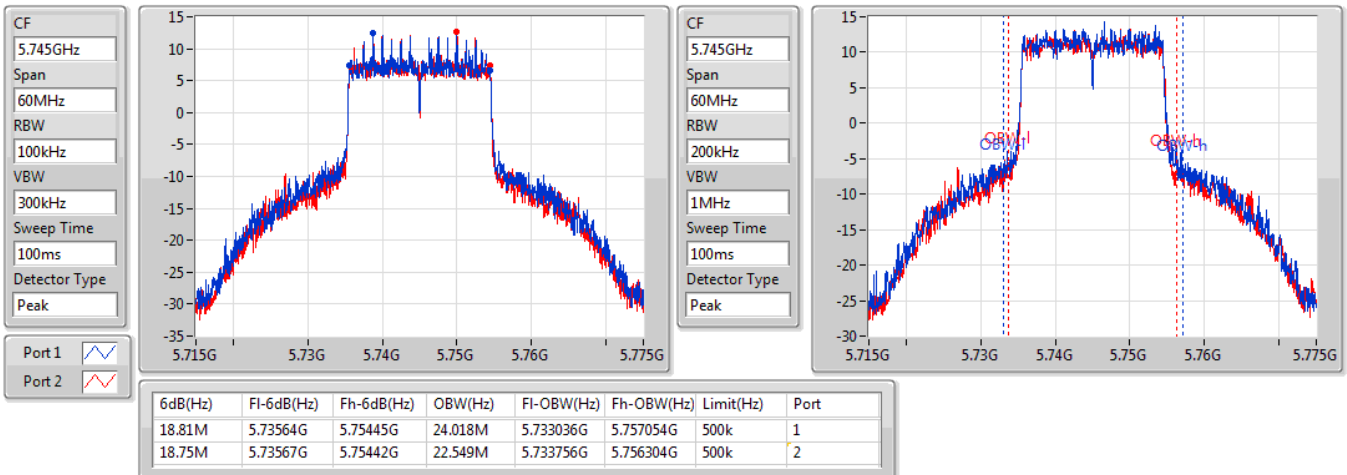

802.11ax HEW20_Nss2,(MCS0)_2TX

EBW

5785MHz

06/02/2020

CF
5.785GHz
Span
60MHz
RBW
100kHz
VBW
300kHz
Sweep Time
100ms
Detector Type
Peak

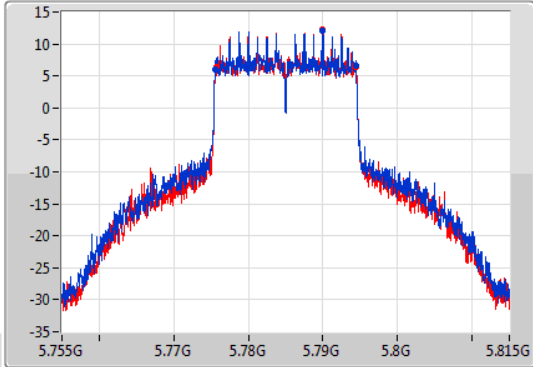

CF
5.785GHz
Span
60MHz
RBW
200kHz
VBW
1MHz
Sweep Time
100ms
Detector Type
Peak

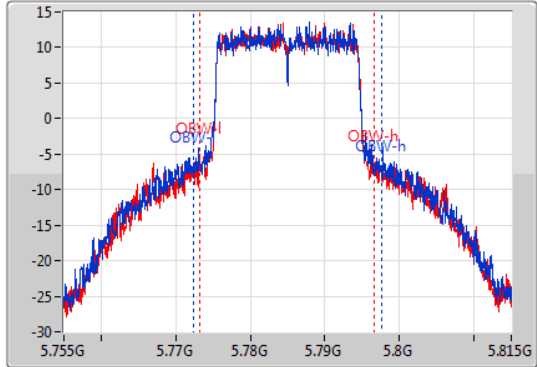

6dB(Hz)	Fl-6dB(Hz)	Fh-6dB(Hz)	OBW(Hz)	Fl-OBW(Hz)	Fh-OBW(Hz)	Limit(Hz)	Port
18.9M	5.77555G	5.79445G	25.187M	5.772376G	5.797564G	500k	1
18.75M	5.77573G	5.79448G	23.418M	5.773276G	5.796694G	500k	2

802.11ax HEW20_Nss2,(MCS0)_2TX

EBW

5825MHz

06/02/2020

CF
5.825GHz
Span
60MHz
RBW
100kHz
VBW
300kHz
Sweep Time
100ms
Detector Type
Peak

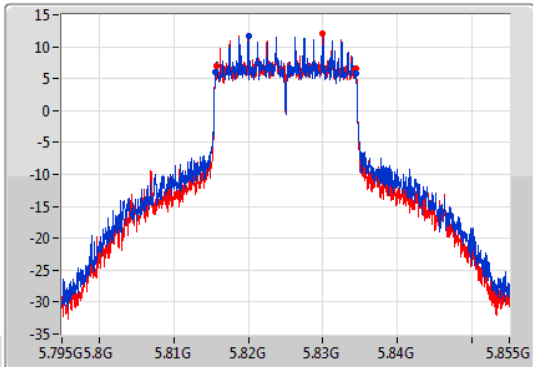

CF
5.825GHz
Span
60MHz
RBW
200kHz
VBW
1MHz
Sweep Time
100ms
Detector Type
Peak

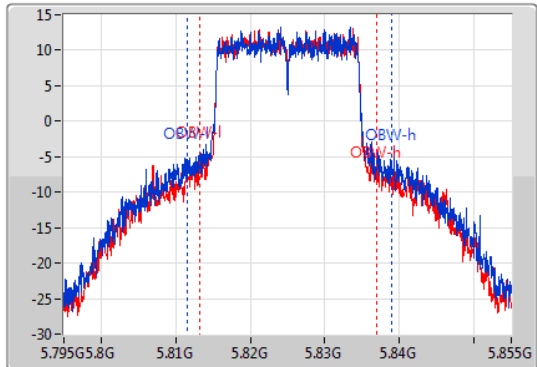

6dB(Hz)	Fl-6dB(Hz)	Fh-6dB(Hz)	OBW(Hz)	Fl-OBW(Hz)	Fh-OBW(Hz)	Limit(Hz)	Port
18.84M	5.81561G	5.83445G	27.406M	5.811477G	5.838883G	500k	1
18.63M	5.81576G	5.83439G	23.628M	5.813246G	5.836874G	500k	2

802.11ax HEW40_Nss2,(MCS0)_2TX

EBW

5190MHz

06/02/2020

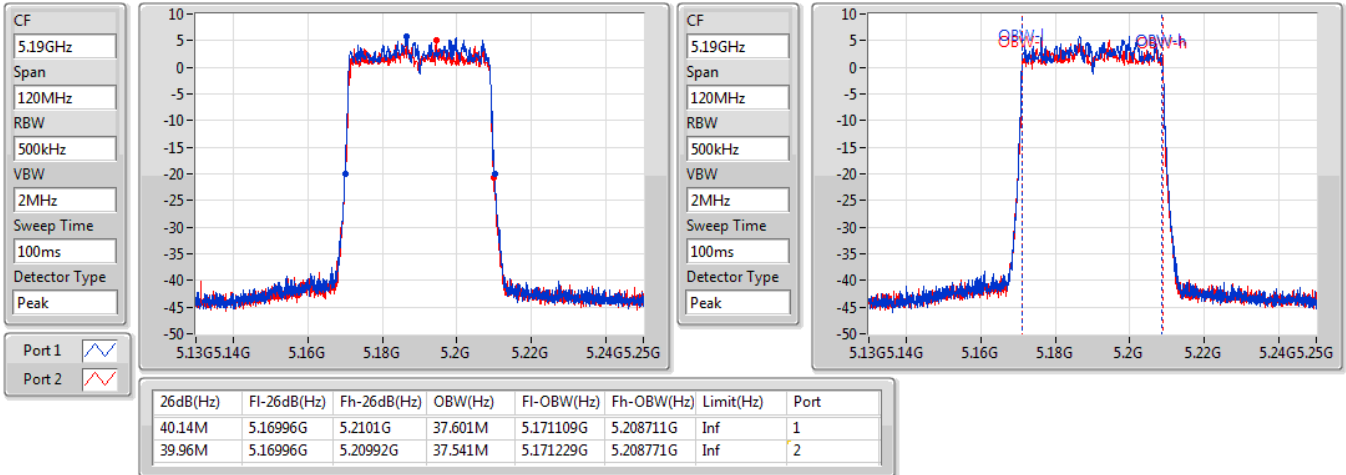

802.11ax HEW40_Nss2,(MCS0)_2TX

EBW

5230MHz

06/02/2020

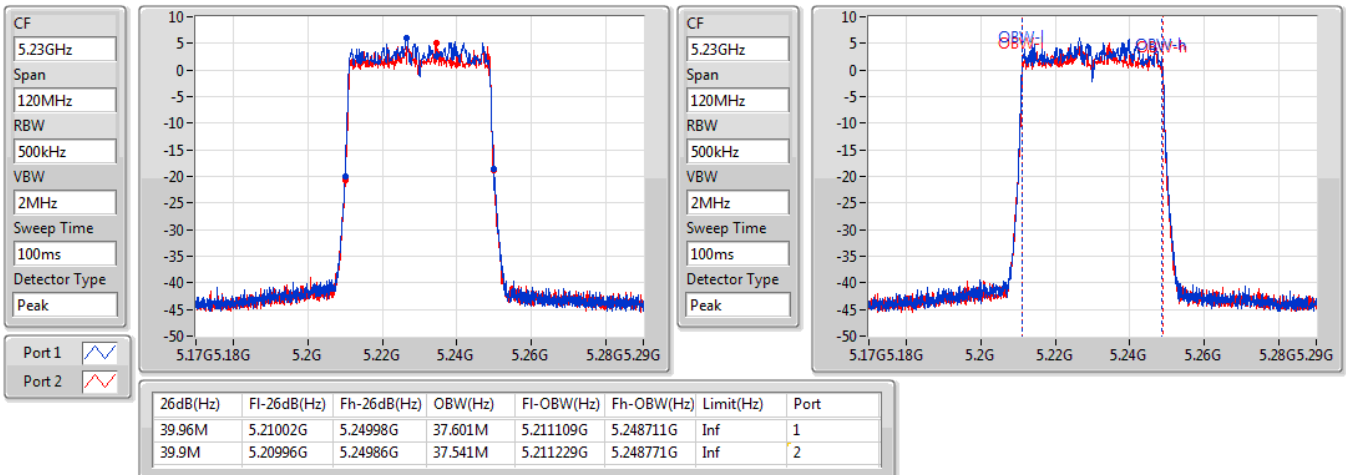

802.11ax HEW40_Nss2,(MCS0)_2TX

EBW

5755MHz

06/02/2020



802.11ax HEW40_Nss2,(MCS0)_2TX

EBW

5795MHz

06/02/2020

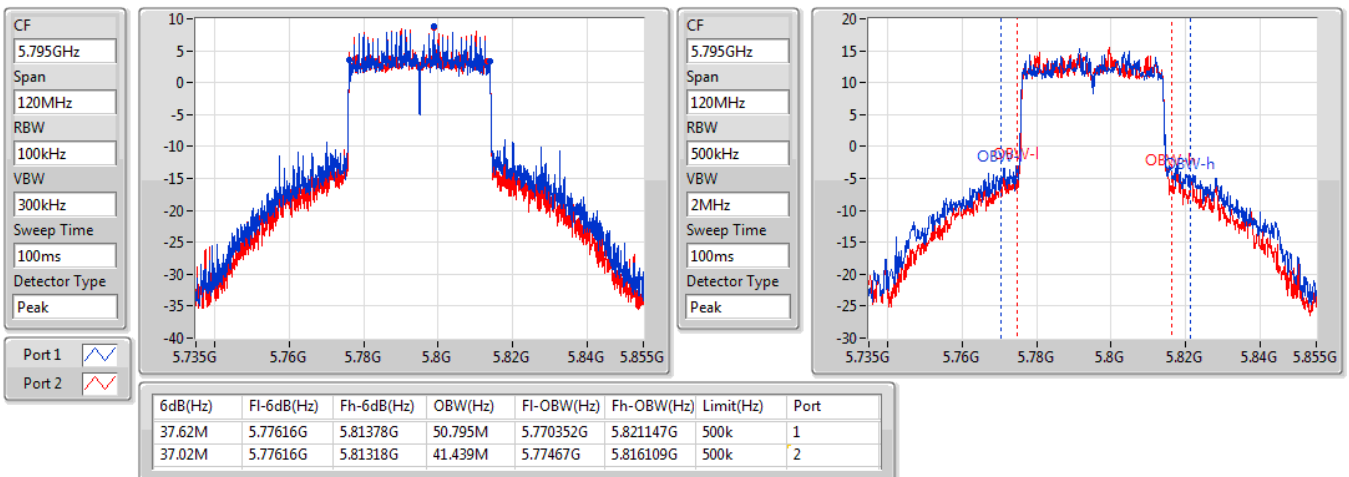

802.11ax HEW80_Nss2,(MCS0)_2TX

EBW

5210MHz

06/02/2020

CF
5.21GHz
Span
240MHz
RBW
1MHz
VBW
3MHz
Sweep Time
100ms
Detector Type
Peak

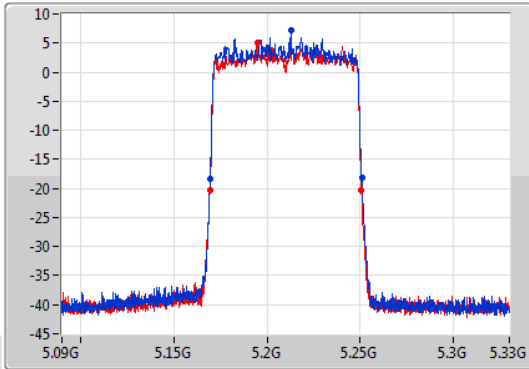

CF
5.21GHz
Span
240MHz
RBW
1MHz
VBW
3MHz
Sweep Time
100ms
Detector Type
Peak

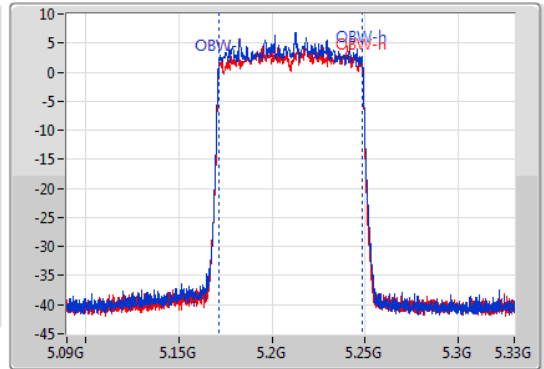

26dB(Hz)	Fl-26dB(Hz)	Fh-26dB(Hz)	OBW(Hz)	Fl-OBW(Hz)	Fh-OBW(Hz)	Limit(Hz)	Port
81.36M	5.16944G	5.2508G	77.121M	5.171499G	5.248621G	Inf	1
81.36M	5.16932G	5.25068G	77.001M	5.171619G	5.248621G	Inf	2

802.11ax HEW80_Nss2,(MCS0)_2TX

EBW

5775MHz

06/02/2020

CF
5.775GHz
Span
240MHz
RBW
100kHz
VBW
300kHz
Sweep Time
100ms
Detector Type
Peak

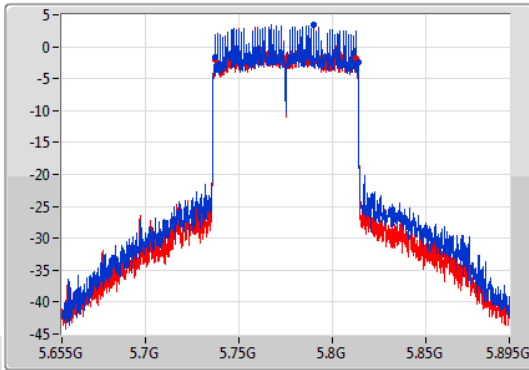

CF
5.775GHz
Span
240MHz
RBW
1MHz
VBW
3MHz
Sweep Time
100ms
Detector Type
Peak

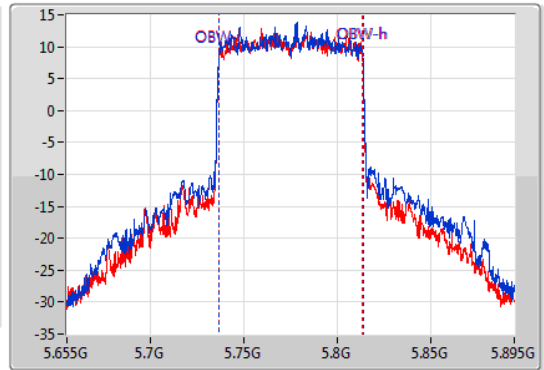

6dB(Hz)	Fl-6dB(Hz)	Fh-6dB(Hz)	OBW(Hz)	Fl-OBW(Hz)	Fh-OBW(Hz)	Limit(Hz)	Port
76.68M	5.7372G	5.81388G	77.601M	5.736259G	5.813861G	500k	1
75.72M	5.7372G	5.81292G	77.361M	5.736379G	5.813741G	500k	2



Summary

Mode	Max-N dB (Hz)	Max-OBW (Hz)	ITU-Code	Min-N dB (Hz)	Min-OBW (Hz)
5.15-5.25GHz	-	-	-	-	-
802.11a_Nss1,(6Mbps)_1TX	35.85M	19.58M	19M6D1D	21.27M	16.822M
802.11ac VHT20_Nss1,(MCS0)_1TX	36.36M	19.31M	19M3D1D	21.54M	17.841M
802.11ac VHT40_Nss1,(MCS0)_1TX	49.2M	36.642M	36M6D1D	40.26M	36.462M
802.11ac VHT80_Nss1,(MCS0)_1TX	82.32M	75.802M	75M8D1D	82.32M	75.802M
802.11ax HEW20_Nss1,(MCS0)_1TX	41.07M	19.88M	19M9D1D	21.48M	19.01M
802.11ax HEW40_Nss1,(MCS0)_1TX	43.68M	37.661M	37M7D1D	40.2M	37.481M
802.11ax HEW80_Nss1,(MCS0)_1TX	82.08M	77.001M	77M0D1D	82.08M	77.001M
5.725-5.85GHz	-	-	-	-	-
802.11a_Nss1,(6Mbps)_1TX	16.32M	23.898M	23M9D1D	16.32M	17.181M
802.11ac VHT20_Nss1,(MCS0)_1TX	17.58M	26.567M	26M6D1D	17.55M	25.367M
802.11ac VHT40_Nss1,(MCS0)_1TX	36.36M	41.019M	41M0D1D	36.3M	37.241M
802.11ac VHT80_Nss1,(MCS0)_1TX	75.24M	75.922M	75M9D1D	75.24M	75.922M
802.11ax HEW20_Nss1,(MCS0)_1TX	18.84M	27.226M	27M2D1D	18.78M	25.457M
802.11ax HEW40_Nss1,(MCS0)_1TX	37.62M	38.321M	38M3D1D	37.5M	37.901M
802.11ax HEW80_Nss1,(MCS0)_1TX	76.8M	77.121M	77M1D1D	76.8M	77.121M

Max-N dB = Maximum 6dB down bandwidth for 5.725-5.85GHz band / Maximum 26dB down bandwidth for other band;

Max-OBW = Maximum 99% occupied bandwidth;

Min-N dB = Minimum 6dB down bandwidth for 5.725-5.85GHz band / Maximum 26dB down bandwidth for other band;

Min-OBW = Minimum 99% occupied bandwidth;



Result

Mode	Result	Limit (Hz)	Port 1-N dB (Hz)	Port 1-OBW (Hz)
802.11a_Nss1,(6Mbps)_1TX	-	-	-	-
5180MHz	Pass	Inf	21.27M	16.822M
5200MHz	Pass	Inf	35.64M	18.651M
5240MHz	Pass	Inf	35.85M	19.58M
5745MHz	Pass	500k	16.32M	17.181M
5785MHz	Pass	500k	16.32M	23.898M
5825MHz	Pass	500k	16.32M	22.639M
802.11ac VHT20_Nss1,(MCS0)_1TX	-	-	-	-
5180MHz	Pass	Inf	21.54M	17.841M
5200MHz	Pass	Inf	26.76M	18.111M
5240MHz	Pass	Inf	36.36M	19.31M
5745MHz	Pass	500k	17.55M	26.567M
5785MHz	Pass	500k	17.58M	25.367M
5825MHz	Pass	500k	17.55M	25.367M
802.11ac VHT40_Nss1,(MCS0)_1TX	-	-	-	-
5190MHz	Pass	Inf	40.26M	36.462M
5230MHz	Pass	Inf	49.2M	36.642M
5755MHz	Pass	500k	36.36M	37.241M
5795MHz	Pass	500k	36.3M	41.019M
802.11ac VHT80_Nss1,(MCS0)_1TX	-	-	-	-
5210MHz	Pass	Inf	82.32M	75.802M
5775MHz	Pass	500k	75.24M	75.922M
802.11ax HEW20_Nss1,(MCS0)_1TX	-	-	-	-
5180MHz	Pass	Inf	21.48M	19.01M
5200MHz	Pass	Inf	30.57M	19.19M
5240MHz	Pass	Inf	41.07M	19.88M
5745MHz	Pass	500k	18.84M	27.226M
5785MHz	Pass	500k	18.81M	25.877M
5825MHz	Pass	500k	18.78M	25.457M
802.11ax HEW40_Nss1,(MCS0)_1TX	-	-	-	-
5190MHz	Pass	Inf	40.2M	37.481M
5230MHz	Pass	Inf	43.68M	37.661M
5755MHz	Pass	500k	37.5M	37.901M
5795MHz	Pass	500k	37.62M	38.321M
802.11ax HEW80_Nss1,(MCS0)_1TX	-	-	-	-
5210MHz	Pass	Inf	82.08M	77.001M
5775MHz	Pass	500k	76.8M	77.121M

Port X-N dB = Port X 6dB down bandwidth for 5.725-5.85GHz band / 26dB down bandwidth for other band
Port X-OBW = Port X 99% occupied bandwidth;

802.11a_Nss1,(6Mbps)_1TX

EBW

5180MHz

03/02/2020

CF
 5.18GHz
 Span
 60MHz
 RBW
 200kHz
 VBW
 1MHz
 Sweep Time
 100ms
 Detector Type
 Peak

Port1

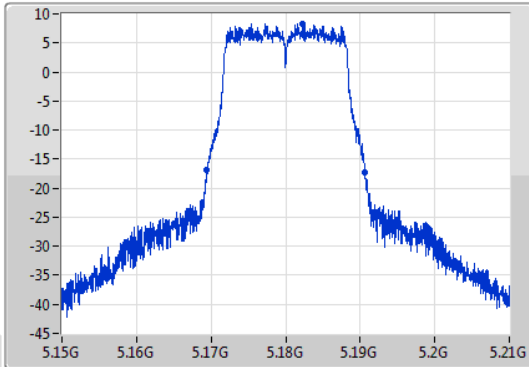

CF
 5.18GHz
 Span
 60MHz
 RBW
 200kHz
 VBW
 1MHz
 Sweep Time
 100ms
 Detector Type
 Peak

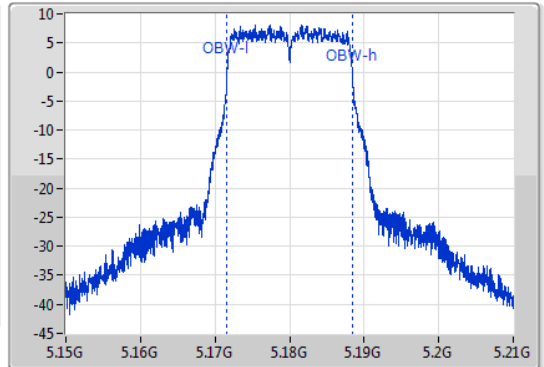

26dB(Hz)	Fl-26dB(Hz)	Fh-26dB(Hz)	OBW(Hz)	Fl-OBW(Hz)	Fh-OBW(Hz)	Limit(Hz)	Port
21.27M	5.16941G	5.19068G	16.822M	5.171634G	5.188456G	Inf	1

802.11a_Nss1,(6Mbps)_1TX

EBW

5200MHz

03/02/2020

CF
 5.2GHz
 Span
 60MHz
 RBW
 200kHz
 VBW
 1MHz
 Sweep Time
 100ms
 Detector Type
 Peak

Port1

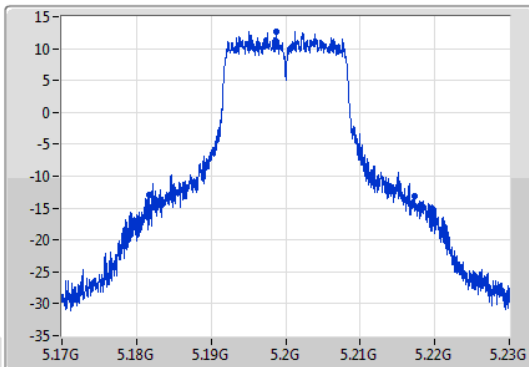

CF
 5.2GHz
 Span
 60MHz
 RBW
 200kHz
 VBW
 1MHz
 Sweep Time
 100ms
 Detector Type
 Peak

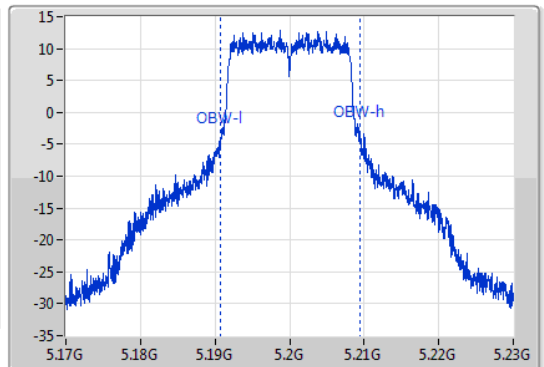

26dB(Hz)	Fl-26dB(Hz)	Fh-26dB(Hz)	OBW(Hz)	Fl-OBW(Hz)	Fh-OBW(Hz)	Limit(Hz)	Port
35.64M	5.18164G	5.21728G	18.651M	5.190795G	5.209445G	Inf	1

802.11a_Nss1,(6Mbps)_1TX

EBW

5240MHz

03/02/2020

CF
5.24GHz
Span
60MHz
RBW
200kHz
VBW
1MHz
Sweep Time
100ms
Detector Type
Peak
Port 1

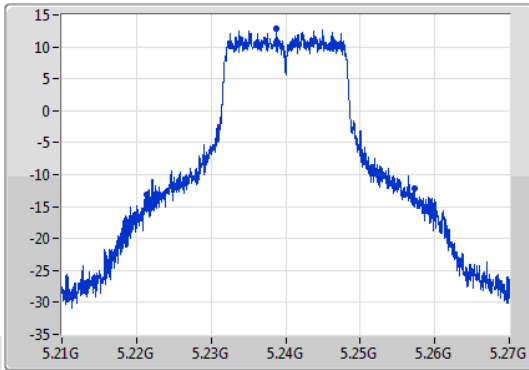

CF
5.24GHz
Span
60MHz
RBW
200kHz
VBW
1MHz
Sweep Time
100ms
Detector Type
Peak

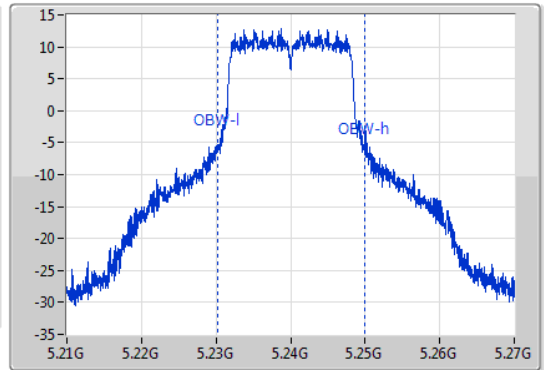

26dB(Hz)	Fl-26dB(Hz)	Fh-26dB(Hz)	OBW(Hz)	Fl-OBW(Hz)	Fh-OBW(Hz)	Limit(Hz)	Port
35.85M	5.22137G	5.25722G	19.58M	5.230285G	5.249865G	Inf	1

802.11a_Nss1,(6Mbps)_1TX

EBW

5745MHz

03/02/2020

CF
5.745GHz
Span
60MHz
RBW
100kHz
VBW
300kHz
Sweep Time
100ms
Detector Type
Peak
Port 1

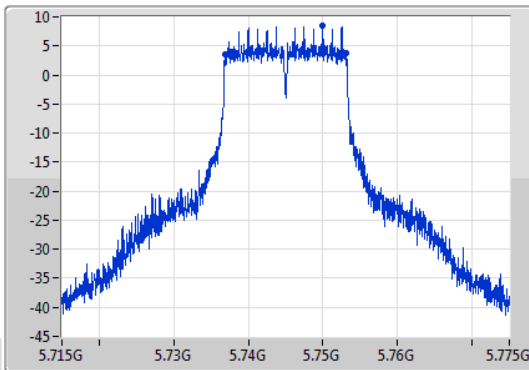

CF
5.745GHz
Span
60MHz
RBW
200kHz
VBW
1MHz
Sweep Time
100ms
Detector Type
Peak

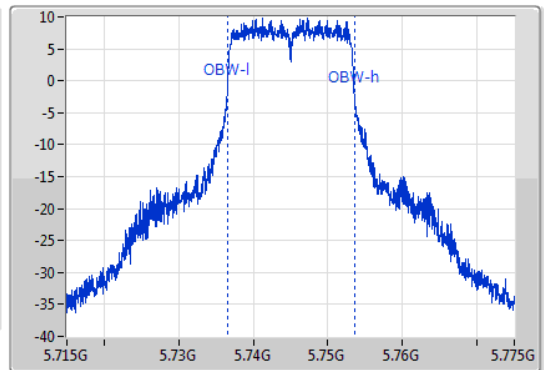

6dB(Hz)	Fl-6dB(Hz)	Fh-6dB(Hz)	OBW(Hz)	Fl-OBW(Hz)	Fh-OBW(Hz)	Limit(Hz)	Port
16.32M	5.73684G	5.75316G	17.181M	5.736484G	5.753666G	500k	1

802.11a_Nss1,(6Mbps)_1TX

EBW

5785MHz

03/02/2020

CF
5.785GHz
Span
60MHz
RBW
100kHz
VBW
300kHz
Sweep Time
100ms
Detector Type
Peak
Port 1

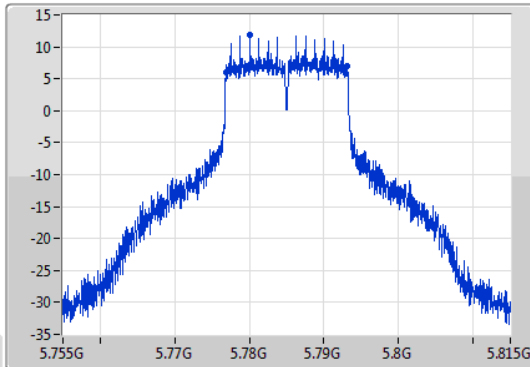

CF
5.785GHz
Span
60MHz
RBW
200kHz
VBW
1MHz
Sweep Time
100ms
Detector Type
Peak

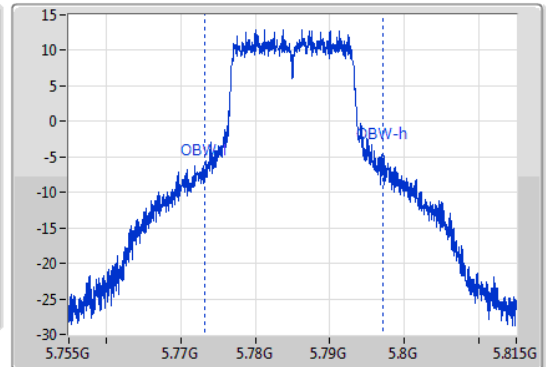

6dB(Hz)	Fl-6dB(Hz)	Fh-6dB(Hz)	OBW(Hz)	Fl-OBW(Hz)	Fh-OBW(Hz)	Limit(Hz)	Port
16.32M	5.77684G	5.79316G	23.898M	5.773276G	5.797174G	500k	1

802.11a_Nss1,(6Mbps)_1TX

EBW

5825MHz

03/02/2020

CF
5.825GHz
Span
60MHz
RBW
100kHz
VBW
300kHz
Sweep Time
100ms
Detector Type
Peak
Port 1

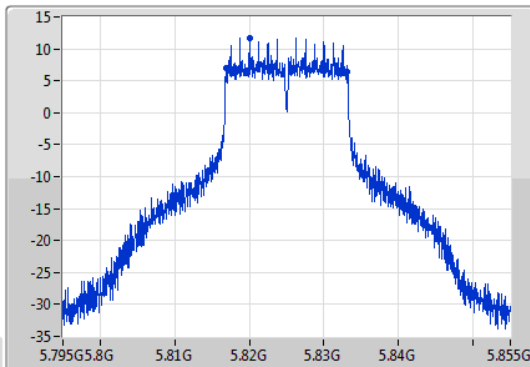

CF
5.825GHz
Span
60MHz
RBW
200kHz
VBW
1MHz
Sweep Time
100ms
Detector Type
Peak

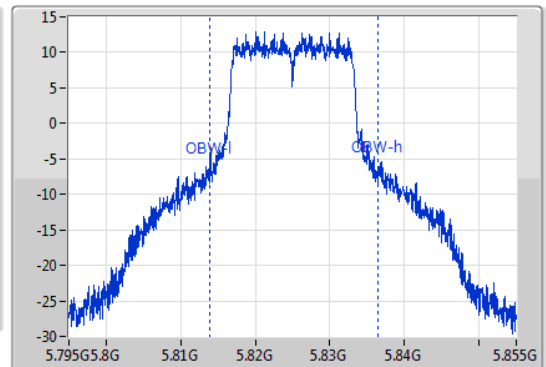

6dB(Hz)	Fl-6dB(Hz)	Fh-6dB(Hz)	OBW(Hz)	Fl-OBW(Hz)	Fh-OBW(Hz)	Limit(Hz)	Port
16.32M	5.81684G	5.83316G	22.639M	5.813846G	5.836484G	500k	1

802.11ac VHT20_Nss1,(MCS0)_1TX

EBW

5180MHz

04/02/2020

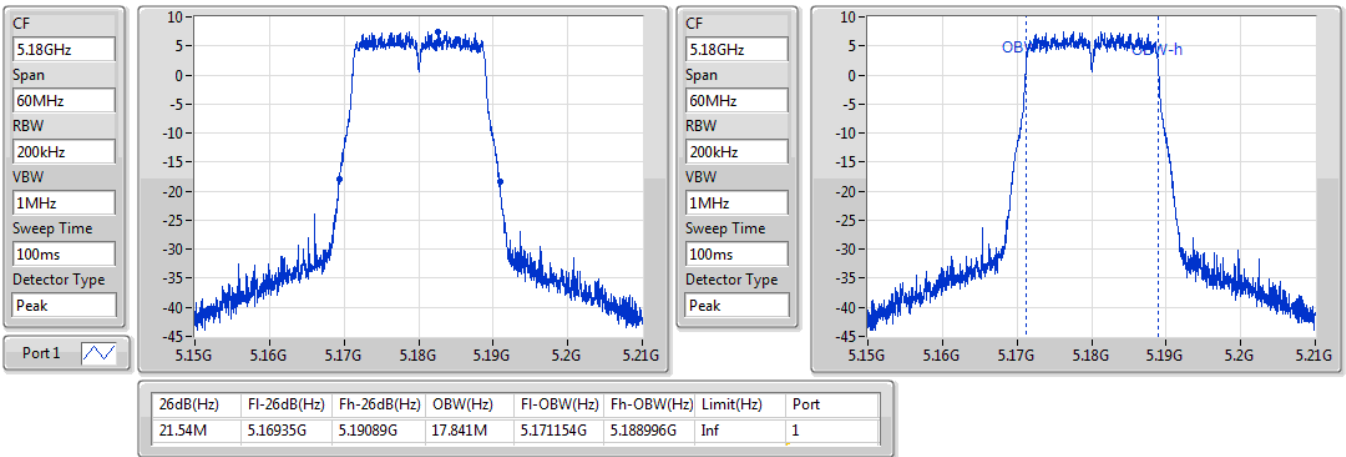

802.11ac VHT20_Nss1,(MCS0)_1TX

EBW

5200MHz

04/02/2020

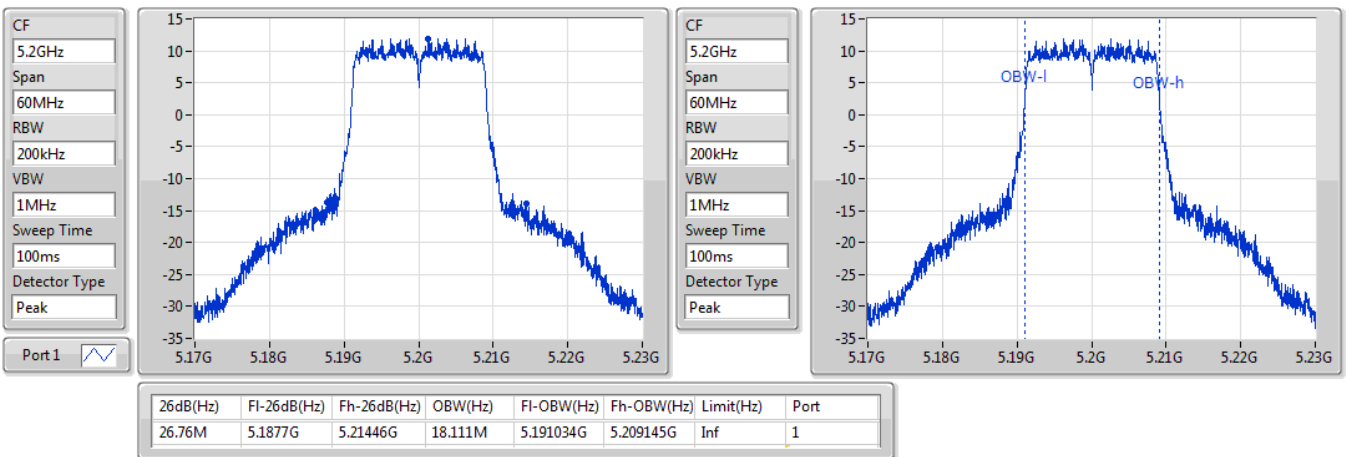

802.11ac VHT20_Nss1,(MCS0)_1TX

EBW

5240MHz

04/02/2020

CF
5.24GHz
Span
60MHz
RBW
200kHz
VBW
1MHz
Sweep Time
100ms
Detector Type
Peak
Port 1

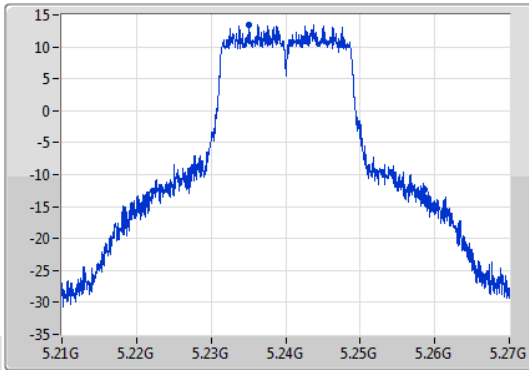

CF
5.24GHz
Span
60MHz
RBW
200kHz
VBW
1MHz
Sweep Time
100ms
Detector Type
Peak

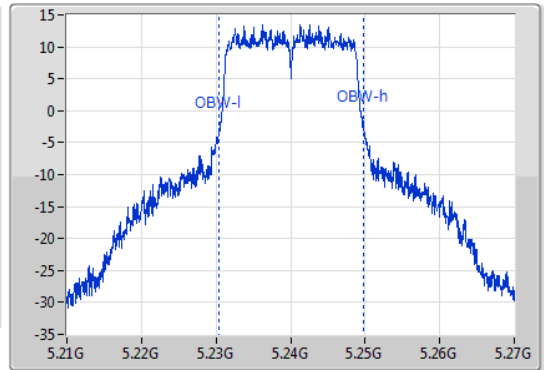

26dB(Hz)	Fl-26dB(Hz)	Fh-26dB(Hz)	OBW(Hz)	Fl-OBW(Hz)	Fh-OBW(Hz)	Limit(Hz)	Port
36.36M	5.22224G	5.2586G	19.31M	5.230465G	5.249775G	Inf	1

802.11ac VHT20_Nss1,(MCS0)_1TX

EBW

5745MHz

04/02/2020

CF
5.745GHz
Span
60MHz
RBW
100kHz
VBW
300kHz
Sweep Time
100ms
Detector Type
Peak
Port 1

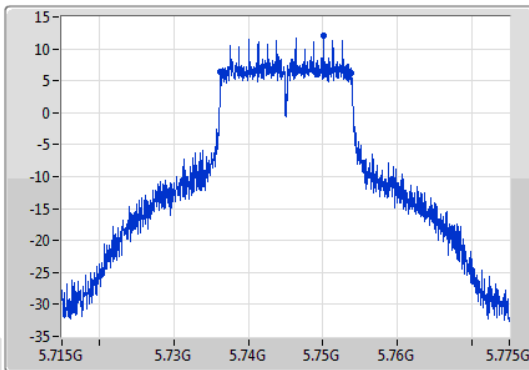

CF
5.745GHz
Span
60MHz
RBW
200kHz
VBW
1MHz
Sweep Time
100ms
Detector Type
Peak

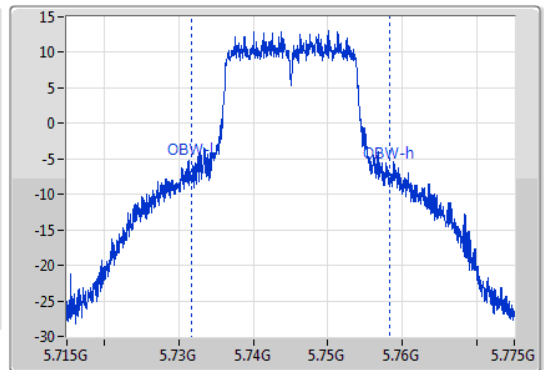

6dB(Hz)	Fl-6dB(Hz)	Fh-6dB(Hz)	OBW(Hz)	Fl-OBW(Hz)	Fh-OBW(Hz)	Limit(Hz)	Port
17.55M	5.7363G	5.75385G	26.567M	5.731687G	5.758253G	500k	1

802.11ac VHT20_Nss1,(MCS0)_1TX

EBW

5785MHz

04/02/2020

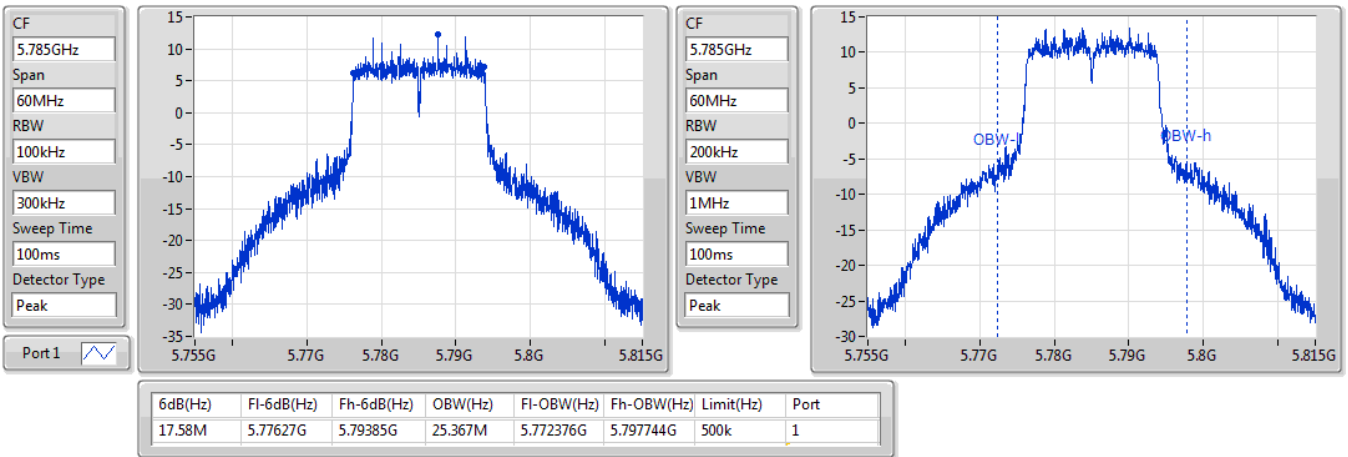

802.11ac VHT20_Nss1,(MCS0)_1TX

EBW

5825MHz

04/02/2020

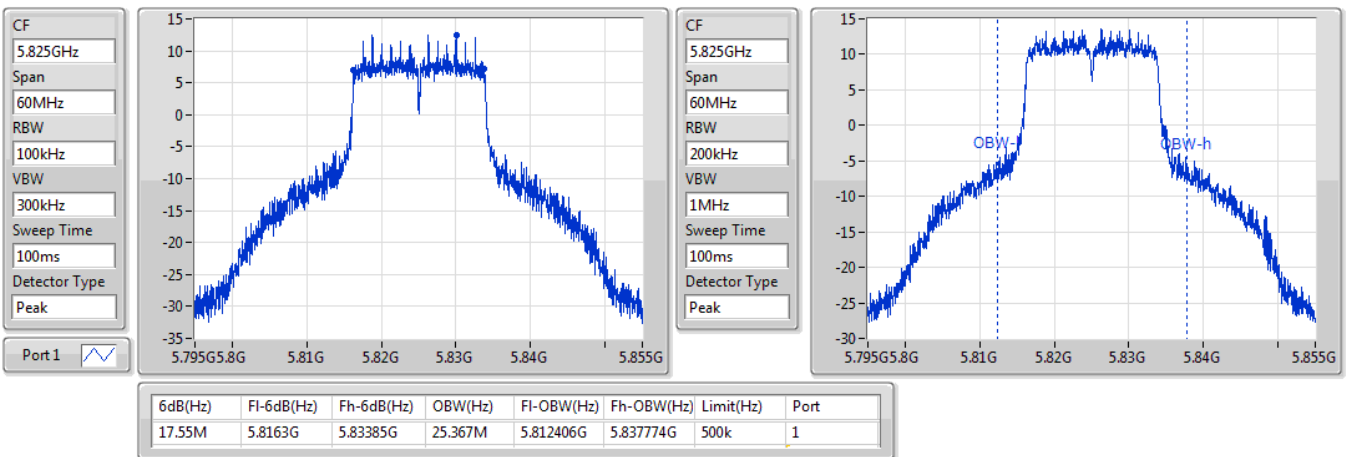

802.11ac VHT40_Nss1,(MCS0)_1TX

EBW

5190MHz

04/02/2020

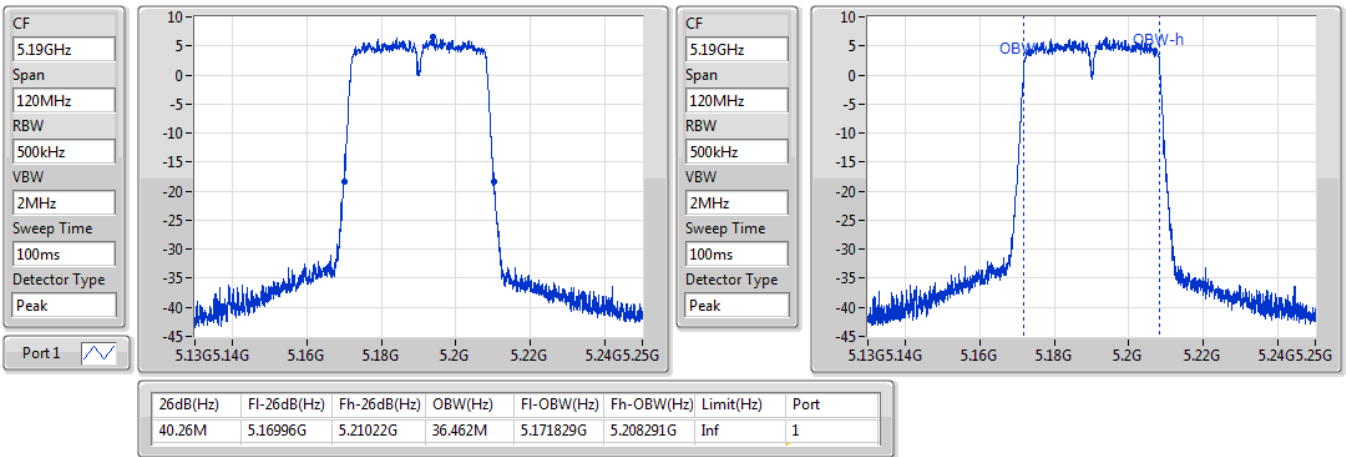

802.11ac VHT40_Nss1,(MCS0)_1TX

EBW

5230MHz

04/02/2020

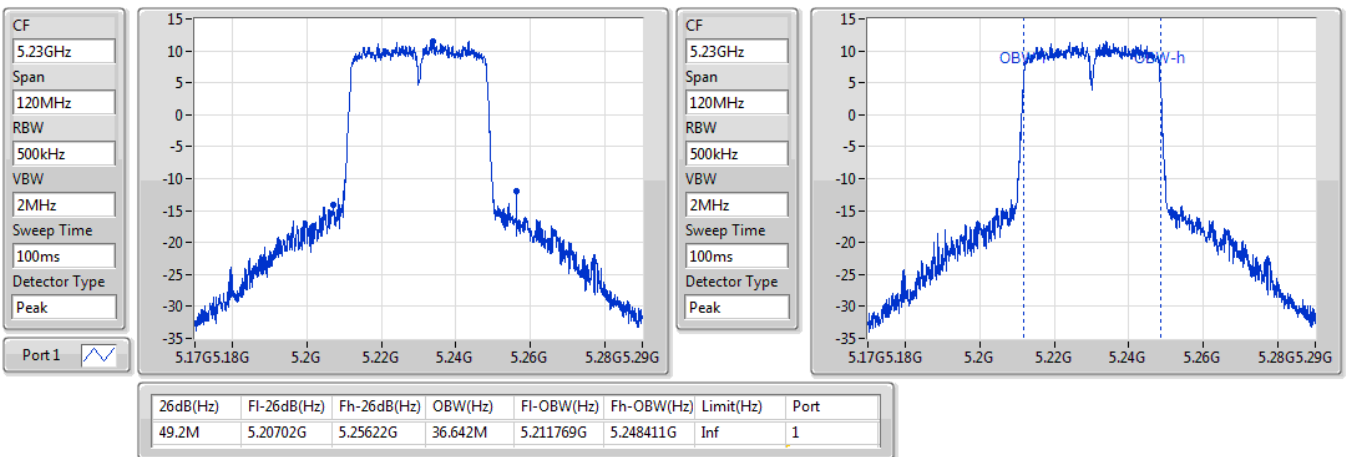

802.11ac VHT40_Nss1,(MCS0)_1TX

EBW

5755MHz

04/02/2020

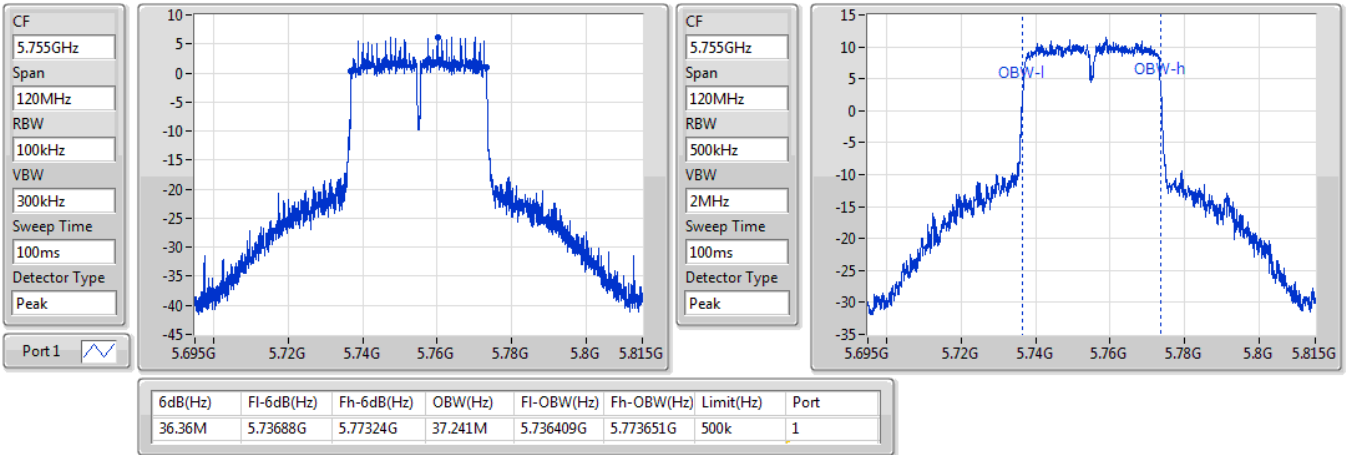

802.11ac VHT40_Nss1,(MCS0)_1TX

EBW

5795MHz

04/02/2020

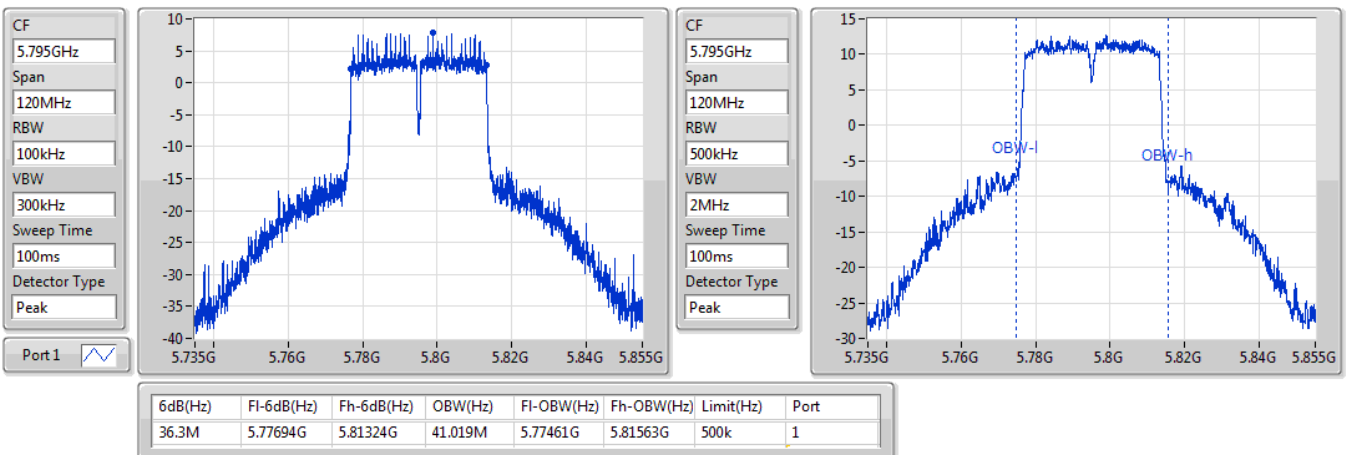

802.11ac VHT80_Nss1,(MCS0)_1TX

EBW

5210MHz

04/02/2020

CF
5.21GHz
Span
240MHz
RBW
1MHz
VBW
3MHz
Sweep Time
100ms
Detector Type
Peak
Port 1

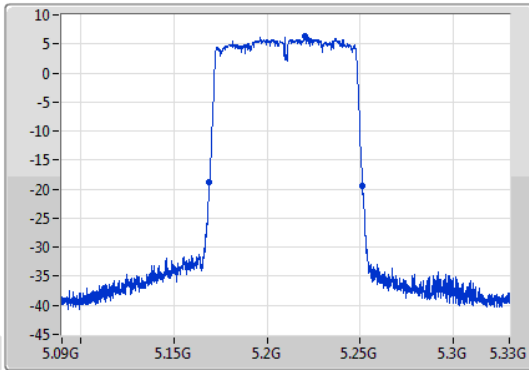

CF
5.21GHz
Span
240MHz
RBW
1MHz
VBW
3MHz
Sweep Time
100ms
Detector Type
Peak

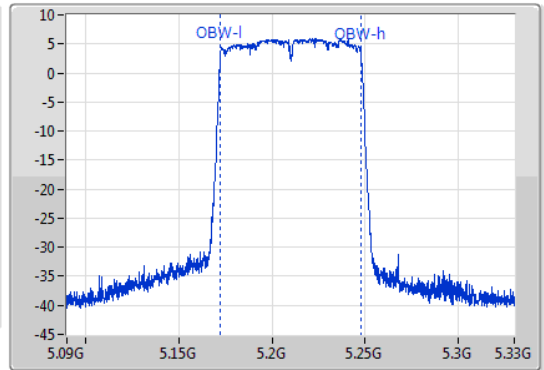

26dB(Hz)	Fl-26dB(Hz)	Fh-26dB(Hz)	OBW(Hz)	Fl-OBW(Hz)	Fh-OBW(Hz)	Limit(Hz)	Port
82.32M	5.16896G	5.25128G	75.802M	5.172219G	5.248021G	Inf	1

802.11ac VHT80_Nss1,(MCS0)_1TX

EBW

5775MHz

04/02/2020

CF
5.775GHz
Span
240MHz
RBW
100kHz
VBW
300kHz
Sweep Time
100ms
Detector Type
Peak
Port 1

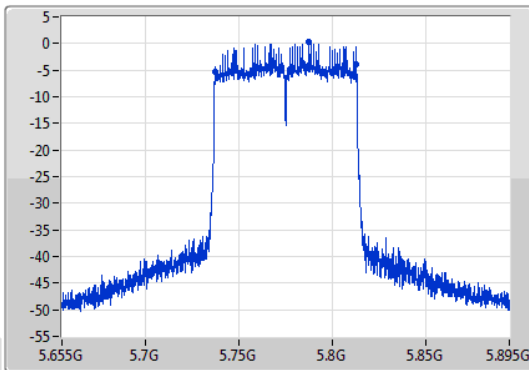

CF
5.775GHz
Span
240MHz
RBW
1MHz
VBW
3MHz
Sweep Time
100ms
Detector Type
Peak

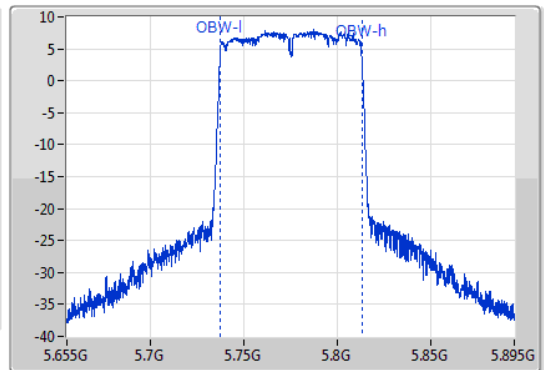

6dB(Hz)	Fl-6dB(Hz)	Fh-6dB(Hz)	OBW(Hz)	Fl-OBW(Hz)	Fh-OBW(Hz)	Limit(Hz)	Port
75.24M	5.73744G	5.81268G	75.922M	5.737219G	5.813141G	500k	1



802.11ax HEW20_Nss1,(MCS0)_1TX

EBW

5180MHz

03/02/2020

CF
5.18GHz
Span
60MHz
RBW
200kHz
VBW
1MHz
Sweep Time
100ms
Detector Type
Peak
Port 1

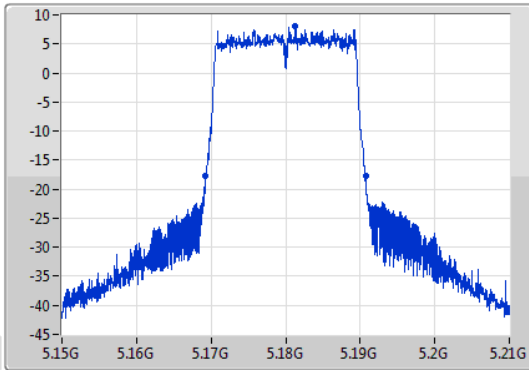

CF
5.18GHz
Span
60MHz
RBW
200kHz
VBW
1MHz
Sweep Time
100ms
Detector Type
Peak

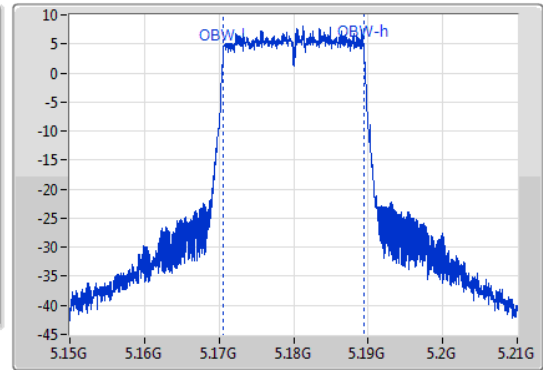

26dB(Hz)	Fl-26dB(Hz)	Fh-26dB(Hz)	OBW(Hz)	Fl-OBW(Hz)	Fh-OBW(Hz)	Limit(Hz)	Port
21.48M	5.16929G	5.19077G	19.01M	5.170495G	5.189505G	Inf	1

802.11ax HEW20_Nss1,(MCS0)_1TX

EBW

5200MHz

03/02/2020

CF
5.2GHz
Span
60MHz
RBW
200kHz
VBW
1MHz
Sweep Time
100ms
Detector Type
Peak
Port 1

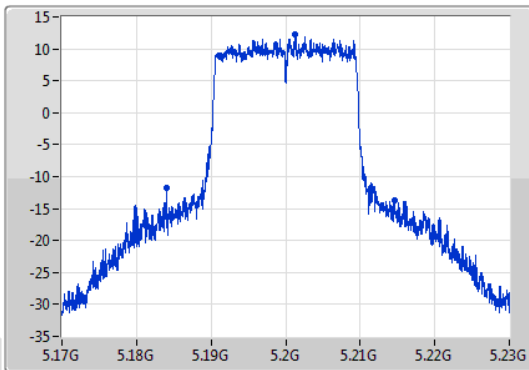

CF
5.2GHz
Span
60MHz
RBW
200kHz
VBW
1MHz
Sweep Time
100ms
Detector Type
Peak

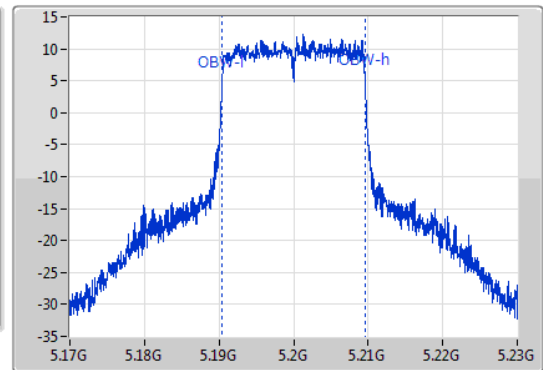

26dB(Hz)	Fl-26dB(Hz)	Fh-26dB(Hz)	OBW(Hz)	Fl-OBW(Hz)	Fh-OBW(Hz)	Limit(Hz)	Port
30.57M	5.18398G	5.21455G	19.19M	5.190405G	5.209595G	Inf	1

802.11ax HEW20_Nss1,(MCS0)_1TX

EBW

5240MHz

03/02/2020

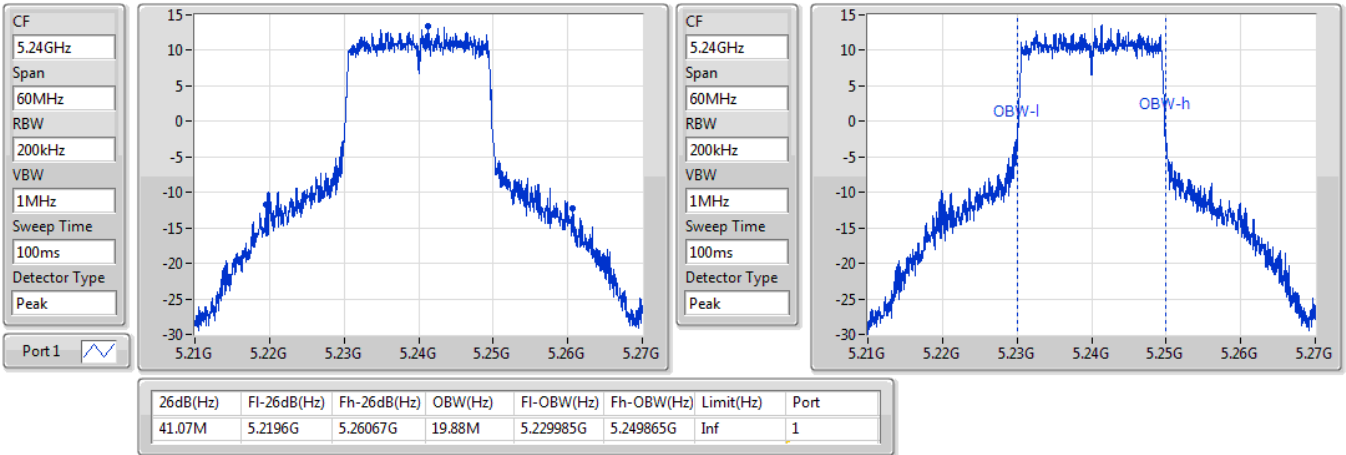

802.11ax HEW20_Nss1,(MCS0)_1TX

EBW

5745MHz

04/02/2020

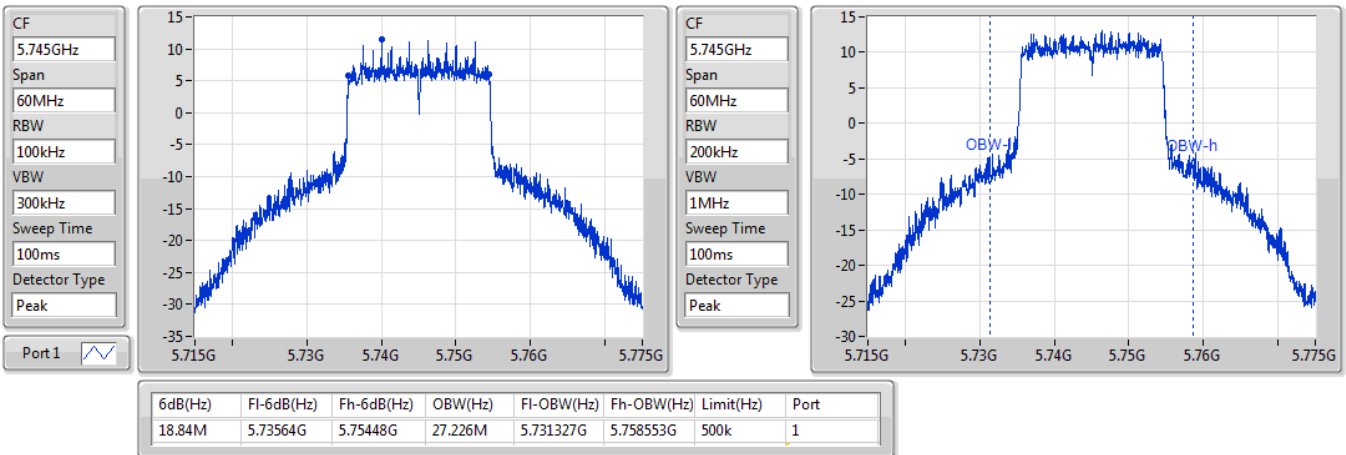

802.11ax HEW20_Nss1,(MCS0)_1TX

EBW

5785MHz

04/02/2020

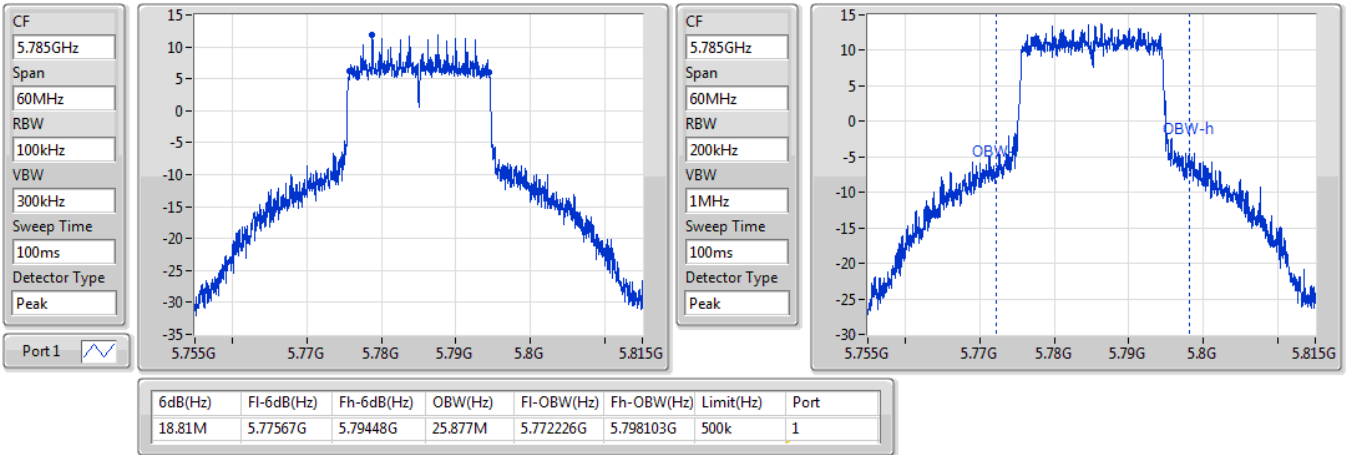

802.11ax HEW20_Nss1,(MCS0)_1TX

EBW

5825MHz

04/02/2020

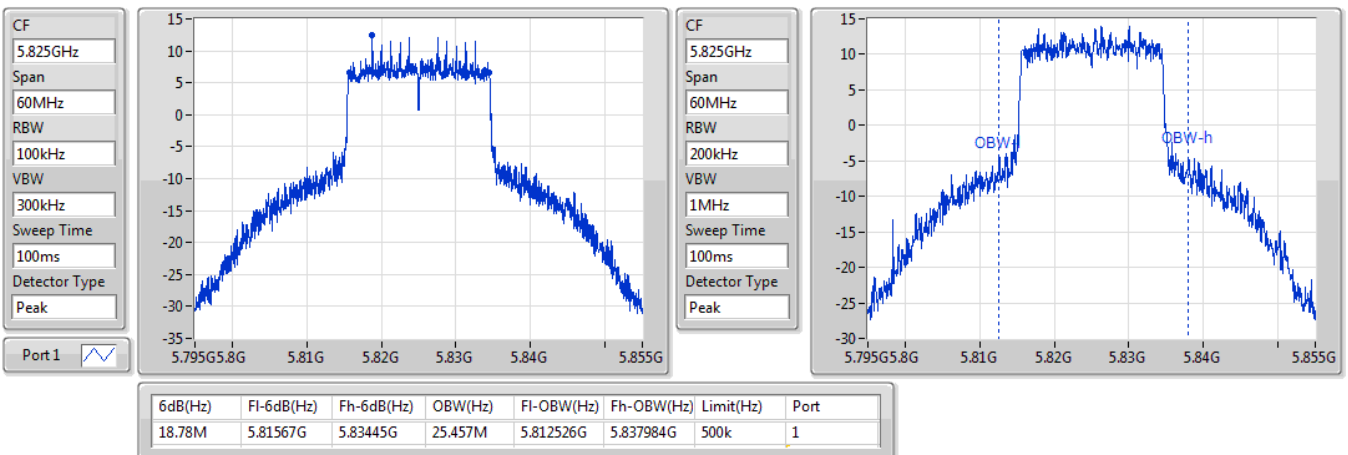

802.11ax HEW40_Nss1,(MCS0)_1TX

EBW

5190MHz

04/02/2020

CF: 5.19GHz
 Span: 120MHz
 RBW: 500kHz
 VBW: 2MHz
 Sweep Time: 100ms
 Detector Type: Peak
 Port 1

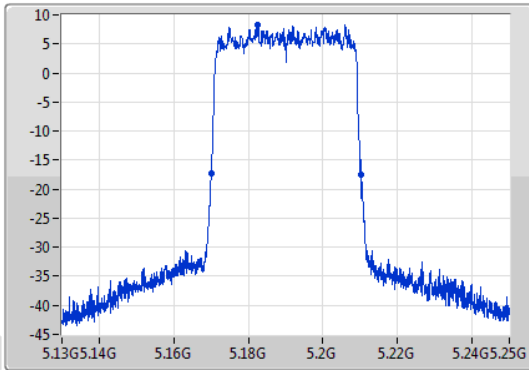

CF: 5.19GHz
 Span: 120MHz
 RBW: 500kHz
 VBW: 2MHz
 Sweep Time: 100ms
 Detector Type: Peak

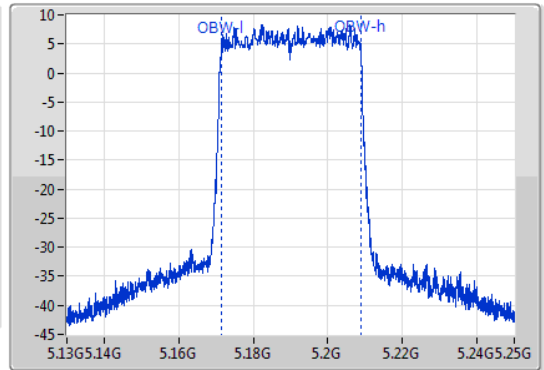

26dB(Hz)	Fl-26dB(Hz)	Fh-26dB(Hz)	OBW(Hz)	Fl-OBW(Hz)	Fh-OBW(Hz)	Limit(Hz)	Port
40.2M	5.17002G	5.21022G	37.481M	5.171349G	5.208831G	Inf	1

802.11ax HEW40_Nss1,(MCS0)_1TX

EBW

5230MHz

04/02/2020

CF: 5.23GHz
 Span: 120MHz
 RBW: 500kHz
 VBW: 2MHz
 Sweep Time: 100ms
 Detector Type: Peak
 Port 1

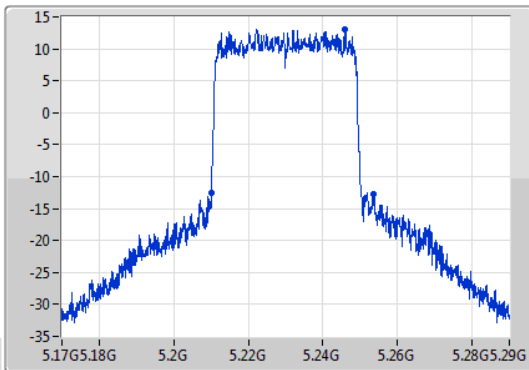

CF: 5.23GHz
 Span: 120MHz
 RBW: 500kHz
 VBW: 2MHz
 Sweep Time: 100ms
 Detector Type: Peak

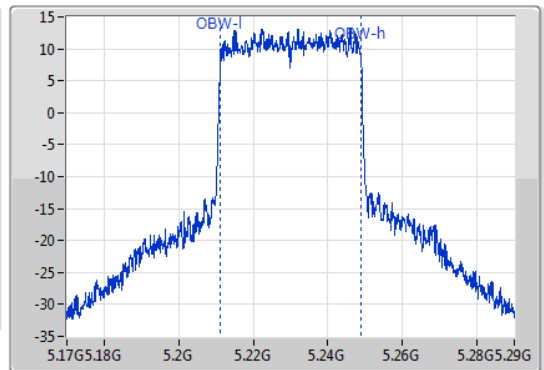

26dB(Hz)	Fl-26dB(Hz)	Fh-26dB(Hz)	OBW(Hz)	Fl-OBW(Hz)	Fh-OBW(Hz)	Limit(Hz)	Port
43.68M	5.21002G	5.2537G	37.661M	5.211229G	5.248891G	Inf	1

802.11ax HEW40_Nss1,(MCS0)_1TX

EBW

5755MHz

04/02/2020

CF
5.755GHz
Span
120MHz
RBW
100kHz
VBW
300kHz
Sweep Time
100ms
Detector Type
Peak
Port 1

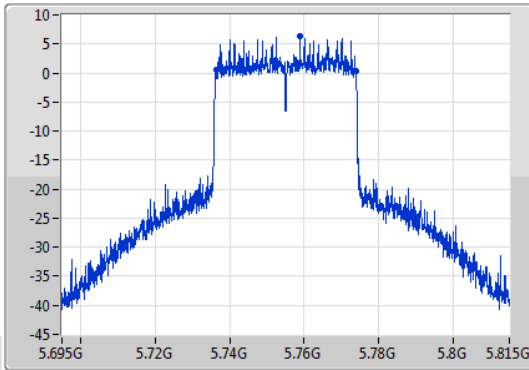

CF
5.755GHz
Span
120MHz
RBW
500kHz
VBW
2MHz
Sweep Time
100ms
Detector Type
Peak

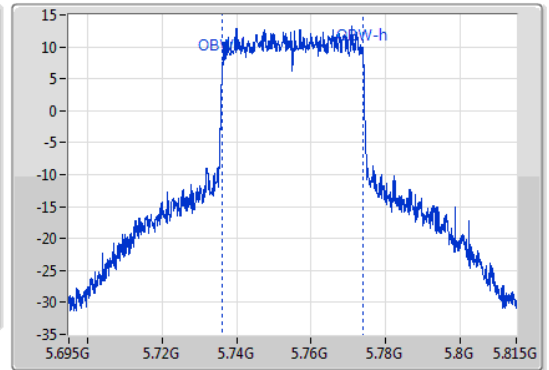

6dB(Hz)	Fl-6dB(Hz)	Fh-6dB(Hz)	OBW(Hz)	Fl-OBW(Hz)	Fh-OBW(Hz)	Limit(Hz)	Port
37.5M	5.73634G	5.77384G	37.901M	5.736109G	5.77401G	500k	1

802.11ax HEW40_Nss1,(MCS0)_1TX

EBW

5795MHz

04/02/2020

CF
5.795GHz
Span
120MHz
RBW
100kHz
VBW
300kHz
Sweep Time
100ms
Detector Type
Peak
Port 1

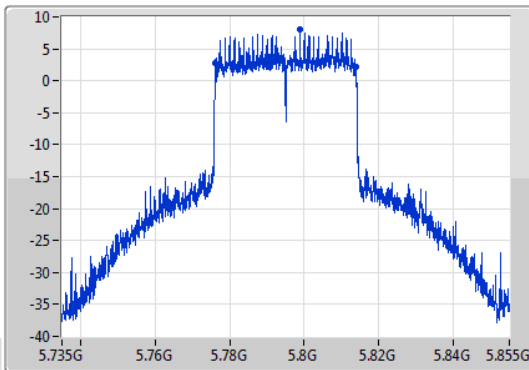

CF
5.795GHz
Span
120MHz
RBW
500kHz
VBW
2MHz
Sweep Time
100ms
Detector Type
Peak

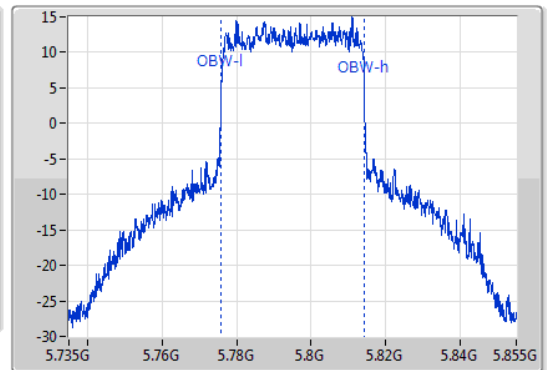

6dB(Hz)	Fl-6dB(Hz)	Fh-6dB(Hz)	OBW(Hz)	Fl-OBW(Hz)	Fh-OBW(Hz)	Limit(Hz)	Port
37.62M	5.77622G	5.81384G	38.321M	5.77593G	5.81425G	500k	1

802.11ax HEW80_Nss1,(MCS0)_1TX

EBW

5210MHz

04/02/2020

CF
5.21GHz
Span
240MHz
RBW
1MHz
VBW
3MHz
Sweep Time
100ms
Detector Type
Peak
Port 1

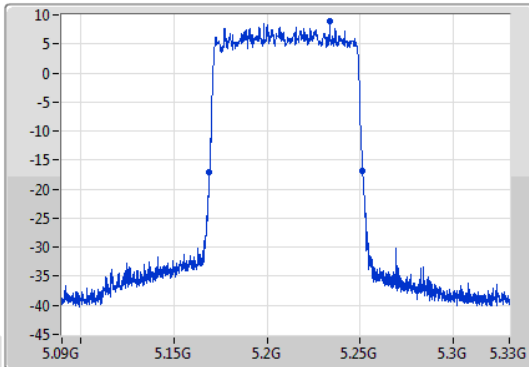

CF
5.21GHz
Span
240MHz
RBW
1MHz
VBW
3MHz
Sweep Time
100ms
Detector Type
Peak

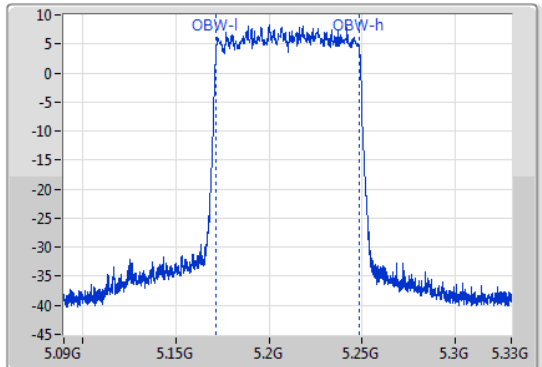

26dB(Hz)	Fl-26dB(Hz)	Fh-26dB(Hz)	OBW(Hz)	Fl-OBW(Hz)	Fh-OBW(Hz)	Limit(Hz)	Port
82.08M	5.1692G	5.25128G	77.001M	5.171619G	5.248621G	Inf	1

802.11ax HEW80_Nss1,(MCS0)_1TX

EBW

5775MHz

04/02/2020

CF
5.775GHz
Span
240MHz
RBW
100kHz
VBW
300kHz
Sweep Time
100ms
Detector Type
Peak
Port 1

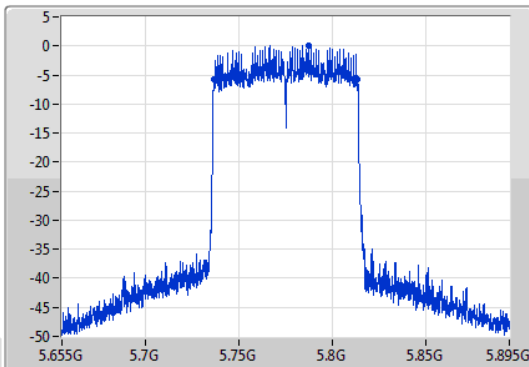

CF
5.775GHz
Span
240MHz
RBW
1MHz
VBW
3MHz
Sweep Time
100ms
Detector Type
Peak

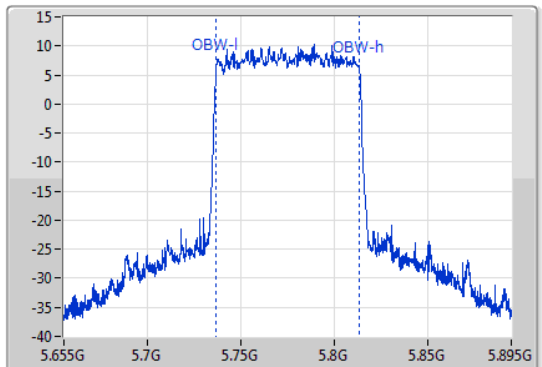

6dB(Hz)	Fl-6dB(Hz)	Fh-6dB(Hz)	OBW(Hz)	Fl-OBW(Hz)	Fh-OBW(Hz)	Limit(Hz)	Port
76.8M	5.7366G	5.8134G	77.121M	5.736619G	5.813741G	500k	1



Summary

Mode	Max-N dB (Hz)	Max-OBW (Hz)	ITU-Code	Min-N dB (Hz)	Min-OBW (Hz)
5.15-5.25GHz	-	-	-	-	-
802.11a_Nss1,(6Mbps)_2TX	29.43M	17.031M	17M0D1D	21.33M	16.672M
802.11ac VHT20_Nss2,(MCS0)_2TX	39.12M	19.46M	19M5D1D	21.36M	17.781M
802.11ac VHT40_Nss2,(MCS0)_2TX	40.08M	36.462M	36M5D1D	39.72M	36.282M
802.11ac VHT80_Nss2,(MCS0)_2TX	81.6M	75.802M	75M8D1D	81.6M	75.802M
802.11ax HEW20_Nss2,(MCS0)_2TX	40.65M	19.58M	19M6D1D	21.15M	19.01M
802.11ax HEW40_Nss2,(MCS0)_2TX	40.14M	37.721M	37M7D1D	40.02M	37.481M
802.11ax HEW80_Nss2,(MCS0)_2TX	81.36M	77.121M	77M1D1D	81.24M	77.001M
5.725-5.85GHz	-	-	-	-	-
802.11a_Nss1,(6Mbps)_2TX	16.53M	17.151M	17M2D1D	16.32M	16.642M
802.11ac VHT20_Nss2,(MCS0)_2TX	17.58M	18.561M	18M6D1D	17.58M	17.811M
802.11ac VHT40_Nss2,(MCS0)_2TX	36.36M	36.882M	36M9D1D	36.3M	36.402M
802.11ac VHT80_Nss2,(MCS0)_2TX	75.6M	75.922M	75M9D1D	75.6M	75.922M
802.11ax HEW20_Nss2,(MCS0)_2TX	18.96M	19.37M	19M4D1D	18.75M	19.04M
802.11ax HEW40_Nss2,(MCS0)_2TX	37.5M	37.901M	37M9D1D	37.02M	37.721M
802.11ax HEW80_Nss2,(MCS0)_2TX	75.72M	77.121M	77M1D1D	75.36M	77.001M

Max-N dB = Maximum 6dB down bandwidth for 5.725-5.85GHz band / Maximum 26dB down bandwidth for other band;

Max-OBW = Maximum 99% occupied bandwidth;

Min-N dB = Minimum 6dB down bandwidth for 5.725-5.85GHz band / Maximum 26dB down bandwidth for other band;

Min-OBW = Minimum 99% occupied bandwidth;



Result

Mode	Result	Limit (Hz)	Port 1-N dB (Hz)	Port 1-OBW (Hz)	Port 2-N dB (Hz)	Port 2-OBW (Hz)
802.11a_Nss1,(6Mbps)_2TX	-	-	-	-	-	-
5180MHz	Pass	Inf	21.36M	16.732M	21.33M	16.672M
5200MHz	Pass	Inf	27.06M	17.031M	29.43M	17.001M
5240MHz	Pass	Inf	26.94M	17.001M	29.34M	17.001M
5745MHz	Pass	500k	16.53M	17.091M	16.32M	17.151M
5785MHz	Pass	500k	16.32M	16.792M	16.32M	16.672M
5825MHz	Pass	500k	16.32M	16.762M	16.32M	16.642M
802.11ac VHT20_Nss2,(MCS0)_2TX	-	-	-	-	-	-
5180MHz	Pass	Inf	21.6M	17.871M	21.36M	17.781M
5200MHz	Pass	Inf	23.94M	17.991M	22.71M	17.901M
5240MHz	Pass	Inf	36.15M	18.861M	39.12M	19.46M
5745MHz	Pass	500k	17.58M	18.561M	17.58M	18.501M
5785MHz	Pass	500k	17.58M	17.961M	17.58M	17.901M
5825MHz	Pass	500k	17.58M	17.871M	17.58M	17.811M
802.11ac VHT40_Nss2,(MCS0)_2TX	-	-	-	-	-	-
5190MHz	Pass	Inf	40.08M	36.402M	39.9M	36.282M
5230MHz	Pass	Inf	40.02M	36.462M	39.72M	36.342M
5755MHz	Pass	500k	36.36M	36.582M	36.3M	36.402M
5795MHz	Pass	500k	36.36M	36.882M	36.3M	36.522M
802.11ac VHT80_Nss2,(MCS0)_2TX	-	-	-	-	-	-
5210MHz	Pass	Inf	81.6M	75.802M	81.6M	75.802M
5775MHz	Pass	500k	75.6M	75.922M	75.6M	75.922M
802.11ax HEW20_Nss2,(MCS0)_2TX	-	-	-	-	-	-
5180MHz	Pass	Inf	21.51M	19.04M	21.15M	19.01M
5200MHz	Pass	Inf	22.74M	19.07M	23.49M	19.1M
5240MHz	Pass	Inf	36.9M	19.37M	40.65M	19.58M
5745MHz	Pass	500k	18.9M	19.25M	18.75M	19.37M
5785MHz	Pass	500k	18.93M	19.04M	18.81M	19.1M
5825MHz	Pass	500k	18.96M	19.04M	18.81M	19.04M
802.11ax HEW40_Nss2,(MCS0)_2TX	-	-	-	-	-	-
5190MHz	Pass	Inf	40.08M	37.661M	40.02M	37.481M
5230MHz	Pass	Inf	40.08M	37.721M	40.14M	37.601M
5755MHz	Pass	500k	37.5M	37.781M	37.02M	37.721M
5795MHz	Pass	500k	37.5M	37.901M	37.02M	37.781M
802.11ax HEW80_Nss2,(MCS0)_2TX	-	-	-	-	-	-
5210MHz	Pass	Inf	81.36M	77.001M	81.24M	77.121M
5775MHz	Pass	500k	75.72M	77.121M	75.36M	77.001M

Port X-N dB = Port X 6dB down bandwidth for 5.725-5.85GHz band / 26dB down bandwidth for other band

Port X-OBW = Port X 99% occupied bandwidth;

802.11a_Nss1,(6Mbps)_2TX

EBW

5180MHz

05/02/2020

CF: 5.18GHz
Span: 60MHz
RBW: 200kHz
VBW: 1MHz
Sweep Time: 100ms
Detector Type: Peak

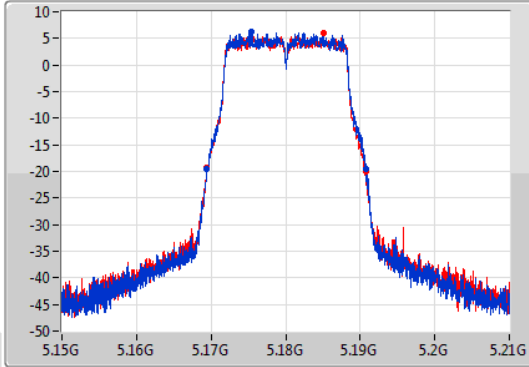

CF: 5.18GHz
Span: 60MHz
RBW: 200kHz
VBW: 1MHz
Sweep Time: 100ms
Detector Type: Peak

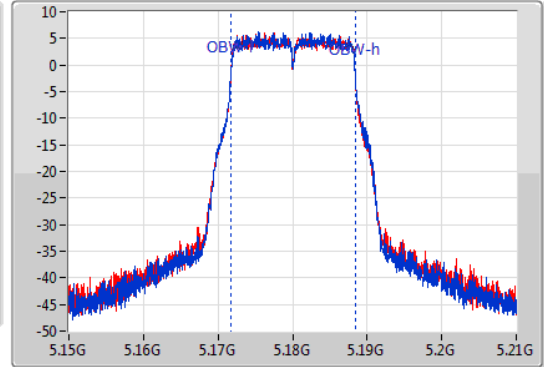

26dB(Hz)	Fl-26dB(Hz)	Fh-26dB(Hz)	OBW(Hz)	Fl-OBW(Hz)	Fh-OBW(Hz)	Limit(Hz)	Port
21.36M	5.16947G	5.19083G	16.732M	5.171724G	5.188456G	Inf	1
21.33M	5.16941G	5.19074G	16.672M	5.171724G	5.188396G	Inf	2

802.11a_Nss1,(6Mbps)_2TX

EBW

5200MHz

05/02/2020

CF: 5.2GHz
Span: 60MHz
RBW: 200kHz
VBW: 1MHz
Sweep Time: 100ms
Detector Type: Peak

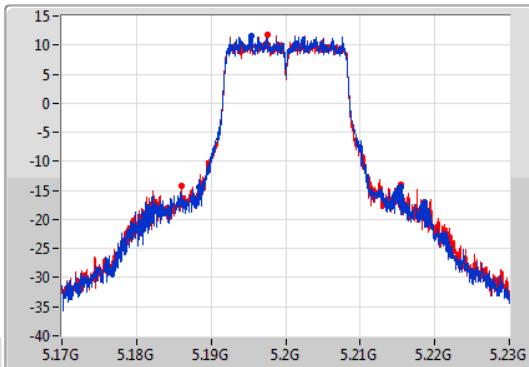

CF: 5.2GHz
Span: 60MHz
RBW: 200kHz
VBW: 1MHz
Sweep Time: 100ms
Detector Type: Peak

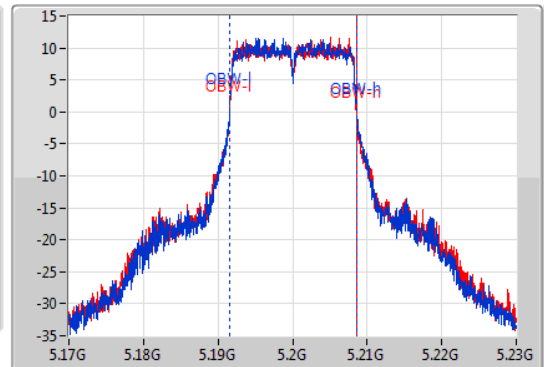

26dB(Hz)	Fl-26dB(Hz)	Fh-26dB(Hz)	OBW(Hz)	Fl-OBW(Hz)	Fh-OBW(Hz)	Limit(Hz)	Port
27.06M	5.18839G	5.21545G	17.031M	5.191604G	5.208636G	Inf	1
29.43M	5.18599G	5.21542G	17.001M	5.191574G	5.208576G	Inf	2

802.11a_Nss1,(6Mbps)_2TX

EBW

5240MHz

05/02/2020

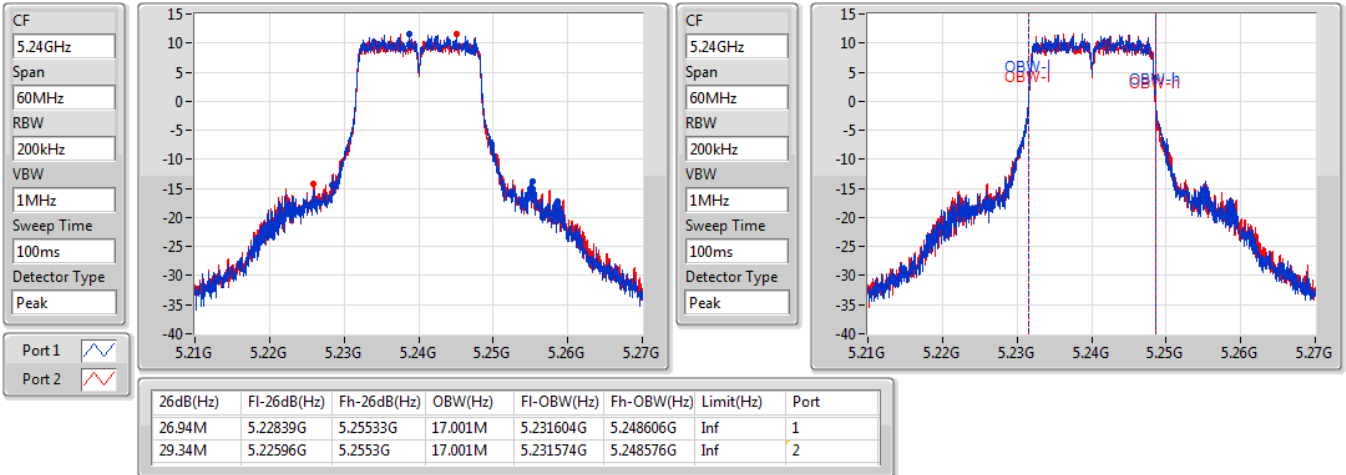

802.11a_Nss1,(6Mbps)_2TX

EBW

5745MHz

05/02/2020

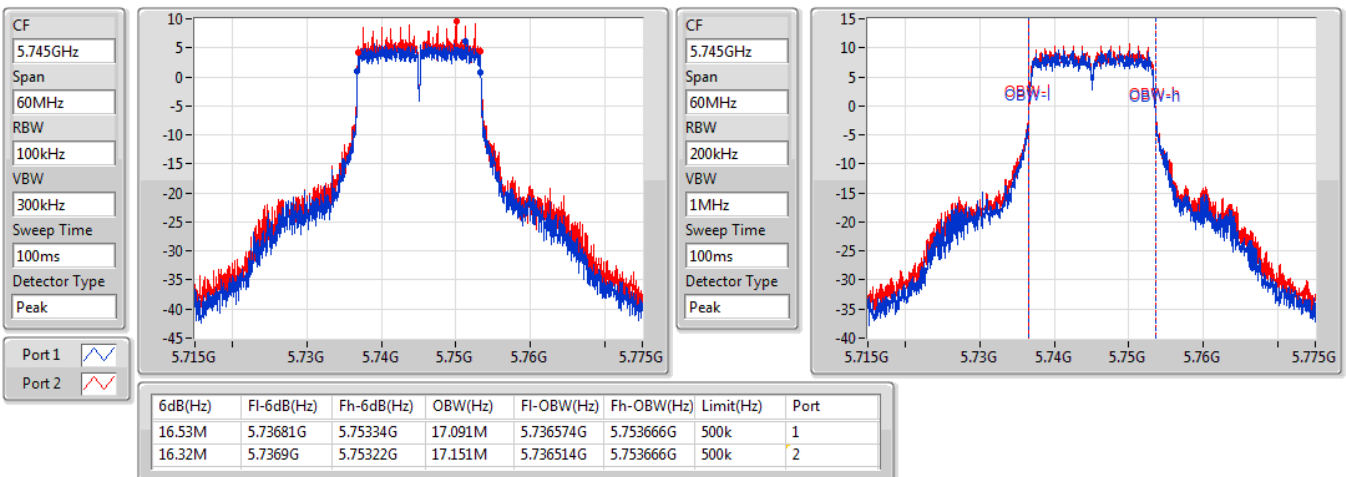

802.11a_Nss1,(6Mbps)_2TX

EBW

5785MHz

05/02/2020

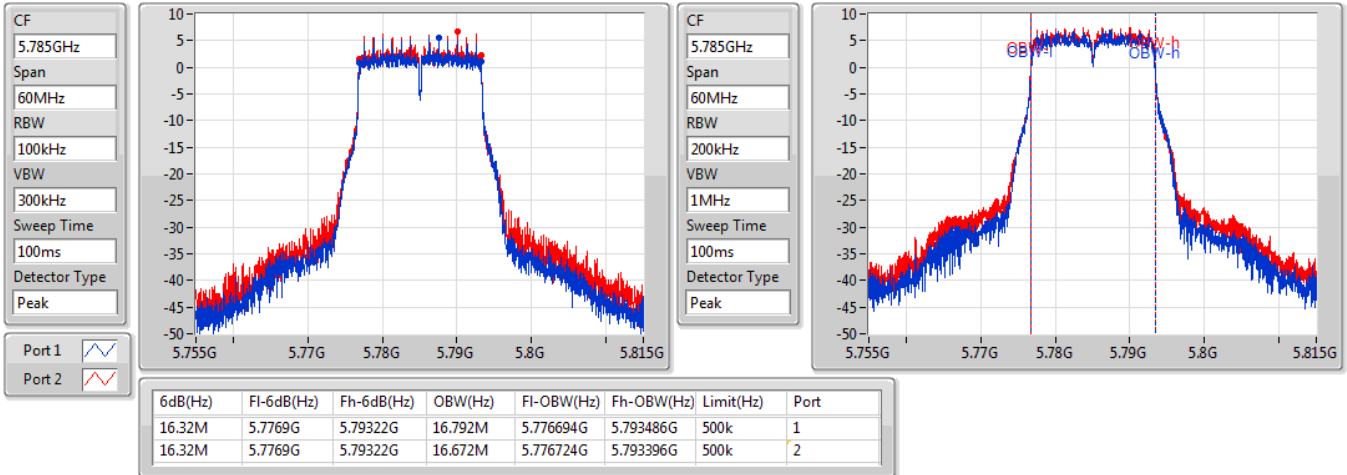

802.11a_Nss1,(6Mbps)_2TX

EBW

5825MHz

05/02/2020

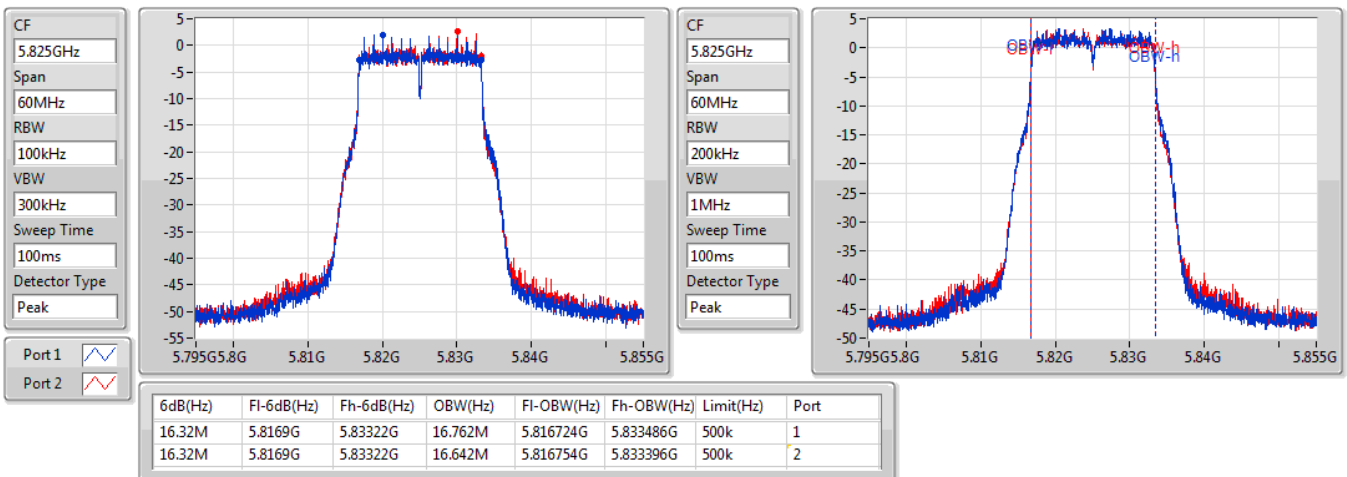

802.11ac VHT20_Nss2,(MCS0)_2TX

EBW

5180MHz

05/02/2020

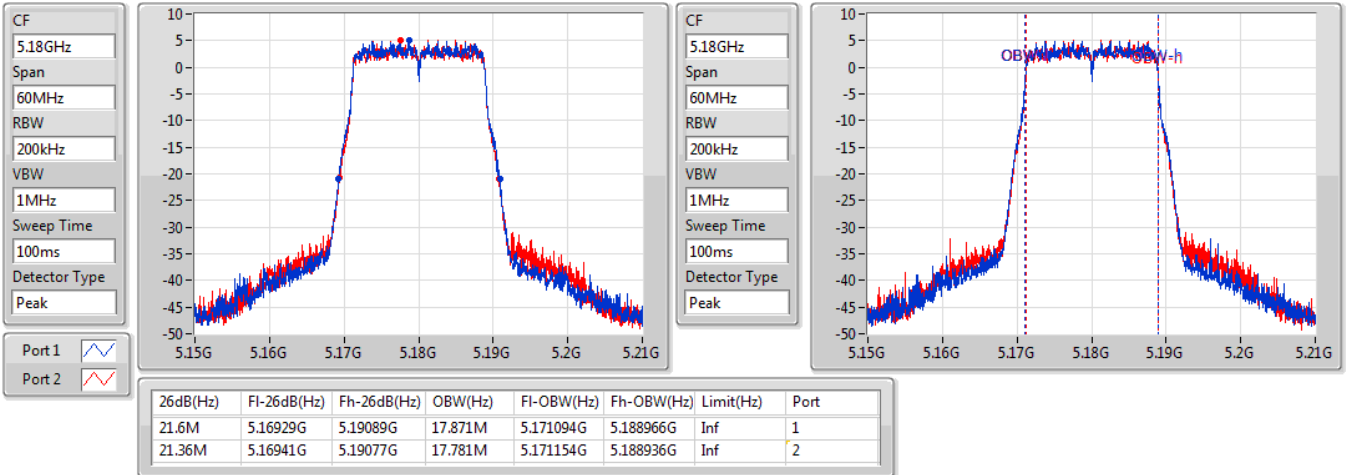

802.11ac VHT20_Nss2,(MCS0)_2TX

EBW

5200MHz

05/02/2020

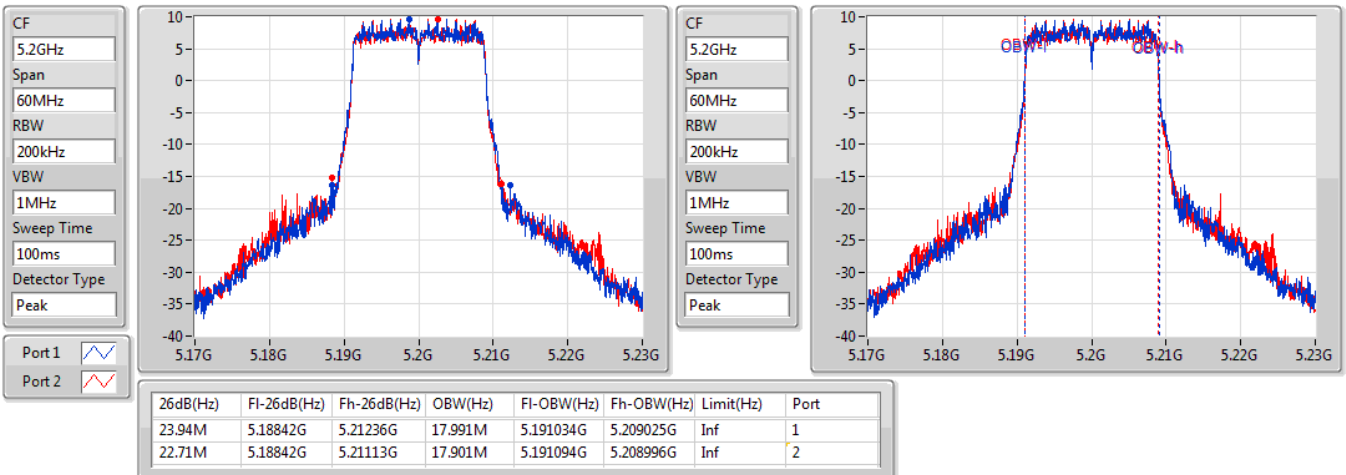

802.11ac VHT20_Nss2,(MCS0)_2TX

EBW

5240MHz

05/02/2020

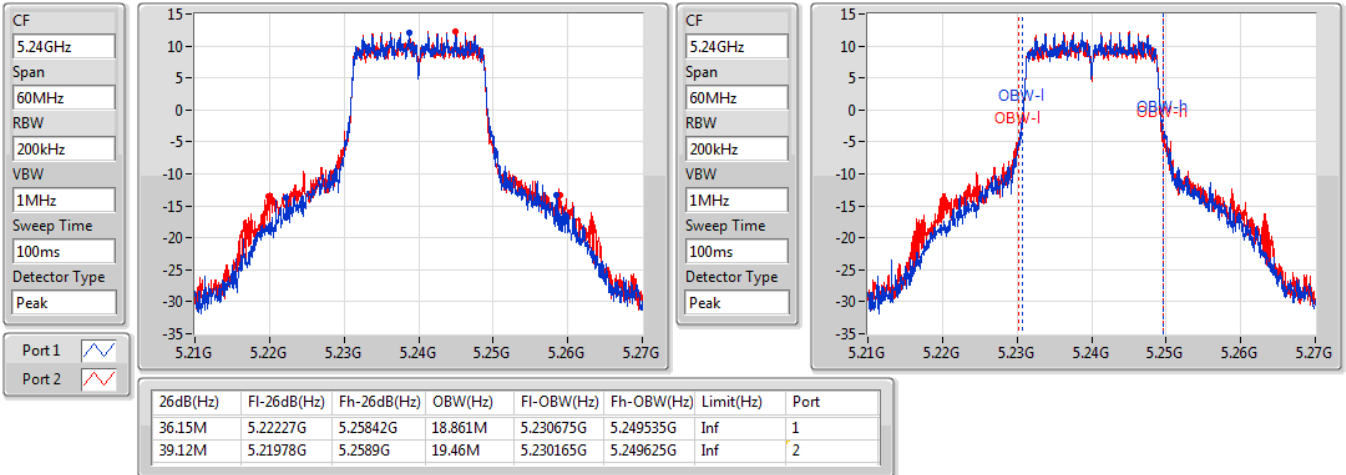

802.11ac VHT20_Nss2,(MCS0)_2TX

EBW

5745MHz

05/02/2020

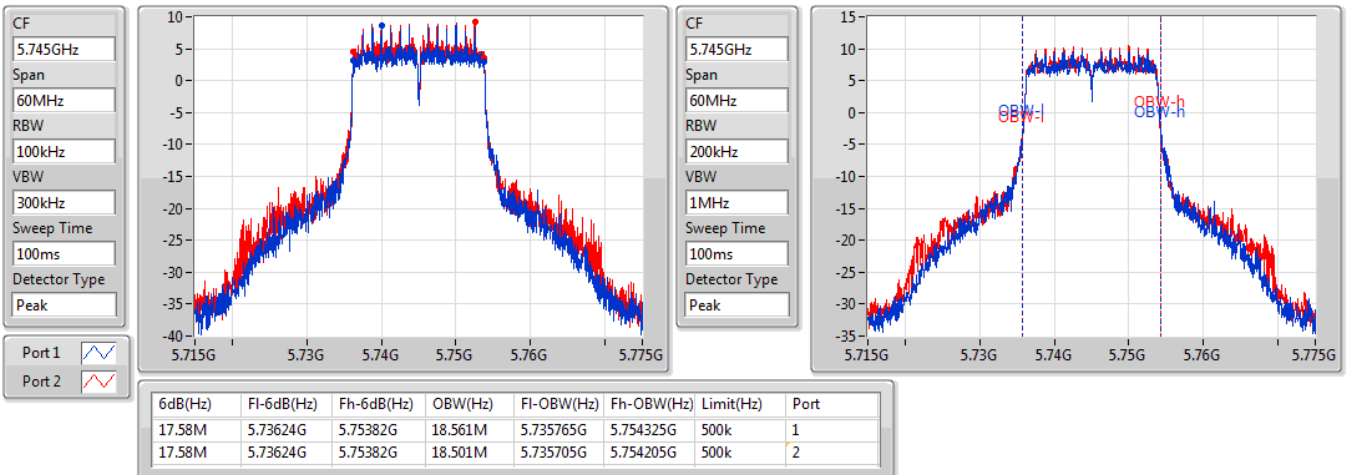

802.11ac VHT20_Nss2,(MCS0)_2TX

EBW

5785MHz

05/02/2020

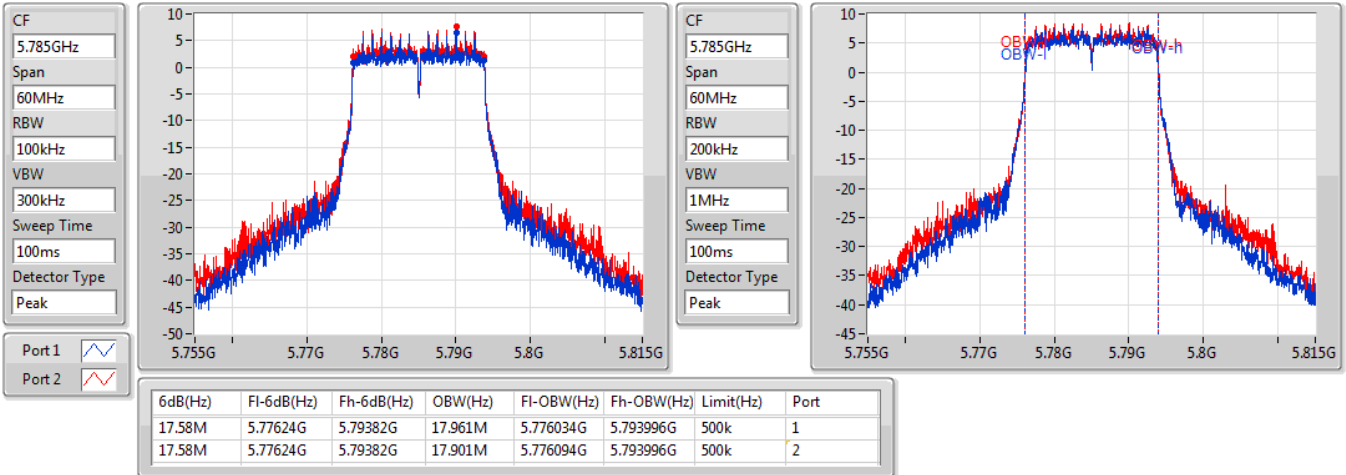

802.11ac VHT20_Nss2,(MCS0)_2TX

EBW

5825MHz

05/02/2020

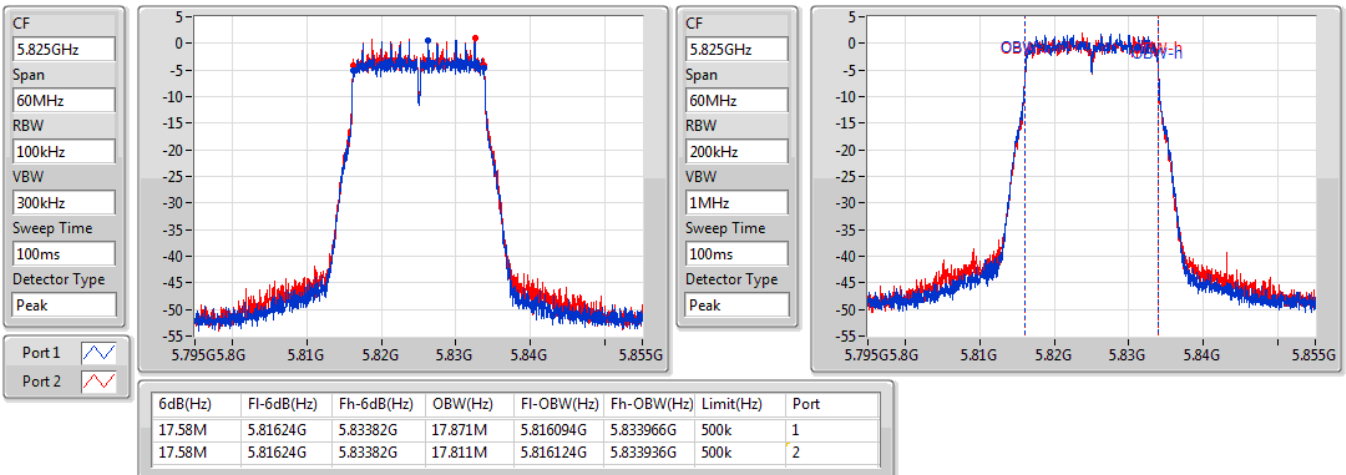

802.11ac VHT40_Nss2,(MCS0)_2TX

EBW

5190MHz

05/02/2020

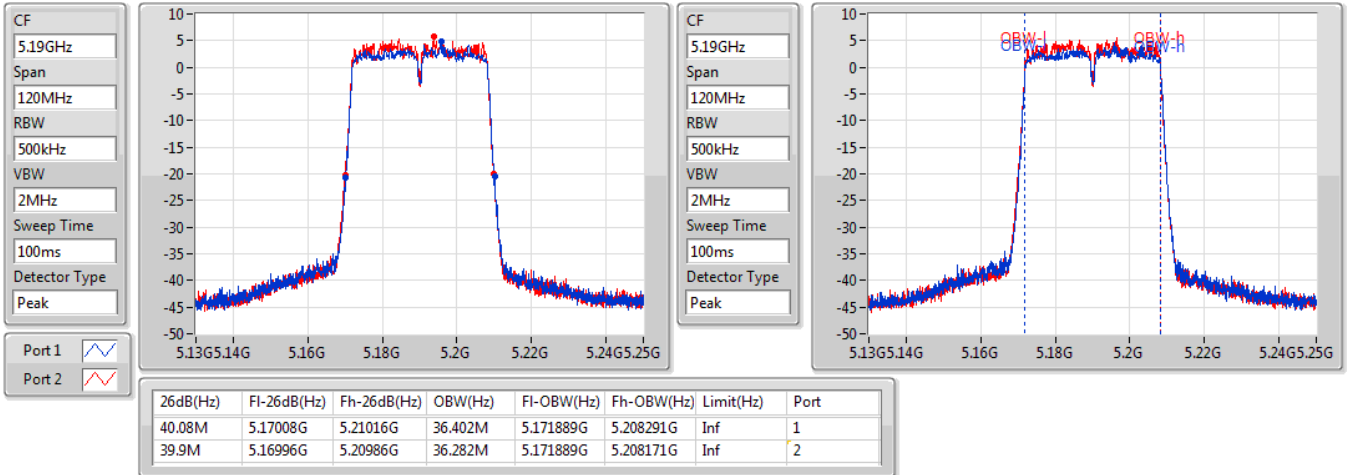

802.11ac VHT40_Nss2,(MCS0)_2TX

EBW

5230MHz

05/02/2020

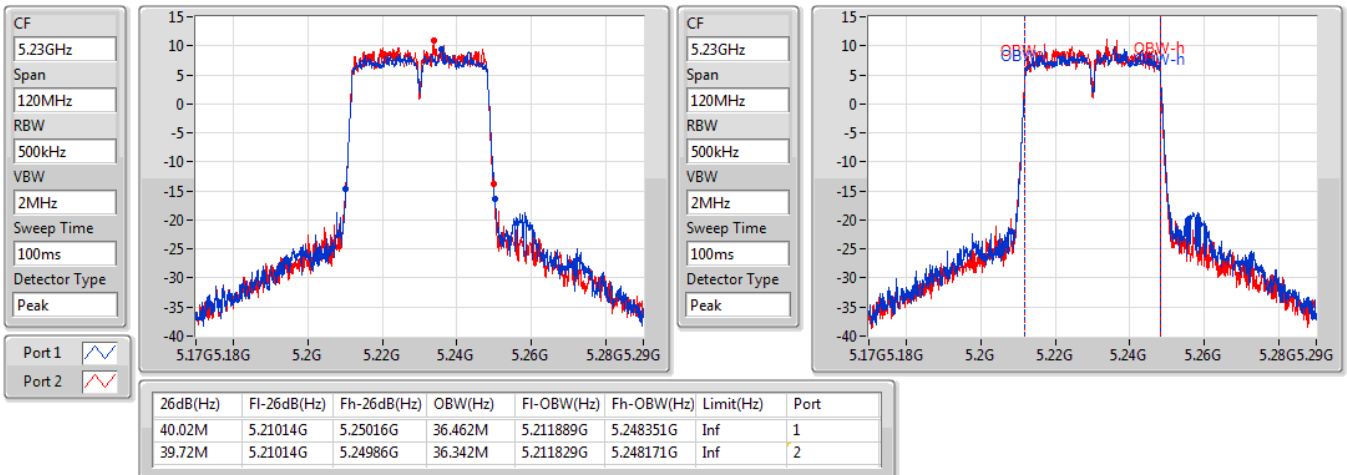

802.11ac VHT40_Nss2,(MCS0)_2TX

EBW

5755MHz

05/02/2020

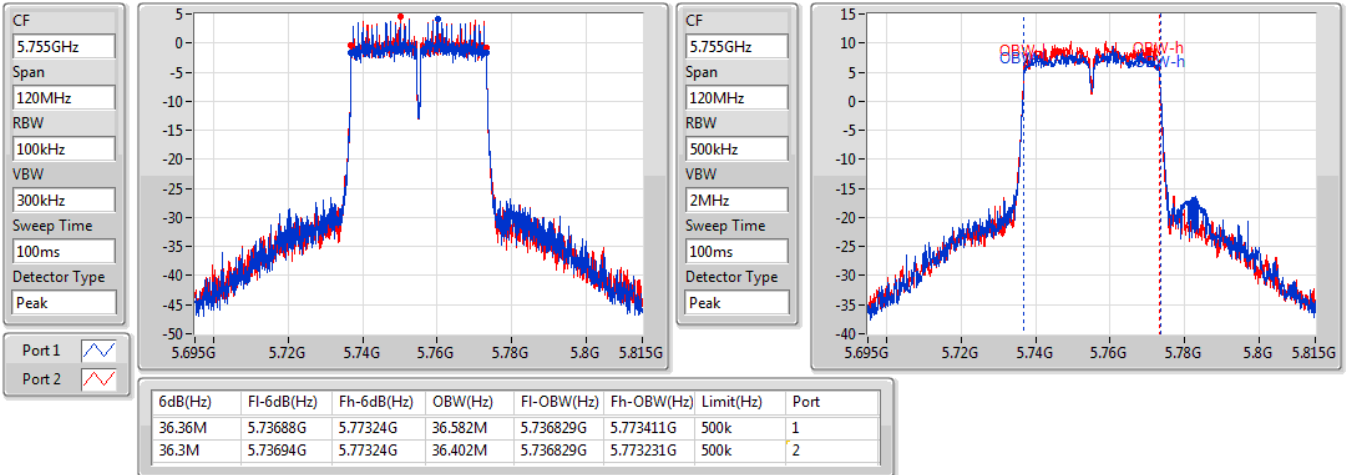

802.11ac VHT40_Nss2,(MCS0)_2TX

EBW

5795MHz

05/02/2020

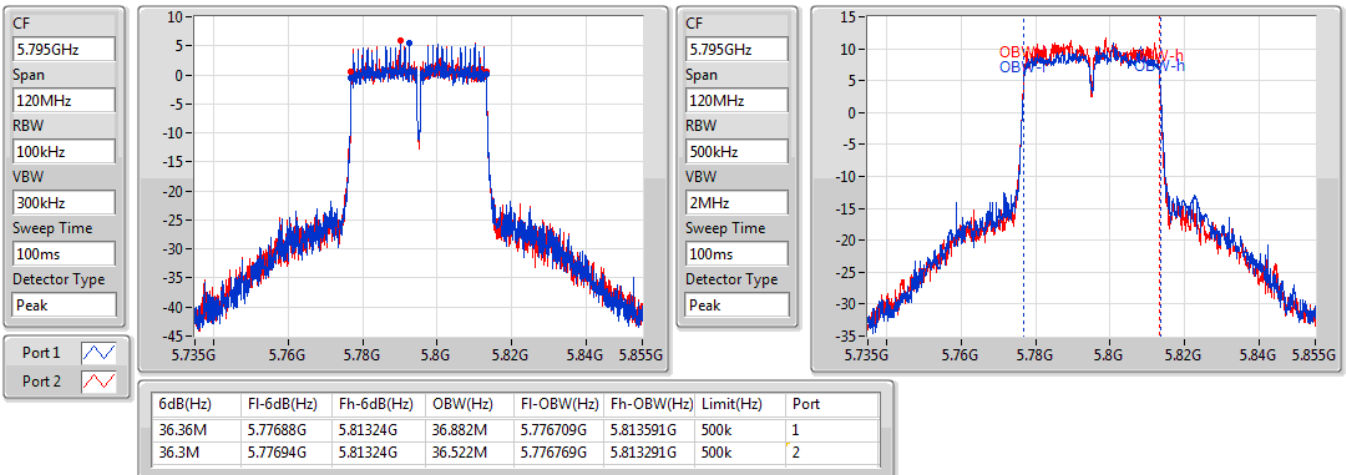

802.11ac VHT80_Nss2,(MCS0)_2TX

EBW

5210MHz

05/02/2020

CF
5.21GHz
Span
240MHz
RBW
1MHz
VBW
3MHz
Sweep Time
100ms
Detector Type
Peak

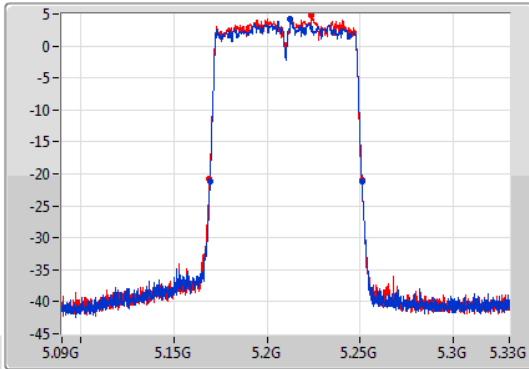

CF
5.21GHz
Span
240MHz
RBW
1MHz
VBW
3MHz
Sweep Time
100ms
Detector Type
Peak

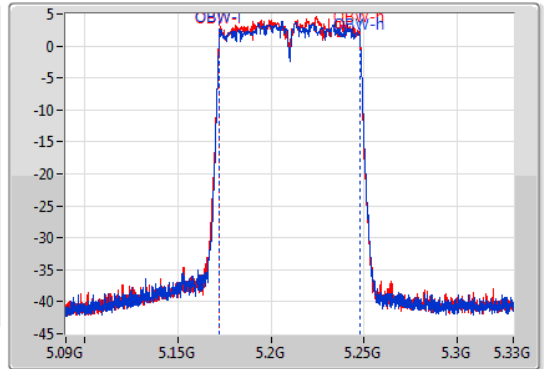

26dB(Hz)	Fl-26dB(Hz)	Fh-26dB(Hz)	OBW(Hz)	Fl-OBW(Hz)	Fh-OBW(Hz)	Limit(Hz)	Port
81.6M	5.16944G	5.25104G	75.802M	5.172219G	5.248021G	Inf	1
81.6M	5.1692G	5.2508G	75.802M	5.172099G	5.247901G	Inf	2

802.11ac VHT80_Nss2,(MCS0)_2TX

EBW

5775MHz

05/02/2020

CF
5.775GHz
Span
240MHz
RBW
100kHz
VBW
300kHz
Sweep Time
100ms
Detector Type
Peak

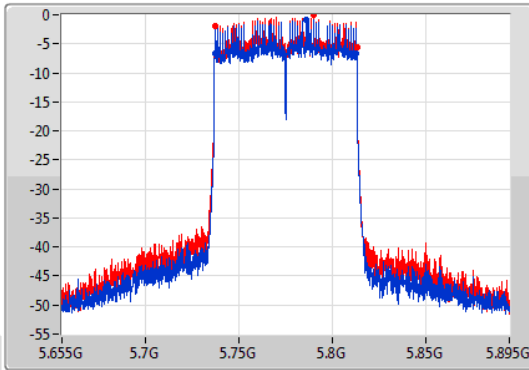

CF
5.775GHz
Span
240MHz
RBW
1MHz
VBW
3MHz
Sweep Time
100ms
Detector Type
Peak

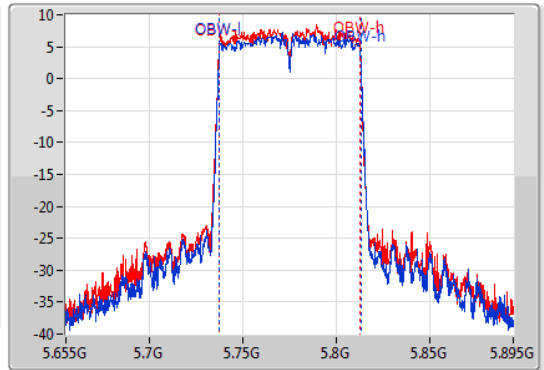

6dB(Hz)	Fl-6dB(Hz)	Fh-6dB(Hz)	OBW(Hz)	Fl-OBW(Hz)	Fh-OBW(Hz)	Limit(Hz)	Port
75.6M	5.73708G	5.81268G	75.922M	5.737219G	5.813141G	500k	1
75.6M	5.73756G	5.81316G	75.922M	5.737099G	5.813021G	500k	2

802.11ax HEW20_Nss2,(MCS0)_2TX

EBW

5180MHz

05/02/2020

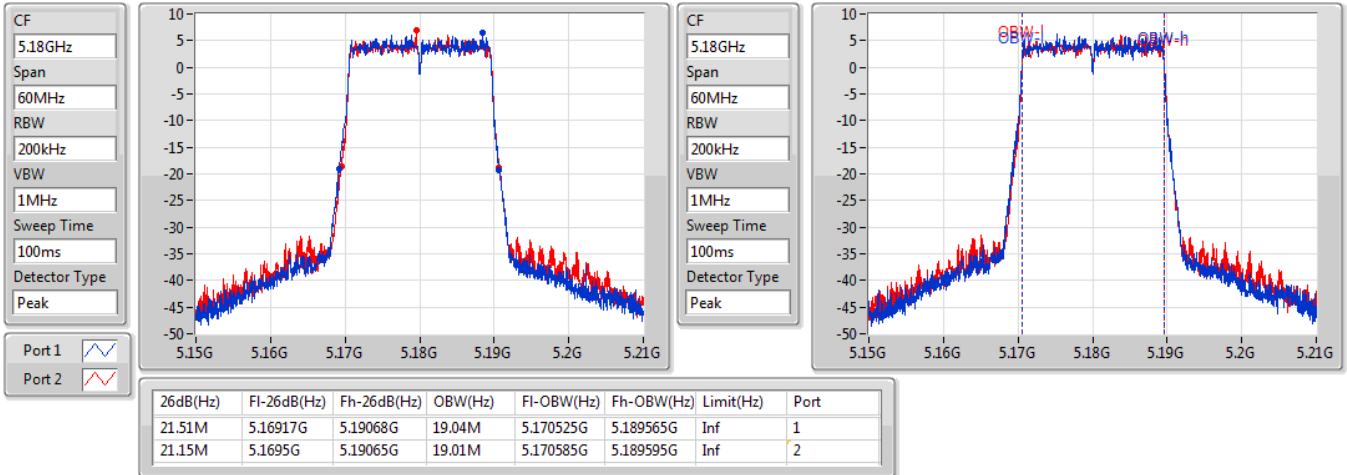

802.11ax HEW20_Nss2,(MCS0)_2TX

EBW

5200MHz

05/02/2020

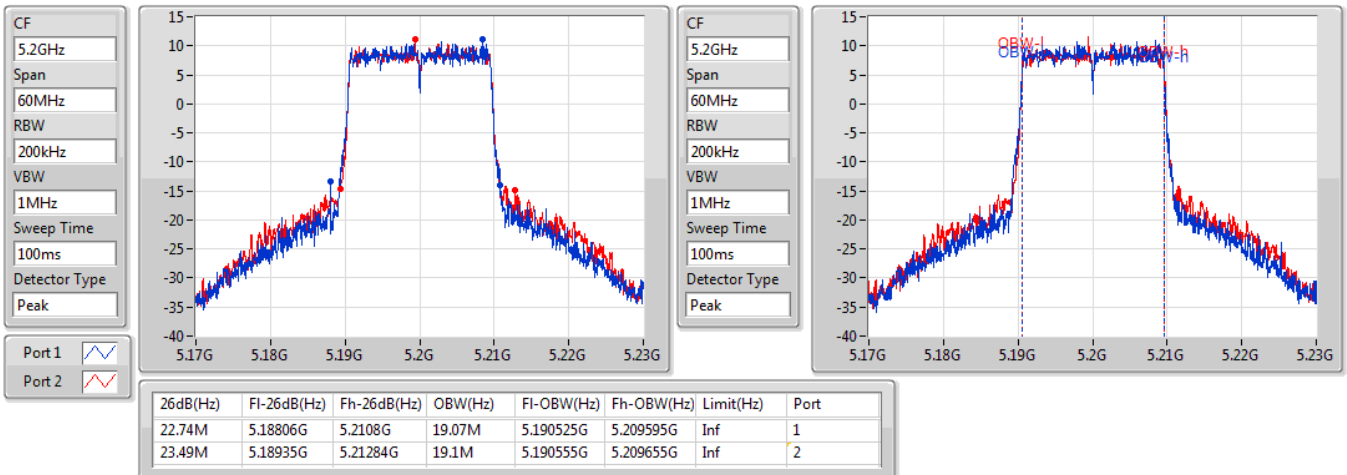

802.11ax HEW20_Nss2,(MCS0)_2TX

EBW

5240MHz

05/02/2020

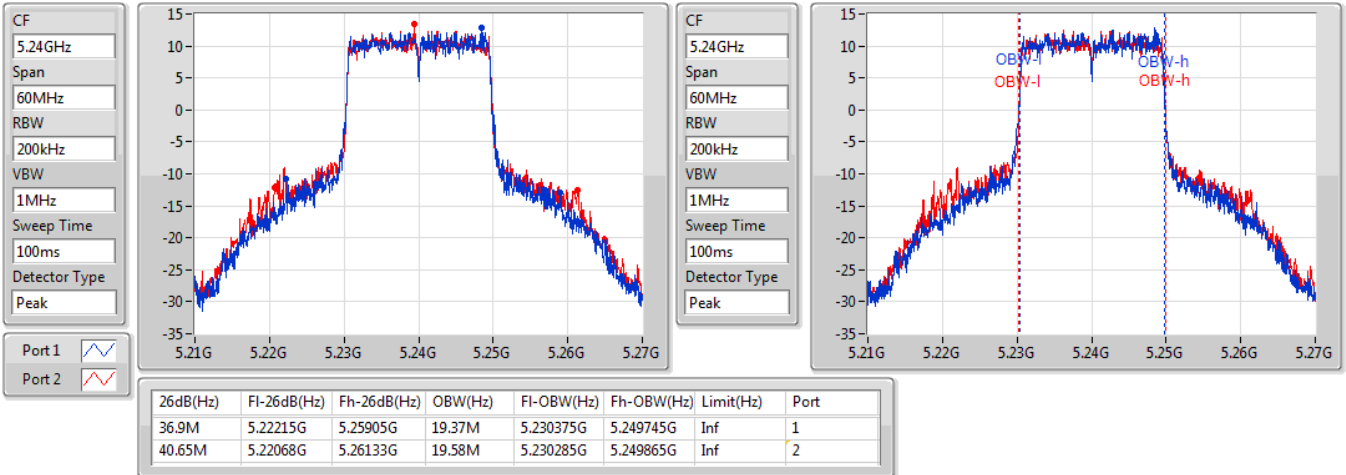

802.11ax HEW20_Nss2,(MCS0)_2TX

EBW

5745MHz

05/02/2020

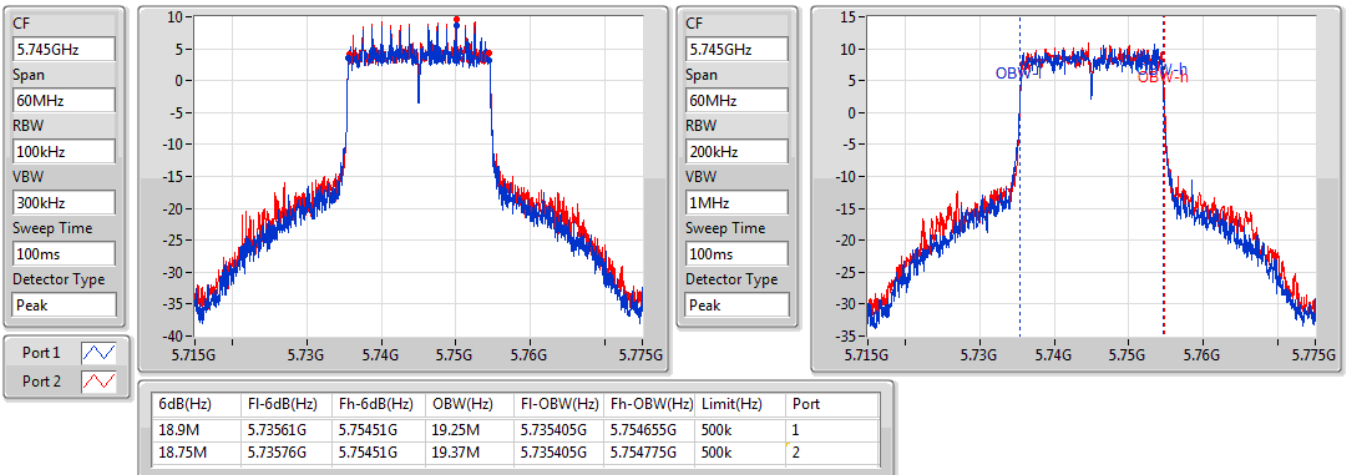

802.11ax HEW20_Nss2,(MCS0)_2TX

EBW

5785MHz

05/02/2020

CF
5.785GHz
Span
60MHz
RBW
100kHz
VBW
300kHz
Sweep Time
100ms
Detector Type
Peak

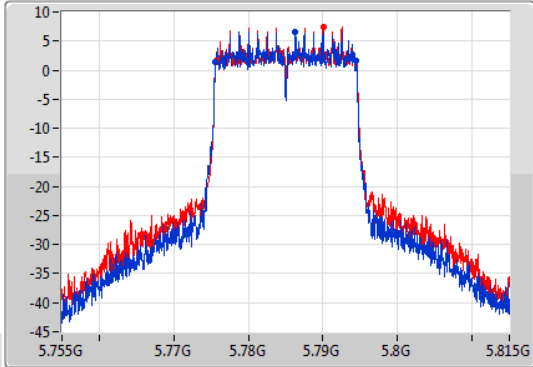

CF
5.785GHz
Span
60MHz
RBW
200kHz
VBW
1MHz
Sweep Time
100ms
Detector Type
Peak

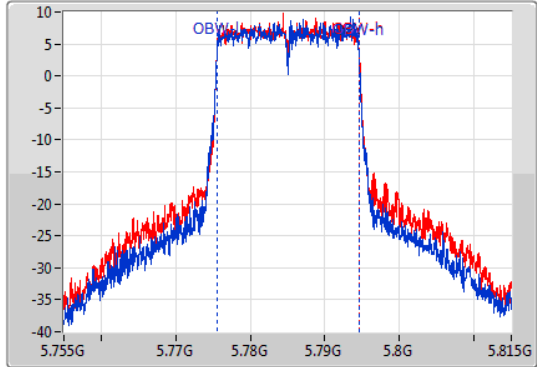

6dB(Hz)	Fl-6dB(Hz)	Fh-6dB(Hz)	OBW(Hz)	Fl-OBW(Hz)	Fh-OBW(Hz)	Limit(Hz)	Port
18.93M	5.77555G	5.79448G	19.04M	5.775525G	5.794565G	500k	1
18.81M	5.7757G	5.79451G	19.1M	5.775525G	5.794625G	500k	2

802.11ax HEW20_Nss2,(MCS0)_2TX

EBW

5825MHz

05/02/2020

CF
5.825GHz
Span
60MHz
RBW
100kHz
VBW
300kHz
Sweep Time
100ms
Detector Type
Peak

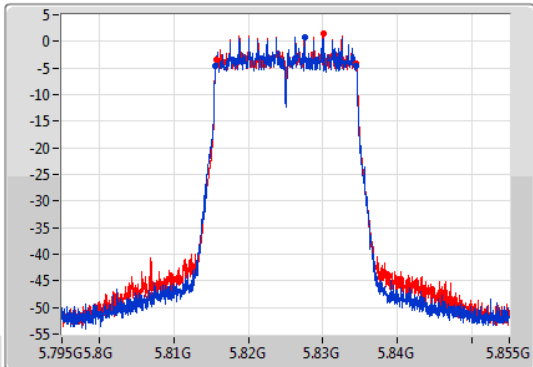

CF
5.825GHz
Span
60MHz
RBW
200kHz
VBW
1MHz
Sweep Time
100ms
Detector Type
Peak

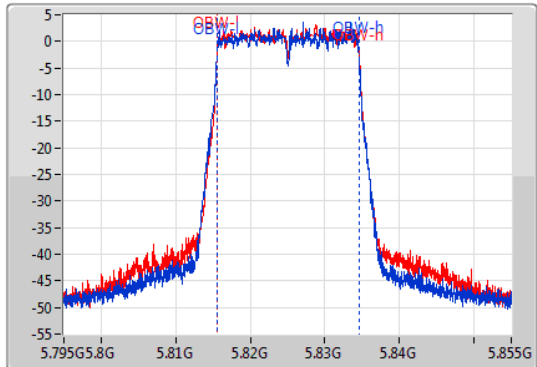

6dB(Hz)	Fl-6dB(Hz)	Fh-6dB(Hz)	OBW(Hz)	Fl-OBW(Hz)	Fh-OBW(Hz)	Limit(Hz)	Port
18.96M	5.81555G	5.83451G	19.04M	5.815525G	5.834565G	500k	1
18.81M	5.8157G	5.83451G	19.04M	5.815555G	5.834595G	500k	2

802.11ax HEW40_Nss2,(MCS0)_2TX

EBW

5190MHz

05/02/2020

CF
5.19GHz
Span
120MHz
RBW
500kHz
VBW
2MHz
Sweep Time
100ms
Detector Type
Peak

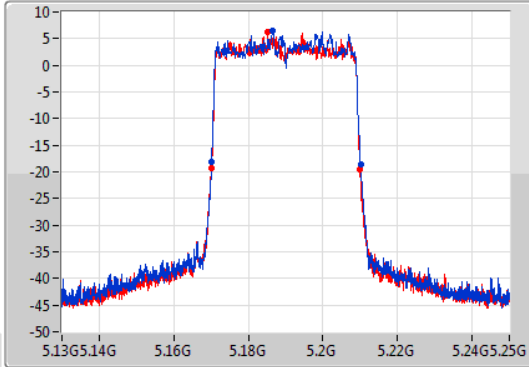

CF
5.19GHz
Span
120MHz
RBW
500kHz
VBW
2MHz
Sweep Time
100ms
Detector Type
Peak

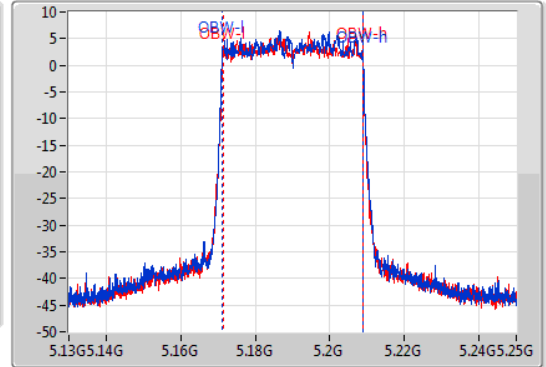

26dB(Hz)	Fl-26dB(Hz)	Fh-26dB(Hz)	OBW(Hz)	Fl-OBW(Hz)	Fh-OBW(Hz)	Limit(Hz)	Port
40.08M	5.17008G	5.21016G	37.661M	5.171169G	5.208831G	Inf	1
40.02M	5.16996G	5.20998G	37.481M	5.171289G	5.208771G	Inf	2

802.11ax HEW40_Nss2,(MCS0)_2TX

EBW

5230MHz

05/02/2020

CF
5.23GHz
Span
120MHz
RBW
500kHz
VBW
2MHz
Sweep Time
100ms
Detector Type
Peak

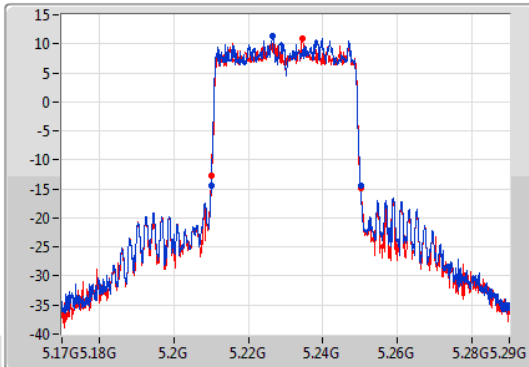

CF
5.23GHz
Span
120MHz
RBW
500kHz
VBW
2MHz
Sweep Time
100ms
Detector Type
Peak

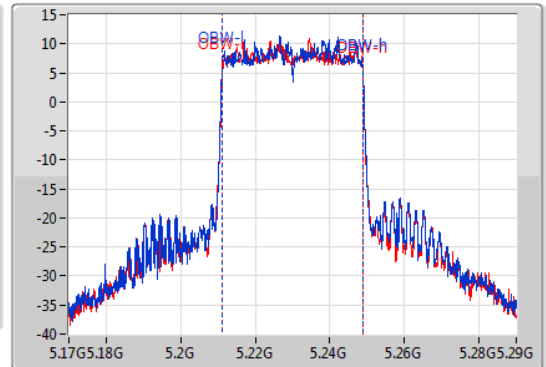

26dB(Hz)	Fl-26dB(Hz)	Fh-26dB(Hz)	OBW(Hz)	Fl-OBW(Hz)	Fh-OBW(Hz)	Limit(Hz)	Port
40.08M	5.21002G	5.2501G	37.721M	5.211109G	5.248831G	Inf	1
40.14M	5.21002G	5.25016G	37.601M	5.211229G	5.248831G	Inf	2

802.11ax HEW40_Nss2,(MCS0)_2TX

EBW

5755MHz

05/02/2020

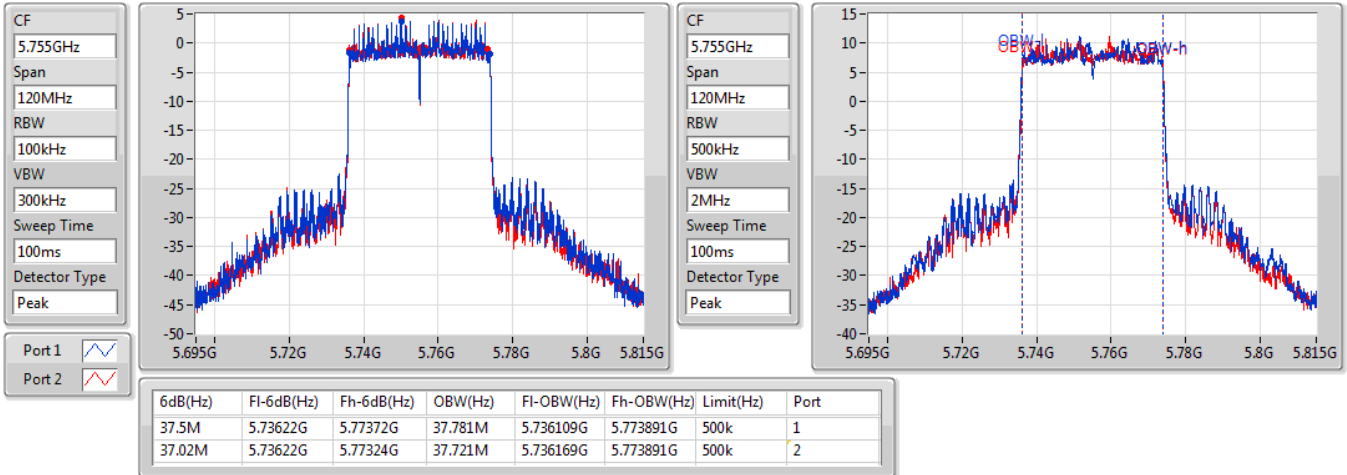

802.11ax HEW40_Nss2,(MCS0)_2TX

EBW

5795MHz

05/02/2020

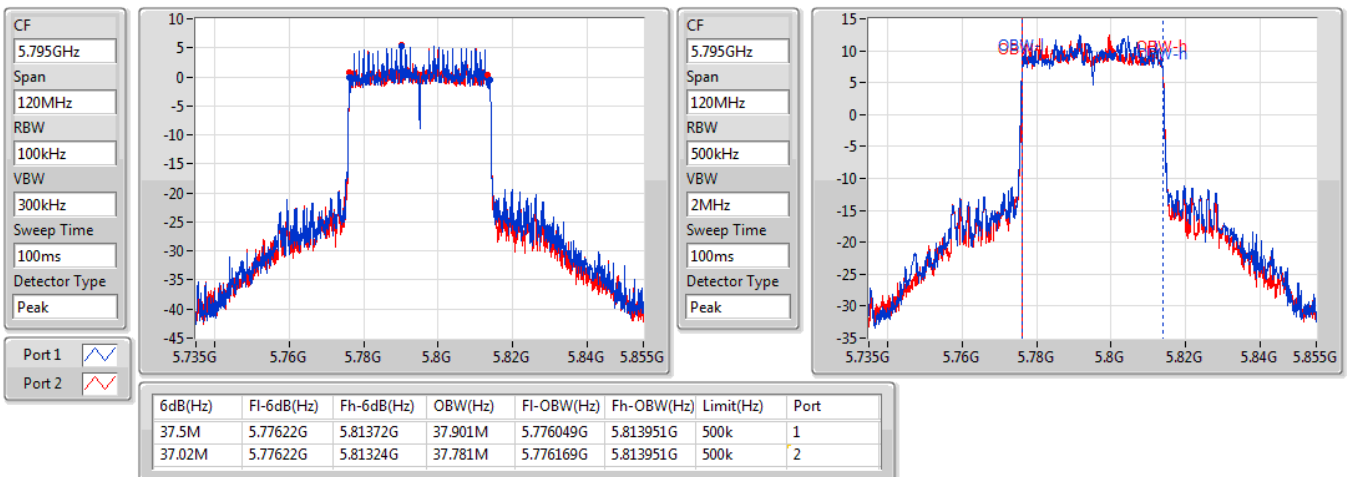

802.11ax HEW80_Nss2,(MCS0)_2TX

EBW

5210MHz

05/02/2020

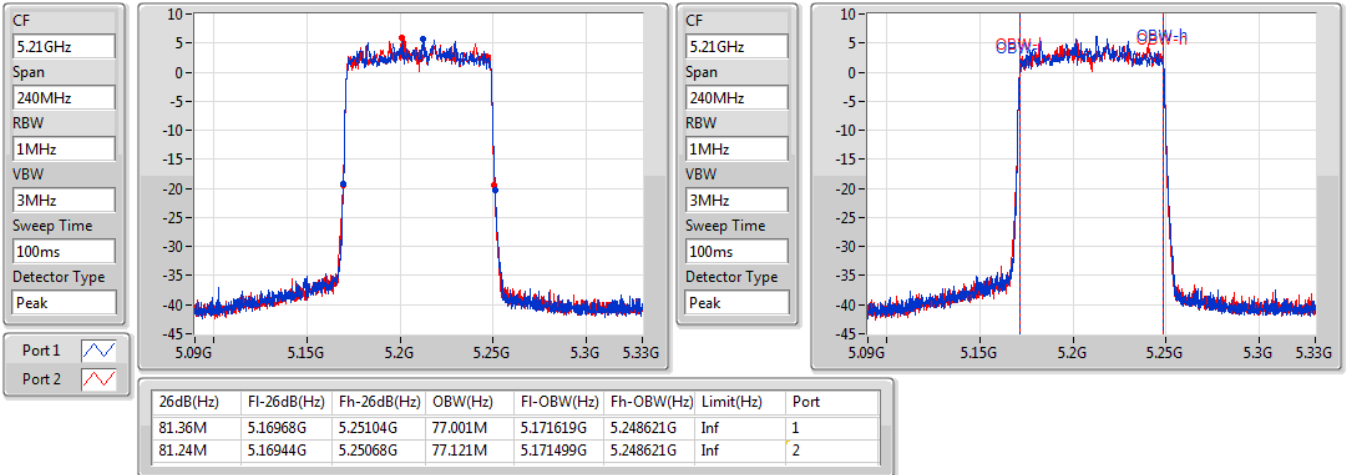

802.11ax HEW80_Nss2,(MCS0)_2TX

EBW

5775MHz

05/02/2020

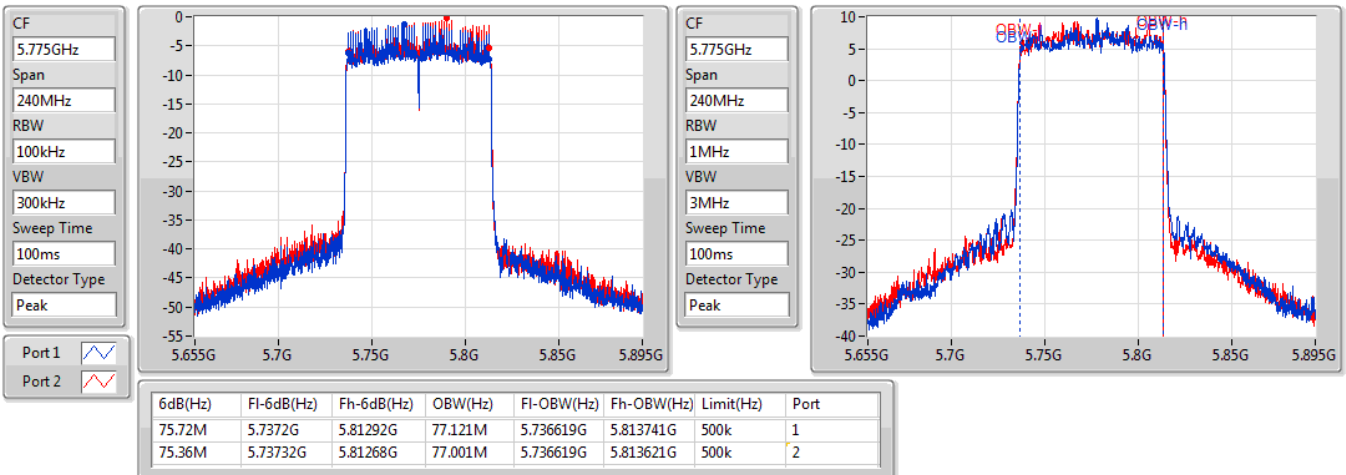



Summary

Mode	Max-N dB (Hz)	Max-OBW (Hz)	ITU-Code	Min-N dB (Hz)	Min-OBW (Hz)
5.15-5.25GHz	-	-	-	-	-
802.11a_Nss1,(6Mbps)_1TX	36.69M	19.76M	19M8D1D	21.33M	16.822M
802.11ac VHT20_Nss1,(MCS0)_1TX	37.59M	19.82M	19M8D1D	21.57M	17.871M
802.11ac VHT40_Nss1,(MCS0)_1TX	51.3M	36.702M	36M7D1D	40.32M	36.522M
802.11ac VHT80_Nss1,(MCS0)_1TX	81.96M	75.682M	75M7D1D	81.96M	75.682M
802.11ax HEW20_Nss1,(MCS0)_1TX	41.1M	20M	20M0D1D	21.36M	19.04M
802.11ax HEW40_Nss1,(MCS0)_1TX	47.16M	37.661M	37M7D1D	40.08M	37.541M
802.11ax HEW80_Nss1,(MCS0)_1TX	82.08M	77.001M	77M0D1D	82.08M	77.001M
5.725-5.85GHz	-	-	-	-	-
802.11a_Nss1,(6Mbps)_1TX	16.35M	24.378M	24M4D1D	16.29M	19.1M
802.11ac VHT20_Nss1,(MCS0)_1TX	17.55M	25.577M	25M6D1D	17.55M	18.381M
802.11ac VHT40_Nss1,(MCS0)_1TX	36.3M	40.3M	40M3D1D	36.3M	37.181M
802.11ac VHT80_Nss1,(MCS0)_1TX	76.08M	75.922M	75M9D1D	76.08M	75.922M
802.11ax HEW20_Nss1,(MCS0)_1TX	18.87M	26.057M	26M1D1D	18.57M	19.34M
802.11ax HEW40_Nss1,(MCS0)_1TX	37.5M	38.321M	38M3D1D	37.2M	37.961M
802.11ax HEW80_Nss1,(MCS0)_1TX	77.04M	77.121M	77M1D1D	77.04M	77.121M

Max-N dB = Maximum 6dB down bandwidth for 5.725-5.85GHz band / Maximum 26dB down bandwidth for other band;

Max-OBW = Maximum 99% occupied bandwidth;

Min-N dB = Minimum 6dB down bandwidth for 5.725-5.85GHz band / Maximum 26dB down bandwidth for other band;

Min-OBW = Minimum 99% occupied bandwidth;



Result

Mode	Result	Limit (Hz)	Port 1-N dB (Hz)	Port 1-OBW (Hz)
802.11a_Nss1,(6Mbps)_1TX	-	-	-	-
5180MHz	Pass	Inf	21.33M	16.822M
5200MHz	Pass	Inf	35.67M	18.411M
5240MHz	Pass	Inf	36.69M	19.76M
5745MHz	Pass	500k	16.35M	19.1M
5785MHz	Pass	500k	16.32M	24.378M
5825MHz	Pass	500k	16.29M	24.288M
802.11ac VHT20_Nss1,(MCS0)_1TX	-	-	-	-
5180MHz	Pass	Inf	21.57M	17.871M
5200MHz	Pass	Inf	32.25M	18.171M
5240MHz	Pass	Inf	37.59M	19.82M
5745MHz	Pass	500k	17.55M	18.381M
5785MHz	Pass	500k	17.55M	25.577M
5825MHz	Pass	500k	17.55M	24.768M
802.11ac VHT40_Nss1,(MCS0)_1TX	-	-	-	-
5190MHz	Pass	Inf	40.32M	36.522M
5230MHz	Pass	Inf	51.3M	36.702M
5755MHz	Pass	500k	36.3M	37.181M
5795MHz	Pass	500k	36.3M	40.3M
802.11ac VHT80_Nss1,(MCS0)_1TX	-	-	-	-
5210MHz	Pass	Inf	81.96M	75.682M
5775MHz	Pass	500k	76.08M	75.922M
802.11ax HEW20_Nss1,(MCS0)_1TX	-	-	-	-
5180MHz	Pass	Inf	21.36M	19.04M
5200MHz	Pass	Inf	34.77M	19.22M
5240MHz	Pass	Inf	41.1M	20M
5745MHz	Pass	500k	18.87M	19.34M
5785MHz	Pass	500k	18.57M	26.057M
5825MHz	Pass	500k	18.84M	25.757M
802.11ax HEW40_Nss1,(MCS0)_1TX	-	-	-	-
5190MHz	Pass	Inf	40.08M	37.541M
5230MHz	Pass	Inf	47.16M	37.661M
5755MHz	Pass	500k	37.5M	37.961M
5795MHz	Pass	500k	37.2M	38.321M
802.11ax HEW80_Nss1,(MCS0)_1TX	-	-	-	-
5210MHz	Pass	Inf	82.08M	77.001M
5775MHz	Pass	500k	77.04M	77.121M

Port X-N dB = Port X 6dB down bandwidth for 5.725-5.85GHz band / 26dB down bandwidth for other band
Port X-OBW = Port X 99% occupied bandwidth;

802.11a_Nss1,(6Mbps)_1TX

EBW

5180MHz

15/02/2020

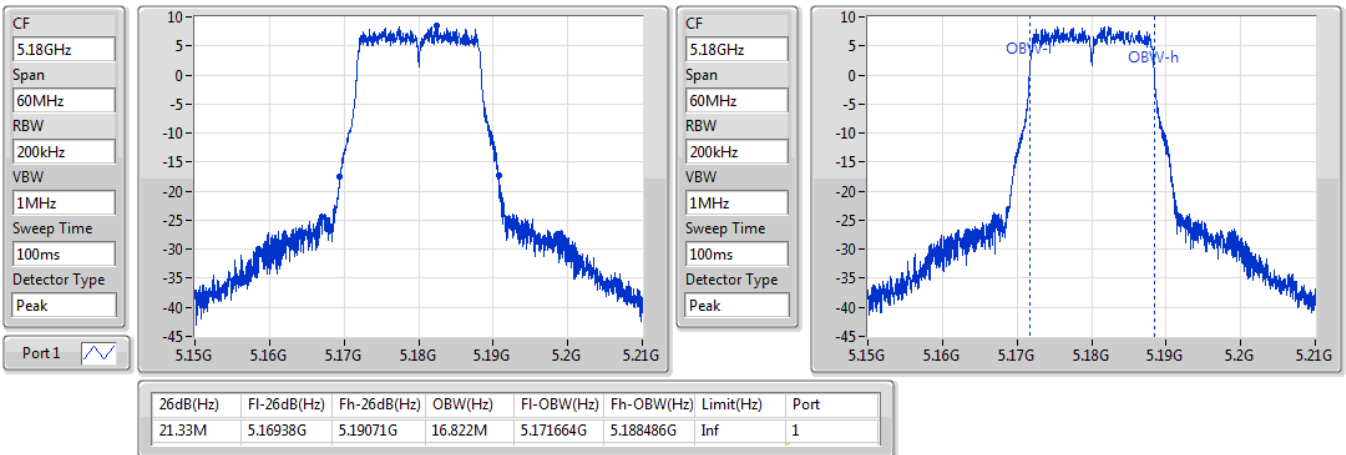

802.11a_Nss1,(6Mbps)_1TX

EBW

5200MHz

15/02/2020

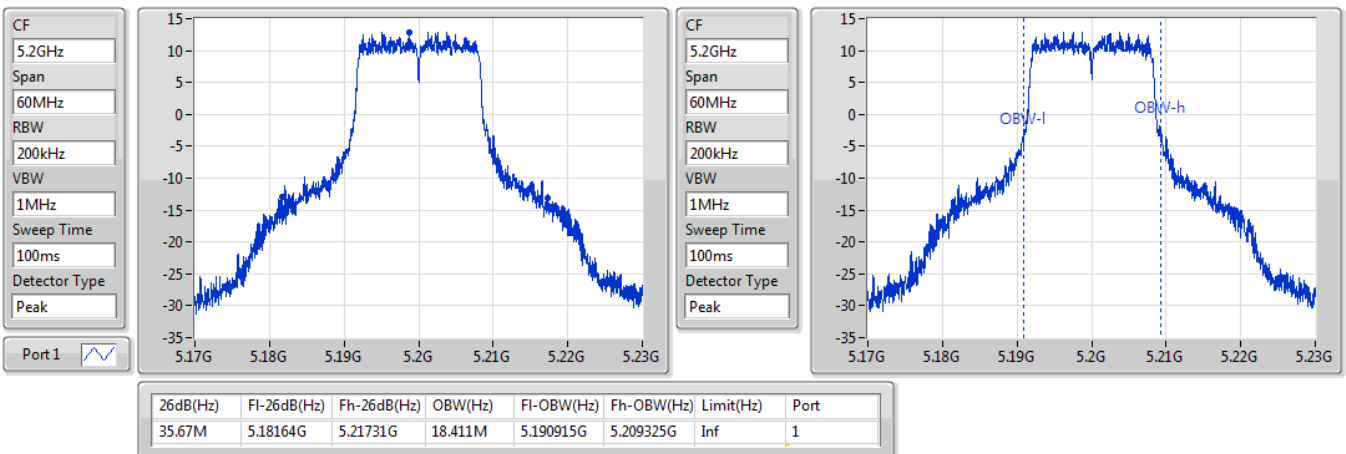

802.11a_Nss1,(6Mbps)_1TX

EBW

5240MHz

15/02/2020

CF
5.24GHz
Span
60MHz
RBW
200kHz
VBW
1MHz
Sweep Time
100ms
Detector Type
Peak
Port 1

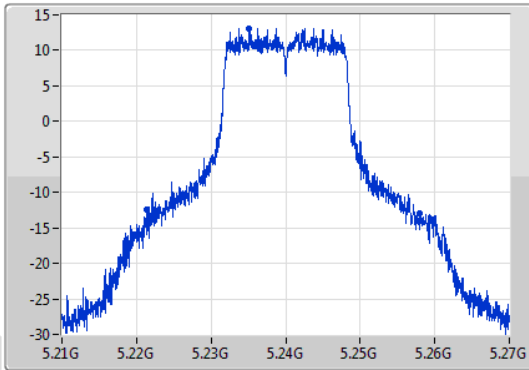

CF
5.24GHz
Span
60MHz
RBW
200kHz
VBW
1MHz
Sweep Time
100ms
Detector Type
Peak

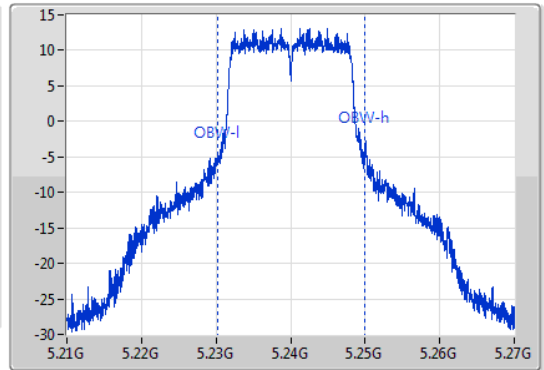

26dB(Hz)	Fl-26dB(Hz)	Fh-26dB(Hz)	OBW(Hz)	Fl-OBW(Hz)	Fh-OBW(Hz)	Limit(Hz)	Port
36.69M	5.22131G	5.258G	19.76M	5.230225G	5.249985G	Inf	1

802.11a_Nss1,(6Mbps)_1TX

EBW

5745MHz

15/02/2020

CF
5.745GHz
Span
60MHz
RBW
100kHz
VBW
300kHz
Sweep Time
100ms
Detector Type
Peak
Port 1

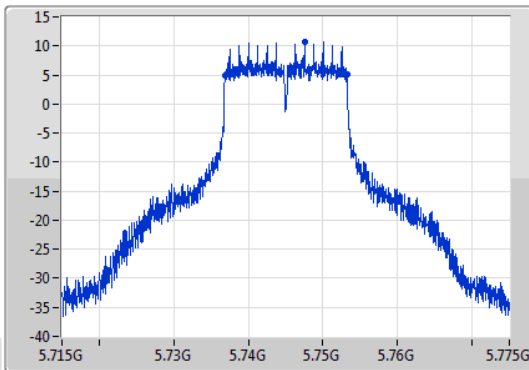

CF
5.745GHz
Span
60MHz
RBW
200kHz
VBW
1MHz
Sweep Time
100ms
Detector Type
Peak

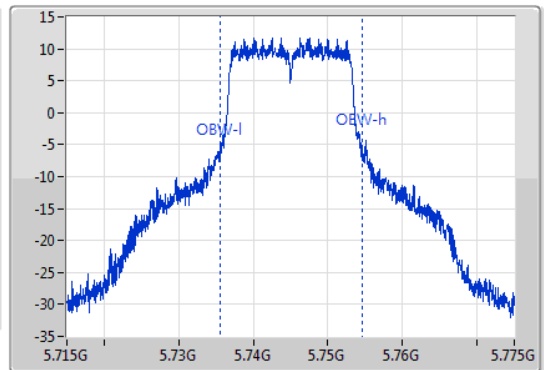

6dB(Hz)	Fl-6dB(Hz)	Fh-6dB(Hz)	OBW(Hz)	Fl-OBW(Hz)	Fh-OBW(Hz)	Limit(Hz)	Port
16.35M	5.73684G	5.75319G	19.1M	5.735495G	5.754595G	500k	1

802.11a_Nss1,(6Mbps)_1TX

EBW

5785MHz

15/02/2020

CF
5.785GHz
Span
60MHz
RBW
100kHz
VBW
300kHz
Sweep Time
100ms
Detector Type
Peak
Port 1

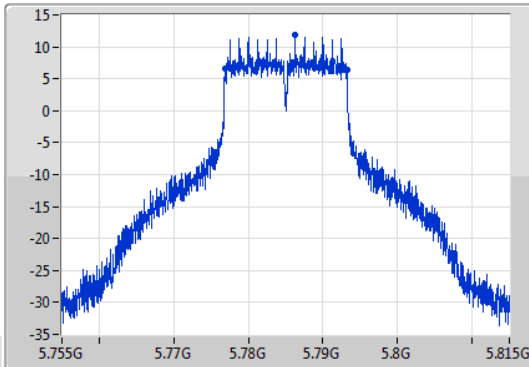

CF
5.785GHz
Span
60MHz
RBW
200kHz
VBW
1MHz
Sweep Time
100ms
Detector Type
Peak

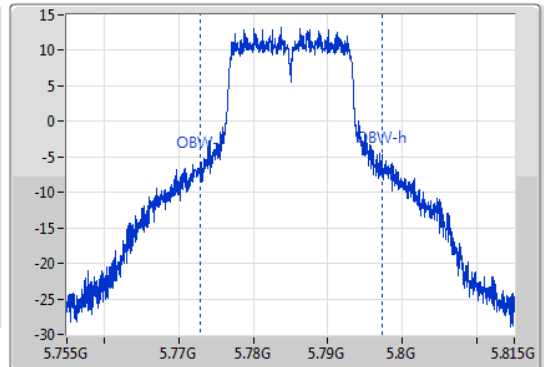

6dB(Hz)	Fl-6dB(Hz)	Fh-6dB(Hz)	OBW(Hz)	Fl-OBW(Hz)	Fh-OBW(Hz)	Limit(Hz)	Port
16.32M	5.77687G	5.79319G	24.378M	5.772946G	5.797324G	500k	1

802.11a_Nss1,(6Mbps)_1TX

EBW

5825MHz

15/02/2020

CF
5.825GHz
Span
60MHz
RBW
100kHz
VBW
300kHz
Sweep Time
100ms
Detector Type
Peak
Port 1

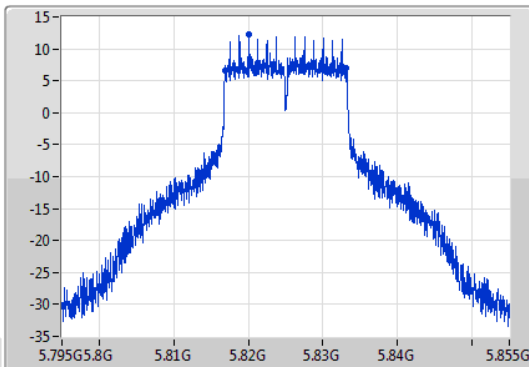

CF
5.825GHz
Span
60MHz
RBW
200kHz
VBW
1MHz
Sweep Time
100ms
Detector Type
Peak

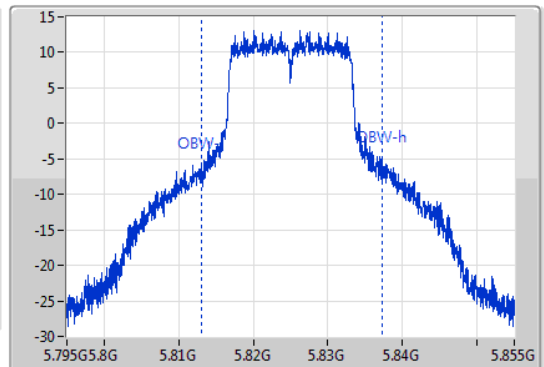

6dB(Hz)	Fl-6dB(Hz)	Fh-6dB(Hz)	OBW(Hz)	Fl-OBW(Hz)	Fh-OBW(Hz)	Limit(Hz)	Port
16.29M	5.81687G	5.83316G	24.288M	5.813006G	5.837294G	500k	1

802.11ac VHT20_Nss1,(MCS0)_1TX

EBW

5180MHz

15/02/2020

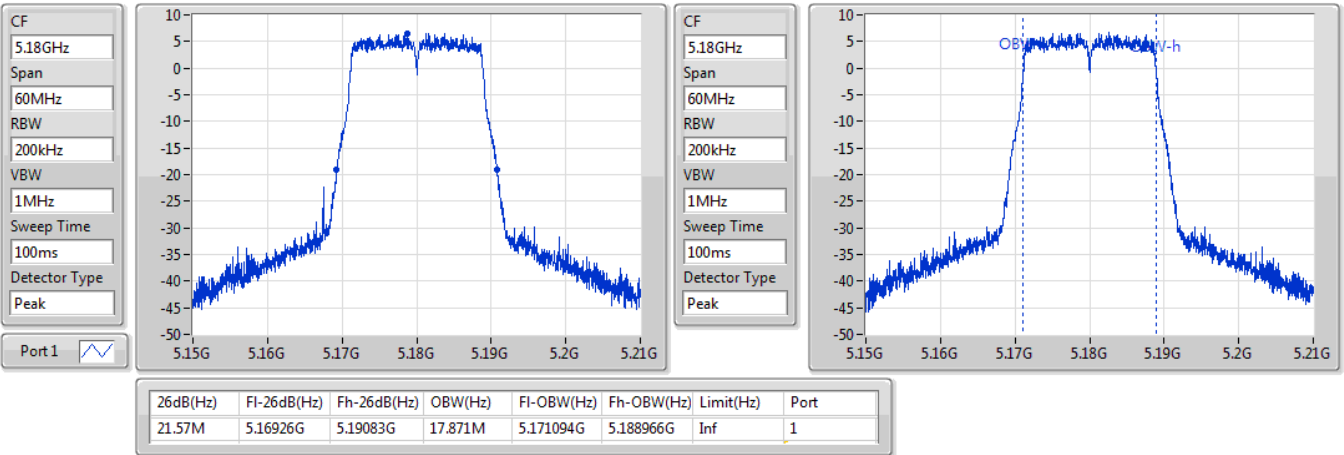

802.11ac VHT20_Nss1,(MCS0)_1TX

EBW

5200MHz

15/02/2020

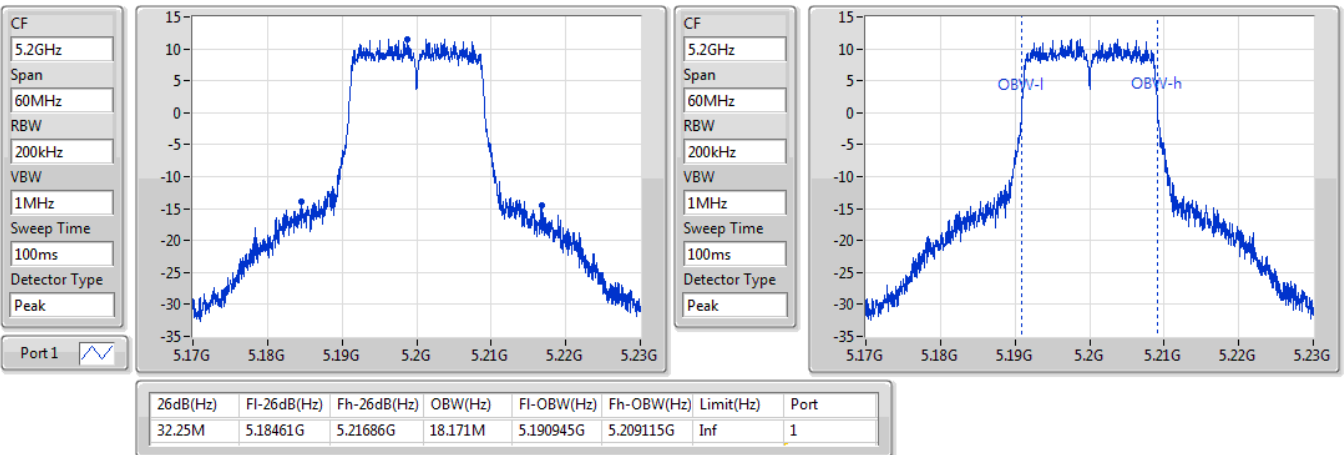

802.11ac VHT20_Nss1,(MCS0)_1TX

EBW

5240MHz

15/02/2020

CF: 5.24GHz
 Span: 60MHz
 RBW: 200kHz
 VBW: 1MHz
 Sweep Time: 100ms
 Detector Type: Peak
 Port 1

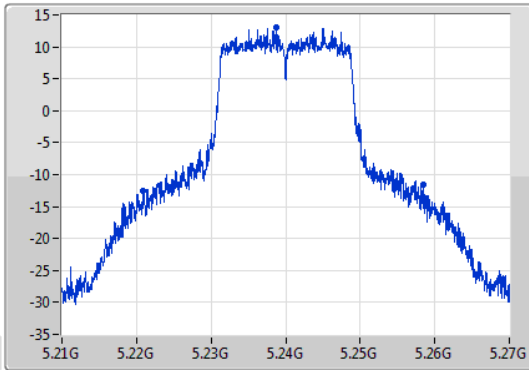

CF: 5.24GHz
 Span: 60MHz
 RBW: 200kHz
 VBW: 1MHz
 Sweep Time: 100ms
 Detector Type: Peak

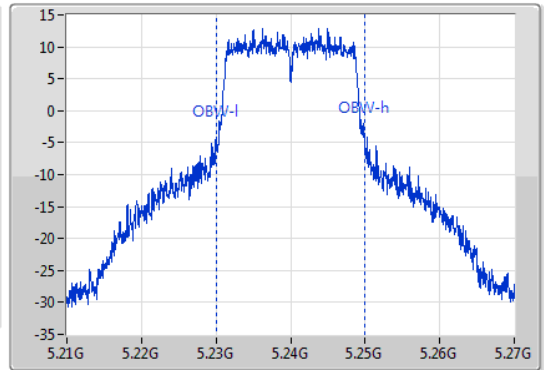

26dB(Hz)	Fl-26dB(Hz)	Fh-26dB(Hz)	OBW(Hz)	Fl-OBW(Hz)	Fh-OBW(Hz)	Limit(Hz)	Port
37.59M	5.22092G	5.25851G	19.82M	5.230045G	5.249865G	Inf	1

802.11ac VHT20_Nss1,(MCS0)_1TX

EBW

5745MHz

15/02/2020

CF: 5.745GHz
 Span: 60MHz
 RBW: 100kHz
 VBW: 300kHz
 Sweep Time: 100ms
 Detector Type: Peak
 Port 1

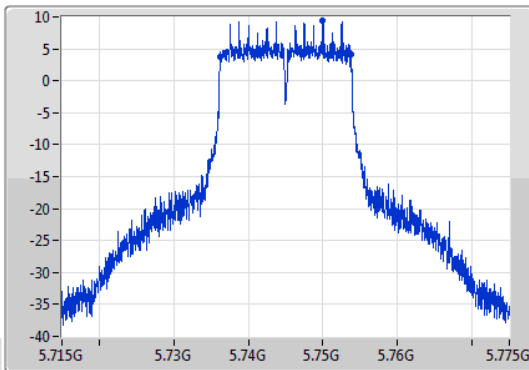

CF: 5.745GHz
 Span: 60MHz
 RBW: 200kHz
 VBW: 1MHz
 Sweep Time: 100ms
 Detector Type: Peak

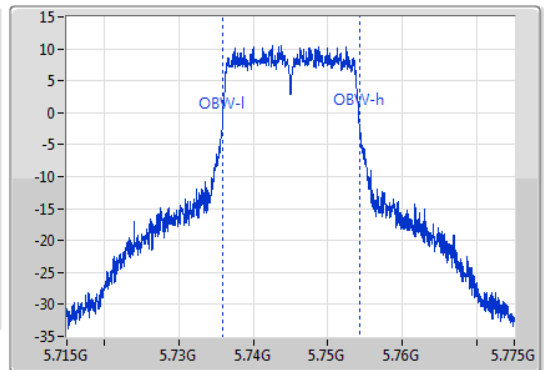

6dB(Hz)	Fl-6dB(Hz)	Fh-6dB(Hz)	OBW(Hz)	Fl-OBW(Hz)	Fh-OBW(Hz)	Limit(Hz)	Port
17.55M	5.73624G	5.75379G	18.381M	5.735825G	5.754205G	500k	1

802.11ac VHT20_Nss1,(MCS0)_1TX

EBW

5785MHz

15/02/2020

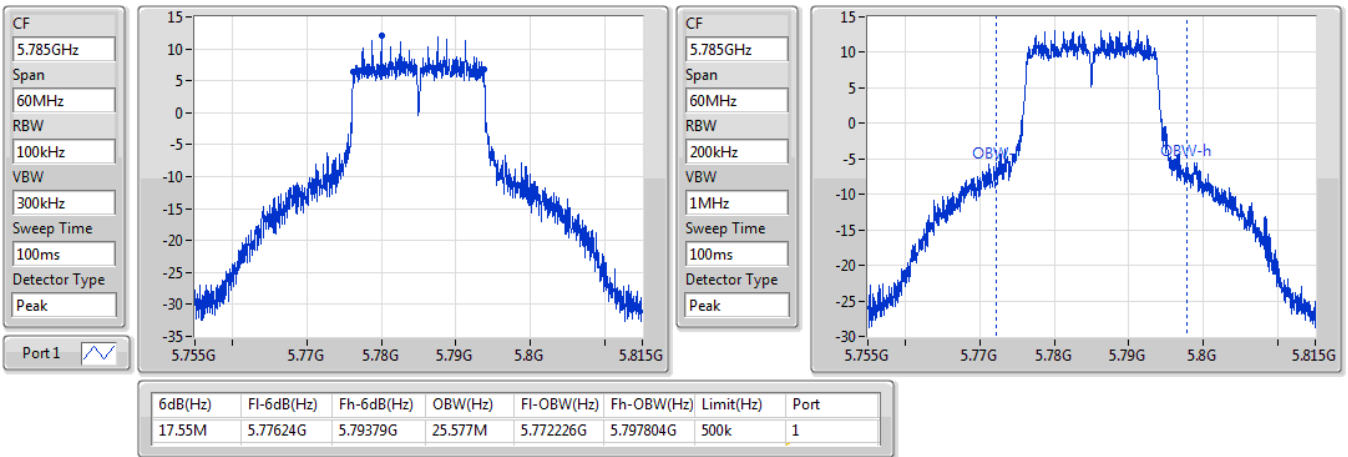

802.11ac VHT20_Nss1,(MCS0)_1TX

EBW

5825MHz

15/02/2020

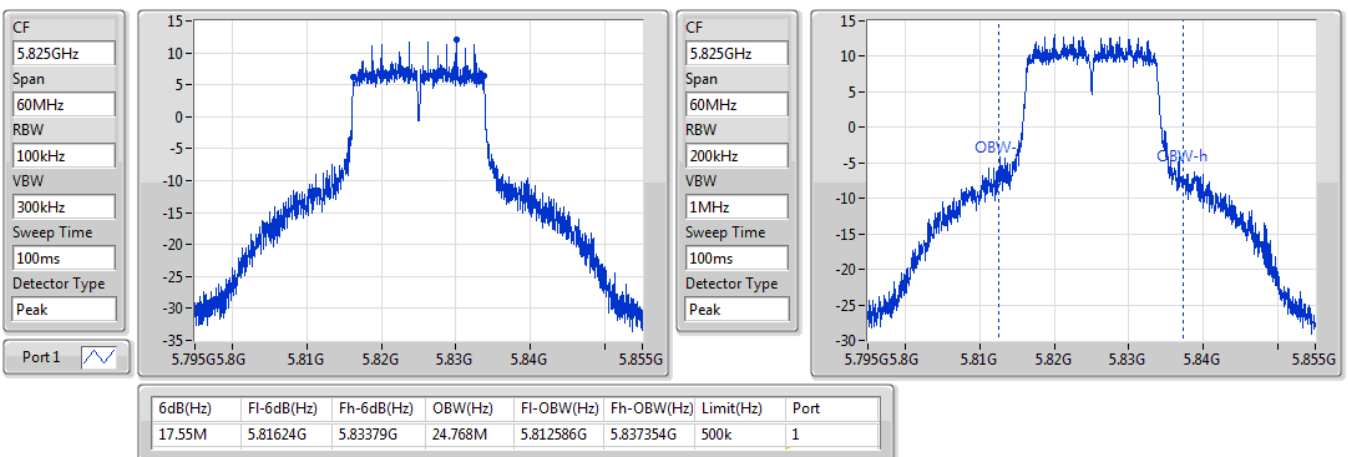



802.11ac VHT40_Nss1,(MCS0)_1TX

EBW

5190MHz

15/02/2020

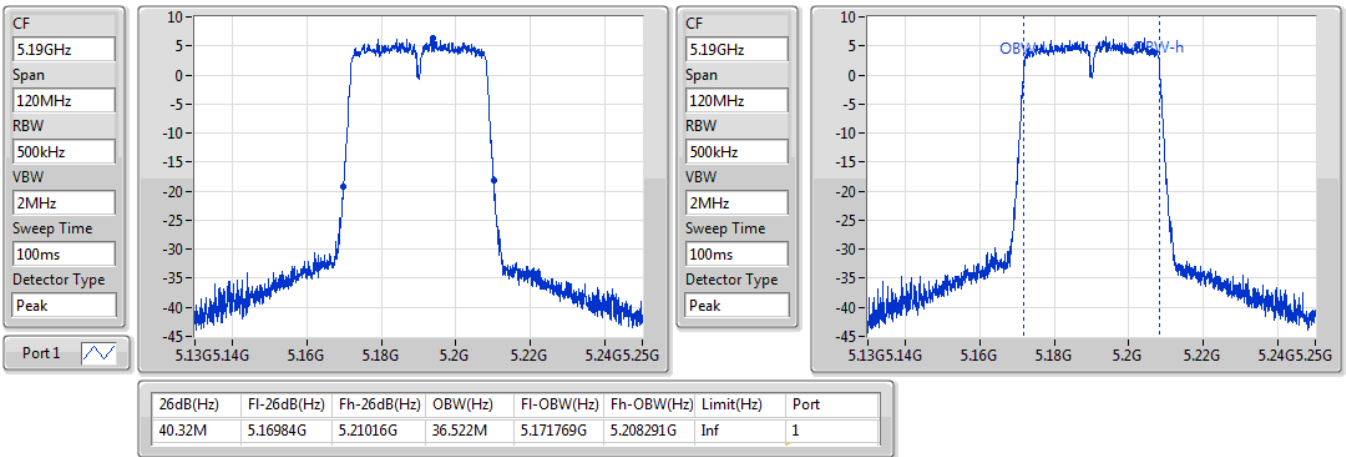

802.11ac VHT40_Nss1,(MCS0)_1TX

EBW

5230MHz

15/02/2020

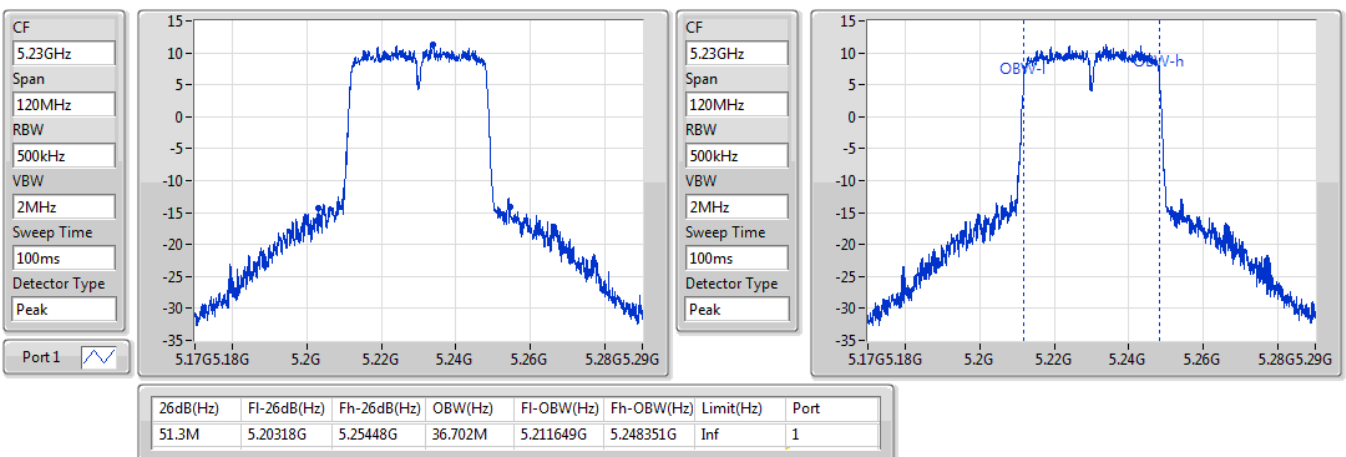

802.11ac VHT40_Nss1,(MCS0)_1TX

EBW

5755MHz

15/02/2020

CF
5.755GHz
Span
120MHz
RBW
100kHz
VBW
300kHz
Sweep Time
100ms
Detector Type
Peak
Port 1

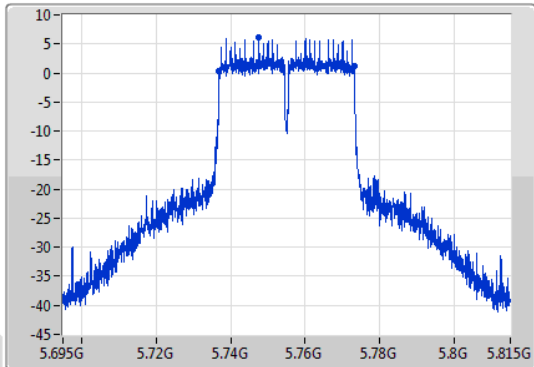

CF
5.755GHz
Span
120MHz
RBW
500kHz
VBW
2MHz
Sweep Time
100ms
Detector Type
Peak

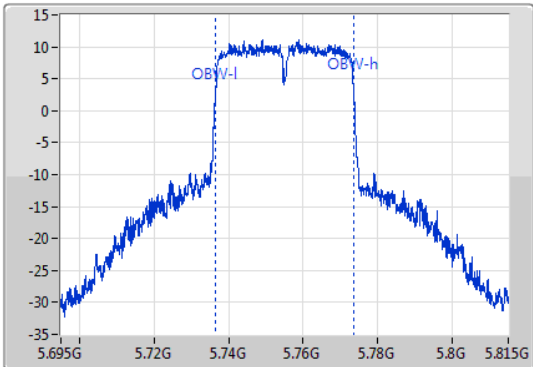

6dB(Hz)	Fl-6dB(Hz)	Fh-6dB(Hz)	OBW(Hz)	Fl-OBW(Hz)	Fh-OBW(Hz)	Limit(Hz)	Port
36.3M	5.73688G	5.77318G	37.181M	5.736349G	5.773531G	500k	1

802.11ac VHT40_Nss1,(MCS0)_1TX

EBW

5795MHz

15/02/2020

CF
5.795GHz
Span
120MHz
RBW
100kHz
VBW
300kHz
Sweep Time
100ms
Detector Type
Peak
Port 1

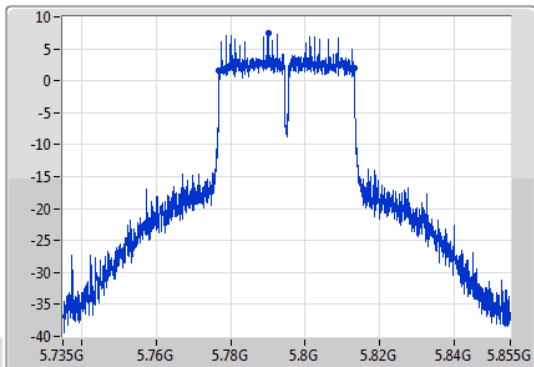

CF
5.795GHz
Span
120MHz
RBW
500kHz
VBW
2MHz
Sweep Time
100ms
Detector Type
Peak

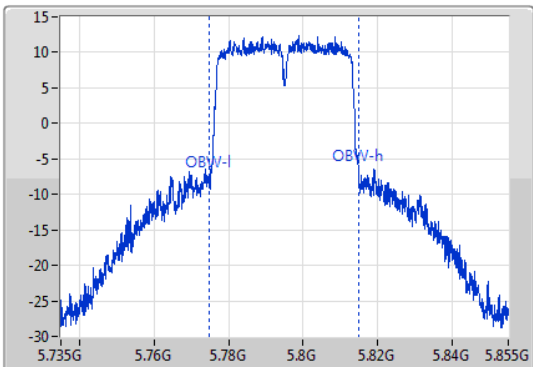

6dB(Hz)	Fl-6dB(Hz)	Fh-6dB(Hz)	OBW(Hz)	Fl-OBW(Hz)	Fh-OBW(Hz)	Limit(Hz)	Port
36.3M	5.77688G	5.81318G	40.3M	5.77467G	5.81497G	500k	1



802.11ac VHT80_Nss1,(MCS0)_1TX

EBW

5210MHz

15/02/2020

CF
5.21GHz
Span
240MHz
RBW
1MHz
VBW
3MHz
Sweep Time
100ms
Detector Type
Peak
Port 1

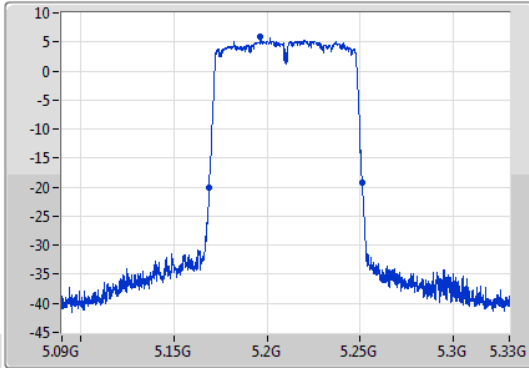

CF
5.21GHz
Span
240MHz
RBW
1MHz
VBW
3MHz
Sweep Time
100ms
Detector Type
Peak

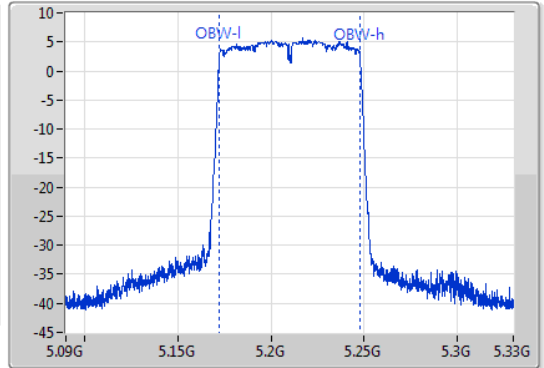

26dB(Hz)	Fl-26dB(Hz)	Fh-26dB(Hz)	OBW(Hz)	Fl-OBW(Hz)	Fh-OBW(Hz)	Limit(Hz)	Port
81.96M	5.16908G	5.25104G	75.682M	5.172219G	5.247901G	Inf	1

802.11ac VHT80_Nss1,(MCS0)_1TX

EBW

5775MHz

15/02/2020

CF
5.775GHz
Span
240MHz
RBW
100kHz
VBW
300kHz
Sweep Time
100ms
Detector Type
Peak
Port 1

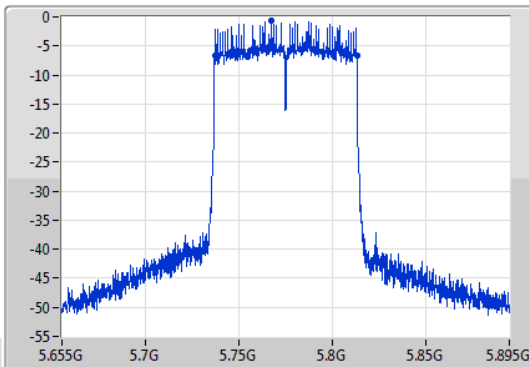

CF
5.775GHz
Span
240MHz
RBW
1MHz
VBW
3MHz
Sweep Time
100ms
Detector Type
Peak

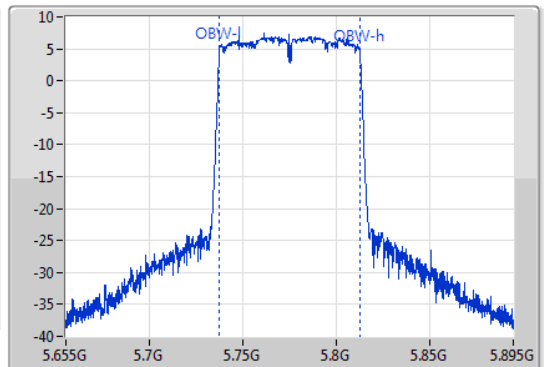

6dB(Hz)	Fl-6dB(Hz)	Fh-6dB(Hz)	OBW(Hz)	Fl-OBW(Hz)	Fh-OBW(Hz)	Limit(Hz)	Port
76.08M	5.73708G	5.81316G	75.922M	5.737099G	5.813021G	500k	1



802.11ax HEW20_Nss1,(MCS0)_1TX

EBW

5180MHz

15/02/2020

CF
5.18GHz
Span
60MHz
RBW
200kHz
VBW
1MHz
Sweep Time
100ms
Detector Type
Peak
Port 1

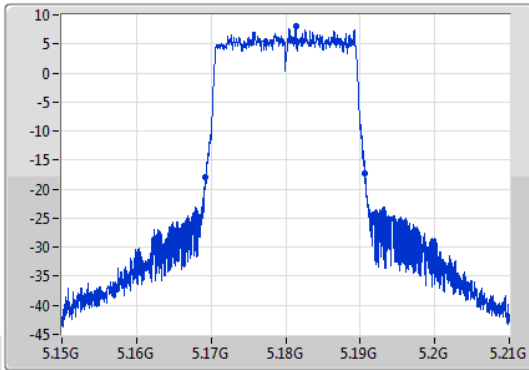

CF
5.18GHz
Span
60MHz
RBW
200kHz
VBW
1MHz
Sweep Time
100ms
Detector Type
Peak

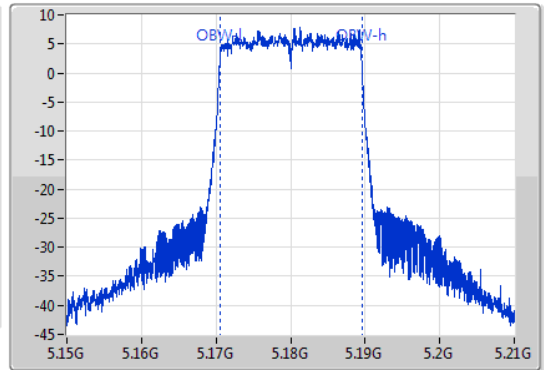

26dB(Hz)	Fl-26dB(Hz)	Fh-26dB(Hz)	OBW(Hz)	Fl-OBW(Hz)	Fh-OBW(Hz)	Limit(Hz)	Port
21.36M	5.16929G	5.19065G	19.04M	5.170495G	5.189535G	Inf	1

802.11ax HEW20_Nss1,(MCS0)_1TX

EBW

5200MHz

15/02/2020

CF
5.2GHz
Span
60MHz
RBW
200kHz
VBW
1MHz
Sweep Time
100ms
Detector Type
Peak
Port 1

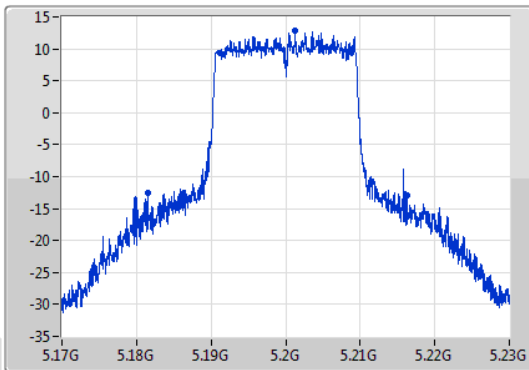

CF
5.2GHz
Span
60MHz
RBW
200kHz
VBW
1MHz
Sweep Time
100ms
Detector Type
Peak

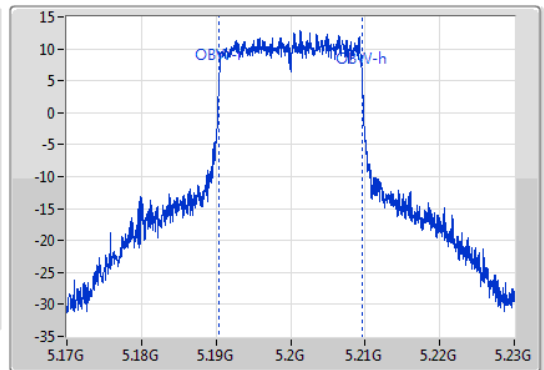

26dB(Hz)	Fl-26dB(Hz)	Fh-26dB(Hz)	OBW(Hz)	Fl-OBW(Hz)	Fh-OBW(Hz)	Limit(Hz)	Port
34.77M	5.18146G	5.21623G	19.22M	5.190405G	5.209625G	Inf	1

802.11ax HEW20_Nss1,(MCS0)_1TX

EBW

5240MHz

15/02/2020

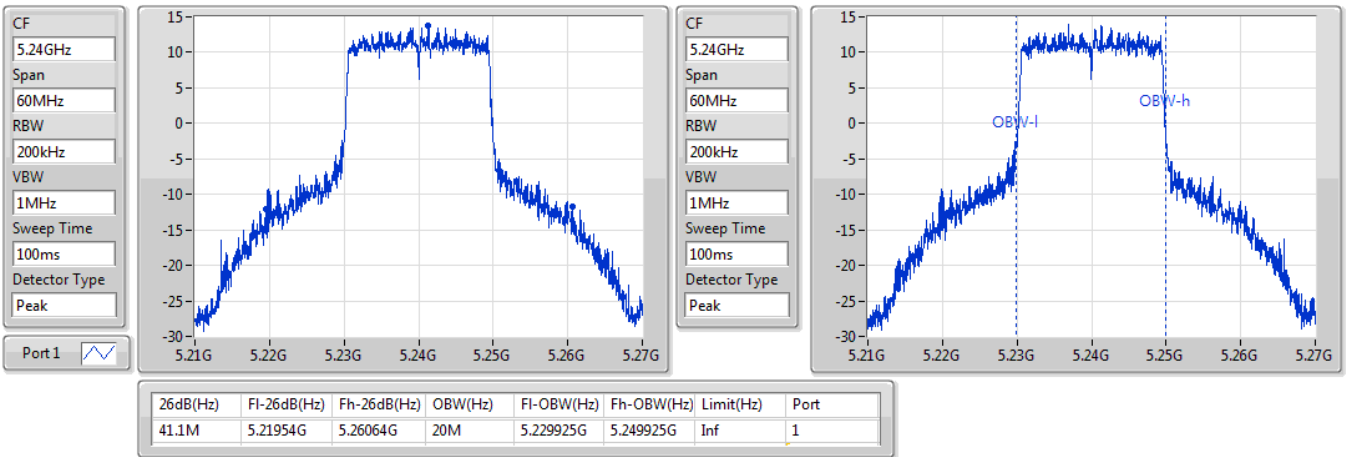

802.11ax HEW20_Nss1,(MCS0)_1TX

EBW

5745MHz

15/02/2020

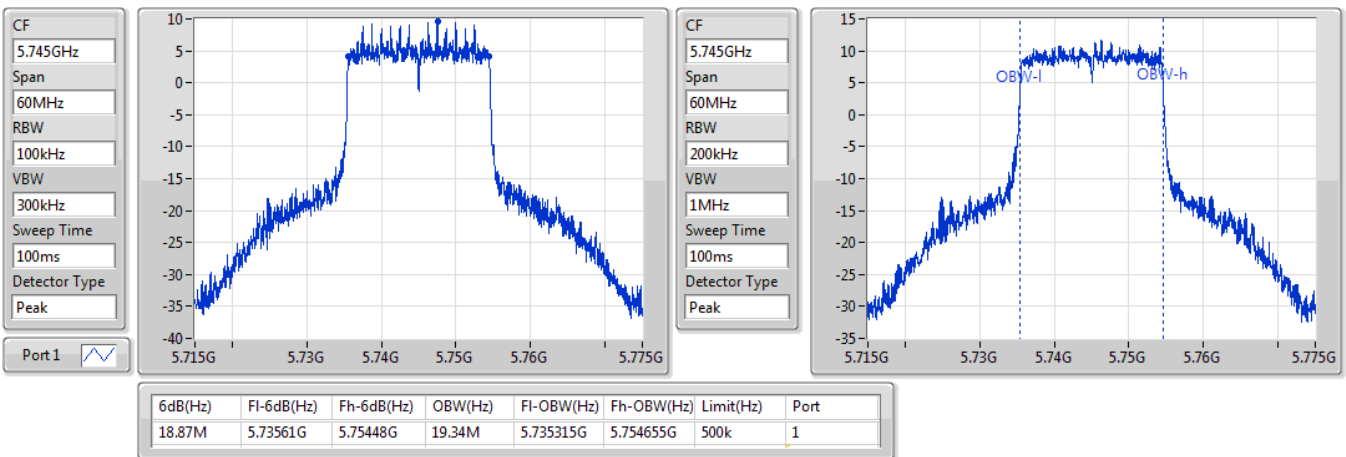

802.11ax HEW20_Nss1,(MCS0)_1TX

EBW

5785MHz

15/02/2020

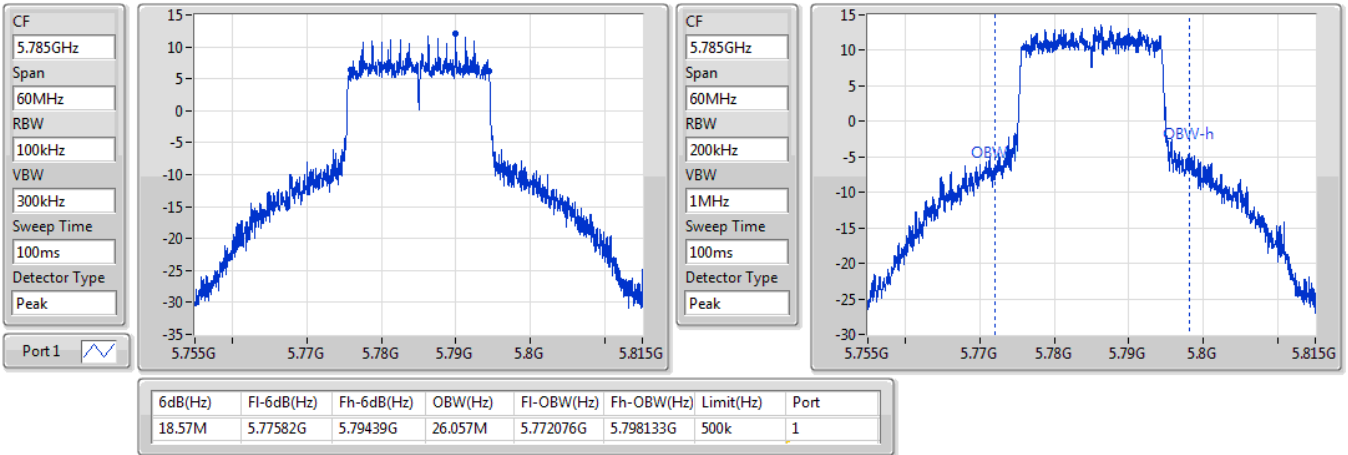

802.11ax HEW20_Nss1,(MCS0)_1TX

EBW

5825MHz

15/02/2020

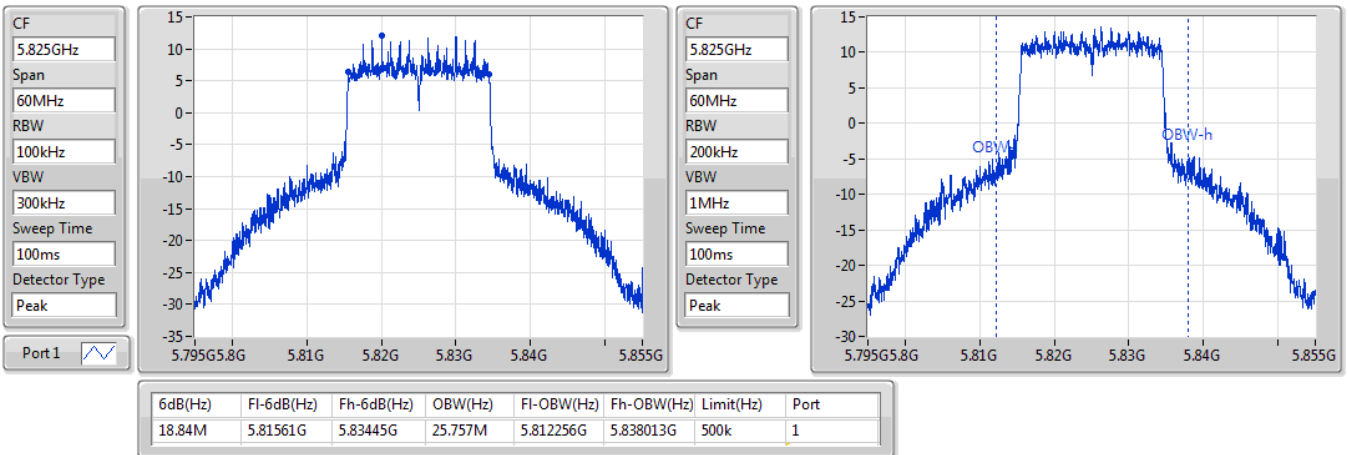

802.11ax HEW40_Nss1,(MCS0)_1TX

EBW

5190MHz

15/02/2020

CF
5.19GHz
Span
120MHz
RBW
500kHz
VBW
2MHz
Sweep Time
100ms
Detector Type
Peak
Port 1

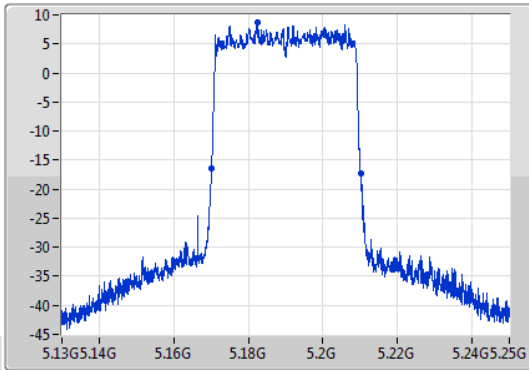

CF
5.19GHz
Span
120MHz
RBW
500kHz
VBW
2MHz
Sweep Time
100ms
Detector Type
Peak

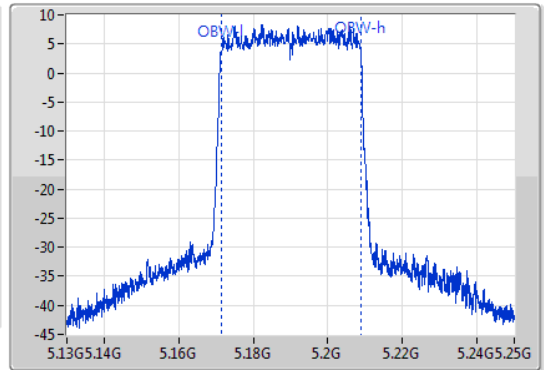

26dB(Hz)	Fl-26dB(Hz)	Fh-26dB(Hz)	OBW(Hz)	Fl-OBW(Hz)	Fh-OBW(Hz)	Limit(Hz)	Port
40.08M	5.17014G	5.21022G	37.541M	5.171289G	5.208831G	Inf	1

802.11ax HEW40_Nss1,(MCS0)_1TX

EBW

5230MHz

15/02/2020

CF
5.23GHz
Span
120MHz
RBW
500kHz
VBW
2MHz
Sweep Time
100ms
Detector Type
Peak
Port 1

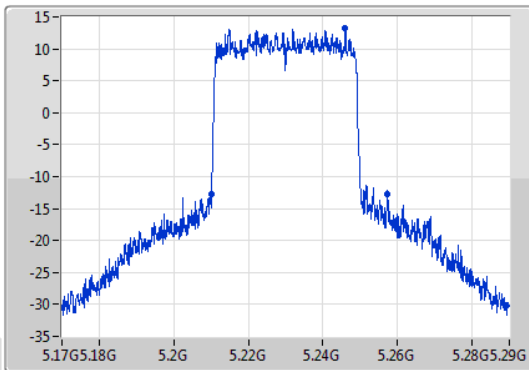

CF
5.23GHz
Span
120MHz
RBW
500kHz
VBW
2MHz
Sweep Time
100ms
Detector Type
Peak

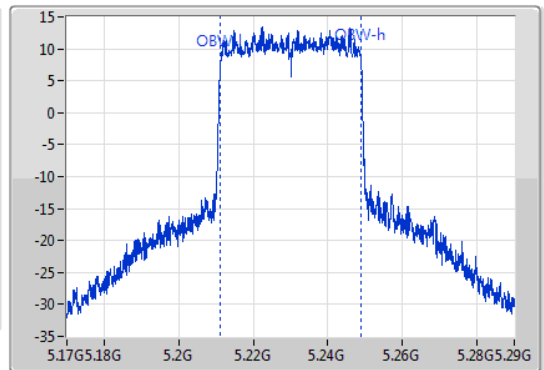

26dB(Hz)	Fl-26dB(Hz)	Fh-26dB(Hz)	OBW(Hz)	Fl-OBW(Hz)	Fh-OBW(Hz)	Limit(Hz)	Port
47.16M	5.21008G	5.25724G	37.661M	5.211229G	5.248891G	Inf	1

802.11ax HEW40_Nss1,(MCS0)_1TX

EBW

5755MHz

15/02/2020

CF
5.755GHz
Span
120MHz
RBW
100kHz
VBW
300kHz
Sweep Time
100ms
Detector Type
Peak
Port 1

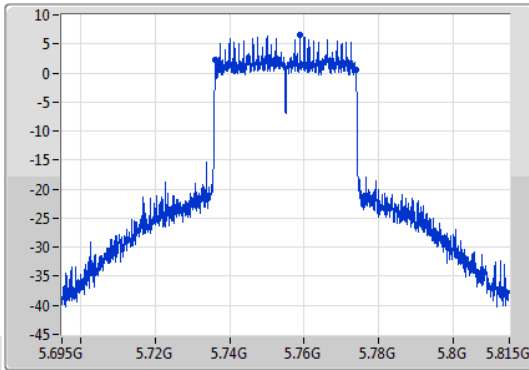

CF
5.755GHz
Span
120MHz
RBW
500kHz
VBW
2MHz
Sweep Time
100ms
Detector Type
Peak

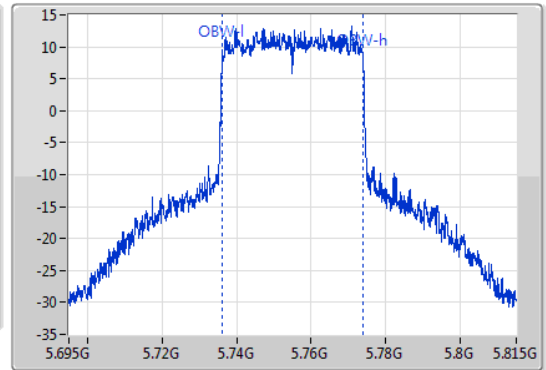

6dB(Hz)	Fl-6dB(Hz)	Fh-6dB(Hz)	OBW(Hz)	Fl-OBW(Hz)	Fh-OBW(Hz)	Limit(Hz)	Port
37.5M	5.73622G	5.77372G	37.961M	5.736049G	5.77401G	500k	1

802.11ax HEW40_Nss1,(MCS0)_1TX

EBW

5795MHz

15/02/2020

CF
5.795GHz
Span
120MHz
RBW
100kHz
VBW
300kHz
Sweep Time
100ms
Detector Type
Peak
Port 1

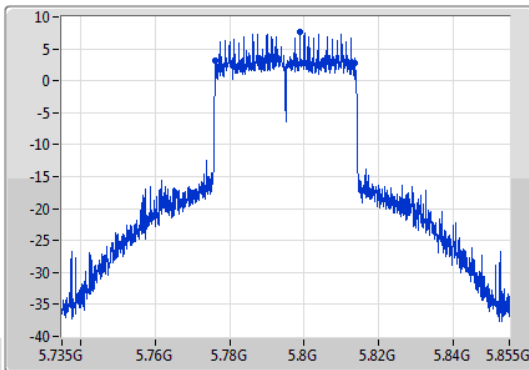

CF
5.795GHz
Span
120MHz
RBW
500kHz
VBW
2MHz
Sweep Time
100ms
Detector Type
Peak

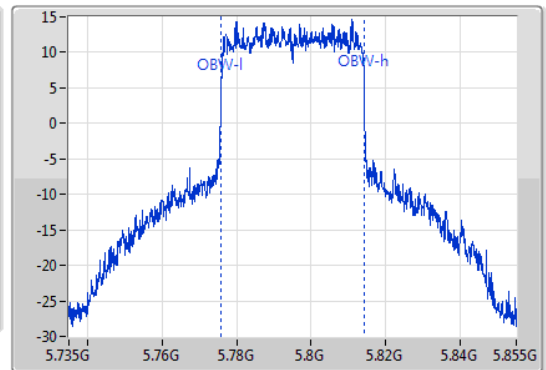

6dB(Hz)	Fl-6dB(Hz)	Fh-6dB(Hz)	OBW(Hz)	Fl-OBW(Hz)	Fh-OBW(Hz)	Limit(Hz)	Port
37.2M	5.77628G	5.81348G	38.321M	5.77587G	5.81419G	500k	1

802.11ax HEW80_Nss1,(MCS0)_1TX

EBW

5210MHz

15/02/2020

CF
5.21GHz
Span
240MHz
RBW
1MHz
VBW
3MHz
Sweep Time
100ms
Detector Type
Peak
Port 1

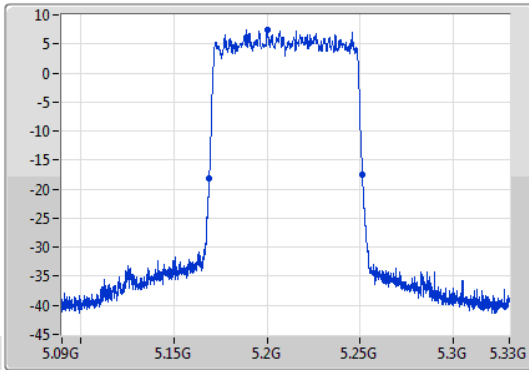

CF
5.21GHz
Span
240MHz
RBW
1MHz
VBW
3MHz
Sweep Time
100ms
Detector Type
Peak

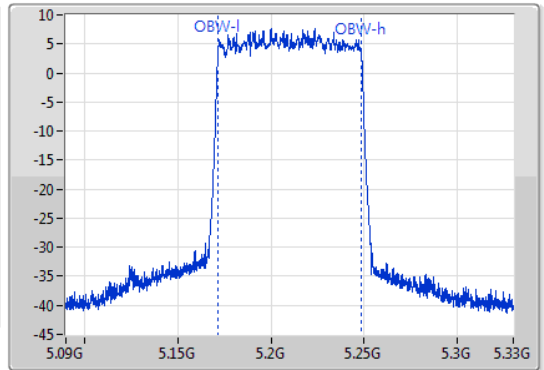

26dB(Hz)	Fl-26dB(Hz)	Fh-26dB(Hz)	OBW(Hz)	Fl-OBW(Hz)	Fh-OBW(Hz)	Limit(Hz)	Port
82.08M	5.16908G	5.25116G	77.001M	5.171619G	5.248621G	Inf	1

802.11ax HEW80_Nss1,(MCS0)_1TX

EBW

5775MHz

15/02/2020

CF
5.775GHz
Span
240MHz
RBW
100kHz
VBW
300kHz
Sweep Time
100ms
Detector Type
Peak
Port 1

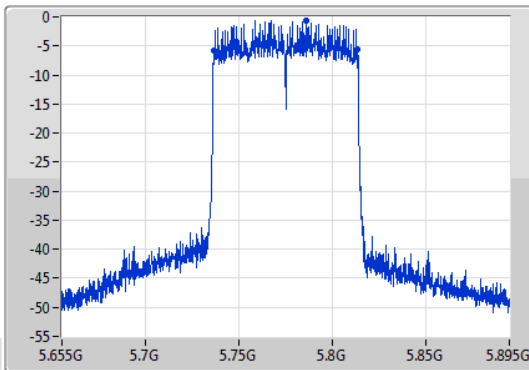

CF
5.775GHz
Span
240MHz
RBW
1MHz
VBW
3MHz
Sweep Time
100ms
Detector Type
Peak

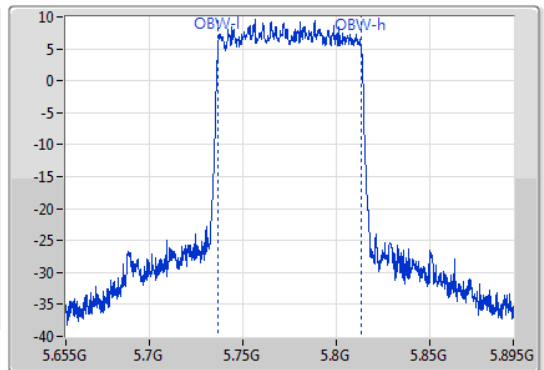

6dB(Hz)	Fl-6dB(Hz)	Fh-6dB(Hz)	OBW(Hz)	Fl-OBW(Hz)	Fh-OBW(Hz)	Limit(Hz)	Port
77.04M	5.73648G	5.81352G	77.121M	5.736499G	5.813621G	500k	1



Summary

Mode	Max-N dB (Hz)	Max-OBW (Hz)	ITU-Code	Min-N dB (Hz)	Min-OBW (Hz)
5.15-5.25GHz	-	-	-	-	-
802.11a_Nss1,(6Mbps)_2TX	21.66M	16.792M	16M8D1D	21.06M	16.642M
802.11ac VHT20_Nss2,(MCS0)_2TX	27.27M	18.111M	18M1D1D	21.48M	17.811M
802.11ac VHT40_Nss2,(MCS0)_2TX	40.38M	36.522M	36M5D1D	39.78M	36.342M
802.11ac VHT80_Nss2,(MCS0)_2TX	81.48M	75.802M	75M8D1D	81.36M	75.802M
802.11ax HEW20_Nss2,(MCS0)_2TX	26.16M	19.13M	19M1D1D	21.33M	19.01M
802.11ax HEW40_Nss2,(MCS0)_2TX	40.56M	37.721M	37M7D1D	39.72M	37.541M
802.11ax HEW80_Nss2,(MCS0)_2TX	81.48M	77.001M	77M0D1D	81.12M	77.001M
5.725-5.85GHz	-	-	-	-	-
802.11a_Nss1,(6Mbps)_2TX	16.56M	17.871M	17M9D1D	16.32M	16.672M
802.11ac VHT20_Nss2,(MCS0)_2TX	17.58M	18.561M	18M6D1D	17.58M	17.811M
802.11ac VHT40_Nss2,(MCS0)_2TX	36.3M	36.822M	36M8D1D	36.3M	36.522M
802.11ac VHT80_Nss2,(MCS0)_2TX	75.72M	75.922M	75M9D1D	75.6M	75.802M
802.11ax HEW20_Nss2,(MCS0)_2TX	18.96M	19.28M	19M3D1D	18.72M	19.01M
802.11ax HEW40_Nss2,(MCS0)_2TX	37.56M	37.961M	38M0D1D	36.78M	37.841M
802.11ax HEW80_Nss2,(MCS0)_2TX	76.32M	77.121M	77M1D1D	75.84M	77.121M

Max-N dB = Maximum 6dB down bandwidth for 5.725-5.85GHz band / Maximum 26dB down bandwidth for other band;
Max-OBW = Maximum 99% occupied bandwidth;
Min-N dB = Minimum 6dB down bandwidth for 5.725-5.85GHz band / Maximum 26dB down bandwidth for other band;
Min-OBW = Minimum 99% occupied bandwidth;



Result

Mode	Result	Limit (Hz)	Port 1-N dB (Hz)	Port 1-OBW (Hz)	Port 2-N dB (Hz)	Port 2-OBW (Hz)
802.11a_Nss1,(6Mbps)_2TX	-	-	-	-	-	-
5180MHz	Pass	Inf	21.42M	16.762M	21.18M	16.642M
5200MHz	Pass	Inf	21.27M	16.762M	21.66M	16.672M
5240MHz	Pass	Inf	21.06M	16.792M	21.3M	16.702M
5745MHz	Pass	500k	16.32M	17.871M	16.32M	17.811M
5785MHz	Pass	500k	16.56M	17.601M	16.32M	17.421M
5825MHz	Pass	500k	16.56M	16.762M	16.32M	16.672M
802.11ac VHT20_Nss2,(MCS0)_2TX	-	-	-	-	-	-
5180MHz	Pass	Inf	21.51M	17.901M	21.48M	17.811M
5200MHz	Pass	Inf	22.56M	17.991M	22.47M	17.871M
5240MHz	Pass	Inf	27.27M	18.111M	22.2M	17.961M
5745MHz	Pass	500k	17.58M	18.561M	17.58M	18.351M
5785MHz	Pass	500k	17.58M	18.411M	17.58M	18.201M
5825MHz	Pass	500k	17.58M	17.871M	17.58M	17.811M
802.11ac VHT40_Nss2,(MCS0)_2TX	-	-	-	-	-	-
5190MHz	Pass	Inf	39.78M	36.342M	39.78M	36.342M
5230MHz	Pass	Inf	40.38M	36.522M	39.78M	36.342M
5755MHz	Pass	500k	36.3M	36.822M	36.3M	36.582M
5795MHz	Pass	500k	36.3M	36.762M	36.3M	36.522M
802.11ac VHT80_Nss2,(MCS0)_2TX	-	-	-	-	-	-
5210MHz	Pass	Inf	81.48M	75.802M	81.36M	75.802M
5775MHz	Pass	500k	75.6M	75.922M	75.72M	75.802M
802.11ax HEW20_Nss2,(MCS0)_2TX	-	-	-	-	-	-
5180MHz	Pass	Inf	21.45M	19.01M	21.33M	19.01M
5200MHz	Pass	Inf	21.51M	19.07M	22.29M	19.07M
5240MHz	Pass	Inf	21.63M	19.13M	26.16M	19.1M
5745MHz	Pass	500k	18.84M	19.19M	18.72M	19.28M
5785MHz	Pass	500k	18.93M	19.19M	18.72M	19.25M
5825MHz	Pass	500k	18.96M	19.01M	18.93M	19.04M
802.11ax HEW40_Nss2,(MCS0)_2TX	-	-	-	-	-	-
5190MHz	Pass	Inf	39.96M	37.601M	39.72M	37.541M
5230MHz	Pass	Inf	40.02M	37.721M	40.56M	37.601M
5755MHz	Pass	500k	37.56M	37.961M	37.5M	37.961M
5795MHz	Pass	500k	36.78M	37.841M	37.02M	37.841M
802.11ax HEW80_Nss2,(MCS0)_2TX	-	-	-	-	-	-
5210MHz	Pass	Inf	81.12M	77.001M	81.48M	77.001M
5775MHz	Pass	500k	75.84M	77.121M	76.32M	77.121M

Port X-N dB = Port X 6dB down bandwidth for 5.725-5.85GHz band / 26dB down bandwidth for other band
 Port X-OBW = Port X 99% occupied bandwidth;



802.11a_Nss1,(6Mbps)_2TX

EBW

5180MHz

16/02/2020

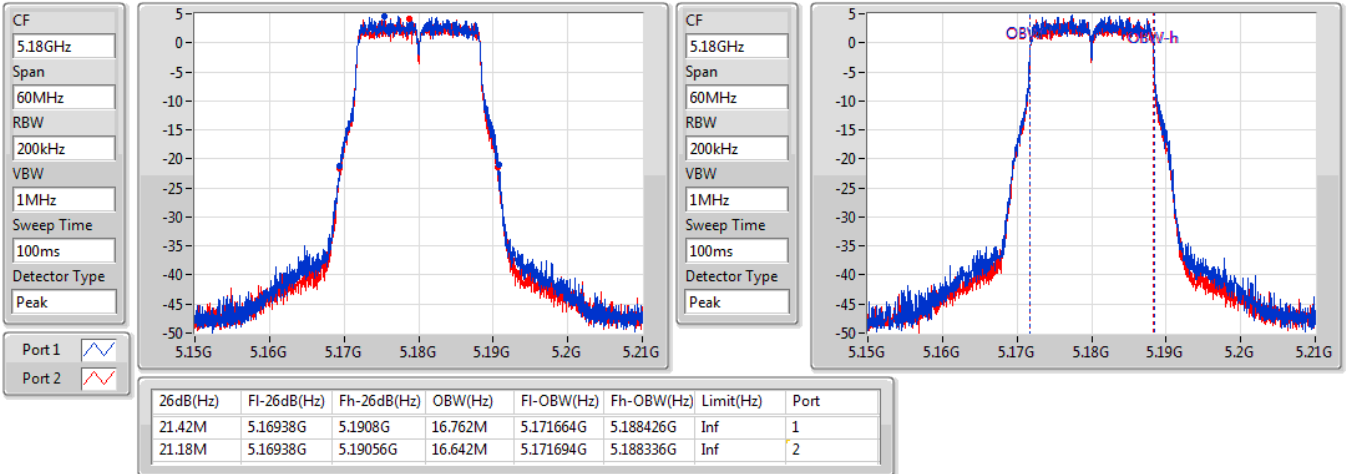

802.11a_Nss1,(6Mbps)_2TX

EBW

5200MHz

16/02/2020

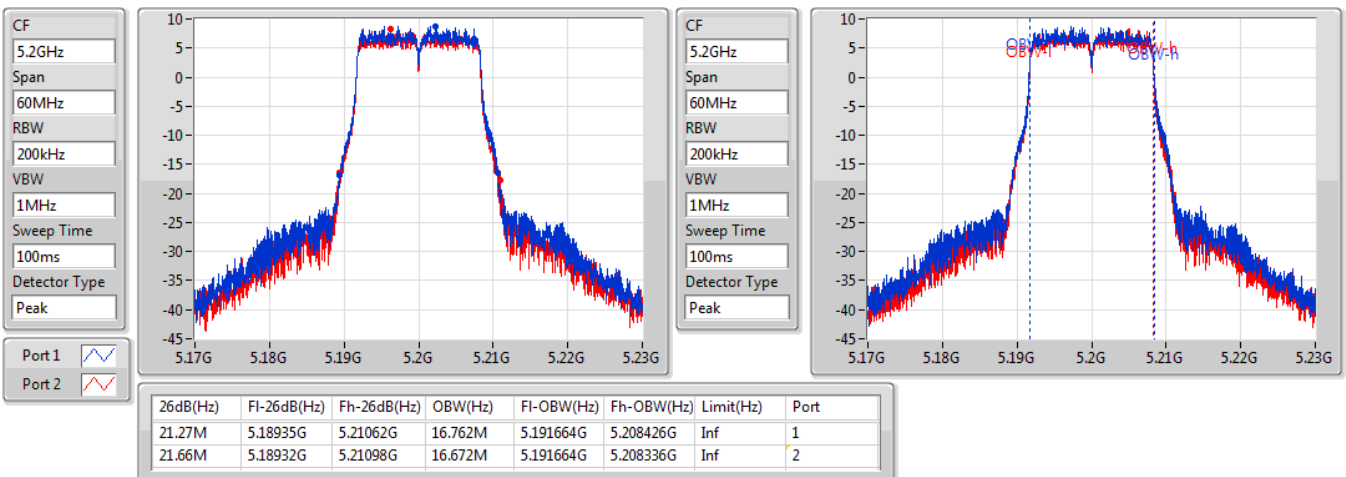

802.11a_Nss1,(6Mbps)_2TX

EBW

5240MHz

16/02/2020

CF
5.24GHz
Span
60MHz
RBW
200kHz
VBW
1MHz
Sweep Time
100ms
Detector Type
Peak

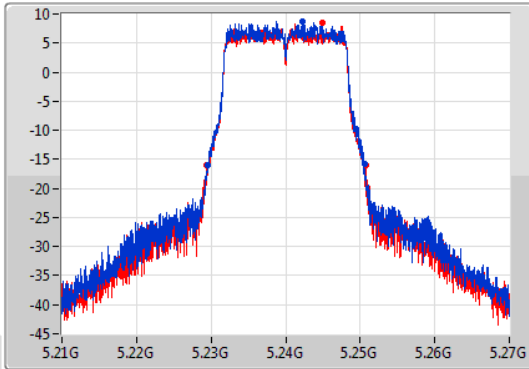

CF
5.24GHz
Span
60MHz
RBW
200kHz
VBW
1MHz
Sweep Time
100ms
Detector Type
Peak

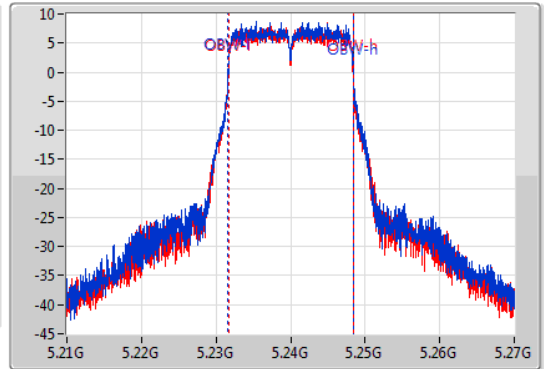

26dB(Hz)	Fl-26dB(Hz)	Fh-26dB(Hz)	OBW(Hz)	Fl-OBW(Hz)	Fh-OBW(Hz)	Limit(Hz)	Port
21.06M	5.2295G	5.25056G	16.792M	5.231634G	5.248426G	Inf	1
21.3M	5.22944G	5.25074G	16.702M	5.231664G	5.248366G	Inf	2

802.11a_Nss1,(6Mbps)_2TX

EBW

5745MHz

16/02/2020

CF
5.745GHz
Span
60MHz
RBW
100kHz
VBW
300kHz
Sweep Time
100ms
Detector Type
Peak

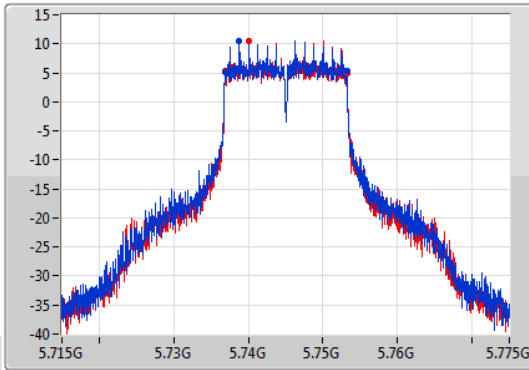

CF
5.745GHz
Span
60MHz
RBW
200kHz
VBW
1MHz
Sweep Time
100ms
Detector Type
Peak

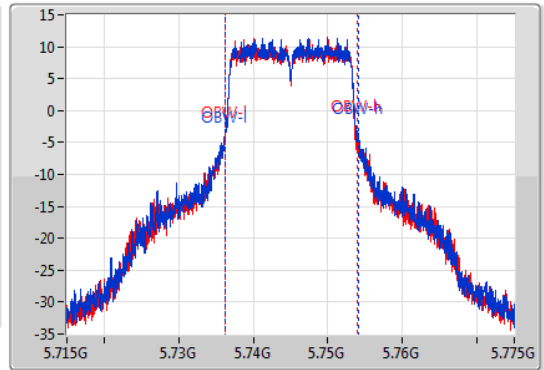

6dB(Hz)	Fl-6dB(Hz)	Fh-6dB(Hz)	OBW(Hz)	Fl-OBW(Hz)	Fh-OBW(Hz)	Limit(Hz)	Port
16.32M	5.73687G	5.75319G	17.871M	5.736154G	5.754025G	500k	1
16.32M	5.73687G	5.75319G	17.811M	5.736154G	5.753966G	500k	2

802.11a_Nss1,(6Mbps)_2TX

EBW

5785MHz

16/02/2020

CF
5.785GHz

Span
60MHz

RBW
100kHz

VBW
300kHz

Sweep Time
100ms

Detector Type
Peak

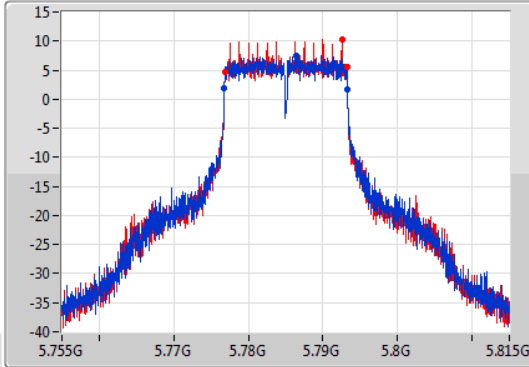

CF
5.785GHz

Span
60MHz

RBW
200kHz

VBW
1MHz

Sweep Time
100ms

Detector Type
Peak

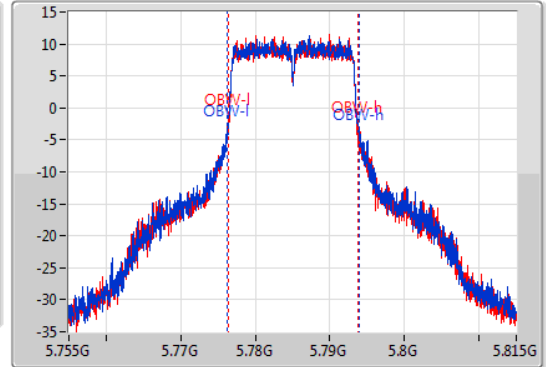

6dB(Hz)	Fl-6dB(Hz)	Fh-6dB(Hz)	OBW(Hz)	Fl-OBW(Hz)	Fh-OBW(Hz)	Limit(Hz)	Port
16.56M	5.77675G	5.79331G	17.601M	5.776304G	5.793906G	500k	1
16.32M	5.77687G	5.79319G	17.421M	5.776334G	5.793756G	500k	2

802.11a_Nss1,(6Mbps)_2TX

EBW

5825MHz

16/02/2020

CF
5.825GHz

Span
60MHz

RBW
100kHz

VBW
300kHz

Sweep Time
100ms

Detector Type
Peak

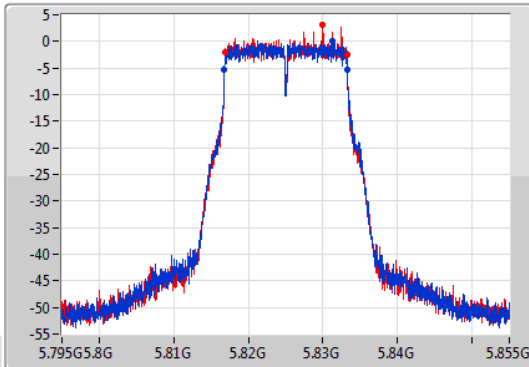

CF
5.825GHz

Span
60MHz

RBW
200kHz

VBW
1MHz

Sweep Time
100ms

Detector Type
Peak

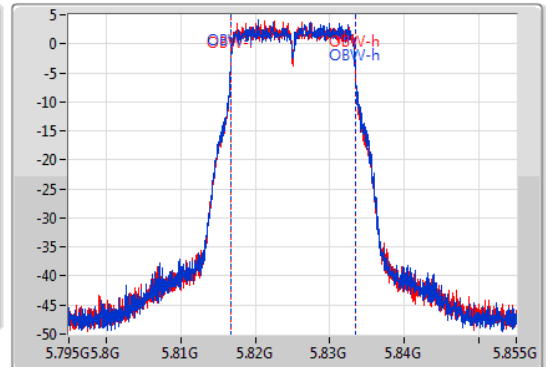

6dB(Hz)	Fl-6dB(Hz)	Fh-6dB(Hz)	OBW(Hz)	Fl-OBW(Hz)	Fh-OBW(Hz)	Limit(Hz)	Port
16.56M	5.81675G	5.83331G	16.762M	5.816694G	5.833456G	500k	1
16.32M	5.81687G	5.83319G	16.672M	5.816694G	5.833366G	500k	2

802.11ac VHT20_Nss2,(MCS0)_2TX

EBW

5180MHz

16/02/2020

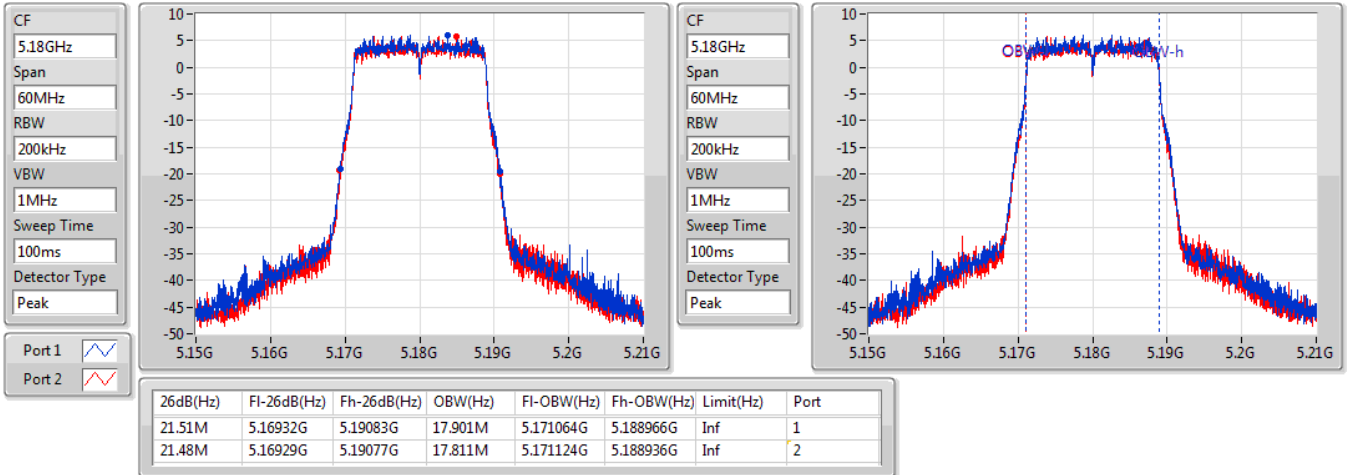

802.11ac VHT20_Nss2,(MCS0)_2TX

EBW

5200MHz

16/02/2020

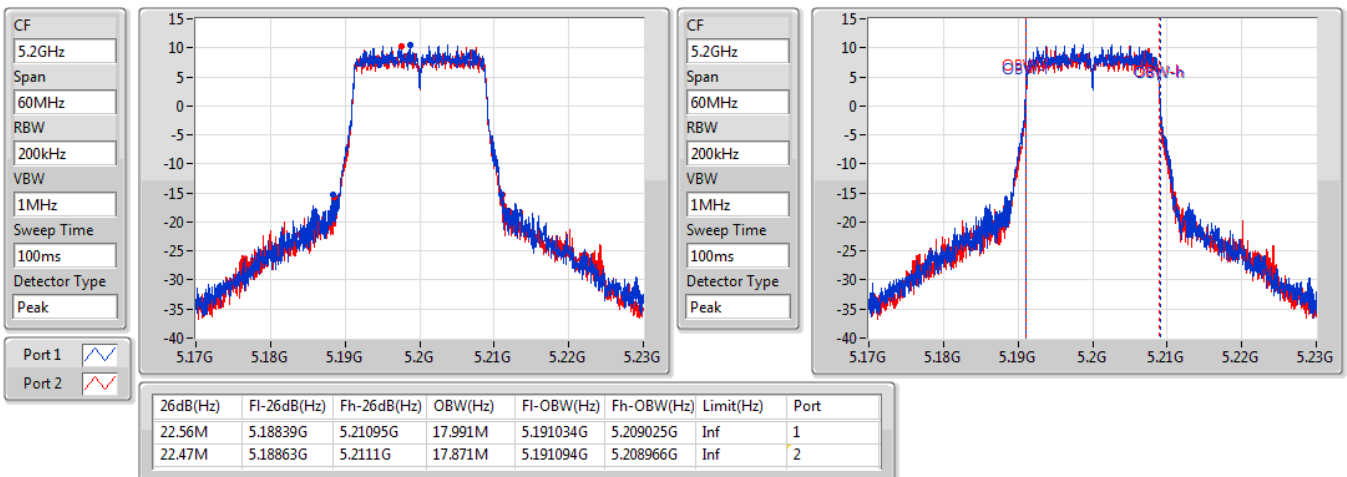

802.11ac VHT20_Nss2,(MCS0)_2TX

EBW

5240MHz

16/02/2020

CF
5.24GHz
Span
60MHz
RBW
200kHz
VBW
1MHz
Sweep Time
100ms
Detector Type
Peak

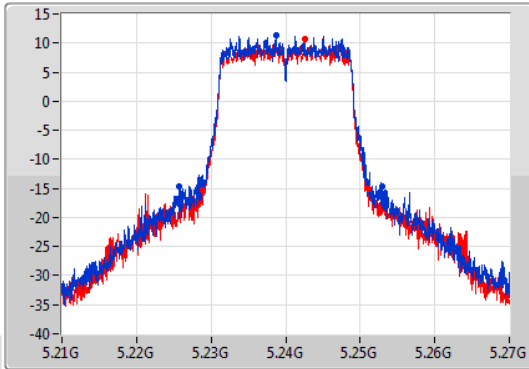

CF
5.24GHz
Span
60MHz
RBW
200kHz
VBW
1MHz
Sweep Time
100ms
Detector Type
Peak

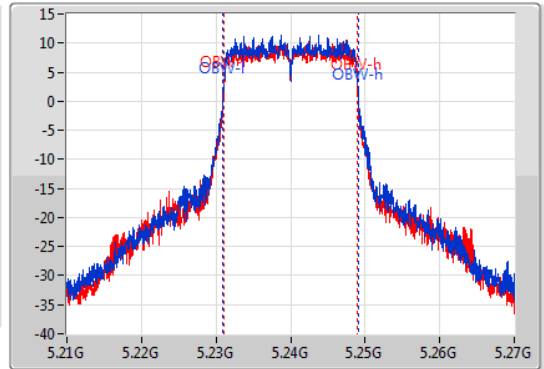

6dB(Hz)	Fl-26dB(Hz)	Fh-26dB(Hz)	OBW(Hz)	Fl-OBW(Hz)	Fh-OBW(Hz)	Limit(Hz)	Port
27.27M	5.22566G	5.25293G	18.111M	5.230975G	5.249085G	Inf	1
22.2M	5.22896G	5.25116G	17.961M	5.231034G	5.248996G	Inf	2

802.11ac VHT20_Nss2,(MCS0)_2TX

EBW

5745MHz

16/02/2020

CF
5.745GHz
Span
60MHz
RBW
100kHz
VBW
300kHz
Sweep Time
100ms
Detector Type
Peak

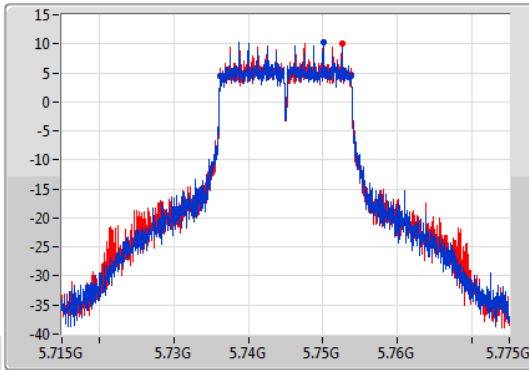

CF
5.745GHz
Span
60MHz
RBW
200kHz
VBW
1MHz
Sweep Time
100ms
Detector Type
Peak

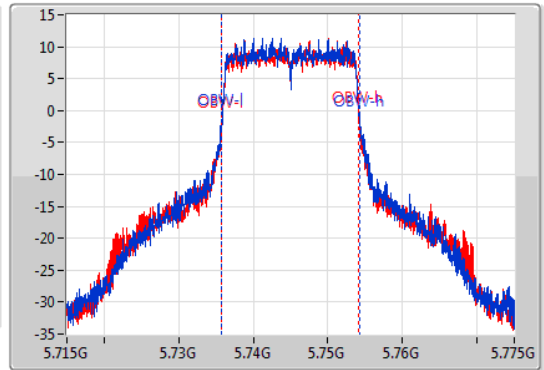

6dB(Hz)	Fl-6dB(Hz)	Fh-6dB(Hz)	OBW(Hz)	Fl-OBW(Hz)	Fh-OBW(Hz)	Limit(Hz)	Port
17.58M	5.73624G	5.75382G	18.561M	5.735735G	5.754295G	500k	1
17.58M	5.73624G	5.75382G	18.351M	5.735795G	5.754145G	500k	2

802.11ac VHT20_Nss2,(MCS0)_2TX

EBW

5785MHz

16/02/2020

CF
5.785GHz
Span
60MHz
RBW
100kHz
VBW
300kHz
Sweep Time
100ms
Detector Type
Peak

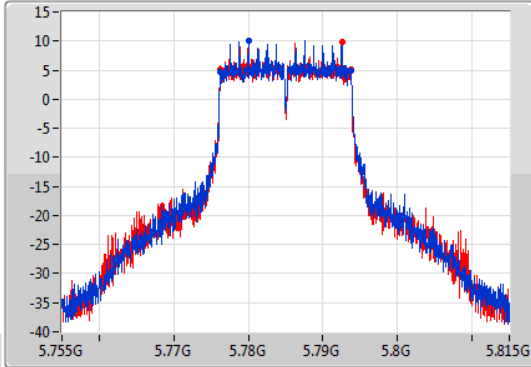

CF
5.785GHz
Span
60MHz
RBW
200kHz
VBW
1MHz
Sweep Time
100ms
Detector Type
Peak

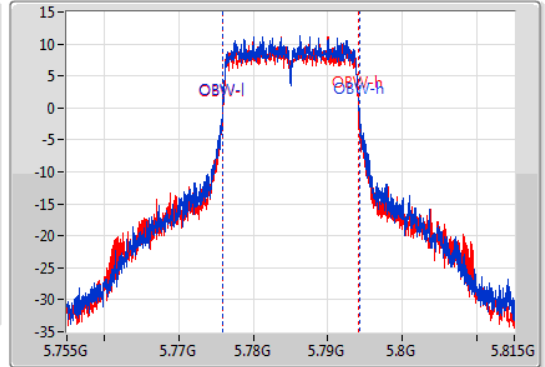

6dB(Hz)	Fl-6dB(Hz)	Fh-6dB(Hz)	OBW(Hz)	Fl-OBW(Hz)	Fh-OBW(Hz)	Limit(Hz)	Port
17.58M	5.77624G	5.79382G	18.411M	5.775825G	5.794235G	500k	1
17.58M	5.77624G	5.79382G	18.201M	5.775885G	5.794085G	500k	2

802.11ac VHT20_Nss2,(MCS0)_2TX

EBW

5825MHz

16/02/2020

CF
5.825GHz
Span
60MHz
RBW
100kHz
VBW
300kHz
Sweep Time
100ms
Detector Type
Peak

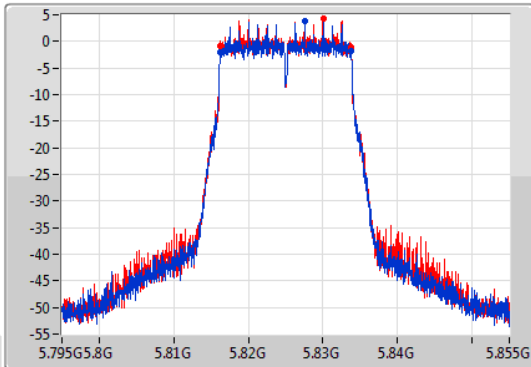

CF
5.825GHz
Span
60MHz
RBW
200kHz
VBW
1MHz
Sweep Time
100ms
Detector Type
Peak

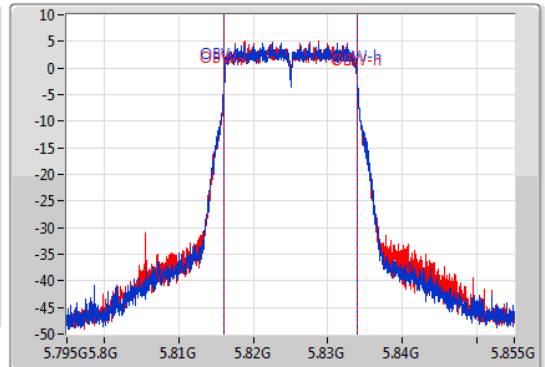

6dB(Hz)	Fl-6dB(Hz)	Fh-6dB(Hz)	OBW(Hz)	Fl-OBW(Hz)	Fh-OBW(Hz)	Limit(Hz)	Port
17.58M	5.81624G	5.83382G	17.871M	5.816094G	5.833966G	500k	1
17.58M	5.81624G	5.83382G	17.811M	5.816124G	5.833936G	500k	2

802.11ac VHT40_Nss2,(MCS0)_2TX

EBW

5190MHz

16/02/2020

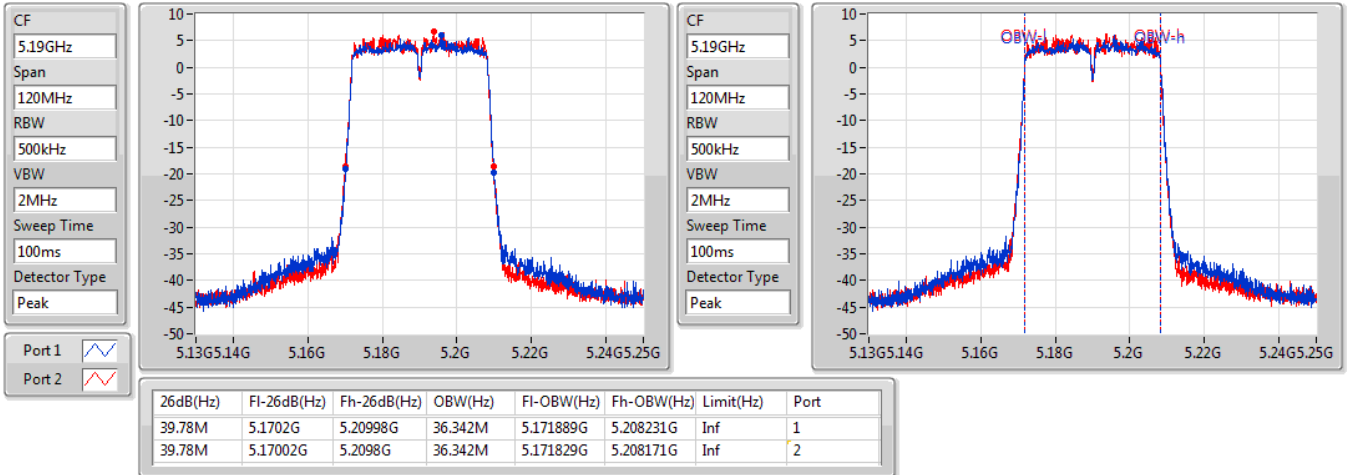

802.11ac VHT40_Nss2,(MCS0)_2TX

EBW

5230MHz

16/02/2020

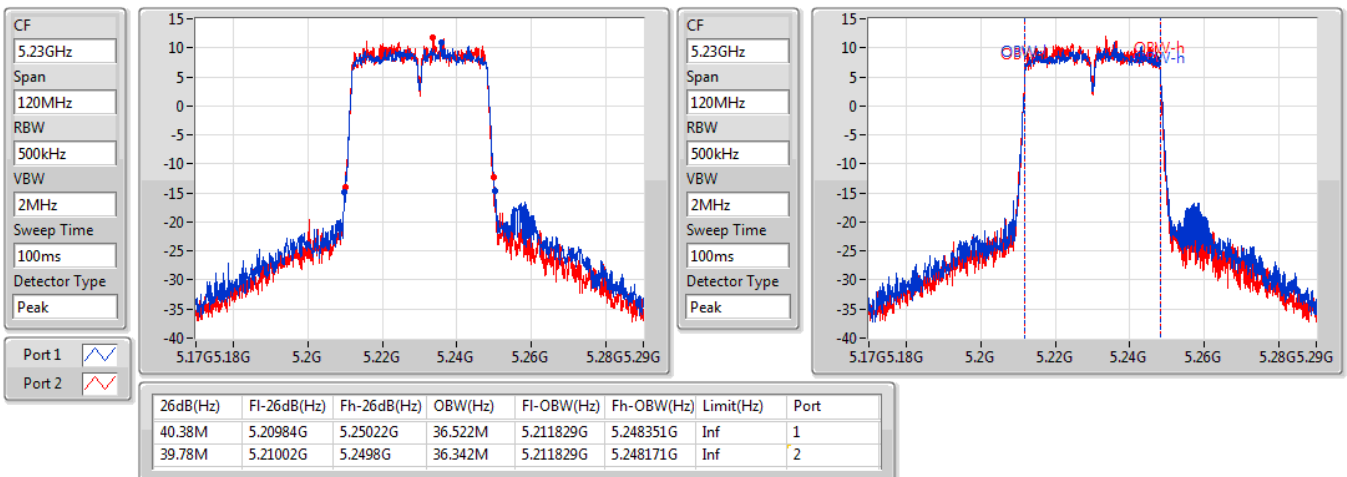

802.11ac VHT40_Nss2,(MCS0)_2TX

EBW

5755MHz

16/02/2020

CF
5.755GHz
Span
120MHz
RBW
100kHz
VBW
300kHz
Sweep Time
100ms
Detector Type
Peak

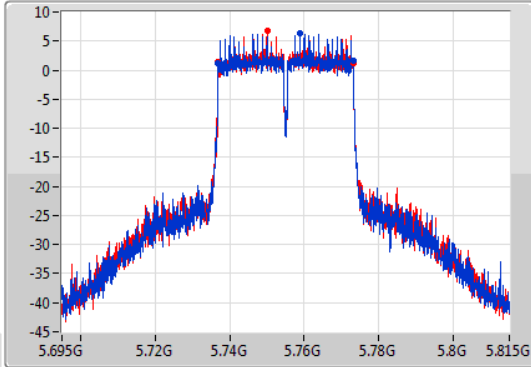

CF
5.755GHz
Span
120MHz
RBW
500kHz
VBW
2MHz
Sweep Time
100ms
Detector Type
Peak

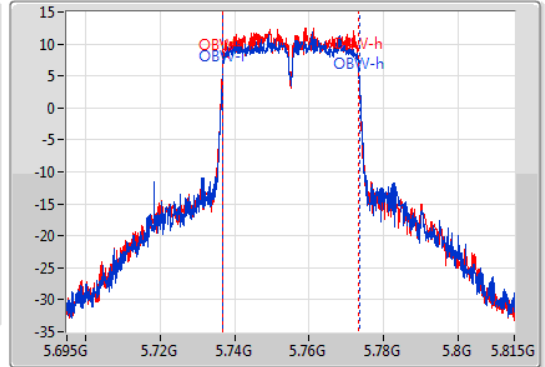

6dB(Hz)	Fl-6dB(Hz)	Fh-6dB(Hz)	OBW(Hz)	Fl-OBW(Hz)	Fh-OBW(Hz)	Limit(Hz)	Port
36.3M	5.73688G	5.77318G	36.822M	5.736709G	5.773531G	500k	1
36.3M	5.73688G	5.77318G	36.582M	5.736709G	5.773291G	500k	2

802.11ac VHT40_Nss2,(MCS0)_2TX

EBW

5795MHz

16/02/2020

CF
5.795GHz
Span
120MHz
RBW
100kHz
VBW
300kHz
Sweep Time
100ms
Detector Type
Peak

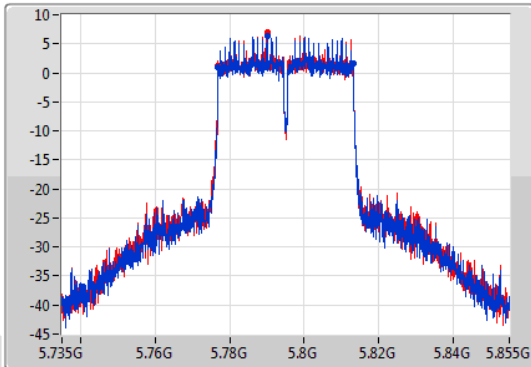

CF
5.795GHz
Span
120MHz
RBW
500kHz
VBW
2MHz
Sweep Time
100ms
Detector Type
Peak

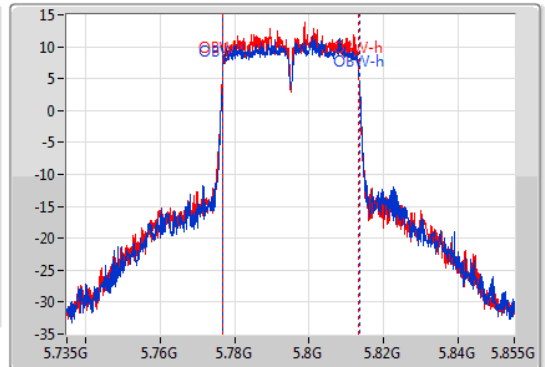

6dB(Hz)	Fl-6dB(Hz)	Fh-6dB(Hz)	OBW(Hz)	Fl-OBW(Hz)	Fh-OBW(Hz)	Limit(Hz)	Port
36.3M	5.77688G	5.81318G	36.762M	5.776769G	5.813531G	500k	1
36.3M	5.77688G	5.81318G	36.522M	5.776769G	5.813291G	500k	2