

## FCC Test Report (DFS Band)

**Report No.:** RF160922E02F-4

**FCC ID:** QXO-7602

**Test Model:** AP-7602

**Received Date:** Sep. 22, 2016

**Test Date:** Nov. 09 to 16, 2016

**Issued Date:** Sep. 11, 2017

**Applicant:** Extreme Networks, Inc.

**Address:** 6480 Via Del Oro, San Jose, CA 95119

**Issued By:** Bureau Veritas Consumer Products Services (H.K.) Ltd., Taoyuan Branch  
Hsin Chu Laboratory

**Lab Address:** E-2, No.1, Li Hsin 1st Road, Hsinchu Science Park, Hsinchu City 300,  
Taiwan R.O.C.

**Test Location (1):** E-2, No.1, Li Hsin 1st Road, Hsinchu Science Park, Hsinchu City 300,  
Taiwan R.O.C.

**Test Location (2):** No. 49, Ln. 206, Wende Rd., Shangshan Tsuen, Chiung Lin Hsiang, Hsin  
Chu Hsien 307, Taiwan R.O.C.



This report is for your exclusive use. Any copying or replication of this report to or for any other person or entity, or use of our name or trademark, is permitted only with our prior written permission. This report sets forth our findings solely with respect to the test samples identified herein. The results set forth in this report are not indicative or representative of the quality or characteristics of the lot from which a test sample was taken or any similar or identical product unless specifically and expressly noted. Our report includes all of the tests requested by you and the results thereof based upon the information that you provided to us. You have 60 days from date of issuance of this report to notify us of any material error or omission caused by our negligence, provided, however, that such notice shall be in writing and shall specifically address the issue you wish to raise. A failure to raise such issue within the prescribed time shall constitute your unqualified acceptance of the completeness of this report, the tests conducted and the correctness of the report contents. Unless specific mention, the uncertainty of measurement has been explicitly taken into account to declare the compliance or non-compliance to the specification. The report must not be used by the client to claim product certification, approval, or endorsement by TAF or any government agencies.

## Table of Contents

<b>Release Control Record</b> .....	<b>4</b>
<b>1 Certificate of Conformity</b> .....	<b>5</b>
<b>2 Summary of Test Results</b> .....	<b>6</b>
2.1 Measurement Uncertainty .....	6
2.2 Modification Record .....	6
<b>3 General Information</b> .....	<b>7</b>
3.1 General Description of EUT (DFS Band) .....	7
3.2 Description of Test Modes .....	10
3.2.1 Test Mode Applicability and Tested Channel Detail .....	11
3.3 Duty Cycle of Test Signal .....	13
3.4 Description of Support Units .....	14
3.4.1 Configuration of System under Test .....	15
3.5 General Description of Applied Standard .....	17
<b>4 Test Types and Results</b> .....	<b>18</b>
4.1 Radiated Emission and Bandedge Measurement .....	18
4.1.1 Limits of Radiated Emission and Bandedge Measurement .....	18
4.1.2 Test Instruments .....	19
4.1.3 Test Procedure .....	21
4.1.4 Deviation from Test Standard .....	21
4.1.5 Test Setup .....	22
4.1.6 EUT Operating Condition .....	23
4.1.7 Test Results .....	24
4.2 Conducted Emission Measurement .....	72
4.2.1 Limits of Conducted Emission Measurement .....	72
4.2.2 Test Instruments .....	72
4.2.3 Test Procedure .....	73
4.2.4 Deviation from Test Standard .....	73
4.2.5 Test Setup .....	73
4.2.6 EUT Operating Condition .....	73
4.2.7 Test Results (Mode 1) .....	74
4.2.8 Test Results (Mode 2) .....	76
4.3 Transmit Power Measurement .....	78
4.3.1 Limits of Transmit Power Measurement .....	78
4.3.2 Test Setup .....	79
4.3.3 Test Instruments .....	79
4.3.4 Test Procedure .....	80
4.3.5 Deviation from Test Standard .....	80
4.3.6 EUT Operating Condition .....	80
4.3.7 Test Result .....	81
4.4 Occupied Bandwidth Measurement .....	98
4.4.1 Test Setup .....	98
4.4.2 Test Instruments .....	98
4.4.3 Test Procedure .....	98
4.4.4 Test Results .....	99
4.5 Peak Power Spectral Density Measurement .....	102
4.5.1 Limits of Peak Power Spectral Density Measurement .....	102
4.5.2 Test Setup .....	102
4.5.3 Test Instruments .....	102
4.5.4 Test Procedure .....	103
4.5.5 Deviation from Test Standard .....	103
4.5.6 EUT Operating Condition .....	103
4.5.7 Test Results .....	104
4.6 Frequency Stability Measurement .....	109

4.6.1	Limits of Frequency Stability Measurement .....	109
4.6.2	Test Setup.....	109
4.6.3	Test Instruments .....	109
4.6.4	Test Procedure .....	109
4.6.5	Deviation from Test Standard .....	109
4.6.6	EUT Operating Condition .....	109
4.6.7	Test Results .....	110
4.7	6dB Bandwidth Measurement .....	111
4.7.1	Limits of 6dB Bandwidth Measurement.....	111
4.7.2	Test Setup.....	111
4.7.3	Test Instruments .....	111
4.7.4	Test Procedure .....	111
4.7.5	Deviation from Test Standard .....	111
4.7.6	EUT Operating Condition .....	111
4.7.7	Test Results .....	112
<b>5</b>	<b>Pictures of Test Arrangements.....</b>	<b>114</b>
	<b>Appendix – Information on the Testing Laboratories .....</b>	<b>115</b>

### Release Control Record

Issue No.	Description	Date Issued
RF160922E02F-4	Original release.	Sep. 11, 2017

## 1 Certificate of Conformity

**Product:** Access Point

**Brand:** Extreme

**Test Model:** AP-7602

**Sample Status:** ENGINEERING SAMPLE

**Applicant:** Extreme Networks, Inc.

**Test Date:** Nov. 09 to 16, 2016

**Standard:** 47 CFR FCC Part 15, Subpart E (Section 15.407)  
ANSI C63.10: 2013

The above equipment has been tested by **Bureau Veritas Consumer Products Services (H.K.) Ltd., Taoyuan Branch**, and found compliance with the requirement of the above standards. The test record, data evaluation & Equipment Under Test (EUT) configurations represented herein are true and accurate accounts of the measurements of the sample's EMC characteristics under the conditions specified in this report.

**Prepared by :** Wendy Wu , **Date:** Sep. 11, 2017  
Wendy Wu / Specialist

**Approved by :** May Chen , **Date:** Sep. 11, 2017  
May Chen / Manager

## 2 Summary of Test Results

47 CFR FCC Part 15, Subpart E (Section 15.407)			
FCC Clause	Test Item	Result	Remarks
15.407(b)(6)	AC Power Conducted Emissions	Pass	Meet the requirement of limit. Minimum passing margin is -15.07dB at 0.40781MHz.
15.407(b) (1/2/3/4(i/ii)/6)	Radiated Emissions & Band Edge Measurement	Pass	Meet the requirement of limit. Minimum passing margin is -1.1dB at 5350.00MHz, 5470.00MHz, 5725.00MHz.
15.407(a)(1/2/3)	Max Average Transmit Power	Pass	Meet the requirement of limit.
---	Occupied Bandwidth Measurement	-	Reference only.
15.407(a)(1/2/3)	Peak Power Spectral Density	Pass	Meet the requirement of limit.
15.407(e)	6dB bandwidth	Pass	Meet the requirement of limit. (U-NII-3 Band only)
15.407(g)	Frequency Stability	Pass	Meet the requirement of limit.
15.203	Antenna Requirement	Pass	Antenna connector is i-pex(MHF) not a standard connector.

### 2.1 Measurement Uncertainty

Where relevant, the following measurement uncertainty levels have been estimated for tests performed on the EUT as specified in CISPR 16-4-2:

Measurement	Frequency	Expanded Uncertainty (k=2) ( $\pm$ )
Conducted Emissions at mains ports	150kHz ~ 30MHz	1.83 dB
Radiated Emissions up to 1 GHz	30MHz ~ 1GHz	5.43 dB
Radiated Emissions above 1 GHz	1GHz ~ 6GHz	3.41 dB
	6GHz ~ 18GHz	4.49 dB
	18GHz ~ 40GHz	3.30 dB

### 2.2 Modification Record

There were no modifications required for compliance.

### 3 General Information

#### 3.1 General Description of EUT (DFS Band)

Product	Access Point
Brand	Extreme
Test Model	AP-7602
Status of EUT	ENGINEERING SAMPLE
SW Version	esdk 5.0.9.1
HW Version	Extreme_ASPEN-W_BCM47452_v21_d2_20160803_Sandy.brd
Power Supply Rating	12Vdc from power adapter or 55Vdc from POE
Modulation Type	CCK, DQPSK, DBPSK for DSSS 64QAM, 16QAM, QPSK, BPSK for OFDM 256QAM for OFDM in 11ac mode and VHT20/40 mode in 2.4GHz band
Modulation Technology	DSSS, OFDM
Transfer Rate	802.11b: up to 11Mbps 802.11a/g: up to 54Mbps 802.11n: up to 300Mbps 802.11ac: up to 866.7Mbps
Operating Frequency	<b>2.4GHz:</b> 2.412 ~ 2.462GHz <b>5GHz:</b> 5.18 ~ 5.24GHz, 5.26 ~ 5.32GHz, 5.50 ~ 5.72GHz, 5.745 ~ 5.825GHz
Number of Channel	<b>2.4GHz:</b> 802.11b, 802.11g, 802.11n (HT20), VHT20: 11 802.11n (HT40), VHT40: 7 <b>5GHz:</b> 802.11a, 802.11n (HT20), 802.11ac (VHT20): 25 802.11n (HT40), 802.11ac (VHT40): 12 802.11ac (VHT80): 6
Output Power	<b>2.4GHz:</b> <b>CDD Mode:</b> 183.039mW <b>Beamforming Mode:</b> 105.547mW <b>5GHz:</b> <b>5.18GHz ~ 5.24GHz:</b> <b>CDD Mode:</b> 194.249mW <b>Beamforming Mode:</b> 189.641mW <b>5.26GHz ~ 5.32GHz:</b> <b>CDD Mode:</b> 185.704mW <b>Beamforming Mode:</b> 182.995mW <b>5.50GHz ~ 5.72GHz:</b> <b>CDD Mode:</b> 162.102mW <b>Beamforming Mode:</b> 162.102mW <b>5.745GHz ~ 5.825GHz:</b> <b>CDD Mode:</b> 260.394mW <b>Beamforming Mode:</b> 260.394mW
Antenna Type	Refer to Note

Antenna Connector	Refer to Note
Accessory Device	NA
Data Cable Supplied	NA

Note:

1. There are WLAN, BT technology used for the EUT.
2. Simultaneously transmission condition.

Condition	Technology		
1	WLAN (2.4GHz-Chain0)	WLAN (5GHz-Chain1)	BT
2	WLAN (2.4GHz-Chain1)	WLAN (5GHz-Chain0)	BT
3	WLAN (2.4GHz-Chain0)	WLAN (2.4GHz-Chain1)	BT
4	WLAN (5GHz-Chain0)	WLAN (5GHz-Chain1)	BT

**Note:** The emission of the simultaneous operation has been evaluated and no non-compliance was found.

3. The EUT must be supplied with a power adapter and POE as following table:

Adapter (Only for test not for sale)		
Brand	Model No.	Spec.
HIPRO	HP-A0502R3D	Input: 100-240Vac, 50-60Hz, 2.4A Output: 12Vdc, 4.16A DC output cable (Unshielded, 1.8m with one core)
POE(Only for test not for sale)		
Brand	Model No.	Spec.
Symbol	PD-9001GR/AT/AC	Input: 100-240Vac, 50/60Hz, 0.67A Output: 55Vdc, 0.6A P/N : AP-PSBIAS-2P3-ATR

From above adapter and POE, the radiated emission worst case was found in **Adapter**. Therefore only the test data of the modes were recorded in this report individually.

4. The antennas provided to the EUT, please refer to the following table:

No.	PCB Chain No	Brand	Model	Antenna Gain(dBi) Including cable loss	Frequency range	Antenna Type	Connector type	Cable Length (mm)
1	Chain 0	NA	NA	2.61	2.4~2.4835GHz	Dipole	i-pex(MHF)	155
				4.39	5.15~5.25GHz			
				4.2	5.25~5.35GHz			
				4.28	5.47~5.725GHz			
				5.61	5.725~5.85GHz			
2	Chain 1	NA	NA	3.76	2.4~2.4835GHz	Dipole	i-pex(MHF)	182
				5.18	5.15~5.25GHz			
				5.22	5.25~5.35GHz			
				4.44	5.47~5.725GHz			
				5.95	5.725~5.85GHz			
3	BT	NA	NA	1.8	2.4~2.483GHz	Dipole	i-pex(MHF)	88



5. The EUT incorporates a MIMO function:

5GHz Band			
MODULATION MODE	DATA RATE (MCS)	TX & RX CONFIGURATION	
802.11a	6 ~ 54Mbps	2TX/1TX diversity	2RX
802.11n (HT20)	MCS 0~7	2TX/1TX diversity	2RX
	MCS 8~15	2TX	2RX
802.11n (HT40)	MCS 0~7	2TX/1TX diversity	2RX
	MCS 8~15	2TX	2RX
802.11ac (VHT20)	MCS 0~8, Nss=1	2TX/1TX diversity	2RX
	MCS 0~8, Nss=2	2TX	2RX
802.11ac (VHT40)	MCS 0~9, Nss=1	2TX/1TX diversity	2RX
	MCS 0~9, Nss=2	2TX	2RX
802.11ac (VHT80)	MCS 0~9, Nss=1	2TX/1TX diversity	2RX
	MCS 0~9, Nss=2	2TX	2RX

Note:

1. All of modulation mode support beamforming function except 802.11a/b/g modulation mode.
2. The modulation and bandwidth are similar for 802.11n mode for 20MHz (40MHz) and 802.11ac mode for 20MHz (40MHz), therefore investigated worst case to representative mode in test report. (Final test mode refer section 3.2.1)
3. The EUT support diversity parameter for 1TX mode, the 1TX output power will remain the same as per chain of 2TX parameter, and all test items were performed by 2TX mode.

6. The above EUT information is declared by manufacturer and for more detailed features description, please refer to the manufacturer's specifications or user's manual.

### 3.2 Description of Test Modes

#### FOR 5260 ~ 5320MHz

4 channels are provided for 802.11a, 802.11n (HT20), 802.11ac (VHT20):

Channel	Frequency	Channel	Frequency
52	5260 MHz	60	5300 MHz
56	5280 MHz	64	5320 MHz

2 channels are provided for 802.11n (HT40), 802.11ac (VHT40):

Channel	Frequency	Channel	Frequency
54	5270 MHz	62	5310 MHz

1 channel is provided for 802.11ac (VHT80):

Channel	Frequency
58	5290 MHz

#### FOR 5500 ~ 5720MHz

12 channels are provided for 802.11a, 802.11n (HT20), 802.11ac (VHT20):

Channel	Frequency	Channel	Frequency
100	5500 MHz	124	5620 MHz
104	5520 MHz	128	5640 MHz
108	5540 MHz	132	5660 MHz
112	5560 MHz	136	5680 MHz
116	5580 MHz	140	5700 MHz
120	5600 MHz	144	5720 MHz

6 channels are provided for 802.11n (HT40), 802.11ac (VHT40):

Channel	Frequency	Channel	Frequency
102	5510 MHz	126	5630 MHz
110	5550 MHz	134	5670 MHz
118	5590 MHz	142	5710 MHz

3 channels are provided for 802.11ac (VHT80):

Channel	Frequency	Channel	Frequency
106	5530 MHz	138	5690 MHz
122	5610 MHz		

### 3.2.1 Test Mode Applicability and Tested Channel Detail

EUT Configure Mode	Applicable To				Description
	RE $\geq$ 1G	RE<1G	PLC	APCM	
1	√	√	√	√	Power from adapter
2	-	-	√	-	Power from POE

Where **RE $\geq$ 1G**: Radiated Emission above 1GHz      **RE<1G**: Radiated Emission below 1GHz  
**PLC**: Power Line Conducted Emission      **APCM**: Antenna Port Conducted Measurement

**NOTE:**

1. The EUT had been pre-tested on the positioned of each 2 axis. The worst case was found when positioned on **Y-plane**.
2. "-" means no effect.

#### **Radiated Emission Test (Above 1GHz):**

- Pre-Scan has been conducted to determine the worst-case mode from all possible combinations between available modulations, data rates and antenna ports (if EUT with antenna diversity architecture).
- Following channel(s) was (were) selected for the final test as listed below.

CDD Mode						
Mode	FREQ. Band (MHz)	Available Channel	Tested Channel	Modulation Technology	Modulation Type	Data Rate (Mbps)
802.11a	5260-5320	52 to 64	52, 60, 64	OFDM	BPSK	6
802.11ac (VHT20)		52 to 64	52, 60, 64	OFDM	BPSK	6.5
802.11ac (VHT40)		54 to 62	54, 62	OFDM	BPSK	13.5
802.11ac (VHT80)		58	58	OFDM	BPSK	29.3
802.11a	5500-5720	100 to 144	100, 116, 140, 144	OFDM	BPSK	6
802.11ac (VHT20)		100 to 144	100, 116, 140, 144	OFDM	BPSK	6.5
802.11ac (VHT40)		102 to 142	102, 110, 134, 142	OFDM	BPSK	13.5
802.11ac (VHT80)		106 to 138	106, 122, 138	OFDM	BPSK	29.3

#### **Radiated Emission Test (Below 1GHz):**

- Pre-Scan has been conducted to determine the worst-case mode from all possible combinations between available modulations, data rates and antenna ports (if EUT with antenna diversity architecture).
- Following channel(s) was (were) selected for the final test as listed below.

CDD Mode						
Mode	FREQ. Band (MHz)	Available Channel	Tested Channel	Modulation Technology	Modulation Type	Data Rate (Mbps)
802.11a	5260-5320	52 to 64	52, 60, 64	OFDM	BPSK	6
802.11ac (VHT20)		52 to 64	52, 60, 64	OFDM	BPSK	6.5
802.11ac (VHT40)		54 to 62	54, 62	OFDM	BPSK	13.5
802.11ac (VHT80)		58	58	OFDM	BPSK	29.3
802.11a	5500-5720	100 to 144	100, 116, 140, 144	OFDM	BPSK	6
802.11ac (VHT20)		100 to 144	100, 116, 140, 144	OFDM	BPSK	6.5
802.11ac (VHT40)		102 to 142	102, 110, 134, 142	OFDM	BPSK	13.5
802.11ac (VHT80)		106 to 138	106, 122, 138	OFDM	BPSK	29.3

### Power Line Conducted Emission Test:

- Pre-Scan has been conducted to determine the worst-case mode from all possible combinations between available modulations, data rates and antenna ports (if EUT with antenna diversity architecture).
- Following channel(s) was (were) selected for the final test as listed below.

CDD Mode						
Mode	FREQ. Band (MHz)	Available Channel	Tested Channel	Modulation Technology	Modulation Type	Data Rate (Mbps)
802.11ac (VHT20)	5260-5320	52 to 64	116	OFDM	BPSK	6.5

### Antenna Port Conducted Measurement:

- This item includes all test value of each mode, but only includes spectrum plot of worst value of each mode.
- Pre-Scan has been conducted to determine the worst-case mode from all possible combinations between available modulations, data rates and antenna ports (if EUT with antenna diversity architecture).
- Following channel(s) was (were) selected for the final test as listed below.

CDD Mode						
Mode	FREQ. Band (MHz)	Available Channel	Tested Channel	Modulation Technology	Modulation Type	Data Rate (Mbps)
802.11a	5260-5320	52 to 64	52, 60, 64	OFDM	BPSK	6
802.11ac (VHT20)		52 to 64	52, 60, 64	OFDM	BPSK	6.5
802.11ac (VHT40)		54 to 62	54, 62	OFDM	BPSK	13.5
802.11ac (VHT80)		58	58	OFDM	BPSK	29.3
802.11a	5500-572	100 to 144	100, 116, 140, 144	OFDM	BPSK	6
802.11ac (VHT20)		100 to 144	100, 116, 140, 144	OFDM	BPSK	6.5
802.11ac (VHT40)		102 to 142	102, 110, 134, 142	OFDM	BPSK	13.5
802.11ac (VHT80)		106 to 138	106, 122, 138	OFDM	BPSK	29.3
Beamforming Mode (Output power only)						
Mode	FREQ. Band (MHz)	Available Channel	Tested Channel	Modulation Technology	Modulation Type	Data Rate (Mbps)
802.11ac (VHT20)	5260-5320	52 to 64	52, 60, 64	OFDM	BPSK	6.5
802.11ac (VHT40)		54 to 62	54, 62	OFDM	BPSK	13.5
802.11ac (VHT80)		58	58	OFDM	BPSK	29.3
802.11ac (VHT20)	5500-5720	100 to 144	100, 116, 140, 144	OFDM	BPSK	6.5
802.11ac (VHT40)		102 to 142	102, 110, 134, 142	OFDM	BPSK	13.5
802.11ac (VHT80)		106 to 138	106, 122, 138	OFDM	BPSK	29.3

### Test Condition:

Applicable To	Environmental Conditions	Input Power	Tested By
RE $\geq$ 1G	25deg. C, 72%RH	120Vac, 60Hz	Terry Huang
RE $<$ 1G	24deg. C, 66%RH	120Vac, 60Hz	Jyunchun Lin
PLC	25deg. C, 60%RH	120Vac, 60Hz	Eagle Chen
APCM	25deg. C, 60%RH	120Vac, 60Hz	Gary Cheng

### 3.3 Duty Cycle of Test Signal

If duty cycle of test signal is  $\geq 98\%$ , duty factor is not required.

If duty cycle of test signal is  $< 98\%$ , duty factor shall be considered.

**802.11a:** Duty cycle =  $2.062 \text{ ms} / 2.084 \text{ ms} = 0.989$

**802.11ac (VHT20):** Duty cycle =  $1.927 \text{ ms} / 1.946 \text{ ms} = 0.99$

**802.11ac (VHT40):** Duty cycle =  $0.952 \text{ ms} / 0.953 \text{ ms} = 0.999$

**802.11ac (VHT80):** Duty cycle =  $0.46 \text{ ms} / 0.48 \text{ ms} = 0.958$ , Duty factor =  $10 * \log(1/0.958) = 0.18$

**802.11a**

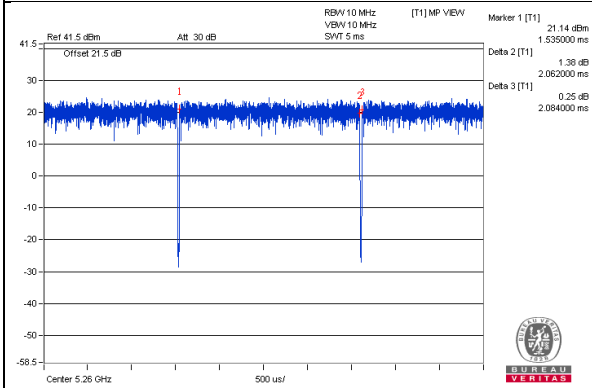

**802.11ac (VHT20)**

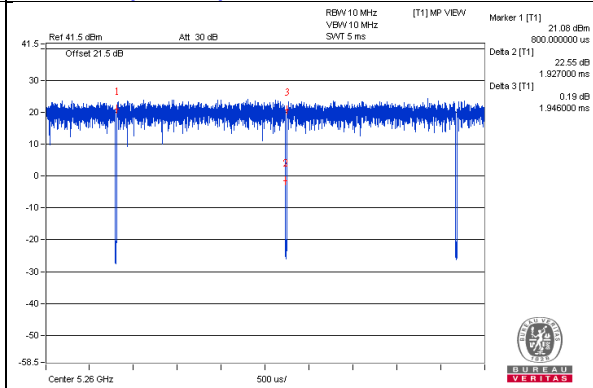

**802.11ac (VHT40)**

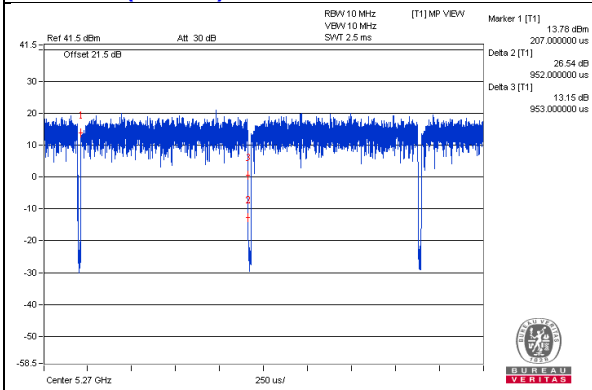

**802.11ac (VHT80)**

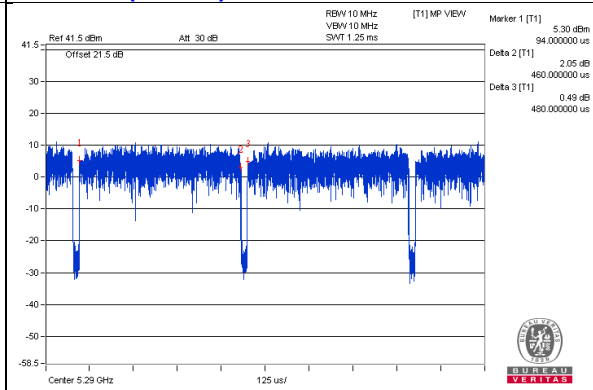

### 3.4 Description of Support Units

The EUT has been tested as an independent unit together with other necessary accessories or support units. The following support units or accessories were used to form a representative test configuration during the tests.

ID	Product	Brand	Model No.	Serial No.	FCC ID	Remarks
A.	Laptop	DELL	E5430	HYV4VY1	FCC DoC	Provided by Lab
B.	POE	Symbol	PD-9001GR/AT/AC	NA	NA	Supplied by client
C.	HUB	ZyXEL	ES-116P	S060H02000215	FCC DoC	Provided by Lab
D.	Adapter	HIPRO	HP-A0502R3D	NA	NA	Supplied by client

Note:

1. All power cords of the above support units are non-shielded (1.8m).

ID	Descriptions	Qty.	Length (m)	Shielding (Yes/No)	Cores (Qty.)	Remarks
1.	RJ-45 Cable	1	10	No	0	Provided by Lab
2.	RJ-45 Cable	1	10	No	0	Provided by Lab
3.	RJ-45 Cable	1	1	No	0	Provided by Lab
4.	DC Cable	1	1.8	No	1	Supplied by client
5.	AC Cable	1	1.8	No	0	Provided by Lab

Note: The core(s) is(are) originally attached to the cable(s).

### 3.4.1 Configuration of System under Test

Adapter Mode:

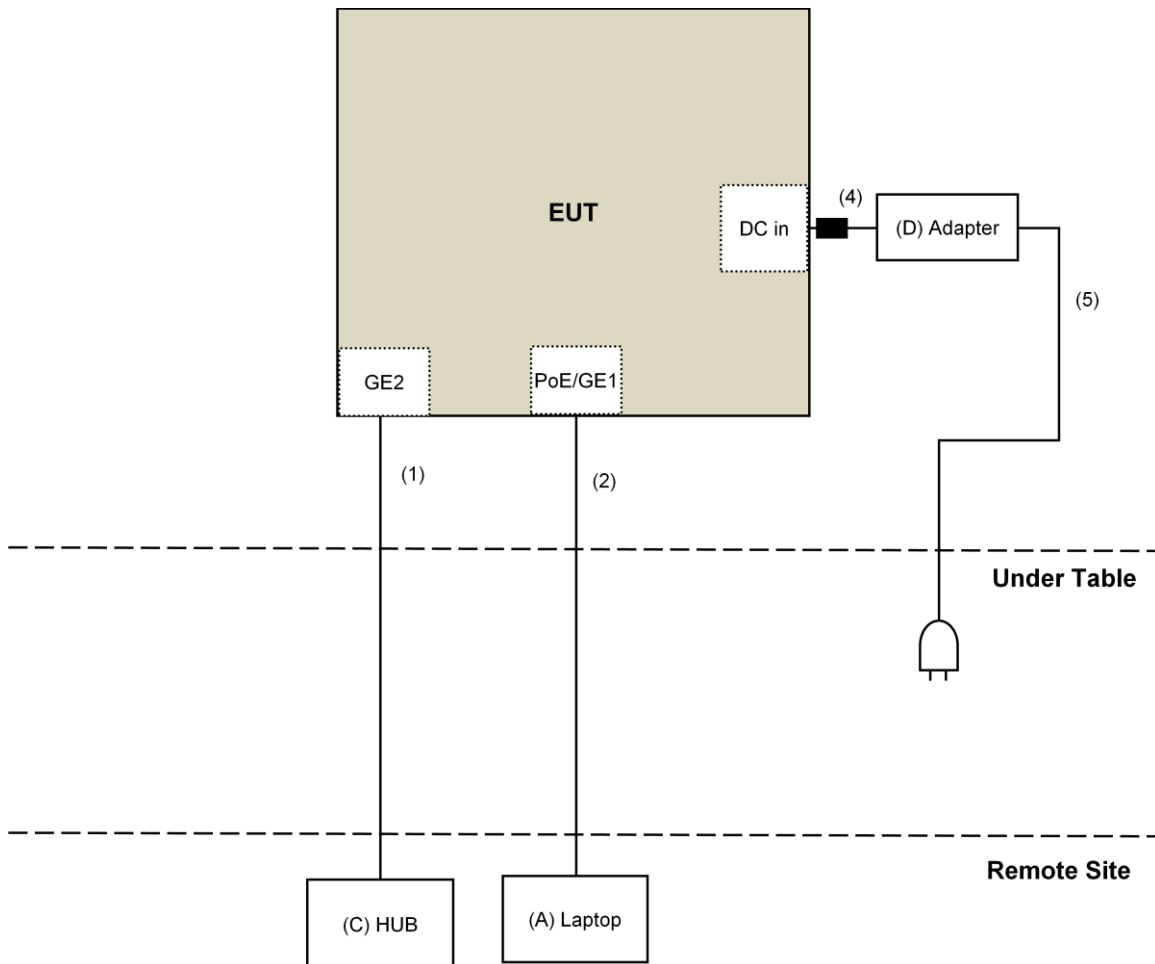

POE Mode

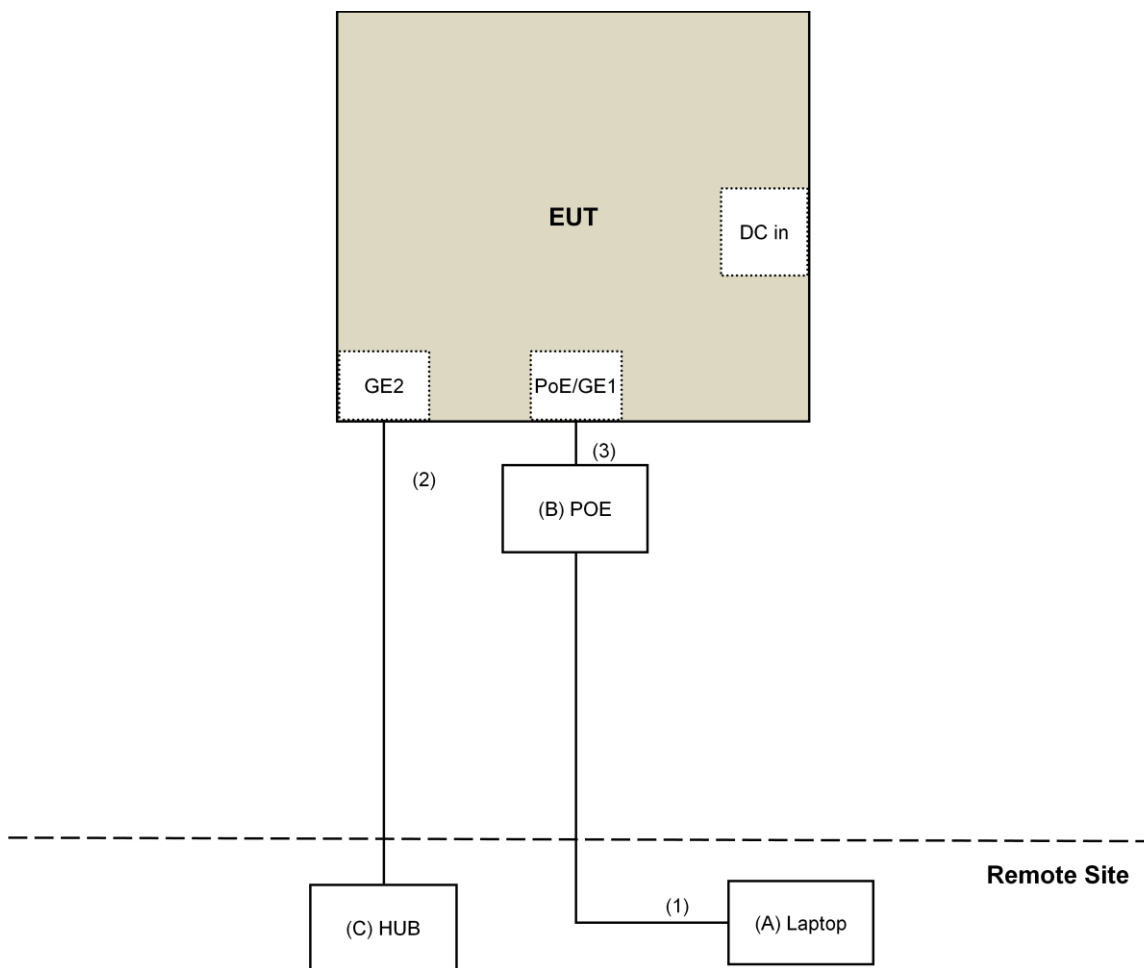



### 3.5 General Description of Applied Standard

The EUT is a RF Product. According to the specifications of the manufacturer, it must comply with the requirements of the following standards:

**FCC Part 15, Subpart E (15.407)**  
**KDB 789033 D02 General UNII Test Procedure New Rules v01r03**  
**KDB 662911 D01 Multiple Transmitter Output v02r01**  
**ANSI C63.10-2013**

All test items have been performed and recorded as per the above standards.

**NOTE:** The EUT has been verified to comply with the requirements of FCC Part 15, Subpart B, Class B (DoC). The test report has been issued separately.

## 4 Test Types and Results

### 4.1 Radiated Emission and Bandedge Measurement

#### 4.1.1 Limits of Radiated Emission and Bandedge Measurement

Radiated emissions which fall in the restricted bands must comply with the radiated emission limits specified as below table.

Frequencies (MHz)	Field Strength (microvolts/meter)	Measurement Distance (meters)
0.009 ~ 0.490	2400/F(kHz)	300
0.490 ~ 1.705	24000/F(kHz)	30
1.705 ~ 30.0	30	30
30 ~ 88	100	3
88 ~ 216	150	3
216 ~ 960	200	3
Above 960	500	3

#### NOTE:

1. The lower limit shall apply at the transition frequencies.
2. Emission level (dBuV/m) = 20 log Emission level (uV/m).
3. For frequencies above 1000MHz, the field strength limits are based on average detector, however, the peak field strength of any emission shall not exceed the maximum permitted average limits, specified above by more than 20dB under any condition of modulation.

Limits of unwanted emission out of the restricted bands

Applicable To		Limit	
789033 D02 General UNII Test Procedure New Rules v01r03		Field Strength at 3m	
		PK:74 (dBuV/m)	AV:54 (dBuV/m)
Frequency Band	Applicable To	EIRP Limit	Equivalent Field Strength at 3m
5150~5250 MHz	15.407(b)(1)	PK:-27 (dBm/MHz)	PK:68.2(dBuV/m)
5250~5350 MHz	15.407(b)(2)		
5470~5725 MHz	15.407(b)(3)		
5725~5850 MHz	<input checked="" type="checkbox"/> 15.407(b)(4)(i)	PK:-27 (dBm/MHz) <sup>*1</sup> PK:10 (dBm/MHz) <sup>*2</sup> PK:15.6 (dBm/MHz) <sup>*3</sup> PK:27 (dBm/MHz) <sup>*4</sup>	PK: 68.2(dBuV/m) <sup>*1</sup> PK:105.2 (dBuV/m) <sup>*2</sup> PK: 110.8(dBuV/m) <sup>*3</sup> PK:122.2 (dBuV/m) <sup>*4</sup>
	<input type="checkbox"/> 15.407(b)(4)(ii)	Emission limits in section 15.247(d)	
<sup>*1</sup> beyond 75 MHz or more above of the band edge.		<sup>*2</sup> below the band edge increasing linearly to 10 dBm/MHz at 25 MHz above.	
<sup>*3</sup> below the band edge increasing linearly to a level of 15.6 dBm/MHz at 5 MHz above.		<sup>*4</sup> from 5 MHz above or below the band edge increasing linearly to a level of 27 dBm/MHz at the band edge.	

#### Note:

The following formula is used to convert the equipment isotropic radiated power (eirp) to field strength:

$$E = \frac{1000000\sqrt{30P}}{3} \mu\text{V/m, where } P \text{ is the eirp (Watts).}$$

## 4.1.2 Test Instruments

DESCRIPTION & MANUFACTURER	MODEL NO.	SERIAL NO.	CALIBRATED DATE	CALIBRATED UNTIL
Test Receiver Keysight	N9038A	MY54450088	July 20, 2016	July 19, 2017
Pre-Amplifier <sup>(*)</sup> EMCI	EMC001340	980142	Jan. 20, 2016	Jan. 19, 2018
Loop Antenna <sup>(*)</sup> Electro-Metrics	EM-6879	264	Dec. 16, 2014	Dec. 15, 2016
RF Cable	NA	LOOPCAB-001 LOOPCAB-002	Jan. 18, 2016	Jan. 17, 2017
Pre-Amplifier Mini-Circuits	ZFL-1000VH2B	AMP-ZFL-01	Nov. 10, 2016	Nov. 09, 2017
Trilog Broadband Antenna SCHWARZBECK	VULB 9168	9168-406	Jan. 04, 2016	Jan. 03, 2017
RF Cable	8D	966-4-1 966-4-2 966-4-3	Apr. 02, 2016	Apr. 01, 2017
Fixed attenuator Mini-Circuits	UNAT-5+	PAD-3m-4-01	Oct. 05, 2016	Oct. 04, 2017
Horn_Antenna SCHWARZBECK	BBHA 9120D	9120D-783	Jan. 19, 2016	Jan. 18, 2017
Pre-Amplifier Agilent	8449B	3008A01922	Sep. 18, 2016	Sep. 17, 2017
RF Cable	EMC104-SM-SM-2000 EMC104-SM-SM-5000 EMC104-SM-SM-5000	150318 150323 150324	Mar. 30, 2016	Mar. 29, 2017
Pre-Amplifier EMCI	EMC184045	980143	Jan. 15, 2016	Jan. 14, 2017
Horn_Antenna SCHWARZBECK	BBHA 9170	BBHA9170608	Jan. 08, 2016	Jan. 07, 2017
RF Cable	SUCOFLEX 102	36432/2 36441/2	Jan. 16, 2016	Jan. 15, 2017
Software	ADT_Radiated_V8.7.08	NA	NA	NA
Antenna Tower & Turn Table Max-Full	MF-7802	MF780208410	NA	NA
Boresight Antenna Fixture	FBA-01	FBA-SIP02	NA	NA
Spectrum Analyzer R&S	FSv40	100964	June 28, 2016	June 27, 2017
Power meter Anritsu	ML2495A	1014008	May 5, 2016	May 4, 2017
Power sensor Anritsu	MA2411B	0917122	May 5, 2016	May 4, 2017
AC Power Source Extech Electronics	6205	1440452	NA	NA
Temperature & Humidity Chamber Giant Force	GTH-150-40-SP-AR	MAA0812-008	Jan. 15, 2016	Jan. 14, 2017
Digital Multimeter FLUKE	87III	73680266	Nov. 10, 2016	Nov. 09, 2017

**Note:**

1. The calibration interval of the above test instruments is 12 months and the calibrations are traceable to NML/ROC and NIST/USA.
2. \*The calibration interval of the above test instruments is 24 months and the calibrations are traceable to NML/ROC and NIST/USA.
3. The test was performed in 966 Chamber No. 4.
4. The CANADA Site Registration No. is 20331-2
5. Loop antenna was used for all emissions below 30 MHz.
- 6 Tested Date: Nov. 11 to 15, 2016

#### 4.1.3 Test Procedure

##### **For Radiated emission below 30MHz**

- a. The EUT was placed on the top of a rotating table 0.8 meters above the ground at a 3 meter chamber room. The table was rotated 360 degrees to determine the position of the highest radiation.
- b. The EUT was set 3 meters away from the interference-receiving antenna, which was mounted on the top of a variable-height antenna tower.
- c. Both X and Y axes of the antenna are set to make the measurement.
- d. For each suspected emission, the EUT was arranged to its worst case and the rotatable table was turned from 0 degrees to 360 degrees to find the maximum reading.
- e. The test-receiver system was set to Quasi-Peak Detect Function and Specified Bandwidth with Maximum Hold Mode.

##### **NOTE:**

1. The resolution bandwidth and video bandwidth of test receiver/spectrum analyzer is 9kHz at frequency below 30MHz.

##### **For Radiated emission above 30MHz**

- a. The EUT was placed on the top of a rotating table 0.8 meters (for 30MHz ~ 1GHz) / 1.5 meters (for above 1GHz) above the ground at 3 meter chamber room for test. The table was rotated 360 degrees to determine the position of the highest radiation.
- b. The EUT was set 3 meters away from the interference-receiving antenna, which was mounted on the top of a variable-height antenna tower.
- c. The height of antenna is varied from one meter to four meters above the ground to determine the maximum value of the field strength. Both horizontal and vertical polarizations of the antenna are set to make the measurement.
- d. For each suspected emission, the EUT was arranged to its worst case and then the antenna was tuned to heights from 1 meter to 4 meters and the rotatable table was turned from 0 degrees to 360 degrees to find the maximum reading.
- e. The test-receiver system was set to quasi-peak detect function and specified bandwidth with maximum hold mode when the test frequency is below 1 GHz.
- f. The test-receiver system was set to peak and average detect function and specified bandwidth with maximum hold mode when the test frequency is above 1 GHz. If the peak reading value also meets average limit, measurement with the average detector is unnecessary.

##### **Note:**

1. The resolution bandwidth and video bandwidth of test receiver/spectrum analyzer is 120kHz for Quasi-peak detection (QP) at frequency below 1GHz.
2. The resolution bandwidth of test receiver/spectrum analyzer is 1 MHz and the video bandwidth is 3 MHz for Peak detection (PK) at frequency above 1GHz.
3. The resolution bandwidth of test receiver/spectrum analyzer is 1MHz and the video bandwidth is  $\geq 1/T$  (Duty cycle < 98%) or 10Hz (Duty cycle  $\geq 98\%$ ) for Average detection (AV) at frequency above 1GHz.
4. All modes of operation were investigated and the worst-case emissions are reported.

#### 4.1.4 Deviation from Test Standard

No deviation.

#### 4.1.5 Test Setup

##### For Radiated emission below 30MHz

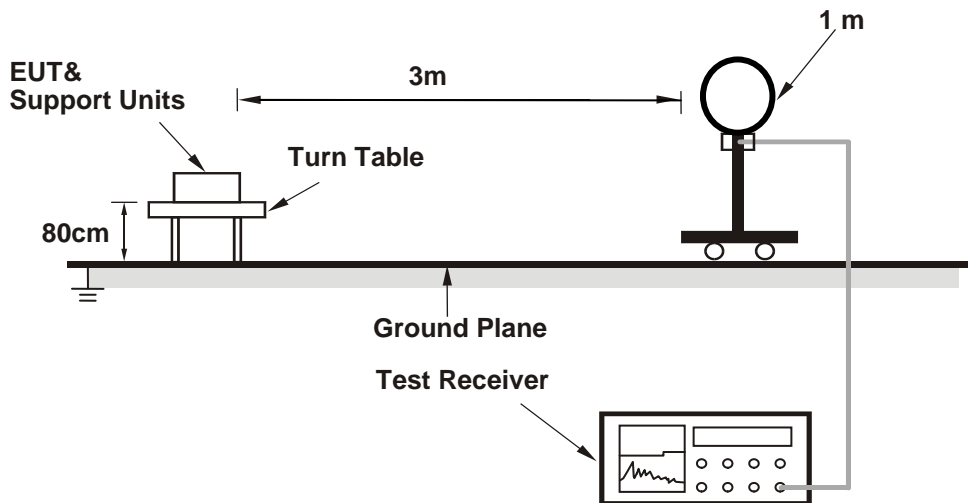

##### For Radiated emission 30MHz to 1GHz

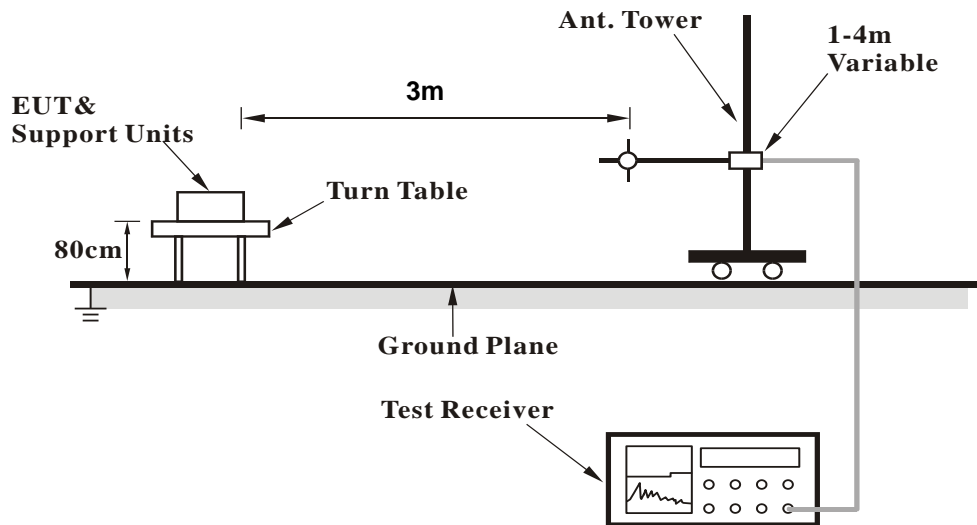

### For Radiated emission above 1GHz

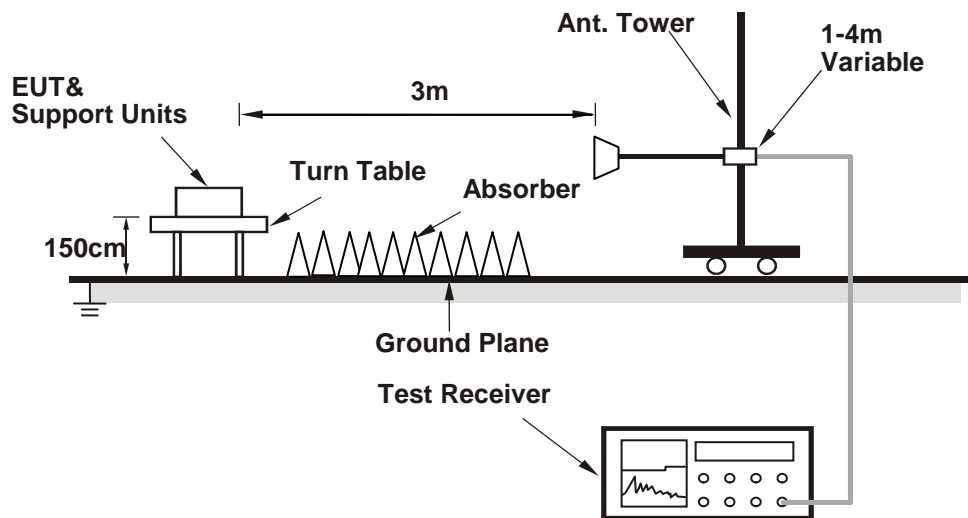

For the actual test configuration, please refer to the attached file (Test Setup Photo).

#### 4.1.6 EUT Operating Condition

- a. Connected the EUT with the Laptop which is placed on remote site.
- b. Controlling software (MTool.exe Ver 2.0.2.7) has been activated to set the EUT on specific status.

4.1.7 Test Results

Above 1GHz Data:

802.11a

<b>CHANNEL</b>	TX Channel 52	<b>DETECTOR FUNCTION</b>	Peak (PK)
<b>FREQUENCY RANGE</b>	1GHz ~ 40GHz		Average (AV)

ANTENNA POLARITY & TEST DISTANCE: HORIZONTAL AT 3 M								
NO.	FREQ. (MHz)	EMISSION LEVEL (dBuV/m)	LIMIT (dBuV/m)	MARGIN (dB)	ANTENNA HEIGHT (m)	TABLE ANGLE (Degree)	RAW VALUE (dBuV)	CORRECTION FACTOR (dB/m)
1	5150.00	51.3 PK	74.0	-22.7	1.22 H	345	49.8	1.5
2	5150.00	40.6 AV	54.0	-13.4	1.22 H	345	39.1	1.5
3	*5260.00	112.7 PK			3.98 H	127	111.0	1.7
4	*5260.00	102.7 AV			3.98 H	127	101.0	1.7
5	#10520.00	56.0 PK	74.0	-18.0	1.44 H	28	43.7	12.3
6	#10520.00	44.2 AV	54.0	-9.8	1.44 H	28	31.9	12.3
7	15780.00	50.4 PK	74.0	-23.6	1.62 H	86	37.3	13.1
8	15780.00	38.4 AV	54.0	-15.6	1.62 H	86	25.3	13.1

ANTENNA POLARITY & TEST DISTANCE: VERTICAL AT 3 M								
NO.	FREQ. (MHz)	EMISSION LEVEL (dBuV/m)	LIMIT (dBuV/m)	MARGIN (dB)	ANTENNA HEIGHT (m)	TABLE ANGLE (Degree)	RAW VALUE (dBuV)	CORRECTION FACTOR (dB/m)
1	5150.00	54.3 PK	74.0	-19.7	2.16 V	24	52.8	1.5
2	5150.00	44.3 AV	54.0	-9.7	2.16 V	24	42.8	1.5
3	*5260.00	114.5 PK			4.00 V	282	112.8	1.7
4	*5260.00	104.8 AV			4.00 V	282	103.1	1.7
5	#10520.00	61.8 PK	74.0	-12.2	2.53 V	298	49.5	12.3
6	#10520.00	49.4 AV	54.0	-4.6	2.53 V	298	37.1	12.3
7	15780.00	51.8 PK	74.0	-22.2	1.46 V	53	38.7	13.1
8	15780.00	39.6 AV	54.0	-14.4	1.46 V	53	26.5	13.1

REMARKS:

1. Emission Level(dBuV/m) = Raw Value(dBuV) + Correction Factor(dB/m)
2. Correction Factor(dB/m) = Antenna Factor(dB/m) + Cable Factor(dB) – Pre-Amplifier Factor(dB)
3. The other emission levels were very low against the limit.
4. Margin value = Emission Level – Limit value
5. " \* ": Fundamental frequency.
6. " # ": The radiated frequency is out of the restricted band.



<b>CHANNEL</b>	TX Channel 60	<b>DETECTOR FUNCTION</b>	Peak (PK)
<b>FREQUENCY RANGE</b>	1GHz ~ 40GHz		Average (AV)

**ANTENNA POLARITY & TEST DISTANCE: HORIZONTAL AT 3 M**

NO.	FREQ. (MHz)	EMISSION LEVEL (dBuV/m)	LIMIT (dBuV/m)	MARGIN (dB)	ANTENNA HEIGHT (m)	TABLE ANGLE (Degree)	RAW VALUE (dBuV)	CORRECTION FACTOR (dB/m)
1	*5300.00	111.7 PK			4.00 H	131	109.9	1.8
2	*5300.00	101.7 AV			4.00 H	131	99.9	1.8
3	10600.00	56.8 PK	74.0	-17.2	1.48 H	41	44.3	12.5
4	10600.00	44.6 AV	54.0	-9.4	1.48 H	41	32.1	12.5
5	15900.00	51.2 PK	74.0	-22.8	1.62 H	74	38.2	13.0
6	15900.00	38.8 AV	54.0	-15.2	1.62 H	74	25.8	13.0

**ANTENNA POLARITY & TEST DISTANCE: VERTICAL AT 3 M**

NO.	FREQ. (MHz)	EMISSION LEVEL (dBuV/m)	LIMIT (dBuV/m)	MARGIN (dB)	ANTENNA HEIGHT (m)	TABLE ANGLE (Degree)	RAW VALUE (dBuV)	CORRECTION FACTOR (dB/m)
1	*5300.00	113.5 PK			3.99 V	266	111.7	1.8
2	*5300.00	103.8 AV			3.99 V	266	102.0	1.8
3	10600.00	61.0 PK	74.0	-13.0	2.55 V	293	48.5	12.5
4	10600.00	48.9 AV	54.0	-5.1	2.55 V	293	36.4	12.5
5	15900.00	51.3 PK	74.0	-22.7	1.40 V	44	38.3	13.0
6	15900.00	39.2 AV	54.0	-14.8	1.40 V	44	26.2	13.0

**REMARKS:**

1. Emission Level(dBuV/m) = Raw Value(dBuV) + Correction Factor(dB/m)
2. Correction Factor(dB/m) = Antenna Factor(dB/m) + Cable Factor(dB) – Pre-Amplifier Factor(dB)
3. The other emission levels were very low against the limit.
4. Margin value = Emission Level – Limit value
5. " \* ": Fundamental frequency.

<b>CHANNEL</b>	TX Channel 64	<b>DETECTOR FUNCTION</b>	Peak (PK)
<b>FREQUENCY RANGE</b>	1GHz ~ 40GHz		Average (AV)

**ANTENNA POLARITY & TEST DISTANCE: HORIZONTAL AT 3 M**

NO.	FREQ. (MHz)	EMISSION LEVEL (dBuV/m)	LIMIT (dBuV/m)	MARGIN (dB)	ANTENNA HEIGHT (m)	TABLE ANGLE (Degree)	RAW VALUE (dBuV)	CORRECTION FACTOR (dB/m)
1	*5320.00	112.3 PK			3.99 H	132	110.5	1.8
2	*5320.00	101.0 AV			3.99 H	132	99.2	1.8
3	5350.00	67.1 PK	74.0	-6.9	3.99 H	132	65.2	1.9
4	5350.00	48.8 AV	54.0	-5.2	3.99 H	132	46.9	1.9
5	10640.00	56.8 PK	74.0	-17.2	1.53 H	33	44.3	12.5
6	10640.00	44.5 AV	54.0	-9.5	1.53 H	33	32.0	12.5
7	15960.00	51.0 PK	74.0	-23.0	1.61 H	78	38.1	12.9
8	15960.00	38.8 AV	54.0	-15.2	1.61 H	78	25.9	12.9

**ANTENNA POLARITY & TEST DISTANCE: VERTICAL AT 3 M**

NO.	FREQ. (MHz)	EMISSION LEVEL (dBuV/m)	LIMIT (dBuV/m)	MARGIN (dB)	ANTENNA HEIGHT (m)	TABLE ANGLE (Degree)	RAW VALUE (dBuV)	CORRECTION FACTOR (dB/m)
1	*5320.00	114.1 PK			2.14 V	26	112.3	1.8
2	*5320.00	103.1 AV			2.14 V	26	101.3	1.8
3	5350.00	70.1 PK	74.0	-3.9	2.14 V	26	68.2	1.9
4	5350.00	52.5 AV	54.0	-1.5	2.14 V	26	50.6	1.9
5	10640.00	61.8 PK	74.0	-12.2	2.68 V	283	49.3	12.5
6	10640.00	49.3 AV	54.0	-4.7	2.68 V	283	36.8	12.5
7	15960.00	51.9 PK	74.0	-22.1	1.52 V	18	39.0	12.9
8	15960.00	39.7 AV	54.0	-14.3	1.52 V	18	26.8	12.9

**REMARKS:**

1. Emission Level(dBuV/m) = Raw Value(dBuV) + Correction Factor(dB/m)
2. Correction Factor(dB/m) = Antenna Factor(dB/m) + Cable Factor(dB) – Pre-Amplifier Factor(dB)
3. The other emission levels were very low against the limit.
4. Margin value = Emission Level – Limit value
5. " \* ": Fundamental frequency.

<b>CHANNEL</b>	TX Channel 100	<b>DETECTOR FUNCTION</b>	Peak (PK)
<b>FREQUENCY RANGE</b>	1GHz ~ 40GHz		Average (AV)

**ANTENNA POLARITY & TEST DISTANCE: HORIZONTAL AT 3 M**

NO.	FREQ. (MHz)	EMISSION LEVEL (dBuV/m)	LIMIT (dBuV/m)	MARGIN (dB)	ANTENNA HEIGHT (m)	TABLE ANGLE (Degree)	RAW VALUE (dBuV)	CORRECTION FACTOR (dB/m)
1	#5470.00	68.8 PK	74.0	-5.2	3.98 H	144	66.7	2.1
2	#5470.00	49.2 AV	54.0	-4.8	3.98 H	144	47.1	2.1
3	*5500.00	110.2 PK			3.98 H	144	108.1	2.1
4	*5500.00	99.5 AV			3.98 H	144	97.4	2.1
5	11000.00	56.3 PK	74.0	-17.7	1.53 H	22	43.1	13.2
6	11000.00	44.1 AV	54.0	-9.9	1.53 H	22	30.9	13.2
7	#16500.00	50.5 PK	74.0	-23.5	1.63 H	68	35.5	15.0
8	#16500.00	38.6 AV	54.0	-15.4	1.63 H	68	23.6	15.0

**ANTENNA POLARITY & TEST DISTANCE: VERTICAL AT 3 M**

NO.	FREQ. (MHz)	EMISSION LEVEL (dBuV/m)	LIMIT (dBuV/m)	MARGIN (dB)	ANTENNA HEIGHT (m)	TABLE ANGLE (Degree)	RAW VALUE (dBuV)	CORRECTION FACTOR (dB/m)
1	#5470.00	71.8 PK	74.0	-2.2	2.10 V	23	69.7	2.1
2	#5470.00	52.9 AV	54.0	-1.1	2.10 V	23	50.8	2.1
3	*5500.00	112.0 PK			2.10 V	23	109.9	2.1
4	*5500.00	101.6 AV			2.10 V	23	99.5	2.1
5	11000.00	61.5 PK	74.0	-12.5	2.62 V	295	48.3	13.2
6	11000.00	48.9 AV	54.0	-5.1	2.62 V	295	35.7	13.2
7	#16500.00	52.1 PK	74.0	-21.9	1.47 V	29	37.1	15.0
8	#16500.00	40.0 AV	54.0	-14.0	1.47 V	29	25.0	15.0

**REMARKS:**

1. Emission Level(dBuV/m) = Raw Value(dBuV) + Correction Factor(dB/m)
2. Correction Factor(dB/m) = Antenna Factor(dB/m) + Cable Factor(dB) – Pre-Amplifier Factor(dB)
3. The other emission levels were very low against the limit.
4. Margin value = Emission Level – Limit value
5. " \* ": Fundamental frequency.
6. " # ": The radiated frequency is out of the restricted band.

<b>CHANNEL</b>	TX Channel 116	<b>DETECTOR FUNCTION</b>	Peak (PK)
<b>FREQUENCY RANGE</b>	1GHz ~ 40GHz		Average (AV)

**ANTENNA POLARITY & TEST DISTANCE: HORIZONTAL AT 3 M**

NO.	FREQ. (MHz)	EMISSION LEVEL (dBuV/m)	LIMIT (dBuV/m)	MARGIN (dB)	ANTENNA HEIGHT (m)	TABLE ANGLE (Degree)	RAW VALUE (dBuV)	CORRECTION FACTOR (dB/m)
1	*5580.00	115.0 PK			3.98 H	148	112.7	2.3
2	*5580.00	104.3 AV			3.98 H	148	102.0	2.3
3	11160.00	55.7 PK	74.0	-18.3	1.54 H	18	42.6	13.1
4	11160.00	44.0 AV	54.0	-10.0	1.54 H	18	30.9	13.1
5	#16740.00	51.3 PK	74.0	-22.7	1.69 H	72	35.2	16.1
6	#16740.00	39.3 AV	54.0	-14.7	1.69 H	72	23.2	16.1

**ANTENNA POLARITY & TEST DISTANCE: VERTICAL AT 3 M**

NO.	FREQ. (MHz)	EMISSION LEVEL (dBuV/m)	LIMIT (dBuV/m)	MARGIN (dB)	ANTENNA HEIGHT (m)	TABLE ANGLE (Degree)	RAW VALUE (dBuV)	CORRECTION FACTOR (dB/m)
1	*5580.00	116.8 PK			4.00 V	256	114.5	2.3
2	*5580.00	106.4 AV			4.00 V	256	104.1	2.3
3	11160.00	61.9 PK	74.0	-12.1	2.59 V	300	48.8	13.1
4	11160.00	49.3 AV	54.0	-4.7	2.59 V	300	36.2	13.1
5	#16740.00	52.0 PK	74.0	-22.0	1.41 V	42	35.9	16.1
6	#16740.00	39.9 AV	54.0	-14.1	1.41 V	42	23.8	16.1

**REMARKS:**

1. Emission Level(dBuV/m) = Raw Value(dBuV) + Correction Factor(dB/m)
2. Correction Factor(dB/m) = Antenna Factor(dB/m) + Cable Factor(dB) – Pre-Amplifier Factor(dB)
3. The other emission levels were very low against the limit.
4. Margin value = Emission Level – Limit value
5. " \* ": Fundamental frequency.
6. " # ": The radiated frequency is out of the restricted band.

<b>CHANNEL</b>	TX Channel 140	<b>DETECTOR FUNCTION</b>	Peak (PK)
<b>FREQUENCY RANGE</b>	1GHz ~ 40GHz		Average (AV)

**ANTENNA POLARITY & TEST DISTANCE: HORIZONTAL AT 3 M**

NO.	FREQ. (MHz)	EMISSION LEVEL (dBuV/m)	LIMIT (dBuV/m)	MARGIN (dB)	ANTENNA HEIGHT (m)	TABLE ANGLE (Degree)	RAW VALUE (dBuV)	CORRECTION FACTOR (dB/m)
1	*5700.00	109.1 PK			3.94 H	146	106.4	2.7
2	*5700.00	99.3 AV			3.94 H	146	96.6	2.7
3	#5725.00	69.1 PK	74.0	-4.9	3.94 H	146	66.4	2.7
4	#5725.00	48.9 AV	54.0	-5.1	3.94 H	146	46.2	2.7
5	11400.00	55.3 PK	74.0	-18.7	1.57 H	29	42.0	13.3
6	11400.00	43.8 AV	54.0	-10.2	1.57 H	29	30.5	13.3
7	#17100.00	50.7 PK	74.0	-23.3	1.74 H	62	33.0	17.7
8	#17100.00	38.9 AV	54.0	-15.1	1.74 H	62	21.2	17.7

**ANTENNA POLARITY & TEST DISTANCE: VERTICAL AT 3 M**

NO.	FREQ. (MHz)	EMISSION LEVEL (dBuV/m)	LIMIT (dBuV/m)	MARGIN (dB)	ANTENNA HEIGHT (m)	TABLE ANGLE (Degree)	RAW VALUE (dBuV)	CORRECTION FACTOR (dB/m)
1	*5700.00	110.9 PK			2.08 V	23	108.2	2.7
2	*5700.00	101.4 AV			2.08 V	23	98.7	2.7
3	#5725.00	72.1 PK	74.0	-1.9	2.08 V	23	69.4	2.7
4	#5725.00	52.6 AV	54.0	-1.4	2.08 V	23	49.9	2.7
5	11400.00	62.0 PK	74.0	-12.0	2.58 V	286	48.7	13.3
6	11400.00	49.1 AV	54.0	-4.9	2.58 V	286	35.8	13.3
7	#17100.00	51.5 PK	74.0	-22.5	1.42 V	39	33.8	17.7
8	#17100.00	39.5 AV	54.0	-14.5	1.42 V	39	21.8	17.7

**REMARKS:**

1. Emission Level(dBuV/m) = Raw Value(dBuV) + Correction Factor(dB/m)
2. Correction Factor(dB/m) = Antenna Factor(dB/m) + Cable Factor(dB) – Pre-Amplifier Factor(dB)
3. The other emission levels were very low against the limit.
4. Margin value = Emission Level – Limit value
5. " \* ": Fundamental frequency.
6. " # ": The radiated frequency is out of the restricted band.

<b>CHANNEL</b>	TX Channel 144	<b>DETECTOR FUNCTION</b>	Peak (PK)
<b>FREQUENCY RANGE</b>	1GHz ~ 40GHz		Average (AV)

**ANTENNA POLARITY & TEST DISTANCE: HORIZONTAL AT 3 M**

NO.	FREQ. (MHz)	EMISSION LEVEL (dBuV/m)	LIMIT (dBuV/m)	MARGIN (dB)	ANTENNA HEIGHT (m)	TABLE ANGLE (Degree)	RAW VALUE (dBuV)	CORRECTION FACTOR (dB/m)
1	#5470.00	49.5 PK	74.0	-24.5	3.97 H	157	47.4	2.1
2	#5470.00	36.8 AV	54.0	-17.2	3.97 H	157	34.7	2.1
3	*5720.00	114.4 PK			3.97 H	157	111.7	2.7
4	*5720.00	103.9 AV			3.97 H	157	101.2	2.7
5	#5850.00	51.5 PK	74.0	-22.5	3.97 H	157	48.7	2.8
6	#5850.00	37.7 AV	54.0	-16.3	3.97 H	157	34.9	2.8
7	11440.00	56.3 PK	74.0	-17.7	1.49 H	40	43.0	13.3
8	11440.00	44.3 AV	54.0	-9.7	1.49 H	40	31.0	13.3
9	#17160.00	51.3 PK	74.0	-22.7	1.61 H	76	33.3	18.0
10	#17160.00	39.3 AV	54.0	-14.7	1.61 H	76	21.3	18.0

**ANTENNA POLARITY & TEST DISTANCE: VERTICAL AT 3 M**

NO.	FREQ. (MHz)	EMISSION LEVEL (dBuV/m)	LIMIT (dBuV/m)	MARGIN (dB)	ANTENNA HEIGHT (m)	TABLE ANGLE (Degree)	RAW VALUE (dBuV)	CORRECTION FACTOR (dB/m)
1	#5470.00	52.5 PK	74.0	-21.5	3.97 V	251	50.4	2.1
2	#5470.00	40.5 AV	54.0	-13.5	3.97 V	251	38.4	2.1
3	*5720.00	116.2 PK			3.97 V	251	113.5	2.7
4	*5720.00	106.0 AV			3.97 V	251	103.3	2.7
5	#5850.00	54.5 PK	74.0	-19.5	3.97 V	251	51.7	2.8
6	#5850.00	41.4 AV	54.0	-12.6	3.97 V	251	38.6	2.8
7	11440.00	62.4 PK	74.0	-11.6	2.54 V	293	49.1	13.3
8	11440.00	49.7 AV	54.0	-4.3	2.54 V	293	36.4	13.3
9	#17160.00	51.6 PK	74.0	-22.4	1.45 V	43	33.6	18.0
10	#17160.00	39.3 AV	54.0	-14.7	1.45 V	43	21.3	18.0

**REMARKS:**

1. Emission Level(dBuV/m) = Raw Value(dBuV) + Correction Factor(dB/m)
2. Correction Factor(dB/m) = Antenna Factor(dB/m) + Cable Factor(dB) – Pre-Amplifier Factor(dB)
3. The other emission levels were very low against the limit.
4. Margin value = Emission Level – Limit value
5. " \* ": Fundamental frequency.
6. " # ": The radiated frequency is out of the restricted band.

**802.11ac (VHT20)**

<b>CHANNEL</b>	TX Channel 52	<b>DETECTOR FUNCTION</b>	Peak (PK)
<b>FREQUENCY RANGE</b>	1GHz ~ 40GHz		Average (AV)

**ANTENNA POLARITY & TEST DISTANCE: HORIZONTAL AT 3 M**

NO.	FREQ. (MHz)	EMISSION LEVEL (dBuV/m)	LIMIT (dBuV/m)	MARGIN (dB)	ANTENNA HEIGHT (m)	TABLE ANGLE (Degree)	RAW VALUE (dBuV)	CORRECTION FACTOR (dB/m)
1	5150.00	62.2 PK	74.0	-11.8	3.95 H	146	60.7	1.5
2	5150.00	43.1 AV	54.0	-10.9	3.95 H	146	41.6	1.5
3	*5260.00	116.0 PK			3.95 H	146	114.3	1.7
4	*5260.00	104.9 AV			3.95 H	146	103.2	1.7
5	5350.00	63.5 PK	74.0	-10.5	3.95 H	146	61.6	1.9
6	5350.00	46.6 AV	54.0	-7.4	3.95 H	146	44.7	1.9
7	#10520.00	56.2 PK	74.0	-17.8	1.49 H	54	43.9	12.3
8	#10520.00	44.3 AV	54.0	-9.7	1.49 H	54	32.0	12.3
9	15780.00	51.8 PK	74.0	-22.2	1.61 H	62	38.7	13.1
10	15780.00	39.8 AV	54.0	-14.2	1.61 H	62	26.7	13.1

**ANTENNA POLARITY & TEST DISTANCE: VERTICAL AT 3 M**

NO.	FREQ. (MHz)	EMISSION LEVEL (dBuV/m)	LIMIT (dBuV/m)	MARGIN (dB)	ANTENNA HEIGHT (m)	TABLE ANGLE (Degree)	RAW VALUE (dBuV)	CORRECTION FACTOR (dB/m)
1	5150.00	65.2 PK	74.0	-8.8	2.08 V	316	63.7	1.5
2	5150.00	46.8 AV	54.0	-7.2	2.08 V	316	45.3	1.5
3	*5260.00	117.8 PK			2.08 V	316	116.1	1.7
4	*5260.00	107.0 AV			2.08 V	316	105.3	1.7
5	5350.00	66.5 PK	74.0	-7.5	2.08 V	316	64.6	1.9
6	5350.00	50.3 AV	54.0	-3.7	2.08 V	316	48.4	1.9
7	#10520.00	62.3 PK	74.0	-11.7	2.49 V	303	50.0	12.3
8	#10520.00	49.3 AV	54.0	-4.7	2.49 V	303	37.0	12.3
9	15780.00	51.3 PK	74.0	-22.7	1.45 V	31	38.2	13.1
10	15780.00	39.2 AV	54.0	-14.8	1.45 V	31	26.1	13.1

**REMARKS:**

- Emission Level(dBuV/m) = Raw Value(dBuV) + Correction Factor(dB/m)
- Correction Factor(dB/m) = Antenna Factor(dB/m) + Cable Factor(dB) – Pre-Amplifier Factor(dB)
- The other emission levels were very low against the limit.
- Margin value = Emission Level – Limit value
- " \* ": Fundamental frequency.
- " # ": The radiated frequency is out of the restricted band.

<b>CHANNEL</b>	TX Channel 60	<b>DETECTOR FUNCTION</b>	Peak (PK)
<b>FREQUENCY RANGE</b>	1GHz ~ 40GHz		Average (AV)

**ANTENNA POLARITY & TEST DISTANCE: HORIZONTAL AT 3 M**

NO.	FREQ. (MHz)	EMISSION LEVEL (dBuV/m)	LIMIT (dBuV/m)	MARGIN (dB)	ANTENNA HEIGHT (m)	TABLE ANGLE (Degree)	RAW VALUE (dBuV)	CORRECTION FACTOR (dB/m)
1	*5300.00	115.6 PK			3.91 H	143	113.8	1.8
2	*5300.00	104.1 AV			3.91 H	143	102.3	1.8
3	5350.00	67.4 PK	74.0	-6.6	3.91 H	143	65.5	1.9
4	5350.00	49.2 AV	54.0	-4.8	3.91 H	143	47.3	1.9
5	10600.00	55.8 PK	74.0	-18.2	1.49 H	55	43.3	12.5
6	10600.00	44.0 AV	54.0	-10.0	1.49 H	55	31.5	12.5
7	15900.00	51.3 PK	74.0	-22.7	1.58 H	64	38.3	13.0
8	15900.00	39.4 AV	54.0	-14.6	1.58 H	64	26.4	13.0

**ANTENNA POLARITY & TEST DISTANCE: VERTICAL AT 3 M**

NO.	FREQ. (MHz)	EMISSION LEVEL (dBuV/m)	LIMIT (dBuV/m)	MARGIN (dB)	ANTENNA HEIGHT (m)	TABLE ANGLE (Degree)	RAW VALUE (dBuV)	CORRECTION FACTOR (dB/m)
1	*5300.00	117.4 PK			2.07 V	315	115.6	1.8
2	*5300.00	106.2 AV			2.07 V	315	104.4	1.8
3	5350.00	70.4 PK	74.0	-3.6	2.07 V	315	68.5	1.9
<b>4</b>	<b>5350.00</b>	<b>52.9 AV</b>	<b>54.0</b>	<b>-1.1</b>	<b>2.07 V</b>	<b>315</b>	<b>51.0</b>	<b>1.9</b>
5	10600.00	62.7 PK	74.0	-11.3	2.51 V	291	50.2	12.5
6	10600.00	49.8 AV	54.0	-4.2	2.51 V	291	37.3	12.5
7	15900.00	51.1 PK	74.0	-22.9	1.46 V	40	38.1	13.0
8	15900.00	38.9 AV	54.0	-15.1	1.46 V	40	25.9	13.0

**REMARKS:**

1. Emission Level(dBuV/m) = Raw Value(dBuV) + Correction Factor(dB/m)
2. Correction Factor(dB/m) = Antenna Factor(dB/m) + Cable Factor(dB) – Pre-Amplifier Factor(dB)
3. The other emission levels were very low against the limit.
4. Margin value = Emission Level – Limit value
5. " \* ": Fundamental frequency.



<b>CHANNEL</b>	TX Channel 64	<b>DETECTOR FUNCTION</b>	Peak (PK)
<b>FREQUENCY RANGE</b>	1GHz ~ 40GHz		Average (AV)

**ANTENNA POLARITY & TEST DISTANCE: HORIZONTAL AT 3 M**

NO.	FREQ. (MHz)	EMISSION LEVEL (dBuV/m)	LIMIT (dBuV/m)	MARGIN (dB)	ANTENNA HEIGHT (m)	TABLE ANGLE (Degree)	RAW VALUE (dBuV)	CORRECTION FACTOR (dB/m)
1	*5320.00	111.5 PK			3.96 H	143	109.7	1.8
2	*5320.00	101.2 AV			3.96 H	143	99.4	1.8
3	5350.00	69.4 PK	74.0	-4.6	3.96 H	143	67.5	1.9
4	5350.00	48.4 AV	54.0	-5.6	3.96 H	143	46.5	1.9
5	10640.00	56.3 PK	74.0	-17.7	1.44 H	70	43.8	12.5
6	10640.00	44.6 AV	54.0	-9.4	1.44 H	70	32.1	12.5
7	15960.00	51.8 PK	74.0	-22.2	1.61 H	78	38.9	12.9
8	15960.00	39.7 AV	54.0	-14.3	1.61 H	78	26.8	12.9

**ANTENNA POLARITY & TEST DISTANCE: VERTICAL AT 3 M**

NO.	FREQ. (MHz)	EMISSION LEVEL (dBuV/m)	LIMIT (dBuV/m)	MARGIN (dB)	ANTENNA HEIGHT (m)	TABLE ANGLE (Degree)	RAW VALUE (dBuV)	CORRECTION FACTOR (dB/m)
1	*5320.00	113.3 PK			2.04 V	318	111.5	1.8
2	*5320.00	103.3 AV			2.04 V	318	101.5	1.8
3	5350.00	72.4 PK	74.0	-1.6	2.04 V	318	70.5	1.9
4	5350.00	52.1 AV	54.0	-1.9	2.04 V	318	50.2	1.9
5	10640.00	62.7 PK	74.0	-11.3	2.52 V	276	50.2	12.5
6	10640.00	49.8 AV	54.0	-4.2	2.52 V	276	37.3	12.5
7	15960.00	51.5 PK	74.0	-22.5	1.46 V	37	38.6	12.9
8	15960.00	39.1 AV	54.0	-14.9	1.46 V	37	26.2	12.9

**REMARKS:**

1. Emission Level(dBuV/m) = Raw Value(dBuV) + Correction Factor(dB/m)
2. Correction Factor(dB/m) = Antenna Factor(dB/m) + Cable Factor(dB) – Pre-Amplifier Factor(dB)
3. The other emission levels were very low against the limit.
4. Margin value = Emission Level – Limit value
5. " \* ": Fundamental frequency.

<b>CHANNEL</b>	TX Channel 100	<b>DETECTOR FUNCTION</b>	Peak (PK)
<b>FREQUENCY RANGE</b>	1GHz ~ 40GHz		Average (AV)

**ANTENNA POLARITY & TEST DISTANCE: HORIZONTAL AT 3 M**

NO.	FREQ. (MHz)	EMISSION LEVEL (dBuV/m)	LIMIT (dBuV/m)	MARGIN (dB)	ANTENNA HEIGHT (m)	TABLE ANGLE (Degree)	RAW VALUE (dBuV)	CORRECTION FACTOR (dB/m)
1	#5470.00	69.4 PK	74.0	-4.6	3.95 H	128	67.3	2.1
2	#5470.00	46.7 AV	54.0	-7.3	3.95 H	128	44.6	2.1
3	*5500.00	110.7 PK			3.95 H	128	108.6	2.1
4	*5500.00	100.1 AV			3.95 H	128	98.0	2.1
5	11000.00	56.3 PK	74.0	-17.7	1.44 H	67	43.1	13.2
6	11000.00	44.1 AV	54.0	-9.9	1.44 H	67	30.9	13.2
7	#16500.00	52.3 PK	74.0	-21.7	1.67 H	68	37.3	15.0
8	#16500.00	40.0 AV	54.0	-14.0	1.67 H	68	25.0	15.0

**ANTENNA POLARITY & TEST DISTANCE: VERTICAL AT 3 M**

NO.	FREQ. (MHz)	EMISSION LEVEL (dBuV/m)	LIMIT (dBuV/m)	MARGIN (dB)	ANTENNA HEIGHT (m)	TABLE ANGLE (Degree)	RAW VALUE (dBuV)	CORRECTION FACTOR (dB/m)
1	#5470.00	72.4 PK	74.0	-1.6	2.08 V	315	70.3	2.1
2	#5470.00	50.4 AV	54.0	-3.6	2.08 V	315	48.3	2.1
3	*5500.00	112.5 PK			2.08 V	315	110.4	2.1
4	*5500.00	102.2 AV			2.08 V	315	100.1	2.1
5	11000.00	62.6 PK	74.0	-11.4	2.46 V	286	49.4	13.2
6	11000.00	50.0 AV	54.0	-4.0	2.46 V	286	36.8	13.2
7	#16500.00	52.0 PK	74.0	-22.0	1.49 V	27	37.0	15.0
8	#16500.00	39.3 AV	54.0	-14.7	1.49 V	27	24.3	15.0

**REMARKS:**

1. Emission Level(dBuV/m) = Raw Value(dBuV) + Correction Factor(dB/m)
2. Correction Factor(dB/m) = Antenna Factor(dB/m) + Cable Factor(dB) – Pre-Amplifier Factor(dB)
3. The other emission levels were very low against the limit.
4. Margin value = Emission Level – Limit value
5. " \* ": Fundamental frequency.
6. " # ": The radiated frequency is out of the restricted band.

<b>CHANNEL</b>	TX Channel 116	<b>DETECTOR FUNCTION</b>	Peak (PK)
<b>FREQUENCY RANGE</b>	1GHz ~ 40GHz		Average (AV)

**ANTENNA POLARITY & TEST DISTANCE: HORIZONTAL AT 3 M**

NO.	FREQ. (MHz)	EMISSION LEVEL (dBuV/m)	LIMIT (dBuV/m)	MARGIN (dB)	ANTENNA HEIGHT (m)	TABLE ANGLE (Degree)	RAW VALUE (dBuV)	CORRECTION FACTOR (dB/m)
1	#5470.00	55.5 PK	74.0	-18.5	4.00 H	115	53.4	2.1
2	#5470.00	39.6 AV	54.0	-14.4	4.00 H	115	37.5	2.1
3	*5580.00	115.7 PK			4.00 H	115	113.4	2.3
4	*5580.00	104.7 AV			4.00 H	115	102.4	2.3
5	11160.00	56.3 PK	74.0	-17.7	1.39 H	66	43.2	13.1
6	11160.00	44.2 AV	54.0	-9.8	1.39 H	66	31.1	13.1
7	#16740.00	52.8 PK	74.0	-21.2	1.65 H	74	36.7	16.1
8	#16740.00	40.3 AV	54.0	-13.7	1.65 H	74	24.2	16.1

**ANTENNA POLARITY & TEST DISTANCE: VERTICAL AT 3 M**

NO.	FREQ. (MHz)	EMISSION LEVEL (dBuV/m)	LIMIT (dBuV/m)	MARGIN (dB)	ANTENNA HEIGHT (m)	TABLE ANGLE (Degree)	RAW VALUE (dBuV)	CORRECTION FACTOR (dB/m)
1	#5470.00	58.5 PK	74.0	-15.5	2.13 V	312	56.4	2.1
2	#5470.00	43.3 AV	54.0	-10.7	2.13 V	312	41.2	2.1
3	*5580.00	117.5 PK			2.13 V	312	115.2	2.3
4	*5580.00	106.8 AV			2.13 V	312	104.5	2.3
5	11160.00	62.5 PK	74.0	-11.5	2.46 V	296	49.4	13.1
6	11160.00	50.1 AV	54.0	-3.9	2.46 V	296	37.0	13.1
7	#16740.00	51.9 PK	74.0	-22.1	1.53 V	33	35.8	16.1
8	#16740.00	39.3 AV	54.0	-14.7	1.53 V	33	23.2	16.1

**REMARKS:**

1. Emission Level(dBuV/m) = Raw Value(dBuV) + Correction Factor(dB/m)
2. Correction Factor(dB/m) = Antenna Factor(dB/m) + Cable Factor(dB) – Pre-Amplifier Factor(dB)
3. The other emission levels were very low against the limit.
4. Margin value = Emission Level – Limit value
5. " \* ": Fundamental frequency.
6. " # ": The radiated frequency is out of the restricted band.

<b>CHANNEL</b>	TX Channel 140	<b>DETECTOR FUNCTION</b>	Peak (PK)
<b>FREQUENCY RANGE</b>	1GHz ~ 40GHz		Average (AV)

**ANTENNA POLARITY & TEST DISTANCE: HORIZONTAL AT 3 M**

NO.	FREQ. (MHz)	EMISSION LEVEL (dBuV/m)	LIMIT (dBuV/m)	MARGIN (dB)	ANTENNA HEIGHT (m)	TABLE ANGLE (Degree)	RAW VALUE (dBuV)	CORRECTION FACTOR (dB/m)
1	*5700.00	109.2 PK			3.97 H	111	106.5	2.7
2	*5700.00	98.7 AV			3.97 H	111	96.0	2.7
3	#5725.00	69.6 PK	74.0	-4.4	3.97 H	111	66.9	2.7
4	#5725.00	47.6 AV	54.0	-6.4	3.97 H	111	44.9	2.7
5	11400.00	56.8 PK	74.0	-17.2	1.45 H	61	43.5	13.3
6	11400.00	44.4 AV	54.0	-9.6	1.45 H	61	31.1	13.3
7	#17100.00	52.0 PK	74.0	-22.0	1.72 H	62	34.3	17.7
8	#17100.00	39.7 AV	54.0	-14.3	1.72 H	62	22.0	17.7

**ANTENNA POLARITY & TEST DISTANCE: VERTICAL AT 3 M**

NO.	FREQ. (MHz)	EMISSION LEVEL (dBuV/m)	LIMIT (dBuV/m)	MARGIN (dB)	ANTENNA HEIGHT (m)	TABLE ANGLE (Degree)	RAW VALUE (dBuV)	CORRECTION FACTOR (dB/m)
1	*5700.00	111.0 PK			2.13 V	312	108.3	2.7
2	*5700.00	100.8 AV			2.13 V	312	98.1	2.7
3	#5725.00	72.6 PK	74.0	-1.4	2.13 V	312	69.9	2.7
4	#5725.00	51.3 AV	54.0	-2.7	2.13 V	312	48.6	2.7
5	11400.00	62.2 PK	74.0	-11.8	2.47 V	303	48.9	13.3
6	11400.00	49.9 AV	54.0	-4.1	2.47 V	303	36.6	13.3
7	#17100.00	52.3 PK	74.0	-21.7	1.48 V	29	34.6	17.7
8	#17100.00	39.4 AV	54.0	-14.6	1.48 V	29	21.7	17.7

**REMARKS:**

1. Emission Level(dBuV/m) = Raw Value(dBuV) + Correction Factor(dB/m)
2. Correction Factor(dB/m) = Antenna Factor(dB/m) + Cable Factor(dB) – Pre-Amplifier Factor(dB)
3. The other emission levels were very low against the limit.
4. Margin value = Emission Level – Limit value
5. " \* ": Fundamental frequency.
6. " # ": The radiated frequency is out of the restricted band.

<b>CHANNEL</b>	TX Channel 144	<b>DETECTOR FUNCTION</b>	Peak (PK)
<b>FREQUENCY RANGE</b>	1GHz ~ 40GHz		Average (AV)

**ANTENNA POLARITY & TEST DISTANCE: HORIZONTAL AT 3 M**

NO.	FREQ. (MHz)	EMISSION LEVEL (dBuV/m)	LIMIT (dBuV/m)	MARGIN (dB)	ANTENNA HEIGHT (m)	TABLE ANGLE (Degree)	RAW VALUE (dBuV)	CORRECTION FACTOR (dB/m)
1	#5470.00	49.0 PK	74.0	-25.0	3.91 H	116	46.9	2.1
2	#5470.00	36.6 AV	54.0	-17.4	3.91 H	116	34.5	2.1
3	*5720.00	113.4 PK			3.91 H	116	110.7	2.7
4	*5720.00	102.3 AV			3.91 H	116	99.6	2.7
5	#5850.00	51.4 PK	74.0	-22.6	3.91 H	116	48.6	2.8
6	#5850.00	37.6 AV	54.0	-16.4	3.91 H	116	34.8	2.8
7	11440.00	56.6 PK	74.0	-17.4	1.47 H	66	43.3	13.3
8	11440.00	44.3 AV	54.0	-9.7	1.47 H	66	31.0	13.3
9	#17160.00	52.9 PK	74.0	-21.1	1.65 H	70	34.9	18.0
10	#17160.00	40.4 AV	54.0	-13.6	1.65 H	70	22.4	18.0

**ANTENNA POLARITY & TEST DISTANCE: VERTICAL AT 3 M**

NO.	FREQ. (MHz)	EMISSION LEVEL (dBuV/m)	LIMIT (dBuV/m)	MARGIN (dB)	ANTENNA HEIGHT (m)	TABLE ANGLE (Degree)	RAW VALUE (dBuV)	CORRECTION FACTOR (dB/m)
1	#5470.00	52.0 PK	74.0	-22.0	2.13 V	313	49.9	2.1
2	#5470.00	40.3 AV	54.0	-13.7	2.13 V	313	38.2	2.1
3	*5720.00	115.2 PK			2.13 V	313	112.5	2.7
4	*5720.00	104.4 AV			2.13 V	313	101.7	2.7
5	#5850.00	54.4 PK	74.0	-19.6	2.13 V	313	51.6	2.8
6	#5850.00	41.3 AV	54.0	-12.7	2.13 V	313	38.5	2.8
7	11440.00	61.6 PK	74.0	-12.4	2.41 V	294	48.3	13.3
8	11440.00	49.5 AV	54.0	-4.5	2.41 V	294	36.2	13.3
9	#17160.00	52.3 PK	74.0	-21.7	1.48 V	42	34.3	18.0
10	#17160.00	39.1 AV	54.0	-14.9	1.48 V	42	21.1	18.0

**REMARKS:**

1. Emission Level(dBuV/m) = Raw Value(dBuV) + Correction Factor(dB/m)
2. Correction Factor(dB/m) = Antenna Factor(dB/m) + Cable Factor(dB) – Pre-Amplifier Factor(dB)
3. The other emission levels were very low against the limit.
4. Margin value = Emission Level – Limit value
5. " \* ": Fundamental frequency.
6. " # ": The radiated frequency is out of the restricted band.

802.11ac (VHT40)

<b>CHANNEL</b>	TX Channel 54	<b>DETECTOR FUNCTION</b>	Peak (PK)
<b>FREQUENCY RANGE</b>	1GHz ~ 40GHz		Average (AV)

ANTENNA POLARITY & TEST DISTANCE: HORIZONTAL AT 3 M								
NO.	FREQ. (MHz)	EMISSION LEVEL (dBuV/m)	LIMIT (dBuV/m)	MARGIN (dB)	ANTENNA HEIGHT (m)	TABLE ANGLE (Degree)	RAW VALUE (dBuV)	CORRECTION FACTOR (dB/m)
1	5150.00	56.5 PK	74.0	-17.5	3.90 H	125	55.0	1.5
2	5150.00	41.1 AV	54.0	-12.9	3.90 H	125	39.6	1.5
3	*5270.00	110.3 PK			3.90 H	125	108.5	1.8
4	*5270.00	99.5 AV			3.90 H	125	97.7	1.8
5	5350.00	65.1 PK	74.0	-8.9	3.90 H	125	63.2	1.9
6	5350.00	49.2 AV	54.0	-4.8	3.90 H	125	47.3	1.9
7	#10540.00	56.5 PK	74.0	-17.5	1.51 H	70	44.2	12.3
8	#10540.00	44.3 AV	54.0	-9.7	1.51 H	70	32.0	12.3
9	15810.00	53.2 PK	74.0	-20.8	1.62 H	69	40.2	13.0
10	15810.00	40.4 AV	54.0	-13.6	1.62 H	69	27.4	13.0

ANTENNA POLARITY & TEST DISTANCE: VERTICAL AT 3 M								
NO.	FREQ. (MHz)	EMISSION LEVEL (dBuV/m)	LIMIT (dBuV/m)	MARGIN (dB)	ANTENNA HEIGHT (m)	TABLE ANGLE (Degree)	RAW VALUE (dBuV)	CORRECTION FACTOR (dB/m)
1	5150.00	59.5 PK	74.0	-14.5	2.16 V	303	58.0	1.5
2	5150.00	44.8 AV	54.0	-9.2	2.16 V	303	43.3	1.5
3	*5270.00	112.1 PK			2.16 V	303	110.3	1.8
4	*5270.00	101.6 AV			2.16 V	303	99.8	1.8
5	5350.00	68.1 PK	74.0	-5.9	2.16 V	303	66.2	1.9
<b>6</b>	<b>5350.00</b>	<b>52.9 AV</b>	<b>54.0</b>	<b>-1.1</b>	<b>2.16 V</b>	<b>303</b>	<b>51.0</b>	<b>1.9</b>
7	#10540.00	61.5 PK	74.0	-12.5	2.42 V	293	49.2	12.3
8	#10540.00	49.4 AV	54.0	-4.6	2.42 V	293	37.1	12.3
9	15810.00	52.7 PK	74.0	-21.3	1.42 V	42	39.7	13.0
10	15810.00	39.5 AV	54.0	-14.5	1.42 V	42	26.5	13.0

**REMARKS:**

1. Emission Level(dBuV/m) = Raw Value(dBuV) + Correction Factor(dB/m)
2. Correction Factor(dB/m) = Antenna Factor(dB/m) + Cable Factor(dB) – Pre-Amplifier Factor(dB)
3. The other emission levels were very low against the limit.
4. Margin value = Emission Level – Limit value
5. " \* ": Fundamental frequency.
6. " # ": The radiated frequency is out of the restricted band.

<b>CHANNEL</b>	TX Channel 62	<b>DETECTOR FUNCTION</b>	Peak (PK)
<b>FREQUENCY RANGE</b>	1GHz ~ 40GHz		Average (AV)

**ANTENNA POLARITY & TEST DISTANCE: HORIZONTAL AT 3 M**

NO.	FREQ. (MHz)	EMISSION LEVEL (dBuV/m)	LIMIT (dBuV/m)	MARGIN (dB)	ANTENNA HEIGHT (m)	TABLE ANGLE (Degree)	RAW VALUE (dBuV)	CORRECTION FACTOR (dB/m)
1	*5310.00	106.6 PK			3.91 H	141	104.8	1.8
2	*5310.00	95.1 AV			3.91 H	141	93.3	1.8
3	5350.00	68.5 PK	74.0	-5.5	3.91 H	141	66.6	1.9
4	5350.00	49.1 AV	54.0	-4.9	3.91 H	141	47.2	1.9
5	10620.00	56.3 PK	74.0	-17.7	1.50 H	59	43.8	12.5
6	10620.00	44.2 AV	54.0	-9.8	1.50 H	59	31.7	12.5
7	15930.00	52.6 PK	74.0	-21.4	1.63 H	67	39.6	13.0
8	15930.00	40.3 AV	54.0	-13.7	1.63 H	67	27.3	13.0

**ANTENNA POLARITY & TEST DISTANCE: VERTICAL AT 3 M**

NO.	FREQ. (MHz)	EMISSION LEVEL (dBuV/m)	LIMIT (dBuV/m)	MARGIN (dB)	ANTENNA HEIGHT (m)	TABLE ANGLE (Degree)	RAW VALUE (dBuV)	CORRECTION FACTOR (dB/m)
1	*5310.00	108.4 PK			2.13 V	314	106.6	1.8
2	*5310.00	97.2 AV			2.13 V	314	95.4	1.8
3	5350.00	71.5 PK	74.0	-2.5	2.13 V	314	69.6	1.9
4	5350.00	52.7 AV	54.0	-1.3	2.13 V	314	50.8	1.9
5	10620.00	61.4 PK	74.0	-12.6	2.47 V	296	48.9	12.5
6	10620.00	49.1 AV	54.0	-4.9	2.47 V	296	36.6	12.5
7	15930.00	52.5 PK	74.0	-21.5	1.47 V	48	39.5	13.0
8	15930.00	39.4 AV	54.0	-14.6	1.47 V	48	26.4	13.0

**REMARKS:**

1. Emission Level(dBuV/m) = Raw Value(dBuV) + Correction Factor(dB/m)
2. Correction Factor(dB/m) = Antenna Factor(dB/m) + Cable Factor(dB) – Pre-Amplifier Factor(dB)
3. The other emission levels were very low against the limit.
4. Margin value = Emission Level – Limit value
5. " \* ": Fundamental frequency.

<b>CHANNEL</b>	TX Channel 102	<b>DETECTOR FUNCTION</b>	Peak (PK)
<b>FREQUENCY RANGE</b>	1GHz ~ 40GHz		Average (AV)

**ANTENNA POLARITY & TEST DISTANCE: HORIZONTAL AT 3 M**

NO.	FREQ. (MHz)	EMISSION LEVEL (dBuV/m)	LIMIT (dBuV/m)	MARGIN (dB)	ANTENNA HEIGHT (m)	TABLE ANGLE (Degree)	RAW VALUE (dBuV)	CORRECTION FACTOR (dB/m)
1	#5470.00	69.6 PK	74.0	-4.4	3.88 H	153	67.5	2.1
2	#5470.00	49.3 AV	54.0	-4.7	3.88 H	153	47.2	2.1
3	*5510.00	104.4 PK			3.88 H	153	102.3	2.1
4	*5510.00	93.2 AV			3.88 H	153	91.1	2.1
5	11020.00	55.8 PK	74.0	-18.2	1.52 H	74	42.6	13.2
6	11020.00	43.7 AV	54.0	-10.3	1.52 H	74	30.5	13.2
7	#16530.00	52.1 PK	74.0	-21.9	1.62 H	66	36.7	15.4
8	#16530.00	39.8 AV	54.0	-14.2	1.62 H	66	24.4	15.4

**ANTENNA POLARITY & TEST DISTANCE: VERTICAL AT 3 M**

NO.	FREQ. (MHz)	EMISSION LEVEL (dBuV/m)	LIMIT (dBuV/m)	MARGIN (dB)	ANTENNA HEIGHT (m)	TABLE ANGLE (Degree)	RAW VALUE (dBuV)	CORRECTION FACTOR (dB/m)
1	#5470.00	72.4 PK	74.0	-1.6	2.08 V	320	70.3	2.1
2	#5470.00	52.9 AV	54.0	-1.1	2.08 V	320	50.8	2.1
3	*5510.00	106.2 PK			2.08 V	320	104.1	2.1
4	*5510.00	95.3 AV			2.08 V	320	93.2	2.1
5	11020.00	61.7 PK	74.0	-12.3	2.48 V	309	48.5	13.2
6	11020.00	49.3 AV	54.0	-4.7	2.48 V	309	36.1	13.2
7	#16530.00	52.7 PK	74.0	-21.3	1.42 V	49	37.3	15.4
8	#16530.00	39.7 AV	54.0	-14.3	1.42 V	49	24.3	15.4

**REMARKS:**

1. Emission Level(dBuV/m) = Raw Value(dBuV) + Correction Factor(dB/m)
2. Correction Factor(dB/m) = Antenna Factor(dB/m) + Cable Factor(dB) – Pre-Amplifier Factor(dB)
3. The other emission levels were very low against the limit.
4. Margin value = Emission Level – Limit value
5. " \* ": Fundamental frequency.
6. " # ": The radiated frequency is out of the restricted band.



<b>CHANNEL</b>	TX Channel 110	<b>DETECTOR FUNCTION</b>	Peak (PK)
<b>FREQUENCY RANGE</b>	1GHz ~ 40GHz		Average (AV)

**ANTENNA POLARITY & TEST DISTANCE: HORIZONTAL AT 3 M**

NO.	FREQ. (MHz)	EMISSION LEVEL (dBuV/m)	LIMIT (dBuV/m)	MARGIN (dB)	ANTENNA HEIGHT (m)	TABLE ANGLE (Degree)	RAW VALUE (dBuV)	CORRECTION FACTOR (dB/m)
1	#5470.00	66.2 PK	74.0	-7.8	3.88 H	150	64.1	2.1
2	#5470.00	49.1 AV	54.0	-4.9	3.88 H	150	47.0	2.1
3	*5550.00	110.5 PK			3.88 H	150	108.2	2.3
4	*5550.00	99.1 AV			3.88 H	150	96.8	2.3
5	11100.00	55.9 PK	74.0	-18.1	1.57 H	88	42.9	13.0
6	11100.00	44.0 AV	54.0	-10.0	1.57 H	88	31.0	13.0
7	#16650.00	52.4 PK	74.0	-21.6	1.64 H	65	36.3	16.1
8	#16650.00	39.8 AV	54.0	-14.2	1.64 H	65	23.7	16.1

**ANTENNA POLARITY & TEST DISTANCE: VERTICAL AT 3 M**

NO.	FREQ. (MHz)	EMISSION LEVEL (dBuV/m)	LIMIT (dBuV/m)	MARGIN (dB)	ANTENNA HEIGHT (m)	TABLE ANGLE (Degree)	RAW VALUE (dBuV)	CORRECTION FACTOR (dB/m)
1	#5470.00	69.2 PK	74.0	-4.8	2.07 V	324	67.1	2.1
2	#5470.00	52.7 AV	54.0	-1.3	2.07 V	324	50.6	2.1
3	*5550.00	112.3 PK			2.07 V	324	110.0	2.3
4	*5550.00	101.2 AV			2.07 V	324	98.9	2.3
5	11100.00	61.3 PK	74.0	-12.7	2.48 V	308	48.3	13.0
6	11100.00	48.9 AV	54.0	-5.1	2.48 V	308	35.9	13.0
7	#16650.00	52.4 PK	74.0	-21.6	1.47 V	60	36.3	16.1
8	#16650.00	39.3 AV	54.0	-14.7	1.47 V	60	23.2	16.1

**REMARKS:**

1. Emission Level(dBuV/m) = Raw Value(dBuV) + Correction Factor(dB/m)
2. Correction Factor(dB/m) = Antenna Factor(dB/m) + Cable Factor(dB) – Pre-Amplifier Factor(dB)
3. The other emission levels were very low against the limit.
4. Margin value = Emission Level – Limit value
5. " \* ": Fundamental frequency.
6. " # ": The radiated frequency is out of the restricted band.

<b>CHANNEL</b>	TX Channel 134	<b>DETECTOR FUNCTION</b>	Peak (PK)
<b>FREQUENCY RANGE</b>	1GHz ~ 40GHz		Average (AV)

**ANTENNA POLARITY & TEST DISTANCE: HORIZONTAL AT 3 M**

NO.	FREQ. (MHz)	EMISSION LEVEL (dBuV/m)	LIMIT (dBuV/m)	MARGIN (dB)	ANTENNA HEIGHT (m)	TABLE ANGLE (Degree)	RAW VALUE (dBuV)	CORRECTION FACTOR (dB/m)
1	*5670.00	107.2 PK			3.94 H	157	104.7	2.5
2	*5670.00	96.2 AV			3.94 H	157	93.7	2.5
3	#5725.00	68.8 PK	74.0	-5.2	3.94 H	157	66.1	2.7
4	#5725.00	48.9 AV	54.0	-5.1	3.94 H	157	46.2	2.7
5	11340.00	55.8 PK	74.0	-18.2	1.57 H	100	42.2	13.6
6	11340.00	43.7 AV	54.0	-10.3	1.57 H	100	30.1	13.6
7	#17010.00	51.9 PK	74.0	-22.1	1.59 H	72	34.1	17.8
8	#17010.00	39.3 AV	54.0	-14.7	1.59 H	72	21.5	17.8

**ANTENNA POLARITY & TEST DISTANCE: VERTICAL AT 3 M**

NO.	FREQ. (MHz)	EMISSION LEVEL (dBuV/m)	LIMIT (dBuV/m)	MARGIN (dB)	ANTENNA HEIGHT (m)	TABLE ANGLE (Degree)	RAW VALUE (dBuV)	CORRECTION FACTOR (dB/m)
1	*5670.00	109.0 PK			2.18 V	298	106.5	2.5
2	*5670.00	98.3 AV			2.18 V	298	95.8	2.5
3	#5725.00	71.6 PK	74.0	-2.4	2.18 V	298	68.9	2.7
4	#5725.00	52.6 AV	54.0	-1.4	2.18 V	298	49.9	2.7
5	11340.00	61.3 PK	74.0	-12.7	2.53 V	309	47.7	13.6
6	11340.00	49.0 AV	54.0	-5.0	2.53 V	309	35.4	13.6
7	#17010.00	52.5 PK	74.0	-21.5	1.49 V	50	34.7	17.8
8	#17010.00	39.6 AV	54.0	-14.4	1.49 V	50	21.8	17.8

**REMARKS:**

1. Emission Level(dBuV/m) = Raw Value(dBuV) + Correction Factor(dB/m)
2. Correction Factor(dB/m) = Antenna Factor(dB/m) + Cable Factor(dB) – Pre-Amplifier Factor(dB)
3. The other emission levels were very low against the limit.
4. Margin value = Emission Level – Limit value
5. " \* ": Fundamental frequency.
6. " # ": The radiated frequency is out of the restricted band.

<b>CHANNEL</b>	TX Channel 142	<b>DETECTOR FUNCTION</b>	Peak (PK)
<b>FREQUENCY RANGE</b>	1GHz ~ 40GHz		Average (AV)

**ANTENNA POLARITY & TEST DISTANCE: HORIZONTAL AT 3 M**

NO.	FREQ. (MHz)	EMISSION LEVEL (dBuV/m)	LIMIT (dBuV/m)	MARGIN (dB)	ANTENNA HEIGHT (m)	TABLE ANGLE (Degree)	RAW VALUE (dBuV)	CORRECTION FACTOR (dB/m)
1	*5710.00	113.1 PK			3.97 H	167	110.4	2.7
2	*5710.00	101.7 AV			3.97 H	167	99.0	2.7
3	#5850.00	63.8 PK	74.0	-10.2	3.97 H	167	61.0	2.8
4	#5850.00	47.6 AV	54.0	-6.4	3.97 H	167	44.8	2.8
5	11420.00	55.9 PK	74.0	-18.1	1.57 H	114	42.6	13.3
6	11420.00	43.9 AV	54.0	-10.1	1.57 H	114	30.6	13.3
7	#17130.00	52.2 PK	74.0	-21.8	1.60 H	75	34.3	17.9
8	#17130.00	39.5 AV	54.0	-14.5	1.60 H	75	21.6	17.9

**ANTENNA POLARITY & TEST DISTANCE: VERTICAL AT 3 M**

NO.	FREQ. (MHz)	EMISSION LEVEL (dBuV/m)	LIMIT (dBuV/m)	MARGIN (dB)	ANTENNA HEIGHT (m)	TABLE ANGLE (Degree)	RAW VALUE (dBuV)	CORRECTION FACTOR (dB/m)
1	*5710.00	114.7 PK			2.13 V	314	112.0	2.7
2	*5710.00	103.7 AV			2.13 V	314	101.0	2.7
3	#5850.00	66.8 PK	74.0	-7.2	2.13 V	314	64.0	2.8
4	#5850.00	51.1 AV	54.0	-2.9	2.13 V	314	48.3	2.8
5	11420.00	61.2 PK	74.0	-12.8	2.57 V	296	47.9	13.3
6	11420.00	48.7 AV	54.0	-5.3	2.57 V	296	35.4	13.3
7	#17130.00	52.1 PK	74.0	-21.9	1.55 V	48	34.2	17.9
8	#17130.00	39.5 AV	54.0	-14.5	1.55 V	48	21.6	17.9

**REMARKS:**

1. Emission Level(dBuV/m) = Raw Value(dBuV) + Correction Factor(dB/m)
2. Correction Factor(dB/m) = Antenna Factor(dB/m) + Cable Factor(dB) – Pre-Amplifier Factor(dB)
3. The other emission levels were very low against the limit.
4. Margin value = Emission Level – Limit value
5. " \* ": Fundamental frequency.
6. " # ": The radiated frequency is out of the restricted band.

802.11ac (VHT80)

<b>CHANNEL</b>	TX Channel 58	<b>DETECTOR FUNCTION</b>	Peak (PK)
<b>FREQUENCY RANGE</b>	1GHz ~ 40GHz		Average (AV)

**ANTENNA POLARITY & TEST DISTANCE: HORIZONTAL AT 3 M**

NO.	FREQ. (MHz)	EMISSION LEVEL (dBuV/m)	LIMIT (dBuV/m)	MARGIN (dB)	ANTENNA HEIGHT (m)	TABLE ANGLE (Degree)	RAW VALUE (dBuV)	CORRECTION FACTOR (dB/m)
1	5150.00	57.2 PK	74.0	-16.8	3.96 H	180	55.7	1.5
2	5150.00	43.2 AV	54.0	-10.8	3.96 H	180	41.7	1.5
3	*5290.00	102.2 PK			3.96 H	180	100.4	1.8
4	*5290.00	92.7 AV			3.96 H	180	90.9	1.8
5	5350.00	66.2 PK	74.0	-7.8	3.96 H	180	64.3	1.9
6	5350.00	49.3 AV	54.0	-4.7	3.96 H	180	47.4	1.9
7	#10580.00	55.5 PK	74.0	-18.5	1.60 H	112	43.1	12.4
8	#10580.00	43.5 AV	54.0	-10.5	1.60 H	112	31.1	12.4
9	15870.00	52.8 PK	74.0	-21.2	1.55 H	87	39.8	13.0
10	15870.00	39.9 AV	54.0	-14.1	1.55 H	87	26.9	13.0

**ANTENNA POLARITY & TEST DISTANCE: VERTICAL AT 3 M**

NO.	FREQ. (MHz)	EMISSION LEVEL (dBuV/m)	LIMIT (dBuV/m)	MARGIN (dB)	ANTENNA HEIGHT (m)	TABLE ANGLE (Degree)	RAW VALUE (dBuV)	CORRECTION FACTOR (dB/m)
1	5150.00	60.0 PK	74.0	-14.0	2.13 V	317	58.5	1.5
2	5150.00	46.9 AV	54.0	-7.1	2.13 V	317	45.4	1.5
3	*5290.00	104.0 PK			2.13 V	317	102.2	1.8
4	*5290.00	94.8 AV			2.13 V	317	93.0	1.8
5	5350.00	69.2 PK	74.0	-4.8	2.13 V	317	67.3	1.9
<b>6</b>	<b>5350.00</b>	<b>52.9 AV</b>	<b>54.0</b>	<b>-1.1</b>	<b>2.13 V</b>	<b>317</b>	<b>51.0</b>	<b>1.9</b>
7	#10580.00	61.2 PK	74.0	-12.8	2.52 V	308	48.8	12.4
8	#10580.00	48.9 AV	54.0	-5.1	2.52 V	308	36.5	12.4
9	15870.00	51.7 PK	74.0	-22.3	1.60 V	59	38.7	13.0
10	15870.00	39.0 AV	54.0	-15.0	1.60 V	59	26.0	13.0

**REMARKS:**

1. Emission Level(dBuV/m) = Raw Value(dBuV) + Correction Factor(dB/m)
2. Correction Factor(dB/m) = Antenna Factor(dB/m) + Cable Factor(dB) – Pre-Amplifier Factor(dB)
3. The other emission levels were very low against the limit.
4. Margin value = Emission Level – Limit value
5. " \* ": Fundamental frequency.
6. " # ": The radiated frequency is out of the restricted band.

<b>CHANNEL</b>	TX Channel 106	<b>DETECTOR FUNCTION</b>	Peak (PK)
<b>FREQUENCY RANGE</b>	1GHz ~ 40GHz		Average (AV)

**ANTENNA POLARITY & TEST DISTANCE: HORIZONTAL AT 3 M**

NO.	FREQ. (MHz)	EMISSION LEVEL (dBuV/m)	LIMIT (dBuV/m)	MARGIN (dB)	ANTENNA HEIGHT (m)	TABLE ANGLE (Degree)	RAW VALUE (dBuV)	CORRECTION FACTOR (dB/m)
1	#5470.00	63.1 PK	74.0	-10.9	3.90 H	175	61.0	2.1
2	#5470.00	49.1 AV	54.0	-4.9	3.90 H	175	47.0	2.1
3	*5530.00	100.4 PK			3.90 H	175	98.2	2.2
4	*5530.00	90.9 AV			3.90 H	175	88.7	2.2
5	11060.00	55.4 PK	74.0	-18.6	1.65 H	115	42.3	13.1
6	11060.00	43.2 AV	54.0	-10.8	1.65 H	115	30.1	13.1
7	#16590.00	53.0 PK	74.0	-21.0	1.60 H	81	36.8	16.2
8	#16590.00	40.3 AV	54.0	-13.7	1.60 H	81	24.1	16.2

**ANTENNA POLARITY & TEST DISTANCE: VERTICAL AT 3 M**

NO.	FREQ. (MHz)	EMISSION LEVEL (dBuV/m)	LIMIT (dBuV/m)	MARGIN (dB)	ANTENNA HEIGHT (m)	TABLE ANGLE (Degree)	RAW VALUE (dBuV)	CORRECTION FACTOR (dB/m)
1	#5470.00	66.1 PK	74.0	-7.9	2.13 V	314	64.0	2.1
2	#5470.00	52.7 AV	54.0	-1.3	2.13 V	314	50.6	2.1
3	*5530.00	102.2 PK			2.13 V	314	100.0	2.2
4	*5530.00	93.0 AV			2.13 V	314	90.8	2.2
5	11060.00	61.9 PK	74.0	-12.1	2.56 V	309	48.8	13.1
6	11060.00	49.4 AV	54.0	-4.6	2.56 V	309	36.3	13.1
7	#16590.00	51.9 PK	74.0	-22.1	1.59 V	58	35.7	16.2
8	#16590.00	39.1 AV	54.0	-14.9	1.59 V	58	22.9	16.2

**REMARKS:**

1. Emission Level(dBuV/m) = Raw Value(dBuV) + Correction Factor(dB/m)
2. Correction Factor(dB/m) = Antenna Factor(dB/m) + Cable Factor(dB) – Pre-Amplifier Factor(dB)
3. The other emission levels were very low against the limit.
4. Margin value = Emission Level – Limit value
5. " \* ": Fundamental frequency.
6. " # ": The radiated frequency is out of the restricted band.

<b>CHANNEL</b>	TX Channel 122	<b>DETECTOR FUNCTION</b>	Peak (PK)
<b>FREQUENCY RANGE</b>	1GHz ~ 40GHz		Average (AV)

**ANTENNA POLARITY & TEST DISTANCE: HORIZONTAL AT 3 M**

NO.	FREQ. (MHz)	EMISSION LEVEL (dBuV/m)	LIMIT (dBuV/m)	MARGIN (dB)	ANTENNA HEIGHT (m)	TABLE ANGLE (Degree)	RAW VALUE (dBuV)	CORRECTION FACTOR (dB/m)
1	#5470.00	61.2 PK	74.0	-12.8	3.89 H	182	59.1	2.1
2	#5470.00	49.5 AV	54.0	-4.5	3.89 H	182	47.4	2.1
3	*5610.00	106.1 PK			3.89 H	182	103.6	2.5
4	*5610.00	96.5 AV			3.89 H	182	94.0	2.5
5	#5725.00	64.0 PK	74.0	-10.0	3.89 H	182	61.3	2.7
6	#5725.00	49.3 AV	54.0	-4.7	3.89 H	182	46.6	2.7
7	11220.00	55.5 PK	74.0	-18.5	1.70 H	129	42.2	13.3
8	11220.00	43.1 AV	54.0	-10.9	1.70 H	129	29.8	13.3
9	#16830.00	52.7 PK	74.0	-21.3	1.60 H	74	36.0	16.7
10	#16830.00	40.2 AV	54.0	-13.8	1.60 H	74	23.5	16.7

**ANTENNA POLARITY & TEST DISTANCE: VERTICAL AT 3 M**

NO.	FREQ. (MHz)	EMISSION LEVEL (dBuV/m)	LIMIT (dBuV/m)	MARGIN (dB)	ANTENNA HEIGHT (m)	TABLE ANGLE (Degree)	RAW VALUE (dBuV)	CORRECTION FACTOR (dB/m)
1	#5470.00	65.2 PK	74.0	-8.8	2.08 V	321	63.1	2.1
2	#5470.00	52.8 AV	54.0	-1.2	2.08 V	321	50.7	2.1
3	*5610.00	107.9 PK			2.08 V	321	105.4	2.5
4	*5610.00	98.6 AV			2.08 V	321	96.1	2.5
5	#5725.00	67.0 PK	74.0	-7.0	2.08 V	321	64.3	2.7
6	#5725.00	52.9 AV	54.0	-1.1	2.08 V	321	50.2	2.7
7	11220.00	62.2 PK	74.0	-11.8	2.53 V	311	48.9	13.3
8	11220.00	49.4 AV	54.0	-4.6	2.53 V	311	36.1	13.3
9	#16830.00	52.1 PK	74.0	-21.9	1.61 V	43	35.4	16.7
10	#16830.00	39.2 AV	54.0	-14.8	1.61 V	43	22.5	16.7

**REMARKS:**

1. Emission Level(dBuV/m) = Raw Value(dBuV) + Correction Factor(dB/m)
2. Correction Factor(dB/m) = Antenna Factor(dB/m) + Cable Factor(dB) – Pre-Amplifier Factor(dB)
3. The other emission levels were very low against the limit.
4. Margin value = Emission Level – Limit value
5. " \* ": Fundamental frequency.
6. " # ": The radiated frequency is out of the restricted band.

<b>CHANNEL</b>	TX Channel 138	<b>DETECTOR FUNCTION</b>	Peak (PK)
<b>FREQUENCY RANGE</b>	1GHz ~ 40GHz		Average (AV)

**ANTENNA POLARITY & TEST DISTANCE: HORIZONTAL AT 3 M**

NO.	FREQ. (MHz)	EMISSION LEVEL (dBuV/m)	LIMIT (dBuV/m)	MARGIN (dB)	ANTENNA HEIGHT (m)	TABLE ANGLE (Degree)	RAW VALUE (dBuV)	CORRECTION FACTOR (dB/m)
1	#5470.00	61.5 PK	74.0	-12.5	3.87 H	197	59.4	2.1
2	#5470.00	44.2 AV	54.0	-9.8	3.87 H	197	42.1	2.1
3	*5690.00	108.2 PK			3.87 H	197	105.5	2.7
4	*5690.00	98.4 AV			3.87 H	197	95.7	2.7
5	#5850.00	63.5 PK	74.0	-10.5	3.87 H	197	60.7	2.8
6	#5850.00	49.2 AV	54.0	-4.8	3.87 H	197	46.4	2.8
7	11380.00	55.6 PK	74.0	-18.4	1.68 H	143	42.2	13.4
8	11380.00	43.4 AV	54.0	-10.6	1.68 H	143	30.0	13.4
9	#17070.00	52.9 PK	74.0	-21.1	1.65 H	65	35.1	17.8
10	#17070.00	40.6 AV	54.0	-13.4	1.65 H	65	22.8	17.8

**ANTENNA POLARITY & TEST DISTANCE: VERTICAL AT 3 M**

NO.	FREQ. (MHz)	EMISSION LEVEL (dBuV/m)	LIMIT (dBuV/m)	MARGIN (dB)	ANTENNA HEIGHT (m)	TABLE ANGLE (Degree)	RAW VALUE (dBuV)	CORRECTION FACTOR (dB/m)
1	#5470.00	64.5 PK	74.0	-9.5	2.14 V	316	62.4	2.1
2	#5470.00	47.8 AV	54.0	-6.2	2.14 V	316	45.7	2.1
3	*5690.00	110.0 PK			2.14 V	316	107.3	2.7
4	*5690.00	100.5 AV			2.14 V	316	97.8	2.7
5	#5850.00	66.5 PK	74.0	-7.5	2.14 V	316	63.7	2.8
6	#5850.00	52.8 AV	54.0	-1.2	2.14 V	316	50.0	2.8
7	11380.00	62.2 PK	74.0	-11.8	2.56 V	319	48.8	13.4
8	11380.00	49.5 AV	54.0	-4.5	2.56 V	319	36.1	13.4
9	#17070.00	52.0 PK	74.0	-22.0	1.63 V	56	34.2	17.8
10	#17070.00	39.0 AV	54.0	-15.0	1.63 V	56	21.2	17.8

**REMARKS:**

1. Emission Level(dBuV/m) = Raw Value(dBuV) + Correction Factor(dB/m)
2. Correction Factor(dB/m) = Antenna Factor(dB/m) + Cable Factor(dB) – Pre-Amplifier Factor(dB)
3. The other emission levels were very low against the limit.
4. Margin value = Emission Level – Limit value
5. " \* ": Fundamental frequency.
6. " # ": The radiated frequency is out of the restricted band.

**Below 1GHz Data:**

**802.11a**

<b>CHANNEL</b>	TX Channel 52	<b>DETECTOR FUNCTION</b>	Quasi-Peak (QP)
<b>FREQUENCY RANGE</b>	9kHz ~ 1GHz		

**ANTENNA POLARITY & TEST DISTANCE: HORIZONTAL AT 3 M**

NO.	FREQ. (MHz)	EMISSION LEVEL (dBuV/m)	LIMIT (dBuV/m)	MARGIN (dB)	ANTENNA HEIGHT (m)	TABLE ANGLE (Degree)	RAW VALUE (dBuV)	CORRECTION FACTOR (dB/m)
1	30.54	30.8 QP	40.0	-9.2	1.95 H	249	40.7	-9.9
2	114.20	25.3 QP	43.5	-18.2	1.52 H	61	36.4	-11.1
3	249.97	34.2 QP	46.0	-11.8	1.00 H	66	44.2	-10.0
4	320.45	33.5 QP	46.0	-12.5	1.03 H	41	40.9	-7.4
5	497.80	27.8 QP	46.0	-18.2	1.53 H	41	30.6	-2.8
6	920.61	30.6 QP	46.0	-15.4	2.46 H	94	26.4	4.2

**ANTENNA POLARITY & TEST DISTANCE: VERTICAL AT 3 M**

NO.	FREQ. (MHz)	EMISSION LEVEL (dBuV/m)	LIMIT (dBuV/m)	MARGIN (dB)	ANTENNA HEIGHT (m)	TABLE ANGLE (Degree)	RAW VALUE (dBuV)	CORRECTION FACTOR (dB/m)
1	30.77	32.5 QP	40.0	-7.5	2.04 V	322	42.5	-10.0
2	42.67	30.1 QP	40.0	-9.9	1.05 V	360	39.0	-8.9
3	250.26	28.0 QP	46.0	-18.0	1.53 V	355	38.0	-10.0
4	320.49	26.4 QP	46.0	-19.6	1.48 V	360	33.8	-7.4
5	497.34	26.0 QP	46.0	-20.0	1.01 V	280	28.8	-2.8
6	926.01	29.6 QP	46.0	-16.4	2.51 V	50	25.3	4.3

**REMARKS:**

1. Emission Level(dBuV/m) = Raw Value(dBuV) + Correction Factor(dB/m)
2. Correction Factor(dB/m) = Antenna Factor(dB/m) + Cable Factor(dB) – Pre-Amplifier Factor(dB)
3. The other emission levels were very low against the limit.
4. Margin value = Emission Level – Limit value



<b>CHANNEL</b>	TX Channel 60	<b>DETECTOR FUNCTION</b>	Quasi-Peak (QP)
<b>FREQUENCY RANGE</b>	9kHz ~ 1GHz		

**ANTENNA POLARITY & TEST DISTANCE: HORIZONTAL AT 3 M**

NO.	FREQ. (MHz)	EMISSION LEVEL (dBuV/m)	LIMIT (dBuV/m)	MARGIN (dB)	ANTENNA HEIGHT (m)	TABLE ANGLE (Degree)	RAW VALUE (dBuV)	CORRECTION FACTOR (dB/m)
1	30.68	31.1 QP	40.0	-8.9	1.95 H	243	41.1	-10.0
2	114.25	25.9 QP	43.5	-17.6	1.45 H	85	37.0	-11.1
3	250.16	34.3 QP	46.0	-11.7	1.00 H	73	44.3	-10.0
4	320.46	33.6 QP	46.0	-12.4	1.06 H	48	41.0	-7.4
5	498.03	27.6 QP	46.0	-18.4	1.53 H	44	30.4	-2.8
6	920.61	31.1 QP	46.0	-14.9	2.46 H	107	26.9	4.2

**ANTENNA POLARITY & TEST DISTANCE: VERTICAL AT 3 M**

NO.	FREQ. (MHz)	EMISSION LEVEL (dBuV/m)	LIMIT (dBuV/m)	MARGIN (dB)	ANTENNA HEIGHT (m)	TABLE ANGLE (Degree)	RAW VALUE (dBuV)	CORRECTION FACTOR (dB/m)
1	30.70	33.0 QP	40.0	-7.0	2.03 V	312	43.0	-10.0
2	42.76	29.7 QP	40.0	-10.3	1.05 V	360	38.5	-8.8
3	250.02	27.6 QP	46.0	-18.4	1.44 V	351	37.6	-10.0
4	320.96	26.5 QP	46.0	-19.5	1.53 V	360	33.9	-7.4
5	497.21	26.1 QP	46.0	-19.9	1.00 V	292	28.9	-2.8
6	926.01	29.6 QP	46.0	-16.4	2.48 V	65	25.3	4.3

**REMARKS:**

1. Emission Level(dBuV/m) = Raw Value(dBuV) + Correction Factor(dB/m)
2. Correction Factor(dB/m) = Antenna Factor(dB/m) + Cable Factor(dB) – Pre-Amplifier Factor(dB)
3. The other emission levels were very low against the limit.
4. Margin value = Emission Level – Limit value

<b>CHANNEL</b>	TX Channel 64	<b>DETECTOR FUNCTION</b>	Quasi-Peak (QP)
<b>FREQUENCY RANGE</b>	9kHz ~ 1GHz		

**ANTENNA POLARITY & TEST DISTANCE: HORIZONTAL AT 3 M**

NO.	FREQ. (MHz)	EMISSION LEVEL (dBuV/m)	LIMIT (dBuV/m)	MARGIN (dB)	ANTENNA HEIGHT (m)	TABLE ANGLE (Degree)	RAW VALUE (dBuV)	CORRECTION FACTOR (dB/m)
1	30.64	31.1 QP	40.0	-8.9	2.04 H	270	41.1	-10.0
2	114.55	25.7 QP	43.5	-17.8	1.52 H	81	36.8	-11.1
3	249.98	34.3 QP	46.0	-11.7	1.01 H	78	44.3	-10.0
4	320.60	33.8 QP	46.0	-12.2	1.00 H	60	41.2	-7.4
5	497.69	27.5 QP	46.0	-18.5	1.53 H	62	30.3	-2.8
6	920.61	30.6 QP	46.0	-15.4	2.46 H	86	26.4	4.2

**ANTENNA POLARITY & TEST DISTANCE: VERTICAL AT 3 M**

NO.	FREQ. (MHz)	EMISSION LEVEL (dBuV/m)	LIMIT (dBuV/m)	MARGIN (dB)	ANTENNA HEIGHT (m)	TABLE ANGLE (Degree)	RAW VALUE (dBuV)	CORRECTION FACTOR (dB/m)
1	30.56	32.5 QP	40.0	-7.5	1.95 V	332	42.4	-9.9
2	42.90	30.0 QP	40.0	-10.0	1.00 V	346	38.8	-8.8
3	250.10	27.6 QP	46.0	-18.4	1.51 V	360	37.6	-10.0
4	320.42	26.4 QP	46.0	-19.6	1.51 V	352	33.8	-7.4
5	497.25	25.8 QP	46.0	-20.2	1.00 V	281	28.6	-2.8
6	926.01	30.1 QP	46.0	-15.9	2.47 V	69	25.8	4.3

**REMARKS:**

1. Emission Level(dBuV/m) = Raw Value(dBuV) + Correction Factor(dB/m)
2. Correction Factor(dB/m) = Antenna Factor(dB/m) + Cable Factor(dB) – Pre-Amplifier Factor(dB)
3. The other emission levels were very low against the limit.
4. Margin value = Emission Level – Limit value

<b>CHANNEL</b>	TX Channel 100	<b>DETECTOR FUNCTION</b>	Quasi-Peak (QP)
<b>FREQUENCY RANGE</b>	9kHz ~ 1GHz		

**ANTENNA POLARITY & TEST DISTANCE: HORIZONTAL AT 3 M**

NO.	FREQ. (MHz)	EMISSION LEVEL (dBuV/m)	LIMIT (dBuV/m)	MARGIN (dB)	ANTENNA HEIGHT (m)	TABLE ANGLE (Degree)	RAW VALUE (dBuV)	CORRECTION FACTOR (dB/m)
1	30.63	30.8 QP	40.0	-9.2	2.04 H	246	40.8	-10.0
2	114.48	25.8 QP	43.5	-17.7	1.45 H	73	36.9	-11.1
3	249.89	34.1 QP	46.0	-11.9	1.00 H	87	44.1	-10.0
4	320.42	33.5 QP	46.0	-12.5	1.02 H	31	40.9	-7.4
5	497.75	27.7 QP	46.0	-18.3	1.47 H	63	30.5	-2.8
6	920.61	30.6 QP	46.0	-15.4	2.50 H	82	26.4	4.2

**ANTENNA POLARITY & TEST DISTANCE: VERTICAL AT 3 M**

NO.	FREQ. (MHz)	EMISSION LEVEL (dBuV/m)	LIMIT (dBuV/m)	MARGIN (dB)	ANTENNA HEIGHT (m)	TABLE ANGLE (Degree)	RAW VALUE (dBuV)	CORRECTION FACTOR (dB/m)
1	30.59	32.9 QP	40.0	-7.1	2.01 V	334	42.9	-10.0
2	42.60	29.9 QP	40.0	-10.1	1.03 V	348	38.8	-8.9
3	249.77	27.6 QP	46.0	-18.4	1.55 V	347	37.6	-10.0
4	320.74	26.9 QP	46.0	-19.1	1.53 V	360	34.3	-7.4
5	497.04	25.9 QP	46.0	-20.1	1.05 V	283	28.7	-2.8
6	926.01	30.0 QP	46.0	-16.0	2.47 V	79	25.7	4.3

**REMARKS:**

1. Emission Level(dBuV/m) = Raw Value(dBuV) + Correction Factor(dB/m)
2. Correction Factor(dB/m) = Antenna Factor(dB/m) + Cable Factor(dB) – Pre-Amplifier Factor(dB)
3. The other emission levels were very low against the limit.
4. Margin value = Emission Level – Limit value

<b>CHANNEL</b>	TX Channel 116	<b>DETECTOR FUNCTION</b>	Quasi-Peak (QP)
<b>FREQUENCY RANGE</b>	9kHz ~ 1GHz		

**ANTENNA POLARITY & TEST DISTANCE: HORIZONTAL AT 3 M**

NO.	FREQ. (MHz)	EMISSION LEVEL (dBuV/m)	LIMIT (dBuV/m)	MARGIN (dB)	ANTENNA HEIGHT (m)	TABLE ANGLE (Degree)	RAW VALUE (dBuV)	CORRECTION FACTOR (dB/m)
1	30.60	31.1 QP	40.0	-8.9	2.02 H	242	41.1	-10.0
2	114.50	25.7 QP	43.5	-17.8	1.55 H	61	36.8	-11.1
3	249.77	34.0 QP	46.0	-12.0	1.00 H	78	44.0	-10.0
4	320.86	33.5 QP	46.0	-12.5	1.02 H	43	40.9	-7.4
5	497.65	27.5 QP	46.0	-18.5	1.50 H	46	30.3	-2.8
6	920.61	31.0 QP	46.0	-15.0	2.51 H	101	26.8	4.2

**ANTENNA POLARITY & TEST DISTANCE: VERTICAL AT 3 M**

NO.	FREQ. (MHz)	EMISSION LEVEL (dBuV/m)	LIMIT (dBuV/m)	MARGIN (dB)	ANTENNA HEIGHT (m)	TABLE ANGLE (Degree)	RAW VALUE (dBuV)	CORRECTION FACTOR (dB/m)
1	30.38	32.7 QP	40.0	-7.3	2.04 V	339	42.6	-9.9
2	42.31	29.7 QP	40.0	-10.3	1.00 V	358	38.6	-8.9
3	250.14	27.7 QP	46.0	-18.3	1.49 V	360	37.7	-10.0
4	320.52	26.8 QP	46.0	-19.2	1.48 V	348	34.2	-7.4
5	497.24	25.9 QP	46.0	-20.1	1.00 V	306	28.7	-2.8
6	926.01	30.0 QP	46.0	-16.0	2.55 V	72	25.7	4.3

**REMARKS:**

1. Emission Level(dBuV/m) = Raw Value(dBuV) + Correction Factor(dB/m)
2. Correction Factor(dB/m) = Antenna Factor(dB/m) + Cable Factor(dB) – Pre-Amplifier Factor(dB)
3. The other emission levels were very low against the limit.
4. Margin value = Emission Level – Limit value

<b>CHANNEL</b>	TX Channel 140	<b>DETECTOR FUNCTION</b>	Quasi-Peak (QP)
<b>FREQUENCY RANGE</b>	9kHz ~ 1GHz		

**ANTENNA POLARITY & TEST DISTANCE: HORIZONTAL AT 3 M**

NO.	FREQ. (MHz)	EMISSION LEVEL (dBuV/m)	LIMIT (dBuV/m)	MARGIN (dB)	ANTENNA HEIGHT (m)	TABLE ANGLE (Degree)	RAW VALUE (dBuV)	CORRECTION FACTOR (dB/m)
1	30.91	30.8 QP	40.0	-9.2	1.94 H	249	40.8	-10.0
2	114.54	25.9 QP	43.5	-17.6	1.53 H	65	37.0	-11.1
3	249.84	34.3 QP	46.0	-11.7	1.03 H	81	44.3	-10.0
4	320.61	33.6 QP	46.0	-12.4	1.00 H	45	41.0	-7.4
5	497.72	27.5 QP	46.0	-18.5	1.54 H	48	30.3	-2.8
6	920.61	30.8 QP	46.0	-15.2	2.46 H	93	26.6	4.2

**ANTENNA POLARITY & TEST DISTANCE: VERTICAL AT 3 M**

NO.	FREQ. (MHz)	EMISSION LEVEL (dBuV/m)	LIMIT (dBuV/m)	MARGIN (dB)	ANTENNA HEIGHT (m)	TABLE ANGLE (Degree)	RAW VALUE (dBuV)	CORRECTION FACTOR (dB/m)
1	30.83	33.0 QP	40.0	-7.0	2.03 V	316	43.0	-10.0
2	42.40	29.5 QP	40.0	-10.5	1.01 V	360	38.4	-8.9
3	249.99	27.9 QP	46.0	-18.1	1.56 V	355	37.9	-10.0
4	320.43	26.3 QP	46.0	-19.7	1.47 V	360	33.7	-7.4
5	497.38	25.9 QP	46.0	-20.1	1.00 V	300	28.7	-2.8
6	926.01	30.0 QP	46.0	-16.0	2.51 V	51	25.7	4.3

**REMARKS:**

1. Emission Level(dBuV/m) = Raw Value(dBuV) + Correction Factor(dB/m)
2. Correction Factor(dB/m) = Antenna Factor(dB/m) + Cable Factor(dB) – Pre-Amplifier Factor(dB)
3. The other emission levels were very low against the limit.
4. Margin value = Emission Level – Limit value

<b>CHANNEL</b>	TX Channel 144	<b>DETECTOR FUNCTION</b>	Quasi-Peak (QP)
<b>FREQUENCY RANGE</b>	9kHz ~ 1GHz		

**ANTENNA POLARITY & TEST DISTANCE: HORIZONTAL AT 3 M**

NO.	FREQ. (MHz)	EMISSION LEVEL (dBuV/m)	LIMIT (dBuV/m)	MARGIN (dB)	ANTENNA HEIGHT (m)	TABLE ANGLE (Degree)	RAW VALUE (dBuV)	CORRECTION FACTOR (dB/m)
1	30.49	30.8 QP	40.0	-9.2	2.03 H	258	40.7	-9.9
2	114.29	25.7 QP	43.5	-17.8	1.51 H	73	36.8	-11.1
3	249.83	33.9 QP	46.0	-12.1	1.00 H	62	43.9	-10.0
4	320.96	33.6 QP	46.0	-12.4	1.01 H	57	41.0	-7.4
5	497.89	27.9 QP	46.0	-18.1	1.54 H	43	30.7	-2.8
6	920.61	30.6 QP	46.0	-15.4	2.45 H	103	26.4	4.2

**ANTENNA POLARITY & TEST DISTANCE: VERTICAL AT 3 M**

NO.	FREQ. (MHz)	EMISSION LEVEL (dBuV/m)	LIMIT (dBuV/m)	MARGIN (dB)	ANTENNA HEIGHT (m)	TABLE ANGLE (Degree)	RAW VALUE (dBuV)	CORRECTION FACTOR (dB/m)
1	30.77	32.5 QP	40.0	-7.5	1.95 V	323	42.5	-10.0
2	42.45	29.8 QP	40.0	-10.2	1.00 V	345	38.7	-8.9
3	250.30	27.8 QP	46.0	-18.2	1.45 V	360	37.8	-10.0
4	320.46	26.5 QP	46.0	-19.5	1.54 V	360	33.9	-7.4
5	497.50	26.2 QP	46.0	-19.8	1.00 V	284	29.0	-2.8
6	926.01	30.2 QP	46.0	-15.8	2.51 V	71	25.9	4.3

**REMARKS:**

1. Emission Level(dBuV/m) = Raw Value(dBuV) + Correction Factor(dB/m)
2. Correction Factor(dB/m) = Antenna Factor(dB/m) + Cable Factor(dB) – Pre-Amplifier Factor(dB)
3. The other emission levels were very low against the limit.
4. Margin value = Emission Level – Limit value

802.11ac (VHT20)

<b>CHANNEL</b>	TX Channel 52	<b>DETECTOR FUNCTION</b>	Quasi-Peak (QP)
<b>FREQUENCY RANGE</b>	9kHz ~ 1GHz		

**ANTENNA POLARITY & TEST DISTANCE: HORIZONTAL AT 3 M**

NO.	FREQ. (MHz)	EMISSION LEVEL (dBuV/m)	LIMIT (dBuV/m)	MARGIN (dB)	ANTENNA HEIGHT (m)	TABLE ANGLE (Degree)	RAW VALUE (dBuV)	CORRECTION FACTOR (dB/m)
1	30.83	31.0 QP	40.0	-9.0	2.06 H	269	41.0	-10.0
2	114.26	25.5 QP	43.5	-18.0	1.44 H	86	36.6	-11.1
3	249.98	34.4 QP	46.0	-11.6	1.01 H	75	44.4	-10.0
4	320.84	33.5 QP	46.0	-12.5	1.00 H	35	40.9	-7.4
5	497.71	27.8 QP	46.0	-18.2	1.50 H	62	30.6	-2.8
6	920.61	30.5 QP	46.0	-15.5	2.46 H	101	26.3	4.2

**ANTENNA POLARITY & TEST DISTANCE: VERTICAL AT 3 M**

NO.	FREQ. (MHz)	EMISSION LEVEL (dBuV/m)	LIMIT (dBuV/m)	MARGIN (dB)	ANTENNA HEIGHT (m)	TABLE ANGLE (Degree)	RAW VALUE (dBuV)	CORRECTION FACTOR (dB/m)
1	30.45	32.8 QP	40.0	-7.2	2.05 V	324	42.7	-9.9
2	42.61	30.1 QP	40.0	-9.9	1.00 V	359	39.0	-8.9
3	249.81	27.7 QP	46.0	-18.3	1.46 V	350	37.7	-10.0
4	320.83	26.3 QP	46.0	-19.7	1.54 V	352	33.7	-7.4
5	497.31	25.9 QP	46.0	-20.1	1.01 V	284	28.7	-2.8
6	926.01	29.8 QP	46.0	-16.2	2.45 V	64	25.5	4.3

**REMARKS:**

1. Emission Level(dBuV/m) = Raw Value(dBuV) + Correction Factor(dB/m)
2. Correction Factor(dB/m) = Antenna Factor(dB/m) + Cable Factor(dB) – Pre-Amplifier Factor(dB)
3. The other emission levels were very low against the limit.
4. Margin value = Emission Level – Limit value

<b>CHANNEL</b>	TX Channel 60	<b>DETECTOR FUNCTION</b>	Quasi-Peak (QP)
<b>FREQUENCY RANGE</b>	9kHz ~ 1GHz		

**ANTENNA POLARITY & TEST DISTANCE: HORIZONTAL AT 3 M**

NO.	FREQ. (MHz)	EMISSION LEVEL (dBuV/m)	LIMIT (dBuV/m)	MARGIN (dB)	ANTENNA HEIGHT (m)	TABLE ANGLE (Degree)	RAW VALUE (dBuV)	CORRECTION FACTOR (dB/m)
1	30.48	31.0 QP	40.0	-9.0	2.02 H	258	40.9	-9.9
2	114.20	25.6 QP	43.5	-17.9	1.45 H	74	36.7	-11.1
3	250.25	34.0 QP	46.0	-12.0	1.03 H	64	44.0	-10.0
4	320.87	34.0 QP	46.0	-12.0	1.05 H	42	41.4	-7.4
5	497.81	27.9 QP	46.0	-18.1	1.50 H	46	30.7	-2.8
6	920.61	30.6 QP	46.0	-15.4	2.53 H	87	26.4	4.2

**ANTENNA POLARITY & TEST DISTANCE: VERTICAL AT 3 M**

NO.	FREQ. (MHz)	EMISSION LEVEL (dBuV/m)	LIMIT (dBuV/m)	MARGIN (dB)	ANTENNA HEIGHT (m)	TABLE ANGLE (Degree)	RAW VALUE (dBuV)	CORRECTION FACTOR (dB/m)
1	30.91	32.8 QP	40.0	-7.2	2.03 V	320	42.8	-10.0
2	42.50	29.9 QP	40.0	-10.1	1.00 V	352	38.8	-8.9
3	249.98	27.8 QP	46.0	-18.2	1.53 V	356	37.8	-10.0
4	320.59	26.4 QP	46.0	-19.6	1.51 V	353	33.8	-7.4
5	497.07	25.9 QP	46.0	-20.1	1.00 V	290	28.7	-2.8
6	926.01	29.8 QP	46.0	-16.2	2.54 V	52	25.5	4.3

**REMARKS:**

1. Emission Level(dBuV/m) = Raw Value(dBuV) + Correction Factor(dB/m)
2. Correction Factor(dB/m) = Antenna Factor(dB/m) + Cable Factor(dB) – Pre-Amplifier Factor(dB)
3. The other emission levels were very low against the limit.
4. Margin value = Emission Level – Limit value



<b>CHANNEL</b>	TX Channel 64	<b>DETECTOR FUNCTION</b>	Quasi-Peak (QP)
<b>FREQUENCY RANGE</b>	9kHz ~ 1GHz		

**ANTENNA POLARITY & TEST DISTANCE: HORIZONTAL AT 3 M**

NO.	FREQ. (MHz)	EMISSION LEVEL (dBuV/m)	LIMIT (dBuV/m)	MARGIN (dB)	ANTENNA HEIGHT (m)	TABLE ANGLE (Degree)	RAW VALUE (dBuV)	CORRECTION FACTOR (dB/m)
1	30.51	30.9 QP	40.0	-9.1	2.02 H	248	40.8	-9.9
2	114.18	25.6 QP	43.5	-17.9	1.46 H	72	36.7	-11.1
3	250.14	34.1 QP	46.0	-11.9	1.00 H	64	44.1	-10.0
4	320.75	33.6 QP	46.0	-12.4	1.00 H	33	41.0	-7.4
5	497.92	27.9 QP	46.0	-18.1	1.49 H	44	30.7	-2.8
6	920.61	30.7 QP	46.0	-15.3	2.49 H	86	26.5	4.2

**ANTENNA POLARITY & TEST DISTANCE: VERTICAL AT 3 M**

NO.	FREQ. (MHz)	EMISSION LEVEL (dBuV/m)	LIMIT (dBuV/m)	MARGIN (dB)	ANTENNA HEIGHT (m)	TABLE ANGLE (Degree)	RAW VALUE (dBuV)	CORRECTION FACTOR (dB/m)
1	30.83	32.8 QP	40.0	-7.2	2.03 V	334	42.8	-10.0
2	42.49	29.6 QP	40.0	-10.4	1.00 V	348	38.5	-8.9
3	250.18	27.4 QP	46.0	-18.6	1.52 V	345	37.4	-10.0
4	320.53	26.9 QP	46.0	-19.1	1.55 V	345	34.3	-7.4
5	497.08	25.9 QP	46.0	-20.1	1.00 V	299	28.7	-2.8
6	926.01	29.7 QP	46.0	-16.3	2.44 V	68	25.4	4.3

**REMARKS:**

1. Emission Level(dBuV/m) = Raw Value(dBuV) + Correction Factor(dB/m)
2. Correction Factor(dB/m) = Antenna Factor(dB/m) + Cable Factor(dB) – Pre-Amplifier Factor(dB)
3. The other emission levels were very low against the limit.
4. Margin value = Emission Level – Limit value

<b>CHANNEL</b>	TX Channel 100	<b>DETECTOR FUNCTION</b>	Quasi-Peak (QP)
<b>FREQUENCY RANGE</b>	9kHz ~ 1GHz		

**ANTENNA POLARITY & TEST DISTANCE: HORIZONTAL AT 3 M**

NO.	FREQ. (MHz)	EMISSION LEVEL (dBuV/m)	LIMIT (dBuV/m)	MARGIN (dB)	ANTENNA HEIGHT (m)	TABLE ANGLE (Degree)	RAW VALUE (dBuV)	CORRECTION FACTOR (dB/m)
1	30.78	30.7 QP	40.0	-9.3	1.97 H	266	40.7	-10.0
2	114.55	25.9 QP	43.5	-17.6	1.49 H	66	37.0	-11.1
3	250.12	34.0 QP	46.0	-12.0	1.00 H	64	44.0	-10.0
4	320.55	33.9 QP	46.0	-12.1	1.03 H	39	41.3	-7.4
5	497.98	27.9 QP	46.0	-18.1	1.44 H	49	30.7	-2.8
6	920.61	30.9 QP	46.0	-15.1	2.54 H	83	26.7	4.2

**ANTENNA POLARITY & TEST DISTANCE: VERTICAL AT 3 M**

NO.	FREQ. (MHz)	EMISSION LEVEL (dBuV/m)	LIMIT (dBuV/m)	MARGIN (dB)	ANTENNA HEIGHT (m)	TABLE ANGLE (Degree)	RAW VALUE (dBuV)	CORRECTION FACTOR (dB/m)
1	30.85	32.8 QP	40.0	-7.2	1.95 V	339	42.8	-10.0
2	42.73	29.6 QP	40.0	-10.4	1.05 V	351	38.4	-8.8
3	250.07	28.0 QP	46.0	-18.0	1.53 V	357	38.0	-10.0
4	320.41	26.7 QP	46.0	-19.3	1.51 V	360	34.1	-7.4
5	497.40	26.2 QP	46.0	-19.8	1.00 V	295	29.0	-2.8
6	926.01	30.0 QP	46.0	-16.0	2.50 V	57	25.7	4.3

**REMARKS:**

1. Emission Level(dBuV/m) = Raw Value(dBuV) + Correction Factor(dB/m)
2. Correction Factor(dB/m) = Antenna Factor(dB/m) + Cable Factor(dB) – Pre-Amplifier Factor(dB)
3. The other emission levels were very low against the limit.
4. Margin value = Emission Level – Limit value

<b>CHANNEL</b>	TX Channel 116	<b>DETECTOR FUNCTION</b>	Quasi-Peak (QP)
<b>FREQUENCY RANGE</b>	9kHz ~ 1GHz		

**ANTENNA POLARITY & TEST DISTANCE: HORIZONTAL AT 3 M**

NO.	FREQ. (MHz)	EMISSION LEVEL (dBuV/m)	LIMIT (dBuV/m)	MARGIN (dB)	ANTENNA HEIGHT (m)	TABLE ANGLE (Degree)	RAW VALUE (dBuV)	CORRECTION FACTOR (dB/m)
1	30.73	30.7 QP	40.0	-9.3	2.00 H	259	40.7	-10.0
2	114.12	25.5 QP	43.5	-18.0	1.49 H	69	36.6	-11.1
3	250.30	34.1 QP	46.0	-11.9	1.00 H	85	44.1	-10.0
4	320.98	33.4 QP	46.0	-12.6	1.00 H	57	40.8	-7.4
5	497.85	27.6 QP	46.0	-18.4	1.52 H	54	30.4	-2.8
6	920.61	30.8 QP	46.0	-15.2	2.49 H	80	26.6	4.2

**ANTENNA POLARITY & TEST DISTANCE: VERTICAL AT 3 M**

NO.	FREQ. (MHz)	EMISSION LEVEL (dBuV/m)	LIMIT (dBuV/m)	MARGIN (dB)	ANTENNA HEIGHT (m)	TABLE ANGLE (Degree)	RAW VALUE (dBuV)	CORRECTION FACTOR (dB/m)
1	30.56	32.7 QP	40.0	-7.3	2.04 V	342	42.6	-9.9
2	42.72	29.6 QP	40.0	-10.4	1.00 V	357	38.4	-8.8
3	249.99	27.6 QP	46.0	-18.4	1.52 V	360	37.6	-10.0
4	320.75	26.5 QP	46.0	-19.5	1.53 V	344	33.9	-7.4
5	497.30	26.2 QP	46.0	-19.8	1.05 V	287	29.0	-2.8
6	926.01	29.9 QP	46.0	-16.1	2.45 V	76	25.6	4.3

**REMARKS:**

1. Emission Level(dBuV/m) = Raw Value(dBuV) + Correction Factor(dB/m)
2. Correction Factor(dB/m) = Antenna Factor(dB/m) + Cable Factor(dB) – Pre-Amplifier Factor(dB)
3. The other emission levels were very low against the limit.
4. Margin value = Emission Level – Limit value

<b>CHANNEL</b>	TX Channel 140	<b>DETECTOR FUNCTION</b>	Quasi-Peak (QP)
<b>FREQUENCY RANGE</b>	9kHz ~ 1GHz		

**ANTENNA POLARITY & TEST DISTANCE: HORIZONTAL AT 3 M**

NO.	FREQ. (MHz)	EMISSION LEVEL (dBuV/m)	LIMIT (dBuV/m)	MARGIN (dB)	ANTENNA HEIGHT (m)	TABLE ANGLE (Degree)	RAW VALUE (dBuV)	CORRECTION FACTOR (dB/m)
1	30.42	30.8 QP	40.0	-9.2	2.04 H	266	40.7	-9.9
2	114.28	25.8 QP	43.5	-17.7	1.55 H	54	36.9	-11.1
3	249.99	34.2 QP	46.0	-11.8	1.05 H	82	44.2	-10.0
4	320.70	33.8 QP	46.0	-12.2	1.00 H	61	41.2	-7.4
5	497.69	27.4 QP	46.0	-18.6	1.54 H	61	30.2	-2.8
6	920.61	30.5 QP	46.0	-15.5	2.50 H	106	26.3	4.2

**ANTENNA POLARITY & TEST DISTANCE: VERTICAL AT 3 M**

NO.	FREQ. (MHz)	EMISSION LEVEL (dBuV/m)	LIMIT (dBuV/m)	MARGIN (dB)	ANTENNA HEIGHT (m)	TABLE ANGLE (Degree)	RAW VALUE (dBuV)	CORRECTION FACTOR (dB/m)
1	30.70	32.7 QP	40.0	-7.3	2.03 V	330	42.7	-10.0
2	42.45	29.6 QP	40.0	-10.4	1.05 V	352	38.5	-8.9
3	250.15	27.7 QP	46.0	-18.3	1.52 V	357	37.7	-10.0
4	320.93	26.7 QP	46.0	-19.3	1.56 V	360	34.1	-7.4
5	497.29	26.4 QP	46.0	-19.6	1.01 V	280	29.2	-2.8
6	926.01	30.0 QP	46.0	-16.0	2.46 V	55	25.7	4.3

**REMARKS:**

1. Emission Level(dBuV/m) = Raw Value(dBuV) + Correction Factor(dB/m)
2. Correction Factor(dB/m) = Antenna Factor(dB/m) + Cable Factor(dB) – Pre-Amplifier Factor(dB)
3. The other emission levels were very low against the limit.
4. Margin value = Emission Level – Limit value

<b>CHANNEL</b>	TX Channel 144	<b>DETECTOR FUNCTION</b>	Quasi-Peak (QP)
<b>FREQUENCY RANGE</b>	9kHz ~ 1GHz		

**ANTENNA POLARITY & TEST DISTANCE: HORIZONTAL AT 3 M**

NO.	FREQ. (MHz)	EMISSION LEVEL (dBuV/m)	LIMIT (dBuV/m)	MARGIN (dB)	ANTENNA HEIGHT (m)	TABLE ANGLE (Degree)	RAW VALUE (dBuV)	CORRECTION FACTOR (dB/m)
1	30.72	30.8 QP	40.0	-9.2	2.04 H	251	40.8	-10.0
2	114.02	25.5 QP	43.5	-18.0	1.47 H	58	36.6	-11.1
3	249.98	34.2 QP	46.0	-11.8	1.03 H	61	44.2	-10.0
4	320.85	33.6 QP	46.0	-12.4	1.00 H	33	41.0	-7.4
5	497.69	27.7 QP	46.0	-18.3	1.44 H	50	30.5	-2.8
6	920.61	30.8 QP	46.0	-15.2	2.50 H	100	26.6	4.2

**ANTENNA POLARITY & TEST DISTANCE: VERTICAL AT 3 M**

NO.	FREQ. (MHz)	EMISSION LEVEL (dBuV/m)	LIMIT (dBuV/m)	MARGIN (dB)	ANTENNA HEIGHT (m)	TABLE ANGLE (Degree)	RAW VALUE (dBuV)	CORRECTION FACTOR (dB/m)
1	30.39	32.7 QP	40.0	-7.3	2.05 V	321	42.6	-9.9
2	42.40	29.9 QP	40.0	-10.1	1.00 V	360	38.8	-8.9
3	249.73	27.8 QP	46.0	-18.2	1.46 V	360	37.8	-10.0
4	320.64	26.3 QP	46.0	-19.7	1.54 V	353	33.7	-7.4
5	497.48	26.0 QP	46.0	-20.0	1.03 V	294	28.8	-2.8
6	926.01	29.7 QP	46.0	-16.3	2.54 V	69	25.4	4.3

**REMARKS:**

1. Emission Level(dBuV/m) = Raw Value(dBuV) + Correction Factor(dB/m)
2. Correction Factor(dB/m) = Antenna Factor(dB/m) + Cable Factor(dB) – Pre-Amplifier Factor(dB)
3. The other emission levels were very low against the limit.
4. Margin value = Emission Level – Limit value

**802.11ac (VHT40)**

<b>CHANNEL</b>	TX Channel 54	<b>DETECTOR FUNCTION</b>	Quasi-Peak (QP)
<b>FREQUENCY RANGE</b>	9kHz ~ 1GHz		

**ANTENNA POLARITY & TEST DISTANCE: HORIZONTAL AT 3 M**

NO.	FREQ. (MHz)	EMISSION LEVEL (dBuV/m)	LIMIT (dBuV/m)	MARGIN (dB)	ANTENNA HEIGHT (m)	TABLE ANGLE (Degree)	RAW VALUE (dBuV)	CORRECTION FACTOR (dB/m)
1	30.43	30.5 QP	40.0	-9.5	2.01 H	253	40.4	-9.9
2	114.30	25.4 QP	43.5	-18.1	1.45 H	59	36.5	-11.1
3	249.95	34.1 QP	46.0	-11.9	1.00 H	77	44.1	-10.0
4	320.98	33.9 QP	46.0	-12.1	1.01 H	35	41.3	-7.4
5	497.60	27.9 QP	46.0	-18.1	1.54 H	64	30.7	-2.8
6	920.61	30.8 QP	46.0	-15.2	2.52 H	107	26.6	4.2

**ANTENNA POLARITY & TEST DISTANCE: VERTICAL AT 3 M**

NO.	FREQ. (MHz)	EMISSION LEVEL (dBuV/m)	LIMIT (dBuV/m)	MARGIN (dB)	ANTENNA HEIGHT (m)	TABLE ANGLE (Degree)	RAW VALUE (dBuV)	CORRECTION FACTOR (dB/m)
1	30.92	32.6 QP	40.0	-7.4	1.99 V	315	42.6	-10.0
2	42.75	29.9 QP	40.0	-10.1	1.00 V	360	38.7	-8.8
3	250.21	28.0 QP	46.0	-18.0	1.52 V	360	38.0	-10.0
4	320.92	26.4 QP	46.0	-19.6	1.49 V	351	33.8	-7.4
5	497.14	26.0 QP	46.0	-20.0	1.00 V	301	28.8	-2.8
6	926.01	29.6 QP	46.0	-16.4	2.45 V	61	25.3	4.3

**REMARKS:**

1. Emission Level(dBuV/m) = Raw Value(dBuV) + Correction Factor(dB/m)
2. Correction Factor(dB/m) = Antenna Factor(dB/m) + Cable Factor(dB) – Pre-Amplifier Factor(dB)
3. The other emission levels were very low against the limit.
4. Margin value = Emission Level – Limit value

<b>CHANNEL</b>	TX Channel 62	<b>DETECTOR FUNCTION</b>	Quasi-Peak (QP)
<b>FREQUENCY RANGE</b>	9kHz ~ 1GHz		

**ANTENNA POLARITY & TEST DISTANCE: HORIZONTAL AT 3 M**

NO.	FREQ. (MHz)	EMISSION LEVEL (dBuV/m)	LIMIT (dBuV/m)	MARGIN (dB)	ANTENNA HEIGHT (m)	TABLE ANGLE (Degree)	RAW VALUE (dBuV)	CORRECTION FACTOR (dB/m)
1	30.66	31.1 QP	40.0	-8.9	2.03 H	254	41.1	-10.0
2	114.38	25.6 QP	43.5	-17.9	1.44 H	86	36.7	-11.1
3	250.21	33.9 QP	46.0	-12.1	1.03 H	75	43.9	-10.0
4	320.74	33.7 QP	46.0	-12.3	1.00 H	55	41.1	-7.4
5	497.94	27.9 QP	46.0	-18.1	1.51 H	64	30.7	-2.8
6	920.61	30.9 QP	46.0	-15.1	2.52 H	93	26.7	4.2

**ANTENNA POLARITY & TEST DISTANCE: VERTICAL AT 3 M**

NO.	FREQ. (MHz)	EMISSION LEVEL (dBuV/m)	LIMIT (dBuV/m)	MARGIN (dB)	ANTENNA HEIGHT (m)	TABLE ANGLE (Degree)	RAW VALUE (dBuV)	CORRECTION FACTOR (dB/m)
1	30.70	32.9 QP	40.0	-7.1	1.99 V	319	42.9	-10.0
2	42.62	29.9 QP	40.0	-10.1	1.00 V	357	38.8	-8.9
3	250.30	27.7 QP	46.0	-18.3	1.51 V	359	37.7	-10.0
4	320.76	26.4 QP	46.0	-19.6	1.48 V	360	33.8	-7.4
5	497.05	25.9 QP	46.0	-20.1	1.00 V	275	28.7	-2.8
6	926.01	30.1 QP	46.0	-15.9	2.48 V	75	25.8	4.3

**REMARKS:**

1. Emission Level(dBuV/m) = Raw Value(dBuV) + Correction Factor(dB/m)
2. Correction Factor(dB/m) = Antenna Factor(dB/m) + Cable Factor(dB) – Pre-Amplifier Factor(dB)
3. The other emission levels were very low against the limit.
4. Margin value = Emission Level – Limit value

<b>CHANNEL</b>	TX Channel 102	<b>DETECTOR FUNCTION</b>	Quasi-Peak (QP)
<b>FREQUENCY RANGE</b>	9kHz ~ 1GHz		

**ANTENNA POLARITY & TEST DISTANCE: HORIZONTAL AT 3 M**

NO.	FREQ. (MHz)	EMISSION LEVEL (dBuV/m)	LIMIT (dBuV/m)	MARGIN (dB)	ANTENNA HEIGHT (m)	TABLE ANGLE (Degree)	RAW VALUE (dBuV)	CORRECTION FACTOR (dB/m)
1	30.77	30.7 QP	40.0	-9.3	2.00 H	248	40.7	-10.0
2	114.44	25.4 QP	43.5	-18.1	1.54 H	83	36.5	-11.1
3	249.87	34.2 QP	46.0	-11.8	1.00 H	61	44.2	-10.0
4	320.71	33.6 QP	46.0	-12.4	1.01 H	52	41.0	-7.4
5	497.63	27.6 QP	46.0	-18.4	1.46 H	64	30.4	-2.8
6	920.61	30.7 QP	46.0	-15.3	2.51 H	77	26.5	4.2

**ANTENNA POLARITY & TEST DISTANCE: VERTICAL AT 3 M**

NO.	FREQ. (MHz)	EMISSION LEVEL (dBuV/m)	LIMIT (dBuV/m)	MARGIN (dB)	ANTENNA HEIGHT (m)	TABLE ANGLE (Degree)	RAW VALUE (dBuV)	CORRECTION FACTOR (dB/m)
1	30.81	32.7 QP	40.0	-7.3	1.98 V	321	42.7	-10.0
2	42.44	30.1 QP	40.0	-9.9	1.05 V	360	39.0	-8.9
3	249.70	27.6 QP	46.0	-18.4	1.51 V	351	37.6	-10.0
4	320.50	26.7 QP	46.0	-19.3	1.45 V	360	34.1	-7.4
5	497.20	26.4 QP	46.0	-19.6	1.00 V	291	29.2	-2.8
6	926.01	29.8 QP	46.0	-16.2	2.47 V	56	25.5	4.3

**REMARKS:**

1. Emission Level(dBuV/m) = Raw Value(dBuV) + Correction Factor(dB/m)
2. Correction Factor(dB/m) = Antenna Factor(dB/m) + Cable Factor(dB) – Pre-Amplifier Factor(dB)
3. The other emission levels were very low against the limit.
4. Margin value = Emission Level – Limit value



<b>CHANNEL</b>	TX Channel 110	<b>DETECTOR FUNCTION</b>	Quasi-Peak (QP)
<b>FREQUENCY RANGE</b>	9kHz ~ 1GHz		

**ANTENNA POLARITY & TEST DISTANCE: HORIZONTAL AT 3 M**

NO.	FREQ. (MHz)	EMISSION LEVEL (dBuV/m)	LIMIT (dBuV/m)	MARGIN (dB)	ANTENNA HEIGHT (m)	TABLE ANGLE (Degree)	RAW VALUE (dBuV)	CORRECTION FACTOR (dB/m)
1	30.51	30.5 QP	40.0	-9.5	2.00 H	254	40.4	-9.9
2	114.08	25.4 QP	43.5	-18.1	1.46 H	77	36.5	-11.1
3	249.73	34.1 QP	46.0	-11.9	1.02 H	87	44.1	-10.0
4	320.69	33.9 QP	46.0	-12.1	1.02 H	52	41.3	-7.4
5	497.82	28.0 QP	46.0	-18.0	1.56 H	44	30.8	-2.8
6	920.61	30.9 QP	46.0	-15.1	2.53 H	103	26.7	4.2

**ANTENNA POLARITY & TEST DISTANCE: VERTICAL AT 3 M**

NO.	FREQ. (MHz)	EMISSION LEVEL (dBuV/m)	LIMIT (dBuV/m)	MARGIN (dB)	ANTENNA HEIGHT (m)	TABLE ANGLE (Degree)	RAW VALUE (dBuV)	CORRECTION FACTOR (dB/m)
1	30.42	33.0 QP	40.0	-7.0	2.04 V	326	42.9	-9.9
2	42.63	30.1 QP	40.0	-9.9	1.02 V	352	39.0	-8.9
3	250.24	27.6 QP	46.0	-18.4	1.50 V	345	37.6	-10.0
4	320.67	26.3 QP	46.0	-19.7	1.52 V	349	33.7	-7.4
5	497.23	25.9 QP	46.0	-20.1	1.02 V	288	28.7	-2.8
6	926.01	29.9 QP	46.0	-16.1	2.45 V	71	25.6	4.3

**REMARKS:**

1. Emission Level(dBuV/m) = Raw Value(dBuV) + Correction Factor(dB/m)
2. Correction Factor(dB/m) = Antenna Factor(dB/m) + Cable Factor(dB) – Pre-Amplifier Factor(dB)
3. The other emission levels were very low against the limit.
4. Margin value = Emission Level – Limit value

<b>CHANNEL</b>	TX Channel 134	<b>DETECTOR FUNCTION</b>	Quasi-Peak (QP)
<b>FREQUENCY RANGE</b>	9kHz ~ 1GHz		

**ANTENNA POLARITY & TEST DISTANCE: HORIZONTAL AT 3 M**

NO.	FREQ. (MHz)	EMISSION LEVEL (dBuV/m)	LIMIT (dBuV/m)	MARGIN (dB)	ANTENNA HEIGHT (m)	TABLE ANGLE (Degree)	RAW VALUE (dBuV)	CORRECTION FACTOR (dB/m)
1	30.53	30.7 QP	40.0	-9.3	1.99 H	240	40.6	-9.9
2	114.15	25.9 QP	43.5	-17.6	1.55 H	71	37.0	-11.1
3	250.12	34.0 QP	46.0	-12.0	1.00 H	77	44.0	-10.0
4	320.90	33.5 QP	46.0	-12.5	1.03 H	58	40.9	-7.4
5	497.63	27.9 QP	46.0	-18.1	1.51 H	65	30.7	-2.8
6	920.61	30.8 QP	46.0	-15.2	2.50 H	88	26.6	4.2

**ANTENNA POLARITY & TEST DISTANCE: VERTICAL AT 3 M**

NO.	FREQ. (MHz)	EMISSION LEVEL (dBuV/m)	LIMIT (dBuV/m)	MARGIN (dB)	ANTENNA HEIGHT (m)	TABLE ANGLE (Degree)	RAW VALUE (dBuV)	CORRECTION FACTOR (dB/m)
1	30.40	32.7 QP	40.0	-7.3	1.97 V	313	42.6	-9.9
2	42.66	29.8 QP	40.0	-10.2	1.04 V	360	38.7	-8.9
3	250.20	27.9 QP	46.0	-18.1	1.46 V	355	37.9	-10.0
4	320.77	26.9 QP	46.0	-19.1	1.48 V	360	34.3	-7.4
5	497.38	26.0 QP	46.0	-20.0	1.01 V	293	28.8	-2.8
6	926.01	30.1 QP	46.0	-15.9	2.46 V	63	25.8	4.3

**REMARKS:**

1. Emission Level(dBuV/m) = Raw Value(dBuV) + Correction Factor(dB/m)
2. Correction Factor(dB/m) = Antenna Factor(dB/m) + Cable Factor(dB) – Pre-Amplifier Factor(dB)
3. The other emission levels were very low against the limit.
4. Margin value = Emission Level – Limit value

<b>CHANNEL</b>	TX Channel 142	<b>DETECTOR FUNCTION</b>	Quasi-Peak (QP)
<b>FREQUENCY RANGE</b>	9kHz ~ 1GHz		

**ANTENNA POLARITY & TEST DISTANCE: HORIZONTAL AT 3 M**

NO.	FREQ. (MHz)	EMISSION LEVEL (dBuV/m)	LIMIT (dBuV/m)	MARGIN (dB)	ANTENNA HEIGHT (m)	TABLE ANGLE (Degree)	RAW VALUE (dBuV)	CORRECTION FACTOR (dB/m)
1	30.45	30.7 QP	40.0	-9.3	2.04 H	257	40.6	-9.9
2	114.44	25.5 QP	43.5	-18.0	1.50 H	84	36.6	-11.1
3	249.99	34.4 QP	46.0	-11.6	1.05 H	68	44.4	-10.0
4	320.93	33.4 QP	46.0	-12.6	1.02 H	35	40.8	-7.4
5	497.78	27.4 QP	46.0	-18.6	1.47 H	50	30.2	-2.8
6	920.61	30.9 QP	46.0	-15.1	2.46 H	105	26.7	4.2

**ANTENNA POLARITY & TEST DISTANCE: VERTICAL AT 3 M**

NO.	FREQ. (MHz)	EMISSION LEVEL (dBuV/m)	LIMIT (dBuV/m)	MARGIN (dB)	ANTENNA HEIGHT (m)	TABLE ANGLE (Degree)	RAW VALUE (dBuV)	CORRECTION FACTOR (dB/m)
1	30.44	32.9 QP	40.0	-7.1	1.96 V	323	42.8	-9.9
2	42.76	29.8 QP	40.0	-10.2	1.00 V	346	38.6	-8.8
3	250.26	27.8 QP	46.0	-18.2	1.53 V	360	37.8	-10.0
4	320.97	26.9 QP	46.0	-19.1	1.55 V	360	34.3	-7.4
5	497.54	25.9 QP	46.0	-20.1	1.01 V	305	28.7	-2.8
6	926.01	29.8 QP	46.0	-16.2	2.54 V	58	25.5	4.3

**REMARKS:**

1. Emission Level(dBuV/m) = Raw Value(dBuV) + Correction Factor(dB/m)
2. Correction Factor(dB/m) = Antenna Factor(dB/m) + Cable Factor(dB) – Pre-Amplifier Factor(dB)
3. The other emission levels were very low against the limit.
4. Margin value = Emission Level – Limit value

**802.11ac (VHT80)**

<b>CHANNEL</b>	TX Channel 58	<b>DETECTOR FUNCTION</b>	Quasi-Peak (QP)
<b>FREQUENCY RANGE</b>	9kHz ~ 1GHz		

**ANTENNA POLARITY & TEST DISTANCE: HORIZONTAL AT 3 M**

NO.	FREQ. (MHz)	EMISSION LEVEL (dBuV/m)	LIMIT (dBuV/m)	MARGIN (dB)	ANTENNA HEIGHT (m)	TABLE ANGLE (Degree)	RAW VALUE (dBuV)	CORRECTION FACTOR (dB/m)
1	30.81	30.6 QP	40.0	-9.4	2.05 H	247	40.6	-10.0
2	114.41	25.9 QP	43.5	-17.6	1.49 H	64	37.0	-11.1
3	249.88	34.1 QP	46.0	-11.9	1.03 H	84	44.1	-10.0
4	320.82	33.6 QP	46.0	-12.4	1.05 H	35	41.0	-7.4
5	497.49	27.9 QP	46.0	-18.1	1.49 H	44	30.7	-2.8
6	920.61	31.0 QP	46.0	-15.0	2.51 H	96	26.8	4.2

**ANTENNA POLARITY & TEST DISTANCE: VERTICAL AT 3 M**

NO.	FREQ. (MHz)	EMISSION LEVEL (dBuV/m)	LIMIT (dBuV/m)	MARGIN (dB)	ANTENNA HEIGHT (m)	TABLE ANGLE (Degree)	RAW VALUE (dBuV)	CORRECTION FACTOR (dB/m)
1	30.69	32.7 QP	40.0	-7.3	2.00 V	332	42.7	-10.0
2	42.56	30.0 QP	40.0	-10.0	1.06 V	345	38.9	-8.9
3	250.14	27.6 QP	46.0	-18.4	1.49 V	360	37.6	-10.0
4	320.46	26.4 QP	46.0	-19.6	1.52 V	344	33.8	-7.4
5	497.47	26.1 QP	46.0	-19.9	1.05 V	296	28.9	-2.8
6	926.01	30.0 QP	46.0	-16.0	2.48 V	60	25.7	4.3

**REMARKS:**

1. Emission Level(dBuV/m) = Raw Value(dBuV) + Correction Factor(dB/m)
2. Correction Factor(dB/m) = Antenna Factor(dB/m) + Cable Factor(dB) – Pre-Amplifier Factor(dB)
3. The other emission levels were very low against the limit.
4. Margin value = Emission Level – Limit value

<b>CHANNEL</b>	TX Channel 106	<b>DETECTOR FUNCTION</b>	Quasi-Peak (QP)
<b>FREQUENCY RANGE</b>	9kHz ~ 1GHz		

**ANTENNA POLARITY & TEST DISTANCE: HORIZONTAL AT 3 M**

NO.	FREQ. (MHz)	EMISSION LEVEL (dBuV/m)	LIMIT (dBuV/m)	MARGIN (dB)	ANTENNA HEIGHT (m)	TABLE ANGLE (Degree)	RAW VALUE (dBuV)	CORRECTION FACTOR (dB/m)
1	30.43	30.8 QP	40.0	-9.2	1.97 H	248	40.7	-9.9
2	114.13	25.9 QP	43.5	-17.6	1.47 H	59	37.0	-11.1
3	250.22	33.9 QP	46.0	-12.1	1.02 H	78	43.9	-10.0
4	320.53	33.7 QP	46.0	-12.3	1.00 H	58	41.1	-7.4
5	497.84	27.5 QP	46.0	-18.5	1.45 H	55	30.3	-2.8
6	920.61	30.7 QP	46.0	-15.3	2.45 H	86	26.5	4.2

**ANTENNA POLARITY & TEST DISTANCE: VERTICAL AT 3 M**

NO.	FREQ. (MHz)	EMISSION LEVEL (dBuV/m)	LIMIT (dBuV/m)	MARGIN (dB)	ANTENNA HEIGHT (m)	TABLE ANGLE (Degree)	RAW VALUE (dBuV)	CORRECTION FACTOR (dB/m)
1	30.82	33.0 QP	40.0	-7.0	2.03 V	340	43.0	-10.0
2	42.55	29.9 QP	40.0	-10.1	1.05 V	346	38.8	-8.9
3	250.02	28.0 QP	46.0	-18.0	1.45 V	360	38.0	-10.0
4	320.54	26.8 QP	46.0	-19.2	1.47 V	360	34.2	-7.4
5	497.16	25.9 QP	46.0	-20.1	1.00 V	289	28.7	-2.8
6	926.01	29.6 QP	46.0	-16.4	2.51 V	79	25.3	4.3

**REMARKS:**

1. Emission Level(dBuV/m) = Raw Value(dBuV) + Correction Factor(dB/m)
2. Correction Factor(dB/m) = Antenna Factor(dB/m) + Cable Factor(dB) – Pre-Amplifier Factor(dB)
3. The other emission levels were very low against the limit.
4. Margin value = Emission Level – Limit value

<b>CHANNEL</b>	TX Channel 122	<b>DETECTOR FUNCTION</b>	Quasi-Peak (QP)
<b>FREQUENCY RANGE</b>	9kHz ~ 1GHz		

**ANTENNA POLARITY & TEST DISTANCE: HORIZONTAL AT 3 M**

NO.	FREQ. (MHz)	EMISSION LEVEL (dBuV/m)	LIMIT (dBuV/m)	MARGIN (dB)	ANTENNA HEIGHT (m)	TABLE ANGLE (Degree)	RAW VALUE (dBuV)	CORRECTION FACTOR (dB/m)
1	30.69	30.7 QP	40.0	-9.3	1.99 H	240	40.7	-10.0
2	114.01	25.5 QP	43.5	-18.0	1.47 H	79	36.6	-11.1
3	249.75	34.0 QP	46.0	-12.0	1.05 H	79	44.0	-10.0
4	320.60	33.7 QP	46.0	-12.3	1.02 H	60	41.1	-7.4
5	497.95	27.8 QP	46.0	-18.2	1.54 H	41	30.6	-2.8
6	920.61	30.9 QP	46.0	-15.1	2.48 H	106	26.7	4.2

**ANTENNA POLARITY & TEST DISTANCE: VERTICAL AT 3 M**

NO.	FREQ. (MHz)	EMISSION LEVEL (dBuV/m)	LIMIT (dBuV/m)	MARGIN (dB)	ANTENNA HEIGHT (m)	TABLE ANGLE (Degree)	RAW VALUE (dBuV)	CORRECTION FACTOR (dB/m)
1	30.77	32.7 QP	40.0	-7.3	1.95 V	339	42.7	-10.0
2	42.65	29.5 QP	40.0	-10.5	1.00 V	347	38.4	-8.9
3	249.85	27.9 QP	46.0	-18.1	1.50 V	360	37.9	-10.0
4	320.84	26.3 QP	46.0	-19.7	1.49 V	360	33.7	-7.4
5	497.27	26.3 QP	46.0	-19.7	1.02 V	291	29.1	-2.8
6	926.01	29.8 QP	46.0	-16.2	2.52 V	68	25.5	4.3

**REMARKS:**

1. Emission Level(dBuV/m) = Raw Value(dBuV) + Correction Factor(dB/m)
2. Correction Factor(dB/m) = Antenna Factor(dB/m) + Cable Factor(dB) – Pre-Amplifier Factor(dB)
3. The other emission levels were very low against the limit.
4. Margin value = Emission Level – Limit value

<b>CHANNEL</b>	TX Channel 138	<b>DETECTOR FUNCTION</b>	Quasi-Peak (QP)
<b>FREQUENCY RANGE</b>	9kHz ~ 1GHz		

**ANTENNA POLARITY & TEST DISTANCE: HORIZONTAL AT 3 M**

NO.	FREQ. (MHz)	EMISSION LEVEL (dBuV/m)	LIMIT (dBuV/m)	MARGIN (dB)	ANTENNA HEIGHT (m)	TABLE ANGLE (Degree)	RAW VALUE (dBuV)	CORRECTION FACTOR (dB/m)
1	30.55	30.7 QP	40.0	-9.3	2.01 H	252	40.6	-9.9
2	114.55	25.8 QP	43.5	-17.7	1.55 H	59	36.9	-11.1
3	250.28	33.8 QP	46.0	-12.2	1.04 H	67	43.8	-10.0
4	320.59	33.7 QP	46.0	-12.3	1.03 H	31	41.1	-7.4
5	497.91	27.8 QP	46.0	-18.2	1.50 H	49	30.6	-2.8
6	920.61	30.7 QP	46.0	-15.3	2.50 H	102	26.5	4.2

**ANTENNA POLARITY & TEST DISTANCE: VERTICAL AT 3 M**

NO.	FREQ. (MHz)	EMISSION LEVEL (dBuV/m)	LIMIT (dBuV/m)	MARGIN (dB)	ANTENNA HEIGHT (m)	TABLE ANGLE (Degree)	RAW VALUE (dBuV)	CORRECTION FACTOR (dB/m)
1	30.47	32.7 QP	40.0	-7.3	1.98 V	340	42.6	-9.9
2	42.54	30.0 QP	40.0	-10.0	1.01 V	359	38.9	-8.9
3	249.92	27.6 QP	46.0	-18.4	1.55 V	360	37.6	-10.0
4	320.55	26.5 QP	46.0	-19.5	1.52 V	349	33.9	-7.4
5	497.58	26.0 QP	46.0	-20.0	1.00 V	305	28.8	-2.8
6	926.01	29.7 QP	46.0	-16.3	2.52 V	70	25.4	4.3

**REMARKS:**

1. Emission Level(dBuV/m) = Raw Value(dBuV) + Correction Factor(dB/m)
2. Correction Factor(dB/m) = Antenna Factor(dB/m) + Cable Factor(dB) – Pre-Amplifier Factor(dB)
3. The other emission levels were very low against the limit.
4. Margin value = Emission Level – Limit value

## 4.2 Conducted Emission Measurement

### 4.2.1 Limits of Conducted Emission Measurement

Frequency (MHz)	Conducted Limit (dBuV)	
	Quasi-peak	Average
0.15 - 0.5	66 - 56	56 - 46
0.50 - 5.0	56	46
5.0 - 30.0	60	50

Note: 1. The lower limit shall apply at the transition frequencies.

2. The limit decreases in line with the logarithm of the frequency in the range of 0.15 to 0.50MHz.

### 4.2.2 Test Instruments

DESCRIPTION & MANUFACTURER	MODEL NO.	SERIAL NO.	CALIBRATED DATE	CALIBRATED UNTIL
Test Receiver R&S	ESCS 30	100287	Apr. 16, 2016	Apr. 15, 2017
Line-Impedance Stabilization Network (for EUT) SCHWARZBECK	NSLK-8127	8127-523	Oct. 11, 2016	Oct. 10, 2017
Line-Impedance Stabilization Network (for Peripheral) R&S	ESH3-Z5	848773/004	Oct. 26, 2016	Oct. 25, 2017
RF Cable	5D-FB	COACAB-001	May 24, 2016	May 23, 2017
10 dB PAD Mini-Circuits	HAT-10+	CONATT-001	Sep. 13, 2016	Sep. 12, 2017
50 ohms Terminator	50	3	Oct. 26, 2016	Oct. 25, 2017
50 ohms Terminator	N/A	EMC-04	Nov. 02, 2016	Nov. 01, 2017
Software BVADT	BVADT_Cond_ V7.3.7.4	NA	NA	NA

**Note:**

1. The calibration interval of the above test instruments are 12 months and the calibrations are traceable to NML/ROC and NIST/USA.
2. The test was performed in Shielded Room No. A.
3. Tested Date: Nov. 09, 2016



#### 4.2.3 Test Procedure

- The EUT was placed 0.4 meters from the conducting wall of the shielded room with EUT being connected to the power mains through a line impedance stabilization network (LISN). Other support units were connected to the power mains through another LISN. The two LISNs provide 50 ohm/ 50uH of coupling impedance for the measuring instrument.
- Both lines of the power mains connected to the EUT were checked for maximum conducted interference.
- The frequency range from 150kHz to 30MHz was searched. Emission levels under (Limit - 20dB) was not recorded.

**NOTE:** All modes of operation were investigated and the worst-case emissions are reported.

#### 4.2.4 Deviation from Test Standard

No deviation.

#### 4.2.5 Test Setup

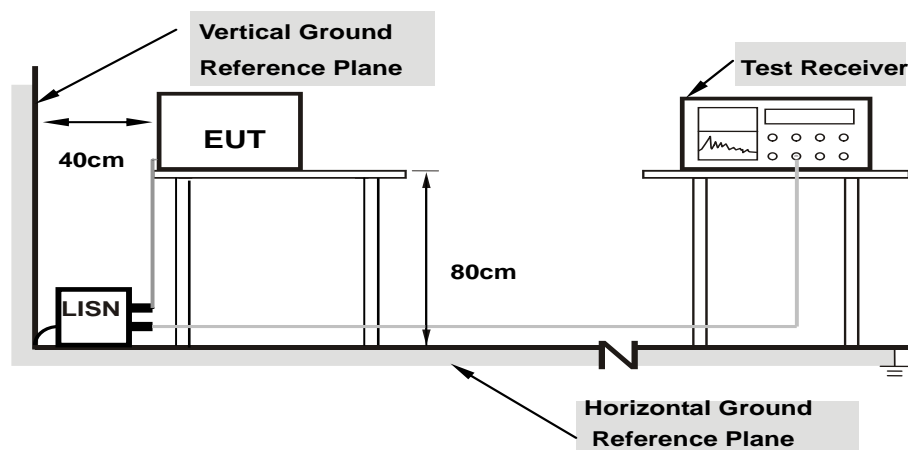

**Note: 1.Support units were connected to second LISN.**

For the actual test configuration, please refer to the attached file (Test Setup Photo).

#### 4.2.6 EUT Operating Condition

Same as 4.1.6.

#### 4.2.7 Test Results (Mode 1)

Phase	Line (L)	Detector Function	Quasi-Peak (QP) / Average (AV)
-------	----------	-------------------	--------------------------------

No	Freq. [MHz]	Corr.	Reading Value		Emission Level		Limit		Margin	
		Factor	[dB (uV)]		[dB (uV)]		[dB (uV)]		(dB)	
	(dB)	Q.P.	AV.	Q.P.	AV.	Q.P.	AV.	Q.P.	AV.	
1	0.15781	10.14	37.41	21.61	47.55	31.75	65.58	55.58	-18.03	-23.83
2	0.17734	10.13	34.26	19.41	44.39	29.54	64.61	54.61	-20.22	-25.07
3	0.22422	10.12	25.71	9.03	35.83	19.15	62.66	52.66	-26.83	-33.51
4	0.41563	10.11	23.09	17.05	33.20	27.16	57.54	47.54	-24.34	-20.38
5	3.30078	10.29	2.38	-6.85	12.67	3.44	56.00	46.00	-43.33	-42.56
6	21.17578	10.85	13.36	8.48	24.21	19.33	60.00	50.00	-35.79	-30.67
7	27.63672	11.09	15.30	10.30	26.39	21.39	60.00	50.00	-33.61	-28.61

#### REMARKS:

1. Q.P. and AV. are abbreviations of quasi-peak and average individually.
2. The emission levels of other frequencies were very low against the limit.
3. Margin value = Emission level - Limit value
4. Correction factor = Insertion loss + Cable loss
5. Emission Level = Correction Factor + Reading Value.

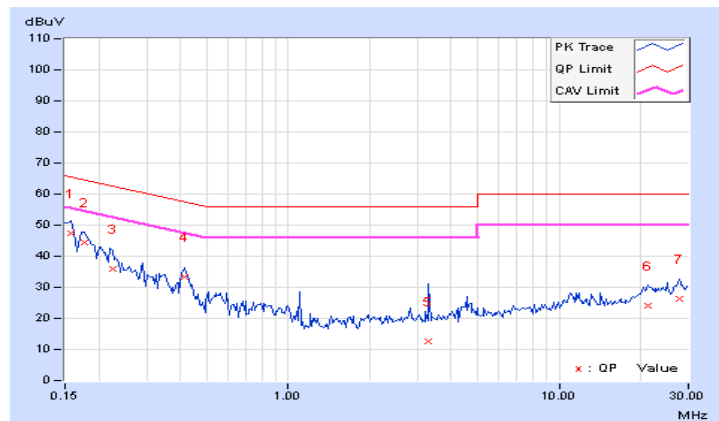

Phase	Neutral (N)	Detector Function	Quasi-Peak (QP) / Average (AV)
-------	-------------	-------------------	--------------------------------

No	Freq. [MHz]	Corr. Factor	Reading Value [dB (uV)]		Emission Level [dB (uV)]		Limit [dB (uV)]		Margin (dB)	
		(dB)	Q.P.	AV.	Q.P.	AV.	Q.P.	AV.	Q.P.	AV.
	1	0.15391	10.18	37.89	23.91	48.07	34.09	65.79	55.79	-17.72
2	0.17344	10.13	34.54	20.69	44.67	30.82	64.79	54.79	-20.12	-23.97
3	0.20078	10.07	29.99	14.45	40.06	24.52	63.58	53.58	-23.52	-29.06
4	0.30234	10.08	19.06	6.33	29.14	16.41	60.18	50.18	-31.04	-33.77
5	0.41563	10.09	24.65	18.43	34.74	28.52	57.54	47.54	-22.80	-19.02
6	21.36719	10.89	14.15	9.17	25.04	20.06	60.00	50.00	-34.96	-29.94
7	27.58203	11.10	15.84	11.42	26.94	22.52	60.00	50.00	-33.06	-27.48

#### REMARKS:

1. Q.P. and AV. are abbreviations of quasi-peak and average individually.
2. The emission levels of other frequencies were very low against the limit.
3. Margin value = Emission level - Limit value
4. Correction factor = Insertion loss + Cable loss
5. Emission Level = Correction Factor + Reading Value.

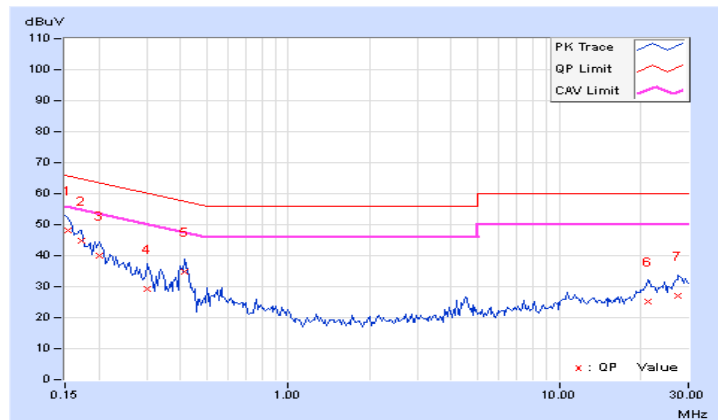

#### 4.2.8 Test Results (Mode 2)

Phase	Line (L)	Detector Function	Quasi-Peak (QP) / Average (AV)
-------	----------	-------------------	--------------------------------

No	Freq. [MHz]	Corr.	Reading Value		Emission Level		Limit		Margin	
		Factor	[dB (uV)]		[dB (uV)]		[dB (uV)]		(dB)	
	(dB)	Q.P.	AV.	Q.P.	AV.	Q.P.	AV.	Q.P.	AV.	
1	0.15000	10.14	38.19	29.22	48.33	39.36	66.00	56.00	-17.67	-16.64
2	0.18125	10.13	32.71	23.73	42.84	33.86	64.43	54.43	-21.59	-20.57
3	0.21250	10.12	28.58	20.42	38.70	30.54	63.11	53.11	-24.41	-22.57
4	0.23984	10.12	26.20	19.92	36.32	30.04	62.10	52.10	-25.78	-22.06
5	0.40781	10.11	30.22	20.52	40.33	30.63	57.69	47.69	-17.36	-17.06
6	21.93750	10.88	20.78	16.03	31.66	26.91	60.00	50.00	-28.34	-23.09
7	28.16016	11.11	25.57	20.65	36.68	31.76	60.00	50.00	-23.32	-18.24

#### REMARKS:

1. Q.P. and AV. are abbreviations of quasi-peak and average individually.
2. The emission levels of other frequencies were very low against the limit.
3. Margin value = Emission level - Limit value
4. Correction factor = Insertion loss + Cable loss
5. Emission Level = Correction Factor + Reading Value.

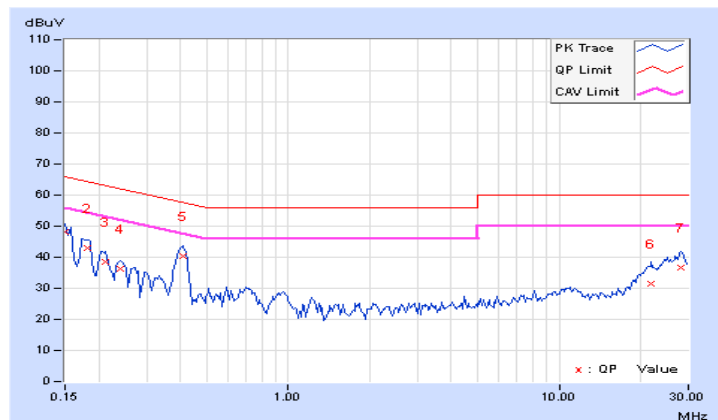

Phase	Neutral (N)	Detector Function	Quasi-Peak (QP) / Average (AV)
-------	-------------	-------------------	--------------------------------

No	Freq. [MHz]	Corr. Factor	Reading Value [dB (uV)]		Emission Level [dB (uV)]		Limit [dB (uV)]		Margin (dB)	
		(dB)	Q.P.	AV.	Q.P.	AV.	Q.P.	AV.	Q.P.	AV.
	1	0.15000	10.19	38.86	30.40	49.05	40.59	66.00	56.00	-16.95
2	0.17734	10.12	33.74	24.51	43.86	34.63	64.61	54.61	-20.75	-19.98
3	0.20859	10.07	29.94	23.33	40.01	33.40	63.26	53.26	-23.25	-19.86
4	0.23984	10.07	27.06	21.52	37.13	31.59	62.10	52.10	-24.97	-20.51
<b>5</b>	<b>0.40781</b>	<b>10.09</b>	<b>32.10</b>	<b>22.53</b>	<b>42.19</b>	<b>32.62</b>	<b>57.69</b>	<b>47.69</b>	<b>-15.50</b>	<b>-15.07</b>
6	23.52734	10.96	22.83	17.83	33.79	28.79	60.00	50.00	-26.21	-21.21
7	27.83594	11.11	25.88	20.78	36.99	31.89	60.00	50.00	-23.01	-18.11

#### REMARKS:

1. Q.P. and AV. are abbreviations of quasi-peak and average individually.
2. The emission levels of other frequencies were very low against the limit.
3. Margin value = Emission level - Limit value
4. Correction factor = Insertion loss + Cable loss
5. Emission Level = Correction Factor + Reading Value.

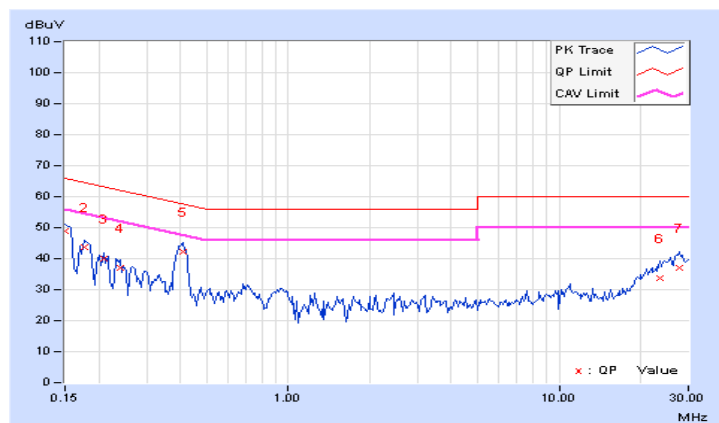

### 4.3 Transmit Power Measurement

#### 4.3.1 Limits of Transmit Power Measurement

Operation Band	EUT Category		Limit
U-NII-1		Outdoor Access Point	1 Watt (30 dBm) (Max. e.i.r.p $\leq$ 125mW(21 dBm) at any elevation angle above 30 degrees as measured from the horizon)
		Fixed point-to-point Access Point	1 Watt (30 dBm)
		Indoor Access Point	1 Watt (30 dBm)
		Mobile and Portable client device	250mW (24 dBm)
U-NII-2A		√	250mW (24 dBm) or 11 dBm+10 log B*
U-NII-2C		√	250mW (24 dBm) or 11 dBm+10 log B*
U-NII-3		√	1 Watt (30 dBm)

\*B is the 26 dB emission bandwidth in megahertz

Per KDB 662911 Method of conducted output power measurement on IEEE 802.11 devices,

Array Gain = 0 dB (i.e., no array gain) for  $N_{ANT} \leq 4$ ;

Array Gain = 0 dB (i.e., no array gain) for channel widths  $\geq 40$  MHz for any  $N_{ANT}$ ;

Array Gain =  $5 \log(N_{ANT}/N_{SS})$  dB or 3 dB, whichever is less for 20-MHz channel widths with  $N_{ANT} \geq 5$ .

For power measurements on all other devices: Array Gain =  $10 \log(N_{ANT}/N_{SS})$  dB.

#### 4.3.2 Test Setup

##### FOR POWER OUTPUT MEASUREMENT

For channel straddling 5725MHz:

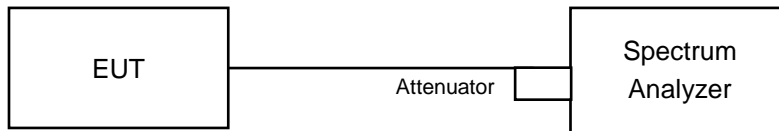

For other channels:

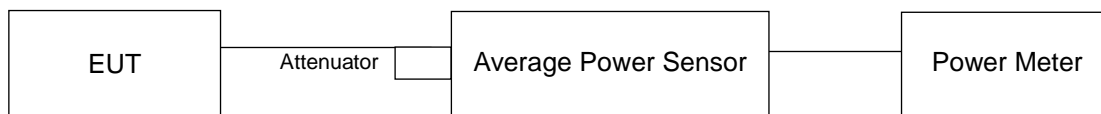

##### FOR 26dB OCCUPIED BANDWIDTH

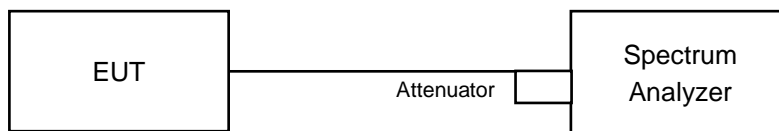

#### 4.3.3 Test Instruments

Refer to section 4.1.2 to get information of above instrument.

#### 4.3.4 Test Procedure

##### For Average Power Measurement

##### For channel straddling 5725MHz:

##### 802.11ac (VHT80)

###### Method SA-2

1. Set span to encompass the emission bandwidth (EBW) of the signal.
2. Set RBW = 1MHz.
3. Set the VBW  $\geq 3 \times$  RBW.
4. Number of points in sweep  $\geq 2$  Span / RBW.
5. Sweep time = auto.
6. Detector = RMS.
7. Trace average at least 100 traces in power averaging mode
8. Compute power by integrating the spectrum across the 26 dB EBW of the signal.
9. Duty factor need added to measured value (duty cycle < 98 percent).

##### Other Modulation mode

###### Method SA-1

1. Set span to encompass the entire emission bandwidth (EBW) of the signal.
2. Set RBW = 1MHz.
3. Set the VBW  $\geq 3 \times$  RBW.
4. Number of points in sweep  $\geq 2$  Span / RBW.
5. Sweep time = auto.
6. Set trigger to free run (duty cycle  $\geq 98$  percent)
7. Detector = RMS.
8. Trace average at least 100 traces in power averaging mode
9. Compute power by integrating the spectrum across the 26 dB EBW of the signal.

##### For other channels:

Method PM is used to perform output power measurement, trigger and gating function of wide band power meter is enabled to measure max output power of TX on burst. Duty factor is not added to measured value.

##### FOR 26dB OCCUPIED BANDWIDTH

1. Set RBW = approximately 1% of the emission bandwidth.
2. Set the VBW > RBW.
3. Detector = Peak.
4. Trace mode = max hold.
5. Measure the maximum width of the emission that is 26 dB down from the peak of the emission. Compare this with the RBW setting of the analyzer. Readjust RBW and repeat measurement as needed until the RBW/EBW ratio is approximately 1%.

#### 4.3.5 Deviation from Test Standard

No deviation.

#### 4.3.6 EUT Operating Condition

The software provided by client to enable the EUT under transmission condition continuously at lowest, middle and highest channel frequencies individually.



#### 4.3.7 Test Result

#### CDD Mode

#### 802.11a

#### Power Output:

Chan.	Chan. Freq. (MHz)	Maximum Conducted Power (dBm)		Total Power (mW)	Total Power (dBm)	Limit (dBm)	Pass / Fail
		Chain 0	Chain 1				
52	5260	20.00	19.33	185.704	22.69	24.00	Pass
60	5300	18.91	18.42	147.306	21.68	24.00	Pass
64	5320	17.78	17.02	110.329	20.43	24.00	Pass
100	5500	15.65	15.58	72.869	18.63	24.00	Pass
116	5580	19.51	18.45	159.315	22.02	24.00	Pass
140	5700	15.59	14.62	65.197	18.14	24.00	Pass
*144 (UNII-2C Band)	5720	15.36	14.18	60.538	17.82	24.00	Pass
*144 (UNII-3 Band)	5720	9.43	8.01	15.094	11.79	30.00	Pass

Note: \* Test was performed in accordance with Measurement follow FCC KDB 789033 UNII test procedure Method SA-1 and use spectrum analyzer test.

The Total Power for the straddle channel:

Chan.	Chan. Freq. (MHz)	Average Power (mW)	Average Power (dBm)
*144	5720	75.632	18.79

Note: The total power was calculated through formula and record the value for reference only.

**26dB BANDWIDTH:**

Channel	Frequency (MHz)	26dBc Bandwidth (MHz)	
		Chain 0	Chain 1
52	5260	34.49	37.22
60	5300	33.91	31.06
64	5320	23.68	26.62
100	5500	24.26	24.94
116	5580	38.92	38.07
140	5700	25.35	21.79
144 (UNII-2C Band)	5720	25.48	24.22

**Note: For U-NII-2A, U-NII-2C Band output power limitation is determined based on 26dBc bandwidth**

Power Limit = 11dBm + 10logB < U-NII-2A, U-NII-2C >			
Channel Number	Freq.(MHz)	Min. B(MHz)	Determined Conducted Limit (dBm)
52	5260	34.49	26.37 > 24
60	5300	31.06	25.92 > 24
64	5320	23.68	24.74 > 24
100	5500	24.26	24.84 > 24
116	5580	38.07	26.8 > 24
140	5700	21.79	24.38 > 24
144 (UNII-2C Band)	5720	24.22	24.84 > 24

## 802.11ac (VHT20)

### Power Output:

Chan.	Chan. Freq. (MHz)	Maximum Conducted Power (dBm)		Total Power (mW)	Total Power (dBm)	Limit (dBm)	Pass / Fail
		Chain 0	Chain 1				
52	5260	19.95	19.25	182.995	22.62	24.00	Pass
60	5300	18.91	18.37	146.511	21.66	24.00	Pass
64	5320	16.42	15.56	79.828	19.02	24.00	Pass
100	5500	13.52	13.16	43.192	16.35	24.00	Pass
116	5580	19.55	18.57	162.102	22.10	24.00	Pass
140	5700	14.48	13.54	50.648	17.05	24.00	Pass
*144 (UNII-2C Band)	5720	14.64	13.76	52.875	17.23	24.00	Pass
*144 (UNII-3 Band)	5720	9.09	8.09	14.552	11.63	30.00	Pass

Note: \* Test was performed in accordance with Measurement follow FCC KDB 789033 UNII test procedure Method SA-1 and use spectrum analyzer test.

The Total Power for the straddle channel:

Chan.	Chan. Freq. (MHz)	Average Power (mW)	Average Power (dBm)
*144	5720	67.427	18.29

Note: The total power was calculated through formula and record the value for reference only.

**26dB BANDWIDTH:**

Channel	Frequency (MHz)	26dBc Bandwidth (MHz)	
		Chain 0	Chain 1
52	5260	42.96	42.57
60	5300	38.49	33.70
64	5320	26.91	23.77
100	5500	22.74	23.03
116	5580	44.04	44.70
140	5700	22.88	21.97
144 (UNII-2C Band)	5720	22.53	22.63

**Note: For U-NII-2A, U-NII-2C Band output power limitation is determined based on 26dBc bandwidth**

Power Limit = 11dBm + 10logB < U-NII-2A, U-NII-2C >			
Channel Number	Freq.(MHz)	Min. B(MHz)	Determined Conducted Limit (dBm)
52	5260	42.57	27.29 > 24
60	5300	33.70	26.27 > 24
64	5320	23.77	24.76 > 24
100	5500	22.74	24.56 > 24
116	5580	44.04	27.43 > 24
140	5700	21.97	24.41 > 24
144 (UNII-2C Band)	5720	22.53	24.52 > 24

## 802.11ac (VHT40)

### Power Output:

Chan.	Chan. Freq. (MHz)	Maximum Conducted Power (dBm)		Total Power (mW)	Total Power (dBm)	Limit (dBm)	Pass / Fail
		Chain 0	Chain 1				
54	5270	18.62	17.47	128.625	21.09	24.00	Pass
62	5310	14.08	12.94	45.265	16.56	24.00	Pass
102	5510	10.36	9.99	20.841	13.19	24.00	Pass
110	5550	16.33	15.64	79.598	19.01	24.00	Pass
134	5670	15.41	14.36	62.044	17.93	24.00	Pass
*142 (UNII-2C Band)	5710	17.76	16.50	104.372	20.19	24.00	Pass
*142 (UNII-3 Band)	5710	8.05	6.60	10.954	10.40	30.00	Pass

Note: \* Test was performed in accordance with Measurement follow FCC KDB 789033 UNII test procedure Method SA-1 and use spectrum analyzer test.

The Total Power for the straddle channel:

Chan.	Chan. Freq. (MHz)	Average Power (mW)	Average Power (dBm)
*142	5710	115.326	20.62

Note: The total power was calculated through formula and record the value for reference only.

**26dB BANDWIDTH:**

Channel	Frequency (MHz)	26dBc Bandwidth (MHz)	
		Chain 0	Chain 1
54	5270	84.56	78.65
62	5310	49.16	48.19
102	5510	43.09	41.36
110	5550	69.31	74.45
134	5670	71.82	64.16
142 (UNII-2C Band)	5710	65.00	65.00

**Note: For U-NII-2A, U-NII-2C Band output power limitation is determined based on 26dBc bandwidth**

Power Limit = 11dBm + 10logB < U-NII-2A, U-NII-2C >			
Channel Number	Freq.(MHz)	Min. B(MHz)	Determined Conducted Limit (dBm)
54	5270	78.65	29.95 > 24
62	5310	48.19	27.82 > 24
102	5510	41.36	27.16 > 24
110	5550	69.31	29.4 > 24
134	5670	64.16	29.07 > 24
142 (UNII-2C Band)	5710	65.00	29.12 > 24

**802.11ac (VHT80)**

Chan.	Chan. Freq. (MHz)	Maximum Conducted Power (dBm)		Total Power (mW)	Total Power (dBm)	Limit (dBm)	Pass / Fail
		Chain 0	Chain 1				
58	5290	13.13	12.10	36.777	15.66	24.00	Pass
106	5530	9.85	8.86	17.352	12.39	24.00	Pass
122	5610	15.51	14.47	63.553	18.03	24.00	Pass
*138 (UNII-2C Band)	5690	15.12	14.35	62.333	17.95	24.00	Pass
*138 (UNII-3 Band)	5690	1.71	0.25	2.653	4.24	30.00	Pass

Note: \* Test was performed in accordance with Measurement follow FCC KDB 789033 UNII test procedure Method SA-2 and use spectrum analyzer test.

The Total Power for the straddle channel:

Chan.	Chan. Freq. (MHz)	Average Power (mW)	Average Power (dBm)
*138	5690	64.986	18.13

Note: The total power was calculated through formula and record the value for reference only.

### 26dB OCCUPIED BANDWIDTH

Channel	Frequency (MHz)	26dBc Bandwidth (MHz)	
		Chain 0	Chain 1
58	5290	85.33	82.41
106	5530	83.10	86.77
122	5610	133.66	123.67
138 (UNII-2C Band)	5690	120.97	122.87

**Note: For U-NII-2A, U-NII-2C Band output power limitation is determined based on 26dBc bandwidth**

Power Limit = 11dBm + 10logB < U-NII-2A, U-NII-2C >			
Channel Number	Freq.(MHz)	Min. B(MHz)	Determined Conducted Limit (dBm)
58	5290	82.41	30.15 > 24
106	5530	83.10	30.19 > 24
122	5610	123.67	31.92 > 24
138 (UNII-2C Band)	5690	120.97	31.82 > 24



## Beamforming Mode

### 802.11ac (VHT20)

#### Power Output:

Chan.	Chan. Freq. (MHz)	Maximum Conducted Power (dBm)		Total Power (mW)	Total Power (dBm)	Limit (dBm)	Pass / Fail
		Chain 0	Chain 1				
52	5260	19.61	18.84	167.971	22.25	22.26	Pass
60	5300	18.91	18.37	146.511	21.66	22.26	Pass
64	5320	16.42	15.56	79.828	19.02	22.26	Pass
100	5500	13.52	13.16	43.192	16.35	22.63	Pass
116	5580	19.55	18.57	162.102	22.10	22.63	Pass
140	5700	14.48	13.54	50.648	17.05	22.63	Pass
*144 (UNII-2C Band)	5720	14.64	13.76	52.875	17.23	22.63	Pass
*144 (UNII-3 Band)	5720	9.09	8.09	14.552	11.63	27.21	Pass

Note: 1. \* Test was performed in accordance with Measurement follow FCC KDB 789033 UNII test procedure Method SA-1 and use spectrum analyzer test.

2. For UNII-2A: Directional gain =  $10 \log[(10^{G1/20} + 10^{G2/20})^2 / 2] = 7.74\text{dBi} > 6\text{dBi}$ , so the power limit shall be reduced to  $24 - (7.74 - 6) = 22.26\text{dBm}$ .

3. For UNII-2C: Directional gain =  $10 \log[(10^{G1/20} + 10^{G2/20})^2 / 2] = 7.37\text{dBi} > 6\text{dBi}$ , so the power limit shall be reduced to  $24 - (7.37 - 6) = 22.63\text{dBm}$ .

4. For UNII-3: Directional gain =  $10 \log[(10^{G1/20} + 10^{G2/20})^2 / 2] = 8.79\text{dBi} > 6\text{dBi}$ , so the power limit shall be reduced to  $30 - (8.79 - 6) = 27.21\text{dBm}$ .

The Total Power for the straddle channel:

Chan.	Chan. Freq. (MHz)	Average Power (mW)	Average Power (dBm)
*144	5720	67.427	18.29

Note: The total power was calculated through formula and record the value for reference only.

**26dB BANDWIDTH:**

Channel	Frequency (MHz)	26dBc Bandwidth (MHz)	
		Chain 0	Chain 1
52	5260	42.96	42.57
60	5300	38.49	33.70
64	5320	26.91	23.77
100	5500	22.74	23.03
116	5580	44.04	44.70
140	5700	22.88	21.97
144 (UNII-2C Band)	5720	22.53	22.63

**Note: For U-NII-2A, U-NII-2C Band output power limitation is determined based on 26dBc bandwidth**

Power Limit = 11dBm + 10logB < U-NII-2A, U-NII-2C >			
Channel Number	Freq.(MHz)	Min. B(MHz)	Determined Conducted Limit (dBm)
52	5260	42.57	27.29 > 24
60	5300	33.70	26.27 > 24
64	5320	23.77	24.76 > 24
100	5500	22.74	24.56 > 24
116	5580	44.04	27.43 > 24
140	5700	21.97	24.41 > 24
144 (UNII-2C Band)	5720	22.53	24.52 > 24

## 802.11ac (VHT40)

### Power Output:

Chan.	Chan. Freq. (MHz)	Maximum Conducted Power (dBm)		Total Power (mW)	Total Power (dBm)	Limit (dBm)	Pass / Fail
		Chain 0	Chain 1				
54	5270	18.62	17.47	128.625	21.09	22.26	Pass
62	5310	14.08	12.94	45.265	16.56	22.26	Pass
102	5510	10.36	9.99	20.841	13.19	22.63	Pass
110	5550	16.33	15.64	79.598	19.01	22.63	Pass
134	5670	15.41	14.36	62.044	17.93	22.63	Pass
*142 (UNII-2C Band)	5710	17.76	16.50	104.372	20.19	22.63	Pass
*142 (UNII-3 Band)	5710	8.05	6.60	10.954	10.40	27.21	Pass

Note: 1. \* Test was performed in accordance with Measurement follow FCC KDB 789033 UNII test procedure Method SA-1 and use spectrum analyzer test.

2. For UNII-2A: Directional gain =  $10 \log[(10^{G1/20} + 10^{G2/20})^2 / 2] = 7.74\text{dBi} > 6\text{dBi}$ , so the power limit shall be reduced to  $24 - (7.74 - 6) = 22.26\text{dBm}$ .

3. For UNII-2C: Directional gain =  $10 \log[(10^{G1/20} + 10^{G2/20})^2 / 2] = 7.37\text{dBi} > 6\text{dBi}$ , so the power limit shall be reduced to  $24 - (7.37 - 6) = 22.63\text{dBm}$ .

4. For UNII-3: Directional gain =  $10 \log[(10^{G1/20} + 10^{G2/20})^2 / 2] = 8.79\text{dBi} > 6\text{dBi}$ , so the power limit shall be reduced to  $30 - (8.79 - 6) = 27.21\text{dBm}$ .

The Total Power for the straddle channel:

Chan.	Chan. Freq. (MHz)	Average Power (mW)	Average Power (dBm)
*142	5710	115.326	20.62

Note: The total power was calculated through formula and record the value for reference only.

**26dB BANDWIDTH:**

Channel	Frequency (MHz)	26dBc Bandwidth (MHz)	
		Chain 0	Chain 1
54	5270	84.56	78.65
62	5310	49.16	48.19
102	5510	43.09	41.36
110	5550	69.31	74.45
134	5670	71.82	64.16
142 (UNII-2C Band)	5710	65.00	65.00

**Note: For U-NII-2A, U-NII-2C Band output power limitation is determined based on 26dBc bandwidth**

Power Limit = 11dBm + 10logB < U-NII-2A, U-NII-2C >			
Channel Number	Freq.(MHz)	Min. B(MHz)	Determined Conducted Limit (dBm)
54	5270	78.65	29.95 > 24
62	5310	48.19	27.82 > 24
102	5510	41.36	27.16 > 24
110	5550	69.31	29.4 > 24
134	5670	64.16	29.07 > 24
142 (UNII-2C Band)	5710	65.00	29.12 > 24

### 802.11ac (VHT80)

Chan.	Chan. Freq. (MHz)	Maximum Conducted Power (dBm)		Total Power (mW)	Total Power (dBm)	Limit (dBm)	Pass / Fail
		Chain 0	Chain 1				
58	5290	13.13	12.10	36.777	15.66	22.26	Pass
106	5530	9.85	8.86	17.352	12.39	22.63	Pass
122	5610	15.51	14.47	63.553	18.03	22.63	Pass
*138 (UNII-2C Band)	5690	15.12	14.35	62.333	17.95	22.63	Pass
*138 (UNII-3 Band)	5690	1.71	0.25	2.653	4.24	27.21	Pass

Note: 1. \* Test was performed in accordance with Measurement follow FCC KDB 789033 UNII test procedure Method SA-1 and use spectrum analyzer test.

2. For UNII-2A: Directional gain =  $10 \log[(10^{G1/20} + 10^{G2/20})^2 / 2] = 7.74\text{dBi} > 6\text{dBi}$  , so the power limit shall be reduced to  $24-(7.74-6) = 22.26\text{dBm}$ .
3. For UNII-2C: Directional gain =  $10 \log[(10^{G1/20} + 10^{G2/20})^2 / 2] = 7.37\text{dBi} > 6\text{dBi}$  , so the power limit shall be reduced to  $24-(7.37-6) = 22.63\text{dBm}$ .
4. For UNII-3: Directional gain =  $10 \log[(10^{G1/20} + 10^{G2/20})^2 / 2] = 8.79\text{dBi} > 6\text{dBi}$  , so the power limit shall be reduced to  $30-(8.79-6) = 27.21\text{dBm}$ .

The Total Power for the straddle channel:

Chan.	Chan. Freq. (MHz)	Average Power (mW)	Average Power (dBm)
*138	5690	64.986	18.13

Note: The total power was calculated through formula and record the value for reference only.

### 26dB OCCUPIED BANDWIDTH

Channel	Frequency (MHz)	26dBc Bandwidth (MHz)	
		Chain 0	Chain 1
58	5290	85.33	82.41
106	5530	83.10	86.77
122	5610	133.66	123.67
138 (UNII-2C Band)	5690	120.97	122.87

**Note: For U-NII-2A, U-NII-2C Band output power limitation is determined based on 26dBc bandwidth**

Power Limit = 11dBm + 10logB < U-NII-2A, U-NII-2C >			
Channel Number	Freq.(MHz)	Min. B(MHz)	Determined Conducted Limit (dBm)
58	5290	82.41	30.15 > 24
106	5530	83.10	30.19 > 24
122	5610	123.67	31.92 > 24
138 (UNII-2C Band)	5690	120.97	31.82 > 24

※Add test for each data rate output power (require by manufacturer):

802.11a

CHANNEL	FREQUENCY (MHz)	AVERAGE POWER (dBm)							
		Data rate							
		6Mbps	9Mbps	12Mbps	18Mbps	24Mbps	36Mbps	48Mbps	54Mbps
52	5260	22.69	22.59	22.53	22.46	22.64	22.42	22.45	22.23
60	5300	21.68	21.67	21.45	21.36	21.49	21.49	21.38	21.59
64	5320	20.43	20.21	20.41	20.21	20.25	20.23	20.23	20.42
100	5500	18.63	18.62	18.54	18.34	18.52	18.32	18.35	18.42
116	5580	22.02	21.87	21.82	21.87	21.93	21.84	21.7	21.67
140	5700	18.14	18.12	17.96	17.91	17.92	17.86	17.72	17.57
144	5720	22.14	22.13	22.01	22.00	22.06	22.05	22.04	22.03

802.11ac (VHT20)

Nss=1

CHANNEL	FREQUENCY (MHz)	AVERAGE POWER (dBm)								
		Data rate								
		MCS0	MCS1	MCS2	MCS3	MCS4	MCS5	MCS6	MCS7	MCS8
52	5260	22.62	22.57	22.37	22.25	22.21	22.03	22.24	22.19	22.09
60	5300	21.66	21.53	21.38	21.21	21.23	21.25	21.05	21.19	21.26
64	5320	19.02	18.80	18.88	18.72	18.85	18.83	18.91	18.9	18.92
100	5500	16.35	16.34	16.22	16.27	16.12	16.2	16.3	16.23	16.24
116	5580	22.10	21.89	21.91	21.78	21.9	22.07	22.01	21.88	22.07
140	5700	17.05	16.85	16.64	16.62	16.73	16.58	16.45	16.54	16.74
144	5720	22.05	21.85	21.72	21.84	21.8	21.64	21.8	21.63	21.69

Nss=2

CHANNEL	FREQUENCY (MHz)	AVERAGE POWER (dBm)								
		Data rate								
		MCS0	MCS1	MCS2	MCS3	MCS4	MCS5	MCS6	MCS7	MCS8
52	5260	22.60	22.54	22.50	22.32	22.49	22.42	22.36	22.30	22.32
60	5300	21.64	21.50	21.28	21.46	21.43	21.25	21.31	21.49	21.31
64	5320	18.93	18.90	18.86	18.70	18.66	18.61	18.71	18.88	18.68
100	5500	16.20	16.15	16.07	16.09	15.88	15.86	15.71	15.53	15.51
116	5580	22.02	21.98	22.07	22.09	22.09	22.09	21.91	21.72	21.58
140	5700	17.03	16.90	16.86	16.95	16.8	16.81	16.61	16.78	16.86
144	5720	21.98	21.95	21.74	21.64	21.73	21.9	21.72	21.77	21.65

**802.11ac (VHT40)**
**Nss=1**

CHANNEL	FREQUENCY (MHz)	AVERAGE POWER (dBm)									
		Data rate									
		MCS0	MCS1	MCS2	MCS3	MCS4	MCS5	MCS6	MCS7	MCS8	MCS9
54	5270	21.09	20.87	21.03	21.01	21.02	20.86	20.84	20.98	20.76	20.58
62	5310	16.56	16.39	16.17	16.08	16.16	16.04	15.92	15.77	15.87	15.83
102	5510	13.19	13.18	13.01	12.87	13.05	12.95	12.78	12.74	12.94	12.88
110	5550	19.01	18.97	18.78	18.84	18.85	18.87	18.68	18.73	18.86	18.71
134	5670	17.93	17.75	17.58	17.65	17.73	17.69	17.81	17.71	17.67	17.76
142	5710	23.82	23.66	23.77	23.69	23.57	23.71	23.79	23.62	23.68	23.72

**Nss=2**

CHANNEL	FREQUENCY (MHz)	AVERAGE POWER (dBm)									
		Data rate									
		MCS0	MCS1	MCS2	MCS3	MCS4	MCS5	MCS6	MCS7	MCS8	MCS9
54	5270	20.96	20.94	20.89	20.72	20.88	20.80	20.86	20.86	20.88	20.67
62	5310	16.55	16.54	16.50	16.30	16.51	16.48	16.41	16.22	16.42	16.50
102	5510	13.15	13.07	13.15	13.14	13.03	12.92	12.93	12.93	13.1	13.15
110	5550	18.93	18.80	18.77	18.93	18.77	18.74	18.64	18.62	18.82	18.99
134	5670	17.79	17.76	17.63	17.83	17.71	17.86	17.92	17.78	17.78	17.72
142	5710	23.75	23.72	23.60	23.71	23.79	23.74	23.66	23.46	23.47	23.30

**802.11ac (VHT80)**
**Nss=1**

CHANNEL	FREQUENCY (MHz)	AVERAGE POWER (dBm)									
		Data rate									
		MCS0	MCS1	MCS2	MCS3	MCS4	MCS5	MCS6	MCS7	MCS8	MCS9
58	5290	15.66	15.55	15.57	15.59	15.42	15.26	15.26	15.11	14.96	15.00
106	5530	12.39	12.36	12.18	12.14	12.18	12.15	12.31	12.18	12.13	12.15
122	5610	18.03	17.96	17.82	17.92	18.01	17.8	17.75	17.86	17.71	17.61
138	5690	21.00	20.86	20.89	20.99	20.77	20.73	20.83	20.91	20.91	20.86

**Nss=2**

CHANNEL	FREQUENCY (MHz)	AVERAGE POWER (dBm)									
		Data rate									
		MCS0	MCS1	MCS2	MCS3	MCS4	MCS5	MCS6	MCS7	MCS8	MCS9
58	5290	15.62	15.57	15.54	15.53	15.57	15.50	15.31	15.26	15.29	15.35
106	5530	12.37	12.36	12.23	12.29	12.33	12.17	12.01	11.97	12.03	11.87
122	5610	18.99	17.97	17.84	17.88	17.96	17.96	17.87	17.66	17.86	17.84
138	5690	20.93	20.85	20.93	20.94	20.9	20.9	20.74	20.52	20.64	20.54



### Spectrum Plot of Worst Value

#### 802.11a\_Chain 1 / CH140

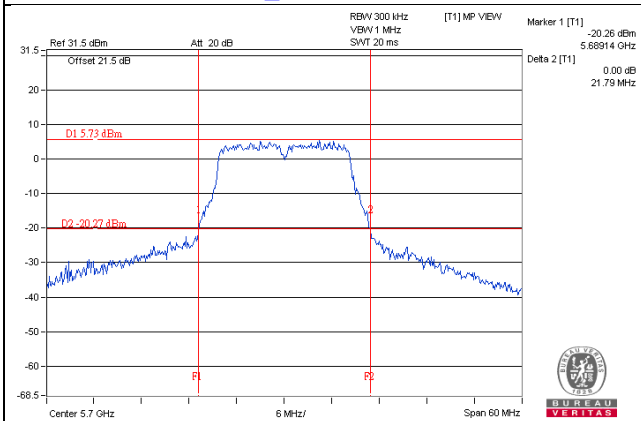

#### 802.11ac (VHT20)\_Chain 1 / CH140

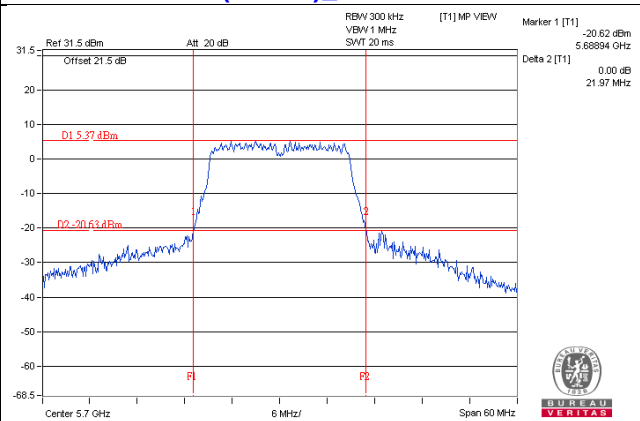

#### 8802.11ac (VHT40)\_Chain 1 / CH102

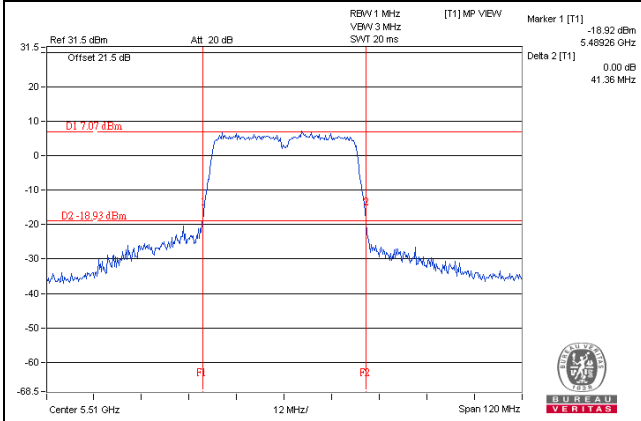

#### 802.11ac (VHT80)\_Chain 1 / CH58

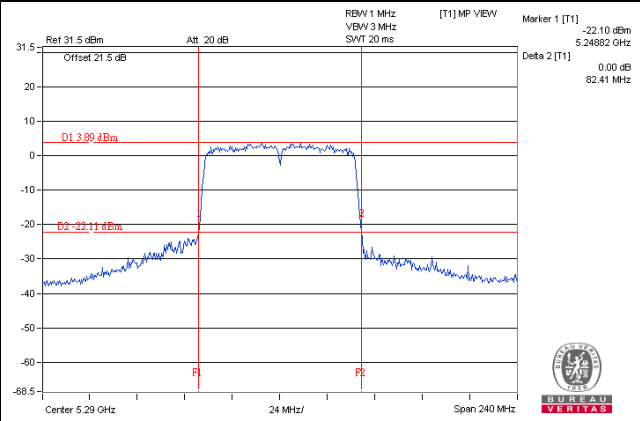

## 4.4 Occupied Bandwidth Measurement

### 4.4.1 Test Setup

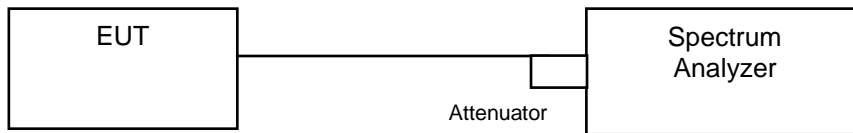

### 4.4.2 Test Instruments

Refer to section 4.1.2 to get information of above instrument.

### 4.4.3 Test Procedure

The transmitter output was connected to the spectrum analyzer through an attenuator. The bandwidth of the fundamental frequency was measured by spectrum analyzer with resolution bandwidth in the range of 1% to 5% of the anticipated emission bandwidth, and a video bandwidth at least 3x the resolution bandwidth and set the detector to SAMPLE. The width of a frequency band such that, below the lower and above the upper frequency limits, the mean powers emitted are each equal to a specified percentage 0.5 %of the total mean power of a given emission.

#### 4.4.4 Test Results

##### 802.11a

Channel	Channel Frequency (MHz)	Occupied Bandwidth (MHz)	
		CHAIN 0	CHAIN 1
52	5260	18.24	18.48
60	5300	17.52	17.52
64	5320	17.28	17.04
100	5500	17.16	17.28
116	5580	19.20	20.16
140	5700	17.28	16.92
144 (UNII-2C Band)	5720	14.96	14.60
144 (UNII-3 Band)	5720	4.36	4.96

##### 802.11ac (VHT20)

Channel	Channel Frequency (MHz)	Occupied Bandwidth (MHz)	
		CHAIN 0	CHAIN 1
52	5260	19.08	19.20
60	5300	18.36	18.24
64	5320	18.12	18.12
100	5500	18.12	18.12
116	5580	20.76	21.12
140	5700	18.12	18.12
144 (UNII-2C Band)	5720	14.36	14.60
144 (UNII-3 Band)	5720	4.24	4.60

##### 802.11ac (VHT40)

Channel	Channel Frequency (MHz)	Occupied Bandwidth (MHz)	
		CHAIN 0	CHAIN 1
54	5270	37.44	37.20
62	5310	36.72	36.72
102	5510	36.72	36.72
110	5550	37.20	36.96
134	5670	36.96	36.96
142 (UNII-2C Band)	5710	44.00	43.40
142 (UNII-3 Band)	5710	15.80	14.60

**802.11ac (VHT80)**

Channel	Channel Frequency (MHz)	Occupied Bandwidth (MHz)	
		CHAIN 0	CHAIN 1
58	5290	75.84	75.84
106	5530	76.32	76.32
122	5610	75.84	76.32
138 (UNII-2C Band)	5690	73.88	73.88
138 (UNII-3 Band)	5690	5.80	3.40

### Spectrum Plot of Worst Value

**802.11a\_Chain1 / CH116**

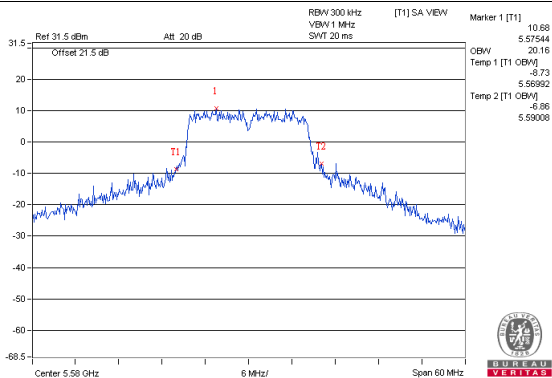

**802.11ac (VHT20)\_Chain1 / CH116**

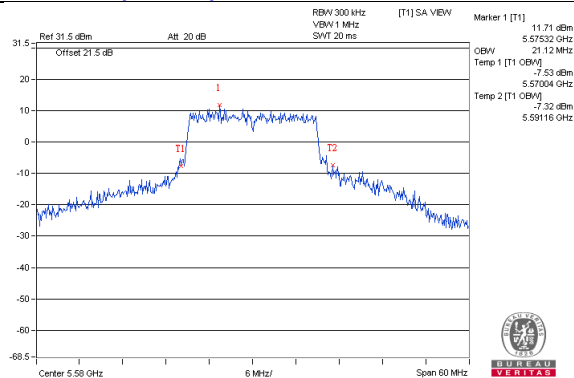

**802.11ac(VHT40)\_Chain0 / CH142 (UNII-2C)**

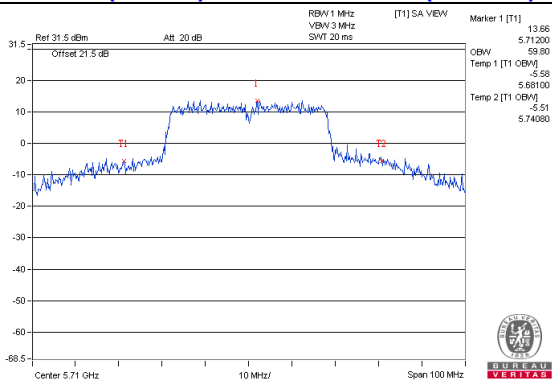

**802.11ac (VHT80)\_Chain0 / CH106**

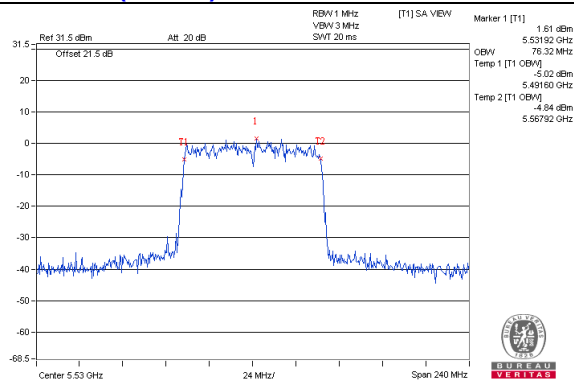

## 4.5 Peak Power Spectral Density Measurement

### 4.5.1 Limits of Peak Power Spectral Density Measurement

Operation Band	EUT Category		Limit
U-NII-1		Outdoor Access Point	17dBm/ MHz
		Fixed point-to-point Access Point	
		Indoor Access Point	
		Mobile and Portable client device	11dBm/ MHz
U-NII-2A		√	11dBm/ MHz
U-NII-2C		√	11dBm/ MHz
U-NII-3		√	30dBm/ 500kHz

### 4.5.2 Test Setup

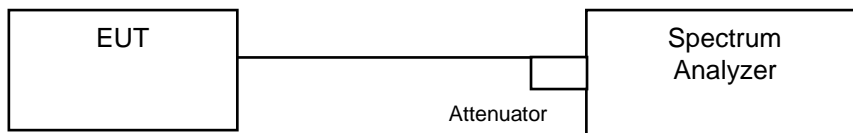

### 4.5.3 Test Instruments

Refer to section 4.1.2 to get information of above instrument.

#### 4.5.4 Test Procedure

##### **802.11a, 802.11ac (VHT20), 802.11ac (VHT40)**

##### **For U-NII-2A, UNII-2C:**

Using method SA-1

1. Set span to encompass the entire emission bandwidth (EBW) of the signal.
2. Set RBW = 1 MHz, Set VBW  $\geq$  3 MHz, Detector = RMS
3. Sweep time = auto, trigger set to "free run".
4. Trace average at least 100 traces in power averaging mode.
5. Record the max value

##### **For U-NII-3:**

1. Set span to encompass the entire emission bandwidth (EBW) of the signal.
2. Set RBW = 300 kHz, Set VBW  $\geq$  1 MHz, Detector = RMS
3. Use the peak marker function to determine the maximum power level in any 300 kHz band segment within the fundamental EBW.
4. Scale the observed power level to an equivalent value in 500 kHz by adjusting (reducing) the measured power by a bandwidth correction factor (BWCF) where  $BWCF = 10\log(500 \text{ kHz}/300\text{kHz})$
5. Sweep time = auto, trigger set to "free run".
6. Trace average at least 100 traces in power averaging mode.
7. Record the max value

##### **802.11ac (VHT80)**

##### **For U-NII-2A, UNII-2C:**

Using method SA-2

1. Set span to encompass the entire emission bandwidth (EBW) of the signal.
2. Set RBW = 1 MHz, Set VBW  $\geq$  3 MHz, Detector = RMS
3. Sweep time = auto, trigger set to "free run".
4. Trace average at least 100 traces in power averaging mode.
5. Record the max value and add  $10 \log (1/\text{duty cycle})$

##### **For U-NII-3:**

1. Set span to encompass the entire emission bandwidth (EBW) of the signal.
2. Set RBW = 300 kHz, Set VBW  $\geq$  1 MHz, Detector = RMS
3. Use the peak marker function to determine the maximum power level in any 300 kHz band segment within the fundamental EBW.
4. Scale the observed power level to an equivalent value in 500 kHz by adjusting (reducing) the measured power by a bandwidth correction factor (BWCF) where  $BWCF = 10\log(500 \text{ kHz}/300\text{kHz})$
5. Sweep time = auto, trigger set to "free run".
6. Trace average at least 100 traces in power averaging mode.
7. Record the max value and add  $10 \log (1/\text{duty cycle})$

#### 4.5.5 Deviation from Test Standard

No deviation.

#### 4.5.6 EUT Operating Condition

Same as Item 4.3.6.

4.5.7 Test Results  
 For U-NII-2A, UNII-2C:  
 802.11a

Chan.	Chan. Freq. (MHz)	PSD (dBm/MHz)		Total Power Density (dBm/MHz)	MAX. Limit (dBm/MHz)	Pass / Fail
		Chain 0	Chain 1			
52	5260	6.37	6.09	9.24	9.26	Pass
60	5300	4.72	4.34	7.54	9.26	Pass
64	5320	3.68	3.20	6.46	9.26	Pass
100	5500	3.45	2.91	6.20	9.63	Pass
120	5600	6.24	5.42	8.86	9.63	Pass
140	5700	1.39	-0.84	3.43	9.63	Pass
144 (UNII-2C Band)	5720	6.16	4.93	8.60	9.63	Pass

- Note:** 1. Method a) of power density measurement of KDB 662911 is using for calculating total power density. Total power density is summing entire spectra across corresponding frequency bins on the various outputs by computer.
2. For UNII-2A: Directional gain =  $10 \log[(10^{G1/20} + 10^{G2/20})^2 / 2] = 7.74\text{dBi} > 6\text{dBi}$ , so the power density limit shall be reduced to  $11-(7.74-6) = 9.26\text{dBm}$ .
3. For UNII-2C: Directional gain =  $10 \log[(10^{G1/20} + 10^{G2/20})^2 / 2] = 7.37\text{dBi} > 6\text{dBi}$ , so the power density limit shall be reduced to  $11-(7.37-6) = 9.63\text{dBm}$ .

802.11ac (VHT20)

Chan.	Chan. Freq. (MHz)	PSD (dBm/MHz)		Total Power Density (dBm/MHz)	MAX. Limit (dBm/MHz)	Pass / Fail
		Chain 0	Chain 1			
52	5260	6.28	6.18	9.24	9.26	Pass
60	5300	4.45	3.93	7.21	9.26	Pass
64	5320	1.77	1.26	4.53	9.26	Pass
100	5500	1.07	0.56	3.83	9.63	Pass
120	5600	6.22	5.15	8.73	9.63	Pass
140	5700	-0.48	-1.27	2.15	9.63	Pass
144 (UNII-2C Band)	5720	6.21	5.10	8.70	9.63	Pass

- Note:** 1. Method a) of power density measurement of KDB 662911 is using for calculating total power density. Total power density is summing entire spectra across corresponding frequency bins on the various outputs by computer.
2. For UNII-2A: Directional gain =  $10 \log[(10^{G1/20} + 10^{G2/20})^2 / 2] = 7.74\text{dBi} > 6\text{dBi}$ , so the power density limit shall be reduced to  $11-(7.74-6) = 9.26\text{dBm}$ .
3. For UNII-2C: Directional gain =  $10 \log[(10^{G1/20} + 10^{G2/20})^2 / 2] = 7.37\text{dBi} > 6\text{dBi}$ , so the power density limit shall be reduced to  $11-(7.37-6) = 9.63\text{dBm}$ .



### 802.11ac (VHT40)

Chan.	Chan. Freq. (MHz)	PSD (dBm/MHz)		Total Power Density (dBm/MHz)	MAX. Limit (dBm/MHz)	Pass / Fail
		Chain 0	Chain 1			
54	5270	1.39	0.77	4.10	9.26	Pass
62	5310	-3.47	-4.32	-0.86	9.26	Pass
102	5510	-4.92	-5.51	-2.19	9.63	Pass
110	5550	1.20	0.39	3.82	9.63	Pass
134	5670	-1.78	-2.79	0.75	9.63	Pass
142 (UNII-2C Band)	5710	3.75	2.49	6.18	9.63	Pass

- Note:** 1. Method a) of power density measurement of KDB 662911 is using for calculating total power density. Total power density is summing entire spectra across corresponding frequency bins on the various outputs by computer.
2. For UNII-2A: Directional gain =  $10 \log[(10^{G1/20} + 10^{G2/20})^2 / 2] = 7.74\text{dBi} > 6\text{dBi}$ , so the power density limit shall be reduced to  $11 - (7.74 - 6) = 9.26\text{dBm}$ .
3. For UNII-2C: Directional gain =  $10 \log[(10^{G1/20} + 10^{G2/20})^2 / 2] = 7.37\text{dBi} > 6\text{dBi}$ , so the power density limit shall be reduced to  $11 - (7.37 - 6) = 9.63\text{dBm}$ .

### 802.11ac (VHT80)

Chan.	Chan. Freq. (MHz)	PSD W/O Duty Factor (dBm/MHz)		Duty Factor (dB)	Total PSD With Duty Factor (dBm/MHz)	MAX. Limit (dBm/MHz)	Pass / Fail
		Chain 0	Chain 1				
58	5290	-7.30	-8.11	0.18	-4.49	9.26	Pass
106	5530	-8.58	-9.06	0.18	-5.62	9.63	Pass
122	5610	-3.06	-3.87	0.18	-0.25	9.63	Pass
138 (UNII-2C Band)	5690	-1.90	-3.06	0.18	0.75	9.63	Pass

- Note:** 1. Method a) of power density measurement of KDB 662911 is using for calculating total power density. Total power density is summing entire spectra across corresponding frequency bins on the various outputs by computer.
2. For UNII-2A: Directional gain =  $10 \log[(10^{G1/20} + 10^{G2/20})^2 / 2] = 7.74\text{dBi} > 6\text{dBi}$ , so the power density limit shall be reduced to  $11 - (7.74 - 6) = 9.26\text{dBm}$ .
3. For UNII-2C: Directional gain =  $10 \log[(10^{G1/20} + 10^{G2/20})^2 / 2] = 7.37\text{dBi} > 6\text{dBi}$ , so the power density limit shall be reduced to  $11 - (7.37 - 6) = 9.63\text{dBm}$ .
4. Refer to section 3.3 for duty cycle spectrum plot.

### Spectrum Plot of Worst Value

#### 802.11a\_Chain 0 / CH52

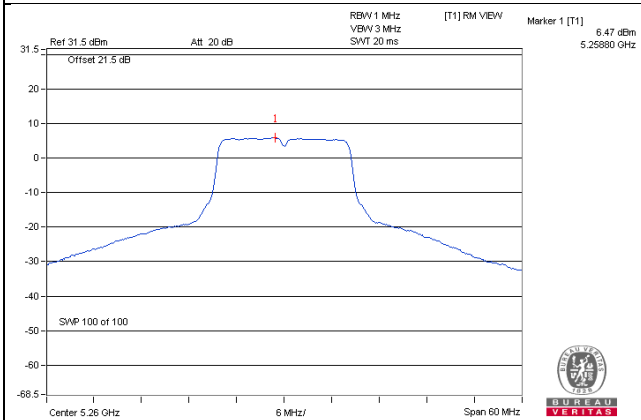

#### 802.11ac (VHT20)\_Chain 0 / CH52

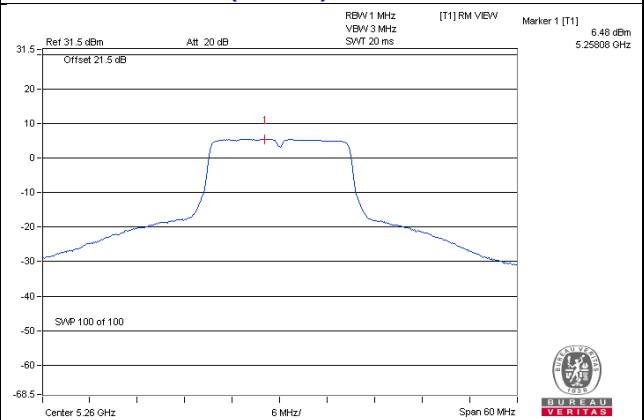

#### 802.11ac (VHT40)\_Chain 0 / CH142(UNII-2C Band)

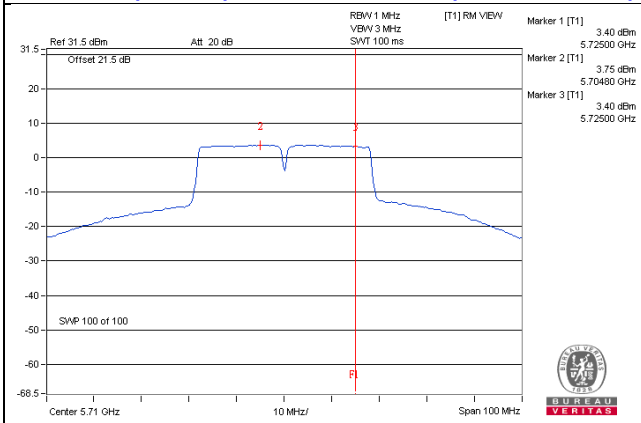

#### 802.11ac (VHT80)\_Chain 0 / CH138(UNII-2C Band)

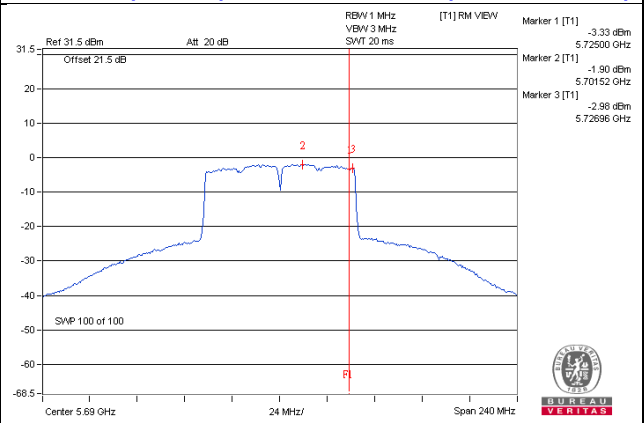

### For U-NII-3:

#### 802.11a

TX chain	Channel	Freq. (MHz)	PSD (dBm/300kHz)	PSD (dBm/500kHz)	10 log (N=2) dB	Total PSD (dBm/500k Hz)	Limit (dBm/500k Hz)	Pass /Fail
0	144 (UNII-3 Band)	5720	-1.73	0.49	3.01	3.50	27.21	Pass
1	144 (UNII-3 Band)	5720	-3.58	-1.36	3.01	1.65	27.21	Pass

Note: 1. Directional gain =  $10 \log[(10^{G1/20} + 10^{G2/20})^2 / 2] = 8.79\text{dBi} > 6\text{dBi}$ , so the power density limit shall be reduced to  $30 - (8.79 - 6) = 27.21\text{dBm}$ .

#### 802.11ac (VHT20)

TX chain	Channel	Freq. (MHz)	PSD (dBm/300kHz)	PSD (dBm/500kHz)	10 log (N=2) dB	Total PSD (dBm/500k Hz)	Limit (dBm/500k Hz)	Pass /Fail
0	144 (UNII-3 Band)	5720	-1.81	0.41	3.01	3.42	27.21	Pass
1	144 (UNII-3 Band)	5720	-3.28	-1.06	3.01	1.95	27.21	Pass

Note: 1. Directional gain =  $10 \log[(10^{G1/20} + 10^{G2/20})^2 / 2] = 8.79\text{dBi} > 6\text{dBi}$ , so the power density limit shall be reduced to  $30 - (8.79 - 6) = 27.21\text{dBm}$ .

#### 802.11ac (VHT40)

TX chain	Channel	Freq. (MHz)	PSD (dBm/300kHz)	PSD (dBm/500kHz)	10 log (N=2) dB	Total PSD (dBm/500k Hz)	Limit (dBm/500k Hz)	Pass /Fail
0	142 (UNII-3 Band)	5710	-4.48	-2.26	3.01	0.75	27.21	Pass
1	142 (UNII-3 Band)	5710	-6.29	-4.07	3.01	-1.06	27.21	Pass

Note: 1. Directional gain =  $10 \log[(10^{G1/20} + 10^{G2/20})^2 / 2] = 8.79\text{dBi} > 6\text{dBi}$ , so the power density limit shall be reduced to  $30 - (8.79 - 6) = 27.21\text{dBm}$ .

#### 802.11ac (VHT80)

TX chain	Chan.	Chan. Freq. (MHz)	PSD W/O Duty Factor		10 log (N=2) dB	Duty Factor (dB)	Total PSD With Duty Factor (dBm/500kHz)	Limit (dBm/500kHz)	Pass /Fail
			(dBm/300kHz)	(dBm/500kHz)					
0	138 (UNII-3 Band)	5690	-11.64	-9.42	3.01	0.18	-6.23	27.21	Pass
1	138 (UNII-3 Band)	5690	-13.25	-11.03	3.01	0.18	-7.84	27.21	Pass

Note: 1. Directional gain =  $10 \log[(10^{G1/20} + 10^{G2/20})^2 / 2] = 8.79\text{dBi} > 6\text{dBi}$ , so the power density limit shall be reduced to  $30 - (8.79 - 6) = 27.21\text{dBm}$ .

2. Refer to section 3.3 for duty cycle spectrum plot.

### Spectrum Plot of Worst Value

#### 802.11a\_Chain 0 / CH144 (UNII-3 Band)

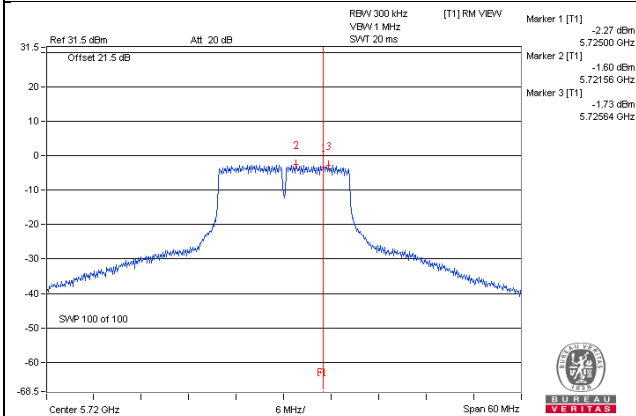

#### 802.11ac (VHT20)\_Chain 0 / CH144 (UNII-3 Band)

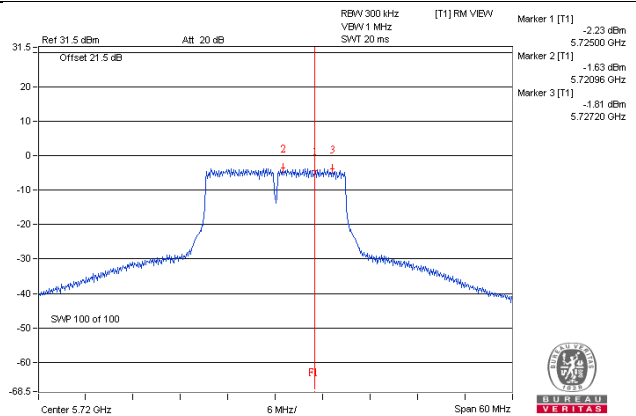

#### 802.11ac (VHT40)\_Chain 0 / CH142 (UNII-3 Band)

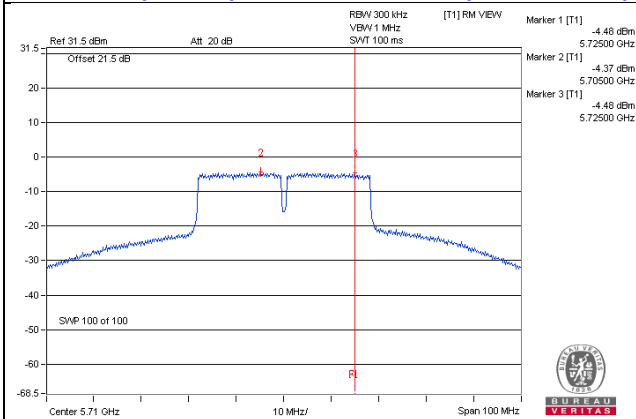

#### 802.11ac (VHT80)\_Chain 0 / CH138 (UNII-3 Band)

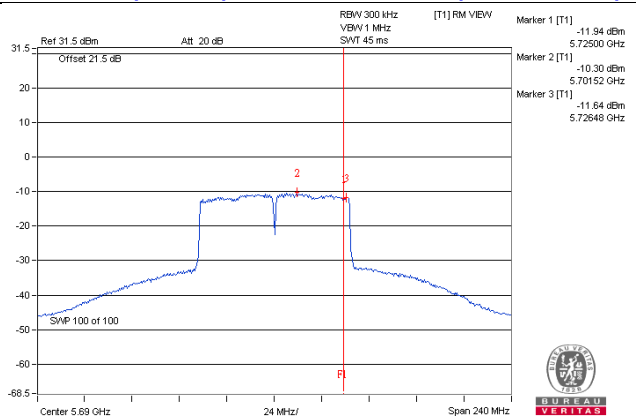

## 4.6 Frequency Stability Measurement

### 4.6.1 Limits of Frequency Stability Measurement

The frequency of the carrier signal shall be maintained within band of operation

### 4.6.2 Test Setup

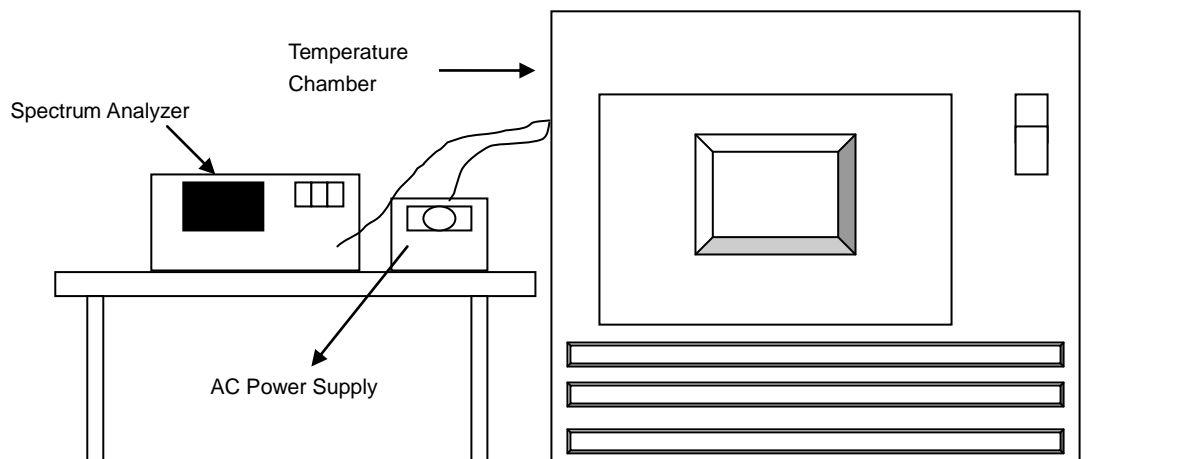

### 4.6.3 Test Instruments

Refer to section 4.1.2 to get information of above instrument.

### 4.6.4 Test Procedure

- The EUT was placed inside the environmental test chamber and powered by nominal AC voltage.
- Turn the EUT on and couple its output to a spectrum analyzer.
- Turn the EUT off and set the chamber to the highest temperature specified.
- Allow sufficient time (approximately 30 min) for the temperature of the chamber to stabilize, turn the EUT on and measure the operating frequency after 2, 5, and 10 Minutes.
- Repeat step 2 and 3 with the temperature chamber set to the lowest temperature.
- The test chamber was allowed to stabilize at +20 degree C for a minimum of 30 Minutes. The supply voltage was then adjusted on the EUT from 85% to 115% and the frequency record.

### 4.6.5 Deviation from Test Standard

No deviation.

### 4.6.6 EUT Operating Condition

Set the EUT transmit at un-modulation mode to test frequency stability.

## 4.6.7 Test Results

Frequency Stability Versus Temp.									
Operating Frequency: 5260 MHz									
TEMP. (°C)	Power Supply (Vac)	0 Minute		2 Minute		5 Minute		10 Minute	
		Measured Frequency (MHz)	Pass/Fail	Measured Frequency (MHz)	Pass/Fail	Measured Frequency (MHz)	Pass/Fail	Measured Frequency (MHz)	Pass/Fail
50	120	5259.987	Pass	5259.9899	Pass	5259.9889	Pass	5259.9879	Pass
40	120	5259.9869	Pass	5259.9844	Pass	5259.9838	Pass	5259.9839	Pass
30	120	5259.9839	Pass	5259.9851	Pass	5259.9861	Pass	5259.9856	Pass
20	120	5260.0082	Pass	5260.0049	Pass	5260.0073	Pass	5260.009	Pass
10	120	5259.9935	Pass	5259.9949	Pass	5259.9961	Pass	5259.9959	Pass
0	120	5260.0074	Pass	5260.0101	Pass	5260.0115	Pass	5260.0096	Pass
-10	120	5259.9877	Pass	5259.9899	Pass	5259.9902	Pass	5259.9906	Pass
-20	120	5259.9814	Pass	5259.9828	Pass	5259.9851	Pass	5259.9819	Pass
-30	120	5260.0116	Pass	5260.0092	Pass	5260.0111	Pass	5260.009	Pass

Frequency Stability Versus Voltage									
Operating Frequency: 5260 MHz									
TEMP. (°C)	Power Supply (Vac)	0 Minute		2 Minute		5 Minute		10 Minute	
		Measured Frequency (MHz)	Pass/Fail	Measured Frequency (MHz)	Pass/Fail	Measured Frequency (MHz)	Pass/Fail	Measured Frequency (MHz)	Pass/Fail
20	138	5260.0076	Pass	5260.004	Pass	5260.0076	Pass	5260.0083	Pass
	120	5260.0082	Pass	5260.0049	Pass	5260.0073	Pass	5260.009	Pass
	102	5260.0091	Pass	5260.0044	Pass	5260.0065	Pass	5260.0085	Pass

## 4.7 6dB Bandwidth Measurement

### 4.7.1 Limits of 6dB Bandwidth Measurement

The minimum of 6dB Bandwidth Measurement is 0.5MHz.

### 4.7.2 Test Setup

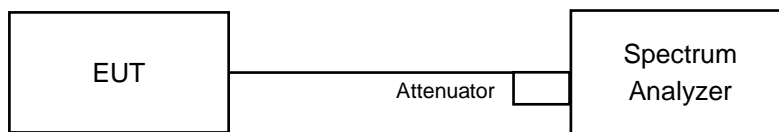

### 4.7.3 Test Instruments

Refer to section 4.1.2 to get information of above instrument.

### 4.7.4 Test Procedure

#### MEASUREMENT PROCEDURE REF

- Set resolution bandwidth (RBW) = 100kHz
- Set the video bandwidth (VBW)  $\geq 3 \times$  RBW, Detector = Peak.
- Trace mode = max hold.
- Sweep = auto couple.
- Measure the maximum width of the emission that is constrained by the frequencies associated with the two amplitude points (upper and lower) that are attenuated by 6 dB relative to the maximum level measured in the fundamental emission

### 4.7.5 Deviation from Test Standard

No deviation.

### 4.7.6 EUT Operating Condition

The software provided by client to enable the EUT under transmission condition continuously at lowest, middle and highest channel frequencies individually.

#### 4.7.7 Test Results

##### 802.11a

Channel	Frequency (MHz)	6dB Bandwidth (MHz)		Minimum Limit (MHz)	Pass / Fail
		Chain 0	Chain 1		
144 (UNII-3 Band)	5720	3.17	3.18	0.5	PASS

Note: The 6dB bandwidth above 5725MHz = Marker 1 + Delta 2 - 5725MHz

##### 802.11ac (VHT20)

Channel	Frequency (MHz)	6dB Bandwidth (MHz)		Minimum Limit (MHz)	Pass / Fail
		Chain 0	Chain 1		
144 (UNII-3 Band)	5720	3.82	3.81	0.5	PASS

Note: The 6dB bandwidth above 5725MHz = Marker 1 + Delta 2 - 5725MHz

##### 802.11ac (VHT40)

Channel	Frequency (MHz)	6dB Bandwidth (MHz)		Minimum Limit (MHz)	Pass / Fail
		Chain 0	Chain 1		
142 (UNII-3 Band)	5710	3.22	3.24	0.5	PASS

Note: The 6dB bandwidth above 5725MHz = Marker 1 + Delta 2 - 5725MHz

##### 802.11ac (VHT80)

Channel	Frequency (MHz)	6dB Bandwidth (MHz)		Minimum Limit (MHz)	Pass / Fail
		Chain 0	Chain 1		
138 (UNII-3 Band)	5690	3.06	3.20	0.5	PASS

Note: The 6dB bandwidth above 5725MHz = Marker 1 + Delta 2 - 5725MHz



Spectrum Plot of Worst Value

802.11a\_Chain 0 / CH144 (UNII-3 Band)

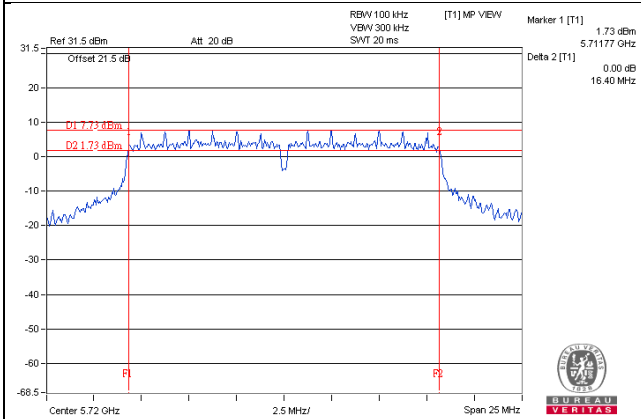

802.11ac (VHT20)\_Chain 1 / CH144 (UNII-3 Band)

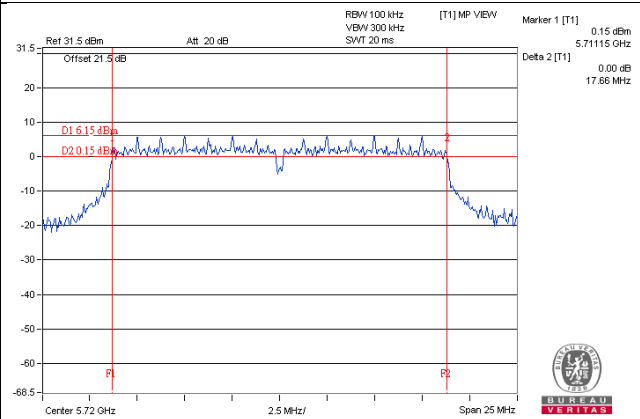

802.11ac (VHT40)\_Chain 0 / CH142 (UNII-3 Band)

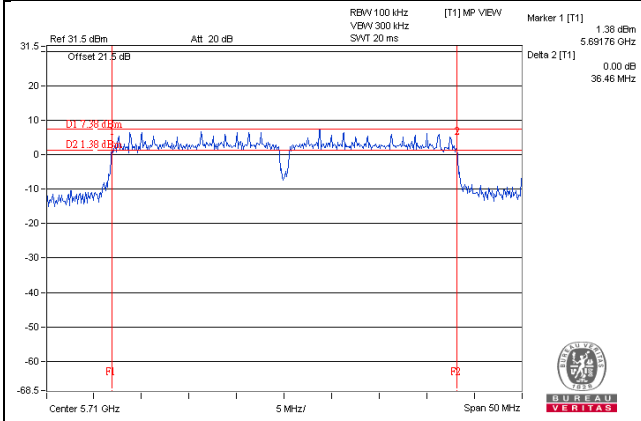

802.11ac (VHT80)\_Chain 0 / CH138 (UNII-3 Band)

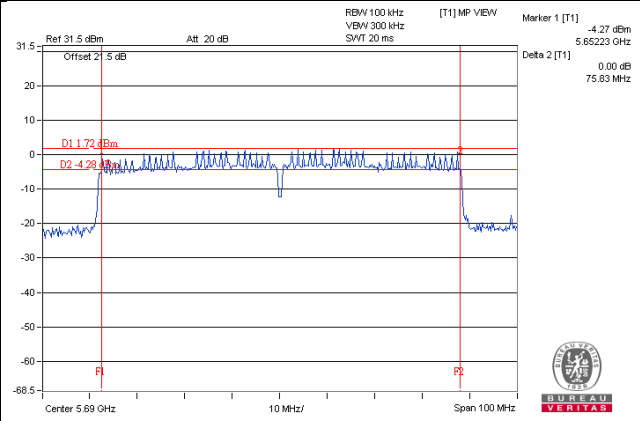

## 5 Pictures of Test Arrangements

Please refer to the attached file (Test Setup Photo).

## Appendix – Information on the Testing Laboratories

We, Bureau Veritas Consumer Products Services (H.K.) Ltd., Taoyuan Branch, were founded in 1988 to provide our best service in EMC, Radio, Telecom and Safety consultation. Our laboratories are accredited and approved according to ISO/IEC 17025.

If you have any comments, please feel free to contact us at the following:

**Linko EMC/RF Lab**

Tel: 886-2-26052180

Fax: 886-2-26051924

**Hsin Chu EMC/RF/Telecom Lab**

Tel: 886-3-6668565

Fax: 886-3-6668323

**Hwa Ya EMC/RF/Safety Lab**

Tel: 886-3-3183232

Fax: 886-3-3270892

**Email:** [service.adt@tw.bureauveritas.com](mailto:service.adt@tw.bureauveritas.com)

**Web Site:** [www.bureauveritas-adt.com](http://www.bureauveritas-adt.com)

The address and road map of all our labs can be found in our web site also.

--- END ---