



A D T

FCC TEST REPORT (15.247)

REPORT NO.: RF140415C27

MODEL NO.: PCE4552AH

FCC ID: QXO-57G45

RECEIVED: Mar. 07, 2014

TESTED: Apr. 09 ~ May 30, 2014

ISSUED: Jun. 05, 2014

APPLICANT: Extreme Networks, Inc.

ADDRESS: 9 Northeastern Blvd. Salem, New Hampshire,
United States, 03079

ISSUED BY: Bureau Veritas Consumer Products Services
(H.K.) Ltd., Taoyuan Branch

LAB ADDRESS: No. 47, 14th Ling, Chia Pau Vil., Lin Kou Dist.,
New Taipei City, Taiwan, R.O.C.

TEST LOCATION: No. 19, Hwa Ya 2nd Rd, Wen Hwa Tsuen, Kwei
Shan Hsiang, Taoyuan Hsien 333, Taiwan, R.O.C.

This report should not be used by the client to claim product certification, approval, or endorsement by TAF or any government agencies.



This report is for your exclusive use. Any copying or replication of this report to or for any other person or entity, or use of our name or trademark, is permitted only with our prior written permission. This report sets forth our findings solely with respect to the test samples identified herein. The results set forth in this report are not indicative or representative of the quality or characteristics of the lot from which a test sample was taken or any similar or identical product unless specifically and expressly noted. Our report includes all of the tests requested by you and the results thereof based upon the information that you provided to us. You have 60 days from date of issuance of this report to notify us of any material error or omission caused by our negligence, provided, however, that such notice shall be in writing and shall specifically address the issue you wish to raise. A failure to raise such issue within the prescribed time shall constitute your unqualified acceptance of the completeness of this report, the tests conducted and the correctness of the report contents. Unless specific mention, the uncertainty of measurement has been explicitly taken into account to declare the compliance or non-compliance to the specification.



TABLE OF CONTENTS

RELEASE CONTROL RECORD	4
1. CERTIFICATION	5
2. SUMMARY OF TEST RESULTS	6
2.1 MEASUREMENT UNCERTAINTY	6
3. GENERAL INFORMATION	7
3.1 GENERAL DESCRIPTION OF EUT	7
3.2 DESCRIPTION OF TEST MODES	8
3.2.1 TEST MODE APPLICABILITY AND TESTED CHANNEL DETAIL	9
3.3 DUTY CYCLE OF TEST SIGNAL	12
3.4 DESCRIPTION OF SUPPORT UNITS	19
3.4.1 CONFIGURATION OF SYSTEM UNDER TEST	20
3.5 GENERAL DESCRIPTION OF APPLIED STANDARDS	22
4. TEST TYPES AND RESULTS (FOR 5.0GHz BAND)	23
4.1 RADIATED EMISSION MEASUREMENT	23
4.1.1 LIMITS OF RADIATED EMISSION MEASUREMENT	23
4.1.2 TEST INSTRUMENTS	24
4.1.3 TEST PROCEDURES	25
4.1.4 DEVIATION FROM TEST STANDARD	25
4.1.5 TEST SETUP	26
4.1.6 EUT OPERATING CONDITIONS	27
4.1.7 TEST RESULTS	28
4.2 CONDUCTED EMISSION MEASUREMENT	98
4.2.1 LIMITS OF CONDUCTED EMISSION MEASUREMENT	98
4.2.2 TEST INSTRUMENTS	98
4.2.3 TEST PROCEDURES	99
4.2.4 DEVIATION FROM TEST STANDARD	99
4.2.5 TEST SETUP	99
4.2.6 EUT OPERATING CONDITIONS	99
4.2.7 TEST RESULTS	100
4.3 6dB BANDWIDTH MEASUREMENT	114
4.3.1 LIMITS OF 6dB BANDWIDTH MEASUREMENT	114
4.3.2 TEST SETUP	114
4.3.3 TEST INSTRUMENTS	114
4.3.4 TEST PROCEDURE	114
4.3.5 DEVIATION FROM TEST STANDARD	114
4.3.6 EUT OPERATING CONDITIONS	114
4.3.7 TEST RESULTS	115
4.4 CONDUCTED OUTPUT POWER	129
4.4.1 LIMITS OF CONDUCTED OUTPUT POWER MEASUREMENT	129
4.4.2 TEST SETUP	129
4.4.3 INSTRUMENTS	129
4.4.4 TEST PROCEDURES	130
4.4.5 DEVIATION FROM TEST STANDARD	130
4.4.6 EUT OPERATING CONDITIONS	130
4.4.7 TEST RESULTS	131
4.5 POWER SPECTRAL DENSITY MEASUREMENT	138
4.5.1 LIMITS OF POWER SPECTRAL DENSITY MEASUREMENT	138
4.5.2 TEST SETUP	138
4.5.3 TEST INSTRUMENTS	138
4.5.4 TEST PROCEDURE	138



A D T

4.5.5	DEVIATION FROM TEST STANDARD.....	138
4.5.6	EUT OPERATING CONDITION.....	138
4.5.7	TEST RESULTS	139
4.6	CONDUCTED OUT OF BAND EMISSION MEASUREMENT	159
4.6.1	LIMITS OF CONDUCTED OUT OF BAND EMISSION MEASUREMENT ...	159
4.6.2	TEST SETUP.....	159
4.6.3	TEST INSTRUMENTS.....	159
4.6.4	TEST PROCEDURE.....	159
4.6.5	DEVIATION FROM TEST STANDARD.....	160
4.6.6	EUT OPERATING CONDITION.....	160
4.6.7	TEST RESULTS	160
5.	PHOTOGRAPHS OF THE TEST CONFIGURATION.....	241
6.	INFORMATION ON THE TESTING LABORATORIES	242
7.	APPENDIX A – MODIFICATIONS RECORDERS FOR ENGINEERING CHANGES TO THE EUT BY THE LAB.....	243



A D T

RELEASE CONTROL RECORD

ISSUE NO.	REASON FOR CHANGE	DATE ISSUED
RF140415C27	Original release	Jun. 05, 2014





A D T

1. CERTIFICATION

PRODUCT: DBDC 3X3 AP
MODEL NO.: PCE4552AH
BRAND: Extreme
APPLICANT: Extreme Networks, Inc.
TESTED: Apr. 09 ~ May 30, 2014
TEST SAMPLE: ENGINEERING SAMPLE
STANDARDS: **FCC Part 15, Subpart C (Section 15.247)**
ANSI C63.10-2009

The above equipment (model: PCE4552AH) has been tested by **Bureau Veritas Consumer Products Services (H.K.) Ltd., Taoyuan Branch**, and found compliance with the requirement of the above standards. The test record, data evaluation & Equipment Under Test (EUT) configurations represented herein are true and accurate accounts of the measurements of the sample's EMC characteristics under the conditions specified in this report.

PREPARED BY :  , **DATE :** Jun. 05, 2014
Pettie Chen / Senior Specialist

APPROVED BY :  , **DATE :** Jun. 05, 2014
Ken Liu / Senior Manager



2. SUMMARY OF TEST RESULTS

The EUT has been tested according to the following specifications:

APPLIED STANDARD: FCC PART 15, SUBPART C (SECTION 15.247)			
STANDARD SECTION	TEST TYPE	RESULT	REMARK
15.207	AC Power Conducted Emission	PASS	Meet the requirement of limit. Minimum passing margin is -26.86dB at 21.85156MHz.
15.205 & 209	Radiated Emissions	PASS	Meet the requirement of limit. Minimum passing margin is -1.0dB at 5383.00, 5439.00, 11650.00MHz.
15.247(d)	Band Edge Measurement	PASS	Meet the requirement of limit. Minimum passing margin is -1.7dB at 5850.00MHz.
15.247(d)	Antenna Port Emission	PASS	Meet the requirement of limit.
15.247(a)(2)	6dB bandwidth	PASS	Meet the requirement of limit.
15.247(b)	Conducted power	PASS	Meet the requirement of limit.
15.247(e)	Power Spectral Density	PASS	Meet the requirement of limit.
15.203	Antenna Requirement	PASS	Antenna connector is N-Type. (The device is professionally installed)

2.1 MEASUREMENT UNCERTAINTY

Where relevant, the following measurement uncertainty levels have been estimated for tests performed on the EUT as specified in CISPR 16-4-2:

MEASUREMENT	FREQUENCY	UNCERTAINTY
Conducted emissions	150kHz~30MHz	2.44 dB
Radiated emissions	30MHz ~ 200MHz	3.34 dB
	200MHz ~1000MHz	3.35 dB
	1GHz ~ 18GHz	2.26 dB
	18GHz ~ 40GHz	1.94 dB

This uncertainty represents an expanded uncertainty expressed at approximately the 95% confidence level using a coverage factor of $k = 2$.



3. GENERAL INFORMATION

3.1 GENERAL DESCRIPTION OF EUT

EUT	DBDC 3X3 AP
MODEL NO.	PCE4552AH
POWER SUPPLY	4.2Vdc (DC)
MODULATION TYPE	64QAM, 16QAM, QPSK, BPSK for OFDM 256QAM for OFDM in 11ac mode only
MODULATION TECHNOLOGY	OFDM
TRANSFER RATE	802.11a: 54.0/ 48.0/ 36.0/ 24.0/ 18.0/ 12.0/ 9.0/ 6.0Mbps 802.11n: up to 450.0Mbps 802.11ac: up to 1300.0Mbps
OPERATING FREQUENCY	5745 ~ 5825MHz
NUMBER OF CHANNEL	802.11a, 802.11n (20MHz), 802.11ac (20MHz): 5 802.11n (40MHz), 802.11ac (40MHz): 2 802.11ac (80MHz): 1
OUTPUT POWER	Ant 1: 990.182mW Ant 2: 83.198mW Ant 3: 272.678mW Ant 4: 628.878mW Ant 5: 553.649mW Ant 6: 793.377mW Ant 7: 635.912mW
ANTENNA TYPE	Refer to NOTE
ANTENNA CONNECTOR	Refer to NOTE
DATA CABLE	NA
I/O PORTS	Refer to user's manual
ACCESSORY DEVICES	NA

NOTE:

1. The EUT incorporates a MIMO function. Physically, the EUT provides three completed transmitters and three receivers.

MODULATION MODE	TX FUNCTION (Ant. 1, 3, 4, 5, 6, 7)	TX FUNCTION (Ant. 2)
802.11a	3TX	2TX
802.11n (20MHz)	3TX	2TX
802.11n (40MHz)	3TX	2TX
802.11ac (20MHz)	3TX	2TX
802.11ac (40MHz)	3TX	2TX
802.11ac (80MHz)	3TX	2TX

* The modulation and bandwidth are similar for 802.11n mode for 20MHz / 40MHz and 802.11ac mode for 20MHz / 40MHz, therefore investigated worst case to representative mode in test report. (Final test mode refer section 3.2.1)



2. There are 7 antennas for the EUT.

Item	Model Name	Ant Type	Ant Connector	Gain(dBi)
1	WS-AO-DT05120N	Sector	N-Type	5
2	WS-AO-5D23009N	Panel	N-Type	23
3	WS-AO-DX13025N	Panel	N-Type	11.5
4	WS-AO-DX10055N	Panel	N-Type	8
5	Omni Stubby	Dipole	N-Type	2
6	Senao dipole 5G	Dipole	N-Type	7
7	SuperPass SP-G2HJ2H-6L	Sector	N-Type	7.2

3. The above EUT information is declared by manufacturer and for more detailed features description, please refer to the manufacturer's specifications or user's manual.

3.2 DESCRIPTION OF TEST MODES

FOR 5.0GHz (5745 ~ 5825MHz):

5 channels are provided for 802.11a, 802.11n (20MHz), 802.11ac (20MHz):

CHANNEL	FREQUENCY	CHANNEL	FREQUENCY
149	5745MHz	161	5805MHz
153	5765MHz	165	5825MHz
157	5785MHz		

2 channels are provided for 802.11n (40MHz), 802.11ac (40MHz):

CHANNEL	FREQUENCY	CHANNEL	FREQUENCY
151	5755MHz	159	5795MHz

1 channel is provided for 802.11ac (80MHz):

CHANNEL	FREQUENCY
155	5775MHz



3.2.1 TEST MODE APPLICABILITY AND TESTED CHANNEL DETAIL

FOR 5.0GHz (5745 ~ 5825MHz):

EUT CONFIGURE MODE	APPLICABLE TO				DESCRIPTION
	RE≥1G	RE<1G	PLC	APCM	
A	√	√	√	√	EUT with Antenna 1
B	√	√	√	√	EUT with Antenna 2
C	√	√	√	√	EUT with Antenna 3
D	√	√	√	√	EUT with Antenna 4
E	√	√	√	√	EUT with Antenna 5
F	√	√	√	√	EUT with Antenna 6
G	√	√	√	√	EUT with Antenna 7

Where **RE≥1G**: Radiated Emission above 1GHz **RE<1G**: Radiated Emission below 1GHz
PLC: Power Line Conducted Emission **APCM**: Antenna Port Conducted Measurement

NOTE: For test mode G, the antenna of EUT had been pre-tested on the positioned of Y axis and Z axis. The worst case was found when positioned on **Y-plane**.

RADIATED EMISSION TEST (ABOVE 1GHz):

- Pre-Scan has been conducted to determine the worst-case mode from all possible combinations between available modulations, data rates and antenna ports (if EUT with antenna diversity architecture).
- Following channel(s) was (were) selected for the final test as listed below.

EUT CONFIGURE MODE	MODE	AVAILABLE CHANNEL	TESTED CHANNEL	MODULATION TECHNOLOGY	MODULATION TYPE	DATA RATE (Mbps)
A, B, C, D, E, F, G	802.11a	149 to 165	149, 157, 165	OFDM	BPSK	6.0
A, B, C, D, E, F, G	802.11n (20MHz)	149 to 165	149, 157, 165	OFDM	BPSK	7.2
A, B, C, D, E, F, G	802.11n (40MHz)	151 to 159	151, 159	OFDM	BPSK	15.0
A, C, D, E, F, G	802.11ac (80MHz)	155	155	OFDM	BPSK	97.5
B	802.11ac (80MHz)	155	155	OFDM	BPSK	65.0



RADIATED EMISSION TEST (BELOW 1GHz):

- Pre-Scan has been conducted to determine the worst-case mode from all possible combinations between available modulations, data rates and antenna ports (if EUT with antenna diversity architecture).
- Following channel(s) was (were) selected for the final test as listed below.

EUT CONFIGURE MODE	MODE	AVAILABLE CHANNEL	TESTED CHANNEL	MODULATION TECHNOLOGY	MODULATION TYPE	DATA RATE (Mbps)
A	802.11a	149 to 165	157	OFDM	BPSK	6.0
B	802.11ac (80MHz)	155	155	OFDM	BPSK	65.0
C	802.11n (40MHz)	151 to 159	151	OFDM	BPSK	15.0
D	802.11n (20MHz)	149 to 165	165	OFDM	BPSK	7.2
E	802.11n (40MHz)	151 to 159	159	OFDM	BPSK	15.0
F	802.11n (20MHz)	149 to 165	165	OFDM	BPSK	7.2
G	802.11n (20MHz)	149 to 165	149	OFDM	BPSK	7.2

POWER LINE CONDUCTED EMISSION TEST:

- Pre-Scan has been conducted to determine the worst-case mode from all possible combinations between available modulations, data rates and antenna ports (if EUT with antenna diversity architecture).
- Following channel(s) was (were) selected for the final test as listed below.

EUT CONFIGURE MODE	MODE	AVAILABLE CHANNEL	TESTED CHANNEL	MODULATION TECHNOLOGY	MODULATION TYPE	DATA RATE (Mbps)
A	802.11a	149 to 165	157	OFDM	BPSK	6.0
B	802.11ac (80MHz)	155	155	OFDM	BPSK	65.0
C	802.11n (40MHz)	151 to 159	151	OFDM	BPSK	15.0
D	802.11n (20MHz)	149 to 165	165	OFDM	BPSK	7.2
E	802.11n (40MHz)	151 to 159	159	OFDM	BPSK	15.0
F	802.11n (20MHz)	149 to 165	165	OFDM	BPSK	7.2
G	802.11n (20MHz)	149 to 165	149	OFDM	BPSK	7.2

BANDEDGE MEASUREMENT:

- Pre-Scan has been conducted to determine the worst-case mode from all possible combinations between available modulations, data rates and antenna ports (if EUT with antenna diversity architecture).
- Following channel(s) was (were) selected for the final test as listed below.

EUT CONFIGURE MODE	MODE	AVAILABLE CHANNEL	TESTED CHANNEL	MODULATION TECHNOLOGY	MODULATION TYPE	DATA RATE (Mbps)
A, B, C, D, E, F, G	802.11a	149 to 165	149, 165	OFDM	BPSK	6.0
A, B, C, D, E, F, G	802.11n (20MHz)	149 to 165	149, 165	OFDM	BPSK	7.2
A, B, C, D, E, F, G	802.11n (40MHz)	151 to 159	151, 159	OFDM	BPSK	15.0
A, C, D, E, F, G	802.11ac (80MHz)	155	155	OFDM	BPSK	97.5
B	802.11ac (80MHz)	155	155	OFDM	BPSK	65.0



A D T

ANTENNA PORT CONDUCTED MEASUREMENT:

- This item includes all test value of each mode, but only includes spectrum plot of worst value of each mode.
- Pre-Scan has been conducted to determine the worst-case mode from all possible combinations between available modulations, data rates and antenna ports (if EUT with antenna diversity architecture).
- Following channel(s) was (were) selected for the final test as listed below.

EUT CONFIGURE MODE	MODE	AVAILABLE CHANNEL	TESTED CHANNEL	MODULATION TECHNOLOGY	MODULATION TYPE	DATA RATE (Mbps)
A, B, C, D, E, F, G	802.11a	149 to 165	149, 157, 165	OFDM	BPSK	6.0
A, B, C, D, E, F, G	802.11n (20MHz)	149 to 165	149, 157, 165	OFDM	BPSK	7.2
A, B, C, D, E, F, G	802.11n (40MHz)	151 to 159	151, 159	OFDM	BPSK	15.0
A, C, D, E, F, G	802.11ac (80MHz)	155	155	OFDM	BPSK	97.5
B	802.11ac (80MHz)	155	155	OFDM	BPSK	65.0

TEST CONDITION:

APPLICABLE TO	ENVIRONMENTAL CONDITIONS	INPUT POWER (SYSTEM)	TESTED BY
RE≥1G	25deg. C, 65%RH	120Vac, 60Hz	Jones Chang Chris Lin Ted Chang
RE<1G	25deg. C, 65%RH	120Vac, 60Hz	Jones Chang Chris Lin
PLC	25deg. C, 68%RH	120Vac, 60Hz	Sun Lin
APCM	25deg. C, 60%RH	120Vac, 60Hz	Nick Chen

3.3 DUTY CYCLE OF TEST SIGNAL

5.0GHz Band:

Mode A

Duty cycle of test signal is < 98 %, duty factor is required

802.11a: Duty cycle = 2.02/2.10 = 0.962, Duty factor = $10 * \log(1/0.962) = 0.17$

802.11n (20MHz): Duty cycle = 1.875/1.96 = 0.957, Duty factor = $10 * \log(1/0.957) = 0.19$

802.11n (40MHz): Duty cycle = 0.92/0.99 = 0.929, Duty factor = $10 * \log(1/0.929) = 0.32$

802.11ac (80MHz): Duty cycle = 0.44/0.515 = 0.854, Duty factor = $10 * \log(1/0.854) = 0.68$

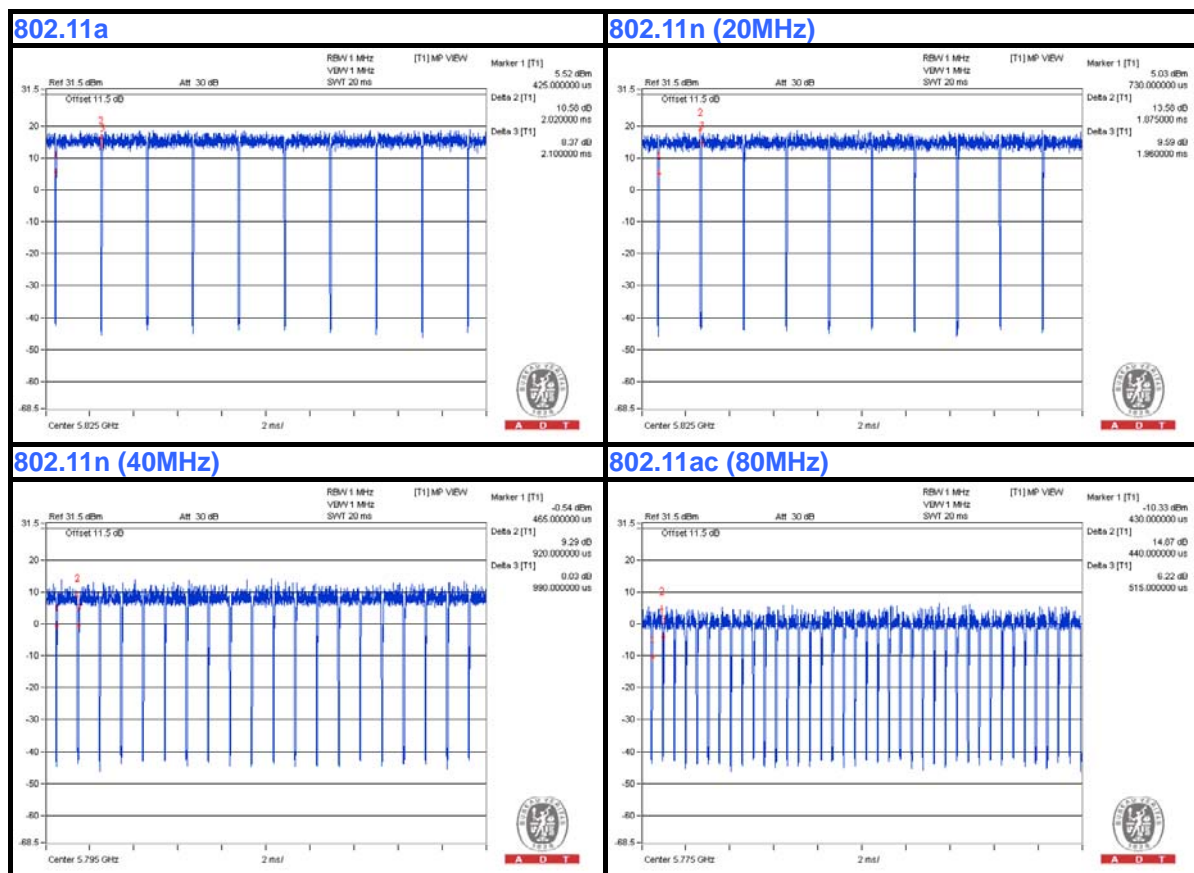



A D T

Mode B

Duty cycle of test signal is < 98 %, duty factor is required

802.11a: Duty cycle = $2.005/2.085 = 0.959$, Duty factor = $10 * \log(1/0.959) = 0.18$

802.11n (20MHz): Duty cycle = $1.88/1.975 = 0.952$, Duty factor = $10 * \log(1/0.952) = 0.21$

802.11n (40MHz): Duty cycle = $0.93/1.0 = 0.93$, Duty factor = $10 * \log(1/0.93) = 0.32$

802.11ac (80MHz): Duty cycle = $0.45/0.52 = 0.865$, Duty factor = $10 * \log(1/0.865) = 0.63$





A D T

Mode C

Duty cycle of test signal is < 98 %, duty factor is required

802.11a: Duty cycle = $2.01/2.095 = 0.959$, Duty factor = $10 * \log(1/0.959) = 0.18$

802.11n (20MHz): Duty cycle = $1.865/1.95 = 0.956$, Duty factor = $10 * \log(1/0.956) = 0.19$

802.11n (40MHz): Duty cycle = $0.915/0.995 = 0.92$, Duty factor = $10 * \log(1/0.92) = 0.36$

802.11ac (80MHz): Duty cycle = $0.455/0.53 = 0.858$, Duty factor = $10 * \log(1/0.858) = 0.66$

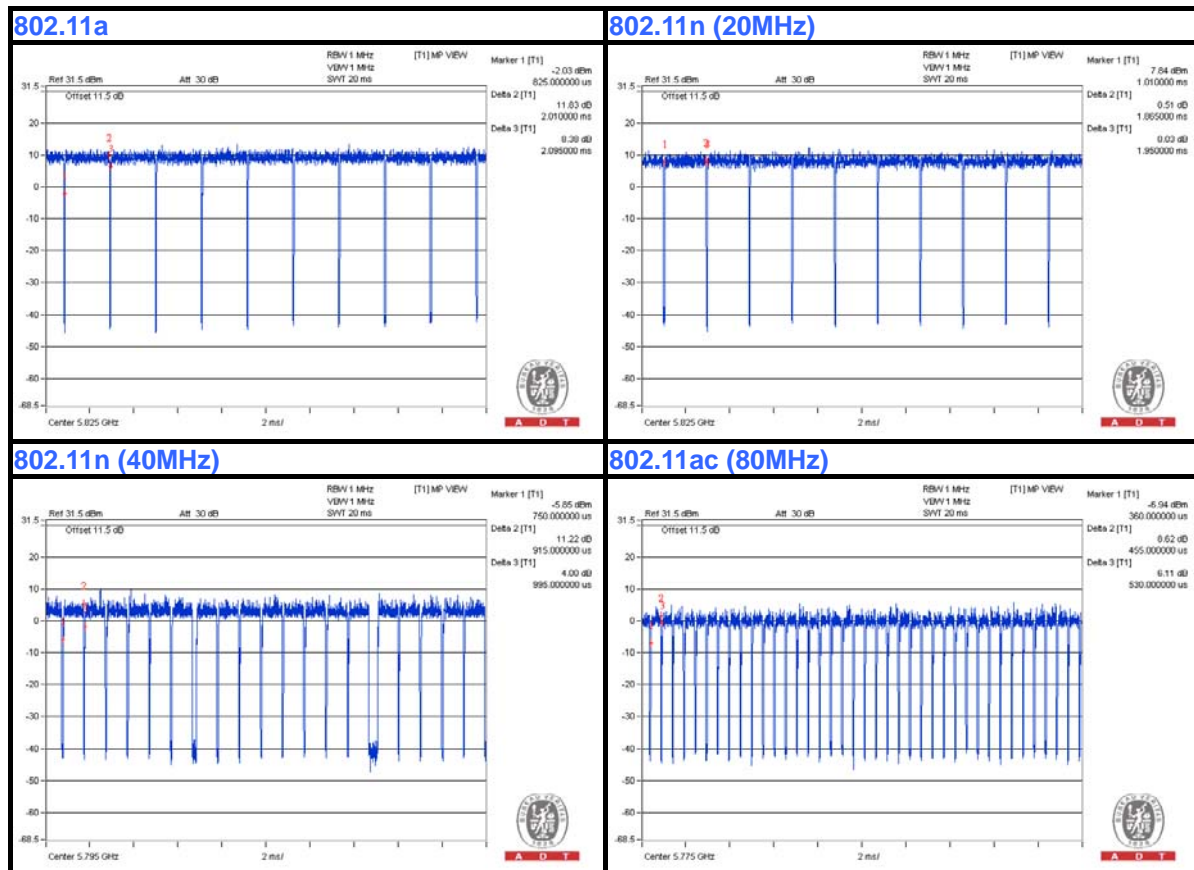



A D T

Mode D

Duty cycle of test signal is < 98 %, duty factor is required

802.11a: Duty cycle = $2.00/2.07 = 0.966$, Duty factor = $10 * \log(1/0.966) = 0.15$

802.11n (20MHz): Duty cycle = $1.88/1.97 = 0.954$, Duty factor = $10 * \log(1/0.954) = 0.20$

802.11n (40MHz): Duty cycle = $0.93/1.01 = 0.921$, Duty factor = $10 * \log(1/0.921) = 0.36$

802.11ac (80MHz): Duty cycle = $0.455/0.52 = 0.875$, Duty factor = $10 * \log(1/0.875) = 0.58$

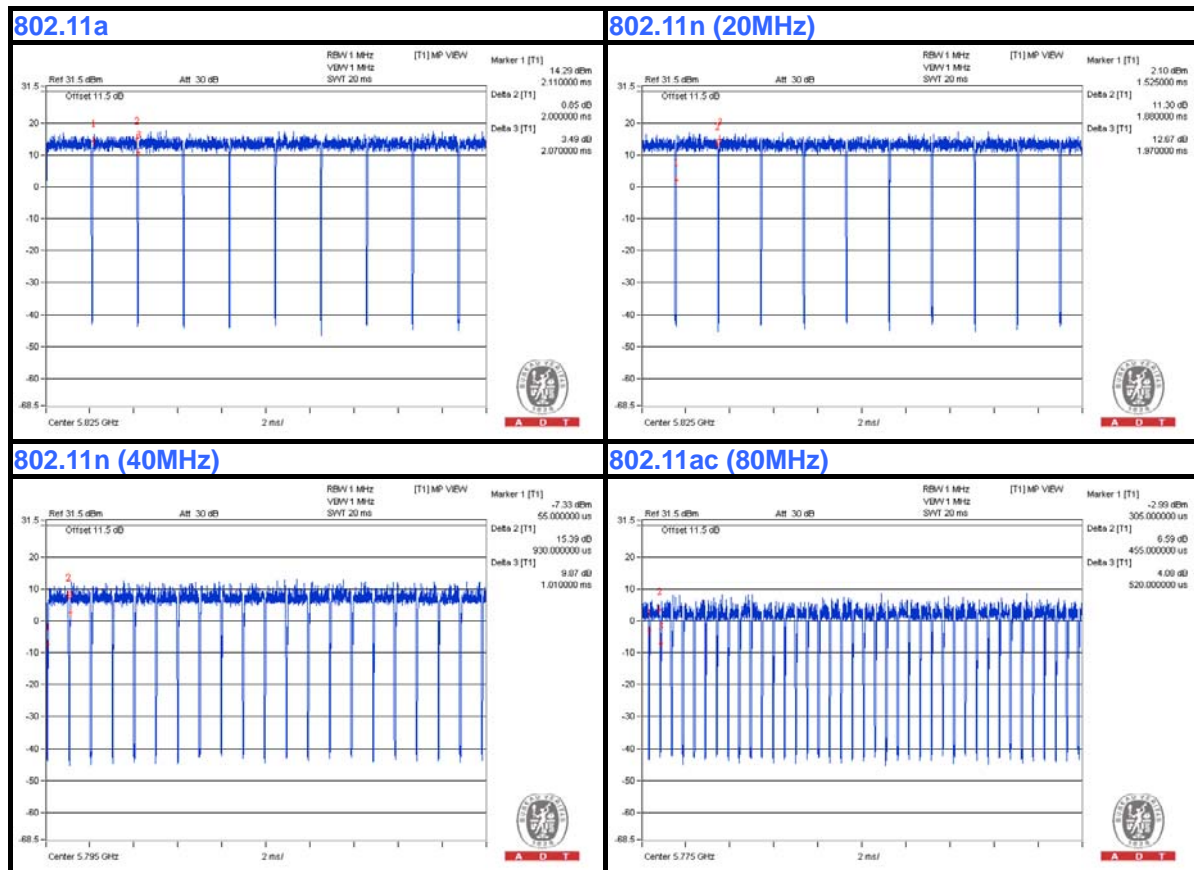



A D T

Mode E

Duty cycle of test signal is < 98 %, duty factor is required

802.11a: Duty cycle = $2.025/2.12 = 0.955$, Duty factor = $10 * \log(1/0.955) = 0.20$

802.11n (20MHz): Duty cycle = $1.88/1.965 = 0.957$, Duty factor = $10 * \log(1/0.957) = 0.19$

802.11n (40MHz): Duty cycle = $0.93/1.00 = 0.93$, Duty factor = $10 * \log(1/0.93) = 0.32$

802.11ac (80MHz): Duty cycle = $0.455/0.525 = 0.867$, Duty factor = $10 * \log(1/0.867) = 0.62$

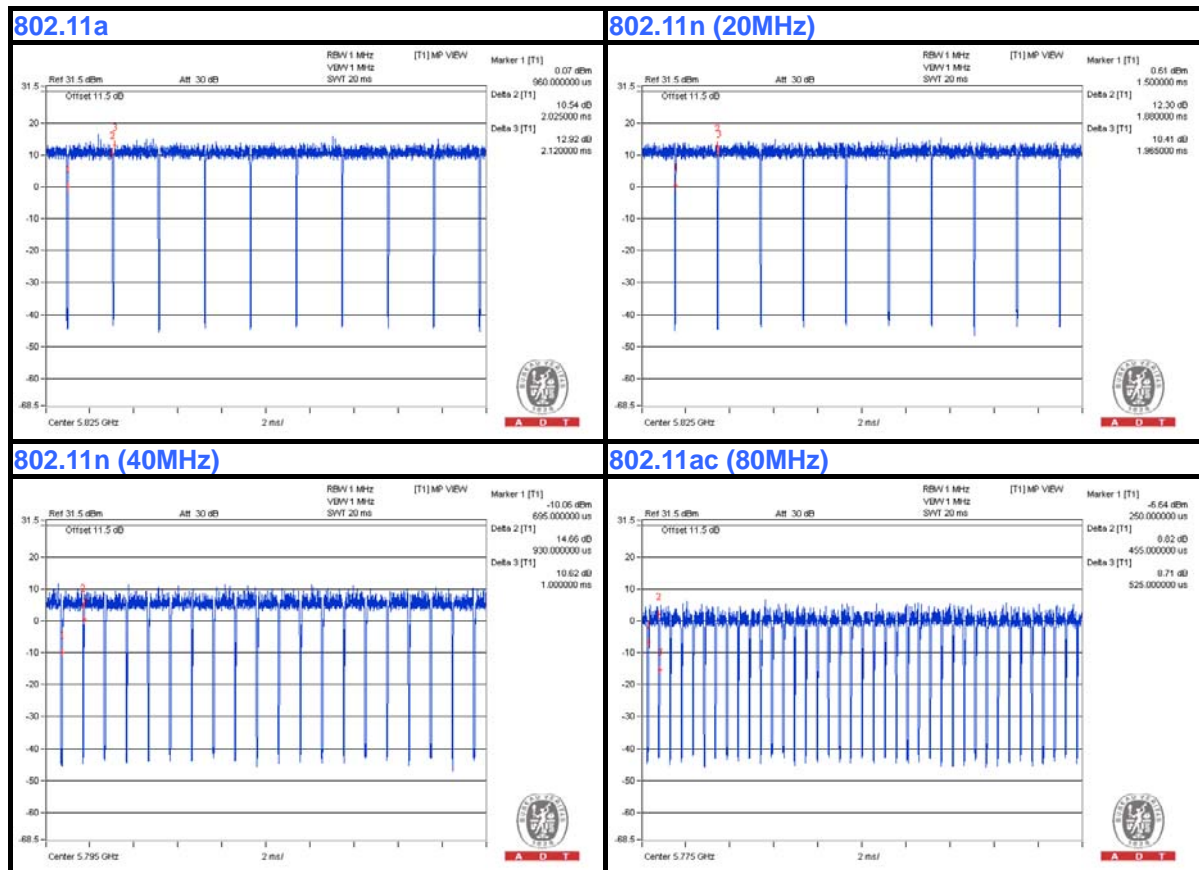



A D T

Mode F

Duty cycle of test signal is < 98 %, duty factor is required

802.11a: Duty cycle = $2.025/2.10 = 0.964$, Duty factor = $10 * \log(1/0.964) = 0.16$

802.11n (20MHz): Duty cycle = $1.875/1.97 = 0.952$, Duty factor = $10 * \log(1/0.952) = 0.21$

802.11n (40MHz): Duty cycle = $0.925/1.01 = 0.916$, Duty factor = $10 * \log(1/0.916) = 0.38$

802.11ac (80MHz): Duty cycle = $0.435/0.52 = 0.837$, Duty factor = $10 * \log(1/0.837) = 0.78$

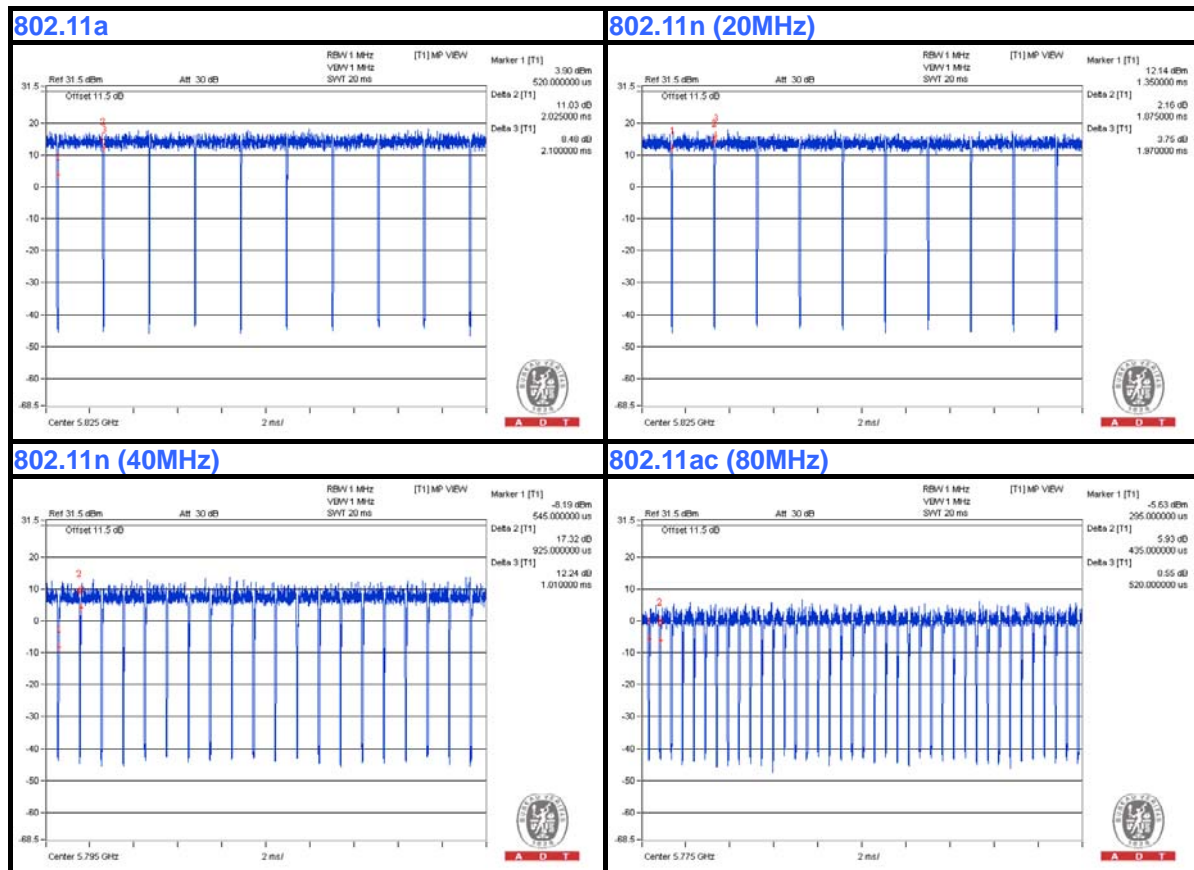



A D T

Mode G

Duty cycle of test signal is < 98 %, duty factor is required

802.11a: Duty cycle = $2.01/2.095 = 0.959$, Duty factor = $10 * \log(1/0.959) = 0.18$

802.11n (20MHz): Duty cycle = $1.88/1.96 = 0.959$, Duty factor = $10 * \log(1/0.959) = 0.18$

802.11n (40MHz): Duty cycle = $0.925/0.995 = 0.93$, Duty factor = $10 * \log(1/0.93) = 0.32$

802.11ac (80MHz): Duty cycle = $0.46/0.52 = 0.885$, Duty factor = $10 * \log(1/0.885) = 0.53$

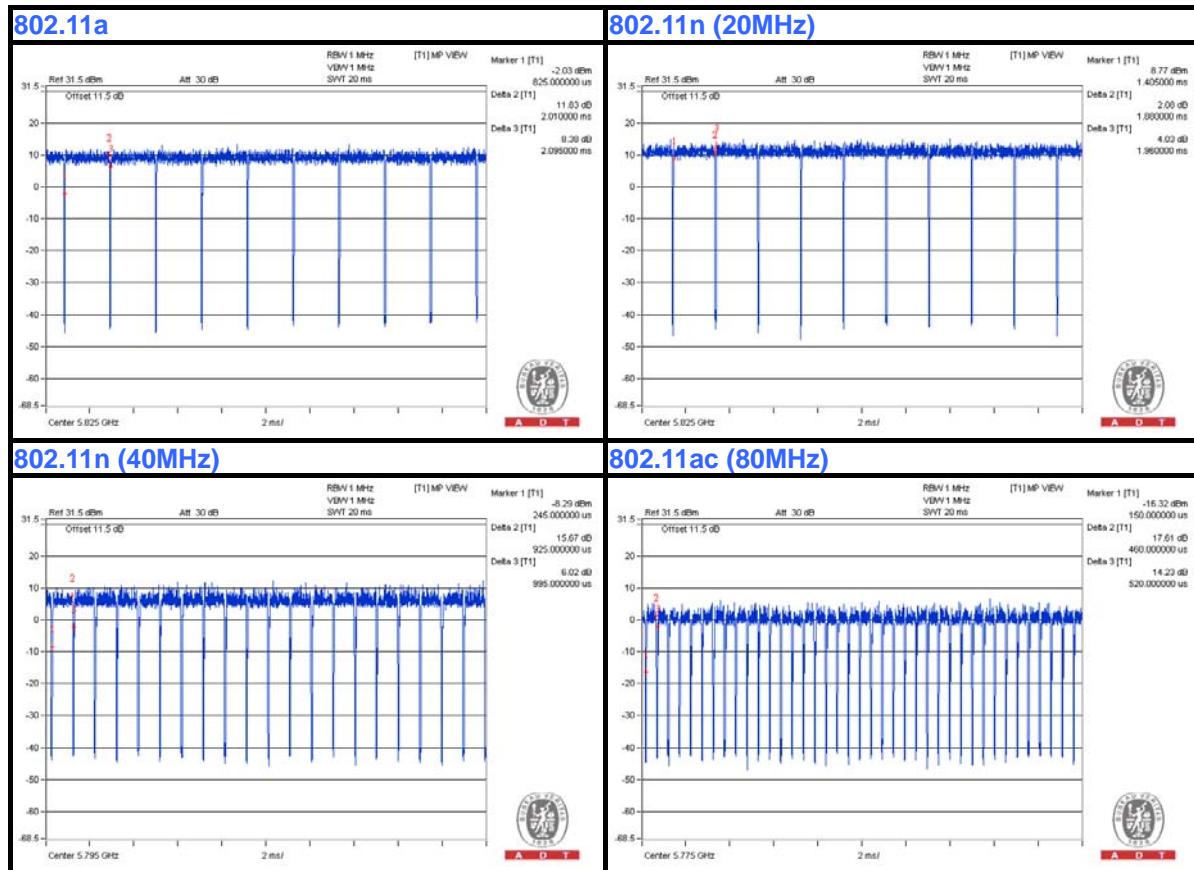



A D T

3.4 DESCRIPTION OF SUPPORT UNITS

The EUT has been tested as an independent unit together with other necessary accessories or support units. The following support units or accessories were used to form a representative test configuration during the tests.

NO.	PRODUCT	BRAND	MODEL NO.	SERIAL NO.	FCC ID
1	Notebook	DELL	D531	CN-0XM006-48643-8 1U-2610	QDS-BRCM1020
2	External Board	NA	NA	NA	NA
3	Power Supply	Topward	6603D	802001	NA

NO.	SIGNAL CABLE DESCRIPTION OF THE ABOVE SUPPORT UNITS
1	NA
2	NA
3	NA

NOTE:

1. All power cords of the above support units are non-shielded (1.8m).
2. Item 2 was provided by client.
3. Item 3 was placed under the test table.

3.4.1 CONFIGURATION OF SYSTEM UNDER TEST

TEST MODE A, G

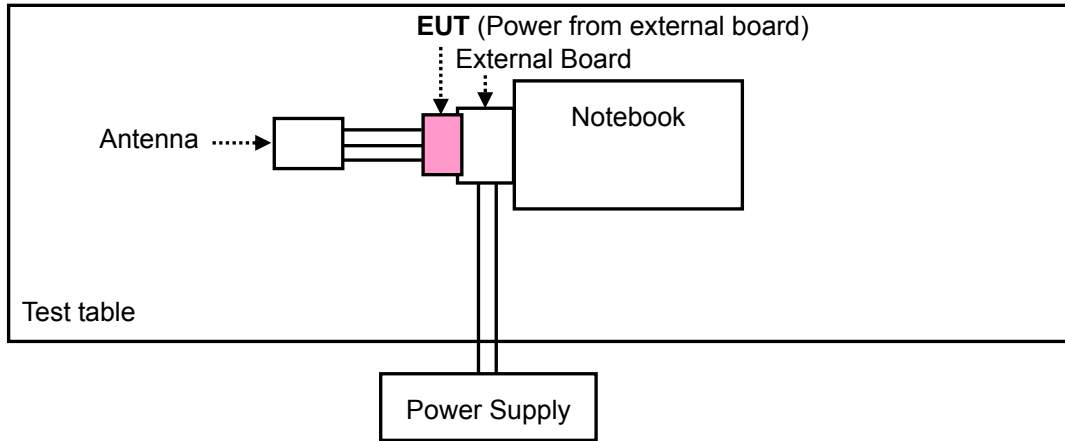

TEST MODE B

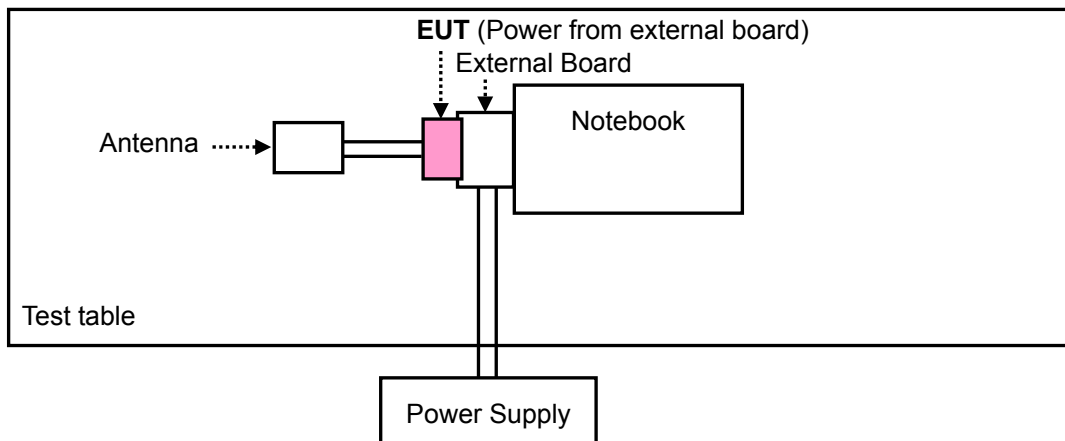

TEST MODE C, D

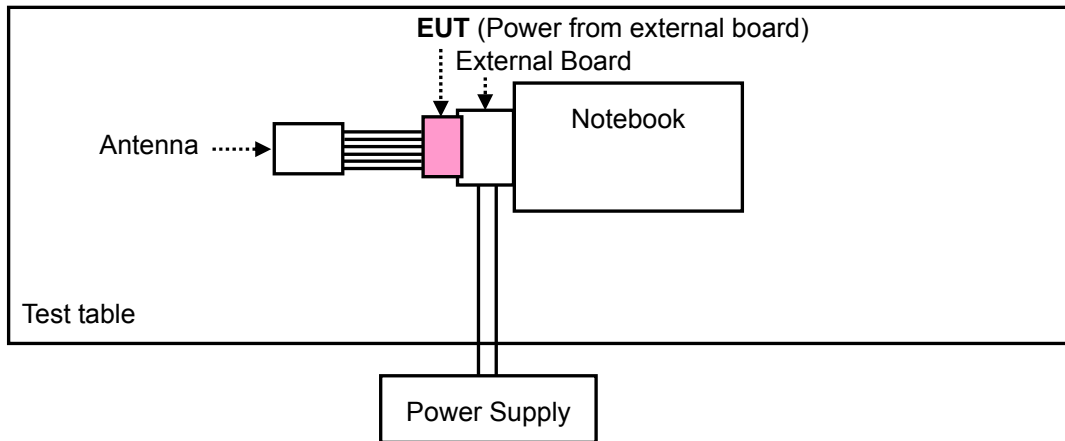

TEST MODE E, F

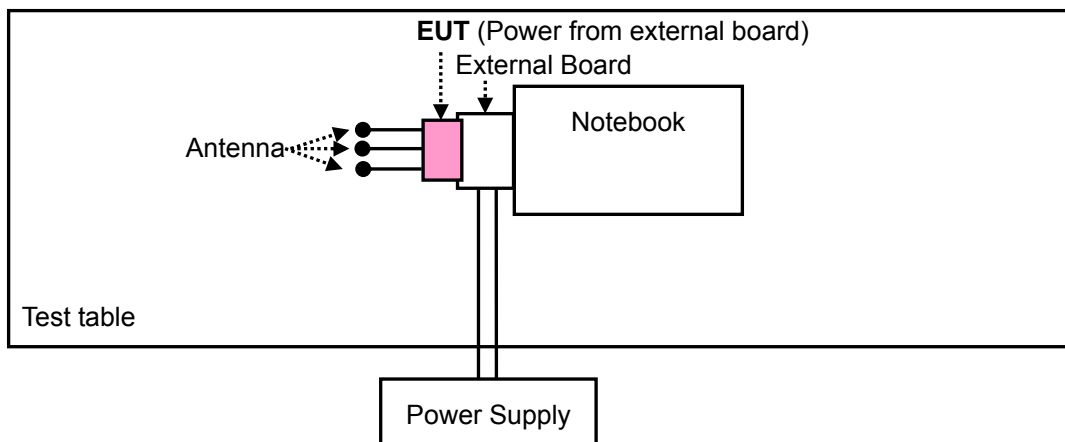



A D T

3.5 GENERAL DESCRIPTION OF APPLIED STANDARDS

The EUT is a RF Product. According to the specifications of the manufacturer, it must comply with the requirements of the following standards:

FCC Part 15, Subpart C (15.247)

558074 D01 DTS Meas Guidance v03r01

662911 D01 Multiple Transmitter Output v02r01

ANSI C63.10-2009

All test items have been performed and recorded as per the above standards.



4. TEST TYPES AND RESULTS (FOR 5.0GHz BAND)

4.1 RADIATED EMISSION MEASUREMENT

4.1.1 LIMITS OF RADIATED EMISSION MEASUREMENT

Radiated emissions which fall in the restricted bands must comply with the radiated emission limits specified as below table. Other emissions shall be at least 30dB below the highest level of the desired power:

FREQUENCIES (MHz)	FIELD STRENGTH (microvolts/meter)	MEASUREMENT DISTANCE (meters)
0.009 ~ 0.490	2400/F(kHz)	300
0.490 ~ 1.705	24000/F(kHz)	30
1.705 ~ 30.0	30	30
30 ~ 88	100	3
88 ~ 216	150	3
216 ~ 960	200	3
Above 960	500	3

NOTE:

1. The lower limit shall apply at the transition frequencies.
2. Emission level (dBuV/m) = 20 log Emission level (uV/m).
3. For frequencies above 1000MHz, the field strength limits are based on average detector, however, the peak field strength of any emission shall not exceed the maximum permitted average limits, specified above by more than 30dB under any condition of modulation.



A D T

4.1.2 TEST INSTRUMENTS

DESCRIPTION & MANUFACTURER	MODEL NO.	SERIAL NO.	DATE OF CALIBRATION	DUE DATE OF CALIBRATION
Test Receiver ROHDE & SCHWARZ	ESIB7	100187	Jan. 02, 2014	Jan. 01, 2015
Spectrum Analyzer ROHDE & SCHWARZ	FSP40	100039	Mar. 03, 2014	Mar. 02, 2015
BILOG Antenna SCHWARZBECK	VULB9168	9168-160	Feb. 26, 2014	Feb. 25, 2015
HORN Antenna SCHWARZBECK	9120D	209	Sep. 12, 2013	Sep. 11, 2014
HORN Antenna SCHWARZBECK	BBHA 9170	148	Jul. 15, 2013	Jul. 14, 2014
Preamplifier Agilent	8447D	2944A10633	Oct. 07, 2013	Oct. 06, 2014
Preamplifier Agilent	8449B	3008A01964	Aug. 26, 2013	Aug. 25, 2014
RF signal cable HUBER+SUHNNER	SUCOFLEX 104	214378/4	Aug. 26, 2013	Aug. 25, 2014
RF signal cable HUBER+SUHNNER	SUCOFLEX 106	12738/6 +309224/4	Aug. 26, 2013	Aug. 25, 2014
Software BV ADT	ADT_Radiated_ V7.6.15.9.4	NA	NA	NA
Antenna Tower inn-co GmbH	MA 4000	013303	NA	NA
Antenna Tower Controller inn-co GmbH	CO2000	017303	NA	NA
Turn Table BV ADT	TT100	TT93021703	NA	NA
Turn Table Controller BV ADT	SC100	SC93021703	NA	NA
26GHz ~ 40GHz Amplifier	EM26400	815221	Oct. 18, 2013	Oct. 17, 2014
High Speed Peak Power Meter	ML2495A	0824011	Jul. 29, 2013	Jul. 28, 2014
Power Sensor	MA2411B	0738171	Jul. 29, 2013	Jul. 28, 2014

- NOTE:** 1. The calibration interval of the above test instruments is 12 months and the calibrations are traceable to NML/ROC and NIST/USA.
2. The test was performed in HwaYa Chamber 3.
3. The horn antenna and HP preamplifier (model: 8449B) are used only for the measurement of emission frequency above 1GHz if tested.
4. The FCC Site Registration No. is 988962.
5. The IC Site Registration No. is IC 7450F-3.



A D T

4.1.3 TEST PROCEDURES

- a. The EUT was placed on the top of a rotating table 0.8 meters above the ground at a 3 meters semi-anechoic chamber. The table was rotated 360 degrees to determine the position of the highest radiation.
- b. The EUT was set 3 meters away from the interference-receiving antenna, which was mounted on the top of a variable-height antenna tower.
- c. The antenna is a broadband antenna, and its height is varied from one meter to four meters above the ground to determine the maximum value of the field strength. Both horizontal and vertical polarizations of the antenna are set to make the measurement.
- d. For each suspected emission, the EUT was arranged to its worst case and then the antenna was tuned to heights from 1 meter to 4 meters and the rotatable table was turned from 0 degrees to 360 degrees to find the maximum reading.
- e. The test-receiver system was set to Peak Detect Function and Specified Bandwidth with Maximum Hold Mode.
- f. If the emission level of the EUT in peak mode was lower than the limit specified, then testing could be stopped and the peak values of the EUT would be reported. Otherwise the emissions would be re-tested one by one using peak, quasi-peak or average method as specified and then reported in a data sheet.

NOTE:

1. The resolution bandwidth and video bandwidth of test receiver/spectrum analyzer is 120kHz for Quasi-peak detection at frequency below 1GHz.
2. The resolution bandwidth of test receiver/spectrum analyzer is 1MHz and video bandwidth is 3MHz for Peak detection at frequency above 1GHz.
3. The resolution bandwidth of test receiver/spectrum analyzer is 1MHz and the video bandwidth is $\geq 1/T$ (Duty cycle < 98%) or 10Hz (Duty cycle > 98%) for Average detection (AV) at frequency above 1GHz.
4. All modes of operation were investigated and the worst-case emissions are reported.

4.1.4 DEVIATION FROM TEST STANDARD

No deviation.

4.1.5 TEST SETUP

Frequency range 30MHz~1GHz

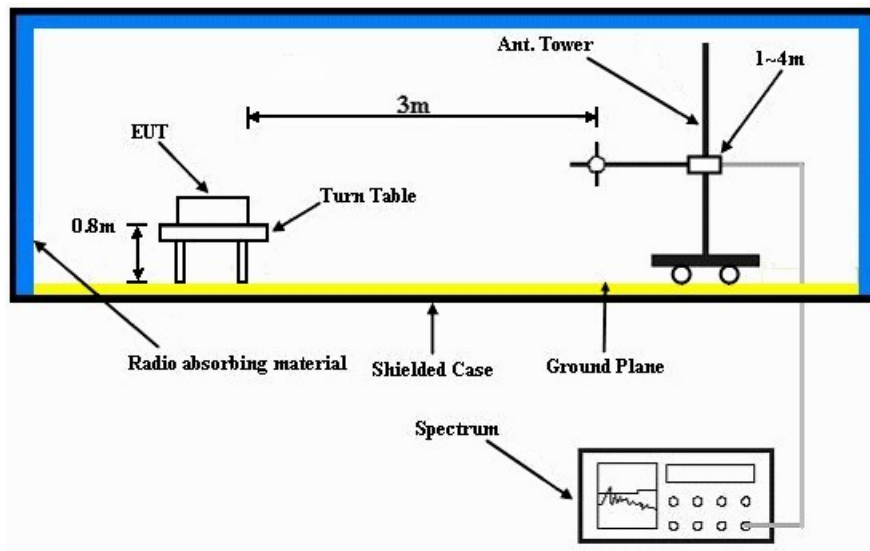

Frequency range above 1GHz

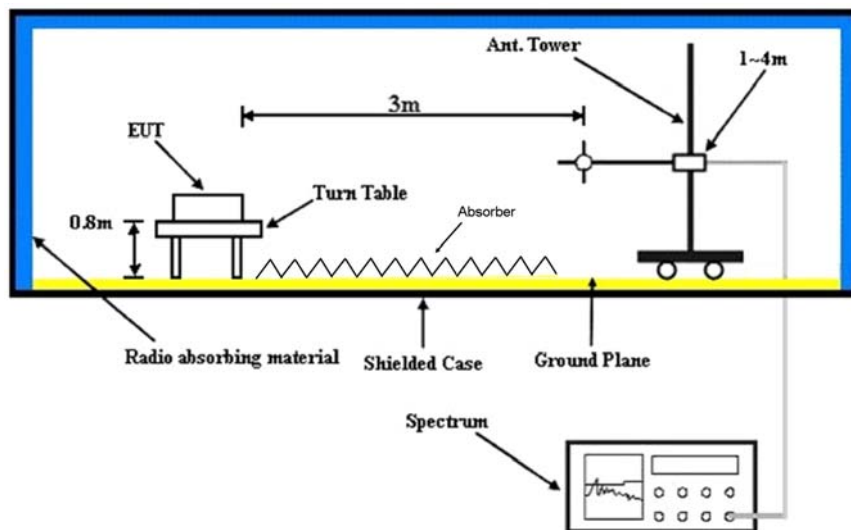

For the actual test configuration, please refer to the attached file (Test Setup Photo).



A D T

4.1.6 EUT OPERATING CONDITIONS

- a. Plugged the EUT into notebook via external board and placed them on the testing table.
- b. The notebook system ran a test program (provided by manufacturer) to enable EUT under transmission condition continuously at specific channel frequency.
- c. The necessary accessories enable the system in full functions.



A D T

4.1.7 TEST RESULTS

ABOVE 1GHz DATA :

802.11a

EUT TEST CONDITION		MEASUREMENT DETAIL	
CHANNEL	Channel 149	FREQUENCY RANGE	1 ~ 40GHz
INPUT POWER (SYSTEM)	120Vac, 60 Hz	DETECTOR FUNCTION	Peak (PK) Average (AV)
ENVIRONMENTAL CONDITIONS	25deg. C, 65%RH	TESTED BY	Jones Chang
TEST MODE	A		

ANTENNA POLARITY & TEST DISTANCE: HORIZONTAL AT 3 M								
NO.	FREQ. (MHz)	EMISSION LEVEL (dBuV/m)	LIMIT (dBuV/m)	MARGIN (dB)	ANTENNA HEIGHT (m)	TABLE ANGLE (Degree)	RAW VALUE (dBuV)	CORRECTION FACTOR (dB/m)
1	*5745.00	119.8 PK			1.11 H	355	81.30	38.50
2	*5745.00	109.2 AV			1.11 H	355	70.70	38.50
3	11490.00	63.8 PK	74.0	-10.2	1.40 H	199	43.40	20.40
4	11490.00	50.2 AV	54.0	-3.8	1.40 H	199	29.80	20.40
ANTENNA POLARITY & TEST DISTANCE: VERTICAL AT 3 M								
NO.	FREQ. (MHz)	EMISSION LEVEL (dBuV/m)	LIMIT (dBuV/m)	MARGIN (dB)	ANTENNA HEIGHT (m)	TABLE ANGLE (Degree)	RAW VALUE (dBuV)	CORRECTION FACTOR (dB/m)
1	*5745.00	126.8 PK			1.04 V	355	88.30	38.50
2	*5745.00	115.9 AV			1.04 V	355	77.40	38.50
3	11490.00	65.3 PK	74.0	-8.7	1.55 V	180	44.90	20.40
4	11490.00	52.4 AV	54.0	-1.6	1.55 V	180	32.00	20.40

REMARKS:

- Emission Level(dBuV/m) = Raw Value(dBuV) + Correction Factor(dB/m)
- Correction Factor(dB/m) = Antenna Factor(dB/m) + Cable Factor(dB) – Pre-Amplifier Factor(dB)
- The other emission levels were very low against the limit.
- Margin value = Emission Level – Limit value
- “ * ”: Fundamental frequency.
- The limit value is defined as per 15.247.



A D T

EUT TEST CONDITION		MEASUREMENT DETAIL	
CHANNEL	Channel 157	FREQUENCY RANGE	1 ~ 40GHz
INPUT POWER (SYSTEM)	120Vac, 60 Hz	DETECTOR FUNCTION	Peak (PK) Average (AV)
ENVIRONMENTAL CONDITIONS	25deg. C, 65%RH	TESTED BY	Jones Chang
TEST MODE	A		

ANTENNA POLARITY & TEST DISTANCE: HORIZONTAL AT 3 M								
NO.	FREQ. (MHz)	EMISSION LEVEL (dBuV/m)	LIMIT (dBuV/m)	MARGIN (dB)	ANTENNA HEIGHT (m)	TABLE ANGLE (Degree)	RAW VALUE (dBuV)	CORRECTION FACTOR (dB/m)
1	*5785.00	119.9 PK			1.09 H	352	81.30	38.60
2	*5785.00	109.8 AV			1.09 H	352	71.20	38.60
3	11570.00	66.9 PK	74.0	-7.1	1.45 H	213	46.50	20.40
4	11570.00	52.0 AV	54.0	-2.0	1.45 H	213	31.60	20.40
ANTENNA POLARITY & TEST DISTANCE: VERTICAL AT 3 M								
NO.	FREQ. (MHz)	EMISSION LEVEL (dBuV/m)	LIMIT (dBuV/m)	MARGIN (dB)	ANTENNA HEIGHT (m)	TABLE ANGLE (Degree)	RAW VALUE (dBuV)	CORRECTION FACTOR (dB/m)
1	*5785.00	125.3 PK			1.03 V	352	86.70	38.60
2	*5785.00	114.2 AV			1.03 V	352	75.60	38.60
3	11570.00	66.9 PK	74.0	-7.1	1.55 V	31	46.50	20.40
4	11570.00	52.6 AV	54.0	-1.4	1.55 V	31	32.20	20.40

REMARKS:

1. Emission Level(dBuV/m) = Raw Value(dBuV) + Correction Factor(dB/m)
2. Correction Factor(dB/m) = Antenna Factor(dB/m) + Cable Factor(dB)
– Pre-Amplifier Factor(dB)
3. The other emission levels were very low against the limit.
4. Margin value = Emission Level – Limit value
5. “ * “: Fundamental frequency.
6. The limit value is defined as per 15.247.



A D T

EUT TEST CONDITION		MEASUREMENT DETAIL	
CHANNEL	Channel 165	FREQUENCY RANGE	1 ~ 40GHz
INPUT POWER (SYSTEM)	120Vac, 60 Hz	DETECTOR FUNCTION	Peak (PK) Average (AV)
ENVIRONMENTAL CONDITIONS	25deg. C, 65%RH	TESTED BY	Jones Chang
TEST MODE	A		

ANTENNA POLARITY & TEST DISTANCE: HORIZONTAL AT 3 M								
NO.	FREQ. (MHz)	EMISSION LEVEL (dBuV/m)	LIMIT (dBuV/m)	MARGIN (dB)	ANTENNA HEIGHT (m)	TABLE ANGLE (Degree)	RAW VALUE (dBuV)	CORRECTION FACTOR (dB/m)
1	*5825.00	121.2 PK			1.09 H	351	82.50	38.70
2	*5825.00	110.2 AV			1.09 H	351	71.50	38.70
3	11650.00	65.6 PK	74.0	-8.4	1.41 H	282	45.30	20.30
4	11650.00	51.3 AV	54.0	-2.7	1.41 H	282	31.00	20.30
ANTENNA POLARITY & TEST DISTANCE: VERTICAL AT 3 M								
NO.	FREQ. (MHz)	EMISSION LEVEL (dBuV/m)	LIMIT (dBuV/m)	MARGIN (dB)	ANTENNA HEIGHT (m)	TABLE ANGLE (Degree)	RAW VALUE (dBuV)	CORRECTION FACTOR (dB/m)
1	*5825.00	126.0 PK			1.13 V	350	87.30	38.70
2	*5825.00	115.8 AV			1.13 V	350	77.10	38.70
3	11650.00	67.6 PK	74.0	-6.4	1.55 V	16	47.30	20.30
4	11650.00	52.8 AV	54.0	-1.2	1.55 V	16	32.50	20.30

REMARKS:

1. Emission Level(dBuV/m) = Raw Value(dBuV) + Correction Factor(dB/m)
2. Correction Factor(dB/m) = Antenna Factor(dB/m) + Cable Factor(dB)
– Pre-Amplifier Factor(dB)
3. The other emission levels were very low against the limit.
4. Margin value = Emission Level – Limit value
5. “ * “: Fundamental frequency.
6. The limit value is defined as per 15.247.



A D T

802.11n (20MHz)

EUT TEST CONDITION		MEASUREMENT DETAIL	
CHANNEL	Channel 149	FREQUENCY RANGE	1 ~ 40GHz
INPUT POWER (SYSTEM)	120Vac, 60 Hz	DETECTOR FUNCTION	Peak (PK) Average (AV)
ENVIRONMENTAL CONDITIONS	25deg. C, 65%RH	TESTED BY	Jones Chang
TEST MODE	A		

ANTENNA POLARITY & TEST DISTANCE: HORIZONTAL AT 3 M								
NO.	FREQ. (MHz)	EMISSION LEVEL (dBuV/m)	LIMIT (dBuV/m)	MARGIN (dB)	ANTENNA HEIGHT (m)	TABLE ANGLE (Degree)	RAW VALUE (dBuV)	CORRECTION FACTOR (dB/m)
1	*5745.00	118.0 PK			1.00 H	353	79.50	38.50
2	*5745.00	108.3 AV			1.00 H	353	69.80	38.50
3	11490.00	63.5 PK	74.0	-10.5	1.41 H	335	43.10	20.40
4	11490.00	50.7 AV	54.0	-3.3	1.41 H	335	30.30	20.40

ANTENNA POLARITY & TEST DISTANCE: VERTICAL AT 3 M								
NO.	FREQ. (MHz)	EMISSION LEVEL (dBuV/m)	LIMIT (dBuV/m)	MARGIN (dB)	ANTENNA HEIGHT (m)	TABLE ANGLE (Degree)	RAW VALUE (dBuV)	CORRECTION FACTOR (dB/m)
1	*5745.00	123.1 PK			1.24 V	357	84.60	38.50
2	*5745.00	112.3 AV			1.24 V	357	73.80	38.50
3	11490.00	65.6 PK	74.0	-8.4	1.15 V	187	45.20	20.40
4	11490.00	51.3 AV	54.0	-2.7	1.15 V	187	30.90	20.40

REMARKS:

1. Emission Level(dBuV/m) = Raw Value(dBuV) + Correction Factor(dB/m)
2. Correction Factor(dB/m) = Antenna Factor(dB/m) + Cable Factor(dB) – Pre-Amplifier Factor(dB)
3. The other emission levels were very low against the limit.
4. Margin value = Emission Level – Limit value
5. “ * “: Fundamental frequency.
6. The limit value is defined as per 15.247.



A D T

EUT TEST CONDITION		MEASUREMENT DETAIL	
CHANNEL	Channel 157	FREQUENCY RANGE	1 ~ 40GHz
INPUT POWER (SYSTEM)	120Vac, 60 Hz	DETECTOR FUNCTION	Peak (PK) Average (AV)
ENVIRONMENTAL CONDITIONS	25deg. C, 65%RH	TESTED BY	Jones Chang
TEST MODE	A		

ANTENNA POLARITY & TEST DISTANCE: HORIZONTAL AT 3 M								
NO.	FREQ. (MHz)	EMISSION LEVEL (dBuV/m)	LIMIT (dBuV/m)	MARGIN (dB)	ANTENNA HEIGHT (m)	TABLE ANGLE (Degree)	RAW VALUE (dBuV)	CORRECTION FACTOR (dB/m)
1	*5785.00	121.0 PK			1.00 H	359	82.40	38.60
2	*5785.00	110.4 AV			1.00 H	359	71.80	38.60
3	11490.00	65.7 PK	74.0	-8.3	1.43 H	284	45.30	20.40
4	11490.00	51.4 AV	54.0	-2.6	1.43 H	284	31.00	20.40
ANTENNA POLARITY & TEST DISTANCE: VERTICAL AT 3 M								
NO.	FREQ. (MHz)	EMISSION LEVEL (dBuV/m)	LIMIT (dBuV/m)	MARGIN (dB)	ANTENNA HEIGHT (m)	TABLE ANGLE (Degree)	RAW VALUE (dBuV)	CORRECTION FACTOR (dB/m)
1	*5785.00	125.4 PK			1.03 V	351	86.80	38.60
2	*5785.00	115.3 AV			1.03 V	351	76.70	38.60
3	11570.00	66.0 PK	74.0	-8.0	1.32 V	37	45.60	20.40
4	11570.00	52.6 AV	54.0	-1.4	1.32 V	37	32.20	20.40

REMARKS:

1. Emission Level(dBuV/m) = Raw Value(dBuV) + Correction Factor(dB/m)
2. Correction Factor(dB/m) = Antenna Factor(dB/m) + Cable Factor(dB)
– Pre-Amplifier Factor(dB)
3. The other emission levels were very low against the limit.
4. Margin value = Emission Level – Limit value
5. “ * “: Fundamental frequency.
6. The limit value is defined as per 15.247.



A D T

EUT TEST CONDITION		MEASUREMENT DETAIL	
CHANNEL	Channel 165	FREQUENCY RANGE	1 ~ 40GHz
INPUT POWER (SYSTEM)	120Vac, 60 Hz	DETECTOR FUNCTION	Peak (PK) Average (AV)
ENVIRONMENTAL CONDITIONS	25deg. C, 65%RH	TESTED BY	Jones Chang
TEST MODE	A		

ANTENNA POLARITY & TEST DISTANCE: HORIZONTAL AT 3 M								
NO.	FREQ. (MHz)	EMISSION LEVEL (dBuV/m)	LIMIT (dBuV/m)	MARGIN (dB)	ANTENNA HEIGHT (m)	TABLE ANGLE (Degree)	RAW VALUE (dBuV)	CORRECTION FACTOR (dB/m)
1	*5825.00	119.6 PK			1.00 H	330	80.90	38.70
2	*5825.00	109.4 AV			1.00 H	330	70.70	38.70
3	11650.00	66.1 PK	74.0	-7.9	1.42 H	284	45.80	20.30
4	11650.00	52.1 AV	54.0	-1.9	1.42 H	284	31.80	20.30
ANTENNA POLARITY & TEST DISTANCE: VERTICAL AT 3 M								
NO.	FREQ. (MHz)	EMISSION LEVEL (dBuV/m)	LIMIT (dBuV/m)	MARGIN (dB)	ANTENNA HEIGHT (m)	TABLE ANGLE (Degree)	RAW VALUE (dBuV)	CORRECTION FACTOR (dB/m)
1	*5825.00	126.4 PK			1.12 V	350	87.70	38.70
2	*5825.00	116.0 AV			1.12 V	350	77.30	38.70
3	11650.00	66.8 PK	74.0	-7.2	1.70 V	17	46.50	20.30
4	11650.00	52.7 AV	54.0	-1.3	1.70 V	17	32.40	20.30

REMARKS:

1. Emission Level(dBuV/m) = Raw Value(dBuV) + Correction Factor(dB/m)
2. Correction Factor(dB/m) = Antenna Factor(dB/m) + Cable Factor(dB)
– Pre-Amplifier Factor(dB)
3. The other emission levels were very low against the limit.
4. Margin value = Emission Level – Limit value
5. “ * “: Fundamental frequency.
6. The limit value is defined as per 15.247.



A D T

802.11n (40MHz)

EUT TEST CONDITION		MEASUREMENT DETAIL	
CHANNEL	Channel 151	FREQUENCY RANGE	1 ~ 40GHz
INPUT POWER (SYSTEM)	120Vac, 60 Hz	DETECTOR FUNCTION	Peak (PK) Average (AV)
ENVIRONMENTAL CONDITIONS	25deg. C, 65%RH	TESTED BY	Jones Chang
TEST MODE	A		

ANTENNA POLARITY & TEST DISTANCE: HORIZONTAL AT 3 M								
NO.	FREQ. (MHz)	EMISSION LEVEL (dBuV/m)	LIMIT (dBuV/m)	MARGIN (dB)	ANTENNA HEIGHT (m)	TABLE ANGLE (Degree)	RAW VALUE (dBuV)	CORRECTION FACTOR (dB/m)
1	*5755.00	116.2 PK			1.00 H	359	77.60	38.60
2	*5755.00	106.1 AV			1.00 H	359	67.50	38.60
3	11510.00	64.0 PK	74.0	-10.0	1.48 H	212	43.60	20.40
4	11510.00	50.3 AV	54.0	-3.7	1.48 H	212	29.90	20.40

ANTENNA POLARITY & TEST DISTANCE: VERTICAL AT 3 M								
NO.	FREQ. (MHz)	EMISSION LEVEL (dBuV/m)	LIMIT (dBuV/m)	MARGIN (dB)	ANTENNA HEIGHT (m)	TABLE ANGLE (Degree)	RAW VALUE (dBuV)	CORRECTION FACTOR (dB/m)
1	*5755.00	121.3 PK			1.03 V	2	82.70	38.60
2	*5755.00	110.9 AV			1.03 V	2	72.30	38.60
3	11510.00	64.0 PK	74.0	-10.0	1.59 V	20	43.60	20.40
4	11510.00	50.9 AV	54.0	-3.1	1.59 V	20	30.50	20.40

REMARKS:

1. Emission Level(dBuV/m) = Raw Value(dBuV) + Correction Factor(dB/m)
2. Correction Factor(dB/m) = Antenna Factor(dB/m) + Cable Factor(dB) – Pre-Amplifier Factor(dB)
3. The other emission levels were very low against the limit.
4. Margin value = Emission Level – Limit value
5. “ * “: Fundamental frequency.
6. The limit value is defined as per 15.247.



A D T

EUT TEST CONDITION		MEASUREMENT DETAIL	
CHANNEL	Channel 159	FREQUENCY RANGE	1 ~ 40GHz
INPUT POWER (SYSTEM)	120Vac, 60 Hz	DETECTOR FUNCTION	Peak (PK) Average (AV)
ENVIRONMENTAL CONDITIONS	25deg. C, 65%RH	TESTED BY	Jones Chang
TEST MODE	A		

ANTENNA POLARITY & TEST DISTANCE: HORIZONTAL AT 3 M								
NO.	FREQ. (MHz)	EMISSION LEVEL (dBuV/m)	LIMIT (dBuV/m)	MARGIN (dB)	ANTENNA HEIGHT (m)	TABLE ANGLE (Degree)	RAW VALUE (dBuV)	CORRECTION FACTOR (dB/m)
1	*5795.00	116.3 PK			1.00 H	343	77.70	38.60
2	*5795.00	106.6 AV			1.00 H	343	68.00	38.60
3	11590.00	64.9 PK	74.0	-9.1	1.48 H	212	44.50	20.40
4	11590.00	50.5 AV	54.0	-3.5	1.48 H	212	30.10	20.40
ANTENNA POLARITY & TEST DISTANCE: VERTICAL AT 3 M								
NO.	FREQ. (MHz)	EMISSION LEVEL (dBuV/m)	LIMIT (dBuV/m)	MARGIN (dB)	ANTENNA HEIGHT (m)	TABLE ANGLE (Degree)	RAW VALUE (dBuV)	CORRECTION FACTOR (dB/m)
1	*5795.00	121.2 PK			1.23 V	347	82.60	38.60
2	*5795.00	110.7 AV			1.23 V	347	72.10	38.60
3	11590.00	66.2 PK	74.0	-7.8	1.41 V	17	45.80	20.40
4	11590.00	52.3 AV	54.0	-1.7	1.41 V	17	31.90	20.40

REMARKS:

1. Emission Level(dBuV/m) = Raw Value(dBuV) + Correction Factor(dB/m)
2. Correction Factor(dB/m) = Antenna Factor(dB/m) + Cable Factor(dB)
– Pre-Amplifier Factor(dB)
3. The other emission levels were very low against the limit.
4. Margin value = Emission Level – Limit value
5. “ * ”: Fundamental frequency.
6. The limit value is defined as per 15.247.



A D T

802.11ac (80MHz)

EUT TEST CONDITION		MEASUREMENT DETAIL	
CHANNEL	Channel 155	FREQUENCY RANGE	1 ~ 40GHz
INPUT POWER (SYSTEM)	120Vac, 60 Hz	DETECTOR FUNCTION	Peak (PK) Average (AV)
ENVIRONMENTAL CONDITIONS	25deg. C, 65%RH	TESTED BY	Jones Chang
TEST MODE	A		

ANTENNA POLARITY & TEST DISTANCE: HORIZONTAL AT 3 M								
NO.	FREQ. (MHz)	EMISSION LEVEL (dBuV/m)	LIMIT (dBuV/m)	MARGIN (dB)	ANTENNA HEIGHT (m)	TABLE ANGLE (Degree)	RAW VALUE (dBuV)	CORRECTION FACTOR (dB/m)
1	*5775.00	114.1 PK			1.00 H	340	75.50	38.60
2	*5775.00	103.8 AV			1.00 H	340	65.20	38.60
3	11550.00	63.4 PK	74.0	-10.6	1.45 H	221	43.00	20.40
4	11550.00	49.9 AV	54.0	-4.1	1.45 H	221	29.50	20.40
ANTENNA POLARITY & TEST DISTANCE: VERTICAL AT 3 M								
NO.	FREQ. (MHz)	EMISSION LEVEL (dBuV/m)	LIMIT (dBuV/m)	MARGIN (dB)	ANTENNA HEIGHT (m)	TABLE ANGLE (Degree)	RAW VALUE (dBuV)	CORRECTION FACTOR (dB/m)
1	*5775.00	117.4 PK			1.23 V	349	78.80	38.60
2	*5775.00	107.7 AV			1.23 V	349	69.10	38.60
3	11550.00	63.6 PK	74.0	-10.4	1.59 V	19	43.20	20.40
4	11550.00	50.6 AV	54.0	-3.4	1.59 V	19	30.20	20.40

REMARKS:

1. Emission Level(dBuV/m) = Raw Value(dBuV) + Correction Factor(dB/m)
2. Correction Factor(dB/m) = Antenna Factor(dB/m) + Cable Factor(dB) - Pre-Amplifier Factor(dB)
3. The other emission levels were very low against the limit.
4. Margin value = Emission Level - Limit value
5. " * " : Fundamental frequency.
6. The limit value is defined as per 15.247.



A D T

802.11a

EUT TEST CONDITION		MEASUREMENT DETAIL	
CHANNEL	Channel 149	FREQUENCY RANGE	1 ~ 40GHz
INPUT POWER (SYSTEM)	120Vac, 60 Hz	DETECTOR FUNCTION	Peak (PK) Average (AV)
ENVIRONMENTAL CONDITIONS	25deg. C, 65%RH	TESTED BY	Chris Lin
TEST MODE	B		

ANTENNA POLARITY & TEST DISTANCE: HORIZONTAL AT 3 M								
NO.	FREQ. (MHz)	EMISSION LEVEL (dBuV/m)	LIMIT (dBuV/m)	MARGIN (dB)	ANTENNA HEIGHT (m)	TABLE ANGLE (Degree)	RAW VALUE (dBuV)	CORRECTION FACTOR (dB/m)
1	5399.00	62.9 PK	74.0	-11.1	1.20 H	353	57.50	5.40
2	5399.00	50.7 AV	54.0	-3.3	1.20 H	353	45.30	5.40
3	*5745.00	118.8 PK			1.18 H	352	80.30	38.50
4	*5745.00	108.9 AV			1.18 H	352	70.40	38.50
5	11490.00	63.0 PK	74.0	-11.0	1.02 H	87	42.60	20.40
6	11490.00	48.2 AV	54.0	-5.8	1.02 H	87	27.80	20.40

ANTENNA POLARITY & TEST DISTANCE: VERTICAL AT 3 M								
NO.	FREQ. (MHz)	EMISSION LEVEL (dBuV/m)	LIMIT (dBuV/m)	MARGIN (dB)	ANTENNA HEIGHT (m)	TABLE ANGLE (Degree)	RAW VALUE (dBuV)	CORRECTION FACTOR (dB/m)
1	5427.00	64.4 PK	74.0	-9.6	1.16 V	350	58.90	5.50
2	5427.00	52.5 AV	54.0	-1.5	1.16 V	350	47.00	5.50
3	*5745.00	125.4 PK			1.16 V	351	86.90	38.50
4	*5745.00	114.0 AV			1.16 V	351	75.50	38.50
5	11490.00	61.4 PK	74.0	-12.6	1.10 V	239	41.00	20.40
6	11490.00	48.2 AV	54.0	-5.8	1.10 V	239	27.80	20.40

REMARKS:

1. Emission Level(dBuV/m) = Raw Value(dBuV) + Correction Factor(dB/m)
2. Correction Factor(dB/m) = Antenna Factor(dB/m) + Cable Factor(dB)
– Pre-Amplifier Factor(dB)
3. The other emission levels were very low against the limit.
4. Margin value = Emission Level – Limit value
5. “ * ”: Fundamental frequency.
6. The limit value is defined as per 15.247.



A D T

EUT TEST CONDITION		MEASUREMENT DETAIL	
CHANNEL	Channel 157	FREQUENCY RANGE	1 ~ 40GHz
INPUT POWER (SYSTEM)	120Vac, 60 Hz	DETECTOR FUNCTION	Peak (PK) Average (AV)
ENVIRONMENTAL CONDITIONS	25deg. C, 65%RH	TESTED BY	Chris Lin
TEST MODE	B		

ANTENNA POLARITY & TEST DISTANCE: HORIZONTAL AT 3 M								
NO.	FREQ. (MHz)	EMISSION LEVEL (dBuV/m)	LIMIT (dBuV/m)	MARGIN (dB)	ANTENNA HEIGHT (m)	TABLE ANGLE (Degree)	RAW VALUE (dBuV)	CORRECTION FACTOR (dB/m)
1	5397.00	63.2 PK	74.0	-10.8	1.16 H	351	57.80	5.40
2	5397.00	51.0 AV	54.0	-3.0	1.16 H	351	45.60	5.40
3	*5785.00	119.3 PK			1.00 H	353	80.70	38.60
4	*5785.00	109.4 AV			1.00 H	353	70.80	38.60
5	11530.00	61.8 PK	74.0	-12.2	1.07 H	44	41.30	20.50
6	11530.00	48.1 AV	54.0	-5.9	1.07 H	44	27.60	20.50

ANTENNA POLARITY & TEST DISTANCE: VERTICAL AT 3 M								
NO.	FREQ. (MHz)	EMISSION LEVEL (dBuV/m)	LIMIT (dBuV/m)	MARGIN (dB)	ANTENNA HEIGHT (m)	TABLE ANGLE (Degree)	RAW VALUE (dBuV)	CORRECTION FACTOR (dB/m)
1	5459.00	64.2 PK	74.0	-9.8	1.15 V	350	58.60	5.60
2	5459.00	52.5 AV	54.0	-1.5	1.15 V	350	46.90	5.60
3	*5785.00	126.0 PK			1.11 V	350	87.40	38.60
4	*5785.00	114.0 AV			1.11 V	350	75.40	38.60
5	11530.00	62.4 PK	74.0	-11.6	1.30 V	224	41.90	20.50
6	11530.00	48.0 AV	54.0	-6.0	1.30 V	224	27.50	20.50

REMARKS:

1. Emission Level(dBuV/m) = Raw Value(dBuV) + Correction Factor(dB/m)
2. Correction Factor(dB/m) = Antenna Factor(dB/m) + Cable Factor(dB)
– Pre-Amplifier Factor(dB)
3. The other emission levels were very low against the limit.
4. Margin value = Emission Level – Limit value
5. “ * ”: Fundamental frequency.
6. The limit value is defined as per 15.247.



A D T

EUT TEST CONDITION		MEASUREMENT DETAIL	
CHANNEL	Channel 165	FREQUENCY RANGE	1 ~ 40GHz
INPUT POWER (SYSTEM)	120Vac, 60 Hz	DETECTOR FUNCTION	Peak (PK) Average (AV)
ENVIRONMENTAL CONDITIONS	25deg. C, 65%RH	TESTED BY	Chris Lin
TEST MODE	B		

ANTENNA POLARITY & TEST DISTANCE: HORIZONTAL AT 3 M								
NO.	FREQ. (MHz)	EMISSION LEVEL (dBuV/m)	LIMIT (dBuV/m)	MARGIN (dB)	ANTENNA HEIGHT (m)	TABLE ANGLE (Degree)	RAW VALUE (dBuV)	CORRECTION FACTOR (dB/m)
1	5395.00	62.7 PK	74.0	-11.3	1.21 H	352	57.30	5.40
2	5395.00	50.5 AV	54.0	-3.5	1.21 H	352	45.10	5.40
3	*5825.00	115.5 PK			1.18 H	351	76.80	38.70
4	*5825.00	105.7 AV			1.18 H	351	67.00	38.70
5	11650.00	61.8 PK	74.0	-12.2	1.23 H	205	41.50	20.30
6	11650.00	48.1 AV	54.0	-5.9	1.23 H	205	27.80	20.30

ANTENNA POLARITY & TEST DISTANCE: VERTICAL AT 3 M								
NO.	FREQ. (MHz)	EMISSION LEVEL (dBuV/m)	LIMIT (dBuV/m)	MARGIN (dB)	ANTENNA HEIGHT (m)	TABLE ANGLE (Degree)	RAW VALUE (dBuV)	CORRECTION FACTOR (dB/m)
1	5383.00	64.9 PK	74.0	-9.1	1.09 V	351	59.50	5.40
2	5383.00	52.3 AV	54.0	-1.7	1.09 V	351	46.90	5.40
3	*5825.00	123.8 PK			1.06 V	350	85.10	38.70
4	*5825.00	112.2 AV			1.06 V	350	73.50	38.70
5	11650.00	61.9 PK	74.0	-12.1	1.10 V	54	41.60	20.30
6	11650.00	48.3 AV	54.0	-5.7	1.10 V	54	28.00	20.30

REMARKS:

1. Emission Level(dBuV/m) = Raw Value(dBuV) + Correction Factor(dB/m)
2. Correction Factor(dB/m) = Antenna Factor(dB/m) + Cable Factor(dB)
– Pre-Amplifier Factor(dB)
3. The other emission levels were very low against the limit.
4. Margin value = Emission Level – Limit value
5. “ * “: Fundamental frequency.
6. The limit value is defined as per 15.247.



A D T

802.11n (20MHz)

EUT TEST CONDITION		MEASUREMENT DETAIL	
CHANNEL	Channel 149	FREQUENCY RANGE	1 ~ 40GHz
INPUT POWER (SYSTEM)	120Vac, 60 Hz	DETECTOR FUNCTION	Peak (PK) Average (AV)
ENVIRONMENTAL CONDITIONS	25deg. C, 65%RH	TESTED BY	Chris Lin
TEST MODE	B		

ANTENNA POLARITY & TEST DISTANCE: HORIZONTAL AT 3 M								
NO.	FREQ. (MHz)	EMISSION LEVEL (dBuV/m)	LIMIT (dBuV/m)	MARGIN (dB)	ANTENNA HEIGHT (m)	TABLE ANGLE (Degree)	RAW VALUE (dBuV)	CORRECTION FACTOR (dB/m)
1	5392.00	62.3 PK	74.0	-11.7	1.22 H	353	56.90	5.40
2	5392.00	50.3 AV	54.0	-3.7	1.22 H	353	44.90	5.40
3	*5745.00	117.0 PK			1.17 H	352	78.50	38.50
4	*5745.00	106.9 AV			1.17 H	352	68.40	38.50
5	11490.00	61.9 PK	74.0	-12.1	1.06 H	208	41.50	20.40
6	11490.00	47.9 AV	54.0	-6.1	1.06 H	208	27.50	20.40
ANTENNA POLARITY & TEST DISTANCE: VERTICAL AT 3 M								
NO.	FREQ. (MHz)	EMISSION LEVEL (dBuV/m)	LIMIT (dBuV/m)	MARGIN (dB)	ANTENNA HEIGHT (m)	TABLE ANGLE (Degree)	RAW VALUE (dBuV)	CORRECTION FACTOR (dB/m)
1	5423.00	64.4 PK	74.0	-9.6	1.17 V	351	58.90	5.50
2	5423.00	52.3 AV	54.0	-1.7	1.17 V	351	46.80	5.50
3	*5745.00	122.4 PK			1.08 V	350	83.90	38.50
4	*5745.00	111.8 AV			1.08 V	350	73.30	38.50
5	11490.00	61.7 PK	74.0	-12.3	1.15 V	69	41.30	20.40
6	11490.00	48.3 AV	54.0	-5.7	1.15 V	69	27.90	20.40

REMARKS:

1. Emission Level(dBuV/m) = Raw Value(dBuV) + Correction Factor(dB/m)
2. Correction Factor(dB/m) = Antenna Factor(dB/m) + Cable Factor(dB) – Pre-Amplifier Factor(dB)
3. The other emission levels were very low against the limit.
4. Margin value = Emission Level – Limit value
5. “ * “: Fundamental frequency.
6. The limit value is defined as per 15.247.



A D T

EUT TEST CONDITION		MEASUREMENT DETAIL	
CHANNEL	Channel 157	FREQUENCY RANGE	1 ~ 40GHz
INPUT POWER (SYSTEM)	120Vac, 60 Hz	DETECTOR FUNCTION	Peak (PK) Average (AV)
ENVIRONMENTAL CONDITIONS	25deg. C, 65%RH	TESTED BY	Chris Lin
TEST MODE	B		

ANTENNA POLARITY & TEST DISTANCE: HORIZONTAL AT 3 M								
NO.	FREQ. (MHz)	EMISSION LEVEL (dBuV/m)	LIMIT (dBuV/m)	MARGIN (dB)	ANTENNA HEIGHT (m)	TABLE ANGLE (Degree)	RAW VALUE (dBuV)	CORRECTION FACTOR (dB/m)
1	5395.00	62.3 PK	74.0	-11.7	1.24 H	350	56.90	5.40
2	5395.00	50.8 AV	54.0	-3.2	1.24 H	350	45.40	5.40
3	*5785.00	116.4 PK			1.11 H	353	77.80	38.60
4	*5785.00	105.9 AV			1.11 H	353	67.30	38.60
5	11570.00	63.3 PK	74.0	-10.7	1.26 H	74	42.90	20.40
6	11570.00	47.9 AV	54.0	-6.1	1.26 H	74	27.50	20.40

ANTENNA POLARITY & TEST DISTANCE: VERTICAL AT 3 M								
NO.	FREQ. (MHz)	EMISSION LEVEL (dBuV/m)	LIMIT (dBuV/m)	MARGIN (dB)	ANTENNA HEIGHT (m)	TABLE ANGLE (Degree)	RAW VALUE (dBuV)	CORRECTION FACTOR (dB/m)
1	5458.00	63.7 PK	74.0	-10.3	1.15 V	351	58.10	5.60
2	5458.00	52.3 AV	54.0	-1.7	1.15 V	351	46.70	5.60
3	*5785.00	121.2 PK			1.14 V	351	82.60	38.60
4	*5785.00	110.6 AV			1.14 V	351	72.00	38.60
5	11570.00	62.3 PK	74.0	-11.7	1.06 V	28	41.90	20.40
6	11570.00	48.0 AV	54.0	-6.0	1.06 V	28	27.60	20.40

REMARKS:

1. Emission Level(dBuV/m) = Raw Value(dBuV) + Correction Factor(dB/m)
2. Correction Factor(dB/m) = Antenna Factor(dB/m) + Cable Factor(dB)
– Pre-Amplifier Factor(dB)
3. The other emission levels were very low against the limit.
4. Margin value = Emission Level – Limit value
5. “ * “: Fundamental frequency.
6. The limit value is defined as per 15.247.



A D T

EUT TEST CONDITION		MEASUREMENT DETAIL	
CHANNEL	Channel 165	FREQUENCY RANGE	1 ~ 40GHz
INPUT POWER (SYSTEM)	120Vac, 60 Hz	DETECTOR FUNCTION	Peak (PK) Average (AV)
ENVIRONMENTAL CONDITIONS	25deg. C, 65%RH	TESTED BY	Chris Lin
TEST MODE	B		

ANTENNA POLARITY & TEST DISTANCE: HORIZONTAL AT 3 M								
NO.	FREQ. (MHz)	EMISSION LEVEL (dBuV/m)	LIMIT (dBuV/m)	MARGIN (dB)	ANTENNA HEIGHT (m)	TABLE ANGLE (Degree)	RAW VALUE (dBuV)	CORRECTION FACTOR (dB/m)
1	5401.00	62.9 PK	74.0	-11.1	1.20 H	352	57.50	5.40
2	5401.00	50.8 AV	54.0	-3.2	1.20 H	352	45.40	5.40
3	*5825.00	114.3 PK			1.10 H	351	75.60	38.70
4	*5825.00	104.5 AV			1.10 H	351	65.80	38.70
5	11650.00	62.2 PK	74.0	-11.8	1.36 H	205	41.90	20.30
6	11650.00	47.7 AV	54.0	-6.3	1.36 H	205	27.40	20.30

ANTENNA POLARITY & TEST DISTANCE: VERTICAL AT 3 M								
NO.	FREQ. (MHz)	EMISSION LEVEL (dBuV/m)	LIMIT (dBuV/m)	MARGIN (dB)	ANTENNA HEIGHT (m)	TABLE ANGLE (Degree)	RAW VALUE (dBuV)	CORRECTION FACTOR (dB/m)
1	5381.00	63.9 PK	74.0	-10.1	1.11 V	350	58.50	5.40
2	5381.00	52.2 AV	54.0	-1.8	1.11 V	350	46.80	5.40
3	*5825.00	120.9 PK			1.05 V	349	82.20	38.70
4	*5825.00	110.4 AV			1.05 V	349	71.70	38.70
5	11650.00	63.0 PK	74.0	-11.0	1.15 V	74	42.70	20.30
6	11650.00	49.2 AV	54.0	-4.8	1.15 V	74	28.90	20.30

REMARKS:

1. Emission Level(dBuV/m) = Raw Value(dBuV) + Correction Factor(dB/m)
2. Correction Factor(dB/m) = Antenna Factor(dB/m) + Cable Factor(dB)
– Pre-Amplifier Factor(dB)
3. The other emission levels were very low against the limit.
4. Margin value = Emission Level – Limit value
5. “ * “: Fundamental frequency.
6. The limit value is defined as per 15.247.



A D T

802.11n (40MHz)

EUT TEST CONDITION		MEASUREMENT DETAIL	
CHANNEL	Channel 151	FREQUENCY RANGE	1 ~ 40GHz
INPUT POWER (SYSTEM)	120Vac, 60 Hz	DETECTOR FUNCTION	Peak (PK) Average (AV)
ENVIRONMENTAL CONDITIONS	25deg. C, 65%RH	TESTED BY	Chris Lin
TEST MODE	B		

ANTENNA POLARITY & TEST DISTANCE: HORIZONTAL AT 3 M								
NO.	FREQ. (MHz)	EMISSION LEVEL (dBuV/m)	LIMIT (dBuV/m)	MARGIN (dB)	ANTENNA HEIGHT (m)	TABLE ANGLE (Degree)	RAW VALUE (dBuV)	CORRECTION FACTOR (dB/m)
1	5148.00	61.1 PK	74.0	-12.9	1.24 H	351	56.00	5.10
2	5148.00	49.2 AV	54.0	-4.8	1.24 H	351	44.10	5.10
3	5396.00	62.2 PK	74.0	-11.8	1.21 H	352	56.80	5.40
4	5396.00	50.5 AV	54.0	-3.5	1.21 H	352	45.10	5.40
5	*5755.00	116.3 PK			1.15 H	353	77.70	38.60
6	*5755.00	106.6 AV			1.15 H	353	68.00	38.60
7	11510.00	62.3 PK	74.0	-11.7	1.19 H	62	41.90	20.40
8	11510.00	48.2 AV	54.0	-5.8	1.19 H	62	27.80	20.40
ANTENNA POLARITY & TEST DISTANCE: VERTICAL AT 3 M								
NO.	FREQ. (MHz)	EMISSION LEVEL (dBuV/m)	LIMIT (dBuV/m)	MARGIN (dB)	ANTENNA HEIGHT (m)	TABLE ANGLE (Degree)	RAW VALUE (dBuV)	CORRECTION FACTOR (dB/m)
1	5103.00	65.6 PK	74.0	-8.4	1.13 V	350	60.50	5.10
2	5103.00	52.7 AV	54.0	-1.3	1.13 V	350	47.60	5.10
3	5439.00	66.8 PK	74.0	-7.2	1.16 V	349	61.20	5.60
4	5439.00	53.0 AV	54.0	-1.0	1.16 V	349	47.40	5.60
5	*5755.00	122.6 PK			1.13 V	350	84.00	38.60
6	*5755.00	111.9 AV			1.13 V	350	73.30	38.60
7	11510.00	62.3 PK	74.0	-11.7	1.00 V	360	41.90	20.40
8	11510.00	47.5 AV	54.0	-6.5	1.00 V	360	27.10	20.40

REMARKS:

1. Emission Level(dBuV/m) = Raw Value(dBuV) + Correction Factor(dB/m)
2. Correction Factor(dB/m) = Antenna Factor(dB/m) + Cable Factor(dB) – Pre-Amplifier Factor(dB)
3. The other emission levels were very low against the limit.
4. Margin value = Emission Level – Limit value
5. “ * “: Fundamental frequency.
6. The limit value is defined as per 15.247.



A D T

EUT TEST CONDITION		MEASUREMENT DETAIL	
CHANNEL	Channel 159	FREQUENCY RANGE	1 ~ 40GHz
INPUT POWER (SYSTEM)	120Vac, 60 Hz	DETECTOR FUNCTION	Peak (PK) Average (AV)
ENVIRONMENTAL CONDITIONS	25deg. C, 65%RH	TESTED BY	Chris Lin
TEST MODE	B		

ANTENNA POLARITY & TEST DISTANCE: HORIZONTAL AT 3 M								
NO.	FREQ. (MHz)	EMISSION LEVEL (dBuV/m)	LIMIT (dBuV/m)	MARGIN (dB)	ANTENNA HEIGHT (m)	TABLE ANGLE (Degree)	RAW VALUE (dBuV)	CORRECTION FACTOR (dB/m)
1	5458.00	63.5 PK	74.0	-10.5	1.10 H	352	57.90	5.60
2	5458.00	51.3 AV	54.0	-2.7	1.10 H	352	45.70	5.60
3	*5795.00	118.4 PK			1.07 H	351	79.80	38.60
4	*5795.00	108.7 AV			1.07 H	351	70.10	38.60
5	11590.00	63.0 PK	74.0	-11.0	1.05 H	22	42.60	20.40
6	11590.00	48.2 AV	54.0	-5.8	1.05 H	22	27.80	20.40

ANTENNA POLARITY & TEST DISTANCE: VERTICAL AT 3 M								
NO.	FREQ. (MHz)	EMISSION LEVEL (dBuV/m)	LIMIT (dBuV/m)	MARGIN (dB)	ANTENNA HEIGHT (m)	TABLE ANGLE (Degree)	RAW VALUE (dBuV)	CORRECTION FACTOR (dB/m)
1	5383.00	64.7 PK	74.0	-9.3	1.14 V	352	59.30	5.40
2	5383.00	53.0 AV	54.0	-1.0	1.14 V	352	47.60	5.40
3	*5795.00	121.1 PK			1.18 V	350	82.50	38.60
4	*5795.00	110.7 AV			1.18 V	350	72.10	38.60
5	11590.00	62.2 PK	74.0	-11.8	1.20 V	36	41.80	20.40
6	11590.00	48.2 AV	54.0	-5.8	1.20 V	36	27.80	20.40

REMARKS:

1. Emission Level(dBuV/m) = Raw Value(dBuV) + Correction Factor(dB/m)
2. Correction Factor(dB/m) = Antenna Factor(dB/m) + Cable Factor(dB)
– Pre-Amplifier Factor(dB)
3. The other emission levels were very low against the limit.
4. Margin value = Emission Level – Limit value
5. “ * ”: Fundamental frequency.
6. The limit value is defined as per 15.247.



A D T

802.11ac (80MHz)

EUT TEST CONDITION		MEASUREMENT DETAIL	
CHANNEL	Channel 155	FREQUENCY RANGE	1 ~ 40GHz
INPUT POWER (SYSTEM)	120Vac, 60 Hz	DETECTOR FUNCTION	Peak (PK) Average (AV)
ENVIRONMENTAL CONDITIONS	25deg. C, 65%RH	TESTED BY	Chris Lin
TEST MODE	B		

ANTENNA POLARITY & TEST DISTANCE: HORIZONTAL AT 3 M								
NO.	FREQ. (MHz)	EMISSION LEVEL (dBuV/m)	LIMIT (dBuV/m)	MARGIN (dB)	ANTENNA HEIGHT (m)	TABLE ANGLE (Degree)	RAW VALUE (dBuV)	CORRECTION FACTOR (dB/m)
1	5149.00	61.6 PK	74.0	-12.4	1.15 H	349	56.50	5.10
2	5149.00	49.4 AV	54.0	-4.6	1.15 H	349	44.30	5.10
3	5395.00	62.9 PK	74.0	-11.1	1.24 H	352	57.50	5.40
4	5395.00	50.7 AV	54.0	-3.3	1.24 H	352	45.30	5.40
5	*5775.00	115.5 PK			1.18 H	352	76.90	38.60
6	*5775.00	105.1 AV			1.18 H	352	66.50	38.60
7	11550.00	62.3 PK	74.0	-11.7	1.15 H	20	41.90	20.40
8	11550.00	49.1 AV	54.0	-4.9	1.15 H	20	28.70	20.40

ANTENNA POLARITY & TEST DISTANCE: VERTICAL AT 3 M								
NO.	FREQ. (MHz)	EMISSION LEVEL (dBuV/m)	LIMIT (dBuV/m)	MARGIN (dB)	ANTENNA HEIGHT (m)	TABLE ANGLE (Degree)	RAW VALUE (dBuV)	CORRECTION FACTOR (dB/m)
1	5149.00	66.6 PK	74.0	-7.4	1.16 V	351	61.50	5.10
2	5149.00	52.5 AV	54.0	-1.5	1.16 V	351	47.40	5.10
3	5395.00	67.1 PK	74.0	-6.9	1.06 V	352	61.70	5.40
4	5395.00	52.8 AV	54.0	-1.2	1.06 V	352	47.40	5.40
5	*5775.00	120.4 PK			1.09 V	351	81.80	38.60
6	*5775.00	110.0 AV			1.09 V	351	71.40	38.60
7	11550.00	63.0 PK	74.0	-11.0	1.05 V	91	42.60	20.40
8	11550.00	49.4 AV	54.0	-4.6	1.05 V	91	29.00	20.40

REMARKS:

1. Emission Level(dBuV/m) = Raw Value(dBuV) + Correction Factor(dB/m)
2. Correction Factor(dB/m) = Antenna Factor(dB/m) + Cable Factor(dB) – Pre-Amplifier Factor(dB)
3. The other emission levels were very low against the limit.
4. Margin value = Emission Level – Limit value
5. “ * “: Fundamental frequency.
6. The limit value is defined as per 15.247.



802.11a

EUT TEST CONDITION		MEASUREMENT DETAIL	
CHANNEL	Channel 149	FREQUENCY RANGE	1 ~ 40GHz
INPUT POWER (SYSTEM)	120Vac, 60 Hz	DETECTOR FUNCTION	Peak (PK) Average (AV)
ENVIRONMENTAL CONDITIONS	25deg. C, 65%RH	TESTED BY	Jones Chang
TEST MODE	C		

ANTENNA POLARITY & TEST DISTANCE: HORIZONTAL AT 3 M								
NO.	FREQ. (MHz)	EMISSION LEVEL (dBuV/m)	LIMIT (dBuV/m)	MARGIN (dB)	ANTENNA HEIGHT (m)	TABLE ANGLE (Degree)	RAW VALUE (dBuV)	CORRECTION FACTOR (dB/m)
1	*5745.00	116.8 PK			1.21 H	344	78.30	38.50
2	*5745.00	105.5 AV			1.21 H	344	67.00	38.50
3	11490.00	62.2 PK	74.0	-11.8	1.26 H	310	41.80	20.40
4	11490.00	49.0 AV	54.0	-5.0	1.26 H	310	28.60	20.40
ANTENNA POLARITY & TEST DISTANCE: VERTICAL AT 3 M								
NO.	FREQ. (MHz)	EMISSION LEVEL (dBuV/m)	LIMIT (dBuV/m)	MARGIN (dB)	ANTENNA HEIGHT (m)	TABLE ANGLE (Degree)	RAW VALUE (dBuV)	CORRECTION FACTOR (dB/m)
1	*5745.00	121.7 PK			1.22 V	356	83.20	38.50
2	*5745.00	111.7 AV			1.22 V	356	73.20	38.50
3	11490.00	63.3 PK	74.0	-10.7	1.21 V	288	42.90	20.40
4	11490.00	50.3 AV	54.0	-3.7	1.21 V	288	29.90	20.40

REMARKS:

1. Emission Level(dBuV/m) = Raw Value(dBuV) + Correction Factor(dB/m)
2. Correction Factor(dB/m) = Antenna Factor(dB/m) + Cable Factor(dB) – Pre-Amplifier Factor(dB)
3. The other emission levels were very low against the limit.
4. Margin value = Emission Level – Limit value
5. “ * ”: Fundamental frequency.
6. The limit value is defined as per 15.247.



A D T

EUT TEST CONDITION		MEASUREMENT DETAIL	
CHANNEL	Channel 157	FREQUENCY RANGE	1 ~ 40GHz
INPUT POWER (SYSTEM)	120Vac, 60 Hz	DETECTOR FUNCTION	Peak (PK) Average (AV)
ENVIRONMENTAL CONDITIONS	25deg. C, 65%RH	TESTED BY	Jones Chang
TEST MODE	C		

ANTENNA POLARITY & TEST DISTANCE: HORIZONTAL AT 3 M								
NO.	FREQ. (MHz)	EMISSION LEVEL (dBuV/m)	LIMIT (dBuV/m)	MARGIN (dB)	ANTENNA HEIGHT (m)	TABLE ANGLE (Degree)	RAW VALUE (dBuV)	CORRECTION FACTOR (dB/m)
1	*5785.00	116.4 PK			1.34 H	350	77.80	38.60
2	*5785.00	105.8 AV			1.34 H	350	67.20	38.60
3	11570.00	61.7 PK	74.0	-12.3	1.30 H	200	41.30	20.40
4	11570.00	48.9 AV	54.0	-5.1	1.30 H	200	28.50	20.40
ANTENNA POLARITY & TEST DISTANCE: VERTICAL AT 3 M								
NO.	FREQ. (MHz)	EMISSION LEVEL (dBuV/m)	LIMIT (dBuV/m)	MARGIN (dB)	ANTENNA HEIGHT (m)	TABLE ANGLE (Degree)	RAW VALUE (dBuV)	CORRECTION FACTOR (dB/m)
1	*5785.00	122.8 PK			1.25 V	354	84.20	38.60
2	*5785.00	111.9 AV			1.25 V	354	73.30	38.60
3	11570.00	62.0 PK	74.0	-12.0	1.20 V	230	41.60	20.40
4	11570.00	49.2 AV	54.0	-4.8	1.20 V	230	28.80	20.40

REMARKS:

1. Emission Level(dBuV/m) = Raw Value(dBuV) + Correction Factor(dB/m)
2. Correction Factor(dB/m) = Antenna Factor(dB/m) + Cable Factor(dB) – Pre-Amplifier Factor(dB)
3. The other emission levels were very low against the limit.
4. Margin value = Emission Level – Limit value
5. “ * “: Fundamental frequency.
6. The limit value is defined as per 15.247.



A D T

EUT TEST CONDITION		MEASUREMENT DETAIL	
CHANNEL	Channel 165	FREQUENCY RANGE	1 ~ 40GHz
INPUT POWER (SYSTEM)	120Vac, 60 Hz	DETECTOR FUNCTION	Peak (PK) Average (AV)
ENVIRONMENTAL CONDITIONS	25deg. C, 65%RH	TESTED BY	Jones Chang
TEST MODE	C		

ANTENNA POLARITY & TEST DISTANCE: HORIZONTAL AT 3 M								
NO.	FREQ. (MHz)	EMISSION LEVEL (dBuV/m)	LIMIT (dBuV/m)	MARGIN (dB)	ANTENNA HEIGHT (m)	TABLE ANGLE (Degree)	RAW VALUE (dBuV)	CORRECTION FACTOR (dB/m)
1	*5825.00	115.5 PK			1.32 H	348	76.80	38.70
2	*5825.00	104.2 AV			1.32 H	348	65.50	38.70
3	11650.00	61.8 PK	74.0	-12.2	1.38 H	149	41.50	20.30
4	11650.00	48.6 AV	54.0	-5.4	1.38 H	149	28.30	20.30
ANTENNA POLARITY & TEST DISTANCE: VERTICAL AT 3 M								
NO.	FREQ. (MHz)	EMISSION LEVEL (dBuV/m)	LIMIT (dBuV/m)	MARGIN (dB)	ANTENNA HEIGHT (m)	TABLE ANGLE (Degree)	RAW VALUE (dBuV)	CORRECTION FACTOR (dB/m)
1	*5825.00	123.2 PK			1.00 V	354	84.50	38.70
2	*5825.00	113.1 AV			1.00 V	354	74.40	38.70
3	11650.00	62.0 PK	74.0	-12.0	1.19 V	179	41.70	20.30
4	11650.00	48.9 AV	54.0	-5.1	1.19 V	179	28.60	20.30

REMARKS:

1. Emission Level(dBuV/m) = Raw Value(dBuV) + Correction Factor(dB/m)
2. Correction Factor(dB/m) = Antenna Factor(dB/m) + Cable Factor(dB)
– Pre-Amplifier Factor(dB)
3. The other emission levels were very low against the limit.
4. Margin value = Emission Level – Limit value
5. “ * ”: Fundamental frequency.
6. The limit value is defined as per 15.247.



A D T

802.11n (20MHz)

EUT TEST CONDITION		MEASUREMENT DETAIL	
CHANNEL	Channel 149	FREQUENCY RANGE	1 ~ 40GHz
INPUT POWER (SYSTEM)	120Vac, 60 Hz	DETECTOR FUNCTION	Peak (PK) Average (AV)
ENVIRONMENTAL CONDITIONS	25deg. C, 65%RH	TESTED BY	Jones Chang
TEST MODE	C		

ANTENNA POLARITY & TEST DISTANCE: HORIZONTAL AT 3 M								
NO.	FREQ. (MHz)	EMISSION LEVEL (dBuV/m)	LIMIT (dBuV/m)	MARGIN (dB)	ANTENNA HEIGHT (m)	TABLE ANGLE (Degree)	RAW VALUE (dBuV)	CORRECTION FACTOR (dB/m)
1	*5745.00	113.0 PK			1.11 H	313	74.50	38.50
2	*5745.00	102.5 AV			1.11 H	313	64.00	38.50
3	11490.00	62.0 PK	74.0	-12.0	1.41 H	222	41.60	20.40
4	11490.00	48.4 AV	54.0	-5.6	1.41 H	222	28.00	20.40

ANTENNA POLARITY & TEST DISTANCE: VERTICAL AT 3 M								
NO.	FREQ. (MHz)	EMISSION LEVEL (dBuV/m)	LIMIT (dBuV/m)	MARGIN (dB)	ANTENNA HEIGHT (m)	TABLE ANGLE (Degree)	RAW VALUE (dBuV)	CORRECTION FACTOR (dB/m)
1	*5745.00	121.7 PK			1.10 V	351	83.20	38.50
2	*5745.00	111.7 AV			1.10 V	351	73.20	38.50
3	11490.00	62.2 PK	74.0	-11.8	1.01 V	292	41.80	20.40
4	11490.00	49.0 AV	54.0	-5.0	1.01 V	292	28.60	20.40

REMARKS:

1. Emission Level(dBuV/m) = Raw Value(dBuV) + Correction Factor(dB/m)
2. Correction Factor(dB/m) = Antenna Factor(dB/m) + Cable Factor(dB) – Pre-Amplifier Factor(dB)
3. The other emission levels were very low against the limit.
4. Margin value = Emission Level – Limit value
5. “ * “: Fundamental frequency.
6. The limit value is defined as per 15.247.



A D T

EUT TEST CONDITION		MEASUREMENT DETAIL	
CHANNEL	Channel 157	FREQUENCY RANGE	1 ~ 40GHz
INPUT POWER (SYSTEM)	120Vac, 60 Hz	DETECTOR FUNCTION	Peak (PK) Average (AV)
ENVIRONMENTAL CONDITIONS	25deg. C, 65%RH	TESTED BY	Jones Chang
TEST MODE	C		

ANTENNA POLARITY & TEST DISTANCE: HORIZONTAL AT 3 M								
NO.	FREQ. (MHz)	EMISSION LEVEL (dBuV/m)	LIMIT (dBuV/m)	MARGIN (dB)	ANTENNA HEIGHT (m)	TABLE ANGLE (Degree)	RAW VALUE (dBuV)	CORRECTION FACTOR (dB/m)
1	*5785.00	113.4 PK			1.05 H	303	74.80	38.60
2	*5785.00	102.9 AV			1.05 H	303	64.30	38.60
3	11570.00	61.5 PK	74.0	-12.5	1.26 H	322	41.10	20.40
4	11570.00	48.3 AV	54.0	-5.7	1.26 H	322	27.90	20.40
ANTENNA POLARITY & TEST DISTANCE: VERTICAL AT 3 M								
NO.	FREQ. (MHz)	EMISSION LEVEL (dBuV/m)	LIMIT (dBuV/m)	MARGIN (dB)	ANTENNA HEIGHT (m)	TABLE ANGLE (Degree)	RAW VALUE (dBuV)	CORRECTION FACTOR (dB/m)
1	*5785.00	122.0 PK			1.11 V	349	83.40	38.60
2	*5785.00	111.8 AV			1.11 V	349	73.20	38.60
3	11570.00	62.0 PK	74.0	-12.0	1.11 V	19	41.60	20.40
4	11570.00	48.7 AV	54.0	-5.3	1.11 V	19	28.30	20.40

REMARKS:

1. Emission Level(dBuV/m) = Raw Value(dBuV) + Correction Factor(dB/m)
2. Correction Factor(dB/m) = Antenna Factor(dB/m) + Cable Factor(dB) – Pre-Amplifier Factor(dB)
3. The other emission levels were very low against the limit.
4. Margin value = Emission Level – Limit value
5. “ * ”: Fundamental frequency.
6. The limit value is defined as per 15.247.



A D T

EUT TEST CONDITION		MEASUREMENT DETAIL	
CHANNEL	Channel 165	FREQUENCY RANGE	1 ~ 40GHz
INPUT POWER (SYSTEM)	120Vac, 60 Hz	DETECTOR FUNCTION	Peak (PK) Average (AV)
ENVIRONMENTAL CONDITIONS	25deg. C, 65%RH	TESTED BY	Jones Chang
TEST MODE	C		

ANTENNA POLARITY & TEST DISTANCE: HORIZONTAL AT 3 M								
NO.	FREQ. (MHz)	EMISSION LEVEL (dBuV/m)	LIMIT (dBuV/m)	MARGIN (dB)	ANTENNA HEIGHT (m)	TABLE ANGLE (Degree)	RAW VALUE (dBuV)	CORRECTION FACTOR (dB/m)
1	*5825.00	113.9 PK			1.18 H	302	75.20	38.70
2	*5825.00	103.9 AV			1.18 H	302	65.20	38.70
3	11650.00	61.0 PK	74.0	-13.0	1.40 H	258	40.70	20.30
4	11650.00	48.0 AV	54.0	-6.0	1.40 H	258	27.70	20.30
ANTENNA POLARITY & TEST DISTANCE: VERTICAL AT 3 M								
NO.	FREQ. (MHz)	EMISSION LEVEL (dBuV/m)	LIMIT (dBuV/m)	MARGIN (dB)	ANTENNA HEIGHT (m)	TABLE ANGLE (Degree)	RAW VALUE (dBuV)	CORRECTION FACTOR (dB/m)
1	*5825.00	122.3 PK			1.08 V	352	83.60	38.70
2	*5825.00	112.4 AV			1.08 V	352	73.70	38.70
3	11650.00	61.5 PK	74.0	-12.5	1.03 V	244	41.20	20.30
4	11650.00	48.4 AV	54.0	-5.6	1.03 V	244	28.10	20.30

REMARKS:

1. Emission Level(dBuV/m) = Raw Value(dBuV) + Correction Factor(dB/m)
2. Correction Factor(dB/m) = Antenna Factor(dB/m) + Cable Factor(dB)
– Pre-Amplifier Factor(dB)
3. The other emission levels were very low against the limit.
4. Margin value = Emission Level – Limit value
5. “ * “: Fundamental frequency.
6. The limit value is defined as per 15.247.



A D T

802.11n (40MHz)

EUT TEST CONDITION		MEASUREMENT DETAIL	
CHANNEL	Channel 151	FREQUENCY RANGE	1 ~ 40GHz
INPUT POWER (SYSTEM)	120Vac, 60 Hz	DETECTOR FUNCTION	Peak (PK) Average (AV)
ENVIRONMENTAL CONDITIONS	25deg. C, 65%RH	TESTED BY	Jones Chang
TEST MODE	C		

ANTENNA POLARITY & TEST DISTANCE: HORIZONTAL AT 3 M								
NO.	FREQ. (MHz)	EMISSION LEVEL (dBuV/m)	LIMIT (dBuV/m)	MARGIN (dB)	ANTENNA HEIGHT (m)	TABLE ANGLE (Degree)	RAW VALUE (dBuV)	CORRECTION FACTOR (dB/m)
1	*5755.00	112.8 PK			1.51 H	299	74.20	38.60
2	*5755.00	101.6 AV			1.51 H	299	63.00	38.60
3	11510.00	61.2 PK	74.0	-12.8	1.43 H	82	40.80	20.40
4	11510.00	47.7 AV	54.0	-6.3	1.43 H	82	27.30	20.40

ANTENNA POLARITY & TEST DISTANCE: VERTICAL AT 3 M								
NO.	FREQ. (MHz)	EMISSION LEVEL (dBuV/m)	LIMIT (dBuV/m)	MARGIN (dB)	ANTENNA HEIGHT (m)	TABLE ANGLE (Degree)	RAW VALUE (dBuV)	CORRECTION FACTOR (dB/m)
1	*5755.00	118.2 PK			1.00 V	352	79.60	38.60
2	*5755.00	108.6 AV			1.00 V	352	70.00	38.60
3	11510.00	61.4 PK	74.0	-12.6	1.23 V	271	41.00	20.40
4	11510.00	48.0 AV	54.0	-6.0	1.23 V	271	27.60	20.40

REMARKS:

1. Emission Level(dBuV/m) = Raw Value(dBuV) + Correction Factor(dB/m)
2. Correction Factor(dB/m) = Antenna Factor(dB/m) + Cable Factor(dB) – Pre-Amplifier Factor(dB)
3. The other emission levels were very low against the limit.
4. Margin value = Emission Level – Limit value
5. “ * “: Fundamental frequency.
6. The limit value is defined as per 15.247.



A D T

EUT TEST CONDITION		MEASUREMENT DETAIL	
CHANNEL	Channel 159	FREQUENCY RANGE	1 ~ 40GHz
INPUT POWER (SYSTEM)	120Vac, 60 Hz	DETECTOR FUNCTION	Peak (PK) Average (AV)
ENVIRONMENTAL CONDITIONS	25deg. C, 65%RH	TESTED BY	Jones Chang
TEST MODE	C		

ANTENNA POLARITY & TEST DISTANCE: HORIZONTAL AT 3 M								
NO.	FREQ. (MHz)	EMISSION LEVEL (dBuV/m)	LIMIT (dBuV/m)	MARGIN (dB)	ANTENNA HEIGHT (m)	TABLE ANGLE (Degree)	RAW VALUE (dBuV)	CORRECTION FACTOR (dB/m)
1	*5795.00	111.3 PK			1.48 H	298	72.70	38.60
2	*5795.00	101.4 AV			1.48 H	298	62.80	38.60
3	11590.00	61.4 PK	74.0	-12.6	1.52 H	323	41.00	20.40
4	11590.00	48.0 AV	54.0	-6.0	1.12 H	33	27.60	20.40
ANTENNA POLARITY & TEST DISTANCE: VERTICAL AT 3 M								
NO.	FREQ. (MHz)	EMISSION LEVEL (dBuV/m)	LIMIT (dBuV/m)	MARGIN (dB)	ANTENNA HEIGHT (m)	TABLE ANGLE (Degree)	RAW VALUE (dBuV)	CORRECTION FACTOR (dB/m)
1	*5795.00	118.1 PK			1.00 V	350	79.50	38.60
2	*5795.00	108.2 AV			1.00 V	350	69.60	38.60
3	11590.00	61.2 PK	74.0	-12.8	1.12 V	33	40.80	20.40
4	11590.00	48.4 AV	54.0	-5.6	1.12 V	33	28.00	20.40

REMARKS:

1. Emission Level(dBuV/m) = Raw Value(dBuV) + Correction Factor(dB/m)
2. Correction Factor(dB/m) = Antenna Factor(dB/m) + Cable Factor(dB)
– Pre-Amplifier Factor(dB)
3. The other emission levels were very low against the limit.
4. Margin value = Emission Level – Limit value
5. “ * ”: Fundamental frequency.
6. The limit value is defined as per 15.247.



A D T

802.11ac (80MHz)

EUT TEST CONDITION		MEASUREMENT DETAIL	
CHANNEL	Channel 155	FREQUENCY RANGE	1 ~ 40GHz
INPUT POWER (SYSTEM)	120Vac, 60 Hz	DETECTOR FUNCTION	Peak (PK) Average (AV)
ENVIRONMENTAL CONDITIONS	25deg. C, 65%RH	TESTED BY	Jones Chang
TEST MODE	C		

ANTENNA POLARITY & TEST DISTANCE: HORIZONTAL AT 3 M								
NO.	FREQ. (MHz)	EMISSION LEVEL (dBuV/m)	LIMIT (dBuV/m)	MARGIN (dB)	ANTENNA HEIGHT (m)	TABLE ANGLE (Degree)	RAW VALUE (dBuV)	CORRECTION FACTOR (dB/m)
1	*5775.00	109.5 PK			1.55 H	303	70.90	38.60
2	*5775.00	99.3 AV			1.55 H	303	60.70	38.60
3	11550.00	62.1 PK	74.0	-11.9	1.54 H	19	41.70	20.40
4	11550.00	49.2 AV	54.0	-4.8	1.54 H	19	28.80	20.40

ANTENNA POLARITY & TEST DISTANCE: VERTICAL AT 3 M								
NO.	FREQ. (MHz)	EMISSION LEVEL (dBuV/m)	LIMIT (dBuV/m)	MARGIN (dB)	ANTENNA HEIGHT (m)	TABLE ANGLE (Degree)	RAW VALUE (dBuV)	CORRECTION FACTOR (dB/m)
1	*5775.00	116.3 PK			1.00 V	352	77.70	38.60
2	*5775.00	106.6 AV			1.00 V	352	68.00	38.60
3	11550.00	61.5 PK	74.0	-12.5	1.05 V	194	41.10	20.40
4	11550.00	49.4 AV	54.0	-4.6	1.05 V	194	29.00	20.40

REMARKS:

1. Emission Level(dBuV/m) = Raw Value(dBuV) + Correction Factor(dB/m)
2. Correction Factor(dB/m) = Antenna Factor(dB/m) + Cable Factor(dB) – Pre-Amplifier Factor(dB)
3. The other emission levels were very low against the limit.
4. Margin value = Emission Level – Limit value
5. “ * “: Fundamental frequency.
6. The limit value is defined as per 15.247.



A D T

802.11a

EUT TEST CONDITION		MEASUREMENT DETAIL	
CHANNEL	Channel 149	FREQUENCY RANGE	1 ~ 40GHz
INPUT POWER (SYSTEM)	120Vac, 60 Hz	DETECTOR FUNCTION	Peak (PK) Average (AV)
ENVIRONMENTAL CONDITIONS	25deg. C, 65%RH	TESTED BY	Chris Lin
TEST MODE	D		

ANTENNA POLARITY & TEST DISTANCE: HORIZONTAL AT 3 M								
NO.	FREQ. (MHz)	EMISSION LEVEL (dBuV/m)	LIMIT (dBuV/m)	MARGIN (dB)	ANTENNA HEIGHT (m)	TABLE ANGLE (Degree)	RAW VALUE (dBuV)	CORRECTION FACTOR (dB/m)
1	*5745.00	114.3 PK			1.17 H	41	75.20	39.10
2	*5745.00	105.1 AV			1.17 H	41	66.00	39.10
3	11490.00	61.4 PK	74.0	-12.6	1.07 H	104	41.10	20.30
4	11490.00	49.4 AV	54.0	-4.6	1.07 H	104	29.10	20.30
ANTENNA POLARITY & TEST DISTANCE: VERTICAL AT 3 M								
NO.	FREQ. (MHz)	EMISSION LEVEL (dBuV/m)	LIMIT (dBuV/m)	MARGIN (dB)	ANTENNA HEIGHT (m)	TABLE ANGLE (Degree)	RAW VALUE (dBuV)	CORRECTION FACTOR (dB/m)
1	*5745.00	124.1 PK			1.14 V	1	85.00	39.10
2	*5745.00	114.4 AV			1.14 V	1	75.30	39.10
3	11490.00	63.2 PK	74.0	-10.8	1.00 V	2	42.90	20.30
4	11490.00	51.0 AV	54.0	-3.0	1.00 V	2	30.70	20.30

REMARKS:

1. Emission Level(dBuV/m) = Raw Value(dBuV) + Correction Factor(dB/m)
2. Correction Factor(dB/m) = Antenna Factor(dB/m) + Cable Factor(dB)
– Pre-Amplifier Factor(dB)
3. The other emission levels were very low against the limit.
4. Margin value = Emission Level – Limit value
5. “ * ”: Fundamental frequency.
6. The limit value is defined as per 15.247.



A D T

EUT TEST CONDITION		MEASUREMENT DETAIL	
CHANNEL	Channel 157	FREQUENCY RANGE	1 ~ 40GHz
INPUT POWER (SYSTEM)	120Vac, 60 Hz	DETECTOR FUNCTION	Peak (PK) Average (AV)
ENVIRONMENTAL CONDITIONS	25deg. C, 65%RH	TESTED BY	Chris Lin
TEST MODE	D		

ANTENNA POLARITY & TEST DISTANCE: HORIZONTAL AT 3 M								
NO.	FREQ. (MHz)	EMISSION LEVEL (dBuV/m)	LIMIT (dBuV/m)	MARGIN (dB)	ANTENNA HEIGHT (m)	TABLE ANGLE (Degree)	RAW VALUE (dBuV)	CORRECTION FACTOR (dB/m)
1	*5785.00	115.3 PK			1.18 H	42	76.10	39.20
2	*5785.00	105.6 AV			1.18 H	42	66.40	39.20
3	11570.00	61.5 PK	74.0	-12.5	1.09 H	138	41.40	20.10
4	11570.00	49.4 AV	54.0	-4.6	1.09 H	138	29.30	20.10
ANTENNA POLARITY & TEST DISTANCE: VERTICAL AT 3 M								
NO.	FREQ. (MHz)	EMISSION LEVEL (dBuV/m)	LIMIT (dBuV/m)	MARGIN (dB)	ANTENNA HEIGHT (m)	TABLE ANGLE (Degree)	RAW VALUE (dBuV)	CORRECTION FACTOR (dB/m)
1	*5785.00	123.2 PK			1.08 V	1	84.00	39.20
2	*5785.00	113.4 AV			1.08 V	1	74.20	39.20
3	11570.00	64.3 PK	74.0	-9.7	1.00 V	6	44.20	20.10
4	11570.00	51.5 AV	54.0	-2.5	1.00 V	6	31.40	20.10

REMARKS:

1. Emission Level(dBuV/m) = Raw Value(dBuV) + Correction Factor(dB/m)
2. Correction Factor(dB/m) = Antenna Factor(dB/m) + Cable Factor(dB)
– Pre-Amplifier Factor(dB)
3. The other emission levels were very low against the limit.
4. Margin value = Emission Level – Limit value
5. “ * “: Fundamental frequency.
6. The limit value is defined as per 15.247.



A D T

EUT TEST CONDITION		MEASUREMENT DETAIL	
CHANNEL	Channel 165	FREQUENCY RANGE	1 ~ 40GHz
INPUT POWER (SYSTEM)	120Vac, 60 Hz	DETECTOR FUNCTION	Peak (PK) Average (AV)
ENVIRONMENTAL CONDITIONS	25deg. C, 65%RH	TESTED BY	Chris Lin
TEST MODE	D		

ANTENNA POLARITY & TEST DISTANCE: HORIZONTAL AT 3 M								
NO.	FREQ. (MHz)	EMISSION LEVEL (dBuV/m)	LIMIT (dBuV/m)	MARGIN (dB)	ANTENNA HEIGHT (m)	TABLE ANGLE (Degree)	RAW VALUE (dBuV)	CORRECTION FACTOR (dB/m)
1	*5825.00	116.4 PK			1.07 H	40	77.10	39.30
2	*5825.00	106.3 AV			1.07 H	40	67.00	39.30
3	11650.00	63.1 PK	74.0	-10.9	1.35 H	10	43.40	19.70
4	11650.00	49.6 AV	54.0	-4.4	1.35 H	10	29.90	19.70
ANTENNA POLARITY & TEST DISTANCE: VERTICAL AT 3 M								
NO.	FREQ. (MHz)	EMISSION LEVEL (dBuV/m)	LIMIT (dBuV/m)	MARGIN (dB)	ANTENNA HEIGHT (m)	TABLE ANGLE (Degree)	RAW VALUE (dBuV)	CORRECTION FACTOR (dB/m)
1	*5825.00	123.1 PK			1.00 V	8	83.80	39.30
2	*5825.00	113.1 AV			1.00 V	8	73.80	39.30
3	11650.00	63.2 PK	74.0	-10.8	1.04 V	360	43.50	19.70
4	11650.00	51.8 AV	54.0	-2.2	1.04 V	360	32.10	19.70

REMARKS:

1. Emission Level(dBuV/m) = Raw Value(dBuV) + Correction Factor(dB/m)
2. Correction Factor(dB/m) = Antenna Factor(dB/m) + Cable Factor(dB)
– Pre-Amplifier Factor(dB)
3. The other emission levels were very low against the limit.
4. Margin value = Emission Level – Limit value
5. “ * “: Fundamental frequency.
6. The limit value is defined as per 15.247.



A D T

802.11n (20MHz)

EUT TEST CONDITION		MEASUREMENT DETAIL	
CHANNEL	Channel 149	FREQUENCY RANGE	1 ~ 40GHz
INPUT POWER (SYSTEM)	120Vac, 60 Hz	DETECTOR FUNCTION	Peak (PK) Average (AV)
ENVIRONMENTAL CONDITIONS	25deg. C, 65%RH	TESTED BY	Chris Lin
TEST MODE	D		

ANTENNA POLARITY & TEST DISTANCE: HORIZONTAL AT 3 M								
NO.	FREQ. (MHz)	EMISSION LEVEL (dBuV/m)	LIMIT (dBuV/m)	MARGIN (dB)	ANTENNA HEIGHT (m)	TABLE ANGLE (Degree)	RAW VALUE (dBuV)	CORRECTION FACTOR (dB/m)
1	*5745.00	113.6 PK			1.28 H	35	74.50	39.10
2	*5745.00	104.0 AV			1.28 H	35	64.90	39.10
3	11490.00	61.3 PK	74.0	-12.7	1.05 H	131	41.00	20.30
4	11490.00	48.8 AV	54.0	-5.2	1.05 H	131	28.50	20.30

ANTENNA POLARITY & TEST DISTANCE: VERTICAL AT 3 M								
NO.	FREQ. (MHz)	EMISSION LEVEL (dBuV/m)	LIMIT (dBuV/m)	MARGIN (dB)	ANTENNA HEIGHT (m)	TABLE ANGLE (Degree)	RAW VALUE (dBuV)	CORRECTION FACTOR (dB/m)
1	*5745.00	123.4 PK			1.18 V	5	84.30	39.10
2	*5745.00	114.0 AV			1.18 V	5	74.90	39.10
3	11490.00	62.4 PK	74.0	-11.6	1.54 V	331	42.10	20.30
4	11490.00	49.8 AV	54.0	-4.2	1.54 V	331	29.50	20.30

REMARKS:

1. Emission Level(dBuV/m) = Raw Value(dBuV) + Correction Factor(dB/m)
2. Correction Factor(dB/m) = Antenna Factor(dB/m) + Cable Factor(dB) – Pre-Amplifier Factor(dB)
3. The other emission levels were very low against the limit.
4. Margin value = Emission Level – Limit value
5. “ * “: Fundamental frequency.
6. The limit value is defined as per 15.247.



A D T

EUT TEST CONDITION		MEASUREMENT DETAIL	
CHANNEL	Channel 157	FREQUENCY RANGE	1 ~ 40GHz
INPUT POWER (SYSTEM)	120Vac, 60 Hz	DETECTOR FUNCTION	Peak (PK) Average (AV)
ENVIRONMENTAL CONDITIONS	25deg. C, 65%RH	TESTED BY	Chris Lin
TEST MODE	D		

ANTENNA POLARITY & TEST DISTANCE: HORIZONTAL AT 3 M								
NO.	FREQ. (MHz)	EMISSION LEVEL (dBuV/m)	LIMIT (dBuV/m)	MARGIN (dB)	ANTENNA HEIGHT (m)	TABLE ANGLE (Degree)	RAW VALUE (dBuV)	CORRECTION FACTOR (dB/m)
1	*5785.00	115.1 PK			1.17 H	40	75.90	39.20
2	*5785.00	105.0 AV			1.17 H	40	65.80	39.20
3	11570.00	61.0 PK	74.0	-13.0	1.18 H	306	40.90	20.10
4	11570.00	51.1 AV	54.0	-2.9	1.18 H	306	31.00	20.10
ANTENNA POLARITY & TEST DISTANCE: VERTICAL AT 3 M								
NO.	FREQ. (MHz)	EMISSION LEVEL (dBuV/m)	LIMIT (dBuV/m)	MARGIN (dB)	ANTENNA HEIGHT (m)	TABLE ANGLE (Degree)	RAW VALUE (dBuV)	CORRECTION FACTOR (dB/m)
1	*5785.00	123.3 PK			1.12 V	357	84.10	39.20
2	*5785.00	113.6 AV			1.12 V	357	74.40	39.20
3	11570.00	61.3 PK	74.0	-12.7	1.15 V	96	41.20	20.10
4	11570.00	52.1 AV	54.0	-1.9	1.15 V	96	32.00	20.10

REMARKS:

1. Emission Level(dBuV/m) = Raw Value(dBuV) + Correction Factor(dB/m)
2. Correction Factor(dB/m) = Antenna Factor(dB/m) + Cable Factor(dB) – Pre-Amplifier Factor(dB)
3. The other emission levels were very low against the limit.
4. Margin value = Emission Level – Limit value
5. “ * ”: Fundamental frequency.
6. The limit value is defined as per 15.247.



A D T

EUT TEST CONDITION		MEASUREMENT DETAIL	
CHANNEL	Channel 165	FREQUENCY RANGE	1 ~ 40GHz
INPUT POWER (SYSTEM)	120Vac, 60 Hz	DETECTOR FUNCTION	Peak (PK) Average (AV)
ENVIRONMENTAL CONDITIONS	25deg. C, 65%RH	TESTED BY	Chris Lin
TEST MODE	D		

ANTENNA POLARITY & TEST DISTANCE: HORIZONTAL AT 3 M								
NO.	FREQ. (MHz)	EMISSION LEVEL (dBuV/m)	LIMIT (dBuV/m)	MARGIN (dB)	ANTENNA HEIGHT (m)	TABLE ANGLE (Degree)	RAW VALUE (dBuV)	CORRECTION FACTOR (dB/m)
1	*5825.00	114.8 PK			1.17 H	35	75.50	39.30
2	*5825.00	104.7 AV			1.17 H	35	65.40	39.30
3	11650.00	61.7 PK	74.0	-12.3	1.19 H	227	42.00	19.70
4	11650.00	52.1 AV	54.0	-1.9	1.19 H	227	32.40	19.70
ANTENNA POLARITY & TEST DISTANCE: VERTICAL AT 3 M								
NO.	FREQ. (MHz)	EMISSION LEVEL (dBuV/m)	LIMIT (dBuV/m)	MARGIN (dB)	ANTENNA HEIGHT (m)	TABLE ANGLE (Degree)	RAW VALUE (dBuV)	CORRECTION FACTOR (dB/m)
1	*5825.00	124.3 PK			1.08 V	2	85.00	39.30
2	*5825.00	114.0 AV			1.08 V	2	74.70	39.30
3	11650.00	61.3 PK	74.0	-12.7	1.15 V	20	41.60	19.70
4	11650.00	50.9 AV	54.0	-3.1	1.15 V	20	31.20	19.70

REMARKS:

1. Emission Level(dBuV/m) = Raw Value(dBuV) + Correction Factor(dB/m)
2. Correction Factor(dB/m) = Antenna Factor(dB/m) + Cable Factor(dB) – Pre-Amplifier Factor(dB)
3. The other emission levels were very low against the limit.
4. Margin value = Emission Level – Limit value
5. “ * ”: Fundamental frequency.
6. The limit value is defined as per 15.247.



A D T

802.11n (40MHz)

EUT TEST CONDITION		MEASUREMENT DETAIL	
CHANNEL	Channel 151	FREQUENCY RANGE	1 ~ 40GHz
INPUT POWER (SYSTEM)	120Vac, 60 Hz	DETECTOR FUNCTION	Peak (PK) Average (AV)
ENVIRONMENTAL CONDITIONS	25deg. C, 65%RH	TESTED BY	Chris Lin
TEST MODE	D		

ANTENNA POLARITY & TEST DISTANCE: HORIZONTAL AT 3 M								
NO.	FREQ. (MHz)	EMISSION LEVEL (dBuV/m)	LIMIT (dBuV/m)	MARGIN (dB)	ANTENNA HEIGHT (m)	TABLE ANGLE (Degree)	RAW VALUE (dBuV)	CORRECTION FACTOR (dB/m)
1	*5755.00	111.0 PK			1.32 H	40	71.80	39.20
2	*5755.00	101.9 AV			1.32 H	40	62.70	39.20
3	11510.00	61.9 PK	74.0	-12.1	1.20 H	54	41.60	20.30
4	11510.00	50.8 AV	54.0	-3.2	1.20 H	54	30.50	20.30

ANTENNA POLARITY & TEST DISTANCE: VERTICAL AT 3 M								
NO.	FREQ. (MHz)	EMISSION LEVEL (dBuV/m)	LIMIT (dBuV/m)	MARGIN (dB)	ANTENNA HEIGHT (m)	TABLE ANGLE (Degree)	RAW VALUE (dBuV)	CORRECTION FACTOR (dB/m)
1	*5755.00	120.3 PK			1.08 V	2	81.10	39.20
2	*5755.00	110.7 AV			1.08 V	2	71.50	39.20
3	11510.00	62.2 PK	74.0	-11.8	1.15 V	230	41.90	20.30
4	11510.00	50.7 AV	54.0	-3.3	1.15 V	230	30.40	20.30

REMARKS:

1. Emission Level(dBuV/m) = Raw Value(dBuV) + Correction Factor(dB/m)
2. Correction Factor(dB/m) = Antenna Factor(dB/m) + Cable Factor(dB) – Pre-Amplifier Factor(dB)
3. The other emission levels were very low against the limit.
4. Margin value = Emission Level – Limit value
5. “ * “: Fundamental frequency.
6. The limit value is defined as per 15.247.



A D T

EUT TEST CONDITION		MEASUREMENT DETAIL	
CHANNEL	Channel 159	FREQUENCY RANGE	1 ~ 40GHz
INPUT POWER (SYSTEM)	120Vac, 60 Hz	DETECTOR FUNCTION	Peak (PK) Average (AV)
ENVIRONMENTAL CONDITIONS	25deg. C, 65%RH	TESTED BY	Chris Lin
TEST MODE	D		

ANTENNA POLARITY & TEST DISTANCE: HORIZONTAL AT 3 M								
NO.	FREQ. (MHz)	EMISSION LEVEL (dBuV/m)	LIMIT (dBuV/m)	MARGIN (dB)	ANTENNA HEIGHT (m)	TABLE ANGLE (Degree)	RAW VALUE (dBuV)	CORRECTION FACTOR (dB/m)
1	*5795.00	111.1 PK			1.15 H	37	71.90	39.20
2	*5795.00	101.4 AV			1.15 H	37	62.20	39.20
3	11590.00	61.7 PK	74.0	-12.3	1.47 H	52	41.60	20.10
4	11590.00	50.5 AV	54.0	-3.5	1.47 H	52	30.40	20.10
ANTENNA POLARITY & TEST DISTANCE: VERTICAL AT 3 M								
NO.	FREQ. (MHz)	EMISSION LEVEL (dBuV/m)	LIMIT (dBuV/m)	MARGIN (dB)	ANTENNA HEIGHT (m)	TABLE ANGLE (Degree)	RAW VALUE (dBuV)	CORRECTION FACTOR (dB/m)
1	*5795.00	119.7 PK			1.00 V	360	80.50	39.20
2	*5795.00	110.2 AV			1.00 V	360	71.00	39.20
3	11590.00	61.7 PK	74.0	-12.3	1.15 V	20	41.60	20.10
4	11590.00	50.5 AV	54.0	-3.5	1.15 V	20	30.40	20.10

REMARKS:

1. Emission Level(dBuV/m) = Raw Value(dBuV) + Correction Factor(dB/m)
2. Correction Factor(dB/m) = Antenna Factor(dB/m) + Cable Factor(dB)
– Pre-Amplifier Factor(dB)
3. The other emission levels were very low against the limit.
4. Margin value = Emission Level – Limit value
5. “ * “: Fundamental frequency.
6. The limit value is defined as per 15.247.



A D T

802.11ac (80MHz)

EUT TEST CONDITION		MEASUREMENT DETAIL	
CHANNEL	Channel 155	FREQUENCY RANGE	1 ~ 40GHz
INPUT POWER (SYSTEM)	120Vac, 60 Hz	DETECTOR FUNCTION	Peak (PK) Average (AV)
ENVIRONMENTAL CONDITIONS	25deg. C, 65%RH	TESTED BY	Chris Lin
TEST MODE	D		

ANTENNA POLARITY & TEST DISTANCE: HORIZONTAL AT 3 M								
NO.	FREQ. (MHz)	EMISSION LEVEL (dBuV/m)	LIMIT (dBuV/m)	MARGIN (dB)	ANTENNA HEIGHT (m)	TABLE ANGLE (Degree)	RAW VALUE (dBuV)	CORRECTION FACTOR (dB/m)
1	*5775.00	109.3 PK			1.17 H	43	70.10	39.20
2	*5775.00	98.5 AV			1.17 H	43	59.30	39.20
3	11550.00	60.7 PK	74.0	-13.3	1.04 H	228	40.50	20.20
4	11550.00	51.2 AV	54.0	-2.8	1.04 H	228	31.00	20.20

ANTENNA POLARITY & TEST DISTANCE: VERTICAL AT 3 M								
NO.	FREQ. (MHz)	EMISSION LEVEL (dBuV/m)	LIMIT (dBuV/m)	MARGIN (dB)	ANTENNA HEIGHT (m)	TABLE ANGLE (Degree)	RAW VALUE (dBuV)	CORRECTION FACTOR (dB/m)
1	*5775.00	117.4 PK			1.06 V	5	78.20	39.20
2	*5775.00	107.8 AV			1.06 V	5	68.60	39.20
3	11550.00	61.4 PK	74.0	-12.6	1.14 V	60	41.20	20.20
4	11550.00	50.6 AV	54.0	-3.4	1.14 V	60	30.40	20.20

REMARKS:

1. Emission Level(dBuV/m) = Raw Value(dBuV) + Correction Factor(dB/m)
2. Correction Factor(dB/m) = Antenna Factor(dB/m) + Cable Factor(dB) – Pre-Amplifier Factor(dB)
3. The other emission levels were very low against the limit.
4. Margin value = Emission Level – Limit value
5. “ * “: Fundamental frequency.
6. The limit value is defined as per 15.247.



A D T

802.11a

EUT TEST CONDITION		MEASUREMENT DETAIL	
CHANNEL	Channel 149	FREQUENCY RANGE	1 ~ 40GHz
INPUT POWER (SYSTEM)	120Vac, 60 Hz	DETECTOR FUNCTION	Peak (PK) Average (AV)
ENVIRONMENTAL CONDITIONS	25deg. C, 65%RH	TESTED BY	Chris Lin
TEST MODE	E		

ANTENNA POLARITY & TEST DISTANCE: HORIZONTAL AT 3 M								
NO.	FREQ. (MHz)	EMISSION LEVEL (dBuV/m)	LIMIT (dBuV/m)	MARGIN (dB)	ANTENNA HEIGHT (m)	TABLE ANGLE (Degree)	RAW VALUE (dBuV)	CORRECTION FACTOR (dB/m)
1	*5745.00	110.5 PK			1.36 H	88	72.00	38.50
2	*5745.00	99.9 AV			1.36 H	88	61.40	38.50
3	11490.00	66.5 PK	74.0	-7.5	1.40 H	243	46.10	20.40
4	11490.00	52.3 AV	54.0	-1.7	1.40 H	243	31.90	20.40
ANTENNA POLARITY & TEST DISTANCE: VERTICAL AT 3 M								
NO.	FREQ. (MHz)	EMISSION LEVEL (dBuV/m)	LIMIT (dBuV/m)	MARGIN (dB)	ANTENNA HEIGHT (m)	TABLE ANGLE (Degree)	RAW VALUE (dBuV)	CORRECTION FACTOR (dB/m)
1	*5745.00	121.5 PK			1.08 V	220	83.00	38.50
2	*5745.00	111.1 AV			1.08 V	220	72.60	38.50
3	11490.00	66.8 PK	74.0	-7.2	1.39 V	305	46.40	20.40
4	11490.00	52.5 AV	54.0	-1.5	1.39 V	305	32.10	20.40

REMARKS:

1. Emission Level(dBuV/m) = Raw Value(dBuV) + Correction Factor(dB/m)
2. Correction Factor(dB/m) = Antenna Factor(dB/m) + Cable Factor(dB) – Pre-Amplifier Factor(dB)
3. The other emission levels were very low against the limit.
4. Margin value = Emission Level – Limit value
5. “ * ”: Fundamental frequency.
6. The limit value is defined as per 15.247.



A D T

EUT TEST CONDITION		MEASUREMENT DETAIL	
CHANNEL	Channel 157	FREQUENCY RANGE	1 ~ 40GHz
INPUT POWER (SYSTEM)	120Vac, 60 Hz	DETECTOR FUNCTION	Peak (PK) Average (AV)
ENVIRONMENTAL CONDITIONS	25deg. C, 65%RH	TESTED BY	Chris Lin
TEST MODE	E		

ANTENNA POLARITY & TEST DISTANCE: HORIZONTAL AT 3 M								
NO.	FREQ. (MHz)	EMISSION LEVEL (dBuV/m)	LIMIT (dBuV/m)	MARGIN (dB)	ANTENNA HEIGHT (m)	TABLE ANGLE (Degree)	RAW VALUE (dBuV)	CORRECTION FACTOR (dB/m)
1	*5785.00	106.4 PK			1.00 H	76	67.80	38.60
2	*5785.00	95.8 AV			1.00 H	76	57.20	38.60
3	11570.00	66.0 PK	74.0	-8.0	1.39 H	247	45.60	20.40
4	11570.00	51.7 AV	54.0	-2.3	1.39 H	247	31.30	20.40
ANTENNA POLARITY & TEST DISTANCE: VERTICAL AT 3 M								
NO.	FREQ. (MHz)	EMISSION LEVEL (dBuV/m)	LIMIT (dBuV/m)	MARGIN (dB)	ANTENNA HEIGHT (m)	TABLE ANGLE (Degree)	RAW VALUE (dBuV)	CORRECTION FACTOR (dB/m)
1	*5785.00	121.1 PK			1.08 V	163	82.50	38.60
2	*5785.00	110.5 AV			1.08 V	163	71.90	38.60
3	11570.00	67.6 PK	74.0	-6.4	1.42 V	309	47.20	20.40
4	11570.00	52.9 AV	54.0	-1.1	1.42 V	309	32.50	20.40

REMARKS:

1. Emission Level(dBuV/m) = Raw Value(dBuV) + Correction Factor(dB/m)
2. Correction Factor(dB/m) = Antenna Factor(dB/m) + Cable Factor(dB) – Pre-Amplifier Factor(dB)
3. The other emission levels were very low against the limit.
4. Margin value = Emission Level – Limit value
5. “ * “: Fundamental frequency.
6. The limit value is defined as per 15.247.



A D T

EUT TEST CONDITION		MEASUREMENT DETAIL	
CHANNEL	Channel 165	FREQUENCY RANGE	1 ~ 40GHz
INPUT POWER (SYSTEM)	120Vac, 60 Hz	DETECTOR FUNCTION	Peak (PK) Average (AV)
ENVIRONMENTAL CONDITIONS	25deg. C, 65%RH	TESTED BY	Chris Lin
TEST MODE	E		

ANTENNA POLARITY & TEST DISTANCE: HORIZONTAL AT 3 M								
NO.	FREQ. (MHz)	EMISSION LEVEL (dBuV/m)	LIMIT (dBuV/m)	MARGIN (dB)	ANTENNA HEIGHT (m)	TABLE ANGLE (Degree)	RAW VALUE (dBuV)	CORRECTION FACTOR (dB/m)
1	*5825.00	110.2 PK			1.36 H	94	71.50	38.70
2	*5825.00	100.2 AV			1.36 H	94	61.50	38.70
3	11650.00	67.5 PK	74.0	-6.5	1.54 H	244	47.20	20.30
4	11650.00	53.0 AV	54.0	-1.0	1.54 H	244	32.70	20.30
ANTENNA POLARITY & TEST DISTANCE: VERTICAL AT 3 M								
NO.	FREQ. (MHz)	EMISSION LEVEL (dBuV/m)	LIMIT (dBuV/m)	MARGIN (dB)	ANTENNA HEIGHT (m)	TABLE ANGLE (Degree)	RAW VALUE (dBuV)	CORRECTION FACTOR (dB/m)
1	*5825.00	119.7 PK			1.07 V	353	81.00	38.70
2	*5825.00	108.9 AV			1.07 V	353	70.20	38.70
3	11650.00	66.7 PK	74.0	-7.3	1.42 V	309	46.40	20.30
4	11650.00	52.4 AV	54.0	-1.6	1.42 V	309	32.10	20.30

REMARKS:

1. Emission Level(dBuV/m) = Raw Value(dBuV) + Correction Factor(dB/m)
2. Correction Factor(dB/m) = Antenna Factor(dB/m) + Cable Factor(dB)
– Pre-Amplifier Factor(dB)
3. The other emission levels were very low against the limit.
4. Margin value = Emission Level – Limit value
5. “ * “: Fundamental frequency.
6. The limit value is defined as per 15.247.



A D T

802.11n (20MHz)

EUT TEST CONDITION		MEASUREMENT DETAIL	
CHANNEL	Channel 149	FREQUENCY RANGE	1 ~ 40GHz
INPUT POWER (SYSTEM)	120Vac, 60 Hz	DETECTOR FUNCTION	Peak (PK) Average (AV)
ENVIRONMENTAL CONDITIONS	25deg. C, 65%RH	TESTED BY	Chris Lin
TEST MODE	E		

ANTENNA POLARITY & TEST DISTANCE: HORIZONTAL AT 3 M								
NO.	FREQ. (MHz)	EMISSION LEVEL (dBuV/m)	LIMIT (dBuV/m)	MARGIN (dB)	ANTENNA HEIGHT (m)	TABLE ANGLE (Degree)	RAW VALUE (dBuV)	CORRECTION FACTOR (dB/m)
1	*5745.00	110.2 PK			1.40 H	92	71.70	38.50
2	*5745.00	100.0 AV			1.40 H	92	61.50	38.50
3	11490.00	65.4 PK	74.0	-8.6	1.41 H	219	45.00	20.40
4	11490.00	52.3 AV	54.0	-1.7	1.41 H	219	31.90	20.40

ANTENNA POLARITY & TEST DISTANCE: VERTICAL AT 3 M								
NO.	FREQ. (MHz)	EMISSION LEVEL (dBuV/m)	LIMIT (dBuV/m)	MARGIN (dB)	ANTENNA HEIGHT (m)	TABLE ANGLE (Degree)	RAW VALUE (dBuV)	CORRECTION FACTOR (dB/m)
1	*5745.00	118.4 PK			1.00 V	343	79.90	38.50
2	*5745.00	108.2 AV			1.00 V	343	69.70	38.50
3	11490.00	67.5 PK	74.0	-6.5	1.35 V	324	47.10	20.40
4	11490.00	52.7 AV	54.0	-1.3	1.35 V	324	32.30	20.40

REMARKS:

1. Emission Level(dBuV/m) = Raw Value(dBuV) + Correction Factor(dB/m)
2. Correction Factor(dB/m) = Antenna Factor(dB/m) + Cable Factor(dB) – Pre-Amplifier Factor(dB)
3. The other emission levels were very low against the limit.
4. Margin value = Emission Level – Limit value
5. “ * “: Fundamental frequency.
6. The limit value is defined as per 15.247.



A D T

EUT TEST CONDITION		MEASUREMENT DETAIL	
CHANNEL	Channel 157	FREQUENCY RANGE	1 ~ 40GHz
INPUT POWER (SYSTEM)	120Vac, 60 Hz	DETECTOR FUNCTION	Peak (PK) Average (AV)
ENVIRONMENTAL CONDITIONS	25deg. C, 65%RH	TESTED BY	Chris Lin
TEST MODE	E		

ANTENNA POLARITY & TEST DISTANCE: HORIZONTAL AT 3 M								
NO.	FREQ. (MHz)	EMISSION LEVEL (dBuV/m)	LIMIT (dBuV/m)	MARGIN (dB)	ANTENNA HEIGHT (m)	TABLE ANGLE (Degree)	RAW VALUE (dBuV)	CORRECTION FACTOR (dB/m)
1	*5785.00	110.4 PK			1.51 H	88	71.80	38.60
2	*5785.00	100.3 AV			1.51 H	88	61.70	38.60
3	11570.00	67.1 PK	74.0	-6.9	1.75 H	218	46.70	20.40
4	11570.00	52.7 AV	54.0	-1.3	1.75 H	218	32.30	20.40
ANTENNA POLARITY & TEST DISTANCE: VERTICAL AT 3 M								
NO.	FREQ. (MHz)	EMISSION LEVEL (dBuV/m)	LIMIT (dBuV/m)	MARGIN (dB)	ANTENNA HEIGHT (m)	TABLE ANGLE (Degree)	RAW VALUE (dBuV)	CORRECTION FACTOR (dB/m)
1	*5785.00	118.9 PK			1.06 V	357	80.30	38.60
2	*5785.00	109.2 AV			1.06 V	357	70.60	38.60
3	11570.00	66.5 PK	74.0	-7.5	1.40 V	324	46.10	20.40
4	11570.00	52.5 AV	54.0	-1.5	1.40 V	324	32.10	20.40

REMARKS:

1. Emission Level(dBuV/m) = Raw Value(dBuV) + Correction Factor(dB/m)
2. Correction Factor(dB/m) = Antenna Factor(dB/m) + Cable Factor(dB)
– Pre-Amplifier Factor(dB)
3. The other emission levels were very low against the limit.
4. Margin value = Emission Level – Limit value
5. “ * “: Fundamental frequency.
6. The limit value is defined as per 15.247.



A D T

EUT TEST CONDITION		MEASUREMENT DETAIL	
CHANNEL	Channel 165	FREQUENCY RANGE	1 ~ 40GHz
INPUT POWER (SYSTEM)	120Vac, 60 Hz	DETECTOR FUNCTION	Peak (PK) Average (AV)
ENVIRONMENTAL CONDITIONS	25deg. C, 65%RH	TESTED BY	Chris Lin
TEST MODE	E		

ANTENNA POLARITY & TEST DISTANCE: HORIZONTAL AT 3 M								
NO.	FREQ. (MHz)	EMISSION LEVEL (dBuV/m)	LIMIT (dBuV/m)	MARGIN (dB)	ANTENNA HEIGHT (m)	TABLE ANGLE (Degree)	RAW VALUE (dBuV)	CORRECTION FACTOR (dB/m)
1	*5825.00	110.6 PK			1.49 H	95	71.90	38.70
2	*5825.00	100.7 AV			1.49 H	95	62.00	38.70
3	11650.00	66.6 PK	74.0	-7.4	1.50 H	243	46.30	20.30
4	11650.00	52.0 AV	54.0	-2.0	1.50 H	243	31.70	20.30
ANTENNA POLARITY & TEST DISTANCE: VERTICAL AT 3 M								
NO.	FREQ. (MHz)	EMISSION LEVEL (dBuV/m)	LIMIT (dBuV/m)	MARGIN (dB)	ANTENNA HEIGHT (m)	TABLE ANGLE (Degree)	RAW VALUE (dBuV)	CORRECTION FACTOR (dB/m)
1	*5825.00	118.9 PK			1.06 V	351	80.20	38.70
2	*5825.00	109.0 AV			1.06 V	351	70.30	38.70
3	11650.00	67.1 PK	74.0	-6.9	1.45 V	324	46.80	20.30
4	11650.00	52.9 AV	54.0	-1.1	1.45 V	324	32.60	20.30

REMARKS:

1. Emission Level(dBuV/m) = Raw Value(dBuV) + Correction Factor(dB/m)
2. Correction Factor(dB/m) = Antenna Factor(dB/m) + Cable Factor(dB) – Pre-Amplifier Factor(dB)
3. The other emission levels were very low against the limit.
4. Margin value = Emission Level – Limit value
5. “ * “: Fundamental frequency.
6. The limit value is defined as per 15.247.



A D T

802.11n (40MHz)

EUT TEST CONDITION		MEASUREMENT DETAIL	
CHANNEL	Channel 151	FREQUENCY RANGE	1 ~ 40GHz
INPUT POWER (SYSTEM)	120Vac, 60 Hz	DETECTOR FUNCTION	Peak (PK) Average (AV)
ENVIRONMENTAL CONDITIONS	25deg. C, 65%RH	TESTED BY	Chris Lin
TEST MODE	E		

ANTENNA POLARITY & TEST DISTANCE: HORIZONTAL AT 3 M								
NO.	FREQ. (MHz)	EMISSION LEVEL (dBuV/m)	LIMIT (dBuV/m)	MARGIN (dB)	ANTENNA HEIGHT (m)	TABLE ANGLE (Degree)	RAW VALUE (dBuV)	CORRECTION FACTOR (dB/m)
1	*5755.00	106.7 PK			1.37 H	92	68.10	38.60
2	*5755.00	96.9 AV			1.37 H	92	58.30	38.60
3	11510.00	63.4 PK	74.0	-10.6	1.37 H	222	43.00	20.40
4	11510.00	50.6 AV	54.0	-3.4	1.37 H	222	30.20	20.40

ANTENNA POLARITY & TEST DISTANCE: VERTICAL AT 3 M								
NO.	FREQ. (MHz)	EMISSION LEVEL (dBuV/m)	LIMIT (dBuV/m)	MARGIN (dB)	ANTENNA HEIGHT (m)	TABLE ANGLE (Degree)	RAW VALUE (dBuV)	CORRECTION FACTOR (dB/m)
1	*5755.00	115.2 PK			1.07 V	347	76.60	38.60
2	*5755.00	105.4 AV			1.07 V	347	66.80	38.60
3	11510.00	65.8 PK	74.0	-8.2	1.34 V	324	45.40	20.40
4	11510.00	52.6 AV	54.0	-1.4	1.34 V	324	32.20	20.40

REMARKS:

1. Emission Level(dBuV/m) = Raw Value(dBuV) + Correction Factor(dB/m)
2. Correction Factor(dB/m) = Antenna Factor(dB/m) + Cable Factor(dB) – Pre-Amplifier Factor(dB)
3. The other emission levels were very low against the limit.
4. Margin value = Emission Level – Limit value
5. “ * “: Fundamental frequency.
6. The limit value is defined as per 15.247.



A D T

EUT TEST CONDITION		MEASUREMENT DETAIL	
CHANNEL	Channel 159	FREQUENCY RANGE	1 ~ 40GHz
INPUT POWER (SYSTEM)	120Vac, 60 Hz	DETECTOR FUNCTION	Peak (PK) Average (AV)
ENVIRONMENTAL CONDITIONS	25deg. C, 65%RH	TESTED BY	Chris Lin
TEST MODE	E		

ANTENNA POLARITY & TEST DISTANCE: HORIZONTAL AT 3 M								
NO.	FREQ. (MHz)	EMISSION LEVEL (dBuV/m)	LIMIT (dBuV/m)	MARGIN (dB)	ANTENNA HEIGHT (m)	TABLE ANGLE (Degree)	RAW VALUE (dBuV)	CORRECTION FACTOR (dB/m)
1	*5795.00	108.9 PK			1.34 H	92	70.30	38.60
2	*5795.00	98.6 AV			1.34 H	92	60.00	38.60
3	11590.00	65.2 PK	74.0	-8.8	1.42 H	245	44.80	20.40
4	11590.00	52.1 AV	54.0	-1.9	1.42 H	245	31.70	20.40
ANTENNA POLARITY & TEST DISTANCE: VERTICAL AT 3 M								
NO.	FREQ. (MHz)	EMISSION LEVEL (dBuV/m)	LIMIT (dBuV/m)	MARGIN (dB)	ANTENNA HEIGHT (m)	TABLE ANGLE (Degree)	RAW VALUE (dBuV)	CORRECTION FACTOR (dB/m)
1	*5795.00	116.2 PK			1.06 V	349	77.60	38.60
2	*5795.00	106.5 AV			1.06 V	349	67.90	38.60
3	11590.00	66.0 PK	74.0	-8.0	1.39 V	308	45.60	20.40
4	11590.00	52.7 AV	54.0	-1.3	1.39 V	308	32.30	20.40

REMARKS:

1. Emission Level(dBuV/m) = Raw Value(dBuV) + Correction Factor(dB/m)
2. Correction Factor(dB/m) = Antenna Factor(dB/m) + Cable Factor(dB) – Pre-Amplifier Factor(dB)
3. The other emission levels were very low against the limit.
4. Margin value = Emission Level – Limit value
5. “ * ”: Fundamental frequency.
6. The limit value is defined as per 15.247.



A D T

802.11ac (80MHz)

EUT TEST CONDITION		MEASUREMENT DETAIL	
CHANNEL	Channel 155	FREQUENCY RANGE	1 ~ 40GHz
INPUT POWER (SYSTEM)	120Vac, 60 Hz	DETECTOR FUNCTION	Peak (PK) Average (AV)
ENVIRONMENTAL CONDITIONS	25deg. C, 65%RH	TESTED BY	Chris Lin
TEST MODE	E		

ANTENNA POLARITY & TEST DISTANCE: HORIZONTAL AT 3 M								
NO.	FREQ. (MHz)	EMISSION LEVEL (dBuV/m)	LIMIT (dBuV/m)	MARGIN (dB)	ANTENNA HEIGHT (m)	TABLE ANGLE (Degree)	RAW VALUE (dBuV)	CORRECTION FACTOR (dB/m)
1	*5775.00	107.5 PK			1.40 H	93	68.90	38.60
2	*5775.00	98.0 AV			1.40 H	93	59.40	38.60
3	11550.00	64.8 PK	74.0	-9.2	1.39 H	245	44.40	20.40
4	11550.00	52.5 AV	54.0	-1.5	1.39 H	245	32.10	20.40

ANTENNA POLARITY & TEST DISTANCE: VERTICAL AT 3 M								
NO.	FREQ. (MHz)	EMISSION LEVEL (dBuV/m)	LIMIT (dBuV/m)	MARGIN (dB)	ANTENNA HEIGHT (m)	TABLE ANGLE (Degree)	RAW VALUE (dBuV)	CORRECTION FACTOR (dB/m)
1	*5775.00	116.1 PK			1.07 V	350	77.50	38.60
2	*5775.00	106.8 AV			1.07 V	350	68.20	38.60
3	11550.00	65.0 PK	74.0	-9.0	1.39 V	325	44.60	20.40
4	11550.00	52.6 AV	54.0	-1.4	1.39 V	325	32.20	20.40

REMARKS:

1. Emission Level(dBuV/m) = Raw Value(dBuV) + Correction Factor(dB/m)
2. Correction Factor(dB/m) = Antenna Factor(dB/m) + Cable Factor(dB) – Pre-Amplifier Factor(dB)
3. The other emission levels were very low against the limit.
4. Margin value = Emission Level – Limit value
5. “ * “: Fundamental frequency.
6. The limit value is defined as per 15.247.



A D T

802.11a

EUT TEST CONDITION		MEASUREMENT DETAIL	
CHANNEL	Channel 149	FREQUENCY RANGE	1 ~ 40GHz
INPUT POWER (SYSTEM)	120Vac, 60 Hz	DETECTOR FUNCTION	Peak (PK) Average (AV)
ENVIRONMENTAL CONDITIONS	25deg. C, 65%RH	TESTED BY	Ted Chang
TEST MODE	F		

ANTENNA POLARITY & TEST DISTANCE: HORIZONTAL AT 3 M								
NO.	FREQ. (MHz)	EMISSION LEVEL (dBuV/m)	LIMIT (dBuV/m)	MARGIN (dB)	ANTENNA HEIGHT (m)	TABLE ANGLE (Degree)	RAW VALUE (dBuV)	CORRECTION FACTOR (dB/m)
1	5423.00	56.3 PK	74.0	-17.7	1.06 H	67	53.70	2.60
2	5423.00	44.9 AV	54.0	-9.1	1.06 H	67	42.30	2.60
3	*5745.00	108.5 PK			1.26 H	82	68.20	40.30
4	*5745.00	98.0 AV			1.26 H	82	57.70	40.30
5	11490.00	61.1 PK	74.0	-12.9	1.05 H	84	45.20	15.90
6	11490.00	48.4 AV	54.0	-5.6	1.05 H	84	32.50	15.90

ANTENNA POLARITY & TEST DISTANCE: VERTICAL AT 3 M								
NO.	FREQ. (MHz)	EMISSION LEVEL (dBuV/m)	LIMIT (dBuV/m)	MARGIN (dB)	ANTENNA HEIGHT (m)	TABLE ANGLE (Degree)	RAW VALUE (dBuV)	CORRECTION FACTOR (dB/m)
1	5423.00	62.5 PK	74.0	-11.5	1.09 V	66	59.90	2.60
2	5423.00	50.1 AV	54.0	-3.9	1.09 V	66	47.50	2.60
3	*5745.00	123.0 PK			1.44 V	70	82.70	40.30
4	*5745.00	112.5 AV			1.44 V	70	72.20	40.30
5	11490.00	66.3 PK	74.0	-7.7	1.74 V	47	50.40	15.90
6	11490.00	52.3 AV	54.0	-1.7	1.74 V	47	36.40	15.90

REMARKS:

- Emission Level(dBuV/m) = Raw Value(dBuV) + Correction Factor(dB/m)
- Correction Factor(dB/m) = Antenna Factor(dB/m) + Cable Factor(dB)
– Pre-Amplifier Factor(dB)
- The other emission levels were very low against the limit.
- Margin value = Emission Level – Limit value
- " * ": Fundamental frequency.
- The limit value is defined as per 15.247.
- "#":The radiated frequency is out the restricted band.



A D T

EUT TEST CONDITION		MEASUREMENT DETAIL	
CHANNEL	Channel 157	FREQUENCY RANGE	1 ~ 40GHz
INPUT POWER (SYSTEM)	120Vac, 60 Hz	DETECTOR FUNCTION	Peak (PK) Average (AV)
ENVIRONMENTAL CONDITIONS	25deg. C, 65%RH	TESTED BY	Ted Chang
TEST MODE	F		

ANTENNA POLARITY & TEST DISTANCE: HORIZONTAL AT 3 M								
NO.	FREQ. (MHz)	EMISSION LEVEL (dBuV/m)	LIMIT (dBuV/m)	MARGIN (dB)	ANTENNA HEIGHT (m)	TABLE ANGLE (Degree)	RAW VALUE (dBuV)	CORRECTION FACTOR (dB/m)
1	*5785.00	106.2 PK			1.13 H	82	65.90	40.30
2	*5785.00	95.2 AV			1.13 H	82	54.90	40.30
3	11570.00	61.1 PK	74.0	-12.9	1.62 H	84	45.20	15.90
4	11570.00	48.5 AV	54.0	-5.5	1.62 H	84	32.60	15.90
ANTENNA POLARITY & TEST DISTANCE: VERTICAL AT 3 M								
NO.	FREQ. (MHz)	EMISSION LEVEL (dBuV/m)	LIMIT (dBuV/m)	MARGIN (dB)	ANTENNA HEIGHT (m)	TABLE ANGLE (Degree)	RAW VALUE (dBuV)	CORRECTION FACTOR (dB/m)
1	*5785.00	118.5 PK			1.54 V	50	78.20	40.30
2	*5785.00	108.1 AV			1.54 V	50	67.80	40.30
3	11570.00	65.7 PK	74.0	-8.3	1.00 V	42	49.80	15.90
4	11570.00	50.9 AV	54.0	-3.1	1.00 V	42	35.00	15.90

REMARKS:

1. Emission Level(dBuV/m) = Raw Value(dBuV) + Correction Factor(dB/m)
2. Correction Factor(dB/m) = Antenna Factor(dB/m) + Cable Factor(dB)
– Pre-Amplifier Factor(dB)
3. The other emission levels were very low against the limit.
4. Margin value = Emission Level – Limit value
5. “ * ”: Fundamental frequency.
6. The limit value is defined as per 15.247.



A D T

EUT TEST CONDITION		MEASUREMENT DETAIL	
CHANNEL	Channel 165	FREQUENCY RANGE	1 ~ 40GHz
INPUT POWER (SYSTEM)	120Vac, 60 Hz	DETECTOR FUNCTION	Peak (PK) Average (AV)
ENVIRONMENTAL CONDITIONS	25deg. C, 65%RH	TESTED BY	Ted Chang
TEST MODE	F		

ANTENNA POLARITY & TEST DISTANCE: HORIZONTAL AT 3 M								
NO.	FREQ. (MHz)	EMISSION LEVEL (dBuV/m)	LIMIT (dBuV/m)	MARGIN (dB)	ANTENNA HEIGHT (m)	TABLE ANGLE (Degree)	RAW VALUE (dBuV)	CORRECTION FACTOR (dB/m)
1	5460.00	58.5 PK	74.0	-15.5	1.05 H	24	55.70	2.80
2	5460.00	45.1 AV	54.0	-8.9	1.05 H	24	42.30	2.80
3	*5825.00	106.8 PK			1.12 H	84	66.30	40.50
4	*5825.00	95.5 AV			1.12 H	84	55.00	40.50
5	#5850.00	75.0 PK	76.8	-1.8	1.20 H	68	34.50	40.50
6	#5850.00	63.8 AV	65.5	-1.7	1.20 H	68	23.30	40.50
7	11650.00	61.2 PK	74.0	-12.8	1.55 H	52	45.30	15.90
8	11650.00	48.1 AV	54.0	-5.9	1.55 H	52	32.20	15.90

ANTENNA POLARITY & TEST DISTANCE: VERTICAL AT 3 M								
NO.	FREQ. (MHz)	EMISSION LEVEL (dBuV/m)	LIMIT (dBuV/m)	MARGIN (dB)	ANTENNA HEIGHT (m)	TABLE ANGLE (Degree)	RAW VALUE (dBuV)	CORRECTION FACTOR (dB/m)
1	5460.00	65.1 PK	74.0	-8.9	1.16 V	77	62.30	2.80
2	5460.00	51.3 AV	54.0	-2.7	1.16 V	77	48.50	2.80
3	*5825.00	118.1 PK			1.08 V	44	77.60	40.50
4	*5825.00	107.4 AV			1.08 V	44	66.90	40.50
5	#5850.00	86.3 PK	88.1	-1.8	1.20 V	68	45.80	40.50
6	#5850.00	75.7 AV	77.4	-1.7	1.20 V	68	35.20	40.50
7	11650.00	63.8 PK	74.0	-10.2	1.00 V	39	47.90	15.90
8	11650.00	50.8 AV	54.0	-3.2	1.00 V	39	34.90	15.90

REMARKS:

- Emission Level(dBuV/m) = Raw Value(dBuV) + Correction Factor(dB/m)
- Correction Factor(dB/m) = Antenna Factor(dB/m) + Cable Factor(dB) – Pre-Amplifier Factor(dB)
- The other emission levels were very low against the limit.
- Margin value = Emission Level – Limit value
- " * ": Fundamental frequency.
- The limit value is defined as per 15.247.
- "#":The radiated frequency is out the restricted band.



A D T

802.11n (20MHz)

EUT TEST CONDITION		MEASUREMENT DETAIL	
CHANNEL	Channel 149	FREQUENCY RANGE	1 ~ 40GHz
INPUT POWER (SYSTEM)	120Vac, 60 Hz	DETECTOR FUNCTION	Peak (PK) Average (AV)
ENVIRONMENTAL CONDITIONS	25deg. C, 65%RH	TESTED BY	Ted Chang
TEST MODE	F		

ANTENNA POLARITY & TEST DISTANCE: HORIZONTAL AT 3 M								
NO.	FREQ. (MHz)	EMISSION LEVEL (dBuV/m)	LIMIT (dBuV/m)	MARGIN (dB)	ANTENNA HEIGHT (m)	TABLE ANGLE (Degree)	RAW VALUE (dBuV)	CORRECTION FACTOR (dB/m)
1	*5745.00	108.2 PK			1.26 H	85	67.90	40.30
2	*5745.00	97.7 AV			1.26 H	85	57.40	40.30
3	11490.00	61.5 PK	74.0	-12.5	1.57 H	48	45.60	15.90
4	11490.00	48.1 AV	54.0	-5.9	1.57 H	48	32.20	15.90

ANTENNA POLARITY & TEST DISTANCE: VERTICAL AT 3 M								
NO.	FREQ. (MHz)	EMISSION LEVEL (dBuV/m)	LIMIT (dBuV/m)	MARGIN (dB)	ANTENNA HEIGHT (m)	TABLE ANGLE (Degree)	RAW VALUE (dBuV)	CORRECTION FACTOR (dB/m)
1	*5745.00	122.7 PK			1.45 V	70	82.40	40.30
2	*5745.00	112.2 AV			1.45 V	70	71.90	40.30
3	11490.00	66.2 PK	74.0	-7.8	1.60 V	47	50.30	15.90
4	11490.00	51.3 AV	54.0	-2.7	1.60 V	47	35.40	15.90

REMARKS:

1. Emission Level(dBuV/m) = Raw Value(dBuV) + Correction Factor(dB/m)
2. Correction Factor(dB/m) = Antenna Factor(dB/m) + Cable Factor(dB) – Pre-Amplifier Factor(dB)
3. The other emission levels were very low against the limit.
4. Margin value = Emission Level – Limit value
5. “ * “: Fundamental frequency.
6. The limit value is defined as per 15.247.
7. "#":The radiated frequency is out the restricted band.



A D T

EUT TEST CONDITION		MEASUREMENT DETAIL	
CHANNEL	Channel 157	FREQUENCY RANGE	1 ~ 40GHz
INPUT POWER (SYSTEM)	120Vac, 60 Hz	DETECTOR FUNCTION	Peak (PK) Average (AV)
ENVIRONMENTAL CONDITIONS	25deg. C, 65%RH	TESTED BY	Ted Chang
TEST MODE	F		

ANTENNA POLARITY & TEST DISTANCE: HORIZONTAL AT 3 M								
NO.	FREQ. (MHz)	EMISSION LEVEL (dBuV/m)	LIMIT (dBuV/m)	MARGIN (dB)	ANTENNA HEIGHT (m)	TABLE ANGLE (Degree)	RAW VALUE (dBuV)	CORRECTION FACTOR (dB/m)
1	5460.00	57.2 PK	74.0	-16.8	1.05 H	84	54.40	2.80
2	5460.00	45.3 AV	54.0	-8.7	1.05 H	84	42.50	2.80
3	*5785.00	107.8 PK			1.28 H	83	67.50	40.30
4	*5785.00	97.2 AV			1.28 H	83	56.90	40.30
5	11570.00	61.1 PK	74.0	-12.9	1.11 H	229	45.20	15.90
6	11570.00	48.2 AV	54.0	-5.8	1.11 H	229	32.30	15.90

ANTENNA POLARITY & TEST DISTANCE: VERTICAL AT 3 M								
NO.	FREQ. (MHz)	EMISSION LEVEL (dBuV/m)	LIMIT (dBuV/m)	MARGIN (dB)	ANTENNA HEIGHT (m)	TABLE ANGLE (Degree)	RAW VALUE (dBuV)	CORRECTION FACTOR (dB/m)
1	5460.00	63.1 PK	74.0	-10.9	1.10 V	52	60.30	2.80
2	5460.00	50.7 AV	54.0	-3.3	1.10 V	52	47.90	2.80
3	*5785.00	122.4 PK			1.42 V	70	82.10	40.30
4	*5785.00	111.4 AV			1.42 V	70	71.10	40.30
5	11570.00	64.3 PK	74.0	-9.7	1.00 V	45	48.40	15.90
6	11570.00	50.2 AV	54.0	-3.8	1.00 V	45	34.30	15.90

REMARKS:

1. Emission Level(dBuV/m) = Raw Value(dBuV) + Correction Factor(dB/m)
2. Correction Factor(dB/m) = Antenna Factor(dB/m) + Cable Factor(dB)
– Pre-Amplifier Factor(dB)
3. The other emission levels were very low against the limit.
4. Margin value = Emission Level – Limit value
5. “ * “: Fundamental frequency.
6. The limit value is defined as per 15.247.



A D T

EUT TEST CONDITION		MEASUREMENT DETAIL	
CHANNEL	Channel 165	FREQUENCY RANGE	1 ~ 40GHz
INPUT POWER (SYSTEM)	120Vac, 60 Hz	DETECTOR FUNCTION	Peak (PK) Average (AV)
ENVIRONMENTAL CONDITIONS	25deg. C, 65%RH	TESTED BY	Ted Chang
TEST MODE	F		

ANTENNA POLARITY & TEST DISTANCE: HORIZONTAL AT 3 M								
NO.	FREQ. (MHz)	EMISSION LEVEL (dBuV/m)	LIMIT (dBuV/m)	MARGIN (dB)	ANTENNA HEIGHT (m)	TABLE ANGLE (Degree)	RAW VALUE (dBuV)	CORRECTION FACTOR (dB/m)
1	5460.00	59.7 PK	74.0	-14.3	1.00 H	51	56.90	2.80
2	5460.00	45.1 AV	54.0	-8.9	1.00 H	51	42.30	2.80
3	*5825.00	105.8 PK			1.10 H	84	65.30	40.50
4	*5825.00	94.3 AV			1.10 H	84	53.80	40.50
5	#5850.00	74.1 PK	75.8	-1.7	1.51 H	51	33.60	40.50
6	#5850.00	62.6 AV	64.3	-1.7	1.51 H	51	22.10	40.50
7	11650.00	60.4 PK	74.0	-13.6	1.89 H	97	44.50	15.90
8	11650.00	48.1 AV	54.0	-5.9	1.89 H	97	32.20	15.90

ANTENNA POLARITY & TEST DISTANCE: VERTICAL AT 3 M								
NO.	FREQ. (MHz)	EMISSION LEVEL (dBuV/m)	LIMIT (dBuV/m)	MARGIN (dB)	ANTENNA HEIGHT (m)	TABLE ANGLE (Degree)	RAW VALUE (dBuV)	CORRECTION FACTOR (dB/m)
1	5460.00	63.9 PK	74.0	-10.1	1.18 V	68	61.10	2.80
2	5460.00	51.1 AV	54.0	-2.9	1.18 V	68	48.30	2.80
3	*5825.00	117.9 PK			1.09 V	50	77.40	40.50
4	*5825.00	107.4 AV			1.09 V	50	66.90	40.50
5	#5850.00	86.2 PK	87.9	-1.7	1.51 V	51	45.70	40.50
6	#5850.00	75.7 AV	77.4	-1.7	1.51 V	51	35.20	40.50
7	11650.00	64.9 PK	74.0	-9.1	1.05 V	9	49.00	15.90
8	11650.00	50.4 AV	54.0	-3.6	1.05 V	9	34.50	15.90

REMARKS:

- Emission Level(dBuV/m) = Raw Value(dBuV) + Correction Factor(dB/m)
- Correction Factor(dB/m) = Antenna Factor(dB/m) + Cable Factor(dB) – Pre-Amplifier Factor(dB)
- The other emission levels were very low against the limit.
- Margin value = Emission Level – Limit value
- " * ": Fundamental frequency.
- The limit value is defined as per 15.247.
- "#":The radiated frequency is out the restricted band.



A D T

802.11n (40MHz)

EUT TEST CONDITION		MEASUREMENT DETAIL	
CHANNEL	Channel 151	FREQUENCY RANGE	1 ~ 40GHz
INPUT POWER (SYSTEM)	120Vac, 60 Hz	DETECTOR FUNCTION	Peak (PK) Average (AV)
ENVIRONMENTAL CONDITIONS	25deg. C, 65%RH	TESTED BY	Ted Chang
TEST MODE	F		

ANTENNA POLARITY & TEST DISTANCE: HORIZONTAL AT 3 M								
NO.	FREQ. (MHz)	EMISSION LEVEL (dBuV/m)	LIMIT (dBuV/m)	MARGIN (dB)	ANTENNA HEIGHT (m)	TABLE ANGLE (Degree)	RAW VALUE (dBuV)	CORRECTION FACTOR (dB/m)
1	5460.00	58.3 PK	74.0	-15.7	1.18 H	264	55.50	2.80
2	5460.00	46.0 AV	54.0	-8.0	1.18 H	264	43.20	2.80
3	*5755.00	105.2 PK			1.26 H	82	64.90	40.30
4	*5755.00	94.4 AV			1.26 H	82	54.10	40.30
5	11510.00	61.5 PK	74.0	-12.5	1.00 H	62	45.60	15.90
6	11510.00	48.4 AV	54.0	-5.6	1.00 H	62	32.50	15.90
ANTENNA POLARITY & TEST DISTANCE: VERTICAL AT 3 M								
NO.	FREQ. (MHz)	EMISSION LEVEL (dBuV/m)	LIMIT (dBuV/m)	MARGIN (dB)	ANTENNA HEIGHT (m)	TABLE ANGLE (Degree)	RAW VALUE (dBuV)	CORRECTION FACTOR (dB/m)
1	5460.00	62.8 PK	74.0	-11.2	1.08 V	62	60.00	2.80
2	5460.00	49.8 AV	54.0	-4.2	1.08 V	62	47.00	2.80
3	*5755.00	119.0 PK			1.42 V	71	78.70	40.30
4	*5755.00	108.8 AV			1.42 V	71	68.50	40.30
5	11510.00	64.2 PK	74.0	-9.8	1.67 V	47	48.30	15.90
6	11510.00	51.1 AV	54.0	-2.9	1.67 V	47	35.20	15.90

REMARKS:

1. Emission Level(dBuV/m) = Raw Value(dBuV) + Correction Factor(dB/m)
2. Correction Factor(dB/m) = Antenna Factor(dB/m) + Cable Factor(dB) – Pre-Amplifier Factor(dB)
3. The other emission levels were very low against the limit.
4. Margin value = Emission Level – Limit value
5. “ * “: Fundamental frequency.
6. The limit value is defined as per 15.247.
7. "#":The radiated frequency is out the restricted band.



A D T

EUT TEST CONDITION		MEASUREMENT DETAIL	
CHANNEL	Channel 159	FREQUENCY RANGE	1 ~ 40GHz
INPUT POWER (SYSTEM)	120Vac, 60 Hz	DETECTOR FUNCTION	Peak (PK) Average (AV)
ENVIRONMENTAL CONDITIONS	25deg. C, 65%RH	TESTED BY	Ted Chang
TEST MODE	F		

ANTENNA POLARITY & TEST DISTANCE: HORIZONTAL AT 3 M								
NO.	FREQ. (MHz)	EMISSION LEVEL (dBuV/m)	LIMIT (dBuV/m)	MARGIN (dB)	ANTENNA HEIGHT (m)	TABLE ANGLE (Degree)	RAW VALUE (dBuV)	CORRECTION FACTOR (dB/m)
1	*5795.00	105.0 PK			1.28 H	82	64.60	40.40
2	*5795.00	94.6 AV			1.28 H	82	54.20	40.40
3	#5850.00	68.1 PK	75.0	-6.9	1.18 H	68	27.60	40.50
4	#5850.00	57.7 AV	64.6	-6.9	1.18 H	68	17.20	40.50
5	11590.00	61.1 PK	74.0	-12.9	1.32 H	224	45.30	15.80
6	11590.00	48.1 AV	54.0	-5.9	1.32 H	224	32.30	15.80

ANTENNA POLARITY & TEST DISTANCE: VERTICAL AT 3 M								
NO.	FREQ. (MHz)	EMISSION LEVEL (dBuV/m)	LIMIT (dBuV/m)	MARGIN (dB)	ANTENNA HEIGHT (m)	TABLE ANGLE (Degree)	RAW VALUE (dBuV)	CORRECTION FACTOR (dB/m)
1	*5795.00	118.9 PK			1.42 V	70	78.50	40.40
2	*5795.00	108.2 AV			1.42 V	70	67.80	40.40
3	#5850.00	82.0 PK	88.9	-6.9	1.18 V	68	41.50	40.50
4	#5850.00	71.3 AV	78.2	-6.9	1.18 V	68	30.80	40.50
5	11590.00	61.9 PK	74.0	-12.1	1.00 V	43	46.10	15.80
6	11590.00	49.0 AV	54.0	-5.0	1.00 V	43	33.20	15.80

REMARKS:

1. Emission Level(dBuV/m) = Raw Value(dBuV) + Correction Factor(dB/m)
2. Correction Factor(dB/m) = Antenna Factor(dB/m) + Cable Factor(dB)
– Pre-Amplifier Factor(dB)
3. The other emission levels were very low against the limit.
4. Margin value = Emission Level – Limit value
5. “ * “: Fundamental frequency.
6. The limit value is defined as per 15.247.
7. "#":The radiated frequency is out the restricted band.



A D T

802.11ac (80MHz)

EUT TEST CONDITION		MEASUREMENT DETAIL	
CHANNEL	Channel 155	FREQUENCY RANGE	1 ~ 40GHz
INPUT POWER (SYSTEM)	120Vac, 60 Hz	DETECTOR FUNCTION	Peak (PK) Average (AV)
ENVIRONMENTAL CONDITIONS	25deg. C, 65%RH	TESTED BY	Chris Lin
TEST MODE	F		

ANTENNA POLARITY & TEST DISTANCE: HORIZONTAL AT 3 M								
NO.	FREQ. (MHz)	EMISSION LEVEL (dBuV/m)	LIMIT (dBuV/m)	MARGIN (dB)	ANTENNA HEIGHT (m)	TABLE ANGLE (Degree)	RAW VALUE (dBuV)	CORRECTION FACTOR (dB/m)
1	*5775.00	101.1 PK			1.31 H	82	60.80	40.30
2	*5775.00	91.2 AV			1.31 H	82	50.90	40.30
3	11550.00	61.1 PK	74.0	-12.9	1.03 H	352	45.20	15.90
4	11550.00	48.2 AV	54.0	-5.8	1.03 H	352	32.30	15.90

ANTENNA POLARITY & TEST DISTANCE: VERTICAL AT 3 M								
NO.	FREQ. (MHz)	EMISSION LEVEL (dBuV/m)	LIMIT (dBuV/m)	MARGIN (dB)	ANTENNA HEIGHT (m)	TABLE ANGLE (Degree)	RAW VALUE (dBuV)	CORRECTION FACTOR (dB/m)
1	*5775.00	115.0 PK			1.42 V	73	74.70	40.30
2	*5775.00	105.5 AV			1.42 V	73	65.20	40.30
3	11550.00	62.5 PK	74.0	-11.5	1.07 V	45	46.60	15.90
4	11550.00	50.2 AV	54.0	-3.8	1.07 V	45	34.30	15.90

REMARKS:

1. Emission Level(dBuV/m) = Raw Value(dBuV) + Correction Factor(dB/m)
2. Correction Factor(dB/m) = Antenna Factor(dB/m) + Cable Factor(dB) – Pre-Amplifier Factor(dB)
3. The other emission levels were very low against the limit.
4. Margin value = Emission Level – Limit value
5. " * " : Fundamental frequency.
6. The limit value is defined as per 15.247.
7. " # " : The radiated frequency is out of the restricted band.



A D T

802.11a

EUT TEST CONDITION		MEASUREMENT DETAIL	
CHANNEL	Channel 149	FREQUENCY RANGE	1 ~ 40GHz
INPUT POWER (SYSTEM)	120Vac, 60 Hz	DETECTOR FUNCTION	Peak (PK) Average (AV)
ENVIRONMENTAL CONDITIONS	25deg. C, 65%RH	TESTED BY	Jones Chang
TEST MODE	G		

ANTENNA POLARITY & TEST DISTANCE: HORIZONTAL AT 3 M								
NO.	FREQ. (MHz)	EMISSION LEVEL (dBuV/m)	LIMIT (dBuV/m)	MARGIN (dB)	ANTENNA HEIGHT (m)	TABLE ANGLE (Degree)	RAW VALUE (dBuV)	CORRECTION FACTOR (dB/m)
1	*5745.00	124.3 PK			1.00 H	356	85.80	38.50
2	*5745.00	114.7 AV			1.00 H	356	76.20	38.50
3	11490.00	67.1 PK	74.0	-6.9	1.45 H	351	46.70	20.40
4	11490.00	52.5 AV	54.0	-1.5	1.45 H	351	32.10	20.40
ANTENNA POLARITY & TEST DISTANCE: VERTICAL AT 3 M								
NO.	FREQ. (MHz)	EMISSION LEVEL (dBuV/m)	LIMIT (dBuV/m)	MARGIN (dB)	ANTENNA HEIGHT (m)	TABLE ANGLE (Degree)	RAW VALUE (dBuV)	CORRECTION FACTOR (dB/m)
1	*5745.00	116.0 PK			1.00 V	144	77.50	38.50
2	*5745.00	105.2 AV			1.00 V	144	66.70	38.50
3	11490.00	65.6 PK	74.0	-8.4	1.85 V	135	45.20	20.40
4	11490.00	52.1 AV	54.0	-1.9	1.85 V	135	31.70	20.40

REMARKS:

1. Emission Level(dBuV/m) = Raw Value(dBuV) + Correction Factor(dB/m)
2. Correction Factor(dB/m) = Antenna Factor(dB/m) + Cable Factor(dB) – Pre-Amplifier Factor(dB)
3. The other emission levels were very low against the limit.
4. Margin value = Emission Level – Limit value
5. “ * “: Fundamental frequency.
6. The limit value is defined as per 15.247.



A D T

EUT TEST CONDITION		MEASUREMENT DETAIL	
CHANNEL	Channel 157	FREQUENCY RANGE	1 ~ 40GHz
INPUT POWER (SYSTEM)	120Vac, 60 Hz	DETECTOR FUNCTION	Peak (PK) Average (AV)
ENVIRONMENTAL CONDITIONS	25deg. C, 65%RH	TESTED BY	Jones Chang
TEST MODE	G		

ANTENNA POLARITY & TEST DISTANCE: HORIZONTAL AT 3 M								
NO.	FREQ. (MHz)	EMISSION LEVEL (dBuV/m)	LIMIT (dBuV/m)	MARGIN (dB)	ANTENNA HEIGHT (m)	TABLE ANGLE (Degree)	RAW VALUE (dBuV)	CORRECTION FACTOR (dB/m)
1	*5745.00	123.4 PK			1.07 H	351	84.90	38.50
2	*5745.00	113.0 AV			1.07 H	351	74.50	38.50
3	11570.00	67.0 PK	74.0	-7.0	1.66 H	349	46.60	20.40
4	11570.00	52.9 AV	54.0	-1.1	1.66 H	349	32.50	20.40
ANTENNA POLARITY & TEST DISTANCE: VERTICAL AT 3 M								
NO.	FREQ. (MHz)	EMISSION LEVEL (dBuV/m)	LIMIT (dBuV/m)	MARGIN (dB)	ANTENNA HEIGHT (m)	TABLE ANGLE (Degree)	RAW VALUE (dBuV)	CORRECTION FACTOR (dB/m)
1	*5785.00	113.5 PK			1.00 V	144	74.90	38.60
2	*5785.00	102.8 AV			1.00 V	144	64.20	38.60
3	11570.00	63.7 PK	74.0	-10.3	1.80 V	133	43.30	20.40
4	11570.00	51.2 AV	54.0	-2.8	1.80 V	133	30.80	20.40

REMARKS:

- Emission Level(dBuV/m) = Raw Value(dBuV) + Correction Factor(dB/m)
- Correction Factor(dB/m) = Antenna Factor(dB/m) + Cable Factor(dB) – Pre-Amplifier Factor(dB)
- The other emission levels were very low against the limit.
- Margin value = Emission Level – Limit value
- “ * ”: Fundamental frequency.
- The limit value is defined as per 15.247.



A D T

EUT TEST CONDITION		MEASUREMENT DETAIL	
CHANNEL	Channel 165	FREQUENCY RANGE	1 ~ 40GHz
INPUT POWER (SYSTEM)	120Vac, 60 Hz	DETECTOR FUNCTION	Peak (PK) Average (AV)
ENVIRONMENTAL CONDITIONS	25deg. C, 65%RH	TESTED BY	Jones Chang
TEST MODE	G		

ANTENNA POLARITY & TEST DISTANCE: HORIZONTAL AT 3 M								
NO.	FREQ. (MHz)	EMISSION LEVEL (dBuV/m)	LIMIT (dBuV/m)	MARGIN (dB)	ANTENNA HEIGHT (m)	TABLE ANGLE (Degree)	RAW VALUE (dBuV)	CORRECTION FACTOR (dB/m)
1	*5825.00	119.6 PK			1.37 H	355	80.90	38.70
2	*5825.00	109.2 AV			1.37 H	355	70.50	38.70
3	11650.00	68.5 PK	74.0	-5.5	1.65 H	352	48.20	20.30
4	11650.00	53.0 AV	54.0	-1.0	1.65 H	352	32.70	20.30
ANTENNA POLARITY & TEST DISTANCE: VERTICAL AT 3 M								
NO.	FREQ. (MHz)	EMISSION LEVEL (dBuV/m)	LIMIT (dBuV/m)	MARGIN (dB)	ANTENNA HEIGHT (m)	TABLE ANGLE (Degree)	RAW VALUE (dBuV)	CORRECTION FACTOR (dB/m)
1	*5825.00	111.9 PK			1.01 V	178	73.20	38.70
2	*5825.00	100.6 AV			1.01 V	178	61.90	38.70
3	11650.00	63.8 PK	74.0	-10.2	1.76 V	139	43.50	20.30
4	11650.00	50.4 AV	54.0	-3.6	1.76 V	139	30.10	20.30

REMARKS:

1. Emission Level(dBuV/m) = Raw Value(dBuV) + Correction Factor(dB/m)
2. Correction Factor(dB/m) = Antenna Factor(dB/m) + Cable Factor(dB)
– Pre-Amplifier Factor(dB)
3. The other emission levels were very low against the limit.
4. Margin value = Emission Level – Limit value
5. “ * “: Fundamental frequency.
6. The limit value is defined as per 15.247.



A D T

802.11n (20MHz)

EUT TEST CONDITION		MEASUREMENT DETAIL	
CHANNEL	Channel 149	FREQUENCY RANGE	1 ~ 40GHz
INPUT POWER (SYSTEM)	120Vac, 60 Hz	DETECTOR FUNCTION	Peak (PK) Average (AV)
ENVIRONMENTAL CONDITIONS	25deg. C, 65%RH	TESTED BY	Jones Chang
TEST MODE	G		

ANTENNA POLARITY & TEST DISTANCE: HORIZONTAL AT 3 M								
NO.	FREQ. (MHz)	EMISSION LEVEL (dBuV/m)	LIMIT (dBuV/m)	MARGIN (dB)	ANTENNA HEIGHT (m)	TABLE ANGLE (Degree)	RAW VALUE (dBuV)	CORRECTION FACTOR (dB/m)
1	*5745.00	122.2 PK			1.00 H	353	83.70	38.50
2	*5745.00	112.0 AV			1.00 H	353	73.50	38.50
3	11490.00	66.4 PK	74.0	-7.6	1.47 H	350	46.00	20.40
4	11490.00	52.2 AV	54.0	-1.8	1.47 H	350	31.80	20.40

ANTENNA POLARITY & TEST DISTANCE: VERTICAL AT 3 M								
NO.	FREQ. (MHz)	EMISSION LEVEL (dBuV/m)	LIMIT (dBuV/m)	MARGIN (dB)	ANTENNA HEIGHT (m)	TABLE ANGLE (Degree)	RAW VALUE (dBuV)	CORRECTION FACTOR (dB/m)
1	*5745.00	114.2 PK			1.22 V	90	75.70	38.50
2	*5745.00	104.1 AV			1.22 V	90	65.60	38.50
3	11490.00	63.1 PK	74.0	-10.9	1.82 V	146	42.70	20.40
4	11490.00	50.4 AV	54.0	-3.6	1.82 V	146	30.00	20.40

REMARKS:

1. Emission Level(dBuV/m) = Raw Value(dBuV) + Correction Factor(dB/m)
2. Correction Factor(dB/m) = Antenna Factor(dB/m) + Cable Factor(dB) – Pre-Amplifier Factor(dB)
3. The other emission levels were very low against the limit.
4. Margin value = Emission Level – Limit value
5. “ * “: Fundamental frequency.
6. The limit value is defined as per 15.247.



A D T

EUT TEST CONDITION		MEASUREMENT DETAIL	
CHANNEL	Channel 157	FREQUENCY RANGE	1 ~ 40GHz
INPUT POWER (SYSTEM)	120Vac, 60 Hz	DETECTOR FUNCTION	Peak (PK) Average (AV)
ENVIRONMENTAL CONDITIONS	25deg. C, 65%RH	TESTED BY	Jones Chang
TEST MODE	G		

ANTENNA POLARITY & TEST DISTANCE: HORIZONTAL AT 3 M								
NO.	FREQ. (MHz)	EMISSION LEVEL (dBuV/m)	LIMIT (dBuV/m)	MARGIN (dB)	ANTENNA HEIGHT (m)	TABLE ANGLE (Degree)	RAW VALUE (dBuV)	CORRECTION FACTOR (dB/m)
1	*5785.00	121.4 PK			1.17 H	352	82.80	38.60
2	*5785.00	111.0 AV			1.17 H	352	72.40	38.60
3	11570.00	66.8 PK	74.0	-7.2	1.60 H	353	46.40	20.40
4	11570.00	52.4 AV	54.0	-1.6	1.60 H	353	32.00	20.40
ANTENNA POLARITY & TEST DISTANCE: VERTICAL AT 3 M								
NO.	FREQ. (MHz)	EMISSION LEVEL (dBuV/m)	LIMIT (dBuV/m)	MARGIN (dB)	ANTENNA HEIGHT (m)	TABLE ANGLE (Degree)	RAW VALUE (dBuV)	CORRECTION FACTOR (dB/m)
1	*5785.00	114.2 PK			1.17 V	118	75.60	38.60
2	*5785.00	103.8 AV			1.17 V	118	65.20	38.60
3	11570.00	63.7 PK	74.0	-10.3	1.72 V	137	43.30	20.40
4	11570.00	50.4 AV	54.0	-3.6	1.72 V	137	30.00	20.40

REMARKS:

1. Emission Level(dBuV/m) = Raw Value(dBuV) + Correction Factor(dB/m)
2. Correction Factor(dB/m) = Antenna Factor(dB/m) + Cable Factor(dB) – Pre-Amplifier Factor(dB)
3. The other emission levels were very low against the limit.
4. Margin value = Emission Level – Limit value
5. “ * ”: Fundamental frequency.
6. The limit value is defined as per 15.247.



A D T

EUT TEST CONDITION		MEASUREMENT DETAIL	
CHANNEL	Channel 165	FREQUENCY RANGE	1 ~ 40GHz
INPUT POWER (SYSTEM)	120Vac, 60 Hz	DETECTOR FUNCTION	Peak (PK) Average (AV)
ENVIRONMENTAL CONDITIONS	25deg. C, 65%RH	TESTED BY	Jones Chang
TEST MODE	G		

ANTENNA POLARITY & TEST DISTANCE: HORIZONTAL AT 3 M								
NO.	FREQ. (MHz)	EMISSION LEVEL (dBuV/m)	LIMIT (dBuV/m)	MARGIN (dB)	ANTENNA HEIGHT (m)	TABLE ANGLE (Degree)	RAW VALUE (dBuV)	CORRECTION FACTOR (dB/m)
1	*5825.00	121.8 PK			1.28 H	350	83.10	38.70
2	*5825.00	111.3 AV			1.28 H	350	72.60	38.70
3	11650.00	67.4 PK	74.0	-6.6	1.61 H	351	47.10	20.30
4	11650.00	53.0 AV	54.0	-1.0	1.61 H	351	32.70	20.30
ANTENNA POLARITY & TEST DISTANCE: VERTICAL AT 3 M								
NO.	FREQ. (MHz)	EMISSION LEVEL (dBuV/m)	LIMIT (dBuV/m)	MARGIN (dB)	ANTENNA HEIGHT (m)	TABLE ANGLE (Degree)	RAW VALUE (dBuV)	CORRECTION FACTOR (dB/m)
1	*5825.00	114.6 PK			1.20 V	123	75.90	38.70
2	*5825.00	104.2 AV			1.20 V	123	65.50	38.70
3	11650.00	63.9 PK	74.0	-10.1	1.68 V	141	43.60	20.30
4	11650.00	50.4 AV	54.0	-3.6	1.68 V	141	30.10	20.30

REMARKS:

1. Emission Level(dBuV/m) = Raw Value(dBuV) + Correction Factor(dB/m)
2. Correction Factor(dB/m) = Antenna Factor(dB/m) + Cable Factor(dB) – Pre-Amplifier Factor(dB)
3. The other emission levels were very low against the limit.
4. Margin value = Emission Level – Limit value
5. “ * “: Fundamental frequency.
6. The limit value is defined as per 15.247.



A D T

802.11n (40MHz)

EUT TEST CONDITION		MEASUREMENT DETAIL	
CHANNEL	Channel 151	FREQUENCY RANGE	1 ~ 40GHz
INPUT POWER (SYSTEM)	120Vac, 60 Hz	DETECTOR FUNCTION	Peak (PK) Average (AV)
ENVIRONMENTAL CONDITIONS	25deg. C, 65%RH	TESTED BY	Jones Chang
TEST MODE	G		

ANTENNA POLARITY & TEST DISTANCE: HORIZONTAL AT 3 M								
NO.	FREQ. (MHz)	EMISSION LEVEL (dBuV/m)	LIMIT (dBuV/m)	MARGIN (dB)	ANTENNA HEIGHT (m)	TABLE ANGLE (Degree)	RAW VALUE (dBuV)	CORRECTION FACTOR (dB/m)
1	*5755.00	120.6 PK			1.00 H	353	82.00	38.60
2	*5755.00	110.9 AV			1.00 H	353	72.30	38.60
3	11510.00	65.6 PK	74.0	-8.4	1.50 H	350	45.20	20.40
4	11510.00	52.7 AV	54.0	-1.3	1.50 H	350	32.30	20.40

ANTENNA POLARITY & TEST DISTANCE: VERTICAL AT 3 M								
NO.	FREQ. (MHz)	EMISSION LEVEL (dBuV/m)	LIMIT (dBuV/m)	MARGIN (dB)	ANTENNA HEIGHT (m)	TABLE ANGLE (Degree)	RAW VALUE (dBuV)	CORRECTION FACTOR (dB/m)
1	*5755.00	111.8 PK			1.00 V	90	73.20	38.60
2	*5755.00	102.1 AV			1.00 V	90	63.50	38.60
3	11510.00	63.6 PK	74.0	-10.4	1.61 V	152	43.20	20.40
4	11510.00	51.0 AV	54.0	-3.0	1.61 V	152	30.60	20.40

REMARKS:

1. Emission Level(dBuV/m) = Raw Value(dBuV) + Correction Factor(dB/m)
2. Correction Factor(dB/m) = Antenna Factor(dB/m) + Cable Factor(dB) – Pre-Amplifier Factor(dB)
3. The other emission levels were very low against the limit.
4. Margin value = Emission Level – Limit value
5. “ * “: Fundamental frequency.
6. The limit value is defined as per 15.247.



A D T

EUT TEST CONDITION		MEASUREMENT DETAIL	
CHANNEL	Channel 159	FREQUENCY RANGE	1 ~ 40GHz
INPUT POWER (SYSTEM)	120Vac, 60 Hz	DETECTOR FUNCTION	Peak (PK) Average (AV)
ENVIRONMENTAL CONDITIONS	25deg. C, 65%RH	TESTED BY	Jones Chang
TEST MODE	G		

ANTENNA POLARITY & TEST DISTANCE: HORIZONTAL AT 3 M								
NO.	FREQ. (MHz)	EMISSION LEVEL (dBuV/m)	LIMIT (dBuV/m)	MARGIN (dB)	ANTENNA HEIGHT (m)	TABLE ANGLE (Degree)	RAW VALUE (dBuV)	CORRECTION FACTOR (dB/m)
1	*5795.00	119.3 PK			1.06 H	352	80.70	38.60
2	*5795.00	109.2 AV			1.06 H	352	70.60	38.60
3	11590.00	65.9 PK	74.0	-8.1	1.54 H	353	45.50	20.40
4	11590.00	52.7 AV	54.0	-1.3	1.54 H	353	32.30	20.40
ANTENNA POLARITY & TEST DISTANCE: VERTICAL AT 3 M								
NO.	FREQ. (MHz)	EMISSION LEVEL (dBuV/m)	LIMIT (dBuV/m)	MARGIN (dB)	ANTENNA HEIGHT (m)	TABLE ANGLE (Degree)	RAW VALUE (dBuV)	CORRECTION FACTOR (dB/m)
1	*5795.00	113.1 PK			1.18 V	88	74.50	38.60
2	*5795.00	102.4 AV			1.18 V	88	63.80	38.60
3	11590.00	62.4 PK	74.0	-11.6	1.58 V	135	42.00	20.40
4	11590.00	49.5 AV	54.0	-4.5	1.58 V	135	29.10	20.40

REMARKS:

1. Emission Level(dBuV/m) = Raw Value(dBuV) + Correction Factor(dB/m)
2. Correction Factor(dB/m) = Antenna Factor(dB/m) + Cable Factor(dB)
– Pre-Amplifier Factor(dB)
3. The other emission levels were very low against the limit.
4. Margin value = Emission Level – Limit value
5. “ * “: Fundamental frequency.
6. The limit value is defined as per 15.247.



A D T

802.11ac (80MHz)

EUT TEST CONDITION		MEASUREMENT DETAIL	
CHANNEL	Channel 155	FREQUENCY RANGE	1 ~ 40GHz
INPUT POWER (SYSTEM)	120Vac, 60 Hz	DETECTOR FUNCTION	Peak (PK) Average (AV)
ENVIRONMENTAL CONDITIONS	25deg. C, 65%RH	TESTED BY	Chris Lin
TEST MODE	G		

ANTENNA POLARITY & TEST DISTANCE: HORIZONTAL AT 3 M								
NO.	FREQ. (MHz)	EMISSION LEVEL (dBuV/m)	LIMIT (dBuV/m)	MARGIN (dB)	ANTENNA HEIGHT (m)	TABLE ANGLE (Degree)	RAW VALUE (dBuV)	CORRECTION FACTOR (dB/m)
1	*5775.00	118.6 PK			1.06 H	349	80.00	38.60
2	*5775.00	108.5 AV			1.06 H	349	69.90	38.60
3	11550.00	64.4 PK	74.0	-9.6	1.69 H	350	44.00	20.40
4	11550.00	52.0 AV	54.0	-2.0	1.69 H	350	31.60	20.40

ANTENNA POLARITY & TEST DISTANCE: VERTICAL AT 3 M								
NO.	FREQ. (MHz)	EMISSION LEVEL (dBuV/m)	LIMIT (dBuV/m)	MARGIN (dB)	ANTENNA HEIGHT (m)	TABLE ANGLE (Degree)	RAW VALUE (dBuV)	CORRECTION FACTOR (dB/m)
1	*5775.00	108.9 PK			1.20 V	90	70.30	38.60
2	*5775.00	99.2 AV			1.20 V	90	60.60	38.60
3	11550.00	63.3 PK	74.0	-10.7	1.57 V	150	42.90	20.40
4	11550.00	50.1 AV	54.0	-3.9	1.57 V	150	29.70	20.40

REMARKS:

1. Emission Level(dBuV/m) = Raw Value(dBuV) + Correction Factor(dB/m)
2. Correction Factor(dB/m) = Antenna Factor(dB/m) + Cable Factor(dB) – Pre-Amplifier Factor(dB)
3. The other emission levels were very low against the limit.
4. Margin value = Emission Level – Limit value
5. " * " : Fundamental frequency.
6. The limit value is defined as per 15.247.
7. " # " : The radiated frequency is out of the restricted band.



A D T

BELOW 1GHz WORST-CASE DATA :

802.11a

EUT TEST CONDITION		MEASUREMENT DETAIL	
CHANNEL	Channel 157	FREQUENCY RANGE	Below 1000MHz
INPUT POWER (SYSTEM)	120Vac, 60 Hz	DETECTOR FUNCTION	Quasi-Peak
ENVIRONMENTAL CONDITIONS	25deg. C, 65%RH	TESTED BY	Jones Chang
TEST MODE	A		

ANTENNA POLARITY & TEST DISTANCE: HORIZONTAL AT 3 M								
NO.	FREQ. (MHz)	EMISSION LEVEL (dBuV/m)	LIMIT (dBuV/m)	MARGIN (dB)	ANTENNA HEIGHT (m)	TABLE ANGLE (Degree)	RAW VALUE (dBuV)	CORRECTION FACTOR (dB/m)
1	144.61	37.3 QP	43.5	-6.2	1.99 H	16	51.40	-14.10
2	234.05	38.2 QP	46.0	-7.8	1.24 H	81	53.50	-15.30
3	337.10	35.2 QP	46.0	-10.8	1.00 H	193	46.70	-11.50
4	424.59	39.0 QP	46.0	-7.0	1.24 H	295	48.70	-9.70
5	527.64	35.9 QP	46.0	-10.1	1.24 H	103	43.70	-7.80
6	620.96	37.9 QP	46.0	-8.1	1.24 H	260	43.50	-5.60

ANTENNA POLARITY & TEST DISTANCE: VERTICAL AT 3 M								
NO.	FREQ. (MHz)	EMISSION LEVEL (dBuV/m)	LIMIT (dBuV/m)	MARGIN (dB)	ANTENNA HEIGHT (m)	TABLE ANGLE (Degree)	RAW VALUE (dBuV)	CORRECTION FACTOR (dB/m)
1	166.00	39.2 QP	43.5	-4.3	1.00 V	126	53.20	-14.00
2	267.10	32.6 QP	46.0	-13.4	1.51 V	189	46.00	-13.40
3	337.10	35.1 QP	46.0	-10.9	1.25 V	106	46.60	-11.50
4	620.96	34.6 QP	46.0	-11.4	1.51 V	10	40.20	-5.60
5	654.02	31.4 QP	46.0	-14.6	1.25 V	61	36.60	-5.20
6	900.94	33.3 QP	46.0	-12.7	1.25 V	136	33.70	-0.40

REMARKS:

1. Emission Level(dBuV/m) = Raw Value(dBuV) + Correction Factor(dB/m)
2. Correction Factor(dB/m) = Antenna Factor(dB/m) + Cable Factor(dB) – Pre-Amplifier Factor (dB)
3. The other emission levels were very low against the limit.
4. Margin value = Emission Level – Limit value



A D T

802.11ac (80MHz)

EUT TEST CONDITION		MEASUREMENT DETAIL	
CHANNEL	Channel 155	FREQUENCY RANGE	Below 1000MHz
INPUT POWER (SYSTEM)	120Vac, 60 Hz	DETECTOR FUNCTION	Quasi-Peak
ENVIRONMENTAL CONDITIONS	25deg. C, 65%RH	TESTED BY	Chris Lin
TEST MODE	B		

ANTENNA POLARITY & TEST DISTANCE: HORIZONTAL AT 3 M								
NO.	FREQ. (MHz)	EMISSION LEVEL (dBuV/m)	LIMIT (dBuV/m)	MARGIN (dB)	ANTENNA HEIGHT (m)	TABLE ANGLE (Degree)	RAW VALUE (dBuV)	CORRECTION FACTOR (dB/m)
1	99.89	38.1 QP	43.5	-5.4	2.00 H	135	56.90	-18.80
2	199.05	37.3 QP	43.5	-6.2	2.00 H	19	53.90	-16.60
3	500.42	37.5 QP	46.0	-8.5	1.26 H	99	45.80	-8.30
4	667.63	40.5 QP	46.0	-5.5	1.00 H	44	45.50	-5.00
5	700.68	42.0 QP	46.0	-4.0	1.26 H	136	46.30	-4.30
6	900.94	40.1 QP	46.0	-5.9	1.00 H	198	40.50	-0.40

ANTENNA POLARITY & TEST DISTANCE: VERTICAL AT 3 M								
NO.	FREQ. (MHz)	EMISSION LEVEL (dBuV/m)	LIMIT (dBuV/m)	MARGIN (dB)	ANTENNA HEIGHT (m)	TABLE ANGLE (Degree)	RAW VALUE (dBuV)	CORRECTION FACTOR (dB/m)
1	76.56	37.4 QP	40.0	-2.6	2.00 V	233	55.00	-17.60
2	166.00	34.2 QP	43.5	-9.3	1.00 V	244	48.20	-14.00
3	298.21	42.5 QP	46.0	-3.5	1.00 V	317	54.80	-12.30
4	500.42	35.7 QP	46.0	-10.3	1.25 V	80	44.00	-8.30
5	700.68	38.3 QP	46.0	-7.7	1.25 V	186	42.60	-4.30
6	897.05	37.9 QP	46.0	-8.1	1.25 V	99	38.40	-0.50

REMARKS:

1. Emission Level(dBuV/m) = Raw Value(dBuV) + Correction Factor(dB/m)
2. Correction Factor(dB/m) = Antenna Factor(dB/m) + Cable Factor(dB)
 - Pre-Amplifier Factor (dB)
3. The other emission levels were very low against the limit.
4. Margin value = Emission Level – Limit value



A D T

802.11n (40MHz)

EUT TEST CONDITION		MEASUREMENT DETAIL	
CHANNEL	Channel 151	FREQUENCY RANGE	Below 1000MHz
INPUT POWER (SYSTEM)	120Vac, 60 Hz	DETECTOR FUNCTION	Quasi-Peak
ENVIRONMENTAL CONDITIONS	23deg. C, 65%RH	TESTED BY	Jones Chang
TEST MODE	C		

ANTENNA POLARITY & TEST DISTANCE: HORIZONTAL AT 3 M

NO.	FREQ. (MHz)	EMISSION LEVEL (dBuV/m)	LIMIT (dBuV/m)	MARGIN (dB)	ANTENNA HEIGHT (m)	TABLE ANGLE (Degree)	RAW VALUE (dBuV)	CORRECTION FACTOR (dB/m)
1	51.29	36.5 QP	40.0	-3.5	1.99 H	93	51.00	-14.50
2	99.89	39.8 QP	43.5	-3.7	1.99 H	86	58.60	-18.80
3	142.67	40.3 QP	43.5	-3.2	1.99 H	92	54.60	-14.30
4	216.55	39.4 QP	46.0	-6.6	1.00 H	163	55.60	-16.20
5	331.26	39.4 QP	46.0	-6.6	1.00 H	159	51.00	-11.60
6	667.63	36.5 QP	46.0	-9.5	1.00 H	37	41.50	-5.00

ANTENNA POLARITY & TEST DISTANCE: VERTICAL AT 3 M

NO.	FREQ. (MHz)	EMISSION LEVEL (dBuV/m)	LIMIT (dBuV/m)	MARGIN (dB)	ANTENNA HEIGHT (m)	TABLE ANGLE (Degree)	RAW VALUE (dBuV)	CORRECTION FACTOR (dB/m)
1	53.23	38.2 QP	40.0	-1.8	1.51 V	11	52.60	-14.40
2	97.95	38.2 QP	43.5	-5.3	1.01 V	79	57.20	-19.00
3	222.38	34.0 QP	46.0	-12.0	1.01 V	327	50.20	-16.20
4	364.32	33.5 QP	46.0	-12.5	1.51 V	217	44.50	-11.00
5	667.63	41.0 QP	46.0	-5.0	1.01 V	93	46.00	-5.00
6	815.39	32.9 QP	46.0	-13.1	1.51 V	132	34.80	-1.90

REMARKS:

1. Emission Level(dBuV/m) = Raw Value(dBuV) + Correction Factor(dB/m)
2. Correction Factor(dB/m) = Antenna Factor(dB/m) + Cable Factor(dB) – Pre-Amplifier Factor (dB)
3. The other emission levels were very low against the limit.
4. Margin value = Emission Level – Limit value



A D T

802.11n (20MHz)

EUT TEST CONDITION		MEASUREMENT DETAIL	
CHANNEL	Channel 165	FREQUENCY RANGE	Below 1000MHz
INPUT POWER (SYSTEM)	120Vac, 60 Hz	DETECTOR FUNCTION	Quasi-Peak
ENVIRONMENTAL CONDITIONS	25deg. C, 65%RH	TESTED BY	Chris Lin
TEST MODE	D		

ANTENNA POLARITY & TEST DISTANCE: HORIZONTAL AT 3 M								
NO.	FREQ. (MHz)	EMISSION LEVEL (dBuV/m)	LIMIT (dBuV/m)	MARGIN (dB)	ANTENNA HEIGHT (m)	TABLE ANGLE (Degree)	RAW VALUE (dBuV)	CORRECTION FACTOR (dB/m)
1	84.34	35.3 QP	40.0	-4.7	1.50 H	165	54.70	-19.40
2	99.89	40.7 QP	43.5	-2.8	1.50 H	159	59.50	-18.80
3	214.61	42.1 QP	43.5	-1.4	1.50 H	187	58.30	-16.20
4	243.77	40.5 QP	46.0	-5.5	1.00 H	133	55.00	-14.50
5	500.42	41.1 QP	46.0	-4.9	1.50 H	138	49.40	-8.30
6	700.68	41.5 QP	46.0	-4.5	1.00 H	127	45.80	-4.30
7	897.05	43.7 QP	46.0	-2.3	1.50 H	129	44.20	-0.50

ANTENNA POLARITY & TEST DISTANCE: VERTICAL AT 3 M								
NO.	FREQ. (MHz)	EMISSION LEVEL (dBuV/m)	LIMIT (dBuV/m)	MARGIN (dB)	ANTENNA HEIGHT (m)	TABLE ANGLE (Degree)	RAW VALUE (dBuV)	CORRECTION FACTOR (dB/m)
1	57.12	34.4 QP	40.0	-5.6	1.00 V	187	49.00	-14.60
2	68.79	34.5 QP	40.0	-5.5	1.00 V	150	50.40	-15.90
3	84.34	38.2 QP	40.0	-1.8	1.49 V	304	57.60	-19.40
4	150.45	39.7 QP	43.5	-3.8	1.00 V	278	53.50	-13.80
5	166.00	39.0 QP	43.5	-4.5	1.00 V	39	53.00	-14.00
6	218.50	41.1 QP	46.0	-4.9	1.49 V	250	57.30	-16.20

REMARKS:

1. Emission Level(dBuV/m) = Raw Value(dBuV) + Correction Factor(dB/m)
2. Correction Factor(dB/m) = Antenna Factor(dB/m) + Cable Factor(dB) – Pre-Amplifier Factor (dB)
3. The other emission levels were very low against the limit.
4. Margin value = Emission Level – Limit value



A D T

802.11n (40MHz)

EUT TEST CONDITION		MEASUREMENT DETAIL	
CHANNEL	Channel 159	FREQUENCY RANGE	Below 1000MHz
INPUT POWER (SYSTEM)	120Vac, 60 Hz	DETECTOR FUNCTION	Quasi-Peak
ENVIRONMENTAL CONDITIONS	25deg. C, 65%RH	TESTED BY	Chris Lin
TEST MODE	E		

ANTENNA POLARITY & TEST DISTANCE: HORIZONTAL AT 3 M								
NO.	FREQ. (MHz)	EMISSION LEVEL (dBuV/m)	LIMIT (dBuV/m)	MARGIN (dB)	ANTENNA HEIGHT (m)	TABLE ANGLE (Degree)	RAW VALUE (dBuV)	CORRECTION FACTOR (dB/m)
1	144.61	35.0 QP	43.5	-8.5	1.99 H	4	49.10	-14.10
2	300.16	40.1 QP	46.0	-5.9	1.00 H	172	52.30	-12.20
3	432.37	31.6 QP	46.0	-14.4	1.99 H	86	41.00	-9.40
4	498.47	31.4 QP	46.0	-14.6	1.50 H	115	39.70	-8.30
5	667.63	32.4 QP	46.0	-13.6	1.25 H	48	37.40	-5.00
6	840.67	31.6 QP	46.0	-14.4	1.50 H	59	33.20	-1.60

ANTENNA POLARITY & TEST DISTANCE: VERTICAL AT 3 M								
NO.	FREQ. (MHz)	EMISSION LEVEL (dBuV/m)	LIMIT (dBuV/m)	MARGIN (dB)	ANTENNA HEIGHT (m)	TABLE ANGLE (Degree)	RAW VALUE (dBuV)	CORRECTION FACTOR (dB/m)
1	31.84	38.3 QP	40.0	-1.7	1.01 V	151	54.20	-15.90
2	144.61	30.5 QP	43.5	-13.0	1.25 V	317	44.60	-14.10
3	300.16	30.9 QP	46.0	-15.1	1.51 V	91	43.10	-12.20
4	432.37	29.6 QP	46.0	-16.4	1.25 V	140	39.00	-9.40
5	667.63	29.9 QP	46.0	-16.1	1.01 V	107	34.90	-5.00
6	832.89	32.8 QP	46.0	-13.2	1.25 V	33	34.50	-1.70

REMARKS:

1. Emission Level(dBuV/m) = Raw Value(dBuV) + Correction Factor(dB/m)
2. Correction Factor(dB/m) = Antenna Factor(dB/m) + Cable Factor(dB)
 - Pre-Amplifier Factor (dB)
3. The other emission levels were very low against the limit.
4. Margin value = Emission Level – Limit value



A D T

802.11n (20MHz)

EUT TEST CONDITION		MEASUREMENT DETAIL	
CHANNEL	Channel 165	FREQUENCY RANGE	Below 1000MHz
INPUT POWER (SYSTEM)	120Vac, 60 Hz	DETECTOR FUNCTION	Quasi-Peak
ENVIRONMENTAL CONDITIONS	25deg. C, 65%RH	TESTED BY	Chris Lin
TEST MODE	F		

ANTENNA POLARITY & TEST DISTANCE: HORIZONTAL AT 3 M								
NO.	FREQ. (MHz)	EMISSION LEVEL (dBuV/m)	LIMIT (dBuV/m)	MARGIN (dB)	ANTENNA HEIGHT (m)	TABLE ANGLE (Degree)	RAW VALUE (dBuV)	CORRECTION FACTOR (dB/m)
1	97.95	33.3 QP	43.5	-10.2	2.00 H	187	52.30	-19.00
2	234.05	37.3 QP	46.0	-8.7	1.00 H	220	52.60	-15.30
3	300.16	44.2 QP	46.0	-1.8	1.00 H	60	56.40	-12.20
4	700.68	44.9 QP	46.0	-1.1	1.00 H	57	49.20	-4.30
5	840.67	34.0 QP	46.0	-12.0	1.00 H	50	35.60	-1.60
6	897.05	40.6 QP	46.0	-5.4	1.50 H	57	41.10	-0.50

ANTENNA POLARITY & TEST DISTANCE: VERTICAL AT 3 M								
NO.	FREQ. (MHz)	EMISSION LEVEL (dBuV/m)	LIMIT (dBuV/m)	MARGIN (dB)	ANTENNA HEIGHT (m)	TABLE ANGLE (Degree)	RAW VALUE (dBuV)	CORRECTION FACTOR (dB/m)
1	57.12	34.1 QP	40.0	-5.9	1.00 V	283	48.70	-14.60
2	298.21	35.6 QP	46.0	-10.4	1.99 V	6	47.90	-12.30
3	424.59	32.2 QP	46.0	-13.8	1.00 V	9	41.90	-9.70
4	498.47	29.3 QP	46.0	-16.7	1.50 V	73	37.60	-8.30
5	700.68	41.5 QP	46.0	-4.5	1.00 V	111	45.80	-4.30
6	840.67	32.9 QP	46.0	-13.1	1.24 V	102	34.50	-1.60

REMARKS:

1. Emission Level(dBuV/m) = Raw Value(dBuV) + Correction Factor(dB/m)
2. Correction Factor(dB/m) = Antenna Factor(dB/m) + Cable Factor(dB)
 - Pre-Amplifier Factor (dB)
3. The other emission levels were very low against the limit.
4. Margin value = Emission Level – Limit value



A D T

802.11n (20MHz)

EUT TEST CONDITION		MEASUREMENT DETAIL	
CHANNEL	Channel 149	FREQUENCY RANGE	Below 1000MHz
INPUT POWER (SYSTEM)	120Vac, 60 Hz	DETECTOR FUNCTION	Quasi-Peak
ENVIRONMENTAL CONDITIONS	25deg. C, 65%RH	TESTED BY	Jones Chang
TEST MODE	G		

ANTENNA POLARITY & TEST DISTANCE: HORIZONTAL AT 3 M								
NO.	FREQ. (MHz)	EMISSION LEVEL (dBuV/m)	LIMIT (dBuV/m)	MARGIN (dB)	ANTENNA HEIGHT (m)	TABLE ANGLE (Degree)	RAW VALUE (dBuV)	CORRECTION FACTOR (dB/m)
1	55.18	34.1 QP	40.0	-5.9	2.00 H	91	48.60	-14.50
2	90.17	37.9 QP	43.5	-5.6	2.00 H	227	57.70	-19.80
3	99.89	40.9 QP	43.5	-2.6	2.00 H	119	59.70	-18.80
4	142.67	37.4 QP	43.5	-6.1	2.00 H	133	51.70	-14.30
5	500.42	35.9 QP	46.0	-10.1	1.51 H	89	44.20	-8.30
6	700.68	43.9 QP	46.0	-2.1	1.00 H	86	48.20	-4.30

ANTENNA POLARITY & TEST DISTANCE: VERTICAL AT 3 M								
NO.	FREQ. (MHz)	EMISSION LEVEL (dBuV/m)	LIMIT (dBuV/m)	MARGIN (dB)	ANTENNA HEIGHT (m)	TABLE ANGLE (Degree)	RAW VALUE (dBuV)	CORRECTION FACTOR (dB/m)
1	55.18	30.9 QP	40.0	-9.1	1.00 V	119	45.40	-14.50
2	74.62	36.3 QP	40.0	-3.7	1.00 V	139	53.60	-17.30
3	199.05	34.3 QP	43.5	-9.2	1.00 V	350	50.90	-16.60
4	335.15	32.9 QP	46.0	-13.1	1.49 V	106	44.50	-11.60
5	364.32	31.0 QP	46.0	-15.0	1.49 V	139	42.00	-11.00
6	840.67	33.0 QP	46.0	-13.0	1.00 V	99	34.60	-1.60

REMARKS:

1. Emission Level(dBuV/m) = Raw Value(dBuV) + Correction Factor(dB/m)
2. Correction Factor(dB/m) = Antenna Factor(dB/m) + Cable Factor(dB) – Pre-Amplifier Factor (dB)
3. The other emission levels were very low against the limit.
4. Margin value = Emission Level – Limit value



A D T

4.2 CONDUCTED EMISSION MEASUREMENT

4.2.1 LIMITS OF CONDUCTED EMISSION MEASUREMENT

FREQUENCY OF EMISSION (MHz)	CONDUCTED LIMIT (dB μ V)	
	Quasi-peak	Average
0.15 ~ 0.5	66 to 56	56 to 46
0.5 ~ 5	56	46
5 ~ 30	60	50

- NOTE:** 1. The lower limit shall apply at the transition frequencies.
2. The limit decreases in line with the logarithm of the frequency in the range of 0.15 to 0.50MHz.
3. All emanations from a class A/B digital device or system, including any network of conductors and apparatus connected thereto, shall not exceed the level of field strengths specified above.

4.2.2 TEST INSTRUMENTS

DESCRIPTION & MANUFACTURER	MODEL NO.	SERIAL NO.	DATE OF CALIBRATION	DUE DATE OF CALIBRATION
Test Receiver ROHDE & SCHWARZ	ESCS30	100288	Apr. 24, 2014	Apr. 23, 2015
RF signal cable Woken	5D-FB	Cable-HYCO2-01	Dec. 27, 2013	Dec. 26, 2014
LISN ROHDE & SCHWARZ (EUT)	ESH2-Z5	100100	Dec. 23, 2013	Dec. 22, 2014
LISN ROHDE & SCHWARZ (Peripheral)	ESH3-Z5	100312	Jul. 08, 2013	Jul. 07, 2014
Software ADT	BV ADT_Cond_ V7.3.7.3	NA	NA	NA

- NOTE:** 1. The calibration interval of the above test instruments is 12 months and the calibrations are traceable to NML/ROC and NIST/USA.
2. The test was performed in HwaYa Shielded Room 2.
3. The VCCI Site Registration No. is C-2047.

4.2.3 TEST PROCEDURES

- a. The EUT was placed 0.4 meters from the conducting wall of the shielded room with EUT being connected to the power mains through a line impedance stabilization network (LISN). Other support units were connected to the power mains through another LISN. The two LISNs provide 50 ohm/ 50uH of coupling impedance for the measuring instrument.
- b. Both lines of the power mains connected to the EUT were checked for maximum conducted interference.
- c. The frequency range from 150kHz to 30MHz was searched. Emission levels under (Limit - 20dB) was not recorded.

NOTE: All modes of operation were investigated and the worst-case emissions are reported.

4.2.4 DEVIATION FROM TEST STANDARD

No deviation.

4.2.5 TEST SETUP

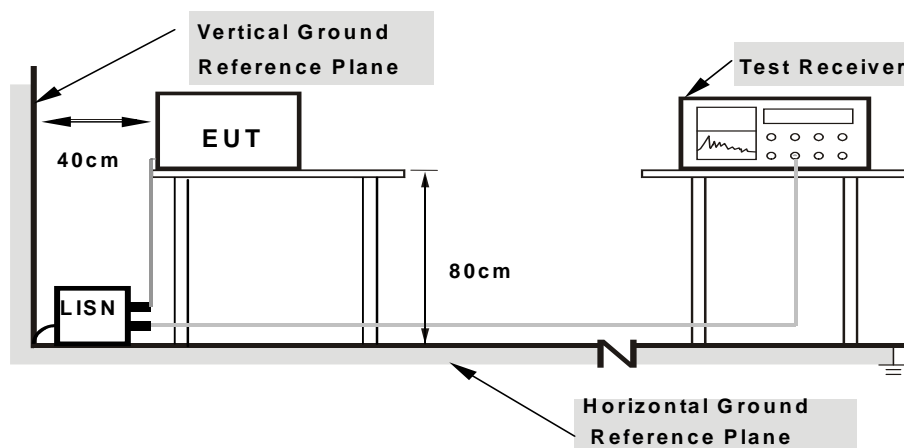

- Note:**
1. Support units were connected to second LISN.
 2. Both of LISNs (AMN) are 80 cm from EUT and at least 80 cm from other units and other metal planes

For the actual test configuration, please refer to the attached file (Test Setup Photo).

4.2.6 EUT OPERATING CONDITIONS

Same as 4.1.6.

4.2.7 TEST RESULTS

CONDUCTED WORST-CASE DATA :

802.11a

PHASE	Line 1	6dB BANDWIDTH	9kHz
TEST MODE	A		

No	Freq. [MHz]	Corr. Factor (dB)	Reading Value		Emission Level		Limit		Margin	
			[dB (uV)]		[dB (uV)]		[dB (uV)]		(dB)	
			Q.P.	AV.	Q.P.	AV.	Q.P.	AV.	Q.P.	AV.
1	0.29844	0.29	19.07	15.62	19.36	15.91	60.29	50.29	-40.93	-34.38
2	0.41953	0.30	12.65	3.59	12.95	3.89	57.46	47.46	-44.51	-43.57
3	3.91406	0.43	20.24	16.74	20.67	17.17	56.00	46.00	-35.33	-28.83
4	5.37500	0.45	22.31	18.47	22.76	18.92	60.00	50.00	-37.24	-31.08
5	14.74219	0.53	25.12	18.00	25.65	18.53	60.00	50.00	-34.35	-31.47
6	22.27344	0.56	26.79	21.42	27.35	21.98	60.00	50.00	-32.65	-28.02

- REMARKS:**
1. Q.P. and AV. are abbreviations of quasi-peak and average individually.
 2. The emission levels of other frequencies were very low against the limit.
 3. Margin value = Emission level - Limit value
 4. Correction factor = Insertion loss + Cable loss
 5. Emission Level = Correction Factor + Reading Value.

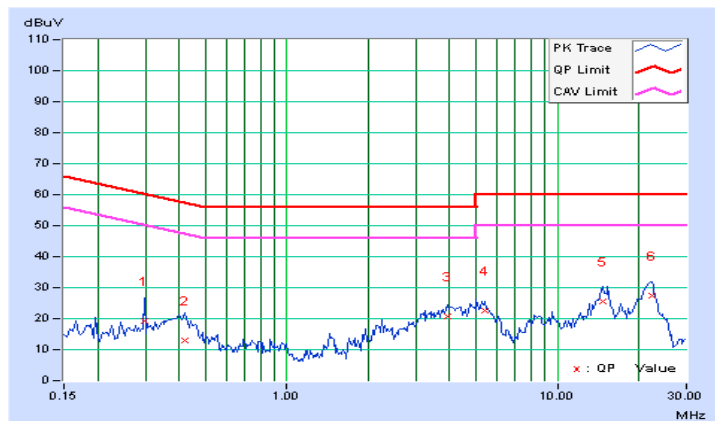



A D T

PHASE	Line 2	6dB BANDWIDTH	9kHz
TEST MODE	A		

No	Freq. [MHz]	Corr. Factor (dB)	Reading Value		Emission Level		Limit		Margin	
			[dB (uV)]		[dB (uV)]		[dB (uV)]		(dB)	
			Q.P.	AV.	Q.P.	AV.	Q.P.	AV.	Q.P.	AV.
1	0.29453	0.29	9.46	2.22	9.75	2.51	60.40	50.40	-50.65	-47.89
2	0.34922	0.29	11.82	5.62	12.11	5.91	58.98	48.98	-46.87	-43.07
3	4.21094	0.44	20.51	16.63	20.95	17.07	56.00	46.00	-35.05	-28.93
4	5.20313	0.46	22.02	18.39	22.48	18.85	60.00	50.00	-37.52	-31.15
5	15.15625	0.57	23.91	16.75	24.48	17.32	60.00	50.00	-35.52	-32.68
6	21.94141	0.61	27.19	22.15	27.80	22.76	60.00	50.00	-32.20	-27.24

- REMARKS:**
1. Q.P. and AV. are abbreviations of quasi-peak and average individually.
 2. The emission levels of other frequencies were very low against the limit.
 3. Margin value = Emission level - Limit value
 4. Correction factor = Insertion loss + Cable loss
 5. Emission Level = Correction Factor + Reading Value.

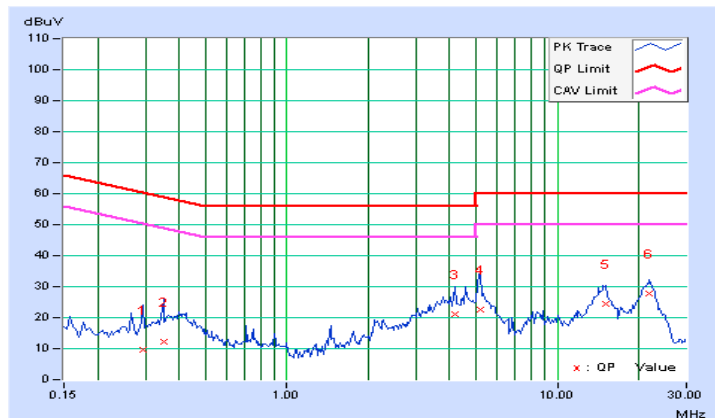



A D T

802.11ac (80MHz)

PHASE	Line 1	6dB BANDWIDTH	9kHz
TEST MODE	B		

No	Freq. [MHz]	Corr. Factor (dB)	Reading Value		Emission Level		Limit		Margin	
			[dB (uV)]		[dB (uV)]		[dB (uV)]		(dB)	
			Q.P.	AV.	Q.P.	AV.	Q.P.	AV.	Q.P.	AV.
1	0.17734	0.27	10.80	3.92	11.07	4.19	64.61	54.61	-53.54	-50.42
2	0.22422	0.28	18.32	12.06	18.60	12.34	62.66	52.66	-44.06	-40.32
3	0.35703	0.30	12.32	4.45	12.62	4.75	58.80	48.80	-46.18	-44.05
4	4.02734	0.43	20.32	16.70	20.75	17.13	56.00	46.00	-35.25	-28.87
5	14.35547	0.53	24.14	17.20	24.67	17.73	60.00	50.00	-35.33	-32.27
6	22.14453	0.57	26.72	21.79	27.29	22.36	60.00	50.00	-32.71	-27.64

- REMARKS:**
1. Q.P. and AV. are abbreviations of quasi-peak and average individually.
 2. The emission levels of other frequencies were very low against the limit.
 3. Margin value = Emission level - Limit value
 4. Correction factor = Insertion loss + Cable loss
 5. Emission Level = Correction Factor + Reading Value.

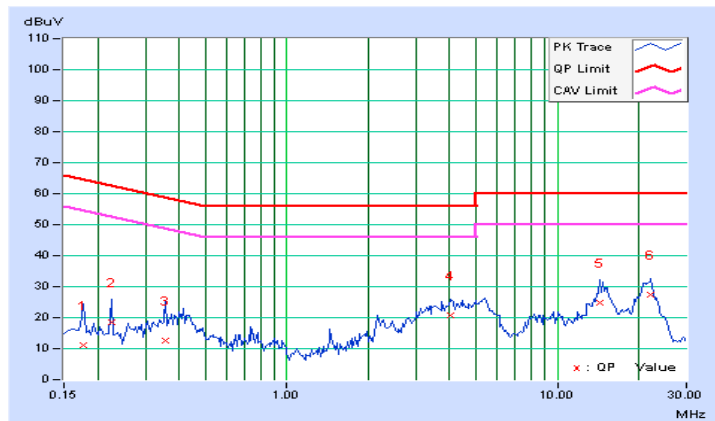



A D T

PHASE	Line 2	6dB BANDWIDTH	9kHz
TEST MODE	B		

No	Freq. [MHz]	Corr. Factor (dB)	Reading Value		Emission Level		Limit		Margin	
			[dB (uV)]		[dB (uV)]		[dB (uV)]		(dB)	
			Q.P.	AV.	Q.P.	AV.	Q.P.	AV.	Q.P.	AV.
1	0.32969	0.29	10.85	2.16	11.14	2.45	59.46	49.46	-48.32	-47.01
2	2.18359	0.38	15.77	10.56	16.15	10.94	56.00	46.00	-39.85	-35.06
3	3.56250	0.42	19.82	16.22	20.24	16.64	56.00	46.00	-35.76	-29.36
4	4.98828	0.45	21.44	17.95	21.89	18.40	56.00	46.00	-34.11	-27.60
5	14.91797	0.56	25.82	17.37	26.38	17.93	60.00	50.00	-33.62	-32.07
6	21.51953	0.62	27.05	22.27	27.67	22.89	60.00	50.00	-32.33	-27.11

- REMARKS:**
1. Q.P. and AV. are abbreviations of quasi-peak and average individually.
 2. The emission levels of other frequencies were very low against the limit.
 3. Margin value = Emission level - Limit value
 4. Correction factor = Insertion loss + Cable loss
 5. Emission Level = Correction Factor + Reading Value.

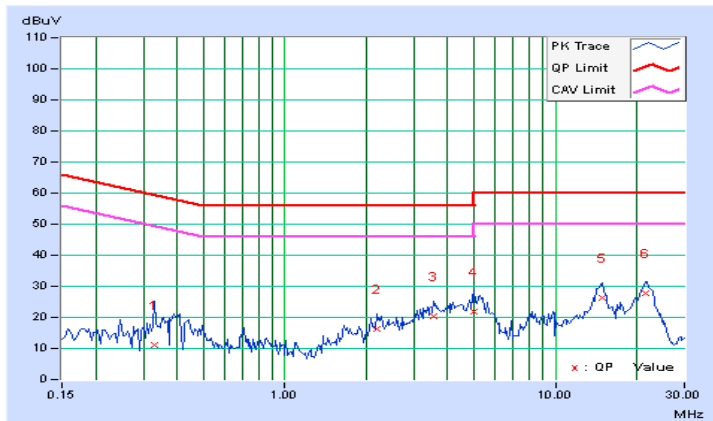



A D T

802.11n (40MHz)

PHASE	Line 1	6dB BANDWIDTH	9kHz
TEST MODE	C		

No	Freq. [MHz]	Corr. Factor (dB)	Reading Value		Emission Level		Limit		Margin	
			[dB (uV)]		[dB (uV)]		[dB (uV)]		(dB)	
			Q.P.	AV.	Q.P.	AV.	Q.P.	AV.	Q.P.	AV.
1	0.15000	0.26	17.56	11.29	17.82	11.55	66.00	56.00	-48.18	-44.45
2	0.33750	0.29	11.06	5.59	11.35	5.88	59.26	49.26	-47.91	-43.38
3	3.66797	0.42	19.79	16.25	20.21	16.67	56.00	46.00	-35.79	-29.33
4	5.37109	0.45	22.87	18.69	23.32	19.14	60.00	50.00	-36.68	-30.86
5	14.78516	0.53	24.70	17.46	25.23	17.99	60.00	50.00	-34.77	-32.01
6	21.69141	0.57	27.27	22.35	27.84	22.92	60.00	50.00	-32.16	-27.08

- REMARKS:**
1. Q.P. and AV. are abbreviations of quasi-peak and average individually.
 2. The emission levels of other frequencies were very low against the limit.
 3. Margin value = Emission level - Limit value
 4. Correction factor = Insertion loss + Cable loss
 5. Emission Level = Correction Factor + Reading Value.

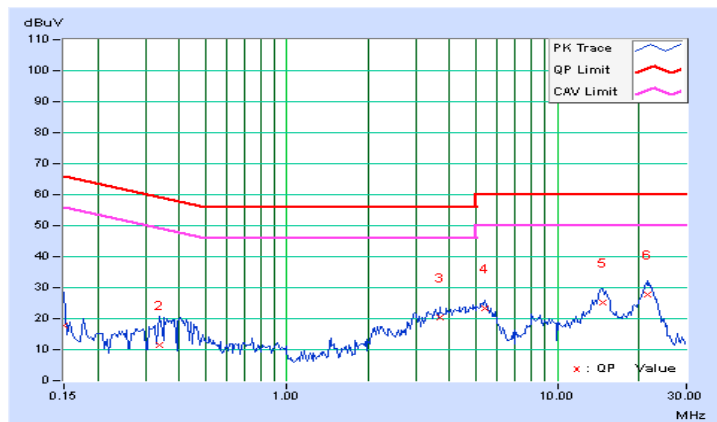



A D T

PHASE	Line 2	6dB BANDWIDTH	9kHz
TEST MODE	C		

No	Freq. [MHz]	Corr. Factor (dB)	Reading Value		Emission Level		Limit		Margin	
			[dB (uV)]		[dB (uV)]		[dB (uV)]		(dB)	
			Q.P.	AV.	Q.P.	AV.	Q.P.	AV.	Q.P.	AV.
1	0.15391	0.27	18.04	14.62	18.31	14.89	65.79	55.79	-47.48	-40.90
2	0.30234	0.29	19.15	15.65	19.44	15.94	60.18	50.18	-40.74	-34.24
3	3.73828	0.43	20.28	16.94	20.71	17.37	56.00	46.00	-35.29	-28.63
4	5.36328	0.46	22.55	18.49	23.01	18.95	60.00	50.00	-36.99	-31.05
5	15.12500	0.57	24.62	17.42	25.19	17.99	60.00	50.00	-34.81	-32.01
6	21.85156	0.61	27.20	22.53	27.81	23.14	60.00	50.00	-32.19	-26.86

- REMARKS:**
1. Q.P. and AV. are abbreviations of quasi-peak and average individually.
 2. The emission levels of other frequencies were very low against the limit.
 3. Margin value = Emission level - Limit value
 4. Correction factor = Insertion loss + Cable loss
 5. Emission Level = Correction Factor + Reading Value.

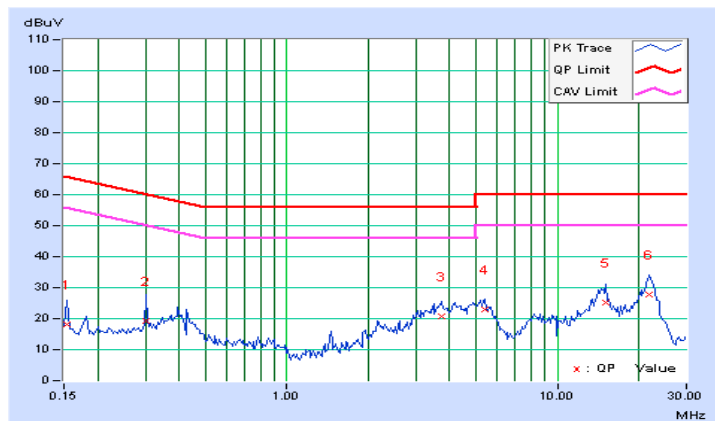



A D T

802.11n (20MHz)

PHASE	Line 1	6dB BANDWIDTH	9kHz
TEST MODE	D		

No	Freq. [MHz]	Corr. Factor (dB)	Reading Value		Emission Level		Limit		Margin	
			[dB (uV)]		[dB (uV)]		[dB (uV)]		(dB)	
			Q.P.	AV.	Q.P.	AV.	Q.P.	AV.	Q.P.	AV.
1	0.25547	0.29	18.68	12.42	18.97	12.71	61.58	51.58	-42.61	-38.87
2	0.40781	0.30	13.16	4.61	13.46	4.91	57.69	47.69	-44.23	-42.78
3	0.70469	0.32	12.21	7.75	12.53	8.07	56.00	46.00	-43.47	-37.93
4	3.98438	0.43	19.75	16.11	20.18	16.54	56.00	46.00	-35.82	-29.46
5	14.74609	0.53	25.20	18.14	25.73	18.67	60.00	50.00	-34.27	-31.33
6	21.64063	0.57	27.09	22.56	27.66	23.13	60.00	50.00	-32.34	-26.87

- REMARKS:**
1. Q.P. and AV. are abbreviations of quasi-peak and average individually.
 2. The emission levels of other frequencies were very low against the limit.
 3. Margin value = Emission level - Limit value
 4. Correction factor = Insertion loss + Cable loss
 5. Emission Level = Correction Factor + Reading Value.

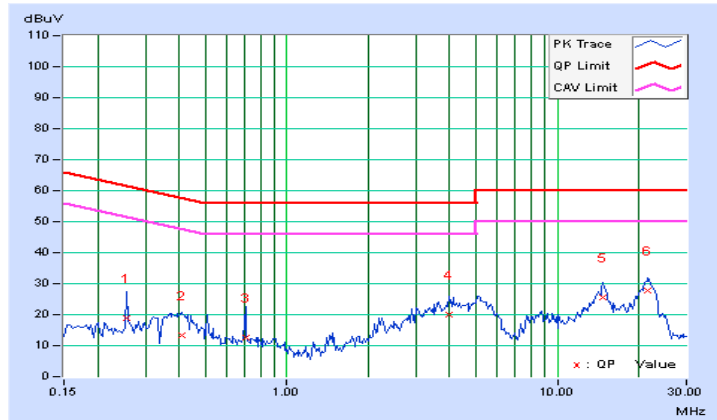

PHASE	Line 2	6dB BANDWIDTH	9kHz
TEST MODE	D		

No	Freq. [MHz]	Corr. Factor (dB)	Reading Value		Emission Level		Limit		Margin	
			[dB (uV)]		[dB (uV)]		[dB (uV)]		(dB)	
			Q.P.	AV.	Q.P.	AV.	Q.P.	AV.	Q.P.	AV.
1	0.29453	0.29	19.32	12.26	19.61	12.55	60.40	50.40	-40.79	-37.85
2	0.38047	0.30	13.22	2.07	13.52	2.37	58.27	48.27	-44.75	-45.90
3	0.84531	0.33	11.27	4.08	11.60	4.41	56.00	46.00	-44.40	-41.59
4	4.70313	0.45	19.37	15.70	19.82	16.15	56.00	46.00	-36.18	-29.85
5	14.44922	0.56	24.20	17.49	24.76	18.05	60.00	50.00	-35.24	-31.95
6	22.22266	0.61	26.48	21.27	27.09	21.88	60.00	50.00	-32.91	-28.12

- REMARKS:**
1. Q.P. and AV. are abbreviations of quasi-peak and average individually.
 2. The emission levels of other frequencies were very low against the limit.
 3. Margin value = Emission level - Limit value
 4. Correction factor = Insertion loss + Cable loss
 5. Emission Level = Correction Factor + Reading Value.

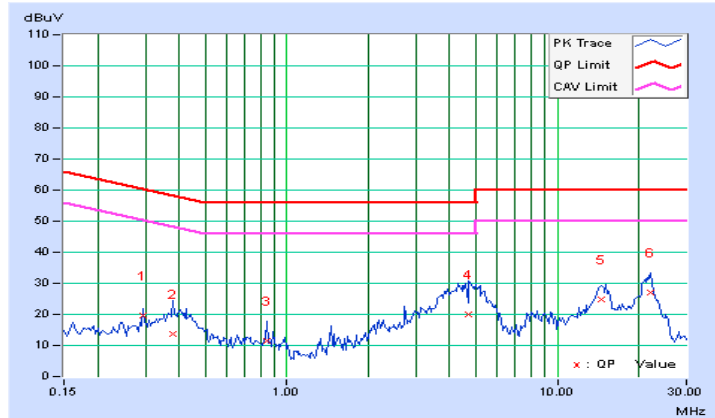



A D T

802.11n (40MHz)

PHASE	Line 1	6dB BANDWIDTH	9kHz
TEST MODE	E		

No	Freq. [MHz]	Corr. Factor (dB)	Reading Value		Emission Level		Limit		Margin	
			[dB (uV)]		[dB (uV)]		[dB (uV)]		(dB)	
			Q.P.	AV.	Q.P.	AV.	Q.P.	AV.	Q.P.	AV.
1	0.16172	0.27	19.58	4.48	19.85	4.75	65.38	55.38	-45.53	-50.63
2	0.27500	0.29	18.34	5.45	18.63	5.74	60.97	50.97	-42.34	-45.23
3	0.41172	0.30	13.14	4.22	13.44	4.52	57.61	47.61	-44.17	-43.09
4	4.02344	0.43	19.67	15.86	20.10	16.29	56.00	46.00	-35.90	-29.71
5	15.09375	0.53	23.45	16.37	23.98	16.90	60.00	50.00	-36.02	-33.10
6	21.64453	0.57	26.78	22.11	27.35	22.68	60.00	50.00	-32.65	-27.32

- REMARKS:**
1. Q.P. and AV. are abbreviations of quasi-peak and average individually.
 2. The emission levels of other frequencies were very low against the limit.
 3. Margin value = Emission level - Limit value
 4. Correction factor = Insertion loss + Cable loss
 5. Emission Level = Correction Factor + Reading Value.

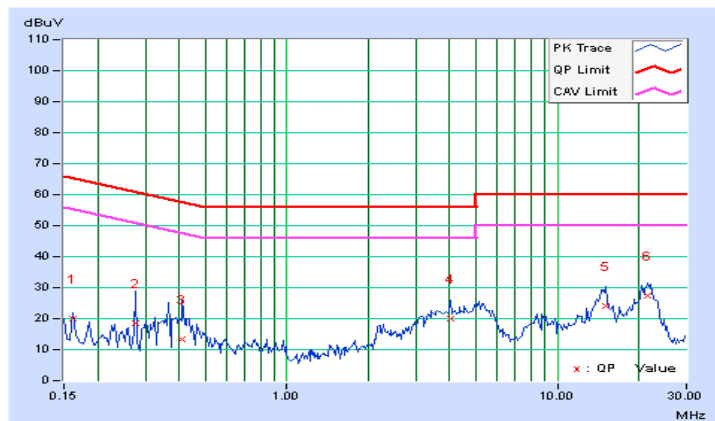



A D T

PHASE	Line 2	6dB BANDWIDTH	9kHz
TEST MODE	E		

No	Freq. [MHz]	Corr. Factor (dB)	Reading Value		Emission Level		Limit		Margin	
			[dB (uV)]		[dB (uV)]		[dB (uV)]		(dB)	
			Q.P.	AV.	Q.P.	AV.	Q.P.	AV.	Q.P.	AV.
1	0.17734	0.27	18.63	2.96	18.90	3.23	64.61	54.61	-45.71	-51.38
2	0.38047	0.30	13.39	5.69	13.69	5.99	58.27	48.27	-44.58	-42.28
3	0.83359	0.33	10.48	6.20	10.81	6.53	56.00	46.00	-45.19	-39.47
4	3.74219	0.43	18.42	14.72	18.85	15.15	56.00	46.00	-37.15	-30.85
5	14.85938	0.56	24.09	16.81	24.65	17.37	60.00	50.00	-35.35	-32.63
6	21.74609	0.61	26.64	21.55	27.25	22.16	60.00	50.00	-32.75	-27.84

- REMARKS:**
1. Q.P. and AV. are abbreviations of quasi-peak and average individually.
 2. The emission levels of other frequencies were very low against the limit.
 3. Margin value = Emission level - Limit value
 4. Correction factor = Insertion loss + Cable loss
 5. Emission Level = Correction Factor + Reading Value.

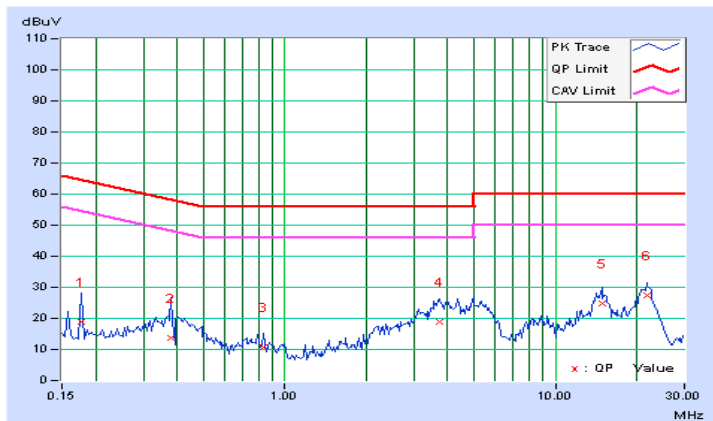



A D T

802.11n (20MHz)

PHASE	Line 1	6dB BANDWIDTH	9kHz
TEST MODE	F		

No	Freq. [MHz]	Corr. Factor (dB)	Reading Value		Emission Level		Limit		Margin	
			[dB (uV)]		[dB (uV)]		[dB (uV)]		(dB)	
			Q.P.	AV.	Q.P.	AV.	Q.P.	AV.	Q.P.	AV.
1	0.26328	0.29	18.15	5.67	18.44	5.96	61.33	51.33	-42.89	-45.37
2	0.39219	0.30	13.45	5.17	13.75	5.47	58.02	48.02	-44.27	-42.55
3	3.46484	0.41	18.25	14.47	18.66	14.88	56.00	46.00	-37.34	-31.12
4	5.07813	0.44	20.93	17.38	21.37	17.82	60.00	50.00	-38.63	-32.18
5	14.90234	0.53	24.32	17.14	24.85	17.67	60.00	50.00	-35.15	-32.33
6	21.93359	0.57	26.99	21.93	27.56	22.50	60.00	50.00	-32.44	-27.50

- REMARKS:**
1. Q.P. and AV. are abbreviations of quasi-peak and average individually.
 2. The emission levels of other frequencies were very low against the limit.
 3. Margin value = Emission level - Limit value
 4. Correction factor = Insertion loss + Cable loss
 5. Emission Level = Correction Factor + Reading Value.

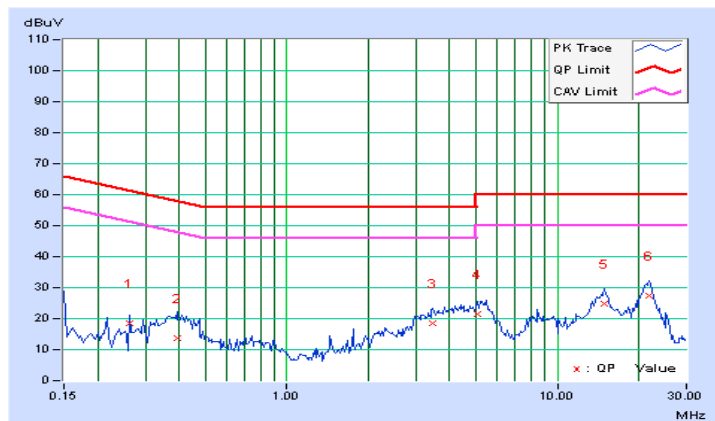



A D T

PHASE	Line 2	6dB BANDWIDTH	9kHz
TEST MODE	F		

No	Freq. [MHz]	Corr. Factor (dB)	Reading Value		Emission Level		Limit		Margin	
			[dB (uV)]		[dB (uV)]		[dB (uV)]		(dB)	
			Q.P.	AV.	Q.P.	AV.	Q.P.	AV.	Q.P.	AV.
1	0.26328	0.29	19.32	2.05	19.61	2.34	61.33	51.33	-41.72	-48.99
2	0.40391	0.30	13.05	5.10	13.35	5.40	57.77	47.77	-44.42	-42.37
3	3.51563	0.42	18.05	14.27	18.47	14.69	56.00	46.00	-37.53	-31.31
4	5.24609	0.46	22.01	17.89	22.47	18.35	60.00	50.00	-37.53	-31.65
5	14.31250	0.56	22.41	15.60	22.97	16.16	60.00	50.00	-37.03	-33.84
6	21.71875	0.61	26.82	22.33	27.43	22.94	60.00	50.00	-32.57	-27.06

- REMARKS:**
1. Q.P. and AV. are abbreviations of quasi-peak and average individually.
 2. The emission levels of other frequencies were very low against the limit.
 3. Margin value = Emission level - Limit value
 4. Correction factor = Insertion loss + Cable loss
 5. Emission Level = Correction Factor + Reading Value.

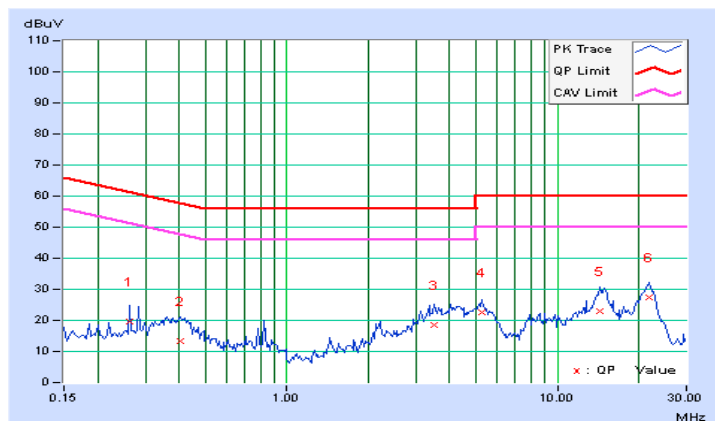



A D T

802.11n (20MHz)

PHASE	Line 1	6dB BANDWIDTH	9kHz
TEST MODE	G		

No	Freq. [MHz]	Corr. Factor (dB)	Reading Value		Emission Level		Limit		Margin	
			[dB (uV)]		[dB (uV)]		[dB (uV)]		(dB)	
			Q.P.	AV.	Q.P.	AV.	Q.P.	AV.	Q.P.	AV.
1	0.37266	0.30	12.87	5.36	13.17	5.66	58.44	48.44	-45.27	-42.78
2	0.46641	0.30	19.01	3.98	19.31	4.28	56.58	46.58	-37.26	-42.29
3	0.84141	0.33	10.35	9.68	10.68	10.01	56.00	46.00	-45.32	-35.99
4	3.89453	0.43	18.52	14.76	18.95	15.19	56.00	46.00	-37.05	-30.81
5	15.15625	0.53	21.85	13.04	22.38	13.57	60.00	50.00	-37.62	-36.43
6	21.97266	0.57	27.19	22.54	27.76	23.11	60.00	50.00	-32.24	-26.89

- REMARKS:**
1. Q.P. and AV. are abbreviations of quasi-peak and average individually.
 2. The emission levels of other frequencies were very low against the limit.
 3. Margin value = Emission level - Limit value
 4. Correction factor = Insertion loss + Cable loss
 5. Emission Level = Correction Factor + Reading Value.

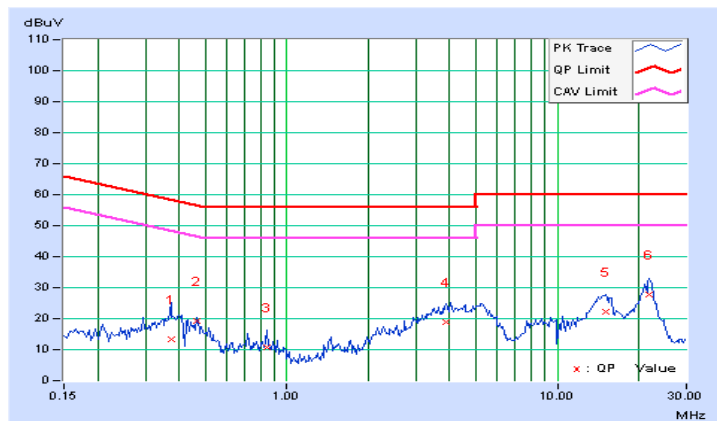



A D T

PHASE	Line 2	6dB BANDWIDTH	9kHz
TEST MODE	G		

No	Freq. [MHz]	Corr. Factor (dB)	Reading Value		Emission Level		Limit		Margin	
			[dB (uV)]		[dB (uV)]		[dB (uV)]		(dB)	
			Q.P.	AV.	Q.P.	AV.	Q.P.	AV.	Q.P.	AV.
1	0.19297	0.28	19.51	2.15	19.79	2.43	63.91	53.91	-44.12	-51.48
2	0.22031	0.28	17.64	2.69	17.92	2.97	62.81	52.81	-44.89	-49.84
3	0.43906	0.30	11.68	4.75	11.98	5.05	57.08	47.08	-45.10	-42.03
4	4.73828	0.45	19.83	15.95	20.28	16.40	56.00	46.00	-35.72	-29.60
5	14.71875	0.56	24.23	17.32	24.79	17.88	60.00	50.00	-35.21	-32.12
6	21.71869	0.61	26.84	22.44	27.45	23.05	60.00	50.00	-32.55	-26.95

- REMARKS:**
1. Q.P. and AV. are abbreviations of quasi-peak and average individually.
 2. The emission levels of other frequencies were very low against the limit.
 3. Margin value = Emission level - Limit value
 4. Correction factor = Insertion loss + Cable loss
 5. Emission Level = Correction Factor + Reading Value.

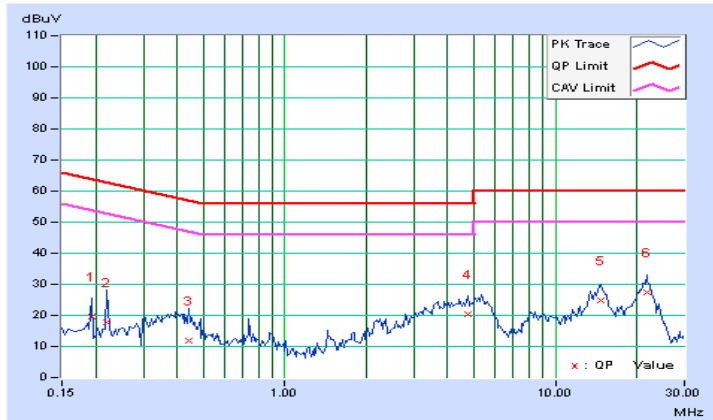

4.3 6dB BANDWIDTH MEASUREMENT

4.3.1 LIMITS OF 6dB BANDWIDTH MEASUREMENT

The minimum of 6dB Bandwidth Measurement is 0.5MHz.

4.3.2 TEST SETUP

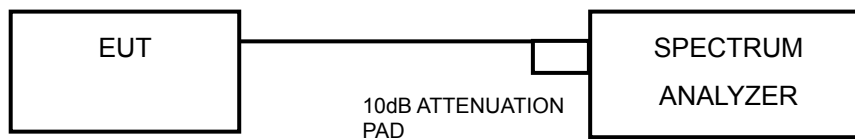

4.3.3 TEST INSTRUMENTS

Refer to section 4.1.2 to get information of above instrument.

4.3.4 TEST PROCEDURE

- a. Set resolution bandwidth (RBW) = 100kHz
- b. Set the video bandwidth (VBW) $\geq 3 \times$ RBW, Detector = Peak.
- c. Trace mode = max hold.
- d. Sweep = auto couple.
- e. Measure the maximum width of the emission that is constrained by the frequencies associated with the two amplitude points (upper and lower) that are attenuated by 6 dB relative to the maximum level measured in the fundamental emission

4.3.5 DEVIATION FROM TEST STANDARD

No deviation.

4.3.6 EUT OPERATING CONDITIONS

The software provided by client to enable the EUT under transmission condition continuously at lowest, middle and highest channel frequencies individually.



A D T

4.3.7 TEST RESULTS

Test Mode A

802.11a

CHANNEL	FREQUENCY (MHz)	6dB BANDWIDTH (MHz)			MINIMUM LIMIT (MHz)	PASS / FAIL
		CHAIN 0	CHAIN 1	CHAIN 2		
149	5745	16.39	16.45	16.41	0.5	PASS
157	5785	16.40	16.39	16.37	0.5	PASS
165	5825	16.40	16.39	16.36	0.5	PASS

802.11n (20MHz)

CHANNEL	FREQUENCY (MHz)	6dB BANDWIDTH (MHz)			MINIMUM LIMIT (MHz)	PASS / FAIL
		CHAIN 0	CHAIN 1	CHAIN 2		
149	5745	17.64	17.63	17.62	0.5	PASS
157	5785	17.61	17.61	17.61	0.5	PASS
165	5825	17.60	17.63	17.59	0.5	PASS

802.11n (40MHz)

CHANNEL	FREQUENCY (MHz)	6dB BANDWIDTH (MHz)			MINIMUM LIMIT (MHz)	PASS / FAIL
		CHAIN 0	CHAIN 1	CHAIN 2		
151	5755	36.17	36.42	36.40	0.5	PASS
159	5795	36.37	36.41	36.44	0.5	PASS

802.11ac (80MHz)

CHANNEL	FREQUENCY (MHz)	6dB BANDWIDTH (MHz)			MINIMUM LIMIT (MHz)	PASS / FAIL
		CHAIN 0	CHAIN 1	CHAIN 2		
155	5775	76.02	76.06	75.96	0.5	PASS



A D T

SPECTRUM PLOT OF WORST VALUE

802.11a

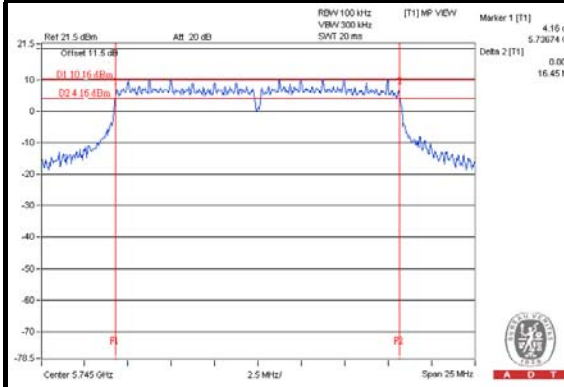

802.11n (20MHz)

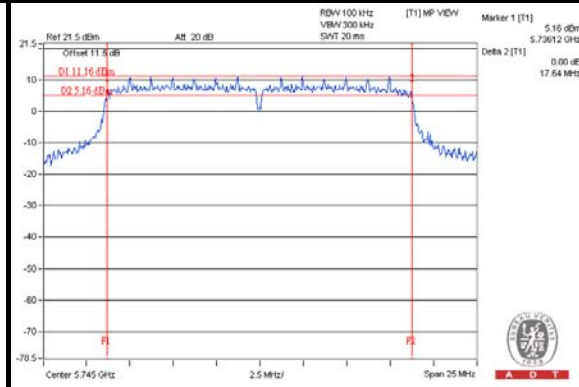

802.11n (40MHz)

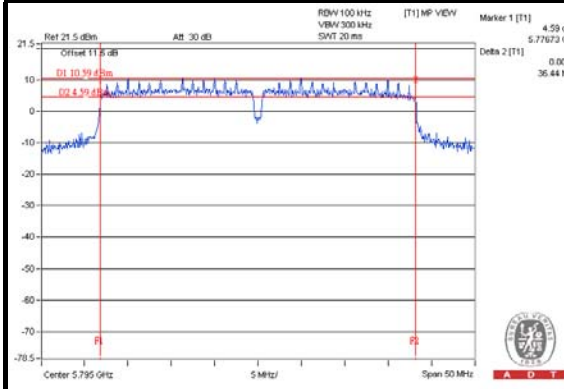

802.11ac (80MHz)

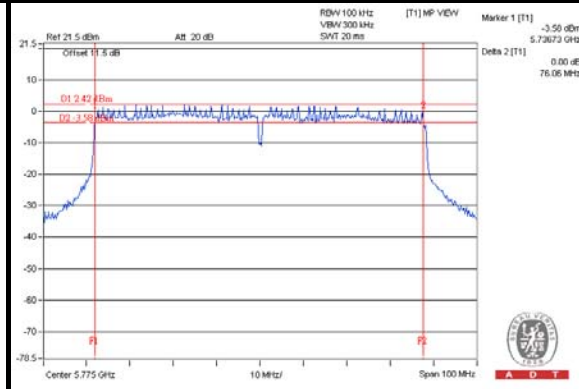



A D T

Test Mode B

802.11a

CHANNEL	FREQUENCY (MHz)	6dB BANDWIDTH (MHz)		MINIMUM LIMIT (MHz)	PASS / FAIL
		CHAIN 0	CHAIN 1		
149	5745	16.47	16.44	0.5	PASS
157	5785	16.44	16.42	0.5	PASS
165	5825	16.45	16.41	0.5	PASS

802.11n (20MHz)

CHANNEL	FREQUENCY (MHz)	6dB BANDWIDTH (MHz)		MINIMUM LIMIT (MHz)	PASS / FAIL
		CHAIN 0	CHAIN 1		
149	5745	17.64	17.63	0.5	PASS
157	5785	17.64	17.62	0.5	PASS
165	5825	17.65	17.64	0.5	PASS

802.11n (40MHz)

CHANNEL	FREQUENCY (MHz)	6dB BANDWIDTH (MHz)		MINIMUM LIMIT (MHz)	PASS / FAIL
		CHAIN 0	CHAIN 1		
151	5755	36.41	36.45	0.5	PASS
159	5795	36.45	36.40	0.5	PASS

802.11ac (80MHz)

CHANNEL	FREQUENCY (MHz)	6dB BANDWIDTH (MHz)		MINIMUM LIMIT (MHz)	PASS / FAIL
		CHAIN 0	CHAIN 1		
155	5775	76.04	76.01	0.5	PASS



A D T

SPECTRUM PLOT OF WORST VALUE

802.11a

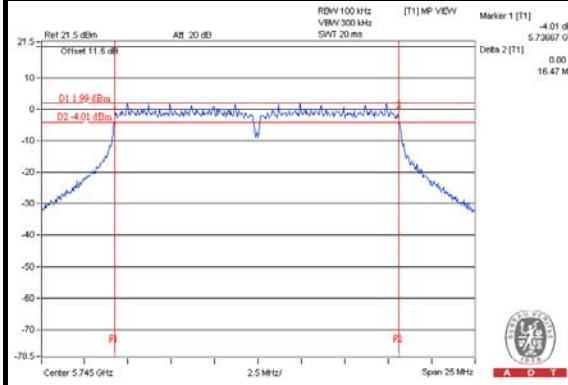

802.11n (20MHz)

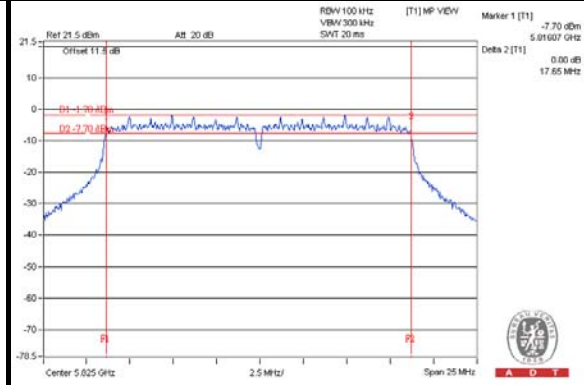

802.11n (40MHz)

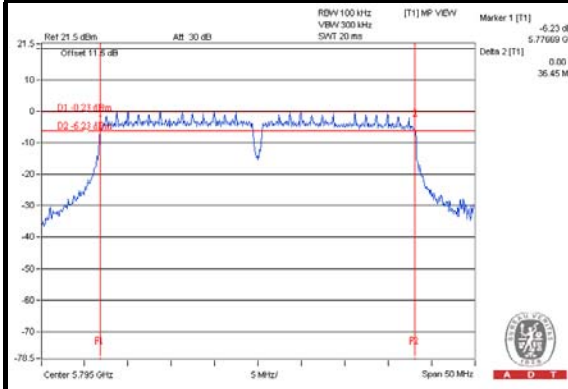

802.11ac (80MHz)

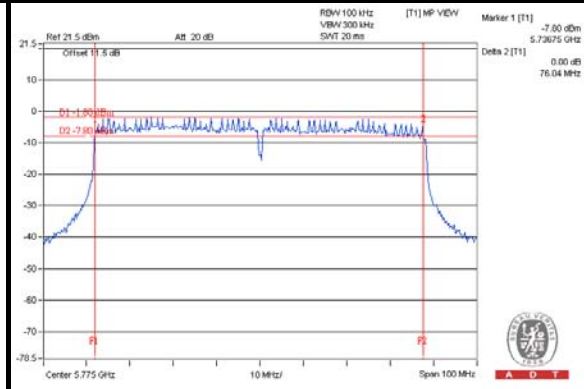



A D T

Test Mode C

802.11a

CHANNEL	FREQUENCY (MHz)	6dB BANDWIDTH (MHz)			MINIMUM LIMIT (MHz)	PASS / FAIL
		CHAIN 0	CHAIN 1	CHAIN 2		
149	5745	16.42	16.46	16.45	0.5	PASS
157	5785	16.44	16.43	16.44	0.5	PASS
165	5825	16.45	16.44	16.41	0.5	PASS

802.11n (20MHz)

CHANNEL	FREQUENCY (MHz)	6dB BANDWIDTH (MHz)			MINIMUM LIMIT (MHz)	PASS / FAIL
		CHAIN 0	CHAIN 1	CHAIN 2		
149	5745	17.66	17.63	17.64	0.5	PASS
157	5785	17.64	17.65	17.66	0.5	PASS
165	5825	17.66	17.65	17.66	0.5	PASS

802.11n (40MHz)

CHANNEL	FREQUENCY (MHz)	6dB BANDWIDTH (MHz)			MINIMUM LIMIT (MHz)	PASS / FAIL
		CHAIN 0	CHAIN 1	CHAIN 2		
151	5755	36.41	36.39	36.46	0.5	PASS
159	5795	36.44	36.38	36.42	0.5	PASS

802.11ac (80MHz)

CHANNEL	FREQUENCY (MHz)	6dB BANDWIDTH (MHz)			MINIMUM LIMIT (MHz)	PASS / FAIL
		CHAIN 0	CHAIN 1	CHAIN 2		
155	5775	76.05	76.08	76.00	0.5	PASS



A D T

SPECTRUM PLOT OF WORST VALUE

802.11a

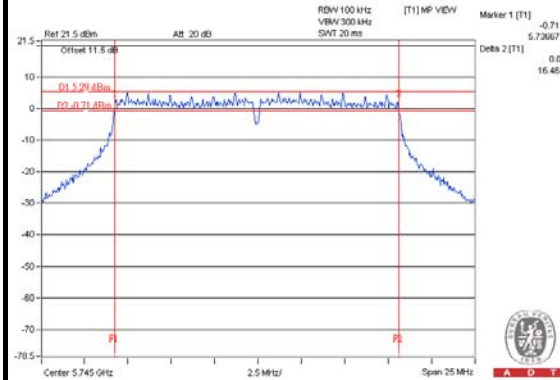

802.11n (20MHz)

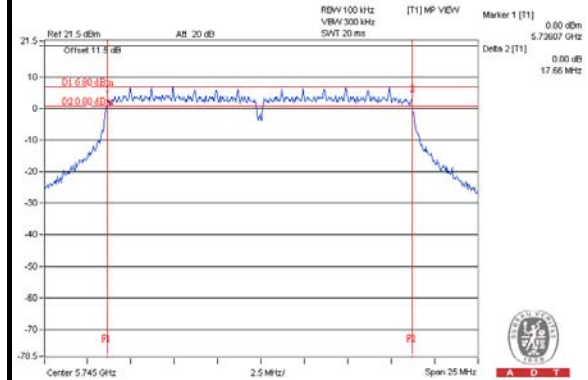

802.11n (40MHz)

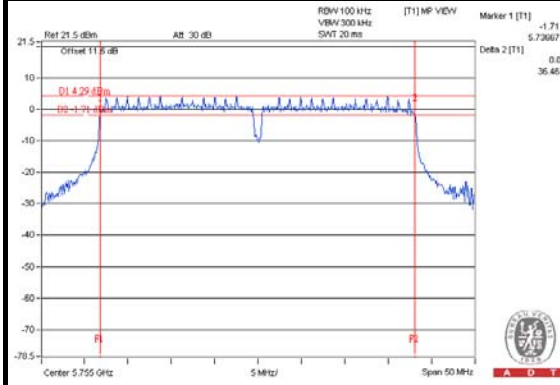

802.11ac (80MHz)

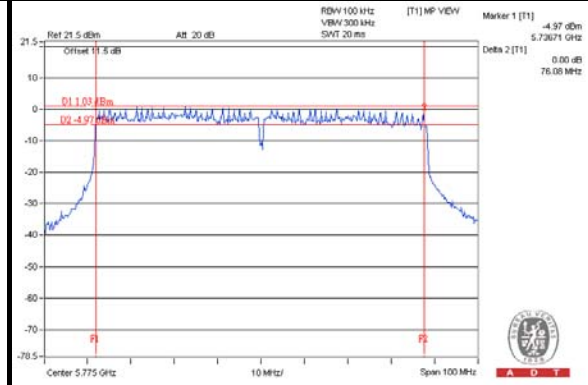

**Test Mode D****802.11a**

CHANNEL	FREQUENCY (MHz)	6dB BANDWIDTH (MHz)			MINIMUM LIMIT (MHz)	PASS / FAIL
		CHAIN 0	CHAIN 1	CHAIN 2		
149	5745	16.41	16.42	16.41	0.5	PASS
157	5785	16.42	16.40	16.39	0.5	PASS
165	5825	16.39	16.41	16.42	0.5	PASS

802.11n (20MHz)

CHANNEL	FREQUENCY (MHz)	6dB BANDWIDTH (MHz)			MINIMUM LIMIT (MHz)	PASS / FAIL
		CHAIN 0	CHAIN 1	CHAIN 2		
149	5745	17.65	17.62	17.64	0.5	PASS
157	5785	17.65	17.65	17.63	0.5	PASS
165	5825	17.64	17.63	17.64	0.5	PASS

802.11n (40MHz)

CHANNEL	FREQUENCY (MHz)	6dB BANDWIDTH (MHz)			MINIMUM LIMIT (MHz)	PASS / FAIL
		CHAIN 0	CHAIN 1	CHAIN 2		
151	5755	36.35	35.64	36.16	0.5	PASS
159	5795	36.43	36.41	36.11	0.5	PASS

802.11ac (80MHz)

CHANNEL	FREQUENCY (MHz)	6dB BANDWIDTH (MHz)			MINIMUM LIMIT (MHz)	PASS / FAIL
		CHAIN 0	CHAIN 1	CHAIN 2		
155	5775	76.06	76.08	75.78	0.5	PASS



A D T

SPECTRUM PLOT OF WORST VALUE

802.11a

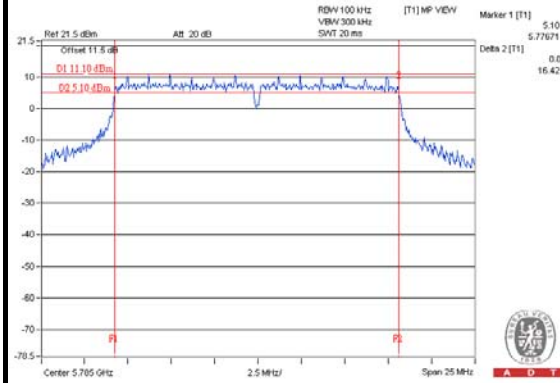

802.11n (20MHz)

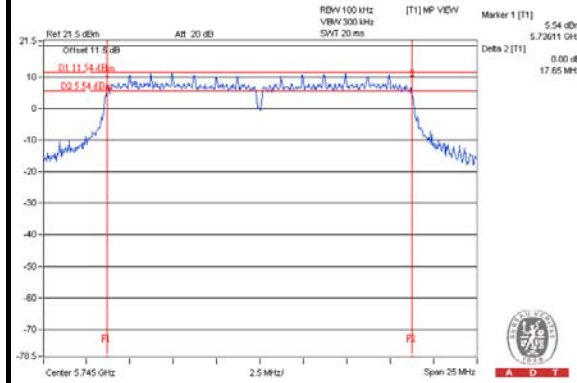

802.11n (40MHz)

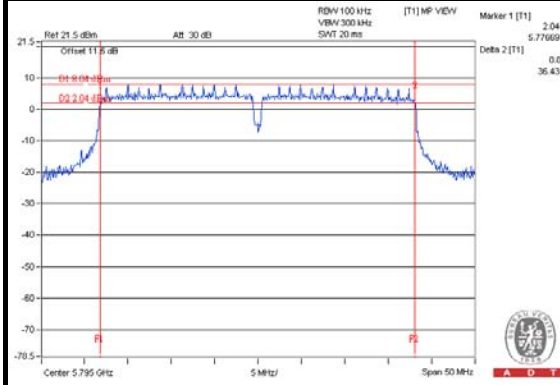

802.11ac (80MHz)

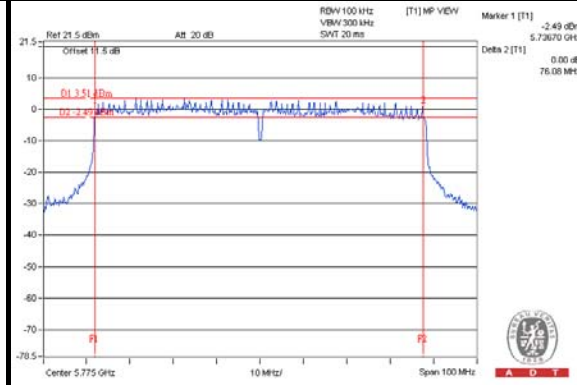

**Test Mode E****802.11a**

CHANNEL	FREQUENCY (MHz)	6dB BANDWIDTH (MHz)			MINIMUM LIMIT (MHz)	PASS / FAIL
		CHAIN 0	CHAIN 1	CHAIN 2		
149	5745	16.43	16.44	16.41	0.5	PASS
157	5785	16.40	16.40	16.43	0.5	PASS
165	5825	16.42	16.43	16.43	0.5	PASS

802.11n (20MHz)

CHANNEL	FREQUENCY (MHz)	6dB BANDWIDTH (MHz)			MINIMUM LIMIT (MHz)	PASS / FAIL
		CHAIN 0	CHAIN 1	CHAIN 2		
149	5745	17.65	17.65	17.62	0.5	PASS
157	5785	17.65	17.65	17.65	0.5	PASS
165	5825	17.65	17.65	17.64	0.5	PASS

802.11n (40MHz)

CHANNEL	FREQUENCY (MHz)	6dB BANDWIDTH (MHz)			MINIMUM LIMIT (MHz)	PASS / FAIL
		CHAIN 0	CHAIN 1	CHAIN 2		
151	5755	36.43	35.62	36.39	0.5	PASS
159	5795	36.42	36.11	36.45	0.5	PASS

802.11ac (80MHz)

CHANNEL	FREQUENCY (MHz)	6dB BANDWIDTH (MHz)			MINIMUM LIMIT (MHz)	PASS / FAIL
		CHAIN 0	CHAIN 1	CHAIN 2		
155	5775	76.02	75.48	75.66	0.5	PASS

SPECTRUM PLOT OF WORST VALUE

802.11a

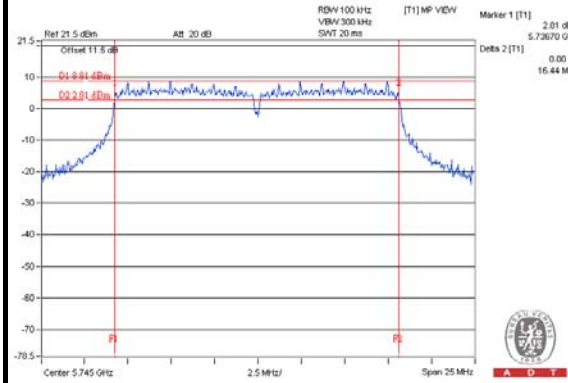

802.11n (20MHz)

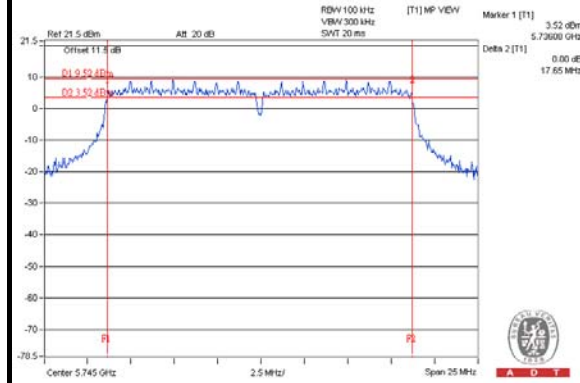

802.11n (40MHz)

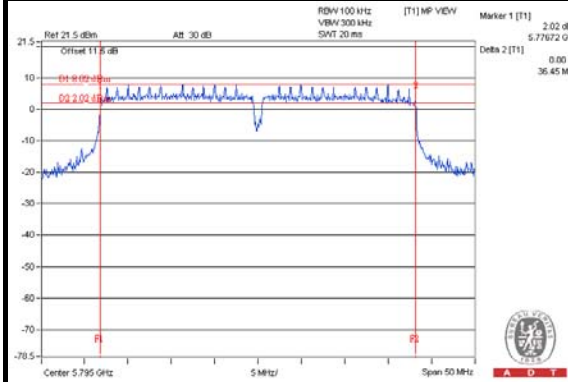

802.11ac (80MHz)

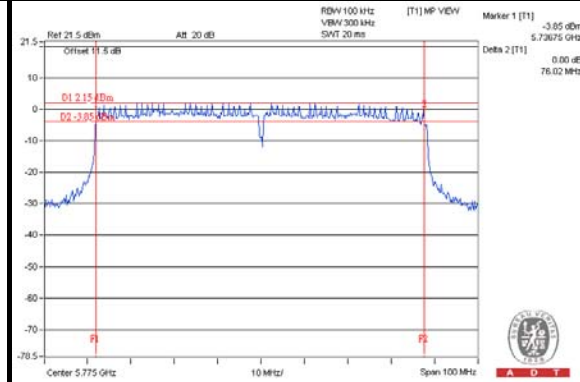

**Test Mode F****802.11a**

CHANNEL	FREQUENCY (MHz)	6dB BANDWIDTH (MHz)			MINIMUM LIMIT (MHz)	PASS / FAIL
		CHAIN 0	CHAIN 1	CHAIN 2		
149	5745	16.43	16.41	16.43	0.5	PASS
157	5785	16.38	16.39	16.42	0.5	PASS
165	5825	16.40	16.39	16.36	0.5	PASS

802.11n (20MHz)

CHANNEL	FREQUENCY (MHz)	6dB BANDWIDTH (MHz)			MINIMUM LIMIT (MHz)	PASS / FAIL
		CHAIN 0	CHAIN 1	CHAIN 2		
149	5745	17.63	17.63	17.62	0.5	PASS
157	5785	17.61	17.62	17.61	0.5	PASS
165	5825	17.62	17.61	17.61	0.5	PASS

802.11n (40MHz)

CHANNEL	FREQUENCY (MHz)	6dB BANDWIDTH (MHz)			MINIMUM LIMIT (MHz)	PASS / FAIL
		CHAIN 0	CHAIN 1	CHAIN 2		
151	5755	36.47	35.61	36.44	0.5	PASS
159	5795	36.36	36.43	36.45	0.5	PASS

802.11ac (80MHz)

CHANNEL	FREQUENCY (MHz)	6dB BANDWIDTH (MHz)			MINIMUM LIMIT (MHz)	PASS / FAIL
		CHAIN 0	CHAIN 1	CHAIN 2		
155	5775	76.09	75.99	75.95	0.5	PASS

SPECTRUM PLOT OF WORST VALUE

802.11a

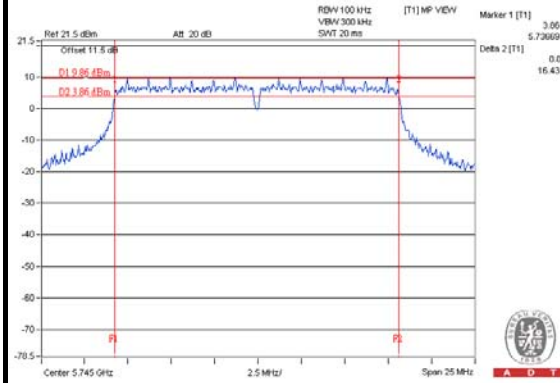

802.11n (20MHz)

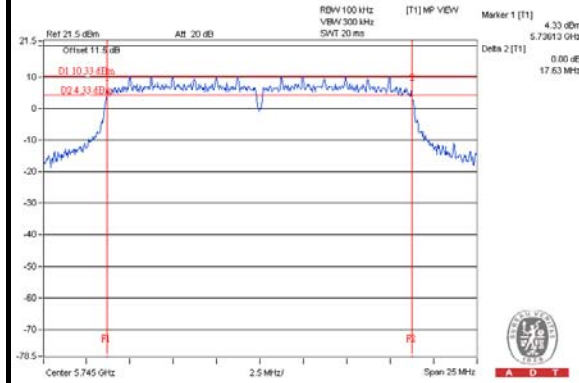

802.11n (40MHz)

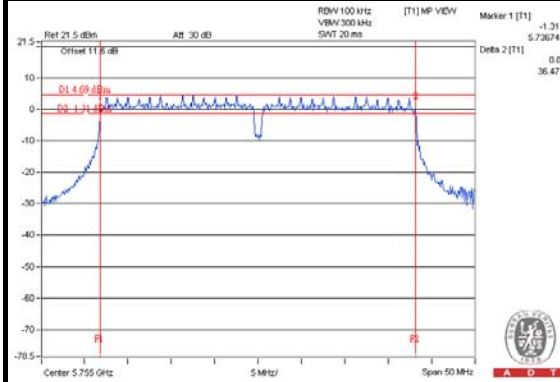

802.11ac (80MHz)

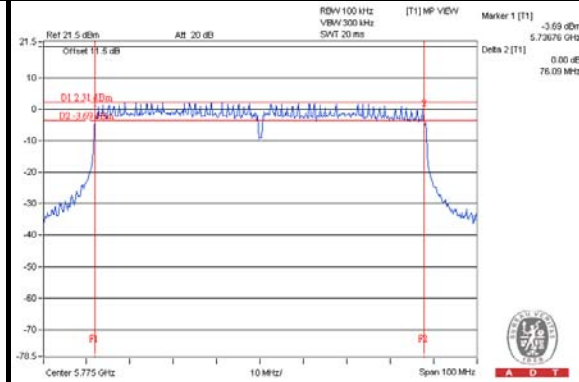

**Test Mode G****802.11a**

CHANNEL	FREQUENCY (MHz)	6dB BANDWIDTH (MHz)			MINIMUM LIMIT (MHz)	PASS / FAIL
		CHAIN 0	CHAIN 1	CHAIN 2		
149	5745	16.53	16.49	16.41	0.5	PASS
157	5785	16.55	16.39	16.43	0.5	PASS
165	5825	16.45	16.40	16.40	0.5	PASS

802.11n (20MHz)

CHANNEL	FREQUENCY (MHz)	6dB BANDWIDTH (MHz)			MINIMUM LIMIT (MHz)	PASS / FAIL
		CHAIN 0	CHAIN 1	CHAIN 2		
149	5745	17.64	17.65	17.64	0.5	PASS
157	5785	17.66	17.65	17.64	0.5	PASS
165	5825	17.64	17.65	17.65	0.5	PASS

802.11n (40MHz)

CHANNEL	FREQUENCY (MHz)	6dB BANDWIDTH (MHz)			MINIMUM LIMIT (MHz)	PASS / FAIL
		CHAIN 0	CHAIN 1	CHAIN 2		
151	5755	36.35	36.46	35.96	0.5	PASS
159	5795	35.84	36.38	36.15	0.5	PASS

802.11ac (80MHz)

CHANNEL	FREQUENCY (MHz)	6dB BANDWIDTH (MHz)			MINIMUM LIMIT (MHz)	PASS / FAIL
		CHAIN 0	CHAIN 1	CHAIN 2		
155	5775	76.08	76.04	75.86	0.5	PASS

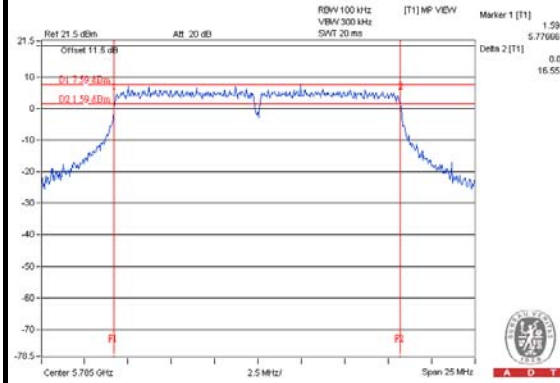
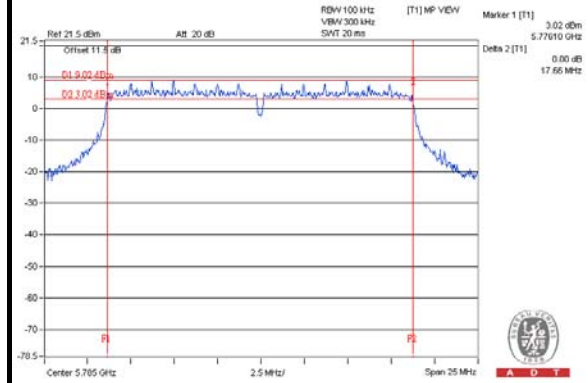
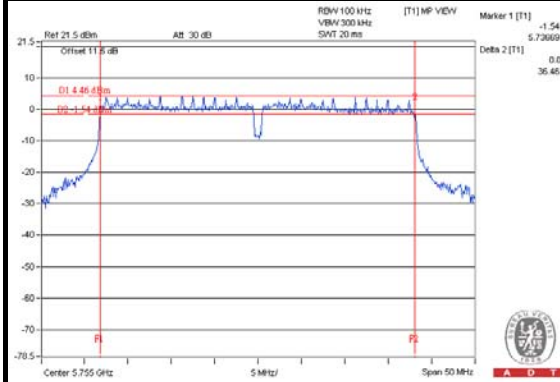
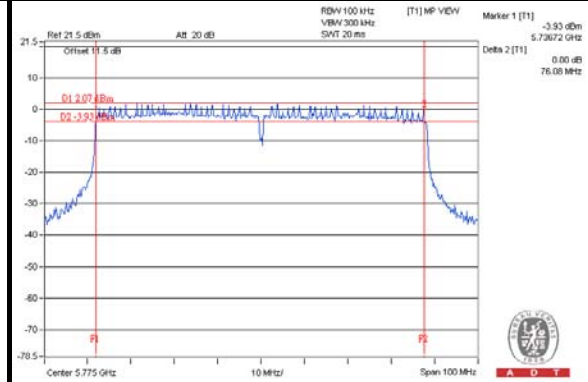
SPECTRUM PLOT OF WORST VALUE**802.11a****802.11n (20MHz)****802.11n (40MHz)****802.11ac (80MHz)**

4.4 CONDUCTED OUTPUT POWER

4.4.1 LIMITS OF CONDUCTED OUTPUT POWER MEASUREMENT

For systems using digital modulation in the 5725 –5850 MHz bands: 1 Watt (30dBm)

Per KDB 662911 D01 Multiple Transmitter Output v02r01 Method of conducted output power measurement on IEEE 802.11 devices,

Array Gain = 0 dB (i.e., no array gain) for NANT \leq 4;

Array Gain = 0 dB (i.e., no array gain) for channel widths \geq 40 MHz for any NANT;

Array Gain = 5 log(NANT/NSS) dB or 3 dB, whichever is less for 20-MHz channel widths with NANT \geq 5.

For power measurements on all other devices: Array Gain = 10 log(NANT/NSS) dB.

4.4.2 TEST SETUP

For 802.11a, 802.11n (20MHz), 802.11n (40MHz)

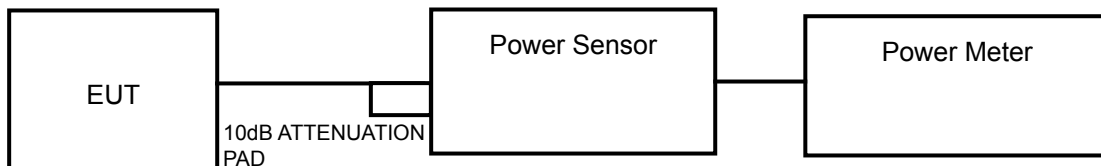

For 802.11ac (80MHz)



4.4.3 INSTRUMENTS

Refer to section 4.1.2 to get information of above instrument.



A D T

4.4.4 TEST PROCEDURES

For 802.11a, 802.11ac (20MHz), 802.11ac (40MHz)

Method PM is used to perform output power measurement, trigger and gating function of wide band power meter is enabled to measure max output power of TX on burst. Duty factor is not added to measured value.

For 802.11ac (80MHz)

Method SA-1

Average

- 1) Set the analyzer span to a minimum of 1.5 times the EBW.
- 2) Set the RBW = 1 MHz.
- 3) Set the VBW = 3 MHz.
- 4) Number of measurement points in the sweep . $2 \times (\text{span}/\text{RBW})$.
- 5) Sweep time = auto couple.
- 6) Detector = power averaging (RMS) or sample.
- 7) Employ trace averaging in power averaging (RMS) mode over a minimum of 100 traces.
- 8) Use the spectrum analyzer's integrated band power measurement function with band limits set equal to the EBW band edges.

4.4.5 DEVIATION FROM TEST STANDARD

No deviation.

4.4.6 EUT OPERATING CONDITIONS

Same as Item 4.3.6.



A D T

4.4.7 TEST RESULTS

FOR AVERAGE POWER

Test Mode A

802.11a

CHAN.	CHAN. FREQ. (MHz)	AVG. POWER (dBm)			TOTAL POWER (mW)	TOTAL POWER (dBm)	LIMIT (dBm)	PASS / FAIL
		CHAIN 0	CHAIN 1	CHAIN 2				
149	5745	23.20	22.93	23.55	631.730	28.01	30	PASS
157	5785	25.28	24.97	25.30	990.182	29.96	30	PASS
165	5825	25.04	25.03	25.18	967.184	29.86	30	PASS

802.11n (20MHz)

CHAN.	CHAN. FREQ. (MHz)	AVG. POWER (dBm)			TOTAL POWER (mW)	TOTAL POWER (dBm)	LIMIT (dBm)	PASS / FAIL
		CHAIN 0	CHAIN 1	CHAIN 2				
149	5745	23.24	22.91	23.61	635.912	28.03	30	PASS
157	5785	25.07	24.51	25.13	929.691	29.68	30	PASS
165	5825	25.16	25.04	25.09	970.098	29.87	30	PASS

802.11n (40MHz)

CHAN.	CHAN. FREQ. (MHz)	AVG. POWER (dBm)			TOTAL POWER (mW)	TOTAL POWER (dBm)	LIMIT (dBm)	PASS / FAIL
		CHAIN 0	CHAIN 1	CHAIN 2				
151	5755	19.82	19.57	20.13	289.552	24.62	30	PASS
159	5795	25.45	24.59	25.01	955.449	29.80	30	PASS

802.11ac (80MHz)

CHAN.	CHAN. FREQ. (MHz)	AVG. POWER (dBm)			TOTAL POWER (mW)	TOTAL POWER (dBm)	LIMIT (dBm)	PASS / FAIL
		CHAIN 0	CHAIN 1	CHAIN 2				
155	5775	20.04	19.95	20.54	313.020	24.96	30	PASS

**Test Mode B****802.11a**

CHAN.	FREQ. (MHz)	AVG. POWER (dBm)		TOTAL POWER (mW)	TOTAL POWER (dBm)	LIMIT (dBm)	PASS / FAIL
		CHAIN 0	CHAIN 1				
149	5745	14.73	14.85	60.266	17.80	30	PASS
157	5785	13.65	14.61	52.081	17.17	30	PASS
165	5825	11.95	12.83	34.855	15.42	30	PASS

802.11n (20MHz)

CHAN.	FREQ. (MHz)	AVG. POWER (dBm)		TOTAL POWER (mW)	TOTAL POWER (dBm)	LIMIT (dBm)	PASS / FAIL
		CHAIN 0	CHAIN 1				
149	5745	13.29	13.27	42.562	16.29	30	PASS
157	5785	11.11	11.73	27.806	14.44	30	PASS
165	5825	10.85	11.78	27.228	14.35	30	PASS

802.11n (40MHz)

CHAN.	FREQ. (MHz)	AVG. POWER (dBm)		TOTAL POWER (mW)	TOTAL POWER (dBm)	LIMIT (dBm)	PASS / FAIL
		CHAIN 0	CHAIN 1				
151	5755	15.77	16.33	80.711	19.07	30	PASS
159	5795	15.14	15.53	68.386	18.35	30	PASS

802.11ac (80MHz)

CHAN.	FREQ. (MHz)	AVG. POWER (dBm)		TOTAL POWER (mW)	TOTAL POWER (dBm)	LIMIT (dBm)	PASS / FAIL
		CHAIN 0	CHAIN 1				
155	5775	15.96	16.41	83.198	19.20	30	PASS



Test Mode C

802.11a

CHAN.	CHAN. FREQ. (MHz)	AVG. POWER (dBm)			TOTAL POWER (mW)	TOTAL POWER (dBm)	LIMIT (dBm)	PASS / FAIL
		CHAIN 0	CHAIN 1	CHAIN 2				
149	5745	19.00	18.63	20.03	253.072	24.03	30	PASS
157	5785	19.29	19.12	20.12	269.378	24.30	30	PASS
165	5825	19.08	19.01	19.80	256.025	24.08	30	PASS

802.11n (20MHz)

CHAN.	CHAN. FREQ. (MHz)	AVG. POWER (dBm)			TOTAL POWER (mW)	TOTAL POWER (dBm)	LIMIT (dBm)	PASS / FAIL
		CHAIN 0	CHAIN 1	CHAIN 2				
149	5745	19.31	18.96	20.16	267.768	24.28	30	PASS
157	5785	19.22	19.03	19.91	261.492	24.17	30	PASS
165	5825	19.10	18.97	19.85	256.774	24.10	30	PASS

802.11n (40MHz)

CHAN.	CHAN. FREQ. (MHz)	AVG. POWER (dBm)			TOTAL POWER (mW)	TOTAL POWER (dBm)	LIMIT (dBm)	PASS / FAIL
		CHAIN 0	CHAIN 1	CHAIN 2				
151	5755	19.54	19.14	20.03	272.678	24.36	30	PASS
159	5795	19.30	19.00	20.01	264.778	24.23	30	PASS

802.11ac (80MHz)

CHAN.	CHAN. FREQ. (MHz)	AVG. POWER (dBm)			TOTAL POWER (mW)	TOTAL POWER (dBm)	LIMIT (dBm)	PASS / FAIL
		CHAIN 0	CHAIN 1	CHAIN 2				
155	5775	19.39	19.09	19.90	265.716	24.24	30	PASS



A D T

Test Mode D

802.11a

CHAN.	CHAN. FREQ. (MHz)	AVG. POWER (dBm)			TOTAL POWER (mW)	TOTAL POWER (dBm)	LIMIT (dBm)	PASS / FAIL
		CHAIN 0	CHAIN 1	CHAIN 2				
149	5745	22.99	22.49	23.24	587.349	27.69	30	PASS
157	5785	22.91	22.80	23.36	602.750	27.80	30	PASS
165	5825	23.00	22.95	23.48	619.612	27.92	30	PASS

802.11n (20MHz)

CHAN.	CHAN. FREQ. (MHz)	AVG. POWER (dBm)			TOTAL POWER (mW)	TOTAL POWER (dBm)	LIMIT (dBm)	PASS / FAIL
		CHAIN 0	CHAIN 1	CHAIN 2				
149	5745	22.87	22.59	23.14	581.257	27.64	30	PASS
157	5785	22.97	22.72	23.47	607.552	27.84	30	PASS
165	5825	23.19	22.98	23.46	628.878	27.99	30	PASS

802.11n (40MHz)

CHAN.	CHAN. FREQ. (MHz)	AVG. POWER (dBm)			TOTAL POWER (mW)	TOTAL POWER (dBm)	LIMIT (dBm)	PASS / FAIL
		CHAIN 0	CHAIN 1	CHAIN 2				
151	5755	19.82	19.57	20.13	289.552	24.62	30	PASS
159	5795	22.95	22.60	23.17	586.703	27.68	30	PASS

802.11ac (80MHz)

CHAN.	CHAN. FREQ. (MHz)	AVG. POWER (dBm)			TOTAL POWER (mW)	TOTAL POWER (dBm)	LIMIT (dBm)	PASS / FAIL
		CHAIN 0	CHAIN 1	CHAIN 2				
155	5775	20.04	19.95	20.54	313.020	24.96	30	PASS



A D T

Test Mode E

802.11a

CHAN.	CHAN. FREQ. (MHz)	AVG. POWER (dBm)			TOTAL POWER (mW)	TOTAL POWER (dBm)	LIMIT (dBm)	PASS / FAIL
		CHAIN 0	CHAIN 1	CHAIN 2				
149	5745	21.83	20.49	20.96	389.087	25.90	30	PASS
157	5785	21.58	21.05	20.79	391.180	25.92	30	PASS
165	5825	21.75	21.14	21.06	407.285	26.10	30	PASS

802.11n (20MHz)

CHAN.	CHAN. FREQ. (MHz)	AVG. POWER (dBm)			TOTAL POWER (mW)	TOTAL POWER (dBm)	LIMIT (dBm)	PASS / FAIL
		CHAIN 0	CHAIN 1	CHAIN 2				
149	5745	22.62	21.50	21.86	477.526	26.79	30	PASS
157	5785	21.89	21.90	21.87	463.222	26.66	30	PASS
165	5825	22.51	22.31	22.21	514.795	27.12	30	PASS

802.11n (40MHz)

CHAN.	CHAN. FREQ. (MHz)	AVG. POWER (dBm)			TOTAL POWER (mW)	TOTAL POWER (dBm)	LIMIT (dBm)	PASS / FAIL
		CHAIN 0	CHAIN 1	CHAIN 2				
151	5755	19.82	19.57	20.13	289.552	24.62	30	PASS
159	5795	23.28	22.28	22.35	553.649	27.43	30	PASS

802.11ac (80MHz)

CHAN.	CHAN. FREQ. (MHz)	AVG. POWER (dBm)			TOTAL POWER (mW)	TOTAL POWER (dBm)	LIMIT (dBm)	PASS / FAIL
		CHAIN 0	CHAIN 1	CHAIN 2				
155	5775	20.04	19.95	20.54	313.020	24.96	30	PASS



A D T

Test Mode F

802.11a

CHAN.	CHAN. FREQ. (MHz)	AVG. POWER (dBm)			TOTAL POWER (mW)	TOTAL POWER (dBm)	LIMIT (dBm)	PASS / FAIL
		CHAIN 0	CHAIN 1	CHAIN 2				
149	5745	22.16	21.88	22.68	503.960	27.02	30	PASS
157	5785	24.16	24.12	24.22	783.082	28.94	30	PASS
165	5825	24.03	23.71	23.81	728.329	28.62	30	PASS

802.11n (20MHz)

CHAN.	CHAN. FREQ. (MHz)	AVG. POWER (dBm)			TOTAL POWER (mW)	TOTAL POWER (dBm)	LIMIT (dBm)	PASS / FAIL
		CHAIN 0	CHAIN 1	CHAIN 2				
149	5745	22.12	21.56	22.73	493.648	26.93	30	PASS
157	5785	24.27	24.01	24.22	783.310	28.94	30	PASS
165	5825	24.24	24.16	24.27	793.377	28.99	30	PASS

802.11n (40MHz)

CHAN.	CHAN. FREQ. (MHz)	AVG. POWER (dBm)			TOTAL POWER (mW)	TOTAL POWER (dBm)	LIMIT (dBm)	PASS / FAIL
		CHAIN 0	CHAIN 1	CHAIN 2				
151	5755	19.82	19.57	20.13	289.552	24.62	30	PASS
159	5795	23.82	23.77	23.89	724.129	28.60	30	PASS

802.11ac (80MHz)

CHAN.	CHAN. FREQ. (MHz)	AVG. POWER (dBm)			TOTAL POWER (mW)	TOTAL POWER (dBm)	LIMIT (dBm)	PASS / FAIL
		CHAIN 0	CHAIN 1	CHAIN 2				
155	5775	20.04	19.95	20.54	313.020	24.96	30	PASS

**Test Mode G****802.11a**

CHAN.	CHAN. FREQ. (MHz)	AVG. POWER (dBm)			TOTAL POWER (mW)	TOTAL POWER (dBm)	LIMIT (dBm)	PASS / FAIL
		CHAIN 0	CHAIN 1	CHAIN 2				
149	5745	23.20	22.93	23.55	631.730	28.01	30	PASS
157	5785	20.84	20.80	21.67	388.458	25.89	30	PASS
165	5825	20.72	20.76	21.45	376.793	25.76	30	PASS

802.11n (20MHz)

CHAN.	CHAN. FREQ. (MHz)	AVG. POWER (dBm)			TOTAL POWER (mW)	TOTAL POWER (dBm)	LIMIT (dBm)	PASS / FAIL
		CHAIN 0	CHAIN 1	CHAIN 2				
149	5745	23.24	22.91	23.61	635.912	28.03	30	PASS
157	5785	21.49	21.45	22.28	449.610	26.53	30	PASS
165	5825	21.90	21.85	22.25	475.871	26.77	30	PASS

802.11n (40MHz)

CHAN.	CHAN. FREQ. (MHz)	AVG. POWER (dBm)			TOTAL POWER (mW)	TOTAL POWER (dBm)	LIMIT (dBm)	PASS / FAIL
		CHAIN 0	CHAIN 1	CHAIN 2				
151	5755	19.82	19.57	20.13	289.552	24.62	30	PASS
159	5795	23.17	23.01	23.53	632.901	28.01	30	PASS

802.11ac (80MHz)

CHAN.	CHAN. FREQ. (MHz)	AVG. POWER (dBm)			TOTAL POWER (mW)	TOTAL POWER (dBm)	LIMIT (dBm)	PASS / FAIL
		CHAIN 0	CHAIN 1	CHAIN 2				
155	5775	20.04	19.95	20.54	313.020	24.96	30	PASS

4.5 POWER SPECTRAL DENSITY MEASUREMENT

4.5.1 LIMITS OF POWER SPECTRAL DENSITY MEASUREMENT

The Maximum of Power Spectral Density Measurement is 8dBm.

4.5.2 TEST SETUP

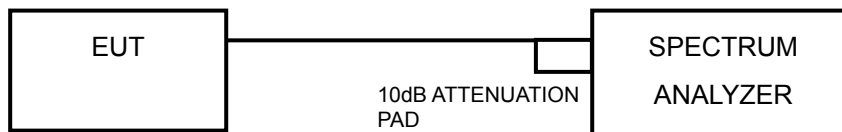

4.5.3 TEST INSTRUMENTS

Refer to section 4.1.2 to get information of above instrument.

4.5.4 TEST PROCEDURE.

- a. Set the RBW = 3 kHz, VBW = 10 kHz, Detector = peak.
- b. Sweep time = auto couple, Trace mode = max hold, allow trace to fully stabilize.
- c. Use the peak marker function to determine the maximum power level in any 100 kHz band segment within the fundamental EBW.

4.5.5 DEVIATION FROM TEST STANDARD

No deviation.

4.5.6 EUT OPERATING CONDITION

Same as item 4.3.6.



A D T

4.5.7 TEST RESULTS

Test Mode A

802.11a

TX chain	Chan.	Freq. (MHz)	PSD (dBm/3kHz)	10 log (N=3) dB	Total PSD without Duty Factor (dBm/3kHz)	Duty Factor	Total PSD with Duty Factor (dBm/3kHz)	Limit (dBm/3kHz)	PASS /FAIL
0	149	5745	-10.16	4.77	-5.39	0.17	-5.22	4.23	PASS
	157	5785	-8.20	4.77	-3.43	0.17	-3.26	4.23	PASS
	165	5825	-9.09	4.77	-4.32	0.17	-4.15	4.23	PASS
1	149	5745	-10.69	4.77	-5.92	0.17	-5.75	4.23	PASS
	157	5785	-8.21	4.77	-3.44	0.17	-3.27	4.23	PASS
	165	5825	-9.04	4.77	-4.27	0.17	-4.10	4.23	PASS
2	149	5745	-10.19	4.77	-5.42	0.17	-5.25	4.23	PASS
	157	5785	-9.15	4.77	-4.38	0.17	-4.21	4.23	PASS
	165	5825	-9.36	4.77	-4.59	0.17	-4.42	4.23	PASS

NOTE: Directional gain = $5\text{dBi} + 10\log(3) = 9.77\text{dBi} > 6\text{dBi}$, so the power density limit shall be reduced to $8-(9.77-6) = 4.23\text{dBm}$.

802.11n (20MHz)

TX chain	Chan.	Freq. (MHz)	PSD (dBm/3kHz)	10 log (N=3) dB	Total PSD without Duty Factor (dBm/3kHz)	Duty Factor	Total PSD with Duty Factor (dBm/3kHz)	Limit (dBm/3kHz)	PASS /FAIL
0	149	5745	-10.64	4.77	-5.87	0.19	-5.68	4.23	PASS
	157	5785	-8.80	4.77	-4.03	0.19	-3.84	4.23	PASS
	165	5825	-9.36	4.77	-4.59	0.19	-4.40	4.23	PASS
1	149	5745	-10.66	4.77	-5.89	0.19	-5.70	4.23	PASS
	157	5785	-9.43	4.77	-4.66	0.19	-4.47	4.23	PASS
	165	5825	-9.61	4.77	-4.84	0.19	-4.65	4.23	PASS
2	149	5745	-10.99	4.77	-6.22	0.19	-6.03	4.23	PASS
	157	5785	-9.34	4.77	-4.57	0.19	-4.38	4.23	PASS
	165	5825	-8.70	4.77	-3.93	0.19	-3.74	4.23	PASS

NOTE: Directional gain = $5\text{dBi} + 10\log(3) = 9.77\text{dBi} > 6\text{dBi}$, so the power density limit shall be reduced to $8-(9.77-6) = 4.23\text{dBm}$.



A D T

802.11n (40MHz)

TX chain	Chan.	Freq. (MHz)	PSD (dBm/3kHz)	10 log (N=3) dB	Total PSD without Duty Factor (dBm/3kHz)	Duty Factor	Total PSD with Duty Factor (dBm/3kHz)	Limit (dBm/3kHz)	PASS /FAIL
0	151	5755	-15.65	4.77	-10.88	0.32	-10.56	4.23	PASS
	159	5795	-12.26	4.77	-7.49	0.32	-7.17	4.23	PASS
1	151	5755	-16.57	4.77	-11.80	0.32	-11.48	4.23	PASS
	159	5795	-11.97	4.77	-7.20	0.32	-6.88	4.23	PASS
2	151	5755	-15.49	4.77	-10.72	0.32	-10.40	4.23	PASS
	159	5795	-11.58	4.77	-6.81	0.32	-6.49	4.23	PASS

NOTE: Directional gain = $5\text{dBi} + 10\log(3) = 9.77\text{dBi} > 6\text{dBi}$, so the power density limit shall be reduced to $8-(9.77-6) = 4.23\text{dBm}$.

802.11ac (80MHz)

TX chain	Chan.	Freq. (MHz)	PSD (dBm/3kHz)	10 log (N=3) dB	Total PSD without Duty Factor (dBm/3kHz)	Duty Factor	Total PSD with Duty Factor (dBm/3kHz)	Limit (dBm/3kHz)	PASS /FAIL
0	155	5775	-19.76	4.77	-14.99	0.68	-14.31	4.23	PASS
1	155	5775	-20.03	4.77	-15.26	0.68	-14.58	4.23	PASS
2	155	5775	-18.82	4.77	-14.05	0.68	-13.37	4.23	PASS

NOTE: Directional gain = $5\text{dBi} + 10\log(3) = 9.77\text{dBi} > 6\text{dBi}$, so the power density limit shall be reduced to $8-(9.77-6) = 4.23\text{dBm}$.



A D T

SPECTRUM PLOT OF WORST VALUE

802.11a

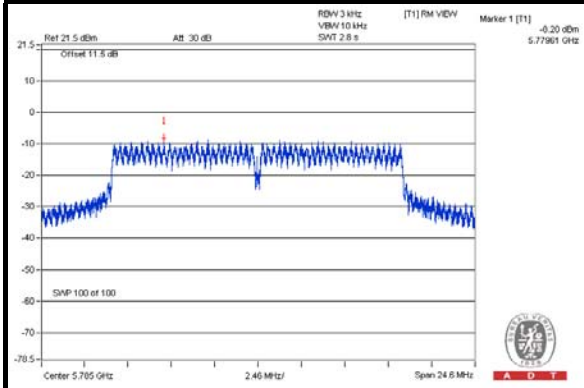

802.11n (20MHz)

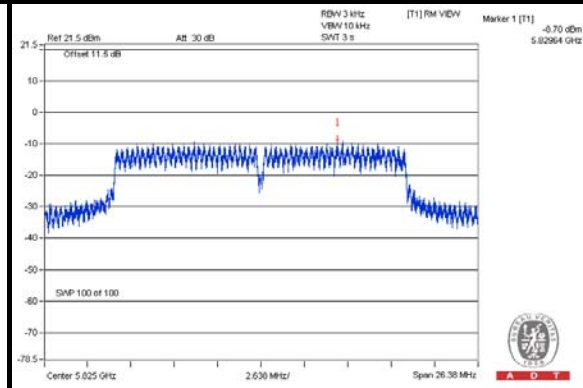

802.11n (40MHz)

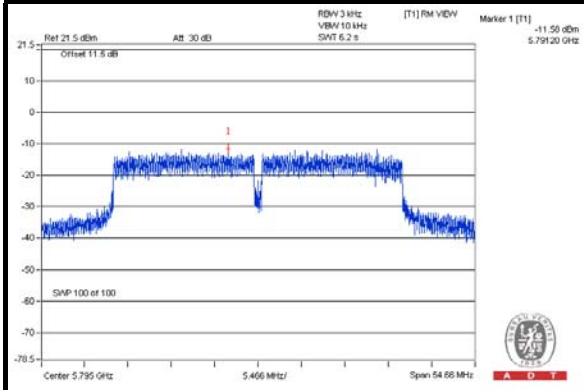

802.11ac (80MHz)

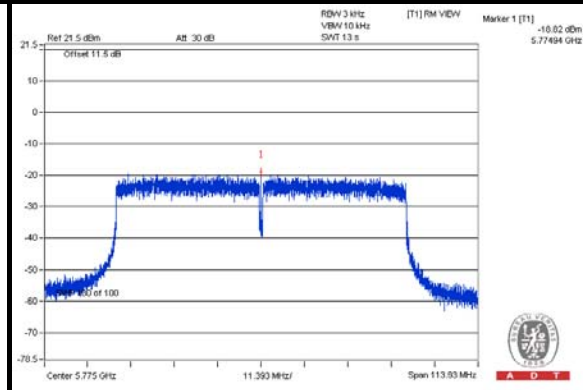



Test Mode B

802.11a

TX chain	Chan.	Freq. (MHz)	PSD (dBm/3kHz)	10 log (N=2) dB	Total PSD without Duty Factor (dBm/3kHz)	Duty Factor	Total PSD with Duty Factor (dBm/3kHz)	Limit (dBm/3kHz)	PASS /FAIL
0	149	5745	-18.74	3.01	-15.73	0.18	-15.55	-12.01	PASS
	157	5785	-19.20	3.01	-16.19	0.18	-16.01	-12.01	PASS
	165	5825	-22.37	3.01	-19.36	0.18	-19.18	-12.01	PASS
1	149	5745	-19.48	3.01	-16.47	0.18	-16.29	-12.01	PASS
	157	5785	-19.87	3.01	-16.86	0.18	-16.68	-12.01	PASS
	165	5825	-21.50	3.01	-18.49	0.18	-18.31	-12.01	PASS

NOTE: Directional gain = 23dBi + 10log(2) = 26.01dBi > 6dBi , so the power density limit shall be reduced to 8-(26.01-6) = -12.01dBm.

802.11n (20MHz)

TX chain	Chan.	Freq. (MHz)	PSD (dBm/3kHz)	10 log (N=2) dB	Total PSD without Duty Factor (dBm/3kHz)	Duty Factor	Total PSD with Duty Factor (dBm/3kHz)	Limit (dBm/3kHz)	PASS /FAIL
0	149	5745	-21.10	3.01	-18.09	0.21	-17.88	-12.01	PASS
	157	5785	-23.39	3.01	-20.38	0.21	-20.17	-12.01	PASS
	165	5825	-23.27	3.01	-20.26	0.21	-20.05	-12.01	PASS
1	149	5745	-20.45	3.01	-17.44	0.21	-17.23	-12.01	PASS
	157	5785	-22.21	3.01	-19.20	0.21	-18.99	-12.01	PASS
	165	5825	-23.52	3.01	-20.51	0.21	-20.30	-12.01	PASS

NOTE: Directional gain = 23dBi + 10log(2) = 26.01dBi > 6dBi , so the power density limit shall be reduced to 8-(26.01-6) = -12.01dBm.

802.11n (40MHz)

TX chain	Chan.	Freq. (MHz)	PSD (dBm/3kHz)	10 log (N=2) dB	Total PSD without Duty Factor (dBm/3kHz)	Duty Factor	Total PSD with Duty Factor (dBm/3kHz)	Limit (dBm/3kHz)	PASS /FAIL
0	151	5755	-20.63	3.01	-17.62	0.32	-17.30	-12.01	PASS
	159	5795	-21.71	3.01	-18.70	0.32	-18.38	-12.01	PASS
1	151	5755	-21.44	3.01	-18.43	0.32	-18.11	-12.01	PASS
	159	5795	-21.33	3.01	-18.32	0.32	-18.00	-12.01	PASS

NOTE: Directional gain = 23dBi + 10log(2) = 26.01dBi > 6dBi , so the power density limit shall be reduced to 8-(26.01-6) = -12.01dBm.



A D T

802.11ac (80MHz)

TX chain	Chan.	Freq. (MHz)	PSD (dBm/3kHz)	10 log (N=2) dB	Total PSD without Duty Factor (dBm/3kHz)	Duty Factor	Total PSD with Duty Factor (dBm/3kHz)	Limit (dBm/3kHz)	PASS /FAIL
0	155	5775	-23.88	3.01	-20.87	0.63	-20.24	-12.01	PASS
1	155	5775	-24.38	3.01	-21.37	0.63	-20.74	-12.01	PASS

NOTE: Directional gain = 23dB_i + 10log(2) = 26.01dB_i > 6dB_i , so the power density limit shall be reduced to 8-(26.01-6) = -12.01dBm.

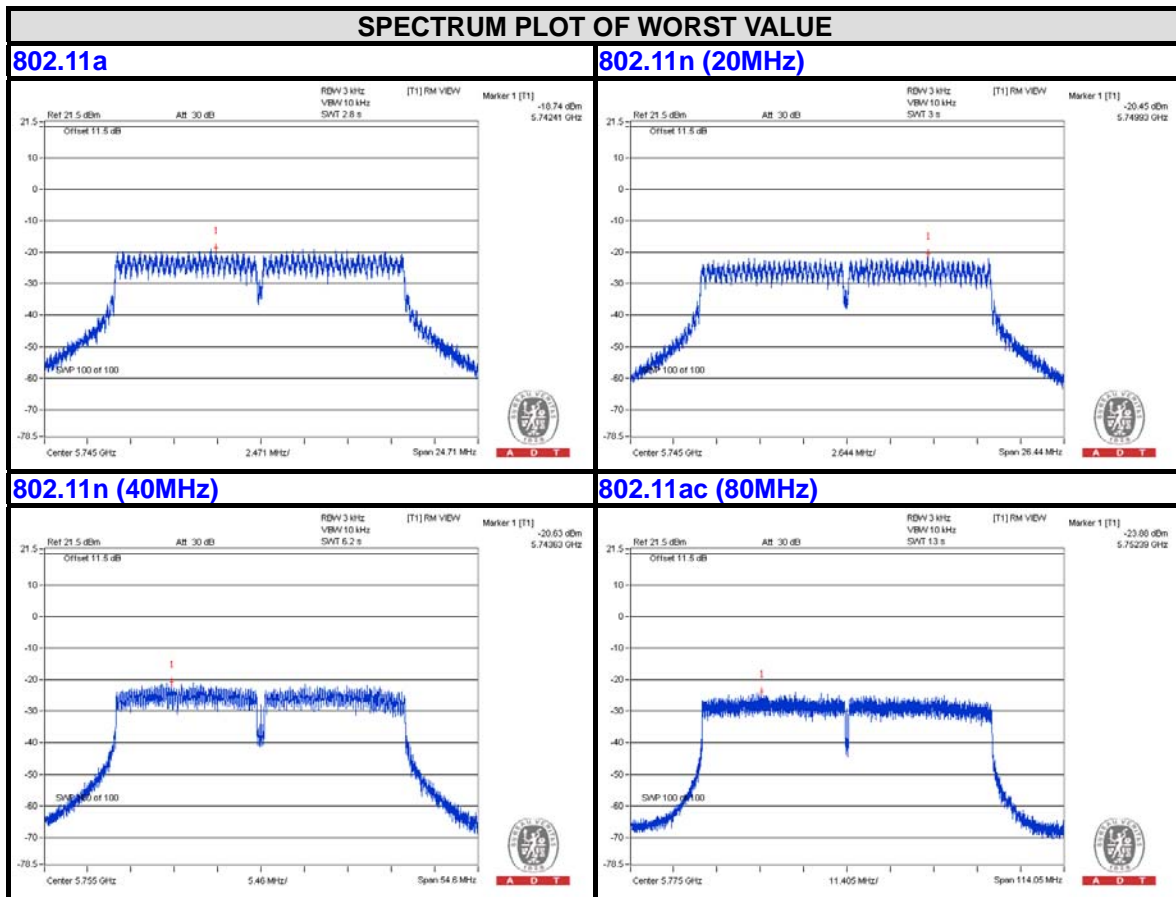



Test Mode C

802.11a

TX chain	Chan.	Freq. (MHz)	PSD (dBm/3kHz)	10 log (N=3) dB	Total PSD without Duty Factor (dBm/3kHz)	Duty Factor	Total PSD with Duty Factor (dBm/3kHz)	Limit (dBm/3kHz)	PASS /FAIL
0	149	5745	-14.85	4.77	-10.08	0.18	-9.90	-2.27	PASS
	157	5785	-14.76	4.77	-9.99	0.18	-9.81	-2.27	PASS
	165	5825	-15.47	4.77	-10.70	0.18	-10.52	-2.27	PASS
1	149	5745	-15.47	4.77	-10.70	0.18	-10.52	-2.27	PASS
	157	5785	-15.37	4.77	-10.60	0.18	-10.42	-2.27	PASS
	165	5825	-15.03	4.77	-10.26	0.18	-10.08	-2.27	PASS
2	149	5745	-13.76	4.77	-8.99	0.18	-8.81	-2.27	PASS
	157	5785	-13.97	4.77	-9.20	0.18	-9.02	-2.27	PASS
	165	5825	-13.77	4.77	-9.00	0.18	-8.82	-2.27	PASS

NOTE: Directional gain = $11.5\text{dBi} + 10\log(3) = 16.27\text{dBi} > 6\text{dBi}$, so the power density limit shall be reduced to $8-(16.27-6) = -2.27\text{dBm}$.

802.11n (20MHz)

TX chain	Chan.	Freq. (MHz)	PSD (dBm/3kHz)	10 log (N=3) dB	Total PSD without Duty Factor (dBm/3kHz)	Duty Factor	Total PSD with Duty Factor (dBm/3kHz)	Limit (dBm/3kHz)	PASS /FAIL
0	149	5745	-14.75	4.77	-9.98	0.19	-9.79	-2.27	PASS
	157	5785	-16.05	4.77	-11.28	0.19	-11.09	-2.27	PASS
	165	5825	-16.14	4.77	-11.37	0.19	-11.18	-2.27	PASS
1	149	5745	-14.82	4.77	-10.05	0.19	-9.86	-2.27	PASS
	157	5785	-14.73	4.77	-9.96	0.19	-9.77	-2.27	PASS
	165	5825	-15.05	4.77	-10.28	0.19	-10.09	-2.27	PASS
2	149	5745	-12.86	4.77	-8.09	0.19	-7.90	-2.27	PASS
	157	5785	-13.69	4.77	-8.92	0.19	-8.73	-2.27	PASS
	165	5825	-14.92	4.77	-10.15	0.19	-9.96	-2.27	PASS

NOTE: Directional gain = $11.5\text{dBi} + 10\log(3) = 16.27\text{dBi} > 6\text{dBi}$, so the power density limit shall be reduced to $8-(16.27-6) = -2.27\text{dBm}$.



A D T

802.11n (40MHz)

TX chain	Chan.	Freq. (MHz)	PSD (dBm/3kHz)	10 log (N=3) dB	Total PSD without Duty Factor (dBm/3kHz)	Duty Factor	Total PSD with Duty Factor (dBm/3kHz)	Limit (dBm/3kHz)	PASS /FAIL
0	151	5755	-18.26	4.77	-13.49	0.36	-13.13	-2.27	PASS
	159	5795	-17.23	4.77	-12.46	0.36	-12.10	-2.27	PASS
1	151	5755	-17.43	4.77	-12.66	0.36	-12.30	-2.27	PASS
	159	5795	-18.10	4.77	-13.33	0.36	-12.97	-2.27	PASS
2	151	5755	-16.82	4.77	-12.05	0.36	-11.69	-2.27	PASS
	159	5795	-17.13	4.77	-12.36	0.36	-12.00	-2.27	PASS

NOTE: Directional gain = $11.5\text{dBi} + 10\log(3) = 16.27\text{dBi} > 6\text{dBi}$, so the power density limit shall be reduced to $8-(16.27-6) = -2.27\text{dBm}$.

802.11ac (80MHz)

TX chain	Chan.	Freq. (MHz)	PSD (dBm/3kHz)	10 log (N=3) dB	Total PSD without Duty Factor (dBm/3kHz)	Duty Factor	Total PSD with Duty Factor (dBm/3kHz)	Limit (dBm/3kHz)	PASS /FAIL
0	155	5775	-21.51	4.77	-16.74	0.66	-16.08	-2.27	PASS
1	155	5775	-21.62	4.77	-16.85	0.66	-16.19	-2.27	PASS
2	155	5775	-21.13	4.77	-16.36	0.66	-15.70	-2.27	PASS

NOTE: Directional gain = $11.5\text{dBi} + 10\log(3) = 16.27\text{dBi} > 6\text{dBi}$, so the power density limit shall be reduced to $8-(16.27-6) = -2.27\text{dBm}$.



A D T

SPECTRUM PLOT OF WORST VALUE

802.11a

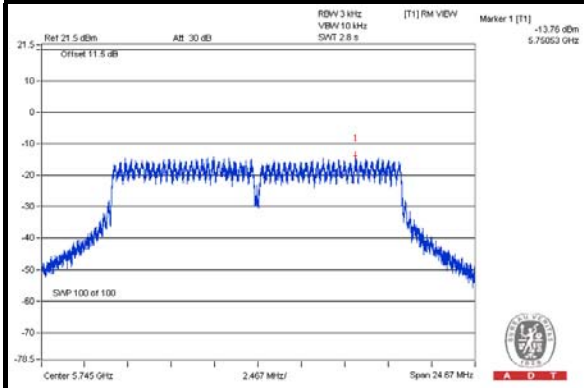

802.11n (20MHz)

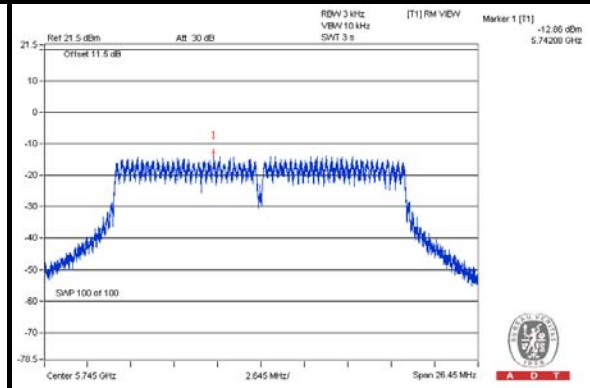

802.11n (40MHz)

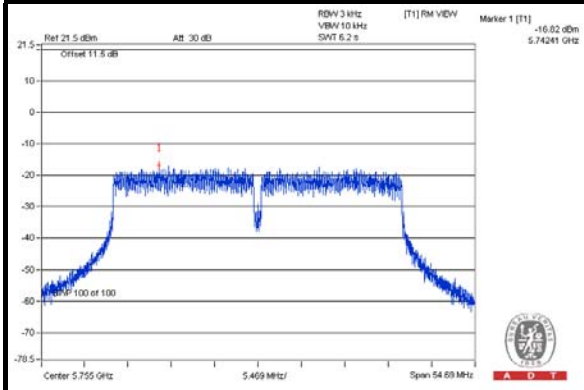

802.11ac (80MHz)

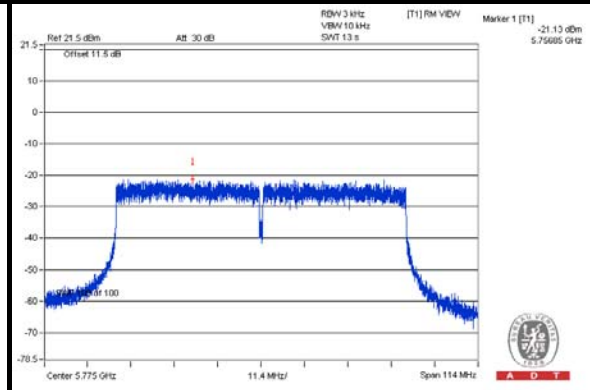



A D T

Test Mode D

802.11a

TX chain	Chan.	Freq. (MHz)	PSD (dBm/3kHz)	10 log (N=3) dB	Total PSD without Duty Factor (dBm/3kHz)	Duty Factor	Total PSD with Duty Factor (dBm/3kHz)	Limit (dBm/3kHz)	PASS /FAIL
0	149	5745	-11.27	4.77	-6.50	0.15	-6.35	1.23	PASS
	157	5785	-10.29	4.77	-5.52	0.15	-5.37	1.23	PASS
	165	5825	-10.56	4.77	-5.79	0.15	-5.64	1.23	PASS
1	149	5745	-11.40	4.77	-6.63	0.15	-6.48	1.23	PASS
	157	5785	-11.14	4.77	-6.37	0.15	-6.22	1.23	PASS
	165	5825	-11.12	4.77	-6.35	0.15	-6.20	1.23	PASS
2	149	5745	-10.83	4.77	-6.06	0.15	-5.91	1.23	PASS
	157	5785	-9.73	4.77	-4.96	0.15	-4.81	1.23	PASS
	165	5825	-12.42	4.77	-7.65	0.15	-7.50	1.23	PASS

NOTE: Directional gain = $8\text{dBi} + 10\log(3) = 12.77\text{dBi} > 6\text{dBi}$, so the power density limit shall be reduced to $8-(12.77-6) = 1.23\text{dBm}$.

802.11n (20MHz)

TX chain	Chan.	Freq. (MHz)	PSD (dBm/3kHz)	10 log (N=3) dB	Total PSD without Duty Factor (dBm/3kHz)	Duty Factor	Total PSD with Duty Factor (dBm/3kHz)	Limit (dBm/3kHz)	PASS /FAIL
0	149	5745	-10.69	4.77	-5.92	0.20	-5.72	1.23	PASS
	157	5785	-10.89	4.77	-6.12	0.20	-5.92	1.23	PASS
	165	5825	-10.66	4.77	-5.89	0.20	-5.69	1.23	PASS
1	149	5745	-10.81	4.77	-6.04	0.20	-5.84	1.23	PASS
	157	5785	-11.24	4.77	-6.47	0.20	-6.27	1.23	PASS
	165	5825	-11.32	4.77	-6.55	0.20	-6.35	1.23	PASS
2	149	5745	-10.97	4.77	-6.20	0.20	-6.00	1.23	PASS
	157	5785	-10.44	4.77	-5.67	0.20	-5.47	1.23	PASS
	165	5825	-10.97	4.77	-6.20	0.20	-6.00	1.23	PASS

NOTE: Directional gain = $8\text{dBi} + 10\log(3) = 12.77\text{dBi} > 6\text{dBi}$, so the power density limit shall be reduced to $8-(12.77-6) = 1.23\text{dBm}$.



A D T

802.11n (40MHz)

TX chain	Chan.	Freq. (MHz)	PSD (dBm/3kHz)	10 log (N=3) dB	Total PSD without Duty Factor (dBm/3kHz)	Duty Factor	Total PSD with Duty Factor (dBm/3kHz)	Limit (dBm/3kHz)	PASS /FAIL
0	151	5755	-15.19	4.77	-10.42	0.36	-10.06	1.23	PASS
	159	5795	-14.22	4.77	-9.45	0.36	-9.09	1.23	PASS
1	151	5755	-15.63	4.77	-10.86	0.36	-10.50	1.23	PASS
	159	5795	-14.06	4.77	-9.29	0.36	-8.93	1.23	PASS
2	151	5755	-15.00	4.77	-10.23	0.36	-9.87	1.23	PASS
	159	5795	-13.74	4.77	-8.97	0.36	-8.61	1.23	PASS

NOTE: Directional gain = 8dBi + 10log(3) = 12.77dBi > 6dBi , so the power density limit shall be reduced to 8-(12.77-6) = 1.23dBm.

802.11ac (80MHz)

TX chain	Chan.	Freq. (MHz)	PSD (dBm/3kHz)	10 log (N=3) dB	Total PSD without Duty Factor (dBm/3kHz)	Duty Factor	Total PSD with Duty Factor (dBm/3kHz)	Limit (dBm/3kHz)	PASS /FAIL
0	155	5775	-18.93	4.77	-14.16	0.58	-13.58	1.23	PASS
1	155	5775	-18.74	4.77	-13.97	0.58	-13.39	1.23	PASS
2	155	5775	-17.60	4.77	-12.83	0.58	-12.25	1.23	PASS

NOTE: Directional gain = 8dBi + 10log(3) = 12.77dBi > 6dBi , so the power density limit shall be reduced to 8-(12.77-6) = 1.23dBm.

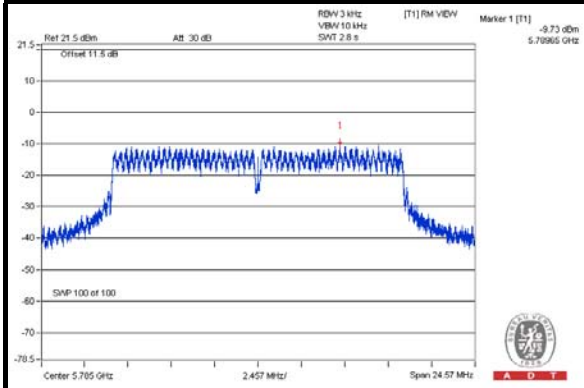
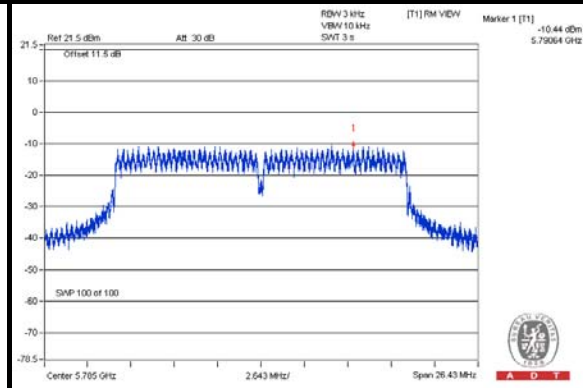
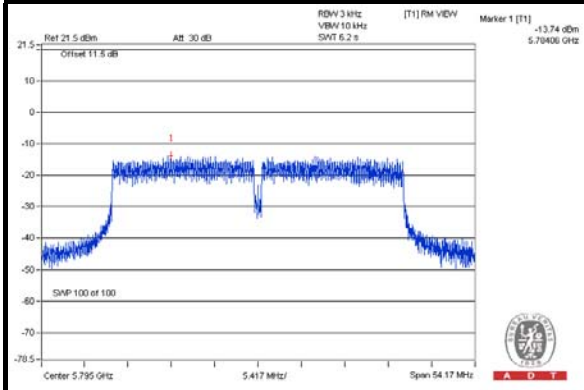
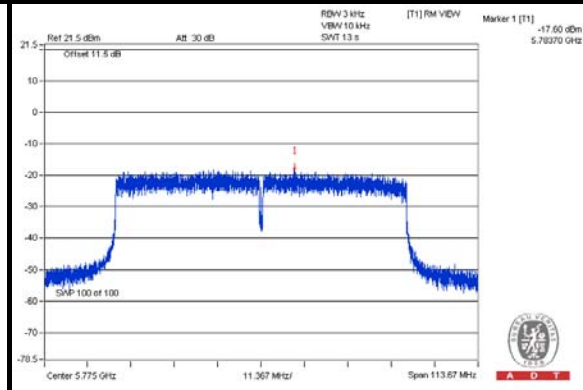
SPECTRUM PLOT OF WORST VALUE
802.11a

802.11n (20MHz)

802.11n (40MHz)

802.11ac (80MHz)



A D T

Test Mode E

802.11a

TX chain	Chan.	Freq. (MHz)	PSD (dBm/3kHz)	10 log (N=3) dB	Total PSD without Duty Factor (dBm/3kHz)	Duty Factor	Total PSD with Duty Factor (dBm/3kHz)	Limit (dBm/3kHz)	PASS /FAIL
0	149	5745	-12.95	4.77	-8.18	0.20	-7.98	7.23	PASS
	157	5785	-12.85	4.77	-8.08	0.20	-7.88	7.23	PASS
	165	5825	-12.41	4.77	-7.64	0.20	-7.44	7.23	PASS
1	149	5745	-12.47	4.77	-7.70	0.20	-7.50	7.23	PASS
	157	5785	-13.39	4.77	-8.62	0.20	-8.42	7.23	PASS
	165	5825	-12.14	4.77	-7.37	0.20	-7.17	7.23	PASS
2	149	5745	-12.43	4.77	-7.66	0.20	-7.46	7.23	PASS
	157	5785	-12.07	4.77	-7.30	0.20	-7.10	7.23	PASS
	165	5825	-12.83	4.77	-8.06	0.20	-7.86	7.23	PASS

NOTE: Directional gain = $2\text{dBi} + 10\log(3) = 6.77\text{dBi} > 6\text{dBi}$, so the power density limit shall be reduced to $8-(6.77-6) = 7.23\text{dBm}$.

802.11n (20MHz)

TX chain	Chan.	Freq. (MHz)	PSD (dBm/3kHz)	10 log (N=3) dB	Total PSD without Duty Factor (dBm/3kHz)	Duty Factor	Total PSD with Duty Factor (dBm/3kHz)	Limit (dBm/3kHz)	PASS /FAIL
0	149	5745	-12.37	4.77	-7.60	0.19	-7.41	7.23	PASS
	157	5785	-11.27	4.77	-6.50	0.19	-6.31	7.23	PASS
	165	5825	-12.13	4.77	-7.36	0.19	-7.17	7.23	PASS
1	149	5745	-11.63	4.77	-6.86	0.19	-6.67	7.23	PASS
	157	5785	-11.99	4.77	-7.22	0.19	-7.03	7.23	PASS
	165	5825	-12.84	4.77	-8.07	0.19	-7.88	7.23	PASS
2	149	5745	-11.87	4.77	-7.10	0.19	-6.91	7.23	PASS
	157	5785	-11.72	4.77	-6.95	0.19	-6.76	7.23	PASS
	165	5825	-10.96	4.77	-6.19	0.19	-6.00	7.23	PASS

NOTE: Directional gain = $2\text{dBi} + 10\log(3) = 6.77\text{dBi} > 6\text{dBi}$, so the power density limit shall be reduced to $8-(6.77-6) = 7.23\text{dBm}$.



A D T

802.11n (40MHz)

TX chain	Chan.	Freq. (MHz)	PSD (dBm/3kHz)	10 log (N=3) dB	Total PSD without Duty Factor (dBm/3kHz)	Duty Factor	Total PSD with Duty Factor (dBm/3kHz)	Limit (dBm/3kHz)	PASS /FAIL
0	151	5755	-16.10	4.77	-11.33	0.32	-11.01	7.23	PASS
	159	5795	-14.35	4.77	-9.58	0.32	-9.26	7.23	PASS
1	151	5755	-16.45	4.77	-11.68	0.32	-11.36	7.23	PASS
	159	5795	-14.85	4.77	-10.08	0.32	-9.76	7.23	PASS
2	151	5755	-15.86	4.77	-11.09	0.32	-10.77	7.23	PASS
	159	5795	-13.69	4.77	-8.92	0.32	-8.60	7.23	PASS

NOTE: Directional gain = $2\text{dBi} + 10\log(3) = 6.77\text{dBi} > 6\text{dBi}$, so the power density limit shall be reduced to $8-(6.77-6) = 7.23\text{dBm}$.

802.11ac (80MHz)

TX chain	Chan.	Freq. (MHz)	PSD (dBm/3kHz)	10 log (N=3) dB	Total PSD without Duty Factor (dBm/3kHz)	Duty Factor	Total PSD with Duty Factor (dBm/3kHz)	Limit (dBm/3kHz)	PASS /FAIL
0	155	5775	-20.31	4.77	-15.54	0.62	-14.92	7.23	PASS
1	155	5775	-19.99	4.77	-15.22	0.62	-14.60	7.23	PASS
2	155	5775	-18.63	4.77	-13.86	0.62	-13.24	7.23	PASS

NOTE: Directional gain = $2\text{dBi} + 10\log(3) = 6.77\text{dBi} > 6\text{dBi}$, so the power density limit shall be reduced to $8-(6.77-6) = 7.23\text{dBm}$.

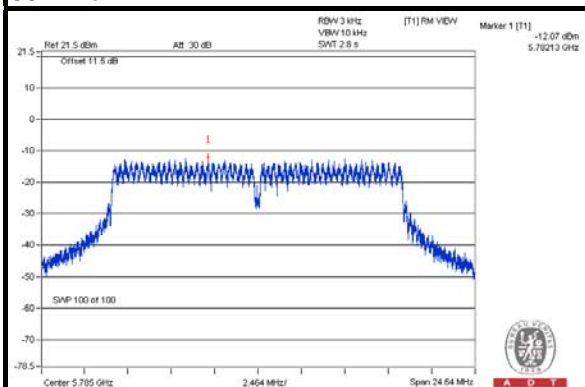
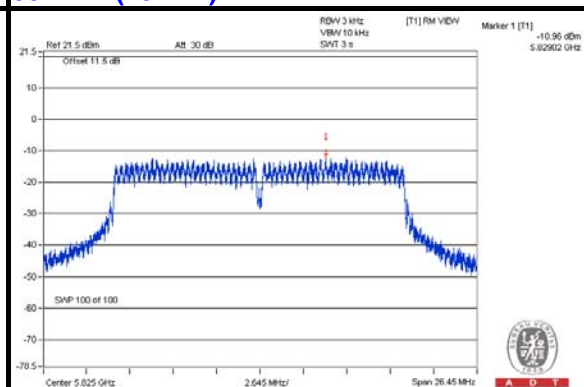
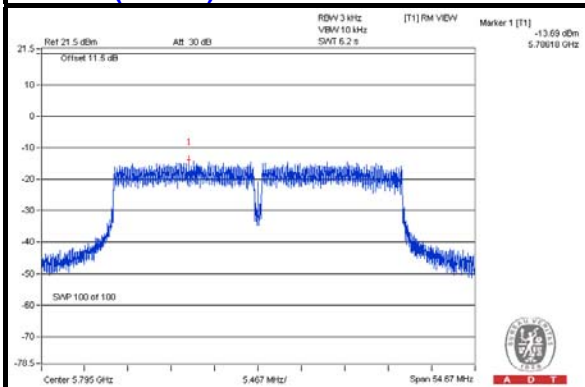
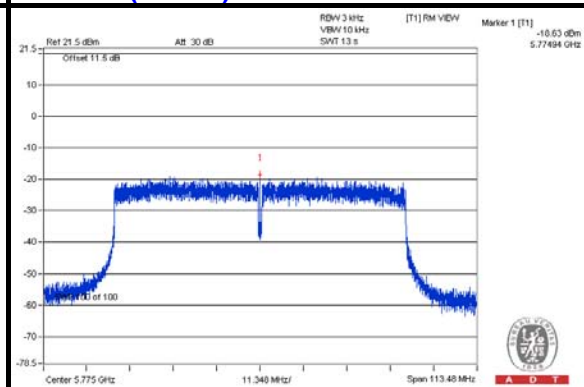
SPECTRUM PLOT OF WORST VALUE**802.11a****802.11n (20MHz)****802.11n (40MHz)****802.11ac (80MHz)**



Test Mode F

802.11a

TX chain	Chan.	Freq. (MHz)	PSD (dBm/3kHz)	10 log (N=3) dB	Total PSD without Duty Factor (dBm/3kHz)	Duty Factor	Total PSD with Duty Factor (dBm/3kHz)	Limit (dBm/3kHz)	PASS /FAIL
0	149	5745	-11.92	4.77	-7.15	0.16	-6.99	2.23	PASS
	157	5785	-8.74	4.77	-3.97	0.16	-3.81	2.23	PASS
	165	5825	-9.95	4.77	-5.18	0.16	-5.02	2.23	PASS
1	149	5745	-12.04	4.77	-7.27	0.16	-7.11	2.23	PASS
	157	5785	-10.07	4.77	-5.30	0.16	-5.14	2.23	PASS
	165	5825	-10.20	4.77	-5.43	0.16	-5.27	2.23	PASS
2	149	5745	-11.03	4.77	-6.26	0.16	-6.10	2.23	PASS
	157	5785	-9.69	4.77	-4.92	0.16	-4.76	2.23	PASS
	165	5825	-9.96	4.77	-5.19	0.16	-5.03	2.23	PASS

NOTE: Directional gain = 7dBi + 10log(3) = 11.77dBi > 6dBi , so the power density limit shall be reduced to 8-(11.77-6) = 2.23dBm.

802.11n (20MHz)

TX chain	Chan.	Freq. (MHz)	PSD (dBm/3kHz)	10 log (N=3) dB	Total PSD without Duty Factor (dBm/3kHz)	Duty Factor	Total PSD with Duty Factor (dBm/3kHz)	Limit (dBm/3kHz)	PASS /FAIL
0	149	5745	-11.01	4.77	-6.24	0.21	-6.03	2.23	PASS
	157	5785	-9.65	4.77	-4.88	0.21	-4.67	2.23	PASS
	165	5825	-9.14	4.77	-4.37	0.21	-4.16	2.23	PASS
1	149	5745	-12.24	4.77	-7.47	0.21	-7.26	2.23	PASS
	157	5785	-9.38	4.77	-4.61	0.21	-4.40	2.23	PASS
	165	5825	-9.00	4.77	-4.23	0.21	-4.02	2.23	PASS
2	149	5745	-11.14	4.77	-6.37	0.21	-6.16	2.23	PASS
	157	5785	-9.93	4.77	-5.16	0.21	-4.95	2.23	PASS
	165	5825	-9.16	4.77	-4.39	0.21	-4.18	2.23	PASS

NOTE: Directional gain = 7dBi + 10log(3) = 11.77dBi > 6dBi , so the power density limit shall be reduced to 8-(11.77-6) = 2.23dBm.



802.11n (40MHz)

TX chain	Chan.	Freq. (MHz)	PSD (dBm/3kHz)	10 log (N=3) dB	Total PSD without Duty Factor (dBm/3kHz)	Duty Factor	Total PSD with Duty Factor (dBm/3kHz)	Limit (dBm/3kHz)	PASS /FAIL
0	151	5755	-17.40	4.77	-12.63	0.38	-12.25	2.23	PASS
	159	5795	-12.01	4.77	-7.24	0.38	-6.86	2.23	PASS
1	151	5755	-14.81	4.77	-10.04	0.38	-9.66	2.23	PASS
	159	5795	-12.89	4.77	-8.12	0.38	-7.74	2.23	PASS
2	151	5755	-16.13	4.77	-11.36	0.38	-10.98	2.23	PASS
	159	5795	-11.74	4.77	-6.97	0.38	-6.59	2.23	PASS

NOTE: Directional gain = 7dBi + 10log(3) = 11.77dBi > 6dBi , so the power density limit shall be reduced to 8-(11.77-6) = 2.23dBm.

802.11ac (80MHz)

TX chain	Chan.	Freq. (MHz)	PSD (dBm/3kHz)	10 log (N=3) dB	Total PSD without Duty Factor (dBm/3kHz)	Duty Factor	Total PSD with Duty Factor (dBm/3kHz)	Limit (dBm/3kHz)	PASS /FAIL
0	155	5775	-19.72	4.77	-14.95	0.78	-14.17	2.23	PASS
1	155	5775	-19.56	4.77	-14.79	0.78	-14.01	2.23	PASS
2	155	5775	-19.29	4.77	-14.52	0.78	-13.74	2.23	PASS

NOTE: Directional gain = 7dBi + 10log(3) = 11.77dBi > 6dBi , so the power density limit shall be reduced to 8-(11.77-6) = 2.23dBm.



A D T

SPECTRUM PLOT OF WORST VALUE

802.11a

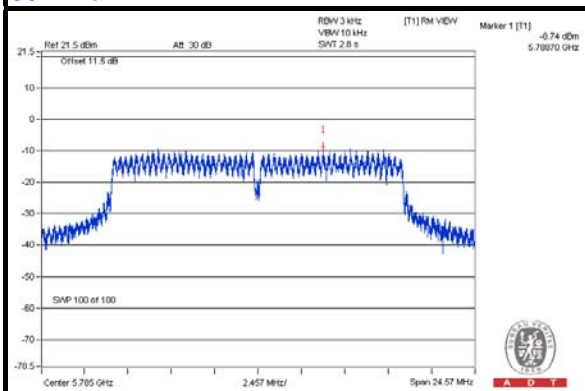

802.11n (20MHz)

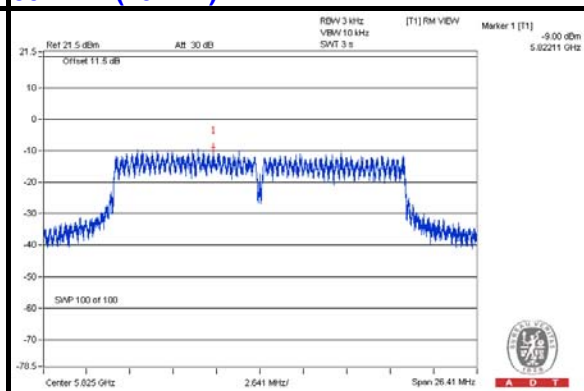

802.11n (40MHz)

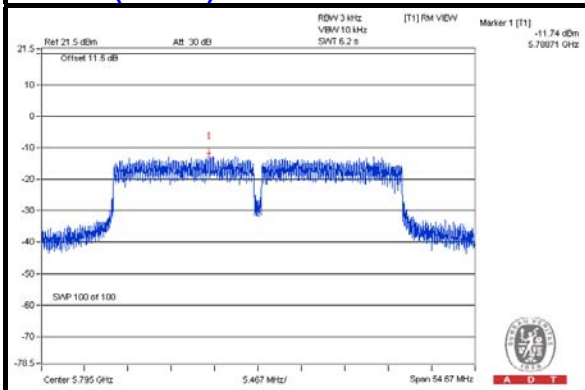

802.11ac (80MHz)

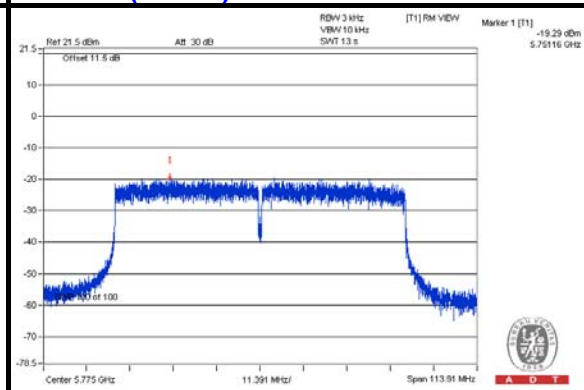



Test Mode G

802.11a

TX chain	Chan.	Freq. (MHz)	PSD (dBm/3kHz)	10 log (N=3) dB	Total PSD without Duty Factor (dBm/3kHz)	Duty Factor	Total PSD with Duty Factor (dBm/3kHz)	Limit (dBm/3kHz)	PASS /FAIL
0	149	5745	-10.83	4.77	-6.06	0.18	-5.88	2.03	PASS
	157	5785	-12.78	4.77	-8.01	0.18	-7.83	2.03	PASS
	165	5825	-12.82	4.77	-8.05	0.18	-7.87	2.03	PASS
1	149	5745	-11.13	4.77	-6.36	0.18	-6.18	2.03	PASS
	157	5785	-12.38	4.77	-7.61	0.18	-7.43	2.03	PASS
	165	5825	-13.22	4.77	-8.45	0.18	-8.27	2.03	PASS
2	149	5745	-10.18	4.77	-5.41	0.18	-5.23	2.03	PASS
	157	5785	-12.49	4.77	-7.72	0.18	-7.54	2.03	PASS
	165	5825	-12.94	4.77	-8.17	0.18	-7.99	2.03	PASS

NOTE: Directional gain = 7.2dBi + 10log(3) = 11.97dBi > 6dBi , so the power density limit shall be reduced to 8-(11.97-6) = 2.03dBm.

802.11n (20MHz)

TX chain	Chan.	Freq. (MHz)	PSD (dBm/3kHz)	10 log (N=3) dB	Total PSD without Duty Factor (dBm/3kHz)	Duty Factor	Total PSD with Duty Factor (dBm/3kHz)	Limit (dBm/3kHz)	PASS /FAIL
0	149	5745	-11.03	4.77	-6.26	0.18	-6.08	2.03	PASS
	157	5785	-13.13	4.77	-8.36	0.18	-8.18	2.03	PASS
	165	5825	-13.33	4.77	-8.56	0.18	-8.38	2.03	PASS
1	149	5745	-11.14	4.77	-6.37	0.18	-6.19	2.03	PASS
	157	5785	-13.21	4.77	-8.44	0.18	-8.26	2.03	PASS
	165	5825	-12.61	4.77	-7.84	0.18	-7.66	2.03	PASS
2	149	5745	-10.32	4.77	-5.55	0.18	-5.37	2.03	PASS
	157	5785	-11.90	4.77	-7.13	0.18	-6.95	2.03	PASS
	165	5825	-12.13	4.77	-7.36	0.18	-7.18	2.03	PASS

NOTE: Directional gain = 7.2dBi + 10log(3) = 11.97dBi > 6dBi , so the power density limit shall be reduced to 8-(11.97-6) = 2.03dBm.



A D T

802.11n (40MHz)

TX chain	Chan.	Freq. (MHz)	PSD (dBm/3kHz)	10 log (N=3) dB	Total PSD without Duty Factor (dBm/3kHz)	Duty Factor	Total PSD with Duty Factor (dBm/3kHz)	Limit (dBm/3kHz)	PASS /FAIL
0	151	5755	-16.81	4.77	-12.04	0.32	-11.72	2.03	PASS
	159	5795	-14.39	4.77	-9.62	0.32	-9.30	2.03	PASS
1	151	5755	-16.83	4.77	-12.06	0.32	-11.74	2.03	PASS
	159	5795	-14.88	4.77	-10.11	0.32	-9.79	2.03	PASS
2	151	5755	-16.30	4.77	-11.53	0.32	-11.21	2.03	PASS
	159	5795	-12.58	4.77	-7.81	0.32	-7.49	2.03	PASS

NOTE: Directional gain = 7.2dBi + 10log(3) = 11.97dBi > 6dBi , so the power density limit shall be reduced to 8-(11.97-6) = 2.03dBm.

802.11ac (80MHz)

TX chain	Chan.	Freq. (MHz)	PSD (dBm/3kHz)	10 log (N=3) dB	Total PSD without Duty Factor (dBm/3kHz)	Duty Factor	Total PSD with Duty Factor (dBm/3kHz)	Limit (dBm/3kHz)	PASS /FAIL
0	155	5775	-20.48	4.77	-15.71	0.53	-15.18	2.03	PASS
1	155	5775	-18.98	4.77	-14.21	0.53	-13.68	2.03	PASS
2	155	5775	-18.70	4.77	-13.93	0.53	-13.40	2.03	PASS

NOTE: Directional gain = 7.2dBi + 10log(3) = 11.97dBi > 6dBi , so the power density limit shall be reduced to 8-(11.97-6) = 2.03dBm.



A D T

SPECTRUM PLOT OF WORST VALUE

802.11a

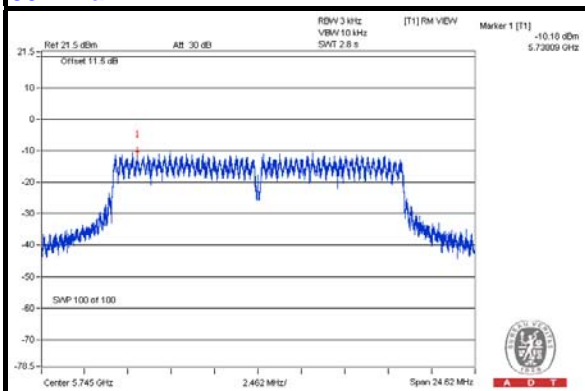

802.11n (20MHz)

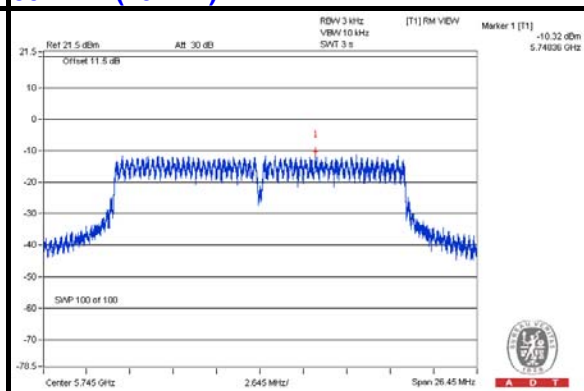

802.11n (40MHz)

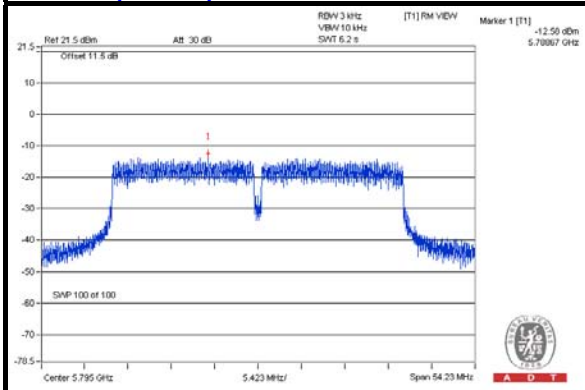

802.11ac (80MHz)

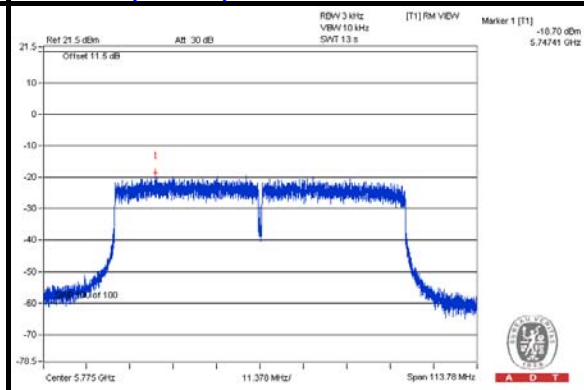

4.6 CONDUCTED OUT OF BAND EMISSION MEASUREMENT

4.6.1 LIMITS OF CONDUCTED OUT OF BAND EMISSION MEASUREMENT

Below -30dB of the highest emission level of operating band (in 100kHz Resolution Bandwidth).

4.6.2 TEST SETUP

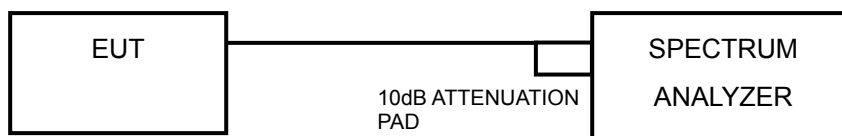

4.6.3 TEST INSTRUMENTS

Refer to section 4.1.2 to get information of above instrument.

4.6.4 TEST PROCEDURE

MEASUREMENT PROCEDURE REF

1. Set the RBW = 100 kHz.
2. Set the VBW \geq 300 kHz.
3. Detector = peak.
4. Sweep time = auto couple.
5. Trace mode = max hold.
6. Allow trace to fully stabilize.
7. Use the peak marker function to determine the maximum power level in any 100 kHz band segment within the fundamental EBW.

MEASUREMENT PROCEDURE OOB

1. Set RBW = 100 kHz.
2. Set VBW \geq 300 kHz.
3. Ensure that the number of measurement points \geq span/RBW
4. According to measurement points to set differ measurement span.
5. Detector = peak.
6. Trace Mode = max hold.
7. Sweep = auto couple.



A D T

4.6.5 DEVIATION FROM TEST STANDARD

No deviation.

4.6.6 EUT OPERATING CONDITION

Same as Item 4.3.6

4.6.7 TEST RESULTS

The conducted emission test is performed on each TX port of operating mode without summing or adding $10\log(N)$ since the limit is relative emission limit.

The spectrum plots are attached on the following pages. D1 line indicates the highest level, and D2 line indicates the 30dB offset below D1. It shows compliance with the requirement.



A D T

Test Mode A
802.11a
CHAIN 0

CH 149

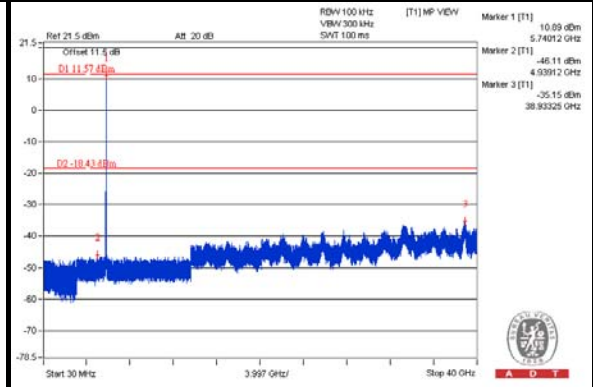
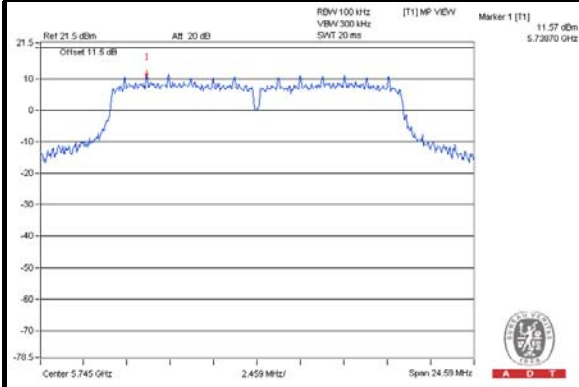

CH 157

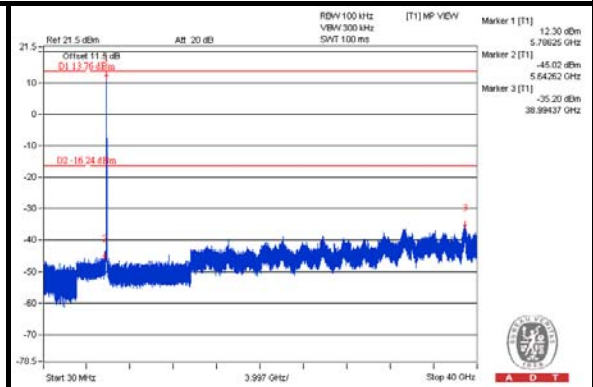
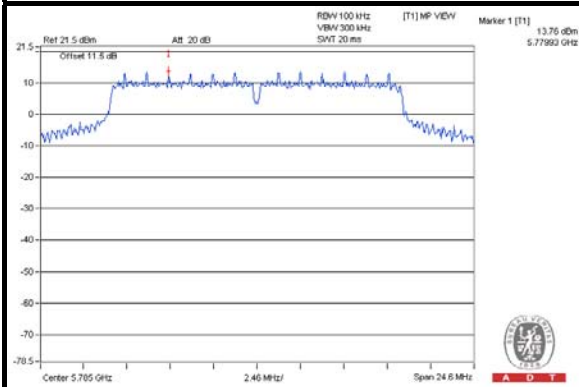

CH 165

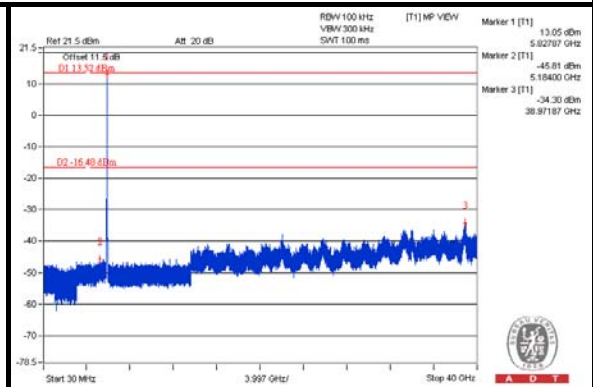
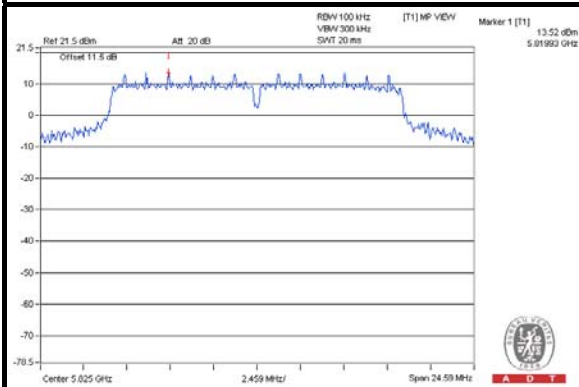

CH 149 Band edge

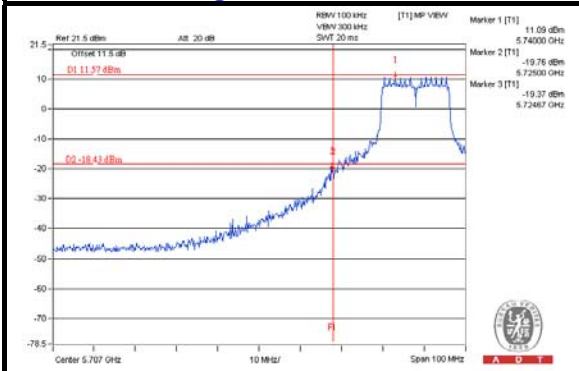

CH 165 Band edge

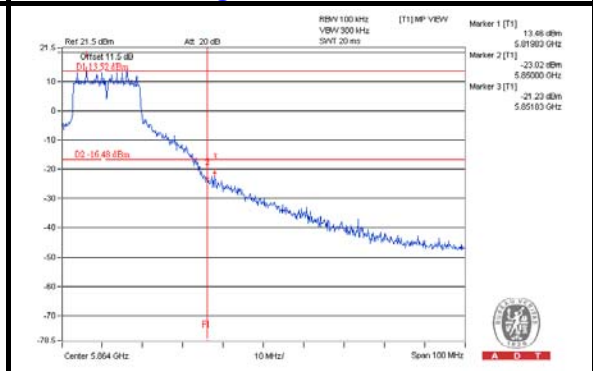



A D T

CHAIN 1

CH 149

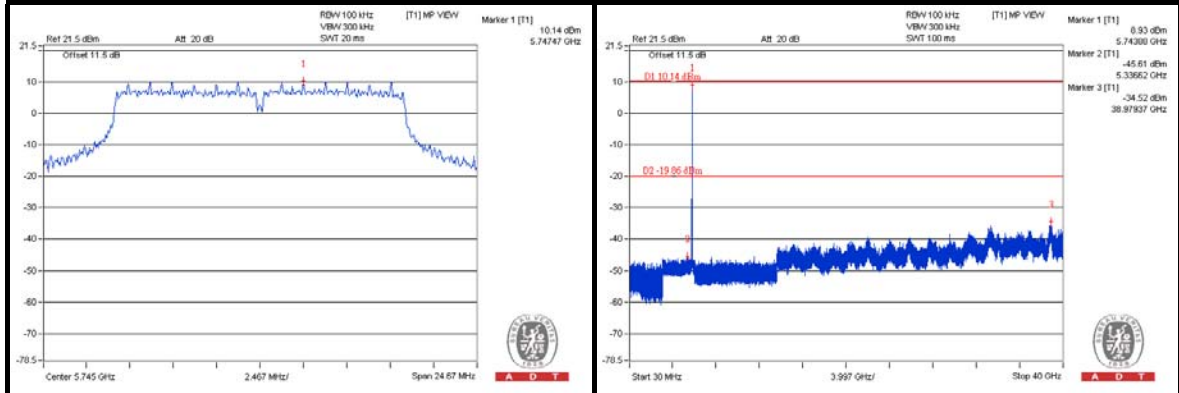

CH 157

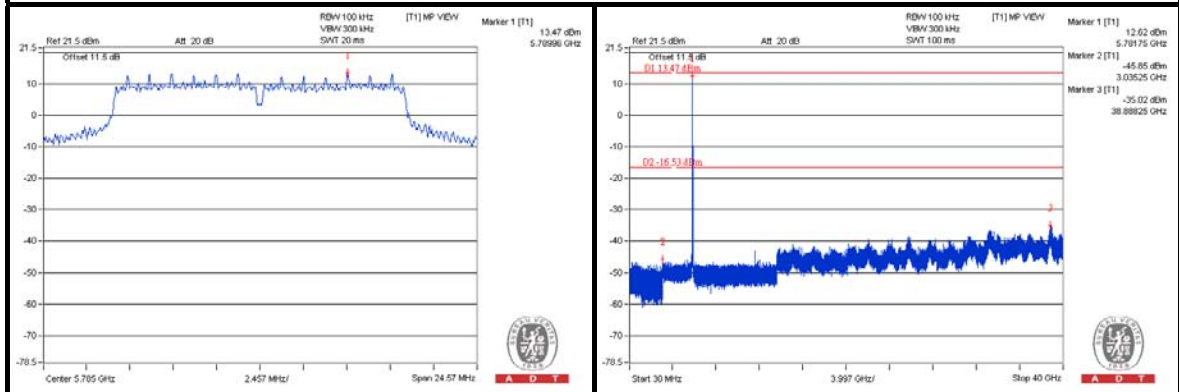

CH 165

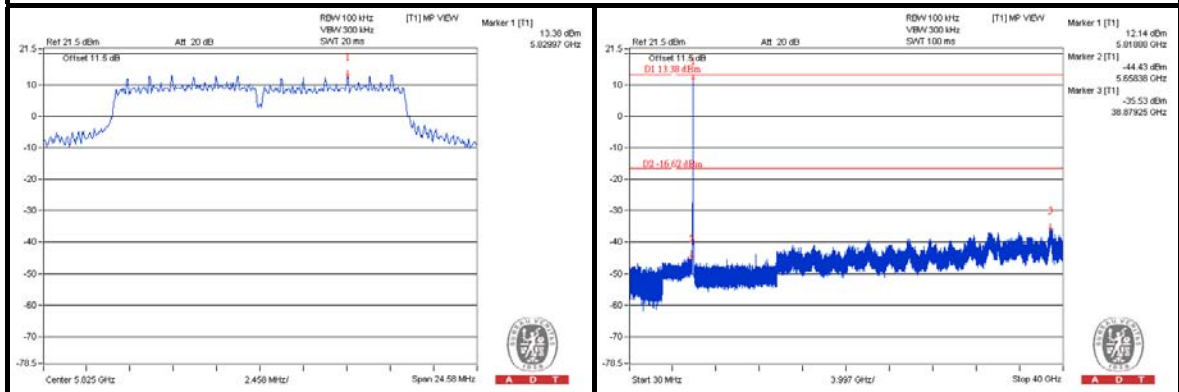

CH 149 Band edge

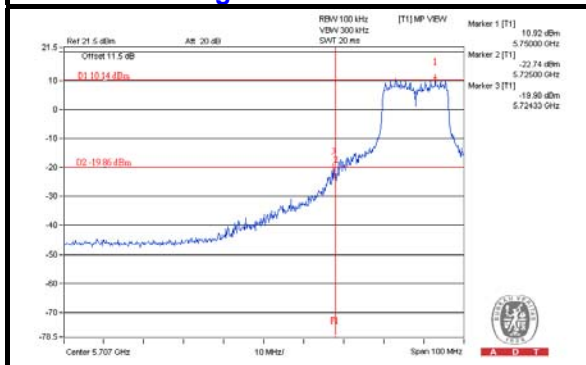

CH 165 Band edge

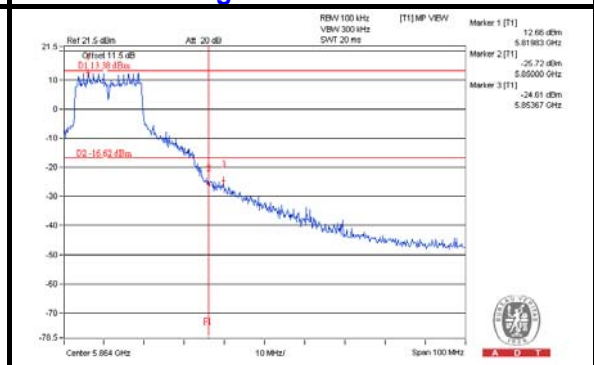



A D T

CHAIN 2

CH 149

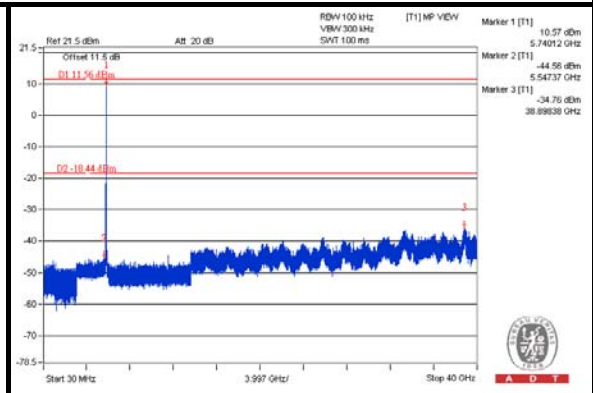
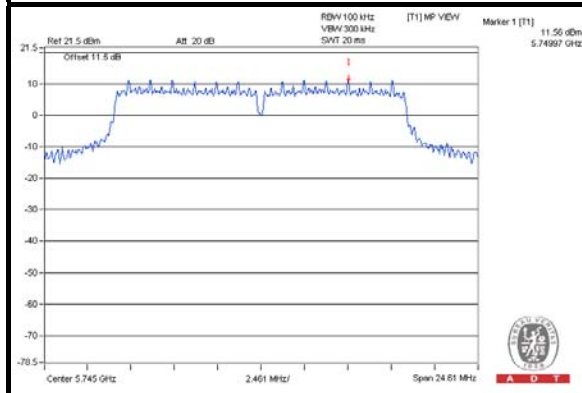

CH 157

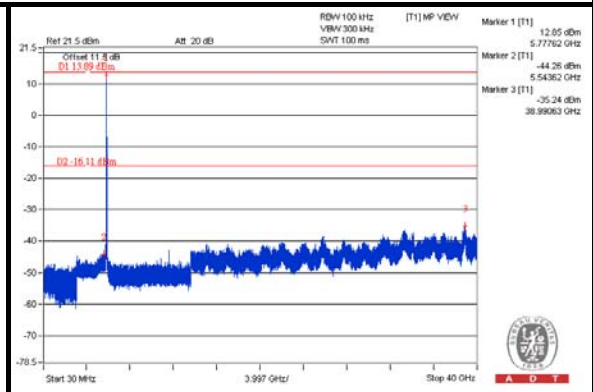
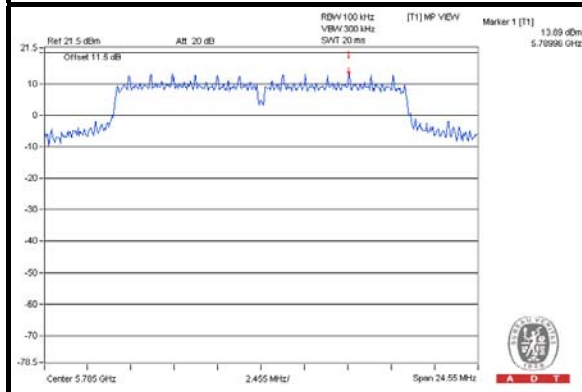

CH 165

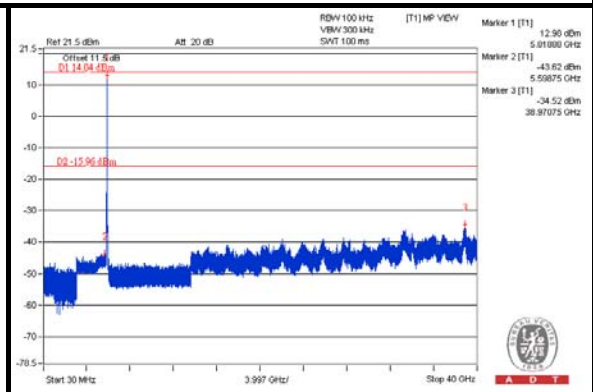
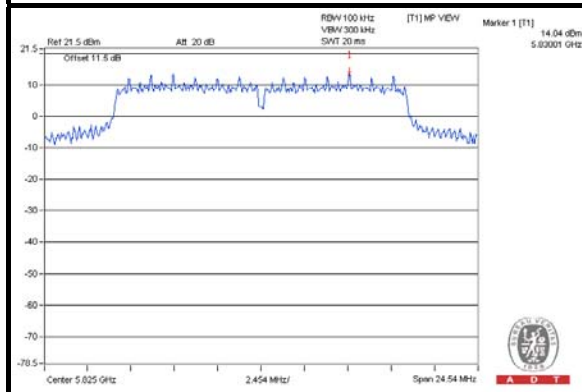

CH 149 Band edge

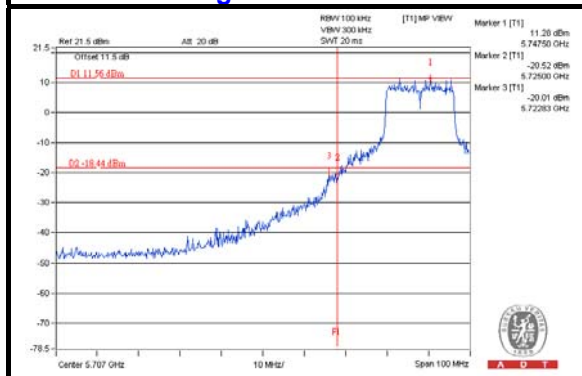

CH 165 Band edge

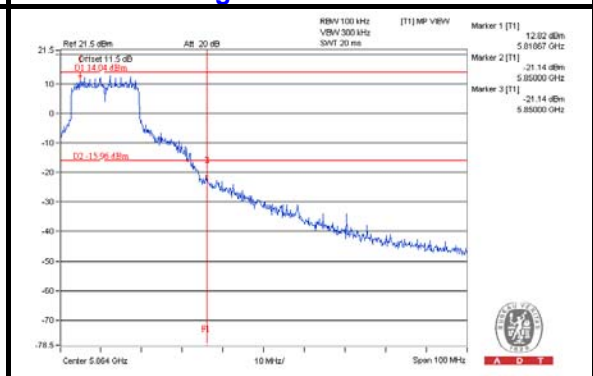



A D T

802.11n (20MHz) CHAIN 0

CH 149

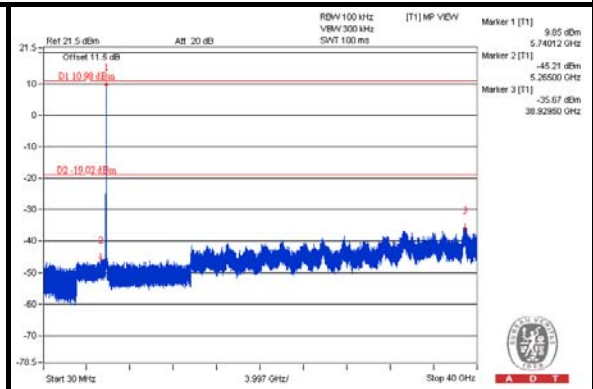
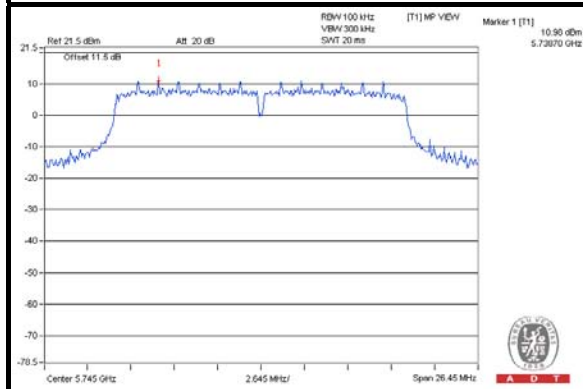

CH 157

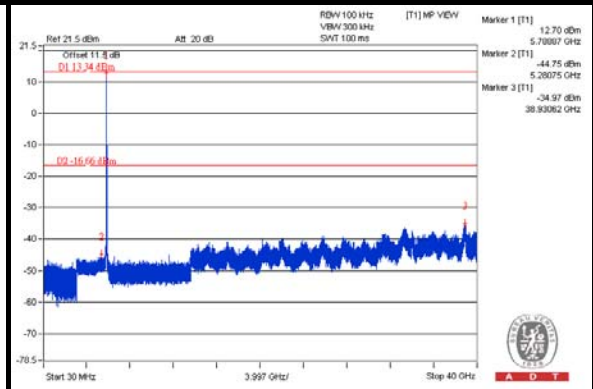
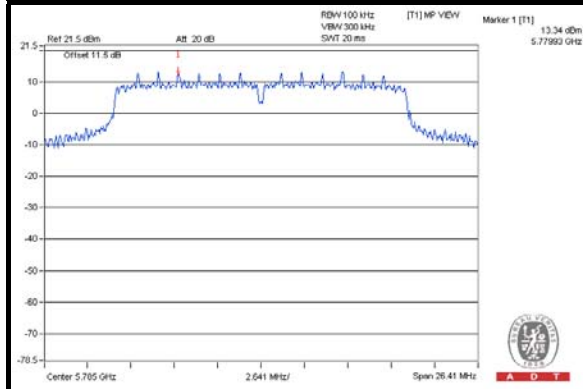

CH 165

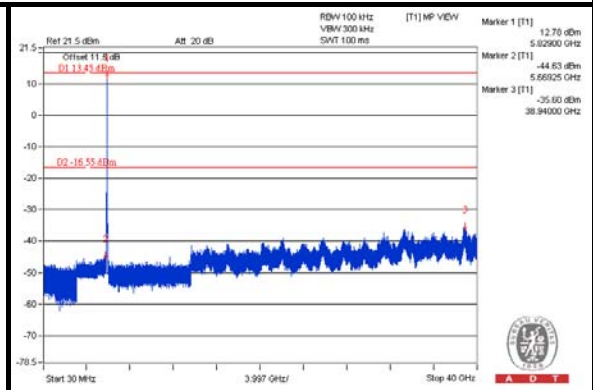
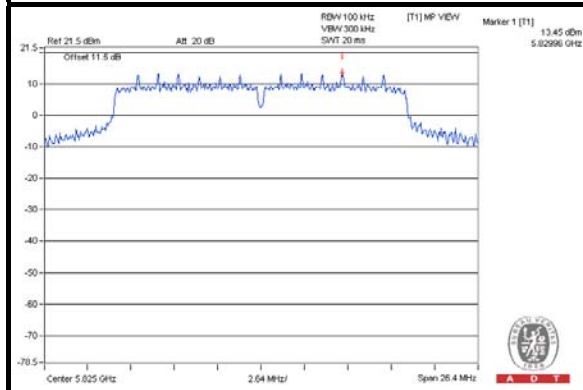

CH 149 Band edge

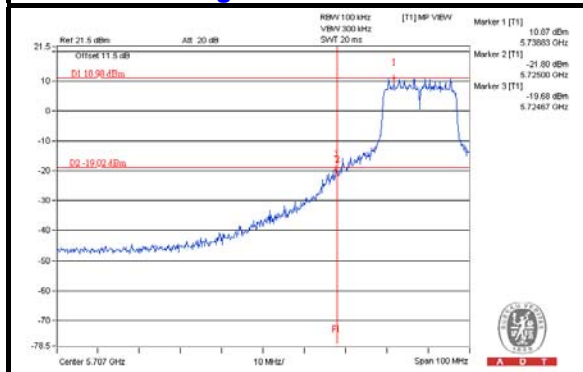

CH 165 Band edge

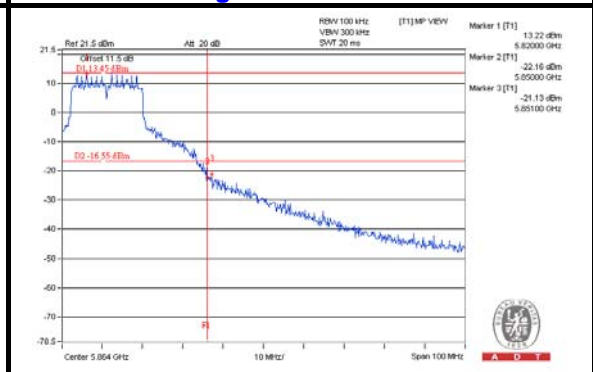



A D T

CHAIN 1

CH 149

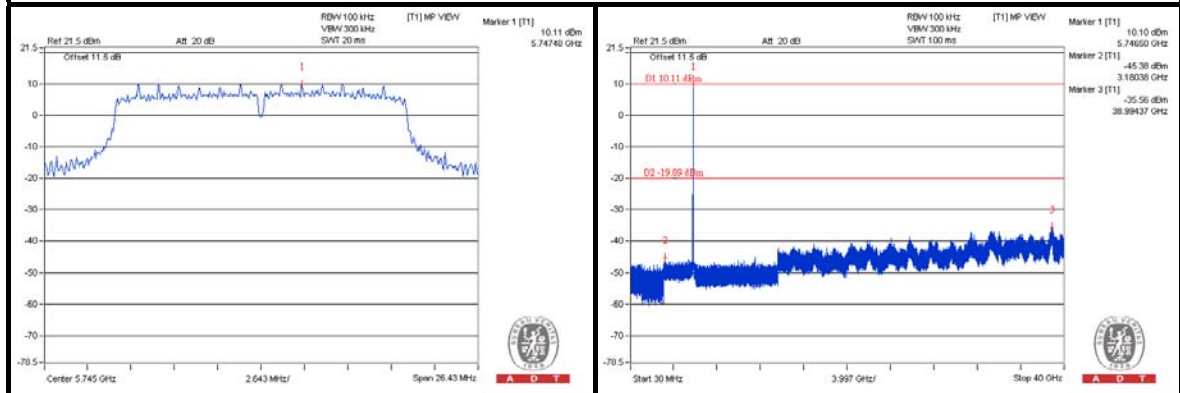

CH 157

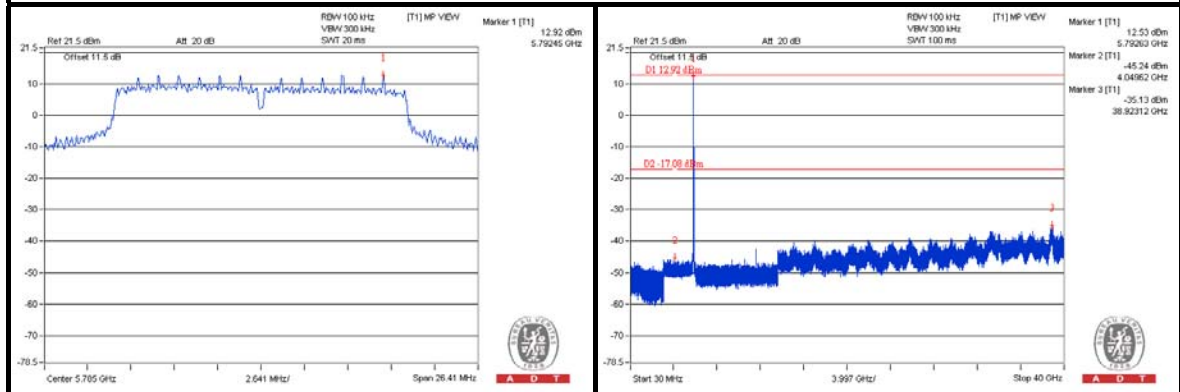

CH 165

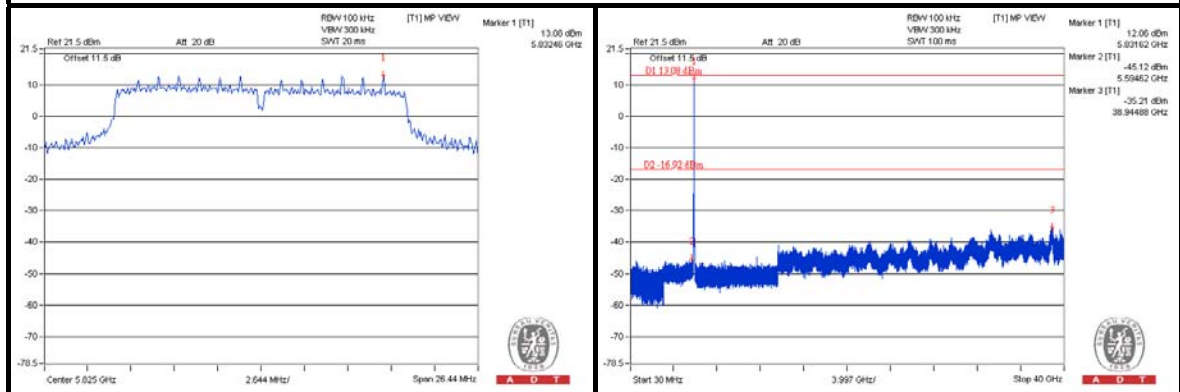

CH 149 Band edge

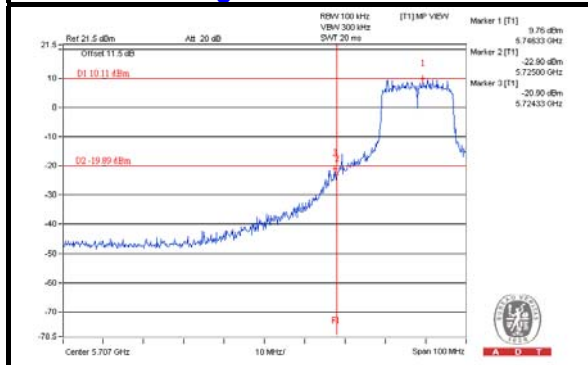

CH 165 Band edge

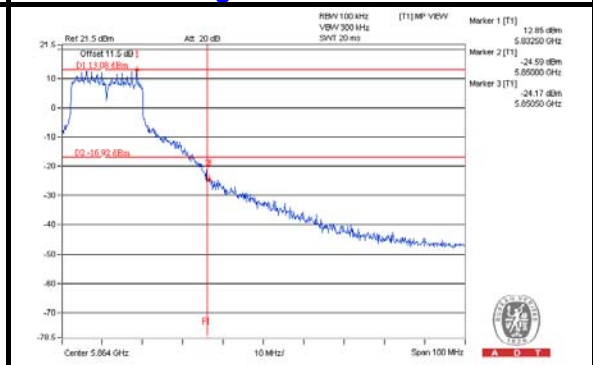



A D T

CHAIN 2

CH 149

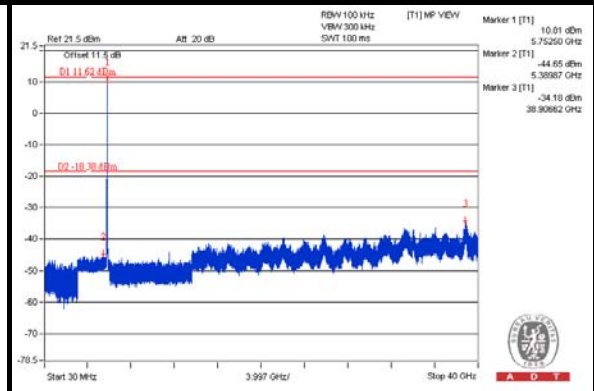
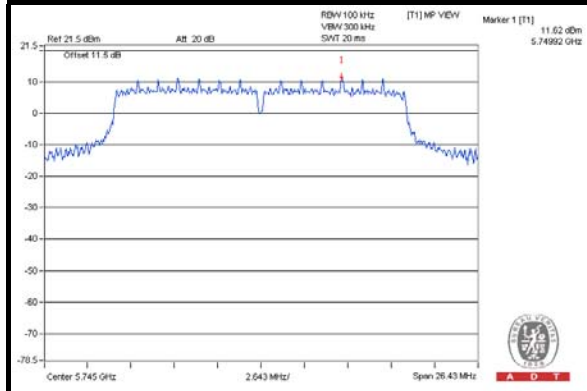

CH 157

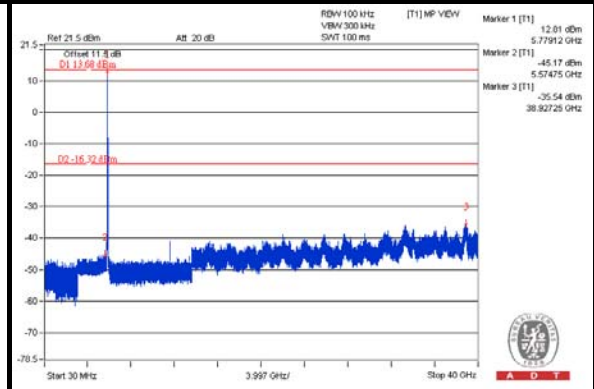
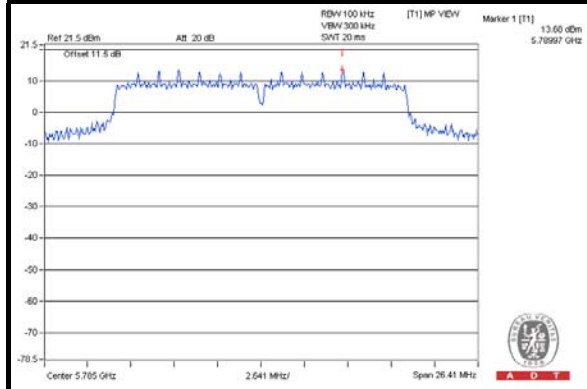

CH 165

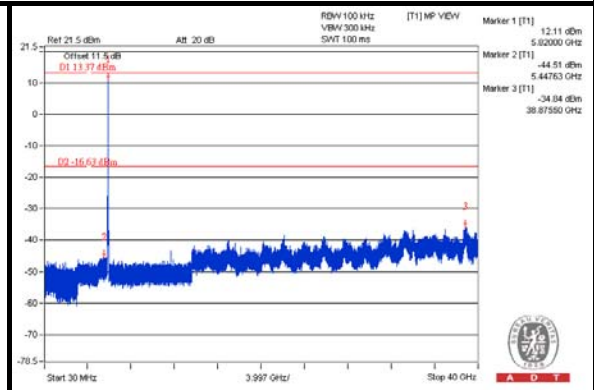
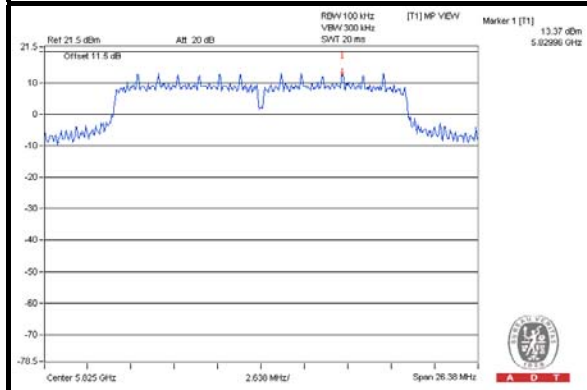

CH 149 Band edge

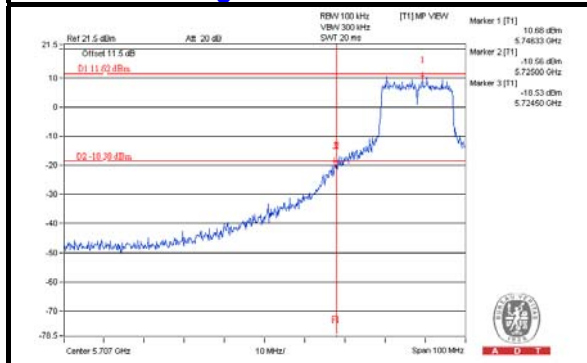

CH 165 Band edge

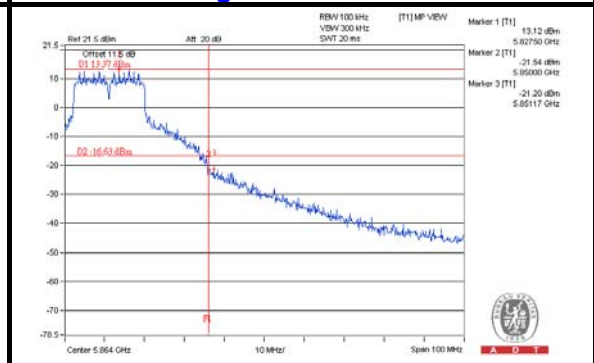



A D T

802.11n (40MHz)

CHAIN 0

CH 151

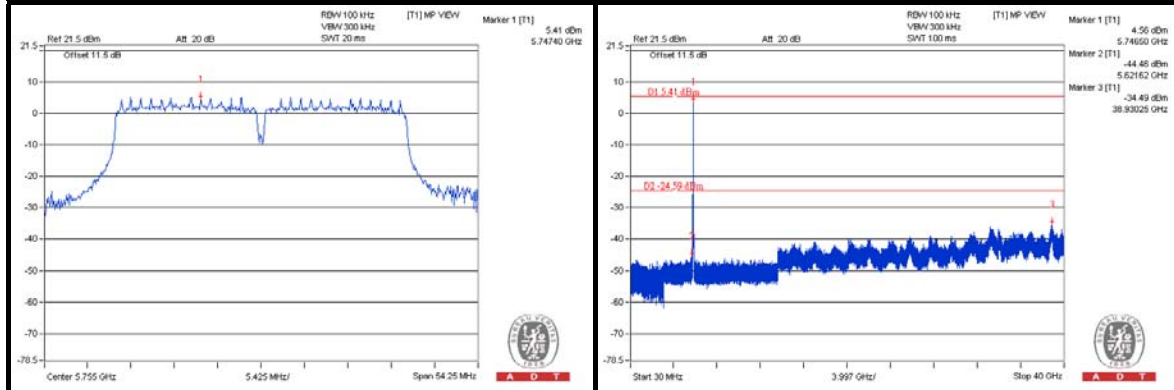

CH 159

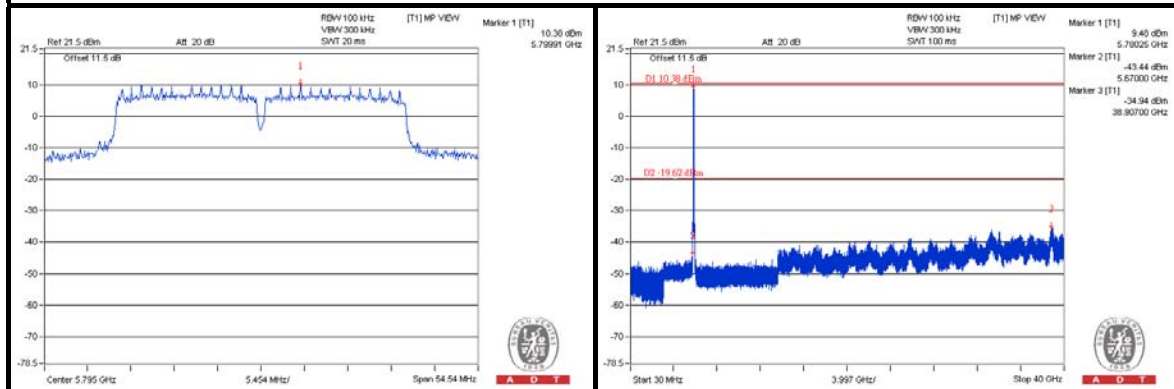

CH 151 Band edge

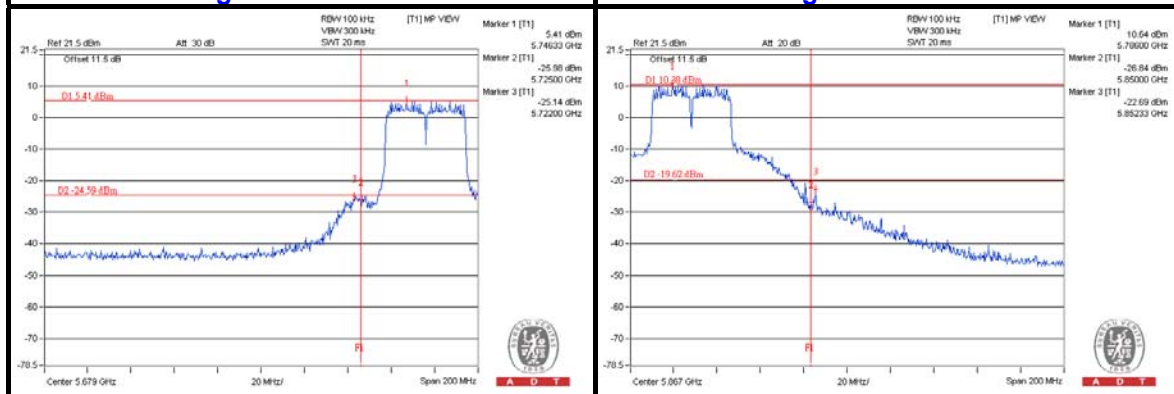



A D T

CHAIN 1

CH 151

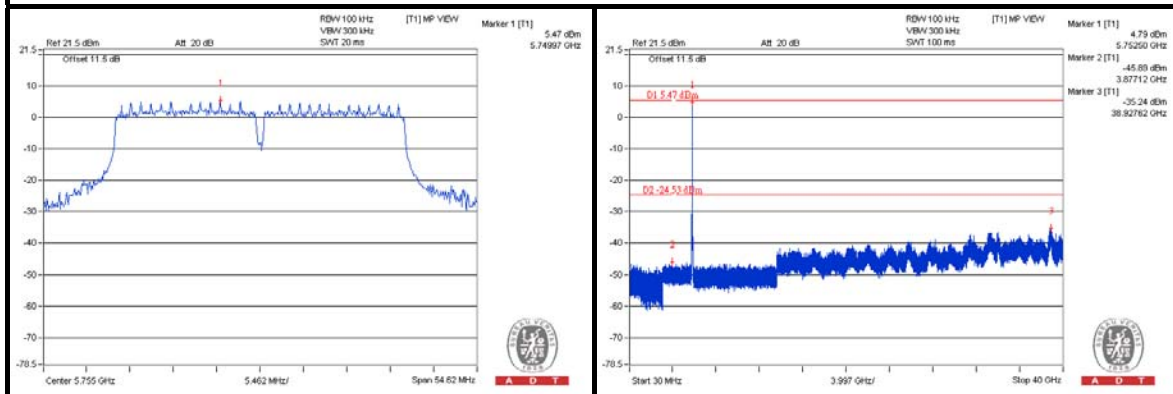

CH 159

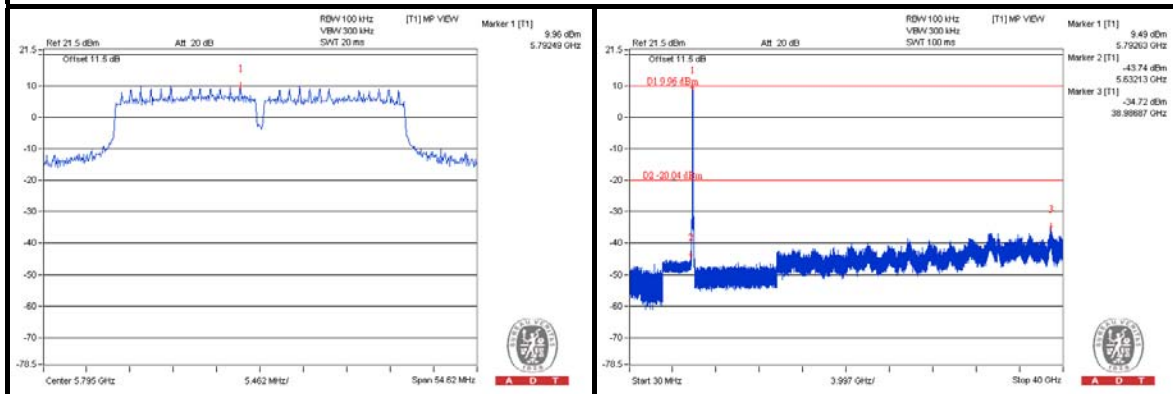

CH 151 Band edge

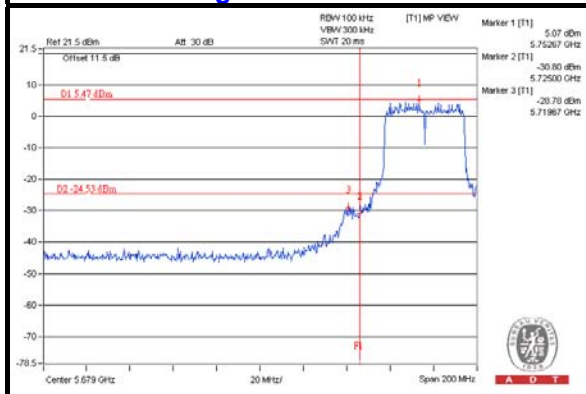

CH 159 Band edge

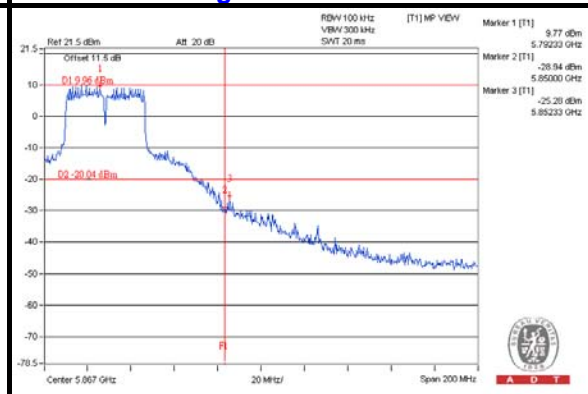



A D T

CHAIN 2

CH 151

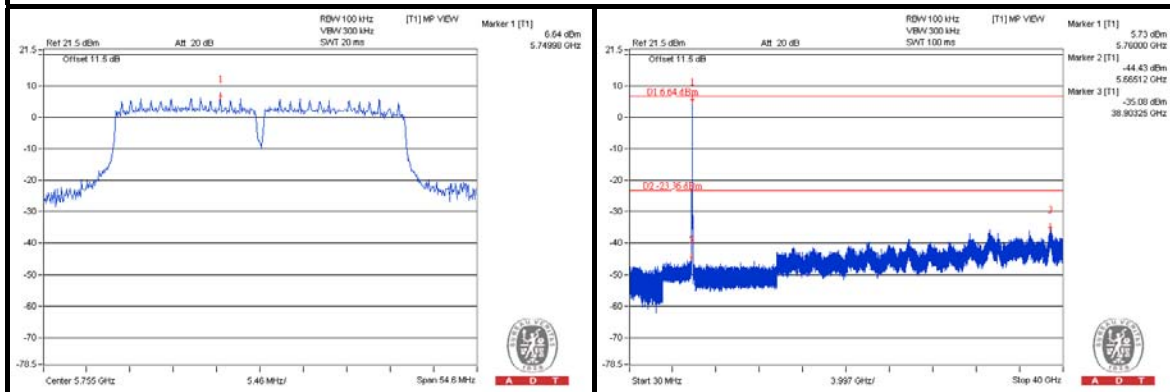

CH 159

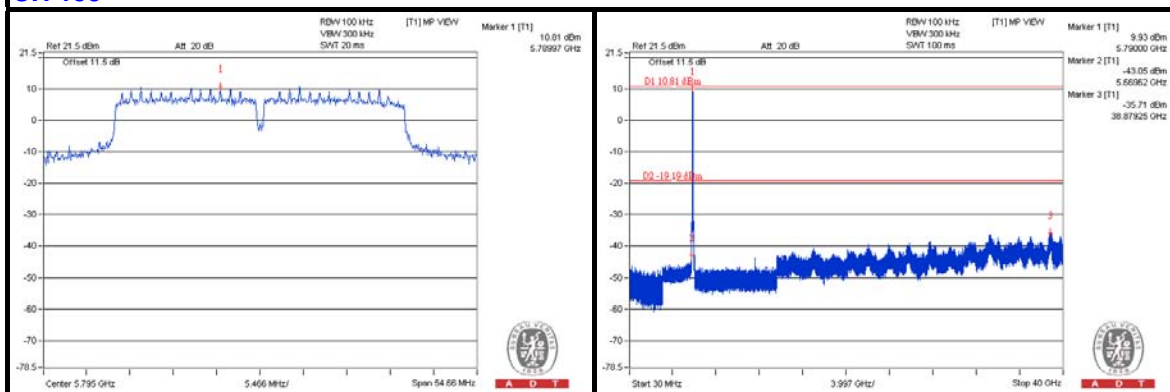

CH 151 Band edge

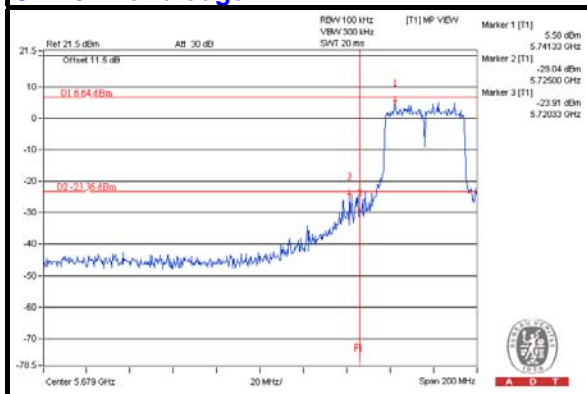

CH 159 Band edge

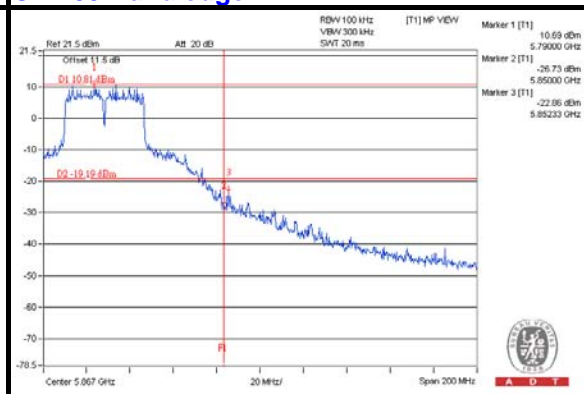



A D T

802.11ac (80MHz)

CHAIN 0

CH 155

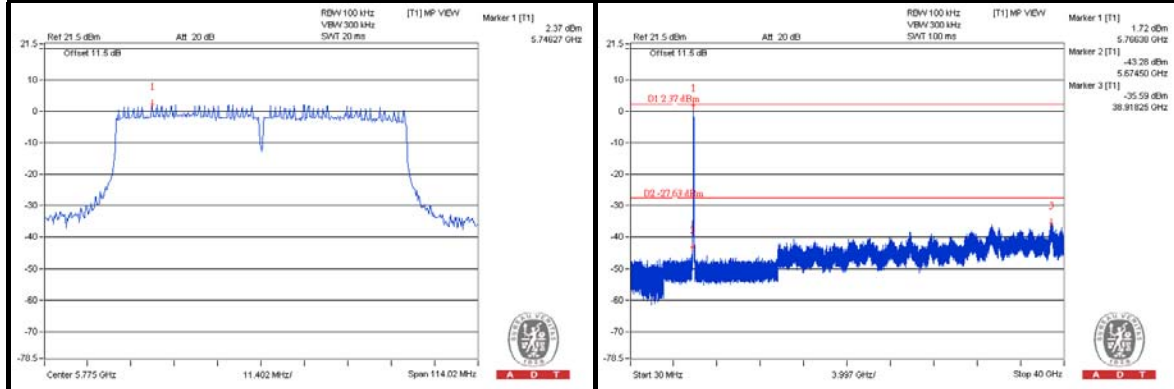

CH 155 Band edge

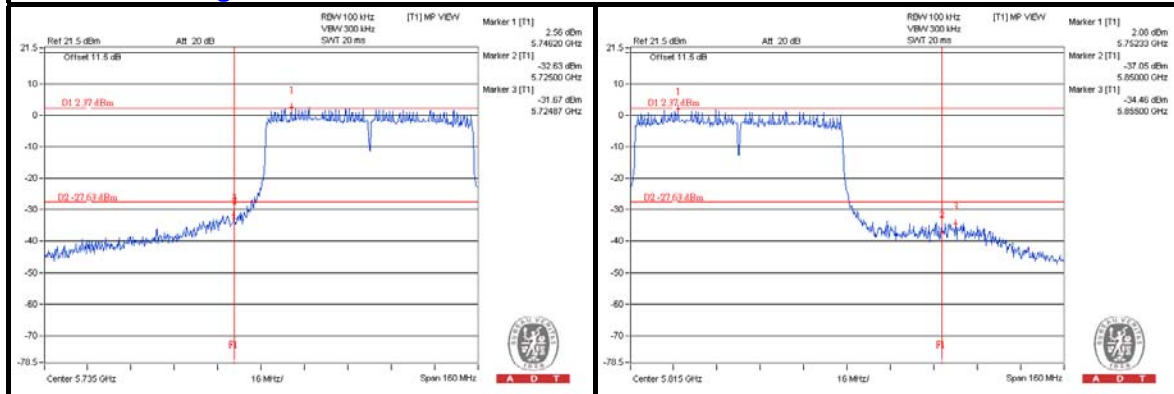

CHAIN 1

CH 155

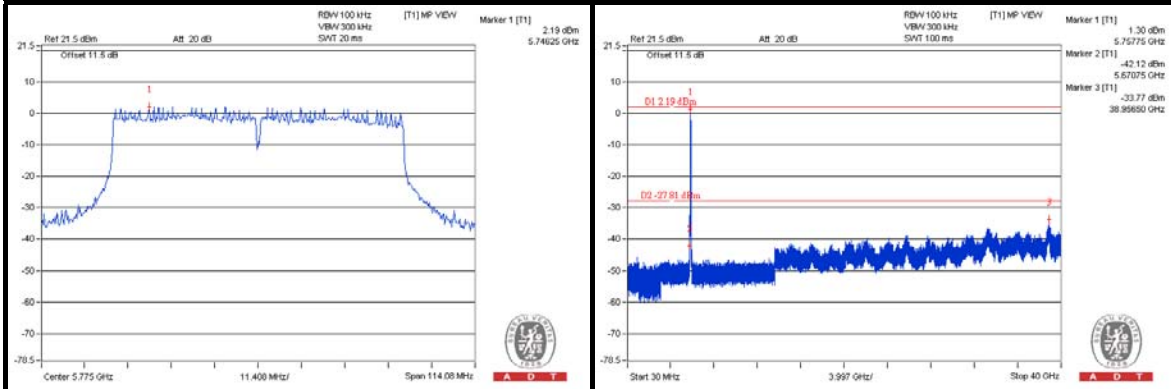

CH 155 Band edge

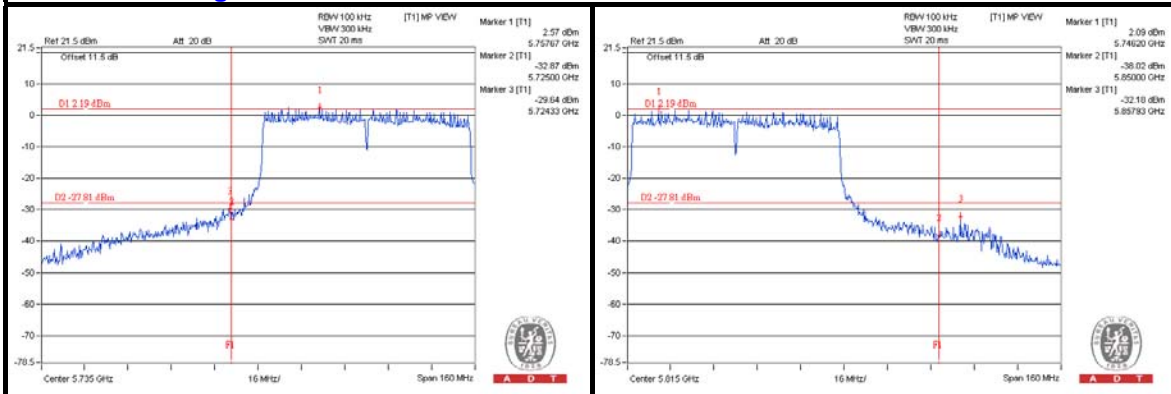

CHAIN 2

CH 155

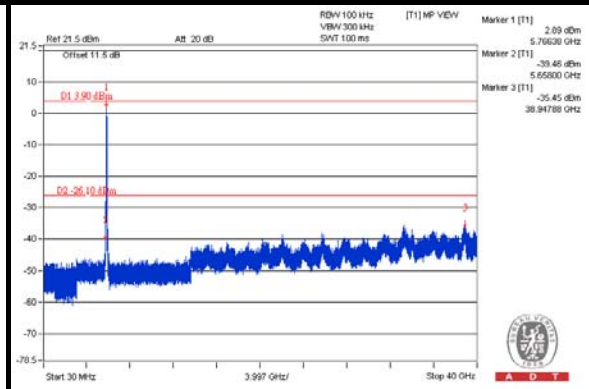
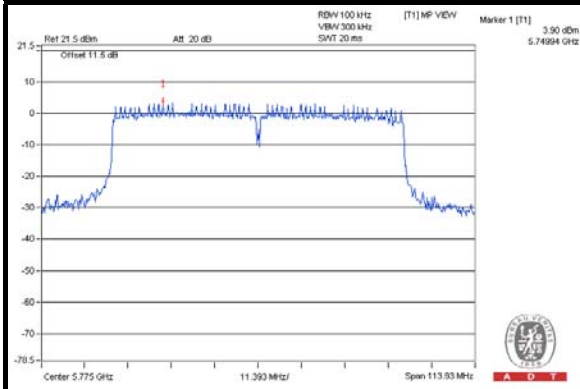

CH 155 Band edge

