

FCC Co-Location Test Report

FCC ID : QXO-4200
Equipment : Wireless 802.11 ac/a + b/g/n Access Point
Model No. : WS-AP3805i, WS-AP3801i, WS-AP3805e
Brand Name : Extreme Networks
Applicant : Extreme Networks, Inc.
Address : 9 Northeastern Blvd., Salem, New Hampshire,
United States, 03079
Standard : 47 CFR FCC Part 15.247
47 CFR FCC Part 15.407
Received Date : Jun. 13, 2014
Tested Date : Jul. 01 ~ Oct. 18, 2014

We, International Certification Corp., would like to declare that the tested sample has been evaluated and in compliance with the requirement of the above standards. The test results contained in this report refer exclusively to the product. It may be duplicated completely for legal use with the approval of the applicant. It shall not be reproduced except in full without the written approval of our laboratory.

Approved & Reviewed by:



Gary Chang / Manager

Table of Contents

1.1	The Equipment List	8
1.2	Test Standards	8
1.3	Measurement Uncertainty	9
2	TEST CONFIGURATION	10
2.1	Testing Condition	10
2.2	The Worst Test Modes and Channel Details	10
3	TRANSMITTER TEST RESULTS.....	11
3.1	Unwanted Emissions into Restricted Frequency Bands	11
4	TEST LABORATORY INFORMATION	37

Release Record

Report No.	Version	Description	Issued Date
FR482702	Rev. 01	Initial issue	Nov. 10, 2014

Summary of Test Results

FCC Rules	Test Items	Measured	Result
15.247(d) 15.407(b) 15.209	Radiated Emissions	[dBuV/m at 3m]: 37.94MHz 38.76 (Margin -1.24dB) – QP	Pass

1 General Description

1.1 Information

1.1.1 Product Details

The following models are provided to this EUT.

Brand Name	Model Name	Product Name	Description
Extreme Networks	WS-AP3805i	Wireless 802.11 ac/a + b/g/n Access Point	Internal PIFA antenna
Extreme Networks	WS-AP3801i	Wireless 802.11 ac/a + b/g/n Access Point	Internal PIFA antenna
Extreme Networks	WS-AP3805e	Wireless 802.11 ac/a + b/g/n Access Point	External Dipole antenna

Note: The AP3805i and AP3801i use identical hardware. The only difference is the AP3801i is software limited to prevent simultaneous operation in the 2.4 GHz and 5GHz bands.

1.1.2 Specification of the Equipment under Test (EUT)

RF General Information					
Frequency Range (MHz)	IEEE Std. 802.11	Ch. Freq. (MHz)	Channel Number	Transmit Chains (N _{TX})	Data Rate / MCS
2400-2483.5	b	2412-2462	1-11 [11]	2	1-11 Mbps
2400-2483.5	g	2412-2462	1-11 [11]	2	6-54 Mbps
2400-2483.5	n (HT20)	2412-2462	1-11 [11]	2	MCS 0-15
2400-2483.5	n (HT40)	2422-2452	3-9 [7]	2	MCS 0-15

Note 1: RF output power specifies that Maximum Peak Conducted Output Power.
 Note 2: 802.11b uses a combination of DSSS-DBPSK, DQPSK, CCK modulation.
 Note 3: 802.11g/n uses a combination of OFDM-BPSK, QPSK, 16QAM, 64QAM modulation.

RF General Information					
Frequency Range (MHz)	IEEE Std. 802.11	Ch. Freq. (MHz)	Channel Number	Transmit Chains (N _{TX})	Data Rate / MCS
5150-5250	a	5180-5240	36-48 [4]	2	6-54 Mbps
5150-5250	n (HT20)	5180-5240	36-48 [4]	2	MCS 0-15
5150-5250	n (HT40)	5190-5230	38-46 [2]	2	MCS 0-15
5150-5250	ac (VHT20)	5180-5240	36-48 [4]	2	MCS 0-8
5150-5250	ac (VHT40)	5190-5230	38-46 [2]	2	MCS 0-9
5150-5250	ac (VHT80)	5210	42 [1]	2	MCS 0-9

Note 1: RF output power specifies that Maximum Conducted Output Power.
 Note 2: 802.11a/n/ac uses a combination of OFDM-BPSK, QPSK, 16QAM, 64QAM, 256QAM modulation.

RF General Information					
Frequency Range (MHz)	IEEE Std. 802.11	Ch. Freq. (MHz)	Channel Number	Transmit Chains (N _{TX})	Data Rate / MCS
5725-5850	a	5745-5825	149-165 [5]	2	6-54 Mbps
5725-5850	n (HT20)	5745-5825	149-165 [5]	2	MCS 0-15
5725-5850	n (HT40)	5755-5795	151-159 [2]	2	MCS 0-15
5725-5850	ac (VHT20)	5745-5825	149-165 [5]	2	MCS 0-8
5725-5850	ac (VHT40)	5755-5795	151-159 [2]	2	MCS 0-9
5725-5850	ac (VHT80)	5775	155 [1]	2	MCS 0-9

Note 1: RF output power specifies that Maximum Conducted Output Power.
 Note 2: 802.11a/n/ac uses a combination of OFDM-BPSK, QPSK, 16QAM, 64QAM, 256QAM modulation.

1.1.3 Antenna Details

Ant. No.	Model	Type	Connector	Operating Frequencies (MHz) / Antenna Gain (dBi)		
				2400~2483.5	5150~5250	5725~5850
1	5718A0075300	PIFA	I-Pex	3.52	---	---
2	5718A0074300	PIFA	I-Pex	3.16	---	---
3	5718A0077300	PIFA	I-Pex	---	5.40	5.23
4	5718A0076300	PIFA	I-Pex	---	4.08	5.68
5	7102A0300000	Dipole	R SMA	4.42	---	---
6	7102A0301000	Dipole	R SMA	---	3.18	2.95
7	WS-AI-DQ04360	Directional Panel	RPSMA	4	7	7
8	WS-AI-DD05120	Directional Panel	RPSMA	5	5	5

1.1.4 Power Supply Type of Equipment under Test (EUT)

Power Supply Type	12Vdc from adapter / 48Vdc from PoE
--------------------------	-------------------------------------

1.1.5 Accessories & Support Units

Accessories & Support Units		
No.	Equipment	Description
1	Power Supply Type 1 Adapter	Brand: Powertron Electronics Corp. Model: PA1015-2I I/P: 100-240Vac, 50-60Hz, 0.4A O/P: 12Vdc, 1.25A, 15W Power line: 1.2m non-shielded with one core
2	Power Supply Type 2 With POE injector (Model: EPE-48GR) **Support unit only	Brand: Powertron Electronics Corp. Model: PA1040-480IB080 I/P: 100-240Vac, 50-60Hz, 1.5A O/P: 48Vdc, 0.8A, 38.4W max Power line: 1.5m non-shielded with one core

1.2 The Equipment List

Test Item	Radiated Emission				
Test Site	966 chamber1 / (03CH01-WS)				
Instrument	Manufacturer	Model No.	Serial No.	Calibration Date	Calibration Until
Spectrum Analyzer	R&S	FSV40	101498	Jan. 25, 2014	Jan. 24, 2015
Receiver	R&S	ESR3	101658	Jan. 10, 2014	Jan. 09, 2015
Bilog Antenna	SCHWARZBECK	VULB9168	VULB9168-523	Jan. 23, 2014	Jan. 22, 2015
Horn Antenna 1G-18G	SCHWARZBECK	BBHA 9120 D	BBHA 9120 D 1096	Feb. 13, 2014	Feb. 12, 2015
Horn Antenna 18G-40G	SCHWARZBECK	BBHA 9170	BBHA 9170517	Dec. 27, 2013	Dec. 26, 2014
Preamplifier	Burgeon	BPA-530	100218	Dec. 09, 2013	Dec. 08, 2014
Preamplifier	Agilent	83017A	MY39501308	Dec. 16, 2013	Dec. 15, 2014
RF Cable	HUBER+SUHNER	SUCOFLEX104	MY16014/4	Dec. 16, 2013	Dec. 15, 2014
RF Cable	HUBER+SUHNER	SUCOFLEX104	MY16019/4	Dec. 16, 2013	Dec. 15, 2014
RF Cable	HUBER+SUHNER	SUCOFLEX104	MY16139/4	Dec. 16, 2013	Dec. 15, 2014
LF cable 3M	Woken	CFD400NL-LW	CFD400NL-001	Dec. 16, 2013	Dec. 15, 2014
LF cable 10M	Woken	CFD400NL-LW	CFD400NL-002	Dec. 16, 2013	Dec. 15, 2014
Measurement Software	AUDIX	e3	6.120210g	NA	NA

Note: Calibration Interval of instruments listed above is one year.

Loop Antenna	R&S	HFH2-Z2	100330	Nov. 15, 2012	Nov. 14, 2014
Amplifier	EM	EM18G40G	060604	Oct. 17, 2013	Oct. 16, 2015

Note: Calibration Interval of instruments listed above is two year.

1.3 Test Standards

According to the specification of EUT, the EUT must comply with following standards and KDB documents.

47 CFR FCC Part 15.247

47 CFR FCC Part 15.407

ANSI C63.10-2009

FCC KDB 412172

FCC 789033 D02 General UNII Test Procedures New Rules v01

FCC KDB 644545 D03 Guidance for IEEE 802 11ac New Rules v01

FCC KDB 558074 D01 DTS Meas Guidance v03r02

FCC KDB 662911 D01 Multiple Transmitter Output v02r01

1.4 Measurement Uncertainty

ISO/IEC 17025 requires that an estimate of the measurement uncertainties associated with the emissions test results be included in the report. The measurement uncertainties given below are based on a 95% confidence level (based on a coverage factor (k=2))

Measurement Uncertainty	
Parameters	Uncertainty
Radiated emission \leq 1GHz	± 3.26 dB
Radiated emission $>$ 1GHz	± 4.94 dB

2 Test Configuration

2.1 Testing Condition

Test Item	Test Site	Ambient Condition	Tested By
Radiated Emissions	03CH01-WS	22-25°C / 64-68%	Anderson Hong Haru Yang

➤ FCC site registration No.: 657002

➤ IC site registration No.: 10807A-1

2.2 The Worst Test Modes and Channel Details

Test item	Modulation Mode	Test Channel	Data rate	Test Configuration
Radiated Emissions ≤1GHz	2.4G 11n 20 + 5G 11ac VHT20	CH6 + CH48	MCS 0 + MCS 0	1, 5
	2.4G 11g + 5G 11a	CH6 + CH40	6Mbps + 6Mbps	2, 6
	2.4G 11g + 5G 11ac VHT20	CH6 + CH40	6Mbps + MCS 0	3, 7
	2.4G 11n 20 + 5G 11ac VHT20	CH6 + CH40	MCS 0 + MCS 0	4, 8
Radiated Emissions >1GHz	2.4G 11n 20 + 5G 11ac VHT20	CH6 + CH48	MCS 0 + MCS 0	1
	2.4G 11g + 5G 11a	CH6 + CH40	6Mbps + 6Mbps	2
	2.4G 11g + 5G 11ac VHT20	CH6 + CH40	6Mbps + MCS 0	3
	2.4G 11n 20 + 5G 11ac VHT20	CH6 + CH40	MCS 0 + MCS 0	4

NOTE:

1. The EUT was pretested with 3 orientations placed on the table for the radiated emission measurement – X, Y, and Z-plane. Refer to the following configurations for each worst case plane.
2. The final test configurations are listed as follows:
 - 1) Configuration 1: Internal PIFA antenna, Adapter mode, Y-plane.
 - 2) Configuration 2: External Dipole antenna, Adapter mode, Y-plane.
 - 3) Configuration 3: External Directional Panel antenna (model WS-AI-DQ04360), Adapter mode, Y-plane.
 - 4) Configuration 4: External Directional Panel antenna (model WS-AI-DD05120), Adapter mode, Y-plane.
 - 5) Configuration 5: Internal PIFA antenna, POE mode, Y-plane.
 - 6) Configuration 6: External Dipole antenna, POE mode, Y-plane.
 - 7) Configuration 7: External Directional Panel antenna (model WS-AI-DQ04360), POE mode, Y-plane.
 - 8) Configuration 8: External Directional Panel antenna (model WS-AI-DD05120), POE mode, Y-plane.

3 Transmitter Test Results

3.1 Unwanted Emissions into Restricted Frequency Bands

3.1.1 Limit of Unwanted Emissions into Restricted Frequency Bands

Restricted Band Emissions Limit			
Frequency Range (MHz)	Field Strength (uV/m)	Field Strength (dBuV/m)	Measure Distance (m)
0.009~0.490	2400/F(kHz)	48.5 - 13.8	300
0.490~1.705	24000/F(kHz)	33.8 - 23	30
1.705~30.0	30	29	30
30~88	100	40	3
88~216	150	43.5	3
216~960	200	46	3
Above 960	500	54	3

Note 1:
Qusai-Peak value is measured for frequency below 1GHz except for 9–90 kHz, 110–490 kHz frequency band. Peak and average value are measured for frequency above 1GHz. The limit on average radio frequency emission is as above table. The limit on peak radio frequency emissions is 20 dB above the maximum permitted average emission limit

Note 2:
Measurements may be performed at a distance other than what is specified provided. When performing measurements at a distance other than that specified, the results shall be extrapolated to the specified distance using an extrapolation factor as below, Frequency at or above 30 MHz: 20 dB/decade Frequency below 30 MHz: 40 dB/decade.

3.1.2 Test Procedures

1. Measurement is made at a semi-anechoic chamber that incorporates a turntable allowing a EUT rotation of 360°. A continuously-rotating, remotely-controlled turntable is installed at the test site to support the EUT and facilitate determination of the direction of maximum radiation for each EUT emission frequency. The EUT is placed at a height of 0.8 m test table above the ground plane.
2. Measurement is made with the antenna positioned in both the horizontal and vertical planes of polarization. The measurement antenna is varied in height (1m ~ 4m) above the reference ground plane to obtain the maximum signal strength. Distance between EUT and antenna is 3 m.
3. This investigation is performed with the EUT rotated 360°, the antenna height scanned between 1 m and 4 m, and the antenna rotated to repeat the measurements for both the horizontal and vertical antenna polarizations.

Note:

1. 120kHz measurement bandwidth of test receiver and Quasi-peak detector is for radiated emission below 1GHz.
2. RBW=1MHz, VBW=3MHz and Peak detector is for peak measured value of radiated emission above 1GHz.
3. RBW=1MHz, VBW=1/T and Peak detector is for average measured value of radiated emission above 1GHz.

3.1.3 Test Setup

Radiated Emissions below 1 GHz

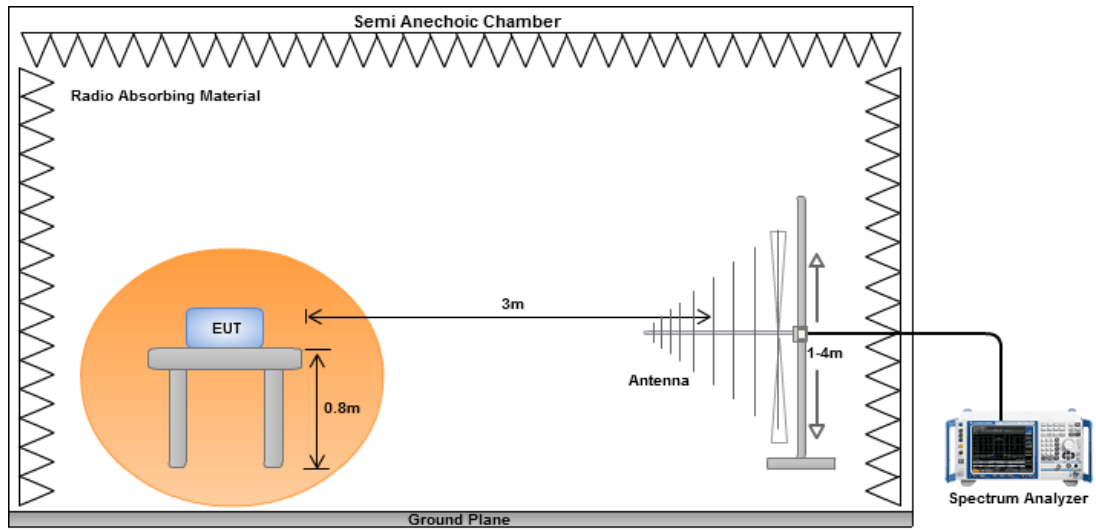

Radiated Emissions above 1 GHz

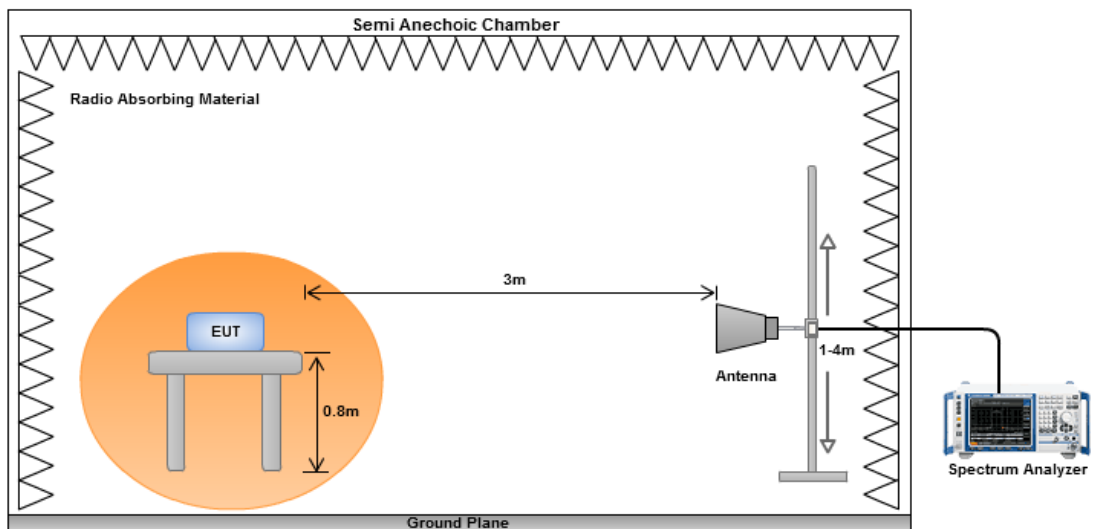

3.1.4 Transmitter Radiated Unwanted Emissions (Below 1GHz) (Configuration 1: Internal PIFA antenna)

Modulation	2.4G 11n 20 + 5G 11ac VHT20	Test Channel	CH6 + CH48
Polarization	Horizontal	Test Configuration	1

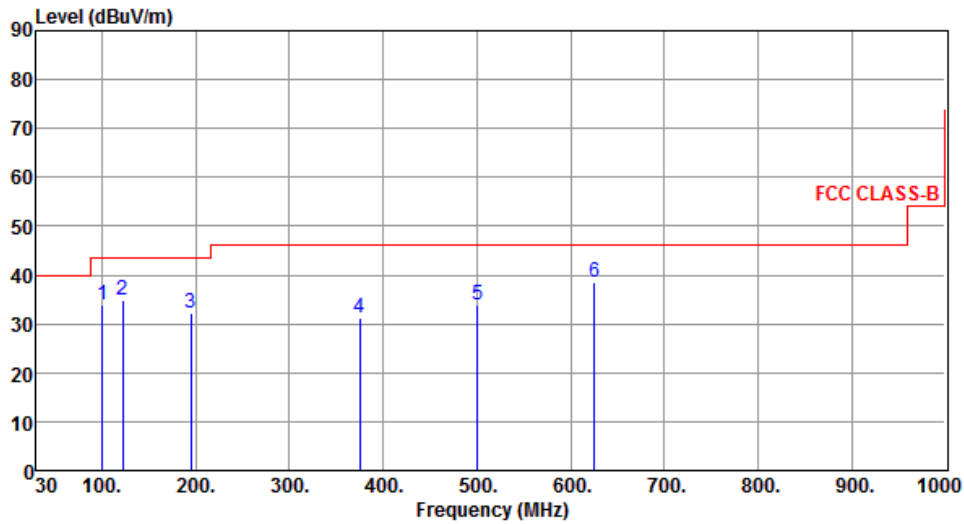

	Freq. MHz	Emission level dBuV/m	Limit dBuV/m	Margin dB	SA reading dBuV	Factor dB	Remark	ANT High cm	Turn Table deg
1	100.53	33.94	43.50	-9.56	55.69	-21.75	Peak	---	---
2	122.43	34.87	43.50	-8.63	53.80	-18.93	Peak	---	---
3	194.58	32.26	43.50	-11.24	51.89	-19.63	Peak	---	---
4	375.26	31.17	46.00	-14.83	45.51	-14.34	Peak	---	---
5	500.39	33.99	46.00	-12.01	45.53	-11.54	Peak	---	---
6	625.49	38.36	46.00	-7.64	47.54	-9.18	Peak	---	---

Note 1: Emission Level (dBuV/m) = SA Reading (dBuV/m) + Factor* (dB)

*Factor includes antenna factor , cable loss and amplifier gain

Note 2: Margin (dB) = Emission level (dBuV/m) – Limit (dBuV/m).

Modulation	2.4G 11n 20 + 5G 11ac VHT20	Test Channel	CH6 + CH48
Polarization	Vertical	Test Configuration	1

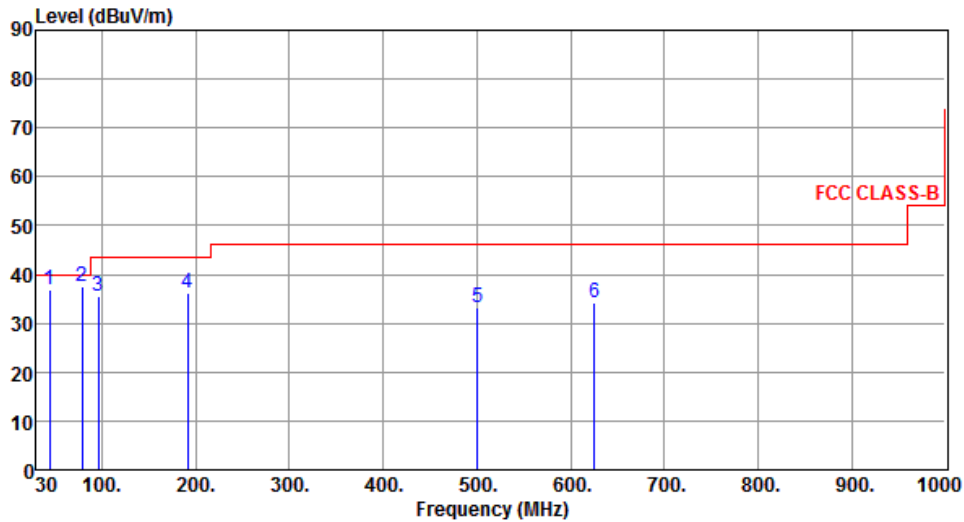

	Freq. MHz	Emission level dBuV/m	Limit dBuV/m	Margin dB	SA reading dBuV	Factor dB	Remark	ANT High cm	Turn Table deg
1	44.52	36.89	40.00	-3.11	53.71	-16.82	Peak	---	---
2	79.23	37.54	40.00	-2.46	59.01	-21.47	Peak	---	---
3	96.54	35.70	43.50	-7.80	57.95	-22.25	Peak	---	---
4	191.61	36.24	43.50	-7.26	55.85	-19.61	Peak	---	---
5	500.35	33.33	46.00	-12.67	44.87	-11.54	Peak	---	---
6	625.47	34.28	46.00	-11.72	43.46	-9.18	Peak	---	---

Note 1: Emission Level (dBuV/m) = SA Reading (dBuV/m) + Factor* (dB)

*Factor includes antenna factor , cable loss and amplifier gain

Note 2: Margin (dB) = Emission level (dBuV/m) – Limit (dBuV/m).

3.1.5 Transmitter Radiated Unwanted Emissions (Below 1GHz) (Configuration 2: External Dipole antenna)

Modulation	2.4G 11g + 5G 11a	Test Channel	CH6 + CH40
Polarization	Horizontal	Test Configuration	2

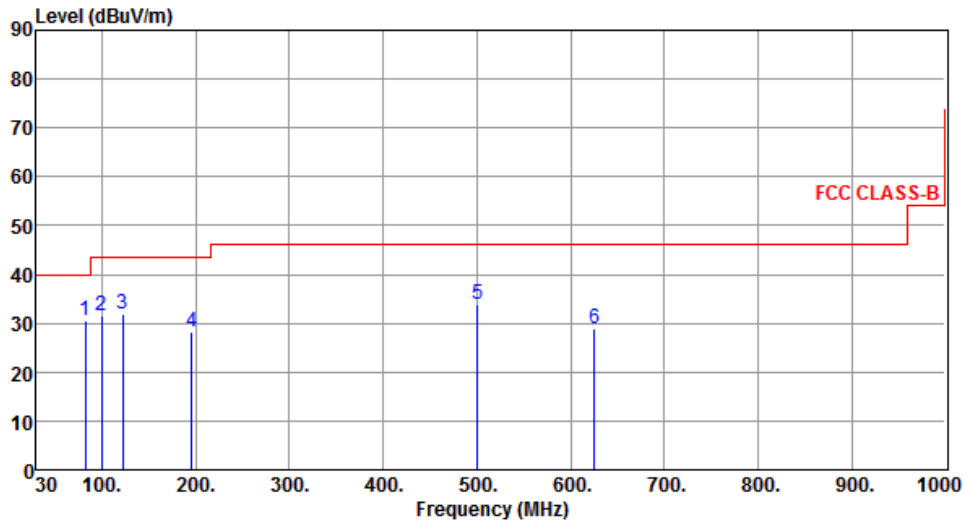

	Freq. MHz	Emission level dBuV/m	Limit dBuV/m	Margin dB	SA reading dBuV	Factor dB	Remark	ANT High cm	Turn Table deg
1	81.88	30.43	40.00	-9.57	52.31	-21.88	Peak	---	---
2	99.53	31.48	43.50	-12.02	53.36	-21.88	Peak	---	---
3	122.46	31.94	43.50	-11.56	50.86	-18.92	Peak	---	---
4	195.87	28.33	43.50	-15.17	47.96	-19.63	Peak	---	---
5	500.43	33.75	46.00	-12.25	45.29	-11.54	Peak	---	---
6	625.50	28.78	46.00	-17.22	37.96	-9.18	Peak	---	---

Note 1: Emission Level (dBuV/m) = SA Reading (dBuV/m) + Factor* (dB)

*Factor includes antenna factor , cable loss and amplifier gain

Note 2: Margin (dB) = Emission level (dBuV/m) – Limit (dBuV/m).

Modulation	2.4G 11g + 5G 11a	Test Channel	CH6 + CH40
Polarization	Vertical	Test Configuration	2

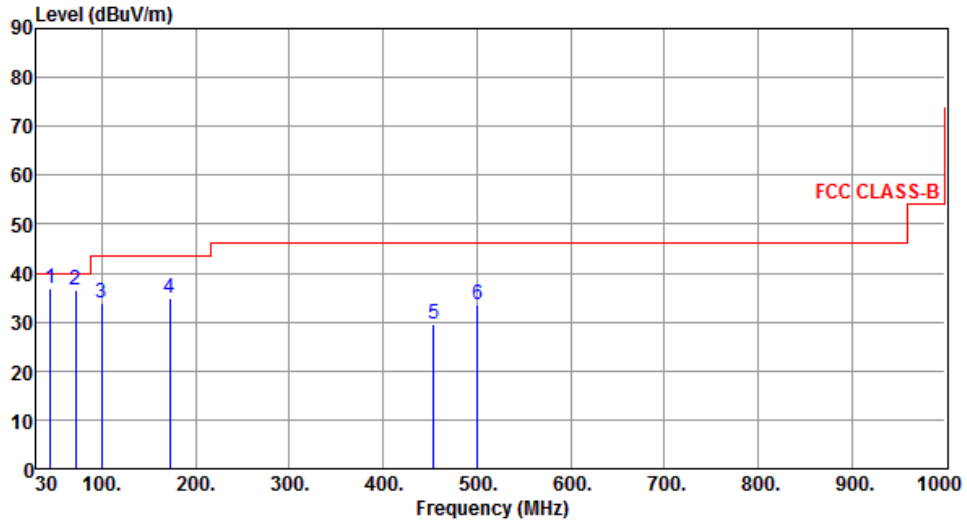

	Freq. MHz	Emission level dBuV/m	Limit dBuV/m	Margin dB	SA reading dBuV	Factor dB	Remark	ANT High cm	Turn Table deg
1	45.32	36.76	40.00	-3.24	53.54	-16.78	Peak	---	---
2	72.25	36.46	40.00	-3.54	56.38	-19.92	Peak	---	---
3	99.88	33.75	43.50	-9.75	55.59	-21.84	Peak	---	---
4	172.43	34.81	43.50	-8.69	52.52	-17.71	Peak	---	---
5	453.74	29.60	46.00	-16.40	42.05	-12.45	Peak	---	---
6	500.49	33.58	46.00	-12.42	45.12	-11.54	Peak	---	---

Note 1: Emission Level (dBuV/m) = SA Reading (dBuV/m) + Factor* (dB)

*Factor includes antenna factor , cable loss and amplifier gain

Note 2: Margin (dB) = Emission level (dBuV/m) – Limit (dBuV/m).

3.1.6 Transmitter Radiated Unwanted Emissions (Below 1GHz) (Configuration 3: External Directional Panel antenna (model WS-AI-DQ04360))

Modulation	2.4G 11g + 5G 11ac VHT20	Test Channel	CH6 + CH40
Polarization	Horizontal	Test Configuration	3

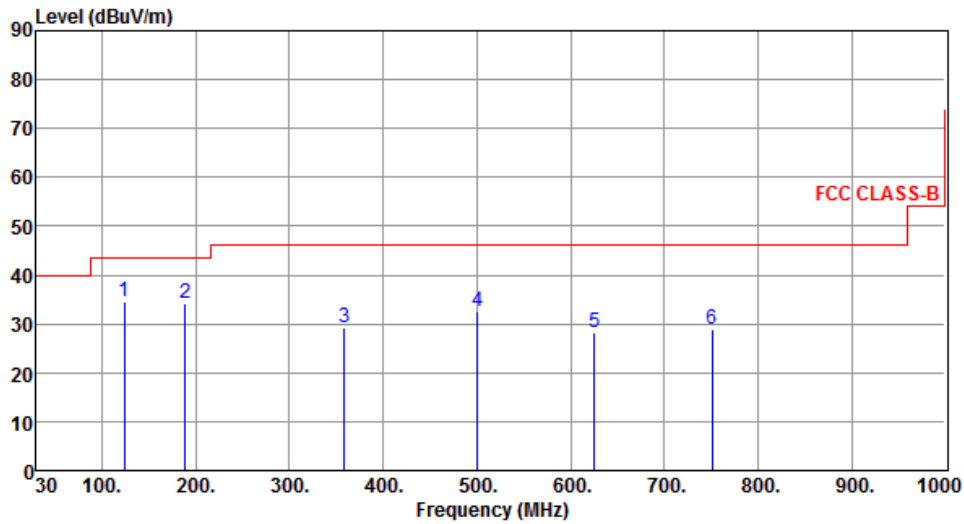

	Freq. MHz	Emission level dBuV/m	Limit dBuV/m	Margin dB	SA reading dBuV	Factor dB	Remark	ANT High cm	Turn Table deg
1	124.09	34.58	43.50	-8.92	53.30	-18.72	Peak	---	---
2	189.08	34.27	43.50	-9.23	53.29	-19.02	Peak	---	---
3	358.83	29.35	46.00	-16.65	44.02	-14.67	Peak	---	---
4	500.45	32.70	46.00	-13.30	44.11	-11.41	Peak	---	---
5	625.58	28.14	46.00	-17.86	37.34	-9.20	Peak	---	---
6	750.71	28.74	46.00	-17.26	35.80	-7.06	Peak	---	---

Note 1: Emission Level (dBuV/m) = SA Reading (dBuV/m) + Factor* (dB)

*Factor includes antenna factor , cable loss and amplifier gain

Note 2: Margin (dB) = Emission level (dBuV/m) – Limit (dBuV/m).

Modulation	2.4G 11g + 5G 11ac VHT20	Test Channel	CH6 + CH40
Polarization	Vertical	Test Configuration	3

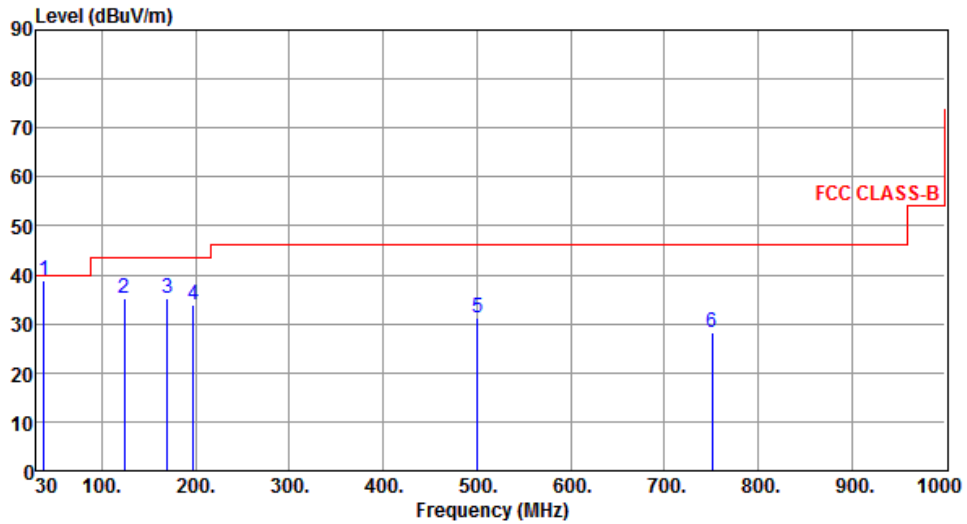

	Freq. MHz	Emission level dBuV/m	Limit dBuV/m	Margin dB	SA reading dBuV	Factor dB	Remark	ANT High cm	Turn Table deg
1	37.94	38.76	40.00	-1.24	55.80	-17.04	QP	---	---
2	124.09	35.33	43.50	-8.17	54.05	-18.72	Peak	---	---
3	169.68	35.04	43.50	-8.46	52.00	-16.96	Peak	---	---
4	197.81	33.91	43.50	-9.59	53.08	-19.17	Peak	---	---
5	500.45	31.20	46.00	-14.80	42.61	-11.41	Peak	---	---
6	750.71	28.36	46.00	-17.64	35.42	-7.06	Peak	---	---

Note 1: Emission Level (dBuV/m) = SA Reading (dBuV/m) + Factor* (dB)

*Factor includes antenna factor , cable loss and amplifier gain

Note 2: Margin (dB) = Emission level (dBuV/m) – Limit (dBuV/m).

3.1.7 Transmitter Radiated Unwanted Emissions (Below 1GHz) (Configuration 4: External Directional Panel antenna (model WS-AI-DD05120))

Modulation	2.4G 11n 20 + 5G 11ac VHT20	Test Channel	CH6 + CH40
Polarization	Horizontal	Test Configuration	4

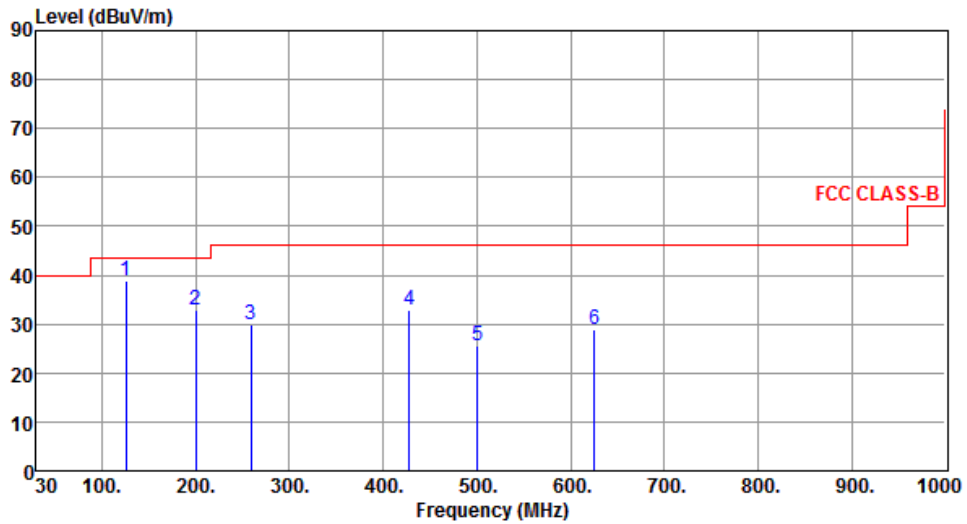

	Freq. MHz	Emission level dBuV/m	Limit dBuV/m	Margin dB	SA reading dBuV	Factor dB	Remark	ANT High cm	Turn Table deg
1	126.03	38.83	43.50	-4.67	57.35	-18.52	Peak	---	---
2	199.75	32.92	43.50	-10.58	52.10	-19.18	Peak	---	---
3	258.92	29.86	46.00	-16.14	47.31	-17.45	Peak	---	---
4	427.70	32.96	46.00	-13.04	45.93	-12.97	Peak	---	---
5	500.45	25.55	46.00	-20.45	36.96	-11.41	Peak	---	---
6	625.58	28.92	46.00	-17.08	38.12	-9.20	Peak	---	---

Note 1: Emission Level (dBuV/m) = SA Reading (dBuV/m) + Factor* (dB)

*Factor includes antenna factor , cable loss and amplifier gain

Note 2: Margin (dB) = Emission level (dBuV/m) – Limit (dBuV/m).

Modulation	2.4G 11n 20 + 5G 11ac VHT20	Test Channel	CH6 + CH40
Polarization	Vertical	Test Configuration	4

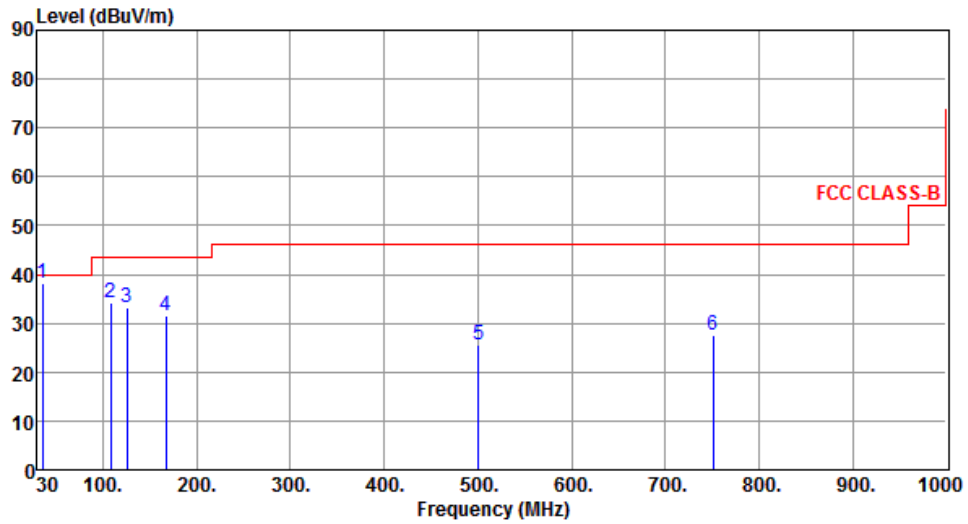

	Freq. MHz	Emission level dBuV/m	Limit dBuV/m	Margin dB	SA reading dBuV	Factor dB	Remark	ANT High cm	Turn Table deg
1	35.82	38.25	40.00	-1.75	55.49	-17.24	Peak	---	---
2	108.57	34.05	43.50	-9.45	54.29	-20.24	Peak	---	---
3	126.03	33.36	43.50	-10.14	51.88	-18.52	Peak	---	---
4	166.77	31.71	43.50	-11.79	48.62	-16.91	Peak	---	---
5	500.45	25.73	46.00	-20.27	37.14	-11.41	Peak	---	---
6	750.71	27.68	46.00	-18.32	34.74	-7.06	Peak	---	---

Note 1: Emission Level (dBuV/m) = SA Reading (dBuV/m) + Factor* (dB)

*Factor includes antenna factor , cable loss and amplifier gain

Note 2: Margin (dB) = Emission level (dBuV/m) – Limit (dBuV/m).

3.1.8 Transmitter Radiated Unwanted Emissions (Below 1GHz) (Configuration 5: Internal PIFA antenna)

Modulation	2.4G 11n 20 + 5G 11ac VHT20	Test Channel	CH6 + CH48
Polarization	Horizontal	Test Configuration	5

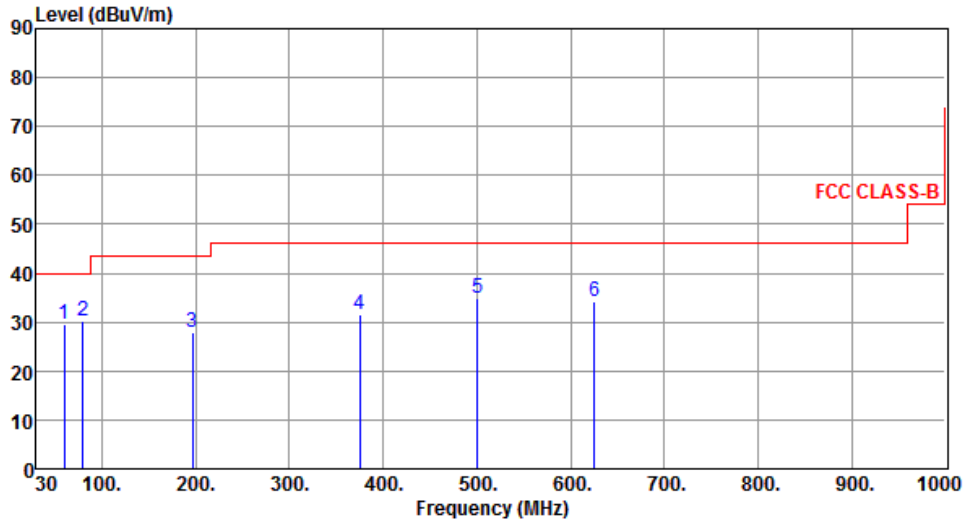

	Freq. MHz	Emission level dBuV/m	Limit dBuV/m	Margin dB	SA reading dBuV	Factor dB	Remark	ANT High cm	Turn Table deg
1	59.43	29.62	40.00	-10.38	46.73	-17.11	Peak	---	---
2	79.84	30.17	40.00	-9.83	51.77	-21.60	Peak	---	---
3	196.75	27.88	43.50	-15.62	47.52	-19.64	Peak	---	---
4	375.31	31.56	46.00	-14.44	45.90	-14.34	Peak	---	---
5	500.45	34.94	46.00	-11.06	46.48	-11.54	Peak	---	---
6	625.34	34.27	46.00	-11.73	43.46	-9.19	Peak	---	---

Note 1: Emission Level (dBuV/m) = SA Reading (dBuV/m) + Factor* (dB)

*Factor includes antenna factor , cable loss and amplifier gain

Note 2: Margin (dB) = Emission level (dBuV/m) – Limit (dBuV/m).

Modulation	2.4G 11n 20 + 5G 11ac VHT20	Test Channel	CH6 + CH48
Polarization	Vertical	Test Configuration	5

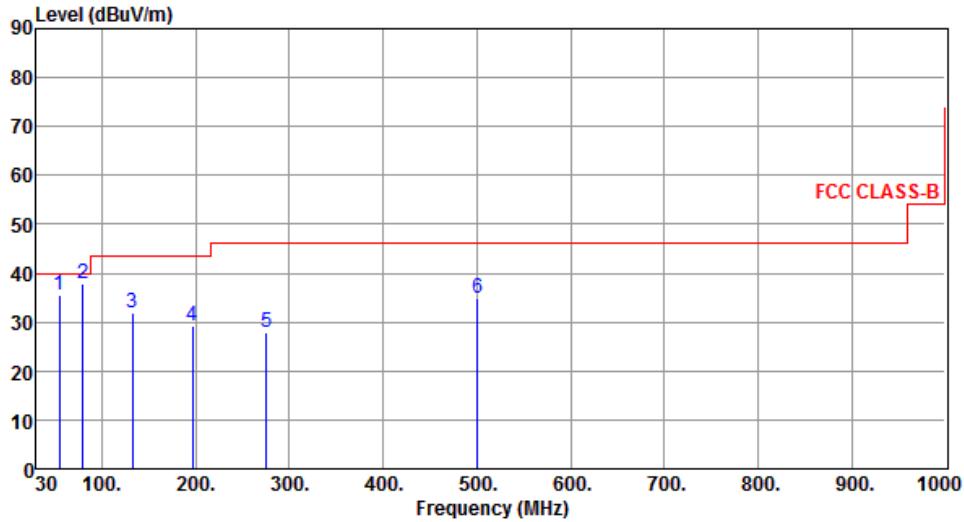

	Freq. MHz	Emission level dBuV/m	Limit dBuV/m	Margin dB	SA reading dBuV	Factor dB	Remark	ANT High cm	Turn Table deg
1	54.61	35.45	40.00	-4.55	52.27	-16.82	QP	---	---
2	79.75	37.74	40.00	-2.26	59.32	-21.58	Peak	---	---
3	132.92	32.00	43.50	-11.50	50.00	-18.00	Peak	---	---
4	196.84	29.23	43.50	-14.27	48.87	-19.64	Peak	---	---
5	275.55	27.99	46.00	-18.01	44.85	-16.86	Peak	---	---
6	500.53	34.92	46.00	-11.08	46.46	-11.54	Peak	---	---

Note 1: Emission Level (dBuV/m) = SA Reading (dBuV/m) + Factor* (dB)

*Factor includes antenna factor , cable loss and amplifier gain

Note 2: Margin (dB) = Emission level (dBuV/m) – Limit (dBuV/m).

3.1.9 Transmitter Radiated Unwanted Emissions (Below 1GHz) (Configuration 6: External Dipole antenna)

Modulation	2.4G 11g + 5G 11a	Test Channel	CH6 + CH40
Polarization	Horizontal	Test Configuration	6

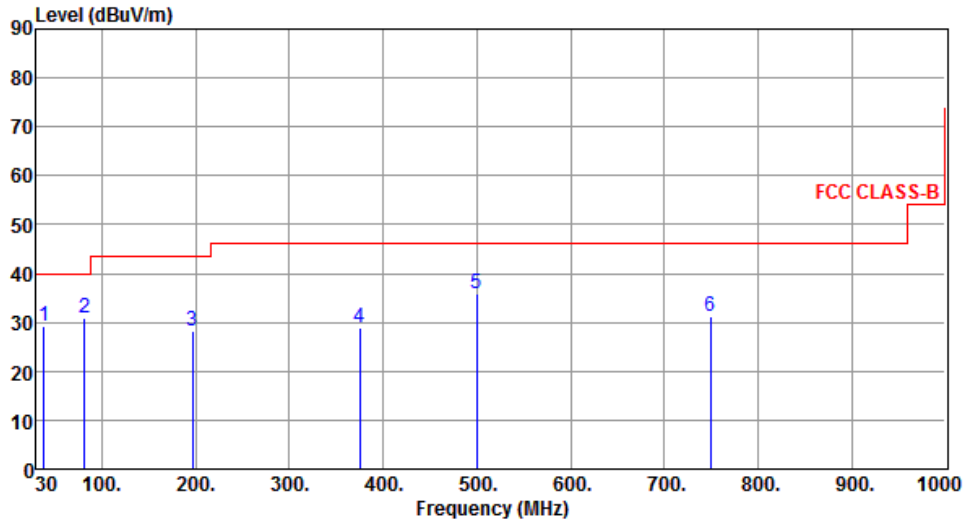

	Freq. MHz	Emission level dBuV/m	Limit dBuV/m	Margin dB	SA reading dBuV	Factor dB	Remark	ANT High cm	Turn Table deg
1	37.73	29.17	40.00	-10.83	46.39	-17.22	Peak	---	---
2	81.56	30.90	40.00	-9.10	52.75	-21.85	Peak	---	---
3	196.47	28.14	43.50	-15.36	47.77	-19.63	Peak	---	---
4	375.29	28.99	46.00	-17.01	43.33	-14.34	Peak	---	---
5	500.26	35.97	46.00	-10.03	47.52	-11.55	Peak	---	---
6	749.14	31.36	46.00	-14.64	38.61	-7.25	Peak	---	---

Note 1: Emission Level (dBuV/m) = SA Reading (dBuV/m) + Factor* (dB)

*Factor includes antenna factor , cable loss and amplifier gain

Note 2: Margin (dB) = Emission level (dBuV/m) – Limit (dBuV/m).

Modulation	2.4G 11g + 5G 11a	Test Channel	CH6 + CH40
Polarization	Vertical	Test Configuration	6

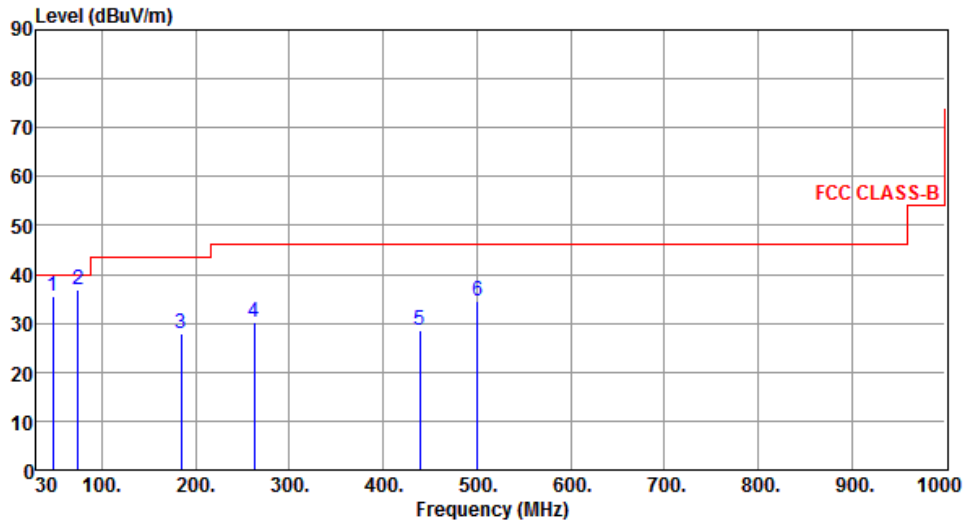

	Freq. MHz	Emission level dBuV/m	Limit dBuV/m	Margin dB	SA reading dBuV	Factor dB	Remark	ANT High cm	Turn Table deg
1	47.58	35.55	40.00	-4.45	52.20	-16.65	Peak	---	---
2	74.54	36.89	40.00	-3.11	57.34	-20.45	Peak	---	---
3	184.58	27.93	43.50	-15.57	46.94	-19.01	Peak	---	---
4	262.75	30.37	46.00	-15.63	47.84	-17.47	Peak	---	---
5	439.18	28.69	46.00	-17.31	41.46	-12.77	Peak	---	---
6	500.37	34.58	46.00	-11.42	46.12	-11.54	Peak	---	---

Note 1: Emission Level (dBuV/m) = SA Reading (dBuV/m) + Factor* (dB)

*Factor includes antenna factor , cable loss and amplifier gain

Note 2: Margin (dB) = Emission level (dBuV/m) – Limit (dBuV/m).

3.1.10 Transmitter Radiated Unwanted Emissions (Below 1GHz) (Configuration 7: External Directional Panel antenna (model WS-AI-DQ04360))

Modulation	2.4G 11g + 5G 11ac VHT20	Test Channel	CH6 + CH40
Polarization	Horizontal	Test Configuration	7

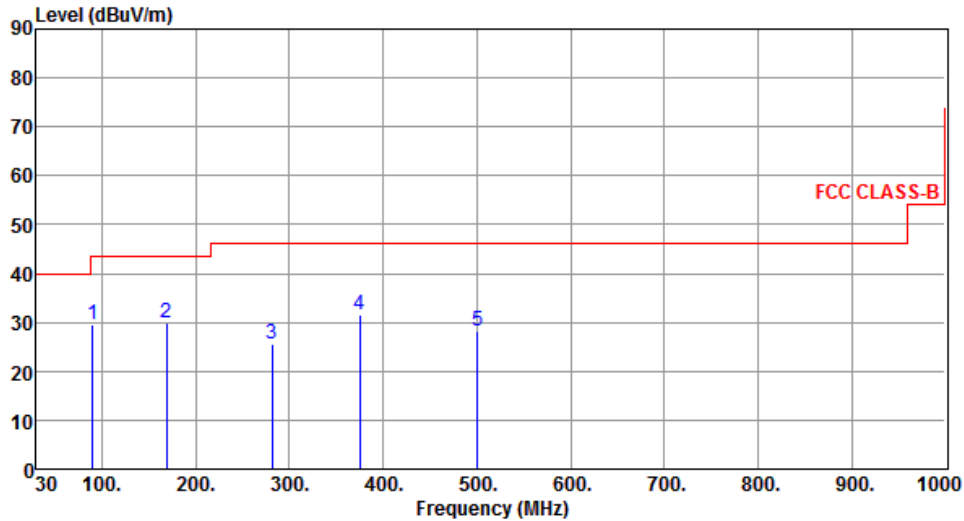

	Freq. MHz	Emission level dBuV/m	Limit dBuV/m	Margin dB	SA reading dBuV	Factor dB	Remark	ANT High cm	Turn Table deg
1	90.14	29.70	43.50	-13.80	52.65	-22.95	Peak	---	---
2	168.71	29.84	43.50	-13.66	46.78	-16.94	Peak	---	---
3	281.23	25.60	46.00	-20.40	42.03	-16.43	Peak	---	---
4	375.32	31.67	46.00	-14.33	45.90	-14.23	Peak	---	---
5	500.45	28.12	46.00	-17.88	39.53	-11.41	Peak	---	---

Note 1: Emission Level (dBuV/m) = SA Reading (dBuV/m) + Factor* (dB)

*Factor includes antenna factor , cable loss and amplifier gain

Note 2: Margin (dB) = Emission level (dBuV/m) – Limit (dBuV/m).

Modulation	2.4G 11g + 5G 11ac VHT20	Test Channel	CH6 + CH40
Polarization	Vertical	Test Configuration	7

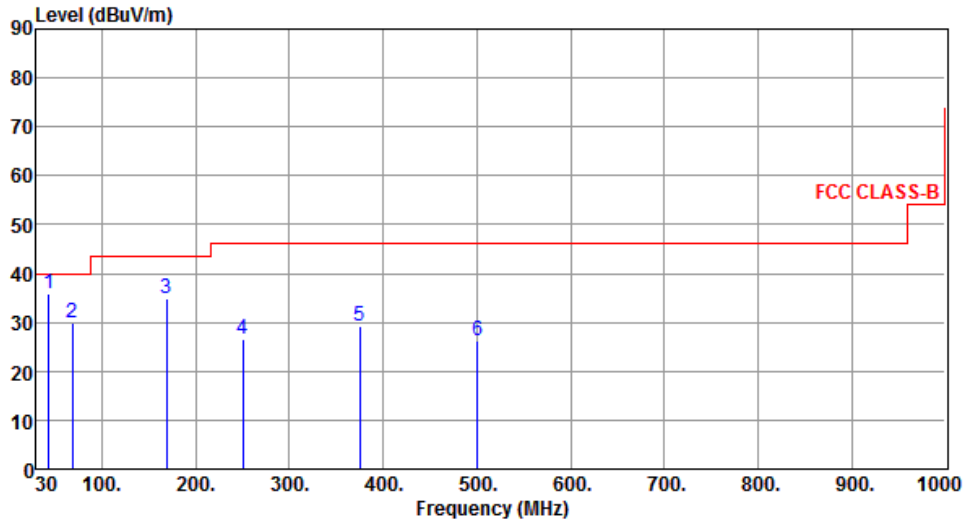

	Freq. MHz	Emission level dBuV/m	Limit dBuV/m	Margin dB	SA reading dBuV	Factor dB	Remark	ANT High cm	Turn Table deg
1	43.58	36.02	40.00	-3.98	52.66	-16.64	Peak	---	---
2	68.80	29.80	40.00	-10.20	48.87	-19.07	Peak	---	---
3	168.71	34.83	43.50	-8.67	51.77	-16.94	Peak	---	---
4	250.19	26.53	46.00	-19.47	44.27	-17.74	Peak	---	---
5	375.32	29.36	46.00	-16.64	43.59	-14.23	Peak	---	---
6	500.45	26.30	46.00	-19.70	37.71	-11.41	Peak	---	---

Note 1: Emission Level (dBuV/m) = SA Reading (dBuV/m) + Factor* (dB)

*Factor includes antenna factor , cable loss and amplifier gain

Note 2: Margin (dB) = Emission level (dBuV/m) – Limit (dBuV/m).

3.1.11 Transmitter Radiated Unwanted Emissions (Below 1GHz) (Configuration 8: External Directional Panel antenna (model WS-AI-DD05120))

Modulation	2.4G 11n 20 + 5G 11ac VHT20	Test Channel	CH6 + CH40
Polarization	Horizontal	Test Configuration	8

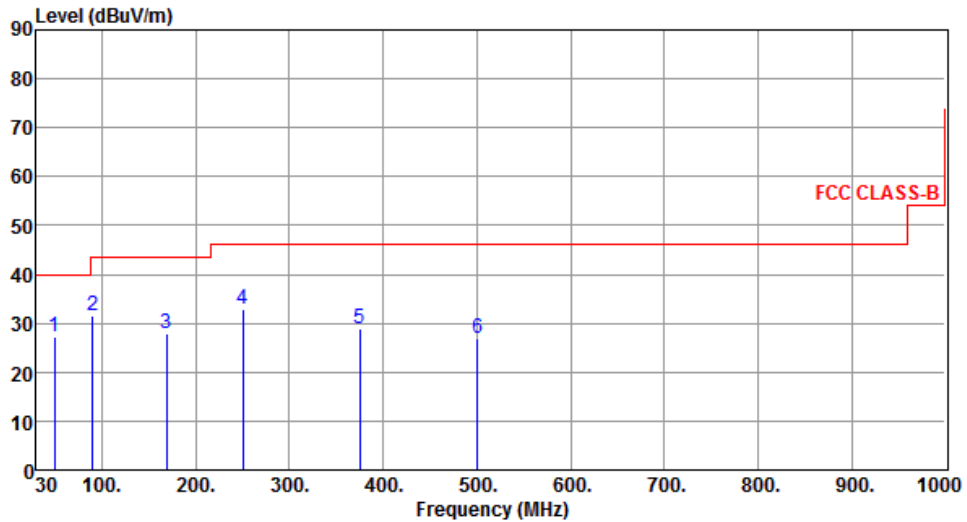

	Freq. MHz	Emission level dBuV/m	Limit dBuV/m	Margin dB	SA reading dBuV	Factor dB	Remark	ANT High cm	Turn Table deg
1	49.40	27.21	40.00	-12.79	43.61	-16.40	Peak	---	---
2	90.14	31.43	43.50	-12.07	54.38	-22.95	Peak	---	---
3	168.71	27.85	43.50	-15.65	44.79	-16.94	Peak	---	---
4	250.19	32.95	46.00	-13.05	50.69	-17.74	Peak	---	---
5	375.32	28.86	46.00	-17.14	43.09	-14.23	Peak	---	---
6	500.45	26.84	46.00	-19.16	38.25	-11.41	Peak	---	---

Note 1: Emission Level (dBuV/m) = SA Reading (dBuV/m) + Factor* (dB)

*Factor includes antenna factor , cable loss and amplifier gain

Note 2: Margin (dB) = Emission level (dBuV/m) – Limit (dBuV/m).

Modulation	2.4G 11n 20 + 5G 11ac VHT20	Test Channel	CH6 + CH40
Polarization	Vertical	Test Configuration	8

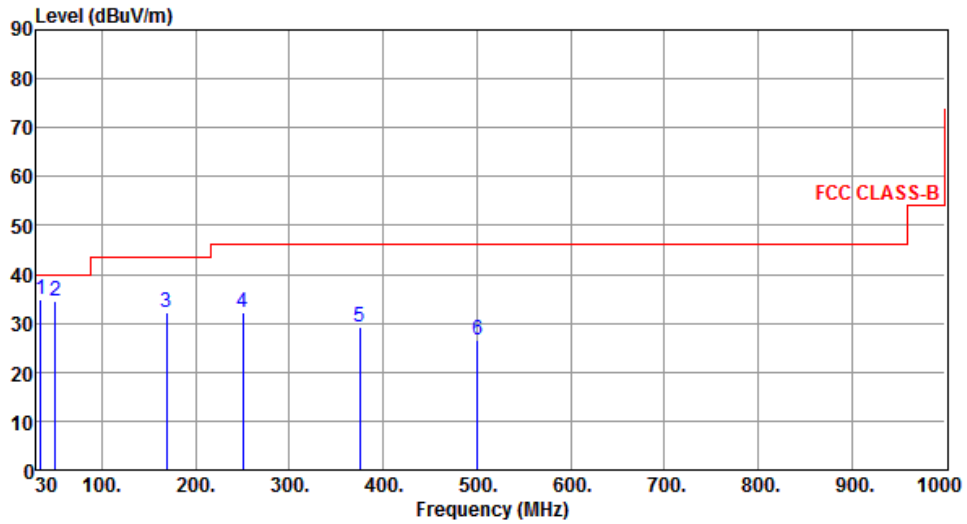

	Freq. MHz	Emission level dBuV/m	Limit dBuV/m	Margin dB	SA reading dBuV	Factor dB	Remark	ANT High cm	Turn Table deg
1	34.85	34.73	40.00	-5.27	52.06	-17.33	Peak	---	---
2	50.37	34.49	40.00	-5.51	50.90	-16.41	Peak	---	---
3	168.71	32.17	43.50	-11.33	49.11	-16.94	Peak	---	---
4	250.19	32.28	46.00	-13.72	50.02	-17.74	Peak	---	---
5	375.32	29.22	46.00	-16.78	43.45	-14.23	Peak	---	---
6	500.45	26.47	46.00	-19.53	37.88	-11.41	Peak	---	---

Note 1: Emission Level (dBuV/m) = SA Reading (dBuV/m) + Factor* (dB)

*Factor includes antenna factor , cable loss and amplifier gain

Note 2: Margin (dB) = Emission level (dBuV/m) – Limit (dBuV/m).

3.1.12 Transmitter Radiated Unwanted Emissions (Above 1GHz) (Configuration 1: Internal PIFA antenna)

Modulation	2.4G 11n 20 + 5G 11ac VHT20	Test Channel	CH6 + CH48
Polarization	Horizontal	Test Configuration	1

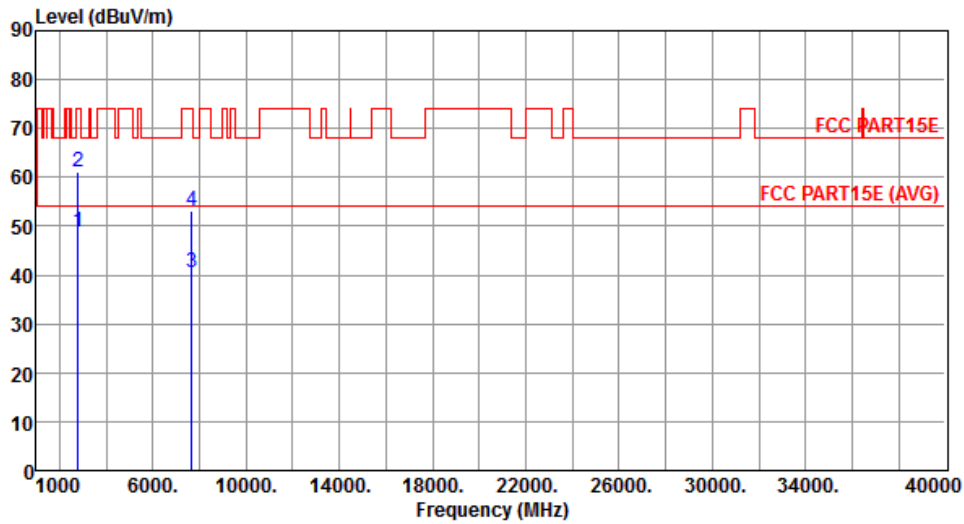

	Freq. MHz	Emission level dBuV/m	Limit dBuV/m	Margin dB	SA reading dBuV	Factor dB	Remark	ANT High cm	Turn Table deg
1	2803.00	48.75	54.00	-5.25	50.85	-2.10	Average	---	---
2	2803.00	61.16	74.00	-12.84	63.26	-2.10	Peak	---	---
3	7677.00	40.55	54.00	-13.45	30.31	10.24	Average	---	---
4	7677.00	53.01	74.00	-20.99	42.77	10.24	Peak	---	---

Note 1: Emission Level (dBuV/m) = SA Reading (dBuV/m) + Factor* (dB)

*Factor includes antenna factor, cable loss and amplifier gain

Note 2: Margin (dB) = Emission level (dBuV/m) – Limit (dBuV/m).

Modulation	2.4G 11n 20 + 5G 11ac VHT20	Test Channel	CH6 + CH48
Polarization	Vertical	Test Configuration	1

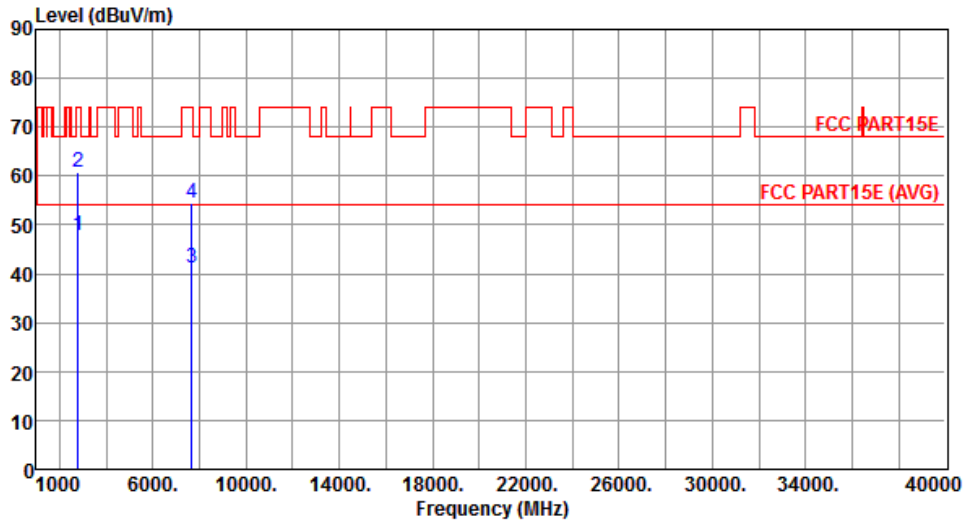

	Freq. MHz	Emission level dBuV/m	Limit dBuV/m	Margin dB	SA reading dBuV	Factor dB	Remark	ANT High cm	Turn Table deg
1	2803.00	47.92	54.00	-6.08	50.02	-2.10	Average	---	---
2	2803.00	60.67	74.00	-13.33	62.77	-2.10	Peak	---	---
3	7677.00	41.18	54.00	-12.82	30.94	10.24	Average	---	---
4	7677.00	54.48	74.00	-19.52	44.24	10.24	Peak	---	---

Note 1: Emission Level (dBuV/m) = SA Reading (dBuV/m) + Factor* (dB)

*Factor includes antenna factor , cable loss and amplifier gain

Note 2: Margin (dB) = Emission level (dBuV/m) – Limit (dBuV/m).

3.1.13 Transmitter Radiated Unwanted Emissions (Above 1GHz) (Configuration 2: External Dipole antenna)

Modulation	2.4G 11g + 5G 11a	Test Channel	CH6 + CH40
Polarization	Horizontal	Test Configuration	2

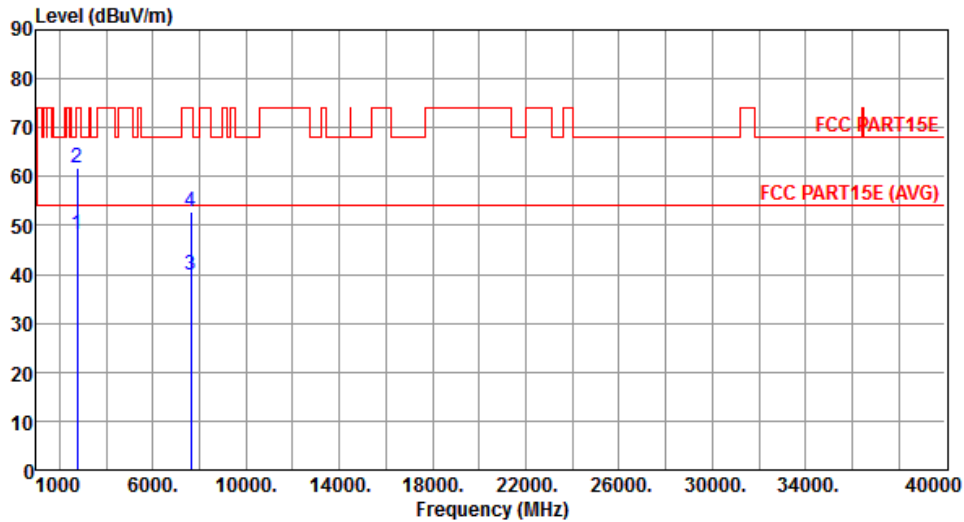

	Freq. MHz	Emission level dBuV/m	Limit dBuV/m	Margin dB	SA reading dBuV	Factor dB	Remark	ANT High cm	Turn Table deg
1	2763.00	48.28	54.00	-5.72	50.53	-2.25	Average	---	---
2	2763.00	61.65	74.00	-12.35	63.90	-2.25	Peak	---	---
3	7637.00	39.75	54.00	-14.25	29.47	10.28	Average	---	---
4	7637.00	52.79	74.00	-21.21	42.51	10.28	Peak	---	---

Note 1: Emission Level (dBuV/m) = SA Reading (dBuV/m) + Factor* (dB)

*Factor includes antenna factor , cable loss and amplifier gain

Note 2: Margin (dB) = Emission level (dBuV/m) – Limit (dBuV/m).

Modulation	2.4G 11g + 5G 11a	Test Channel	CH6 + CH40
Polarization	Vertical	Test Configuration	2

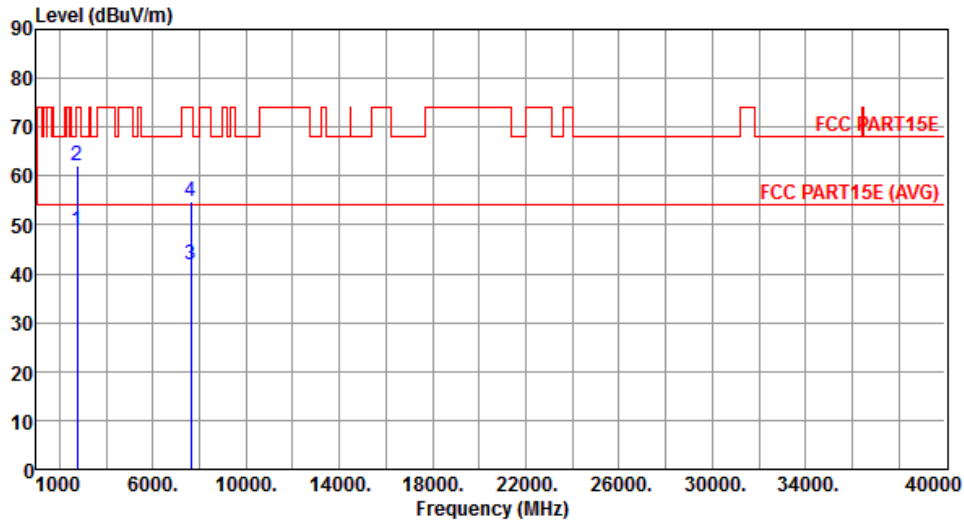

	Freq. MHz	Emission level dBuV/m	Limit dBuV/m	Margin dB	SA reading dBuV	Factor dB	Remark	ANT High cm	Turn Table deg
1	2763.00	48.72	54.00	-5.28	50.97	-2.25	Average	---	---
2	2763.00	62.02	74.00	-11.98	64.27	-2.25	Peak	---	---
3	7637.00	41.77	54.00	-12.23	31.49	10.28	Average	---	---
4	7637.00	54.79	74.00	-19.21	44.51	10.28	Peak	---	---

Note 1: Emission Level (dBuV/m) = SA Reading (dBuV/m) + Factor* (dB)

*Factor includes antenna factor , cable loss and amplifier gain

Note 2: Margin (dB) = Emission level (dBuV/m) – Limit (dBuV/m).

3.1.14 Transmitter Radiated Unwanted Emissions (Above 1GHz) (Configuration 3: External Directional Panel antenna (model WS-AI-DQ04360))

Modulation	2.4G 11g + 5G 11ac VHT20	Test Channel	CH6 + CH40
Polarization	Horizontal	Test Configuration	3

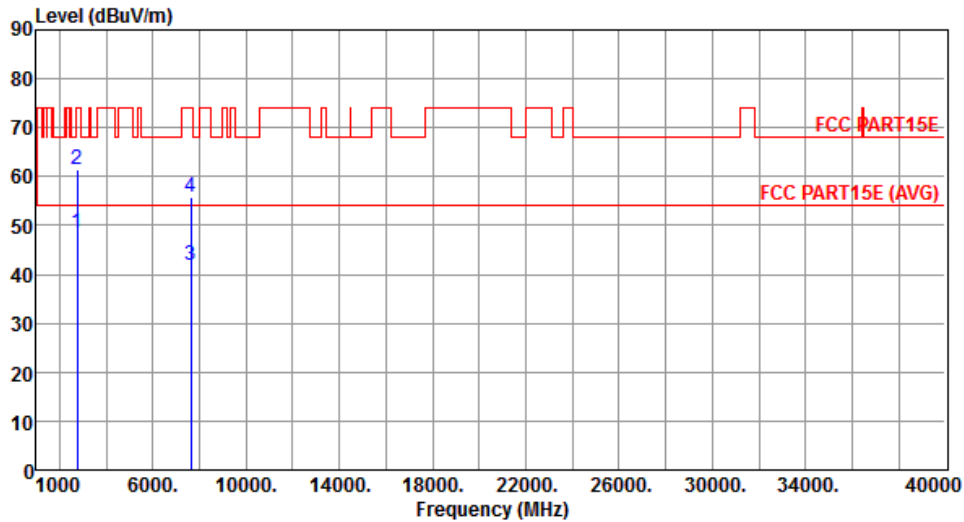

	Freq. MHz	Emission level dBuV/m	Limit dBuV/m	Margin dB	SA reading dBuV	Factor dB	Remark	ANT High cm	Turn Table deg
1	2763.00	48.38	54.00	-5.62	50.63	-2.25	Average	---	---
2	2763.00	61.51	74.00	-12.49	63.76	-2.25	Peak	---	---
3	7637.00	41.87	54.00	-12.13	31.59	10.28	Average	---	---
4	7637.00	55.92	74.00	-18.08	45.64	10.28	Peak	---	---

Note 1: Emission Level (dBuV/m) = SA Reading (dBuV/m) + Factor* (dB)

*Factor includes antenna factor , cable loss and amplifier gain

Note 2: Margin (dB) = Emission level (dBuV/m) – Limit (dBuV/m).

Modulation	2.4G 11g + 5G 11ac VHT20	Test Channel	CH6 + CH40
Polarization	Vertical	Test Configuration	3

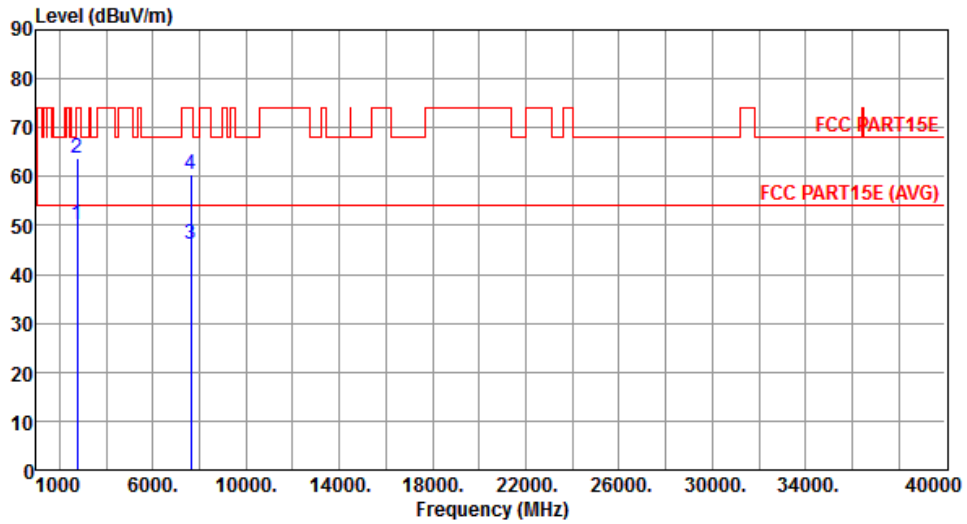

	Freq. MHz	Emission level dBuV/m	Limit dBuV/m	Margin dB	SA reading dBuV	Factor dB	Remark	ANT High cm	Turn Table deg
1	2763.00	50.15	54.00	-3.85	52.40	-2.25	Average	---	---
2	2763.00	63.85	74.00	-10.15	66.10	-2.25	Peak	---	---
3	7637.00	46.31	54.00	-7.69	36.03	10.28	Average	---	---
4	7637.00	60.39	74.00	-13.61	50.11	10.28	Peak	---	---

Note 1: Emission Level (dBuV/m) = SA Reading (dBuV/m) + Factor* (dB)

*Factor includes antenna factor , cable loss and amplifier gain

Note 2: Margin (dB) = Emission level (dBuV/m) – Limit (dBuV/m).

3.1.15 Transmitter Radiated Unwanted Emissions (Above 1GHz) (Configuration 4: External Directional Panel antenna (model WS-AI-DD05120))

Modulation	2.4G 11n 20 + 5G 11ac VHT20	Test Channel	CH6 + CH40
Polarization	Horizontal	Test Configuration	4

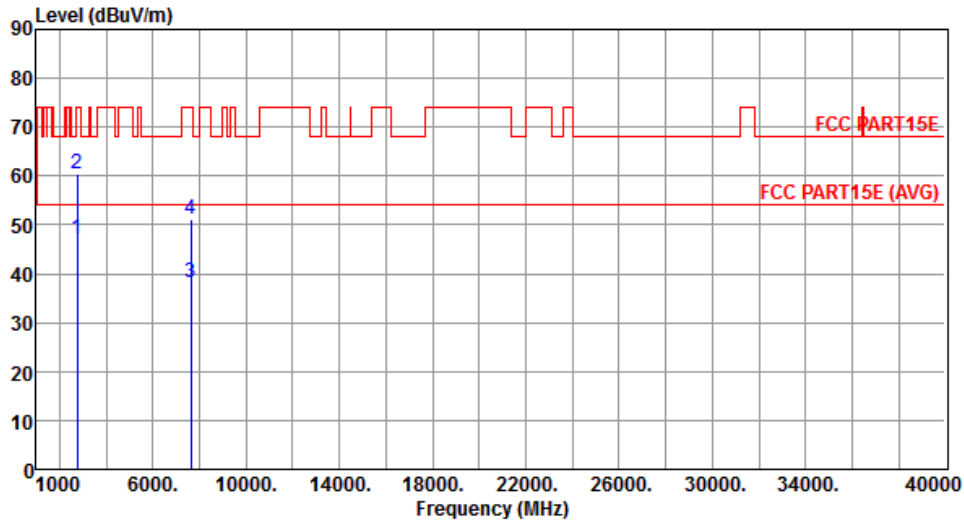

	Freq. MHz	Emission level dBuV/m	Limit dBuV/m	Margin dB	SA reading dBuV	Factor dB	Remark	ANT High cm	Turn Table deg
1	2763.00	47.17	54.00	-6.83	49.42	-2.25	Average	---	---
2	2763.00	60.31	74.00	-13.69	62.56	-2.25	Peak	---	---
3	7637.00	38.32	54.00	-15.68	28.04	10.28	Average	---	---
4	7637.00	51.21	74.00	-22.79	40.93	10.28	Peak	---	---

Note 1: Emission Level (dBuV/m) = SA Reading (dBuV/m) + Factor* (dB)

*Factor includes antenna factor , cable loss and amplifier gain

Note 2: Margin (dB) = Emission level (dBuV/m) – Limit (dBuV/m).

Modulation	2.4G 11n 20 + 5G 11ac VHT20	Test Channel	CH6 + CH40
Polarization	Vertical	Test Configuration	4

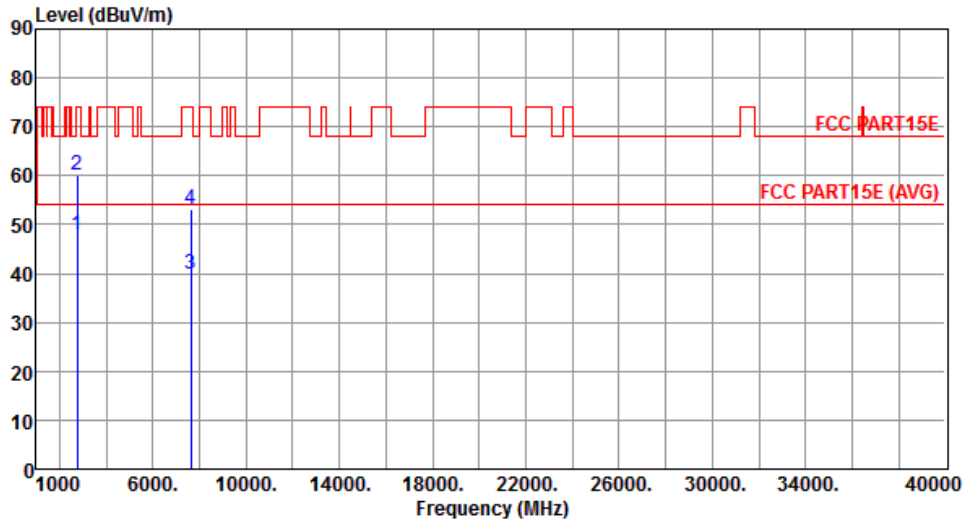

	Freq. MHz	Emission level dBuV/m	Limit dBuV/m	Margin dB	SA reading dBuV	Factor dB	Remark	ANT High cm	Turn Table deg
1	2763.00	47.85	54.00	-6.15	50.10	-2.25	Average	---	---
2	2763.00	60.21	74.00	-13.79	62.46	-2.25	Peak	---	---
3	7637.00	39.82	54.00	-14.18	29.54	10.28	Average	---	---
4	7637.00	53.14	74.00	-20.86	42.86	10.28	Peak	---	---

Note 1: Emission Level (dBuV/m) = SA Reading (dBuV/m) + Factor* (dB)

*Factor includes antenna factor , cable loss and amplifier gain

Note 2: Margin (dB) = Emission level (dBuV/m) – Limit (dBuV/m).

4 Test laboratory information

Established in 2012, ICC provides foremost EMC & RF Testing and advisory consultation services by our skilled engineers and technicians. Our services employ a wide variety of advanced edge test equipment and one of the widest certification extents in the business.

International Certification Corp, it is our definitive objective is to institute long term, trust-based associations with our clients. The expectation we set up with our clients is based on outstanding service, practical expertise and devotion to a certified value structure. Our passion is to grant our clients with best EMC / RF services by oriented knowledgeable and accommodating staff.

Our Test sites are located at Linkou District and Kwei Shan Hsiang. Location map can be found on our website <http://www.icertifi.com.tw>.

Linkou

Tel: 886-2-2601-1640

No. 30-2, Ding Fwu Tsuen, Lin Kou
District, New Taipei City, Taiwan,
R.O.C.

Kwei Shan

Tel: 886-3-271-8666

No. 3-1, Lane 6, Wen San 3rd
St., Kwei Shan Hsiang, Tao Yuan
Hsien 333, Taiwan, R.O.C.

Kwei Shan Site II

Tel: 886-3-271-8640

No. 14-1, Lane 19, Wen San 3rd
St., Kwei Shan Hsiang, Tao Yuan
Hsien 333, Taiwan, R.O.C.

If you have any suggestion, please feel free to contact us as below information

Tel: 886-3-271-8666

Fax: 886-3-318-0155

Email: ICC_Service@icertifi.com.tw

==END==