

DFS Test Report

Report No.: RF160719C17A-1

FCC ID: QXO-4018WP

Test Model: 31025, 31026

Received Date: Jul. 19, 2016

Test Date: Oct. 11 ~ Oct. 14, 2016

Issued Date: Oct. 17, 2016

Applicant: Extreme Networks, Inc.

Address: 9 Northeastern Blvd. Salem, New Hampshire, United States, 03079

Issued By: Bureau Veritas Consumer Products Services (H.K.) Ltd., Taoyuan Branch

Lab Address: No. 47-2, 14th Ling, Chia Pau Vil., Lin Kou Dist., New Taipei City, Taiwan, R.O.C.

Test Location: No. 19, Hwa Ya 2nd Rd., Wen Hwa Vil., Kwei Shan Dist., Taoyuan City 33383, TAIWAN (R.O.C.)



This report is for your exclusive use. Any copying or replication of this report to or for any other person or entity, or use of our name or trademark, is permitted only with our prior written permission. This report sets forth our findings solely with respect to the test samples identified herein. The results set forth in this report are not indicative or representative of the quality or characteristics of the lot from which a test sample was taken or any similar or identical product specifically and expressly noted. Our report includes all of the tests requested by you and the results thereof based upon the information that you provided to us. You have 60 days from date of issuance of this report to notify us of any material error or omission caused by our negligence, provided, however, that such notice shall be in writing and shall specifically address the issue you wish to raise. A failure to raise such issue within the prescribed time shall constitute your unqualified acceptance of the completeness of this report, the tests conducted and the correctness of the report contents. Unless specific mention, the uncertainty of measurement has been explicitly taken into account to declare the compliance or non-compliance to the specification. The report must not be used by the client to claim product certification, approval, or endorsement by TAF or any government agencies.

Table of Contents

Release Control Record	3
1 Certificate of Conformity	4
2 EUT Information	5
2.1 Operating Frequency Bands and Mode of EUT.....	5
2.2 EUT Software and Firmware Version.....	5
2.3 Description of Available Antennas to the EUT	5
2.4 EUT Maximum Conducted Power.....	6
2.5 EUT Maximum E.I.R.P. Power	8
2.6 Transmit Power Control (TPC).....	9
2.7 Statement of Manufacturer.....	9
3 U-NII DFS Rule Requirements	10
3.1 Working Modes and Required Test Items	10
3.2 Test Limits and Radar Signal Parameters.....	11
4 Test & Support Equipment List	14
4.1 Test Instruments.....	14
4.2 Description of Support Units	14
5 Test Procedure	15
5.1 ADT DFS Measurement System.....	15
5.2 Calibration of DFS Detection Threshold Level.....	16
5.3 Deviation from Test Standard.....	16
5.4 Radiated Test Setup Configuration	17
5.4.1 Master Mode.....	17
6 Test Results	18
6.1 Summary of Test Results	18
6.2 Test Results.....	19
6.2.1 Test Mode: Device Operating In Client without Radar Detection Mode.....	19
6.2.2 U-NII Detection Bandwidth	24
6.1.1 Channel Availability Check Time	30
6.1.2 Channel Closing Transmission and Channel Move Time.....	32
6.2.3 Non-Occupancy Period	41
6.2.4 Uniform Spreading.....	45
6.2.5 Transmit power control (TPC)	45
7 Information on the Testing Laboratories	46



Release Control Record

Issue No.	Description	Date Issued
RF160719C17A-1	Original release	Oct. 17, 2016

1 Certificate of Conformity

Product: Wireless 802.11 abgn/ac Router

Brand: Extreme Networks

Test Model: 31025, 31026

Sample Status: Engineering Sample

Applicant: Extreme Networks, Inc.

Test Date: Oct. 11 ~ Oct. 14, 2016

Standards: FCC Part 15, Subpart E (Section 15.407)

KDB 905462 D02 UNII DFS Compliance Procedures New Rules v02

The above equipment has been tested by **Bureau Veritas Consumer Products Services (H.K.) Ltd., Taoyuan Branch**, and found compliance with the requirement of the above standards. The test record, data evaluation & Equipment Under Test (EUT) configurations represented herein are true and accurate accounts of the measurements of the sample's EMC characteristics under the conditions specified in this report.

Prepared by : , **Date:** Oct. 17, 2016
Polly Chien / Specialist

Approved by : , **Date:** Oct. 17, 2016
Ken Liu / Senior Manager

2 EUT Information

2.1 Operating Frequency Bands and Mode of EUT

Table 1: Operating Frequency Bands and Mode of EUT

Operational Mode	Operating Frequency Range	
	5250~5350MHz	5470~5725MHz
Master	✓	✓

2.2 EUT Software and Firmware Version

Table 2: The EUT Software/Firmware Version

No.	Product	Test Model No.	Software/Firmware Version
1	Wireless 802.11 abgn/ac Router	31026	Firmware version : 10.21.01.0007T

Note: All models are listed as below. Model: 31026 is representative for final test.

Brand	Model	Difference
Extreme Networks	31026	All models are electrically identical, different model names are for marketing purpose.
	31025	

Equipment	EUT	Description	Model
Wireless 802.11 abgn/ac Router	1	WS-AP3912i-ROW	31026
Wireless 802.11 abgn/ac Router	2	WS-AP3912i-FCC	31025

2.3 Description of Available Antennas to the EUT

Table 3: Antenna List

ANT No.	Antenna Type	Operation Frequency Range (MHz)	Gain (dBi)
1.	PIFA	5250-5725	5.72
2.	PIFA	5250-5725	5.99

2.4 EUT Maximum Conducted Power

Table 4: The Measured Conducted Output Power

CDD Mode

802.11a

Frequency Band (MHz)	Max. Power	
	Output Power (dBm)	Output Power (mW)
5250~5350	19.91	97.962
5470~5725	19.52	89.629

802.11n HT20

Frequency Band (MHz)	Max. Power	
	Output Power (dBm)	Output Power (mW)
5250~5350	20.82	120.791
5470~5725	20.73	118.313

802.11n HT40

Frequency Band (MHz)	Max. Power	
	Output Power (dBm)	Output Power (mW)
5250~5350	22.97	197.976
5470~5725	22.51	178.111

802.11ac VHT80

Frequency Band (MHz)	Max. Power	
	Output Power (dBm)	Output Power (mW)
5250~5350	17.34	54.143
5470~5725	21.72	148.660

Beamforming Mode

802.11n HT20

Frequency Band (MHz)	Max. Power	
	Output Power (dBm)	Output Power (mW)
5250~5350	20.84	121.430
5470~5725	20.92	123.636

802.11n HT40

Frequency Band (MHz)	Max. Power	
	Output Power (dBm)	Output Power (mW)
5250~5350	18.93	78.139
5470~5725	20.73	118.261

802.11ac VHT80

Frequency Band (MHz)	Max. Power	
	Output Power (dBm)	Output Power (mW)
5250~5350	16.66	46.332
5470~5725	20.69	117.200

2.5 EUT Maximum E.I.R.P. Power

Table 5: The EIRP Output Power List

CDD Mode

802.11a

Frequency Band (MHz)	Max. Power	
	Output Power (dBm)	Output Power (mW)
5250~5350	25.90	389.097
5470~5725	25.51	355.999

802.11n HT20

Frequency Band (MHz)	Max. Power	
	Output Power (dBm)	Output Power (mW)
5250~5350	26.81	479.772
5470~5725	26.72	469.929

802.11n HT40

Frequency Band (MHz)	Max. Power	
	Output Power (dBm)	Output Power (mW)
5250~5350	28.96	786.344
5470~5725	28.50	707.442

802.11ac VHT80

Frequency Band (MHz)	Max. Power	
	Output Power (dBm)	Output Power (mW)
5250~5350	22.65	184.077
5470~5725	27.71	590.201

Beamforming Mode

802.11n HT20

Frequency Band (MHz)	Max. Power	
	Output Power (dBm)	Output Power (mW)
5250~5350	26.83	481.948
5470~5725	26.91	490.908

802.11n HT40

Frequency Band (MHz)	Max. Power	
	Output Power (dBm)	Output Power (mW)
5250~5350	24.92	310.456
5470~5725	26.72	469.894

802.11ac VHT80

Frequency Band (MHz)	Max. Power	
	Output Power (dBm)	Output Power (mW)
5250~5350	22.65	184.077
5470~5725	26.68	465.586

2.6 Transmit Power Control (TPC)

U-NII devices operating in the 5.25-5.35 GHz band and the 5.47-5.725 GHz band shall employ a TPC mechanism. The U-NII device is required to have the capability to operate at least 6 dB below the mean EIRP value of 30 dBm. A TPC mechanism is not required for systems with an e.i.r.p. of less than 500 mW.

Maximum EIRP of this device is 786.344mW which more than 500mW, therefore it's require TPC function.

The UUT can adjust a transmitter's output power based on the signal level present at the receiver. TPC is auto controlled by software

2.7 Statement of Manufacturer

Manufacturer statement confirming that information regarding the parameters of the detected Radar Waveforms is not available to the end user.

3 U-NII DFS Rule Requirements

3.1 Working Modes and Required Test Items

The manufacturer shall state whether the UUT is capable of operating as a Master and/or a Client. If the UUT is capable of operating in more than one operating mode then each operating mode shall be tested separately. See tables 6 and 7 for the applicability of DFS requirements for each of the operational modes.

Table 6: Applicability of DFS Requirements Prior To Use a Channel

Requirement	Operational Mode		
	Master	Client without radar detection	Client with radar detection
Non-Occupancy Period	✓	✓ note	✓
DFS Detection Threshold	✓	Not required	✓
Channel Availability Check Time	✓	Not required	Not required
U-NII Detection Bandwidth	✓	Not required	✓

Note: Regarding KDB 905462 D03 Client Without DFS New Rules v01r01 section (b)(5/6), If the client moves with the master, the device is considered compliant if nothing appears in the client non-occupancy period test. For devices that shut down (rather than moving channels), no beacons should appear. An analyzer plot that contains a single 30-minute sweep on the original channel.

Table 7: Applicability of DFS Requirements during Normal Operation.

Requirement	Operational Mode	
	Master or Client with radar detection	Client without radar detection
DFS Detection Threshold	✓	Not required
Channel Closing Transmission Time	✓	✓
Channel Move Time	✓	✓
U-NII Detection Bandwidth	✓	Not required

Additional requirements for devices with multiple bandwidth modes	Master or Client with radar detection	Client without radar detection
U-NII Detection Bandwidth and Statistical Performance Check	All BW modes must be tested	Not required
Channel Move Time and Channel Closing Transmission Time	Test using widest BW mode available	Test using the widest BW mode available for the link
All other tests	Any single BW mode	Not required

Note: Frequencies selected for statistical performance check (Section 7.8.4) should include several frequencies within the radar detection bandwidth and frequencies near the edge of the radar detection bandwidth. For 802.11 devices it is suggested to select frequencies in each of the bonded 20 MHz channels and the channel center frequency.

3.2 Test Limits and Radar Signal Parameters

Detection Threshold Values

Table 8: DFS Detection Thresholds for Master Devices And Client Devices With Radar Detection

Maximum Transmit Power	Value (See Notes 1, 2, and 3)
EIRP \geq 200 milliwatt	-64 dBm
EIRP < 200 milliwatt and power spectral density < 10 dBm/MHz	-62 dBm
EIRP < 200 milliwatt that do not meet the power spectral density requirement	-64 dBm

Note 1: This is the level at the input of the receiver assuming a 0 dBi receive antenna.

Note 2: Throughout these test procedures an additional 1 dB has been added to the amplitude of the test transmission waveforms to account for variations in measurement equipment. This will ensure that the test signal is at or above the detection threshold level to trigger a DFS response.

Note3: EIRP is based on the highest antenna gain. For MIMO devices refer to KDB Publication 662911 D01.

Table 9: DFS Response Requirement Values

Parameter	Value
Non-occupancy period	Minimum 30 minutes
Channel Availability Check Time	60 seconds
Channel Move Time	10 seconds See Note 1.
Channel Closing Transmission Time	200 milliseconds + an aggregate of 60 milliseconds over remaining 10 second period. See Notes 1 and 2.
U-NII Detection Bandwidth	Minimum 100% of the U-NII 99% transmission power bandwidth. See Note 3

Note 1: Channel Move Time and the Channel Closing Transmission Time should be performed with Radar Type 0. The measurement timing begins at the end of the Radar Type 0 burst.

Note 2: The Channel Closing Transmission Time is comprised of 200 milliseconds starting at the beginning of the Channel Move Time plus any additional intermittent control signals required to facilitate a Channel move (an aggregate of 60 milliseconds) during the remainder of the 10 second period. The aggregate duration of control signals will not count quiet periods in between transmissions.

Note 3: During the U-NII Detection Bandwidth detection test, radar type 0 should be used. For each frequency step the minimum percentage of detection is 90 percent. Measurements are performed with no data traffic.

Parameters of DFS Test Signals

Step intervals of 0.1 microsecond for Pulse Width, 1 microsecond for PRI, 1 MHz for chirp width and 1 for the number of pulses will be utilized for the random determination of specific test waveforms.

Table 10: Short Pulse Radar Test Waveforms

Radar Type	Pulse Width (μsec)	PRI (μsec)	Number of Pulses	Minimum Percentage of Successful Detection	Minimum Number of Trials
0	1	1428	18	See Note 1	See Note 1
1	1	Test A: 15 unique PRI values randomly selected from the list of 23 PRI values in Table 5a ----- Test B: 15 unique PRI values randomly selected within the range of 518-3066 μ sec, with a minimum increment of 1 μ sec, excluding PRI values selected in Test A	$\text{Roundup} \left\{ \begin{array}{l} \left(\frac{1}{360} \right) \\ \left(\frac{19 \cdot 10^6}{\text{PRI}_{\mu\text{sec}}} \right) \end{array} \right\}$	60%	30
2	1-5	150-230	23-29	60%	30
3	6-10	200-500	16-18	60%	30
4	11-20	200-500	12-16	60%	30
Aggregate (Radar Types 1-4)				80%	120
Note 1: Short Pulse Radar Type 0 should be used for the detection bandwidth test, channel move time, and channel closing time tests.					

Table 11: Long Pulse Radar Test Waveform

Radar Type	Pulse Width (μsec)	Chirp Width (MHz)	PRI (μsec)	Number Of Pulses Per Burst	Number Of Bursts	Minimum Percentage Of Successful Detection	Minimum Number Of Trials
5	50-100	5-20	1000-2000	1-3	8-20	80%	30

Three subsets of trials will be performed with a minimum of ten trials per subset. The subset of trials differ in where the Long Pulse Type 5 Signal is tuned in frequency.

- a) the Channel center frequency
- b) tuned frequencies such that 90% of the Long Pulse Type 5 frequency modulation is within the low edge of the UUT Occupied Bandwidth
- c) tuned frequencies such that 90% of the Long Pulse Type 5 frequency modulation is within the high edge of the UUT Occupied Bandwidth

It include 10 trails for every subset, the formula as below,

For subset case 1: the center frequency of the signal generator will remain fixed at the center of the UUT Channel.

For subset case 2: to retain 90% frequency overlap between the radar signal and the UUT Occupied Bandwidth, the center frequency of the signal generator will vary for each of the ten trials in subset case 2. The center frequency of the signal generator for each trial is calculated by:

$$FL+(0.4*Chirp\ Width\ [in\ MHz])$$

For subset case 3: to retain 90% frequency overlap between the radar signal and the UUT Occupied Bandwidth, the center frequency of the signal generator will vary for each of the ten trials in subset case 3. The center frequency of the signal generator for each trial is calculated by:

$$FH-(0.4*Chirp\ Width\ [in\ MHz])$$

Table 12: Frequency Hopping Radar Test Waveform

Radar Type	Pulse Width (μsec)	PRI (μsec)	Pulses PER HOP	Hopping Rate (kHz)	Hopping Sequence Length (msec)	Minimum Percentage Of Successful Detection	Minimum Number Of Trials
6	1	333	9	0.333	300	70%	30

4 Test & Support Equipment List

4.1 Test Instruments

Table 13: Test Instruments List

Description & Manufacturer	Model No.	Brand	Date Of Calibration	Due Date Of Calibration
R&S Spectrum analyzer	ESR	R&S	2016/02/02	2017/02/01
Signal generator	8645A	Agilent	2016/08/06	2017/08/05

4.2 Description of Support Units

Table 14: Support Unit Information.

No.	Product	Brand	Model No.	FCC ID
1	Wireless-AC Mini USB Adapter	LINKSYS	AE6000	Q87-AE6000

Note: This device was functioned as a Master Slave device during the DFS test.

5 Test Procedure

5.1 ADT DFS Measurement System

A complete ADT DFS Measurement System consists of two subsystems: (1) the Radar Signal Generating Subsystem and (2) the Traffic Monitoring Subsystem. The control PC is necessary for generating the Radar waveforms in Table 10, 11 and 12. The traffic monitoring subsystem is specified to the type of unit under test (UUT).

Radiated Setup Configuration of ADT DFS Measurement System

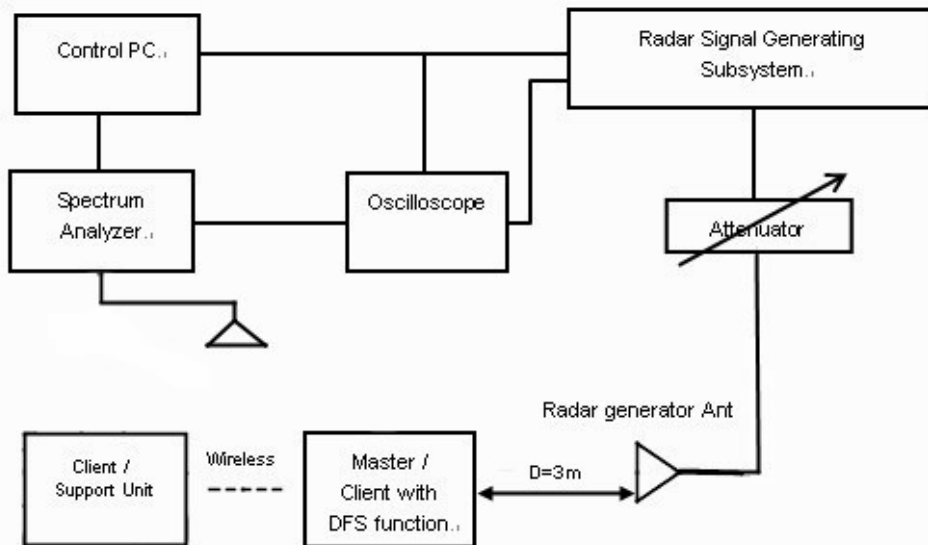

System testing will be performed with channel-loading using means appropriate to the data types that are used by the unlicensed device. The following requirements apply:

	a) The data file must be of a type that is typical for the device (i.e., MPEG-2, MPEG-4, WAV, MP3, MP4, AVI, etc.) and must generally be transmitting in a streaming mode.
	b) Software to ping the client is permitted to simulate data transfer but must have random ping intervals.
V	c) Timing plots are required with calculations demonstrating a minimum channel loading of approximately 17% or greater.
	d) Unicast or Multicast protocols are preferable but other protocols may be used. The appropriate protocol used must be described in the test procedures.

5.2 Calibration of DFS Detection Threshold Level

The measured channel is 5500MHz, 5510MHz and 5530MHz. The radar signal was the same as transmitted channels, and injected into the antenna of AP (master) or Client Device with Radar Detection, measured the channel closing transmission time and channel move time. The calibrated detection threshold level is set to -64dBm. The tested level is lower than required level hence it provides margin to the limit.

Radiated Setup Configuration of Calibration of DFS Detection Threshold Level

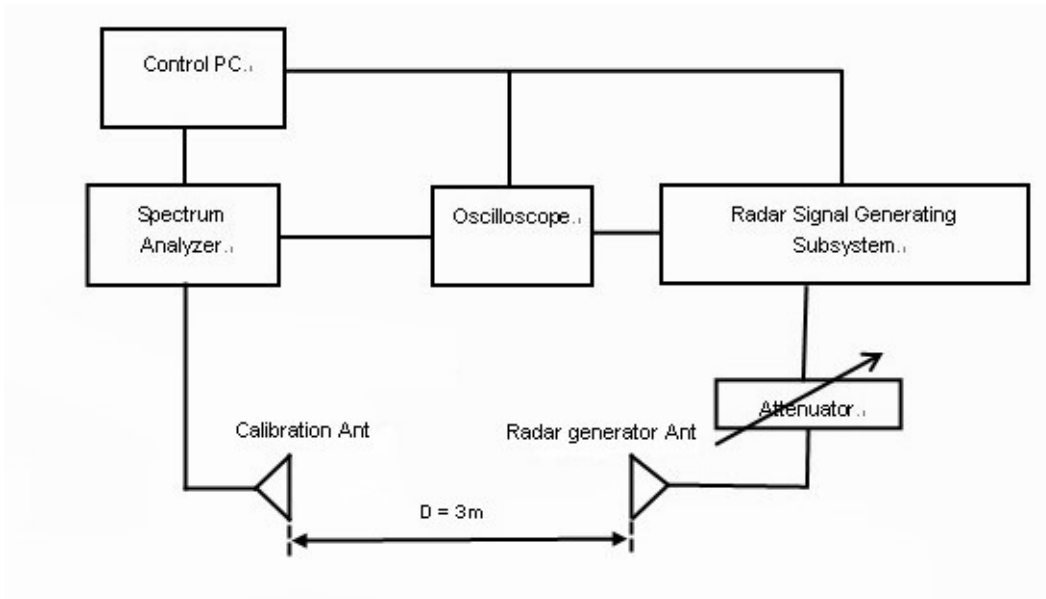

5.3 Deviation from Test Standard

No deviation.

5.4 Radiated Test Setup Configuration

5.4.1 Master Mode

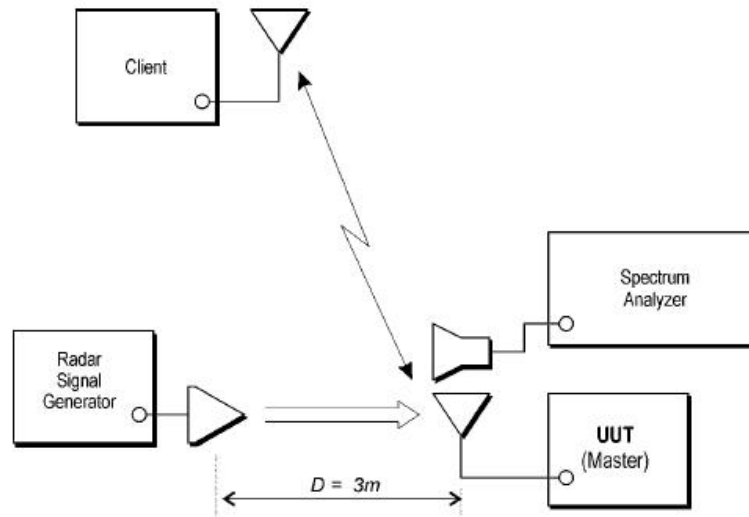

The EUT is a U-NII Device operating in Master mode. The radar test signals are injected into the Master Device.

6 Test Results

6.1 Summary of Test Results

Clause	Test Parameter	Remarks	Pass/Fail
15.407	DFS Detection Threshold	Applicable	Pass
15.407	U-NII Detection Bandwidth	Applicable	Pass
15.407	Channel Availability Check Time	Applicable	Pass
15.407	Channel Move Time	Applicable	Pass
15.407	Channel Closing Transmission Time	Applicable	Pass
15.407	Non- Occupancy Period	Applicable	Pass
15.407	Uniform Spreading	Applicable	Pass

6.2 Test Results

6.2.1 Test Mode: Device Operating In Client without Radar Detection Mode.

Master with injection at the Master. (Radar Test Waveforms are injected into the Master.)

DFS Detection Threshold

For a detection threshold level of -64dBm, the required signal strength at EUT antenna location is -64 dBm. The tested level is lower than required level hence it provides margin to the limit.

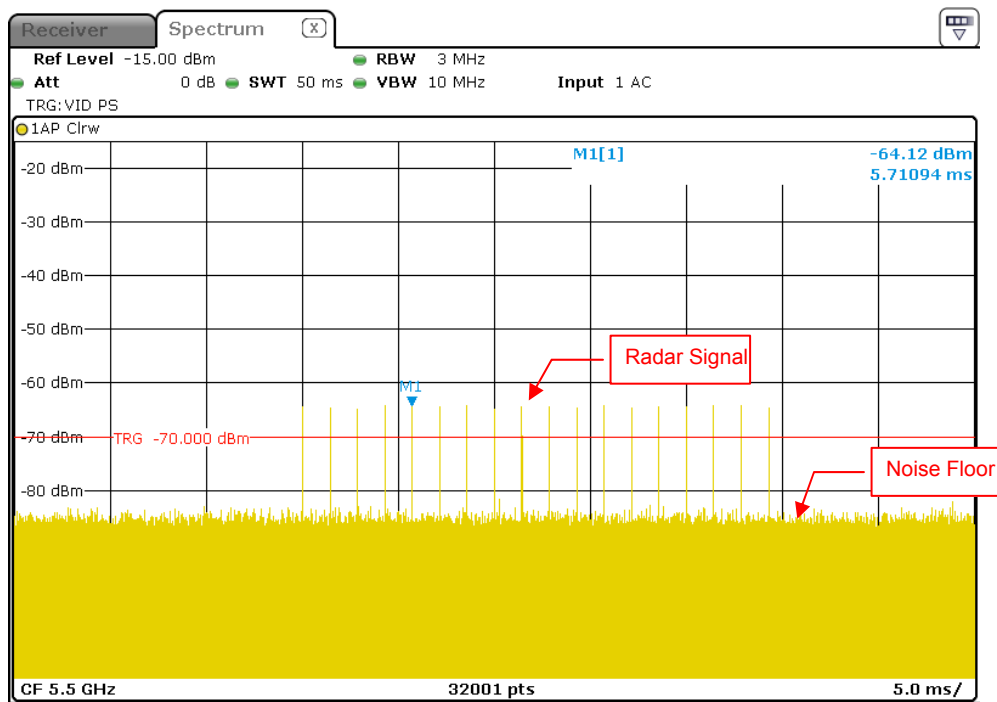

Radar Signal 0

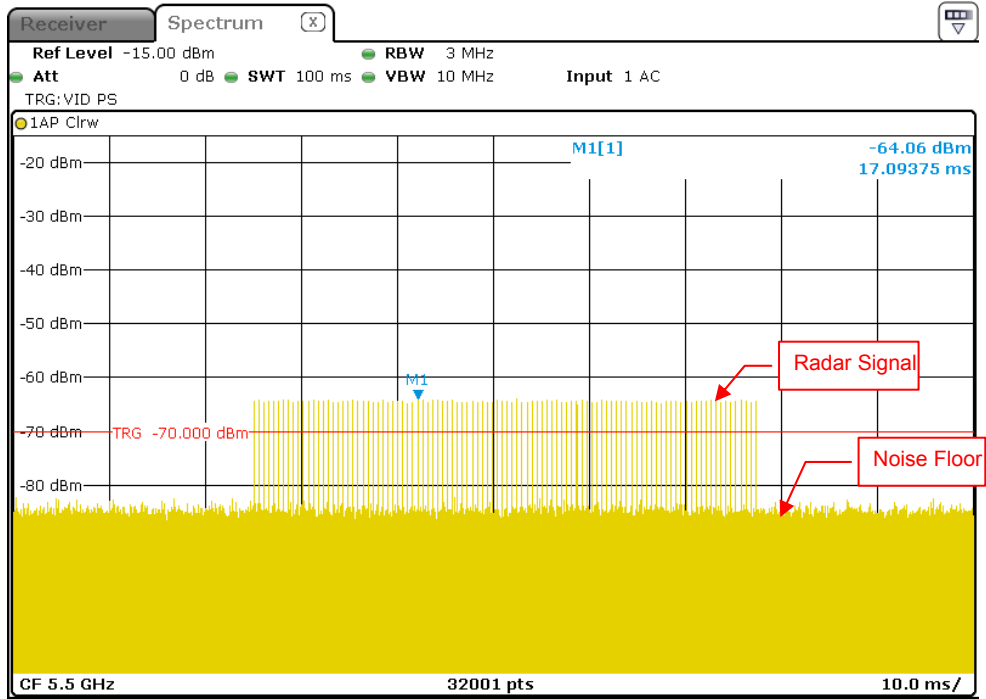

Radar Signal 1 (Test A)

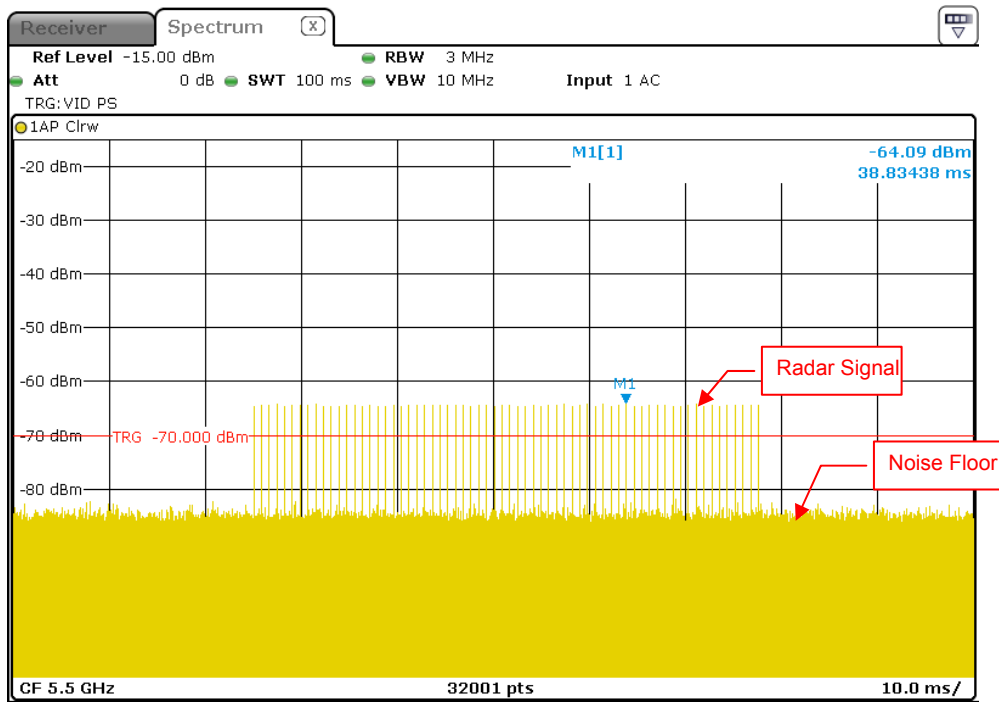

Radar Signal 1 (Test B)

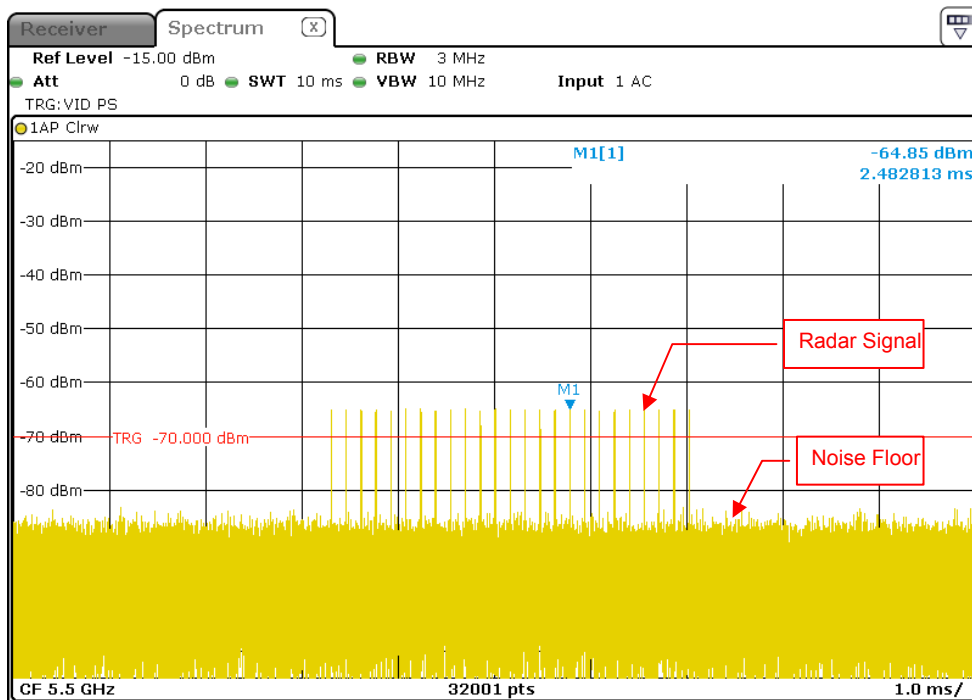

Radar Signal 2

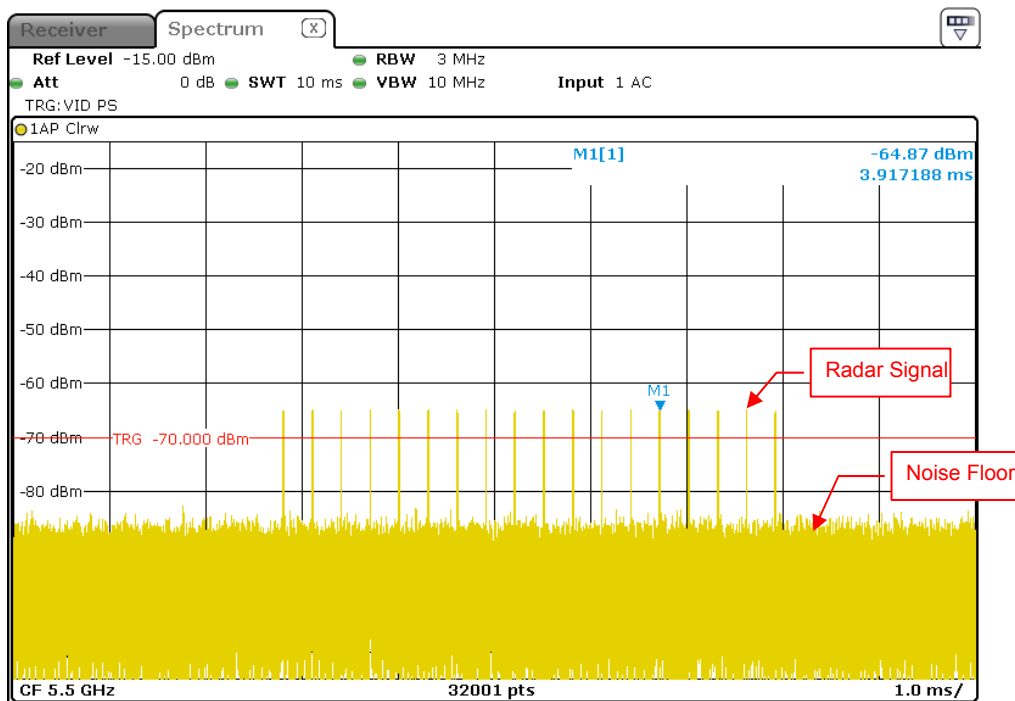

Radar Signal 3

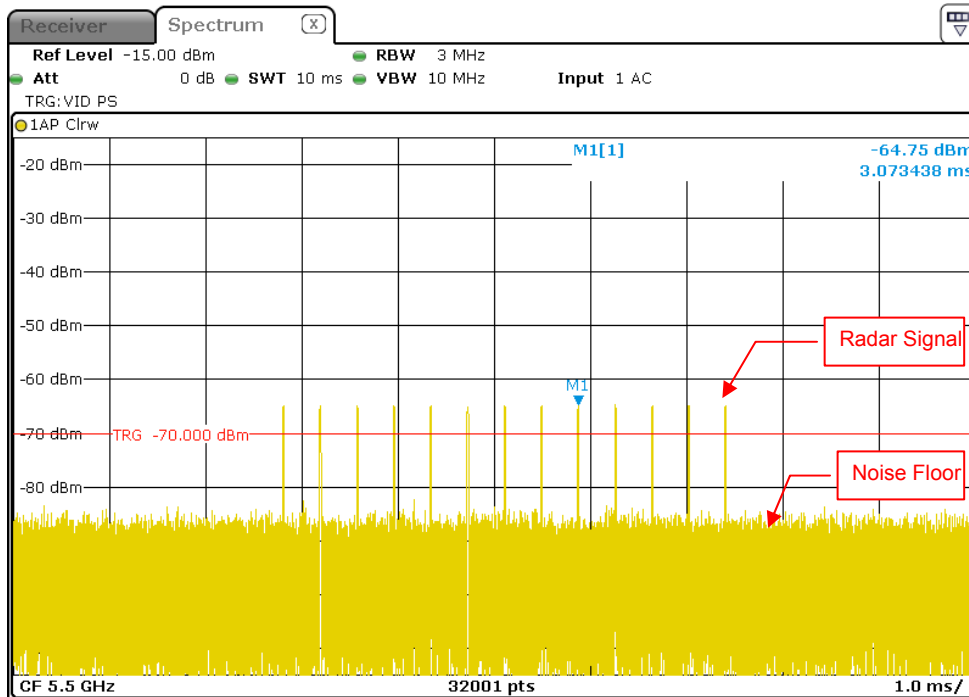

Radar Signal 4

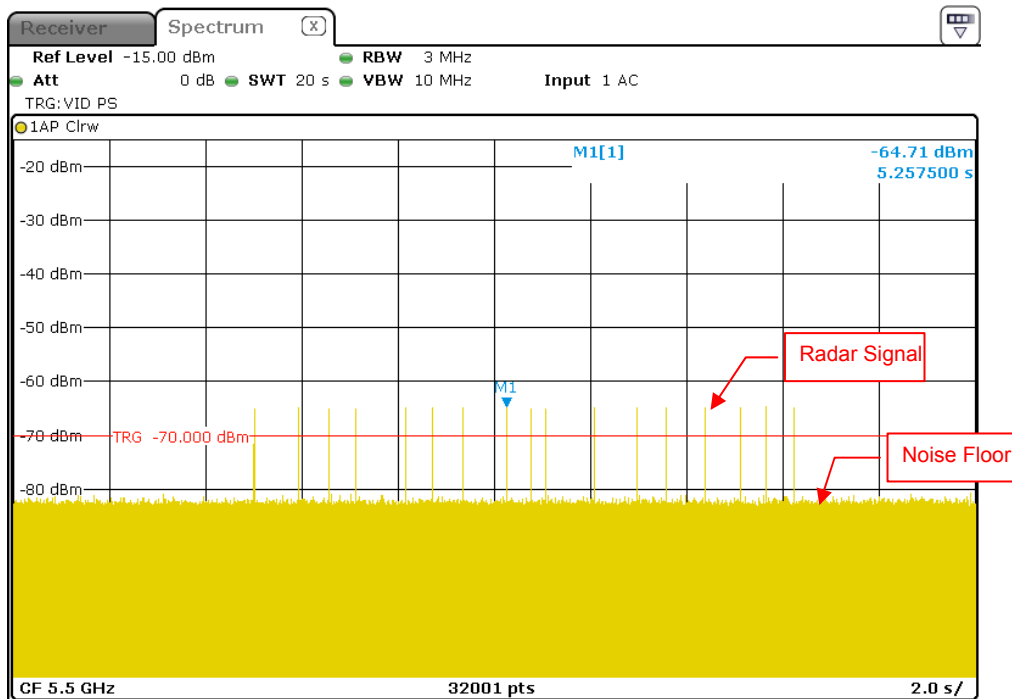

Radar Signal 5

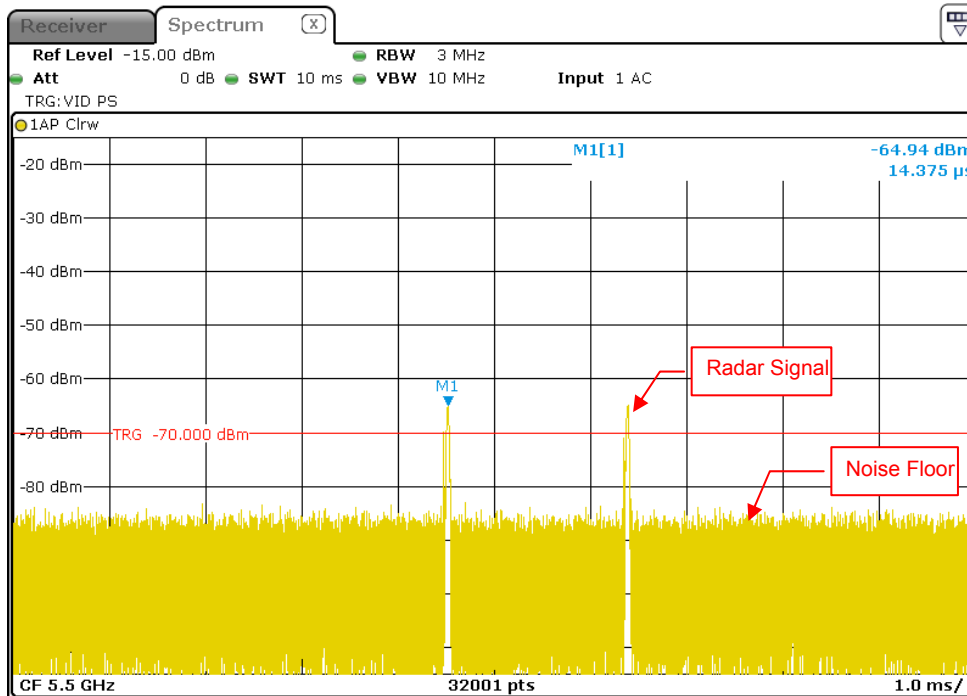

Single Burst of Radar Signal 5

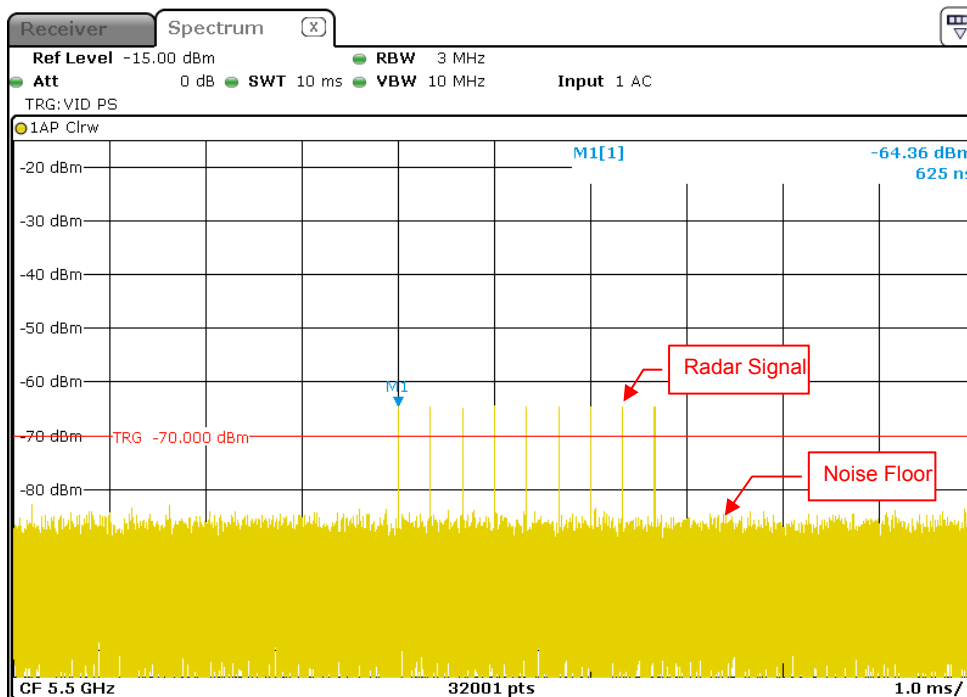

Radar Signal 6

6.2.2 U-NII Detection Bandwidth

802.11n HT20

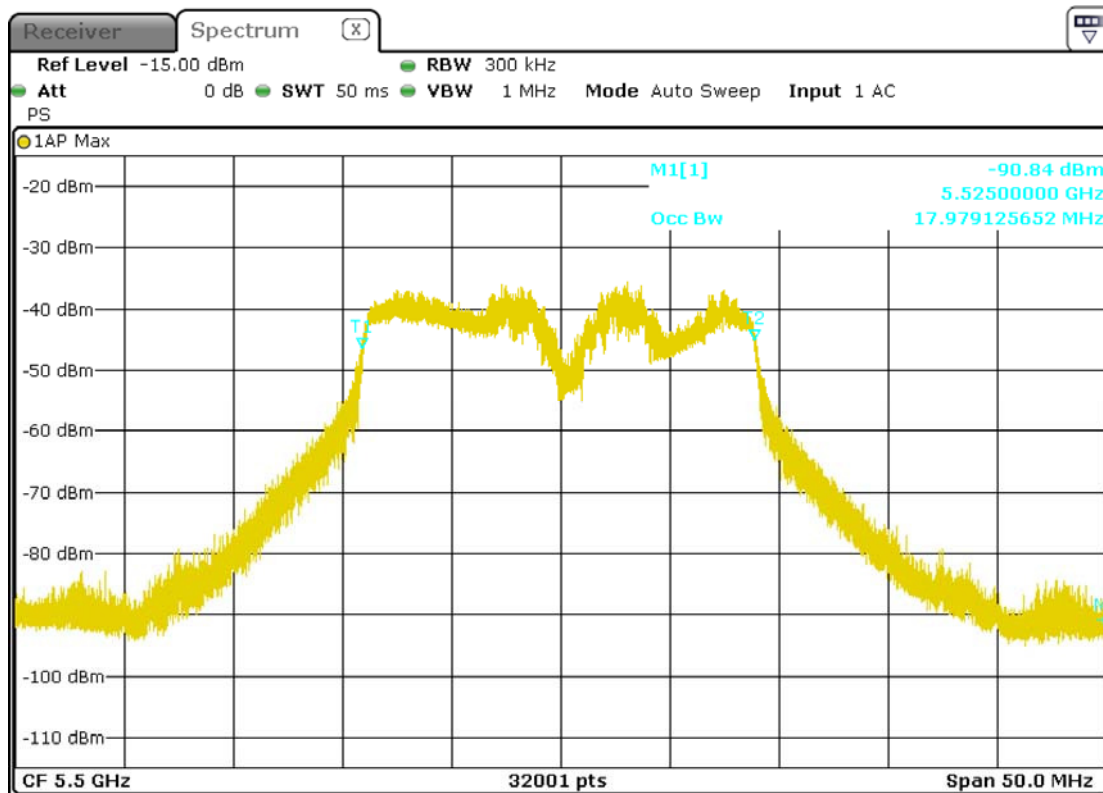

U-NII 99% Channel bandwidth

802.11n HT40

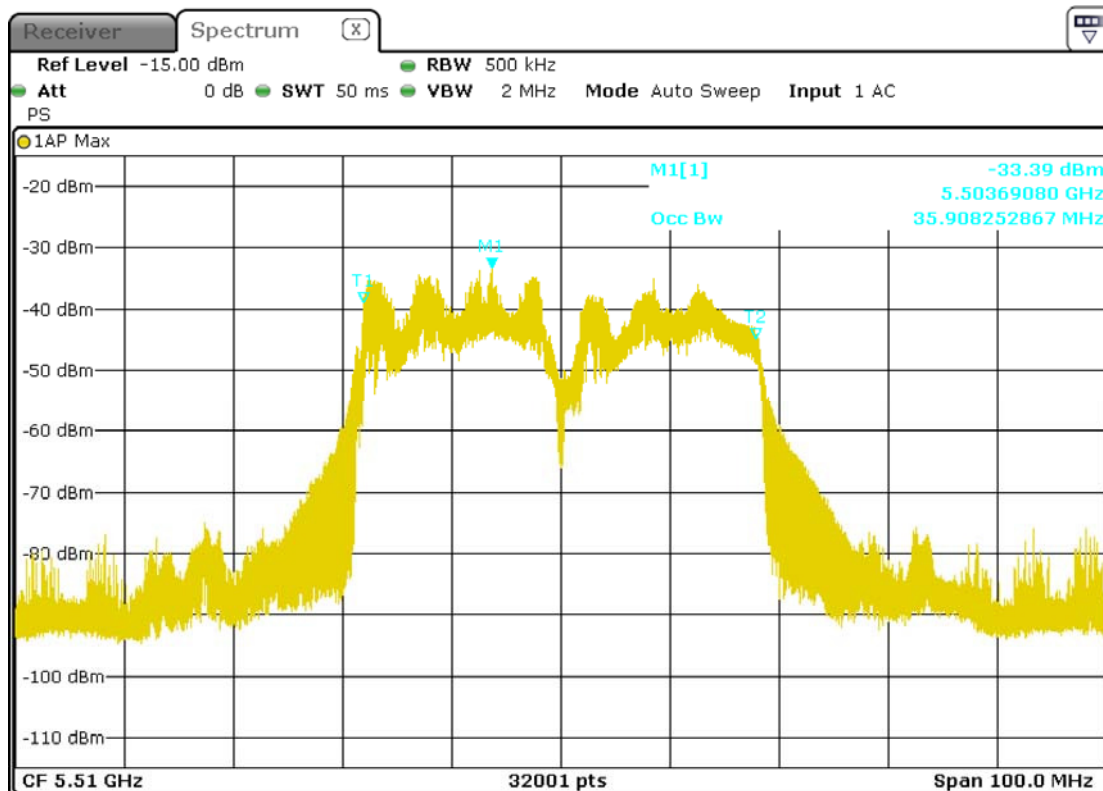

U-NII 99% Channel bandwidth

802.11ac VHT80

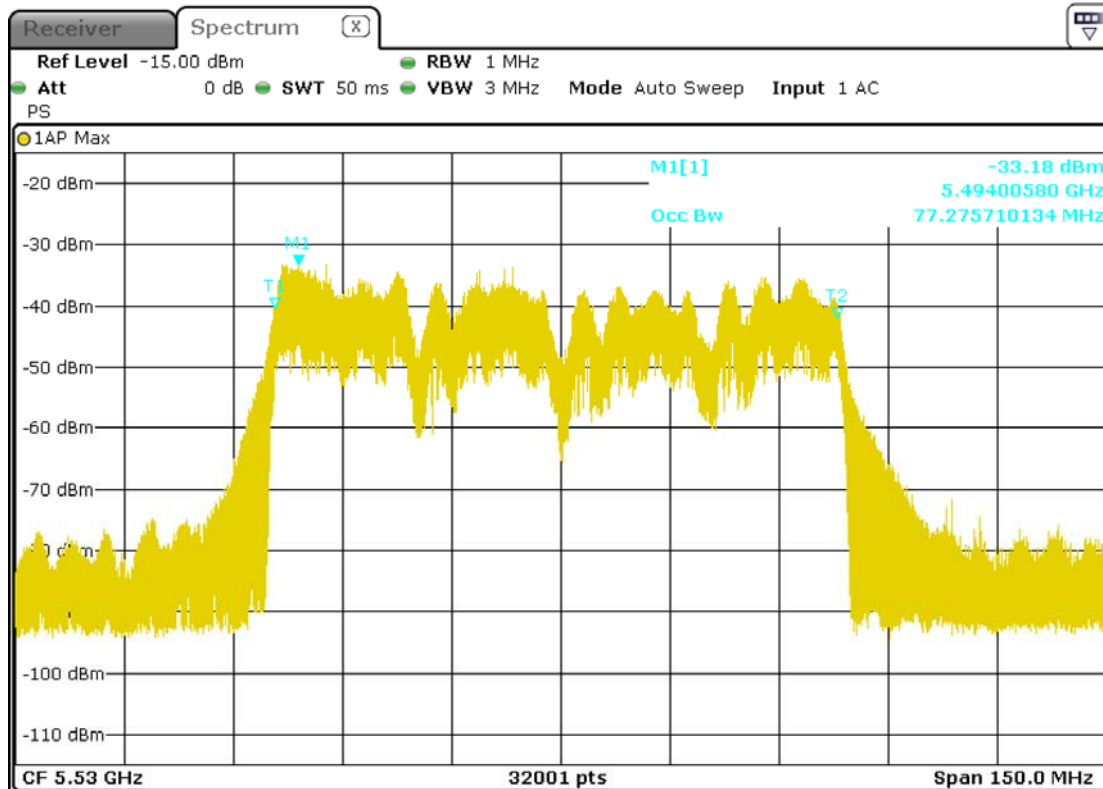

U-NII 99% Channel bandwidth

Detection Bandwidth Test - IEEE 802.11n (HT20)

Radar Type 0

EUT Frequency: 5500MHz

EUT 99% Power bandwidth: 17.97MHz

Detection bandwidth limit (100% of EUT 99% Power bandwidth): 17.97MHz

Detection bandwidth (5510(FH) – 5490(FL)) : 20MHz

Test Result : PASS

Radar Frequency (MHz)	Trial Number / Detection										Detection Rate (%)
	1	2	3	4	5	6	7	8	9	10	
5489	N	N	N	N	N	N	N	N	N	N	0
5490(FL)	Y	Y	Y	Y	Y	Y	Y	Y	Y	Y	100
5491	Y	Y	Y	Y	Y	Y	Y	Y	Y	Y	100
5492	Y	Y	Y	Y	Y	Y	Y	Y	Y	Y	100
5493	Y	Y	Y	Y	Y	Y	Y	Y	Y	Y	100
5494	Y	Y	Y	Y	Y	Y	Y	Y	Y	Y	100
5495	Y	Y	Y	Y	Y	Y	Y	Y	Y	Y	100
5496	Y	Y	Y	Y	Y	Y	Y	Y	Y	Y	100
5497	Y	Y	Y	Y	Y	Y	Y	Y	Y	Y	100
5498	Y	Y	Y	Y	Y	Y	Y	Y	Y	Y	100
5499	Y	Y	Y	Y	Y	Y	Y	Y	Y	Y	100
5500	Y	Y	Y	Y	Y	Y	Y	Y	Y	Y	100
5501	Y	Y	Y	Y	Y	Y	Y	Y	Y	Y	100
5502	Y	Y	Y	Y	Y	Y	Y	Y	Y	Y	100
5503	Y	Y	Y	Y	Y	Y	Y	Y	Y	Y	100
5504	Y	Y	Y	Y	Y	Y	Y	Y	Y	Y	100
5505	Y	Y	Y	Y	Y	Y	Y	Y	Y	Y	100
5506	Y	Y	Y	Y	Y	Y	Y	Y	Y	Y	100
5507	Y	Y	Y	Y	Y	Y	Y	Y	Y	Y	100
5508	Y	Y	Y	Y	Y	Y	Y	Y	Y	Y	100
5509	Y	Y	Y	Y	Y	Y	Y	Y	Y	Y	100
5510(FH)	Y	Y	Y	Y	Y	Y	Y	Y	Y	Y	100
5511	N	N	N	N	N	N	N	N	N	N	0

Detection Bandwidth Test - IEEE 802.11n (HT40)

Radar Type 0

EUT Frequency: 5510MHz

EUT 99% Power bandwidth: 35.90MHz

Detection bandwidth limit (100% of EUT 99% Power bandwidth): 35.90MHz

Detection bandwidth (5530(FH) – 5490(FL)) : 40MHz

Test Result : PASS

Radar Frequency (MHz)	Trial Number / Detection										Detection Rate (%)
	1	2	3	4	5	6	7	8	9	10	
5489	N	N	N	N	N	N	N	N	N	N	0
5490(FL)	Y	Y	Y	Y	Y	Y	Y	Y	Y	Y	100
5491	Y	Y	Y	Y	Y	Y	Y	Y	Y	Y	100
5492	Y	Y	Y	Y	Y	Y	Y	Y	Y	Y	100
5493	Y	Y	Y	Y	Y	Y	Y	Y	Y	Y	100
5494	Y	Y	Y	Y	Y	Y	Y	Y	Y	Y	100
5495	Y	Y	Y	Y	Y	Y	Y	Y	Y	Y	100
5496	Y	Y	Y	Y	Y	Y	Y	Y	Y	Y	100
5497	Y	Y	Y	Y	Y	Y	Y	Y	Y	Y	100
5498	Y	Y	Y	Y	Y	Y	Y	Y	Y	Y	100
5499	Y	Y	Y	Y	Y	Y	Y	Y	Y	Y	100
5500	Y	Y	Y	Y	Y	Y	Y	Y	Y	Y	100
5501	Y	Y	Y	Y	Y	Y	Y	Y	Y	Y	100
5502	Y	Y	Y	Y	Y	Y	Y	Y	Y	Y	100
5503	Y	Y	Y	Y	Y	Y	Y	Y	Y	Y	100
5504	Y	Y	Y	Y	Y	Y	Y	Y	Y	Y	100
5505	Y	Y	Y	Y	Y	Y	Y	Y	Y	Y	100
5506	Y	Y	Y	Y	Y	Y	Y	Y	Y	Y	100
5507	Y	Y	Y	Y	Y	Y	Y	Y	Y	Y	100
5508	Y	Y	Y	Y	Y	Y	Y	Y	Y	Y	100
5509	Y	Y	Y	Y	Y	Y	Y	Y	Y	Y	100
5510	Y	Y	Y	Y	Y	Y	Y	Y	Y	Y	100
5511	Y	Y	Y	Y	Y	Y	Y	Y	Y	Y	100
5512	Y	Y	Y	Y	Y	Y	Y	Y	Y	Y	100
5513	Y	Y	Y	Y	Y	Y	Y	Y	Y	Y	100
5514	Y	Y	Y	Y	Y	Y	Y	Y	Y	Y	100
5515	Y	Y	Y	Y	Y	Y	Y	Y	Y	Y	100
5516	Y	Y	Y	Y	Y	Y	Y	Y	Y	Y	100
5517	Y	Y	Y	Y	Y	Y	Y	Y	Y	Y	100
5518	Y	Y	Y	Y	Y	Y	Y	Y	Y	Y	100
5519	Y	Y	Y	Y	Y	Y	Y	Y	Y	Y	100
5520	Y	Y	Y	Y	Y	Y	Y	Y	Y	Y	100
5521	Y	Y	Y	Y	Y	Y	Y	Y	Y	Y	100
5522	Y	Y	Y	Y	Y	Y	Y	Y	Y	Y	100
5523	Y	Y	Y	Y	Y	Y	Y	Y	Y	Y	100
5524	Y	Y	Y	Y	Y	Y	Y	Y	Y	Y	100
5525	Y	Y	Y	Y	Y	Y	Y	Y	Y	Y	100
5526	Y	Y	Y	Y	Y	Y	Y	Y	Y	Y	100
5527	Y	Y	Y	Y	Y	Y	Y	Y	Y	Y	100
5528	Y	Y	Y	Y	Y	Y	Y	Y	Y	Y	100
5529	Y	Y	Y	Y	Y	Y	Y	Y	Y	Y	100
5530(FH)	Y	Y	Y	Y	Y	Y	Y	Y	Y	Y	100
5531	N	N	N	N	N	N	N	N	N	N	0

Detection Bandwidth Test - IEEE 802.11ac (VHT80)

Radar Type 0

EUT Frequency: 5530MHz

EUT 99% Power bandwidth: 77.27MHz

Detection bandwidth limit (100% of EUT 99% Power bandwidth): 77.27MHz

Detection bandwidth (5570(FH) – 5490(FL)) : 80MHz

Test Result : PASS

Radar Frequency (MHz)	Trial Number / Detection										Detection Rate (%)
	1	2	3	4	5	6	7	8	9	10	
5489	N	N	N	N	N	N	N	N	N	N	0
5490(FL)	Y	Y	Y	Y	Y	Y	Y	Y	Y	Y	100
5491	Y	Y	Y	Y	Y	Y	Y	Y	Y	Y	100
5492	Y	Y	Y	Y	Y	Y	Y	Y	Y	Y	100
5493	Y	Y	Y	Y	Y	Y	Y	Y	Y	Y	100
5494	Y	Y	Y	Y	Y	Y	Y	Y	Y	Y	100
5495	Y	Y	Y	Y	Y	Y	Y	Y	Y	Y	100
5496	Y	Y	Y	Y	Y	Y	Y	Y	Y	Y	100
5497	Y	Y	Y	Y	Y	Y	Y	Y	Y	Y	100
5498	Y	Y	Y	Y	Y	Y	Y	Y	Y	Y	100
5499	Y	Y	Y	Y	Y	Y	Y	Y	Y	Y	100
5500	Y	Y	Y	Y	Y	Y	Y	Y	Y	Y	100
5501	Y	Y	Y	Y	Y	Y	Y	Y	Y	Y	100
5502	Y	Y	Y	Y	Y	Y	Y	Y	Y	Y	100
5503	Y	Y	Y	Y	Y	Y	Y	Y	Y	Y	100
5504	Y	Y	Y	Y	Y	Y	Y	Y	Y	Y	100
5505	Y	Y	Y	Y	Y	Y	Y	Y	Y	Y	100
5506	Y	Y	Y	Y	Y	Y	Y	Y	Y	Y	100
5507	Y	Y	Y	Y	Y	Y	Y	Y	Y	Y	100
5508	Y	Y	Y	Y	Y	Y	Y	Y	Y	Y	100
5509	Y	Y	Y	Y	Y	Y	Y	Y	Y	Y	100
5510	Y	Y	Y	Y	Y	Y	Y	Y	Y	Y	100
5511	Y	Y	Y	Y	Y	Y	Y	Y	Y	Y	100
5512	Y	Y	Y	Y	Y	Y	Y	Y	Y	Y	100
5513	Y	Y	Y	Y	Y	Y	Y	Y	Y	Y	100
5514	Y	Y	Y	Y	Y	Y	Y	Y	Y	Y	100
5515	Y	Y	Y	Y	Y	Y	Y	Y	Y	Y	100
5516	Y	Y	Y	Y	Y	Y	Y	Y	Y	Y	100
5517	Y	Y	Y	Y	Y	Y	Y	Y	Y	Y	100
5518	Y	Y	Y	Y	Y	Y	Y	Y	Y	Y	100
5519	Y	Y	Y	Y	Y	Y	Y	Y	Y	Y	100
5520	Y	Y	Y	Y	Y	Y	Y	Y	Y	Y	100
5521	Y	Y	Y	Y	Y	Y	Y	Y	Y	Y	100
5522	Y	Y	Y	Y	Y	Y	Y	Y	Y	Y	100
5523	Y	Y	Y	Y	Y	Y	Y	Y	Y	Y	100
5524	Y	Y	Y	Y	Y	Y	Y	Y	Y	Y	100
5525	Y	Y	Y	Y	Y	Y	Y	Y	Y	Y	100
5526	Y	Y	Y	Y	Y	Y	Y	Y	Y	Y	100
5527	Y	Y	Y	Y	Y	Y	Y	Y	Y	Y	100
5528	Y	Y	Y	Y	Y	Y	Y	Y	Y	Y	100
5529	Y	Y	Y	Y	Y	Y	Y	Y	Y	Y	100
5530	Y	Y	Y	Y	Y	Y	Y	Y	Y	Y	100
5531	Y	Y	Y	Y	Y	Y	Y	Y	Y	Y	100
5532	Y	Y	Y	Y	Y	Y	Y	Y	Y	Y	100
5533	Y	Y	Y	Y	Y	Y	Y	Y	Y	Y	100
5534	Y	Y	Y	Y	Y	Y	Y	Y	Y	Y	100

Radar Frequency (MHz)	Trial Number / Detection										Detection Rate (%)
	1	2	3	4	5	6	7	8	9	10	
5535	Y	Y	Y	Y	Y	Y	Y	Y	Y	Y	100
5536	Y	Y	Y	Y	Y	Y	Y	Y	Y	Y	100
5537	Y	Y	Y	Y	Y	Y	Y	Y	Y	Y	100
5538	Y	Y	Y	Y	Y	Y	Y	Y	Y	Y	100
5539	Y	Y	Y	Y	Y	Y	Y	Y	Y	Y	100
5540	Y	Y	Y	Y	Y	Y	Y	Y	Y	Y	100
5541	Y	Y	Y	Y	Y	Y	Y	Y	Y	Y	100
5542	Y	Y	Y	Y	Y	Y	Y	Y	Y	Y	100
5543	Y	Y	Y	Y	Y	Y	Y	Y	Y	Y	100
5544	Y	Y	Y	Y	Y	Y	Y	Y	Y	Y	100
5545	Y	Y	Y	Y	Y	Y	Y	Y	Y	Y	100
5546	Y	Y	Y	Y	Y	Y	Y	Y	Y	Y	100
5547	Y	Y	Y	Y	Y	Y	Y	Y	Y	Y	100
5548	Y	Y	Y	Y	Y	Y	Y	Y	Y	Y	100
5549	Y	Y	Y	Y	Y	Y	Y	Y	Y	Y	100
5550	Y	Y	Y	Y	Y	Y	Y	Y	Y	Y	100
5551	Y	Y	Y	Y	Y	Y	Y	Y	Y	Y	100
5552	Y	Y	Y	Y	Y	Y	Y	Y	Y	Y	100
5553	Y	Y	Y	Y	Y	Y	Y	Y	Y	Y	100
5554	Y	Y	Y	Y	Y	Y	Y	Y	Y	Y	100
5555	Y	Y	Y	Y	Y	Y	Y	Y	Y	Y	100
5556	Y	Y	Y	Y	Y	Y	Y	Y	Y	Y	100
5557	Y	Y	Y	Y	Y	Y	Y	Y	Y	Y	100
5558	Y	Y	Y	Y	Y	Y	Y	Y	Y	Y	100
5559	Y	Y	Y	Y	Y	Y	Y	Y	Y	Y	100
5560	Y	Y	Y	Y	Y	Y	Y	Y	Y	Y	100
5561	Y	Y	Y	Y	Y	Y	Y	Y	Y	Y	100
5562	Y	Y	Y	Y	Y	Y	Y	Y	Y	Y	100
5563	Y	Y	Y	Y	Y	Y	Y	Y	Y	Y	100
5564	Y	Y	Y	Y	Y	Y	Y	Y	Y	Y	100
5565	Y	Y	Y	Y	Y	Y	Y	Y	Y	Y	100
5566	Y	Y	Y	Y	Y	Y	Y	Y	Y	Y	100
5567	Y	Y	Y	Y	Y	Y	Y	Y	Y	Y	100
5568	Y	Y	Y	Y	Y	Y	Y	Y	Y	Y	100
5569	Y	Y	Y	Y	Y	Y	Y	Y	Y	Y	100
5570(FH)	Y	Y	Y	Y	Y	Y	Y	Y	Y	Y	100
5571	N	N	N	N	N	N	N	N	N	N	0

6.1.1 Channel Availability Check Time

If the EUT successfully detected the radar burst, it should be observed as the EUT has no transmissions occurred until the EUT starts transmitting on another channel.

Timing of Radar Signal	Observation	
	EUT	Spectrum Analyzer
Within 1 to 6 second	Detected	No transmissions
Within 54 to 60 second	Detected	No transmissions

Initial Channel Availability Check Time

Channel Availability Check

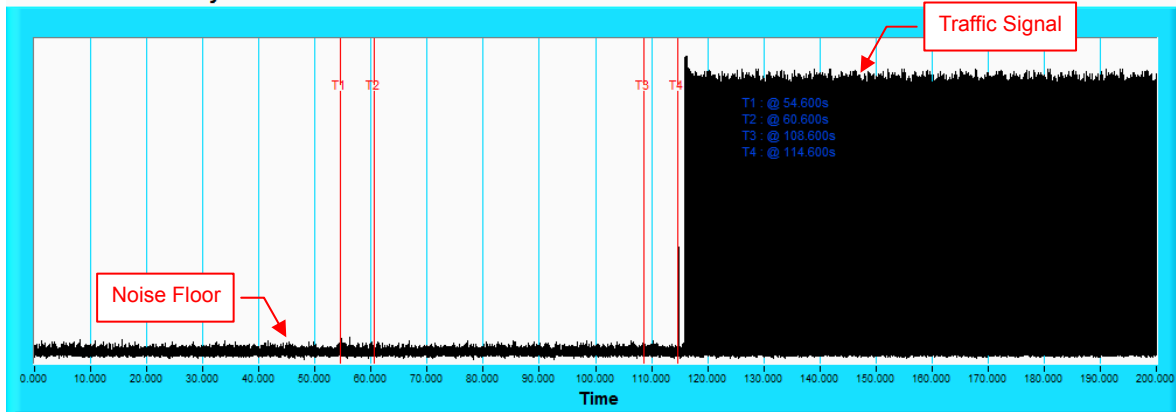

NOTE: T1 denotes the end of power-up time period is 54.6 second. T4 denotes the end of Channel Availability Check time is 114.6 second. Channel Availability Check time is equal to (T4 – T1) 60 seconds.

Radar Burst at the Beginning of the Channel Availability Check Time

Channel Availability Check

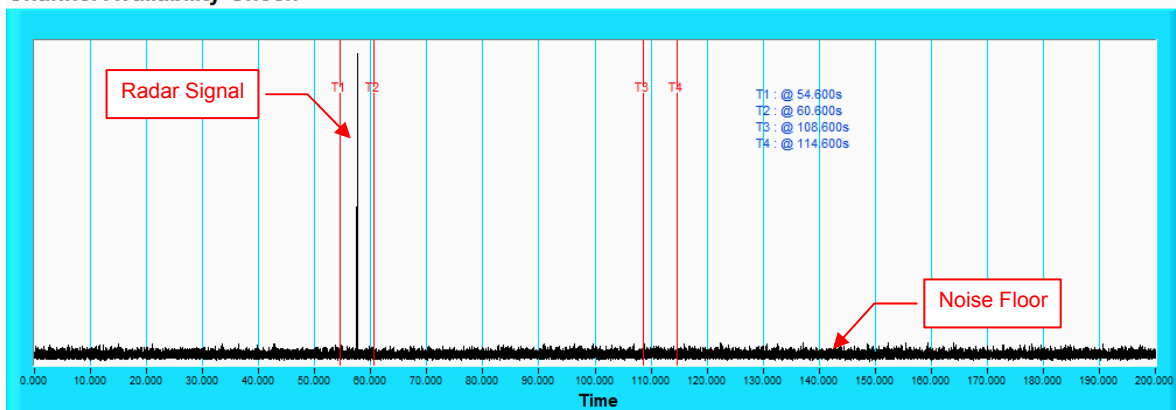

NOTE: T1 denotes the end of power up time period is 54.6 second. T2 denotes 60.6 second, the radar burst was commenced within a 6 second window starting from the end of power-up sequence. T4 denotes the 114.6 second.

Radar Burst at the End of the Channel Availability Check Time

Channel Availability Check

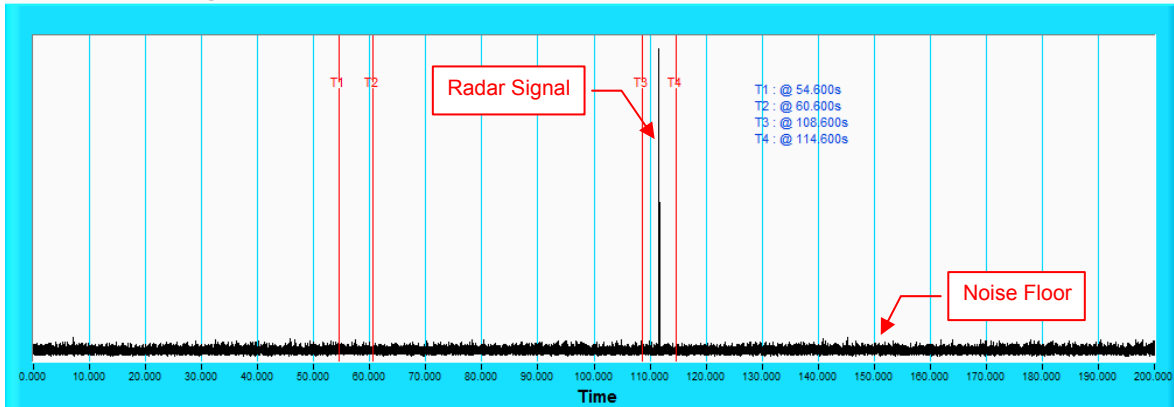

NOTE: T1 denotes the end of power up time period is 54.6 second. T3 denotes 108.6 second and radar burst was commenced within 54th second to 60th second window starting from the end of power-up sequence. T4 denotes the 114.6 second.

6.1.2 Channel Closing Transmission and Channel Move Time

Wireless Traffic Loading IEEE 802.11n (HT20)

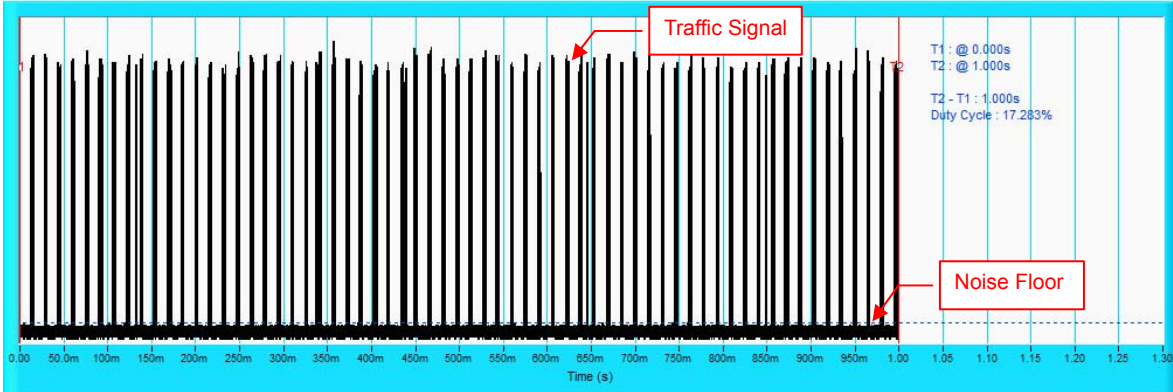

IEEE 802.11n (HT40)

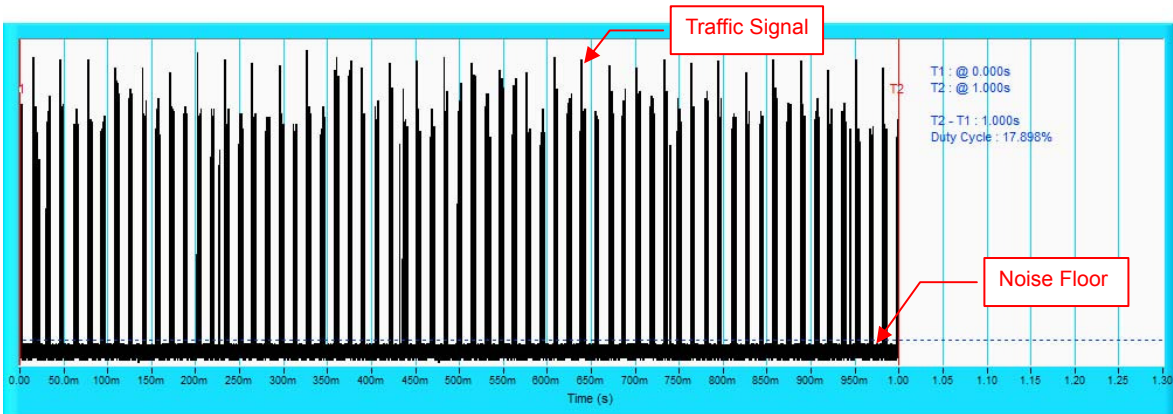

IEEE 802.11ac VHT80

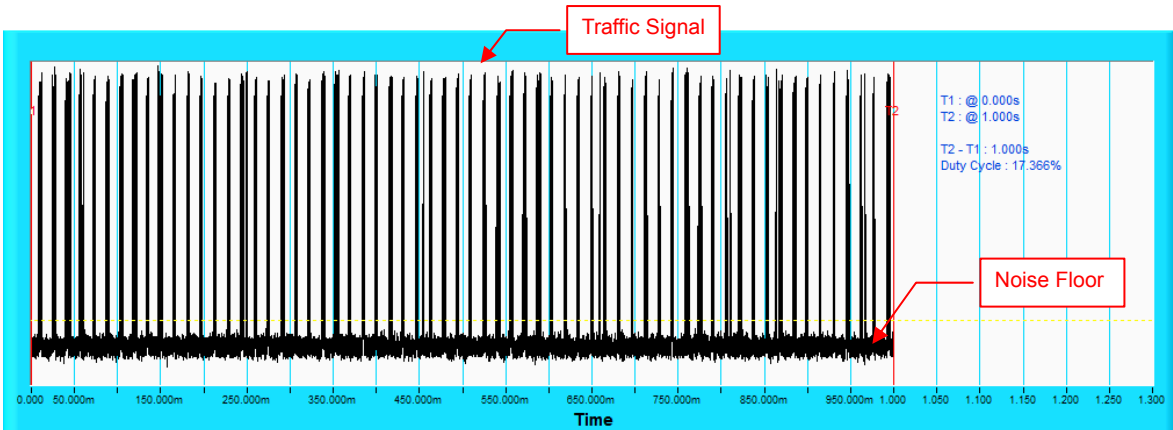

IEEE 802.11n (HT20)

Table 1: Short Pulse Radar Test Waveforms.

Radar Type	Pulse Width (μsec)	PRI (μsec)	Number of Pulses	Number of Trials (Times)	Percentage of Successful Detection (%)
1	1	Test A: 15 unique PRI values randomly selected from the list of 23 PRI values in Table 5a	Roundup $\left\{ \begin{array}{l} \frac{1}{360} \cdot \\ \frac{19 \cdot 10^6}{\text{PRI}_{\mu\text{sec}}} \end{array} \right\}$	30	100
		Test B: 15 unique PRI values randomly selected within the range of 518-3066 μ sec, with a minimum increment of 1 μ sec, excluding PRI values selected in Test A			
2	1-5	150-230	23-29	30	86.7
3	6-10	200-500	16-18	30	80
4	11-20	200-500	12-16	30	86.7
Aggregate (Radar Types 1-4)				120	88.35

Table 2: Long Pulse Radar Test Waveform

Radar Type	Pulse Width (μsec)	Chirp Width (MHz)	PRI (μsec)	Number of Pulses per Burst	Number of Bursts	Number of Trials(Times)	Percentage of Successful Detection (%)
5	50-100	5-20	1000-2000	1-3	8-20	30	80

Table 3: Frequency Hopping Radar Test Waveform

Radar Type	Pulse Width (μsec)	PRI (μsec)	Pulses per Hop	Hopping Rate (kHz)	Hopping Sequence Length (msec)	Number of Trials(Times)	Percentage of Successful Detection (%)
6	1	333	9	0.333	300	30	100

The Detailed Radar pattern and Statistical Performance showed in Annex A.

IEEE 802.11n (HT40)

Table 1: Short Pulse Radar Test Waveforms.

Radar Type	Pulse Width (μsec)	PRI (μsec)	Number of Pulses	Number of Trials (Times)	Percentage of Successful Detection (%)
1	1	Test A: 15 unique PRI values randomly selected from the list of 23 PRI values in Table 5a	Roundup $\left\{ \begin{array}{l} \left\lceil \frac{1}{360} \right\rceil \cdot \\ \left\lceil \frac{19 \cdot 10^6}{\text{PRI}_{\mu\text{sec}}} \right\rceil \end{array} \right\}$	30	100
		Test B: 15 unique PRI values randomly selected within the range of 518-3066 μ sec, with a minimum increment of 1 μ sec, excluding PRI values selected in Test A			
2	1-5	150-230	23-29	30	90
3	6-10	200-500	16-18	30	93.3
4	11-20	200-500	12-16	30	83.3
Aggregate (Radar Types 1-4)				120	91.65

Table 2: Long Pulse Radar Test Waveform

Radar Type	Pulse Width (μsec)	Chirp Width (MHz)	PRI (μsec)	Number of Pulses per Burst	Number of Bursts	Number of Trials(Times)	Percentage of Successful Detection (%)
5	50-100	5-20	1000-2000	1-3	8-20	30	83.3

Table 3: Frequency Hopping Radar Test Waveform

Radar Type	Pulse Width (μsec)	PRI (μsec)	Pulses per Hop	Hopping Rate (kHz)	Hopping Sequence Length (msec)	Number of Trials(Times)	Percentage of Successful Detection (%)
6	1	333	9	0.333	300	30	100

The Detailed Radar pattern and Statistical Performance showed in Annex A.

IEEE 802.11ac (VHT80)

Table 1: Short Pulse Radar Test Waveforms.

Radar Type	Pulse Width (μsec)	PRI (μsec)	Number of Pulses	Number of Trials (Times)	Percentage of Successful Detection (%)
1	1	Test A: 15 unique PRI values randomly selected from the list of 23 PRI values in Table 5a	$\text{Roundup} \left\{ \left(\frac{1}{360} \right) \cdot \left(\frac{19 \cdot 10^6}{\text{PRI}_{\mu\text{sec}}} \right) \right\}$	30	100
		Test B: 15 unique PRI values randomly selected within the range of 518-3066 μ sec, with a minimum increment of 1 μ sec, excluding PRI values selected in Test A			
2	1-5	150-230	23-29	30	90
3	6-10	200-500	16-18	30	80
4	11-20	200-500	12-16	30	90
Aggregate (Radar Types 1-4)				120	90

Table 2: Long Pulse Radar Test Waveform

Radar Type	Pulse Width (μsec)	Chirp Width (MHz)	PRI (μsec)	Number of Pulses per Burst	Number of Bursts	Number of Trials(Times)	Percentage of Successful Detection (%)
5	50-100	5-20	1000-2000	1-3	8-20	30	86.7

Table 3: Frequency Hopping Radar Test Waveform

Radar Type	Pulse Width (μsec)	PRI (μsec)	Pulses per Hop	Hopping Rate (kHz)	Hopping Sequence Length (msec)	Number of Trials(Times)	Percentage of Successful Detection (%)
6	1	333	9	0.333	300	30	100

The Detailed Radar pattern and Statistical Performance showed in Annex A.

Radar signal 0 IEEE 802.11n (HT20)

Channel Closing Transmission Time & Channel Move Time

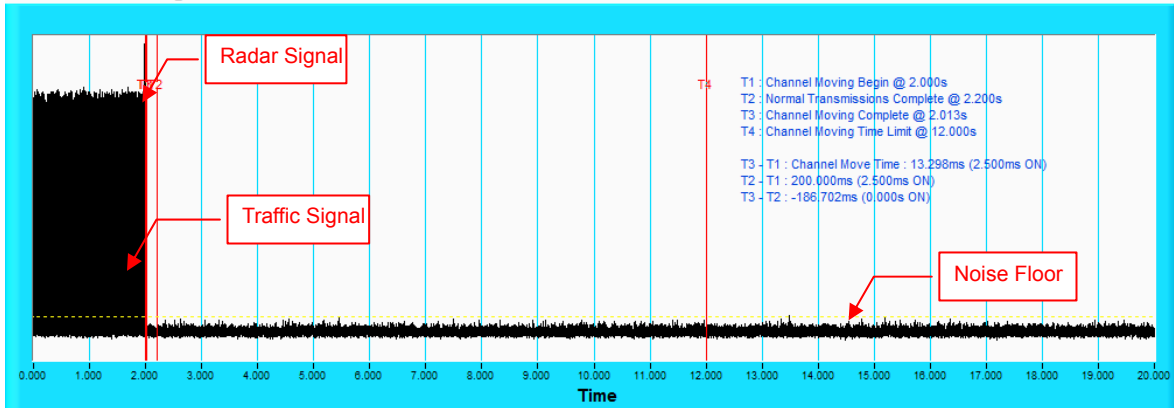

NOTE: T1 denotes the start of Channel Move Time upon the end of the last Radar burst. T2 denotes the data transmission time of 200ms from T1. T3 denotes the end of Channel Move Time. T4 denotes the 10 second from T1 to observe the aggregate duration of transmissions.

Channel Closing Transmission Time & Channel Move Time

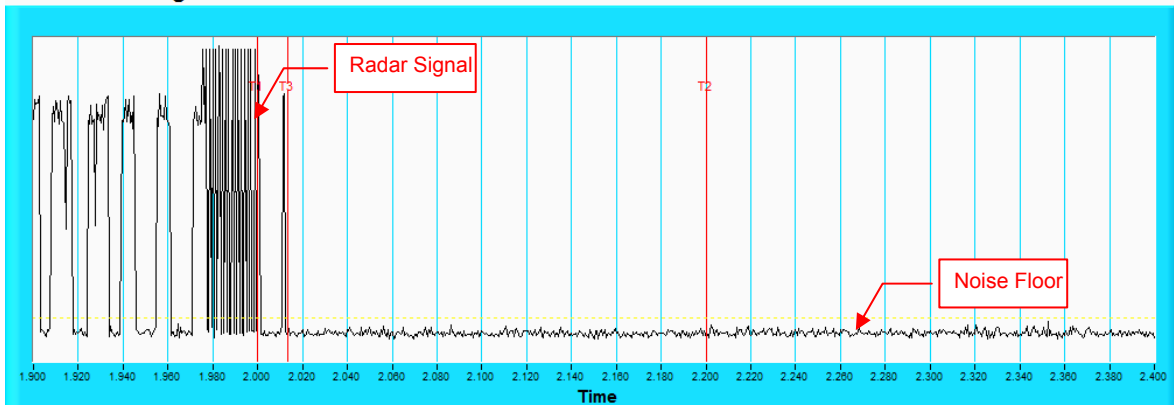

NOTE: Room-in of the first 500ms after radar signal applied.

Radar signal 1 IEEE 802.11n (HT20)

Channel Closing Transmission Time & Channel Move Time

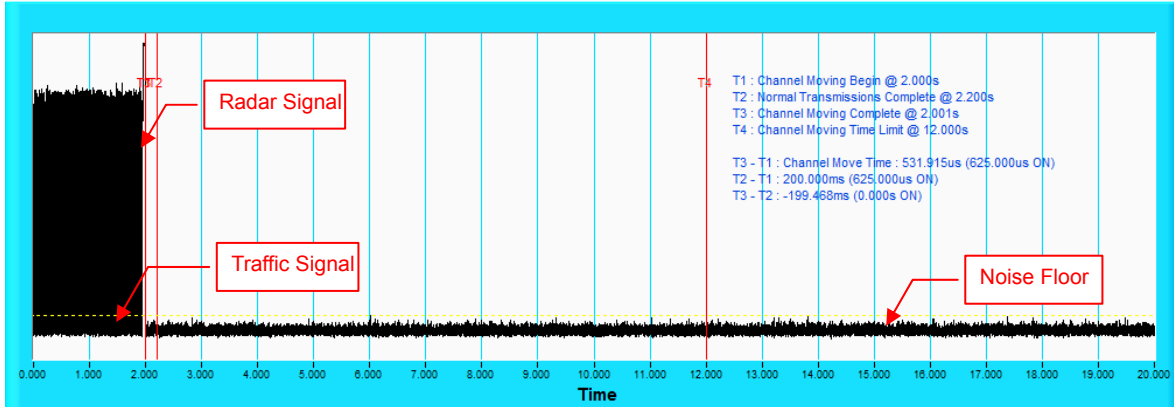

NOTE: T1 denotes the start of Channel Move Time upon the end of the last Radar burst. T2 denotes the data transmission time of 200ms from T1. T3 denotes the end of Channel Move Time. T4 denotes the 10 second from T1 to observe the aggregate duration of transmissions.

Channel Closing Transmission Time & Channel Move Time

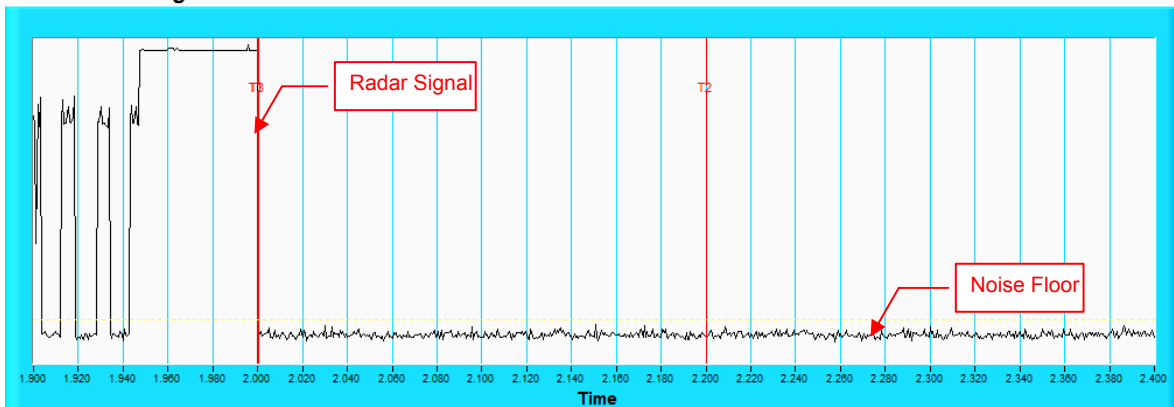

NOTE: Room-in of the first 500ms after radar signal applied.

Radar signal 2

IEEE 802.11n (HT20)

Channel Closing Transmission Time & Channel Move Time

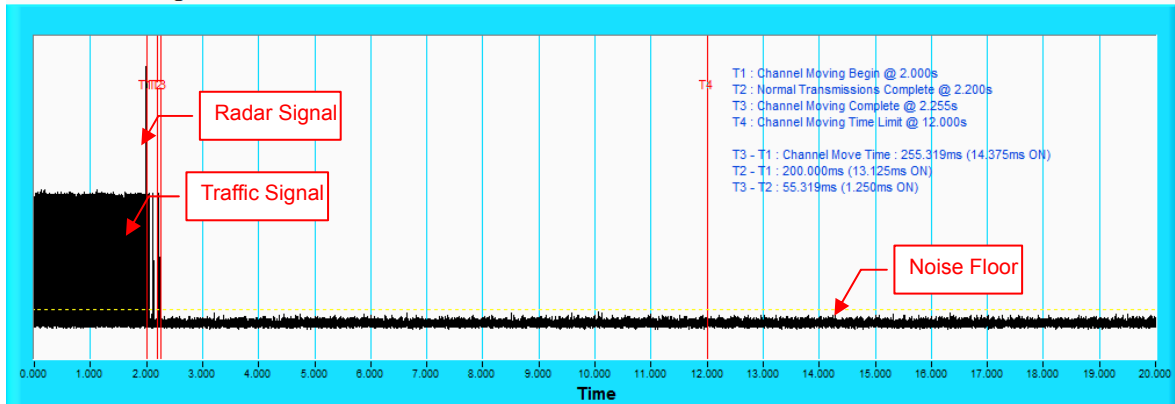

NOTE: T1 denotes the start of Channel Move Time upon the end of the last Radar burst. T2 denotes the data transmission time of 200ms from T1. T3 denotes the end of Channel Move Time. T4 denotes the 10 second from T1 to observe the aggregate duration of transmissions.

Channel Closing Transmission Time & Channel Move Time

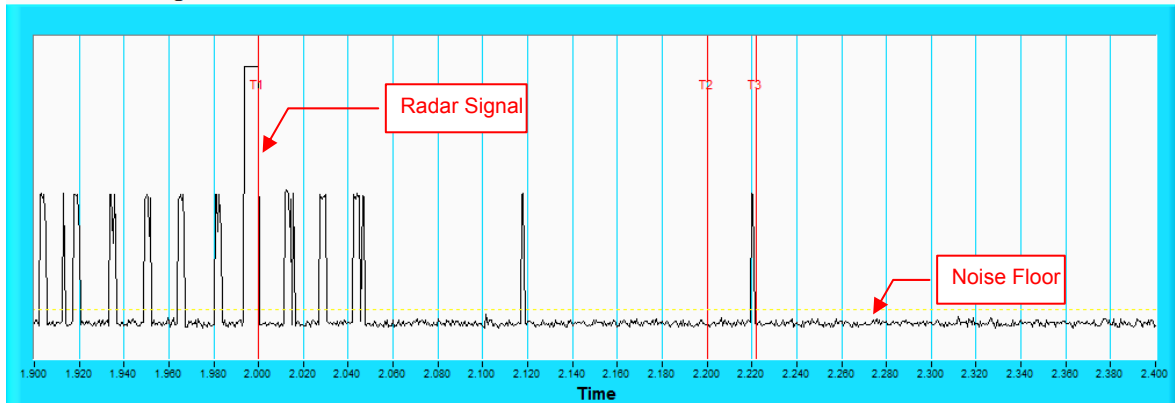

NOTE: Room-in of the first 500ms after radar signal applied.

Radar signal 3 IEEE 802.11n (HT20)

Channel Closing Transmission Time & Channel Move Time

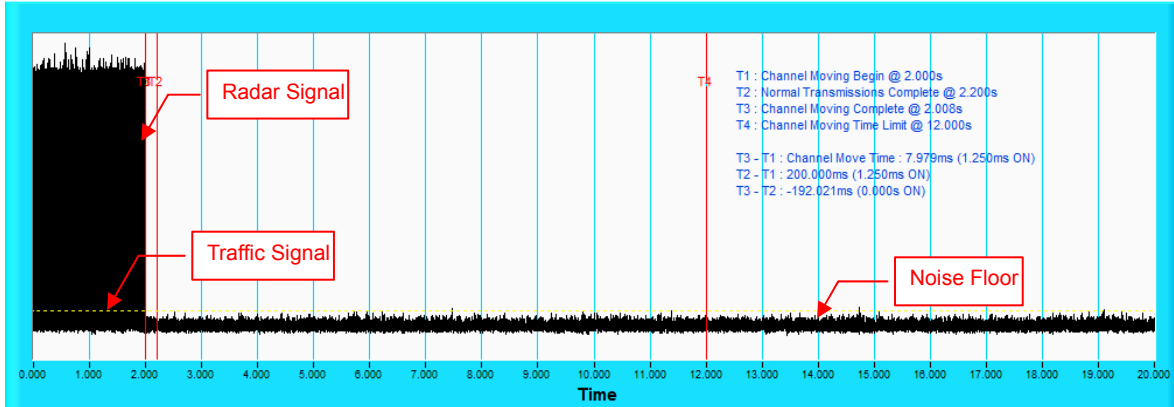

NOTE: T1 denotes the start of Channel Move Time upon the end of the last Radar burst. T2 denotes the data transmission time of 200ms from T1. T3 denotes the end of Channel Move Time. T4 denotes the 10 second from T1 to observe the aggregate duration of transmissions.

Channel Closing Transmission Time & Channel Move Time

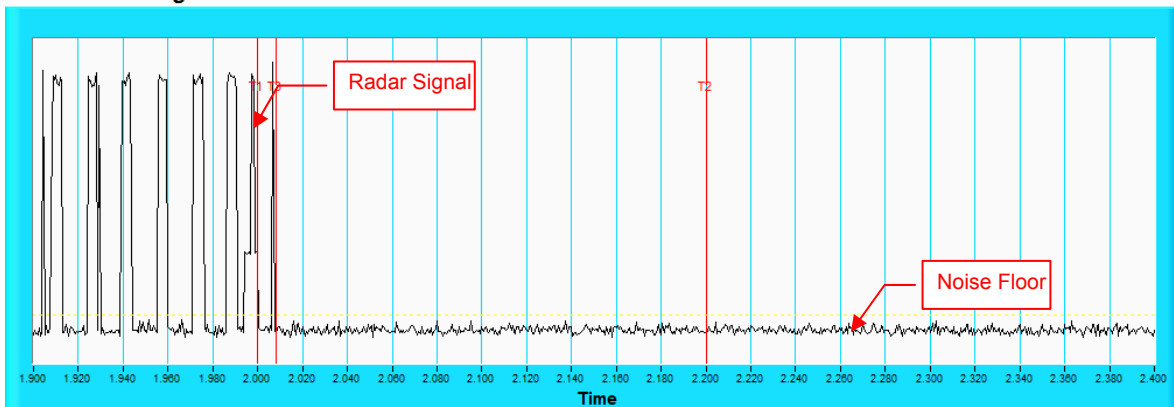

NOTE: Room-in of the first 500ms after radar signal applied.

Radar signal 4 IEEE 802.11n (HT20)

Channel Closing Transmission Time & Channel Move Time

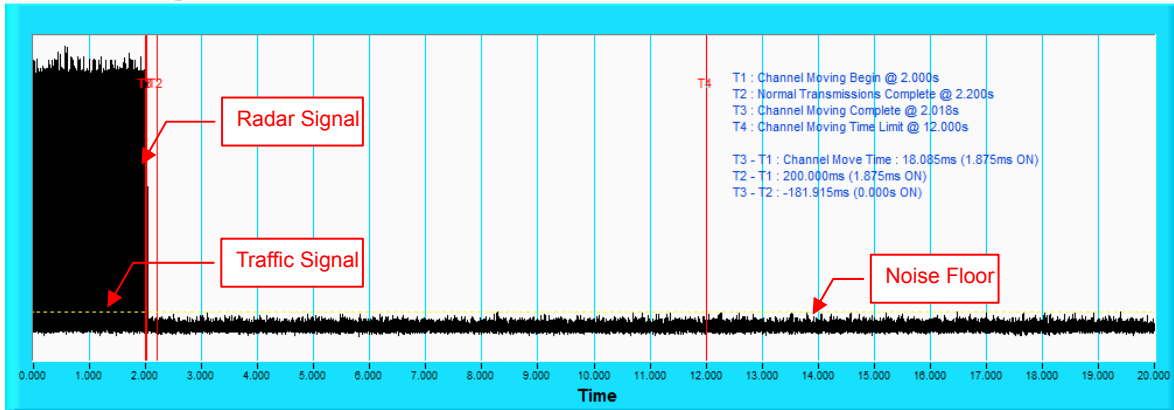

NOTE: T1 denotes the start of Channel Move Time upon the end of the last Radar burst. T2 denotes the data transmission time of 200ms from T1. T3 denotes the end of Channel Move Time. T4 denotes the 10 second from T1 to observe the aggregate duration of transmissions.

Channel Closing Transmission Time & Channel Move Time

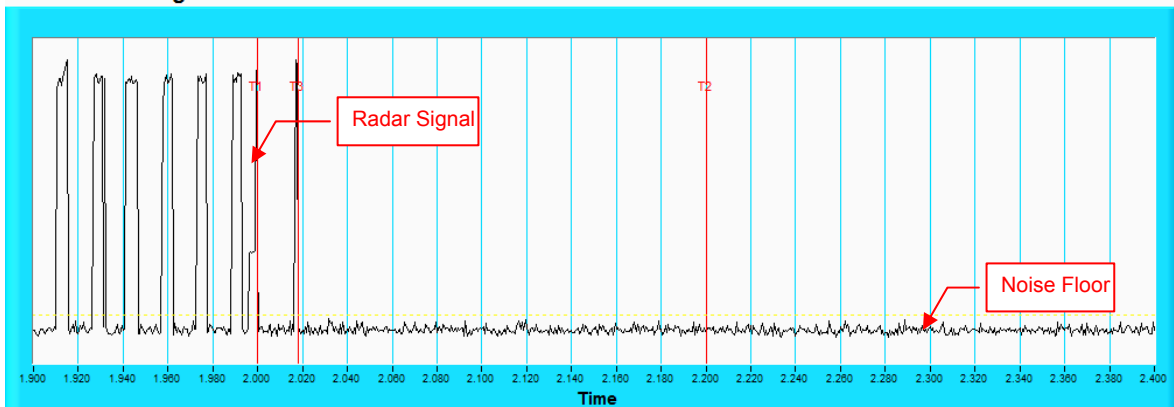

NOTE: Room-in of the first 500ms after radar signal applied.

6.2.3 Non-Occupancy Period

Associate test:

During the 30 minutes observation time, UUT did not make any transmissions on a channel after a radar signal was detected on that channel by either the Channel Availability Check or the In-Service Monitoring.

- 1) EUT (Client) links with master on 5500MHz.

Waveform of EUT links up with Master

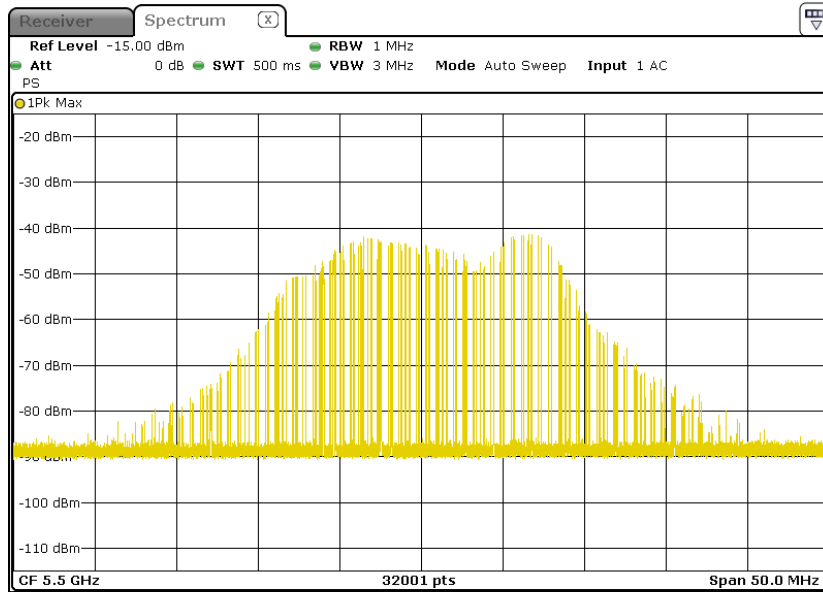

- 2) Client plays specified files via master.

Waveform of transmission

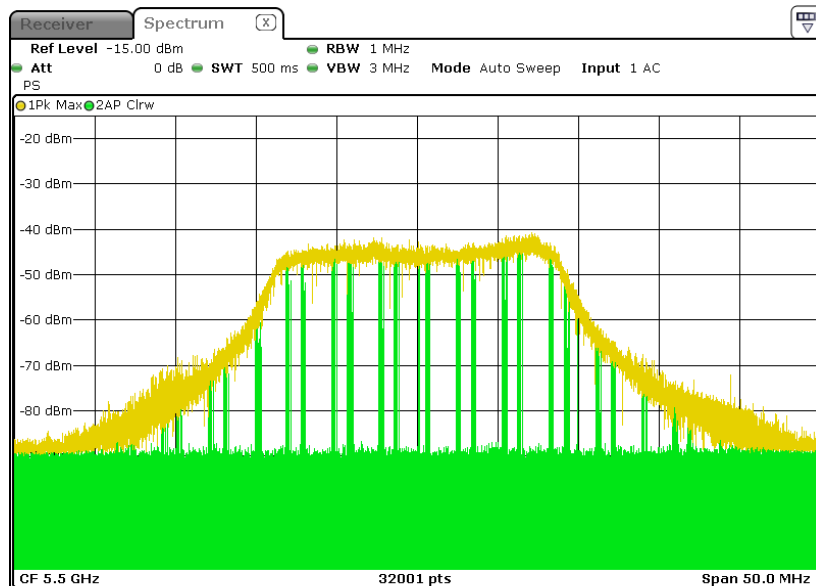

3) Radar signal is applied to the Master device and WiFi traffic signal stop immediately.

Radar 0

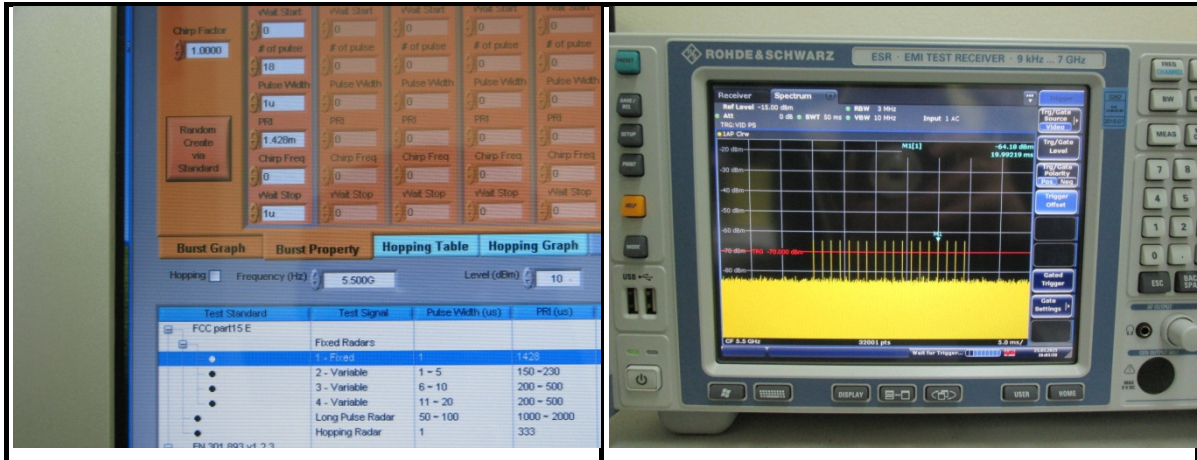

Radar 1

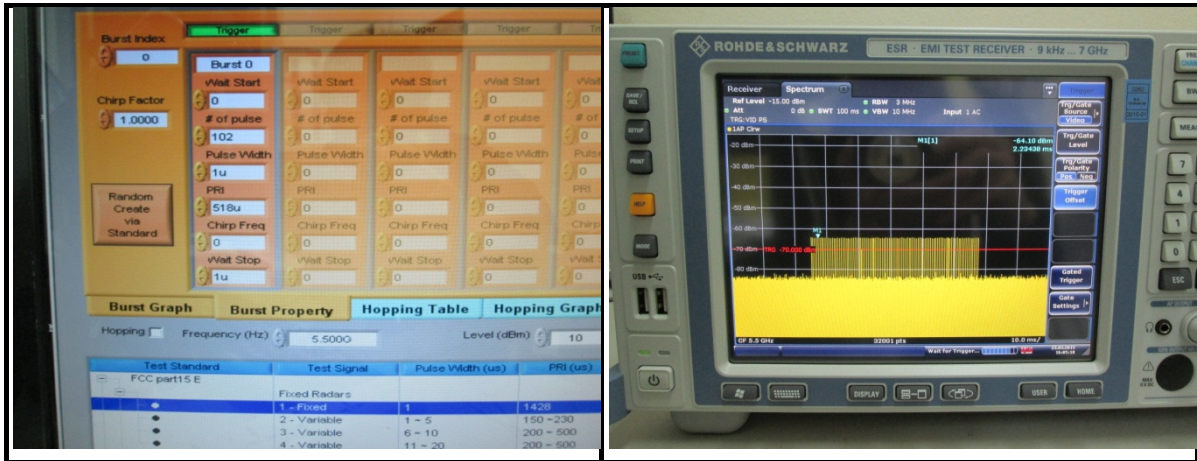

Radar 2



Radar 3

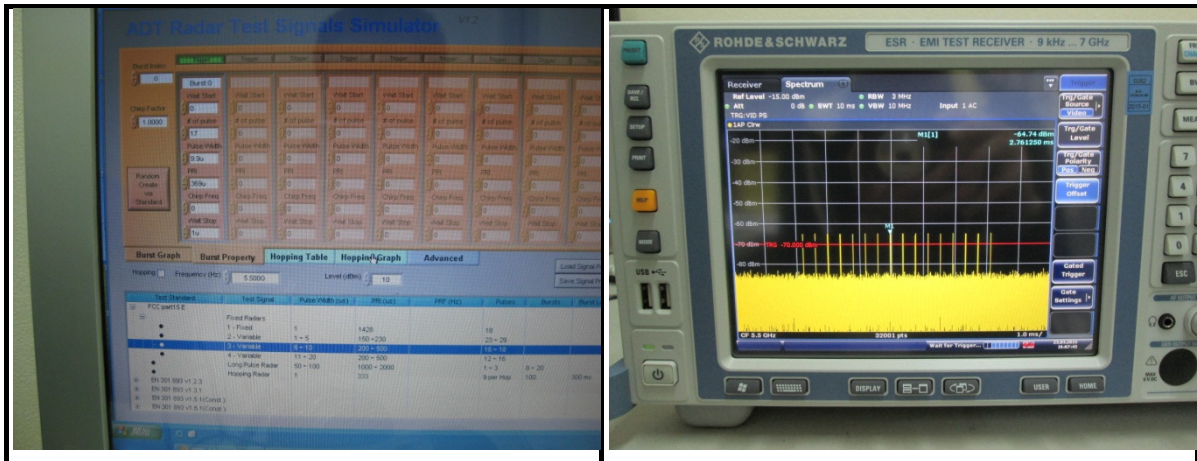

Radar 4

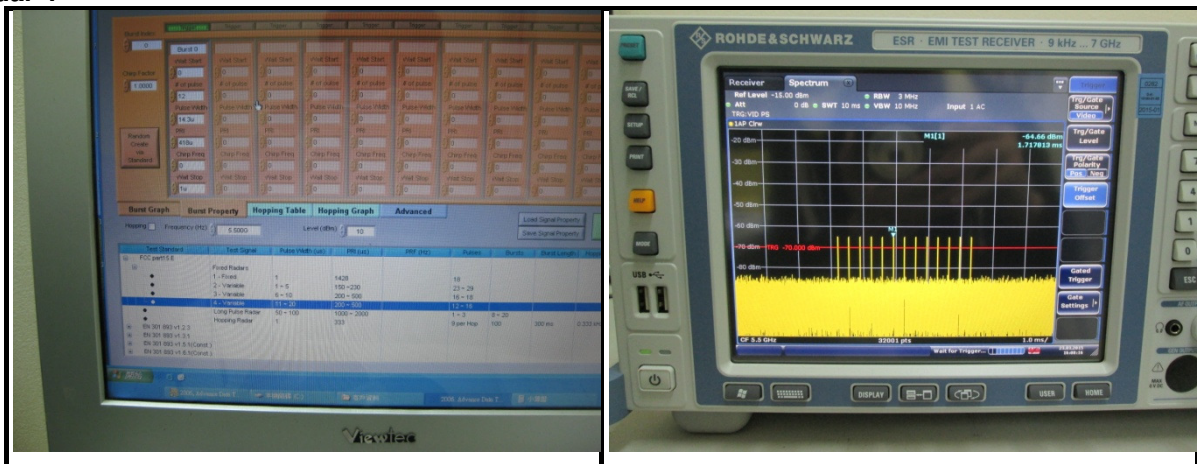

Radar 5



Radar 6



4) 5500MHz has been monitored in 30 minutes period. In this period, no any transmission occurs.

Plot of 30minutes period

802.11n HT20

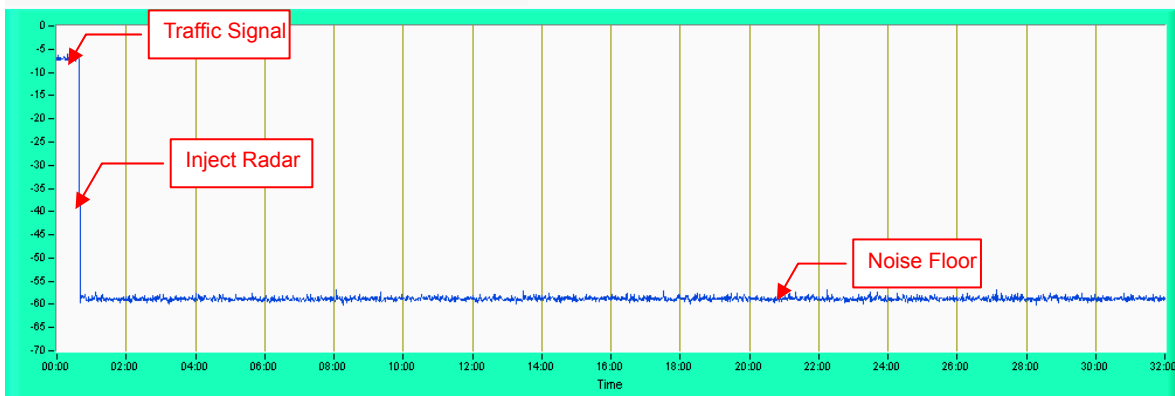

NOTE: Test setup are shown on Test setup photo.pdf

6.2.4 Uniform Spreading

The intention of the uniform spreading is to provide, on aggregate, a uniform loading of the spectrum. The EUT randomly select next output channel without any bias or fixed pattern, so that all channels in DFS bands (5250 to 5350MHz and 5470 to 5725 MHz) will be used equally.

6.2.5 Transmit power control (TPC)

TPC	E.I.R.P	FCC 15.407(h)(1)
√	> 500mW	The TPC mechanism is required for system with an E.I.R.P. of above 500mW
	< 500mW	The TPC mechanism is not required for system with an E.I.R.P. of less 500mW

7 Information on the Testing Laboratories

We, Bureau Veritas Consumer Products Services (H.K.) Ltd., Taoyuan Branch, were founded in 1988 to provide our best service in EMC, Radio, Telecom and Safety consultation. Our laboratories are accredited and approved according to ISO/IEC 17025.

If you have any comments, please feel free to contact us at the following:

Linko EMC/RF Lab

Tel: 886-2-26052180

Fax: 886-2-26051924

Hsin Chu EMC/RF/Telecom Lab

Tel: 886-3-6668565

Fax: 886-3-6668323

Hwa Ya EMC/RF/Safety Lab

Tel: 886-3-3183232

Fax: 886-3-3270892

Email: service.adt@tw.bureauveritas.com

Web Site: www.bureauveritas-adt.com

The address and road map of all our labs can be found in our web site also.

--- END ---

Annex-A

Annex A.1: The Detailed Radar pattern and Statistical Performance

IEEE 802.11N 20MHz

Type 1 Radar Statistical Performances					
Trial #	Pulses per Burst	Pulse Width (s)	PRI (s)	Radar Frequency	Detection
1	102	1.0u	518.0u	5490	Yes
2	99	1.0u	538.0u	5491	Yes
3	95	1.0u	558.0u	5492	Yes
4	92	1.0u	578.0u	5493	Yes
5	89	1.0u	598.0u	5494	Yes
6	86	1.0u	618.0u	5495	Yes
7	83	1.0u	638.0u	5496	Yes
8	81	1.0u	658.0u	5497	Yes
9	78	1.0u	678.0u	5497	Yes
10	76	1.0u	698.0u	5498	Yes
11	74	1.0u	718.0u	5498	Yes
12	72	1.0u	738.0u	5499	Yes
13	70	1.0u	758.0u	5499	Yes
14	68	1.0u	778.0u	5500	Yes
15	67	1.0u	798.0u	5500	Yes
16	102	1.0u	519.0u	5500	Yes
17	80	1.0u	667.0u	5501	Yes
18	63	1.0u	847.0u	5501	Yes
19	71	1.0u	749.0u	5502	Yes
20	64	1.0u	829.0u	5502	Yes
21	96	1.0u	553.0u	5503	Yes
22	73	1.0u	733.0u	5503	Yes
23	96	1.0u	555.0u	5504	Yes
24	70	1.0u	755.0u	5504	Yes
25	57	1.0u	935.0u	5505	Yes
26	78	1.0u	677.0u	5506	Yes
27	61	1.0u	877.0u	5507	Yes
28	70	1.0u	761.0u	5508	Yes
29	62	1.0u	861.0u	5509	Yes
30	57	1.0u	933.0u	5510	Yes

Detection Rate: 100.0 %

Type 2 Radar Statistical Performances					
Trial #	Pulses per Burst	Pulse Width (s)	PRI (s)	Radar Frequency	Detection
1	29	4.8u	194.0u	5490	Yes
2	29	1.1u	168.0u	5491	Yes
3	25	2.1u	162.0u	5492	No
4	28	3.2u	179.0u	5493	Yes
5	28	1.1u	152.0u	5494	Yes
6	26	4.0u	213.0u	5495	Yes
7	23	1.6u	230.0u	5496	Yes
8	28	4.0u	213.0u	5497	Yes
9	27	1.5u	184.0u	5497	Yes
10	27	1.0u	181.0u	5498	No
11	29	1.7u	196.0u	5498	No
12	25	1.9u	196.0u	5499	Yes
13	27	4.4u	223.0u	5499	No
14	24	2.6u	200.0u	5500	Yes
15	27	1.3u	182.0u	5500	Yes
16	27	1.6u	154.0u	5500	Yes
17	23	1.9u	185.0u	5501	Yes
18	28	2.4u	207.0u	5501	Yes
19	23	1.0u	180.0u	5502	Yes
20	24	1.2u	201.0u	5502	Yes
21	25	1.4u	176.0u	5503	Yes
22	27	3.5u	209.0u	5503	Yes
23	27	1.9u	223.0u	5504	Yes
24	26	2.5u	188.0u	5504	Yes
25	24	4.5u	186.0u	5505	Yes
26	25	2.7u	226.0u	5506	Yes
27	24	3.9u	218.0u	5507	Yes
28	23	3.7u	199.0u	5508	Yes
29	28	1.5u	228.0u	5509	Yes
30	28	2.6u	175.0u	5510	Yes
					Detection Rate: 86.7 %

Type 3 Radar Statistical Performances					
Trial #	Pulses per Burst	Pulse Width (s)	PRI (s)	Radar Frequency	Detection
1	16	10.0u	402.0u	5490	Yes
2	16	7.7u	239.0u	5491	Yes
3	17	6.2u	255.0u	5492	No
4	16	9.8u	484.0u	5493	Yes
5	16	9.6u	225.0u	5494	No
6	17	7.2u	255.0u	5495	No
7	16	6.7u	419.0u	5496	Yes
8	18	7.2u	479.0u	5497	Yes
9	18	9.3u	289.0u	5497	Yes
10	16	9.2u	246.0u	5498	Yes
11	16	6.7u	338.0u	5498	Yes
12	17	7.2u	400.0u	5499	Yes
13	17	7.3u	496.0u	5499	Yes
14	18	7.1u	380.0u	5500	Yes
15	17	9.8u	201.0u	5500	Yes
16	17	8.6u	380.0u	5500	Yes
17	17	8.7u	467.0u	5501	No
18	18	6.7u	218.0u	5501	Yes
19	17	7.9u	414.0u	5502	Yes
20	18	7.9u	464.0u	5502	Yes
21	16	7.1u	490.0u	5503	Yes
22	17	9.8u	480.0u	5503	Yes
23	16	7.1u	236.0u	5504	Yes
24	17	7.5u	283.0u	5504	Yes
25	16	8.5u	482.0u	5505	Yes
26	17	7.9u	252.0u	5506	Yes
27	16	8.7u	205.0u	5507	No
28	17	8.6u	432.0u	5508	No
29	17	9.7u	225.0u	5509	Yes
30	17	6.9u	310.0u	5510	Yes
Detection Rate: 80.0 %					

Type 4 Radar Statistical Performances					
Trial #	Pulses per Burst	Pulse Width (s)	PRI (s)	Radar Frequency	Detection
1	13	14.8u	419.0u	5490	Yes
2	13	12.4u	334.0u	5491	Yes
3	13	12.7u	226.0u	5492	Yes
4	15	15.3u	375.0u	5493	Yes
5	14	19.6u	245.0u	5494	No
6	15	13.9u	452.0u	5495	Yes
7	15	17.2u	358.0u	5496	Yes
8	16	13.8u	373.0u	5497	Yes
9	13	18.3u	365.0u	5497	Yes
10	13	13.9u	259.0u	5498	Yes
11	13	16.4u	275.0u	5498	No
12	15	15.0u	244.0u	5499	Yes
13	15	12.3u	339.0u	5499	Yes
14	16	15.5u	400.0u	5500	Yes
15	14	12.6u	369.0u	5500	Yes
16	13	11.2u	469.0u	5500	Yes
17	12	11.1u	448.0u	5501	Yes
18	15	19.0u	453.0u	5501	Yes
19	16	14.3u	357.0u	5502	Yes
20	15	17.6u	434.0u	5502	No
21	16	17.0u	463.0u	5503	Yes
22	14	18.2u	431.0u	5503	Yes
23	13	12.6u	232.0u	5504	Yes
24	13	11.2u	283.0u	5504	Yes
25	12	14.0u	272.0u	5505	Yes
26	15	11.8u	297.0u	5506	Yes
27	13	18.0u	232.0u	5507	No
28	13	17.7u	313.0u	5508	Yes
29	13	16.7u	282.0u	5509	Yes
30	16	13.6u	267.0u	5510	Yes
Detection Rate: 86.7 %					

Type 5 Radar Statistical Performances		
Trial #	Test Signal Name	Detection
1	LP_Signal_01	No
2	LP_Signal_02	No
3	LP_Signal_03	No
4	LP_Signal_04	Yes
5	LP_Signal_05	Yes
6	LP_Signal_06	Yes
7	LP_Signal_07	Yes
8	LP_Signal_08	Yes
9	LP_Signal_09	No
10	LP_Signal_10	No
11	LP_Signal_11	Yes
12	LP_Signal_12	Yes
13	LP_Signal_13	Yes
14	LP_Signal_14	Yes
15	LP_Signal_15	Yes
16	LP_Signal_16	Yes
17	LP_Signal_17	Yes
18	LP_Signal_18	Yes
19	LP_Signal_19	Yes
20	LP_Signal_20	Yes
21	LP_Signal_21	Yes
22	LP_Signal_22	Yes
23	LP_Signal_23	Yes
24	LP_Signal_24	Yes
25	LP_Signal_25	Yes
26	LP_Signal_26	Yes
27	LP_Signal_27	Yes
28	LP_Signal_28	No
29	LP_Signal_29	Yes
30	LP_Signal_30	Yes
		Detection Rate: 80.0 %

Long Pulse Radar Test Signal						
Test Signal Name: LP_Signal_01						
Number of Bursts in Trial: 19						
Chrip Center Frequency: 5491MHz						
Burst	Pulses per Burst	Chrip (Hz)	Pulse Width (s)	Pulse 1 to 2 Spacing (s)	Pulse 2 to 3 Spacing (s)	Start Location (s)
1	2	5M	50.4u	1.916m	-	334.6m
2	2	5M	54.2u	1.760m	-	40.17m
3	2	5M	66.7u	1.591m	-	375.0m
4	1	5M	81.8u	-	-	224.8m
5	3	5M	85.3u	1.562m	1.550m	598.5m
6	2	5M	50.9u	1.097m	-	247.8m
7	3	5M	71.5u	1.403m	1.250m	384.9m
8	1	5M	57.3u	-	-	545.1m
9	1	5M	99.4u	-	-	327.7m
10	2	5M	81.7u	1.762m	-	346.5m
11	3	5M	87.0u	1.625m	1.683m	237.2m
12	2	5M	94.9u	1.522m	-	585.4m
13	2	5M	83.5u	1.529m	-	480.1m
14	2	5M	66.1u	1.677m	-	545.9m
15	2	5M	52.9u	1.709m	-	563.8m
16	3	5M	51.5u	1.865m	1.887m	433.2m
17	1	5M	82.8u	-	-	4.846m
18	2	5M	84.6u	957.4u	-	397.1m
19	3	5M	70.6u	1.247m	1.791m	432.2m

Long Pulse Radar Test Signal
 Test Signal Name: LP_Signal_02
 Number of Bursts in Trial: 9
 Chrip Center Frequency: 5491MHz

Burst	Pulses per Burst	Chrip (Hz)	Pulse Width (s)	Pulse 1 to 2 Spacing (s)	Pulse 2 to 3 Spacing (s)	Start Location (s)
1	1	6M	60.5u	-	-	472.7m
2	1	6M	80.1u	-	-	675.8m
3	2	6M	66.3u	1.548m	-	1.264
4	2	6M	96.6u	1.803m	-	1.141
5	1	6M	81.9u	-	-	946.6m
6	1	6M	80.8u	-	-	104.5m
7	3	6M	55.8u	966.2u	1.307m	288.3m
8	1	6M	61.4u	-	-	551.7m
9	3	6M	88.4u	973.6u	1.741m	76.95m

Long Pulse Radar Test Signal						
Test Signal Name: LP_Signal_03						
Number of Bursts in Trial: 17						
Chrip Center Frequency: 5492MHz						
Burst	Pulses per Burst	Chrip (Hz)	Pulse Width (s)	Pulse 1 to 2 Spacing (s)	Pulse 2 to 3 Spacing (s)	Start Location (s)
1	3	8M	66.5u	1.595m	1.844m	354.9m
2	2	8M	89.2u	980.8u	-	248.4m
3	2	8M	54.7u	1.070m	-	657.2m
4	2	8M	90.3u	1.780m	-	43.30m
5	2	8M	50.3u	1.378m	-	145.2m
6	3	8M	64.0u	1.435m	1.098m	377.9m
7	2	8M	86.4u	1.318m	-	452.1m
8	2	8M	89.4u	1.211m	-	280.2m
9	1	8M	83.5u	-	-	566.8m
10	2	8M	67.6u	1.072m	-	178.7m
11	2	8M	84.3u	1.071m	-	274.6m
12	2	8M	69.9u	1.591m	-	378.6m
13	1	8M	69.4u	-	-	456.7m
14	2	8M	65.5u	981.5u	-	286.7m
15	1	8M	64.7u	-	-	628.0m
16	2	8M	95.7u	1.225m	-	574.7m
17	2	8M	64.3u	1.246m	-	314.7m

Long Pulse Radar Test Signal						
Test Signal Name: LP_Signal_04						
Number of Bursts in Trial: 13						
Chrip Center Frequency: 5493MHz						
Burst	Pulses per Burst	Chrip (Hz)	Pulse Width (s)	Pulse 1 to 2 Spacing (s)	Pulse 2 to 3 Spacing (s)	Start Location (s)
1	2	9M	61.5u	955.5u	-	640.4m
2	1	9M	92.5u	-	-	393.8m
3	3	9M	71.1u	1.724m	1.483m	227.5m
4	2	9M	79.5u	1.035m	-	625.6m
5	2	9M	75.3u	1.324m	-	302.7m
6	3	9M	71.1u	1.201m	1.880m	210.6m
7	2	9M	83.2u	1.845m	-	576.6m
8	2	9M	81.1u	1.333m	-	524.0m
9	2	9M	97.7u	1.050m	-	855.4m
10	2	9M	95.7u	1.224m	-	597.8m
11	2	9M	53.5u	1.334m	-	874.0m
12	3	9M	70.8u	1.735m	1.020m	510.2m
13	2	9M	95.7u	1.535m	-	870.2m

Long Pulse Radar Test Signal						
Test Signal Name: LP_Signal_05						
Number of Bursts in Trial: 20						
Chrip Center Frequency: 5493MHz						
Burst	Pulses per Burst	Chrip (Hz)	Pulse Width (s)	Pulse 1 to 2 Spacing (s)	Pulse 2 to 3 Spacing (s)	Start Location (s)
1	3	11M	83.2u	1.644m	1.165m	247.3m
2	2	11M	59.0u	1.897m	-	528.2m
3	2	11M	65.4u	938.6u	-	344.7m
4	2	11M	81.5u	1.723m	-	322.6m
5	3	11M	76.3u	1.820m	1.145m	27.03m
6	2	11M	88.5u	1.700m	-	209.2m
7	2	11M	82.8u	1.612m	-	306.0m
8	1	11M	59.6u	-	-	204.1m
9	2	11M	51.5u	1.110m	-	235.1m
10	3	11M	93.5u	1.872m	1.143m	350.1m
11	2	11M	81.6u	1.092m	-	370.2m
12	3	11M	50.5u	1.928m	1.706m	363.2m
13	1	11M	53.1u	-	-	37.77m
14	1	11M	52.2u	-	-	316.9m
15	3	11M	58.3u	1.014m	1.238m	172.4m
16	2	11M	71.5u	1.270m	-	446.4m
17	3	11M	95.0u	1.172m	1.527m	127.9m
18	3	11M	76.8u	1.802m	1.280m	370.9m
19	2	11M	70.9u	1.096m	-	297.7m
20	3	11M	71.6u	1.254m	1.111m	489.0m

Long Pulse Radar Test Signal						
Test Signal Name: LP_Signal_06						
Number of Bursts in Trial: 14						
Chrip Center Frequency: 5494MHz						
Burst	Pulses per Burst	Chrip (Hz)	Pulse Width (s)	Pulse 1 to 2 Spacing (s)	Pulse 2 to 3 Spacing (s)	Start Location (s)
1	1	12M	51.2u	-	-	793.1m
2	1	12M	94.5u	-	-	825.8m
3	2	12M	75.3u	1.101m	-	558.8m
4	3	12M	89.1u	1.366m	1.401m	806.0m
5	2	12M	76.4u	1.655m	-	170.1m
6	2	12M	56.9u	1.940m	-	674.9m
7	3	12M	79.5u	1.038m	1.213m	754.7m
8	3	12M	63.2u	1.248m	1.497m	317.7m
9	2	12M	74.2u	1.913m	-	702.9m
10	2	12M	55.3u	1.035m	-	36.98m
11	2	12M	80.6u	1.625m	-	834.5m
12	2	12M	63.5u	1.574m	-	335.8m
13	1	12M	52.9u	-	-	245.9m
14	3	12M	99.2u	1.689m	900.8u	35.74m

Long Pulse Radar Test Signal						
Test Signal Name: LP_Signal_07						
Number of Bursts in Trial: 8						
Chrip Center Frequency: 5495MHz						
Burst	Pulses per Burst	Chrip (Hz)	Pulse Width (s)	Pulse 1 to 2 Spacing (s)	Pulse 2 to 3 Spacing (s)	Start Location (s)
1	2	14M	100.0u	1.316m	-	574.2m
2	2	14M	67.5u	1.529m	-	280.0m
3	3	14M	52.4u	1.833m	955.6u	312.3m
4	3	14M	74.3u	1.451m	1.391m	1.205
5	2	14M	82.0u	1.489m	-	1.470
6	2	14M	65.4u	1.871m	-	1.159
7	2	14M	56.9u	1.758m	-	300.0m
8	1	14M	67.1u	-	-	431.5m

Long Pulse Radar Test Signal						
Test Signal Name: LP_Signal_08						
Number of Bursts in Trial: 9						
Chrip Center Frequency: 5495MHz						
Burst	Pulses per Burst	Chrip (Hz)	Pulse Width (s)	Pulse 1 to 2 Spacing (s)	Pulse 2 to 3 Spacing (s)	Start Location (s)
1	2	16M	95.0u	1.637m	-	263.4m
2	2	16M	75.8u	1.761m	-	1.021
3	2	16M	64.2u	1.140m	-	298.8m
4	1	16M	99.0u	-	-	587.8m
5	2	16M	67.5u	1.113m	-	894.9m
6	2	16M	82.5u	1.573m	-	1.185
7	2	16M	99.1u	1.224m	-	143.0m
8	3	16M	66.4u	1.584m	1.360m	1.320
9	1	16M	90.5u	-	-	586.0m

Long Pulse Radar Test Signal						
Test Signal Name: LP_Signal_09						
Number of Bursts in Trial: 15						
Chrip Center Frequency: 5496MHz						
Burst	Pulses per Burst	Chrip (Hz)	Pulse Width (s)	Pulse 1 to 2 Spacing (s)	Pulse 2 to 3 Spacing (s)	Start Location (s)
1	2	17M	83.3u	1.461m	-	505.3m
2	1	17M	80.8u	-	-	348.6m
3	2	17M	63.4u	1.265m	-	374.7m
4	2	17M	90.4u	949.6u	-	40.99m
5	3	17M	53.6u	1.350m	1.625m	117.0m
6	2	17M	83.2u	1.632m	-	58.99m
7	2	17M	58.1u	1.629m	-	501.3m
8	2	17M	79.4u	1.903m	-	759.4m
9	1	17M	53.6u	-	-	210.0m
10	1	17M	80.1u	-	-	651.0m
11	2	17M	76.2u	935.8u	-	650.7m
12	2	17M	82.5u	1.394m	-	582.6m
13	3	17M	68.6u	1.491m	1.582m	401.2m
14	1	17M	76.7u	-	-	703.8m
15	1	17M	79.2u	-	-	563.3m

Long Pulse Radar Test Signal						
Test Signal Name: LP_Signal_10						
Number of Bursts in Trial: 14						
Chrip Center Frequency: 5497MHz						
Burst	Pulses per Burst	Chrip (Hz)	Pulse Width (s)	Pulse 1 to 2 Spacing (s)	Pulse 2 to 3 Spacing (s)	Start Location (s)
1	2	19M	57.4u	1.572m	-	817.2m
2	3	19M	74.9u	1.651m	1.525m	728.1m
3	2	19M	61.0u	1.735m	-	456.8m
4	1	19M	51.0u	-	-	705.2m
5	1	19M	70.9u	-	-	416.2m
6	1	19M	74.4u	-	-	137.3m
7	2	19M	96.1u	1.248m	-	252.5m
8	2	19M	62.4u	1.425m	-	346.7m
9	3	19M	83.2u	1.202m	1.002m	4.653m
10	2	19M	75.3u	1.397m	-	392.0m
11	2	19M	59.8u	1.393m	-	455.0m
12	2	19M	59.2u	1.897m	-	349.0m
13	2	19M	84.7u	1.796m	-	755.0m
14	2	19M	61.9u	1.149m	-	413.6m

Long Pulse Radar Test Signal						
Test Signal Name: LP_Signal_11						
Number of Bursts in Trial: 18						
Chrip Center Frequency: 5500MHz						
Burst	Pulses per Burst	Chrip (Hz)	Pulse Width (s)	Pulse 1 to 2 Spacing (s)	Pulse 2 to 3 Spacing (s)	Start Location (s)
1	1	5M	53.6u	-	-	504.6m
2	3	5M	97.1u	1.798m	1.565m	441.5m
3	3	5M	53.5u	1.548m	1.068m	291.7m
4	2	5M	52.2u	1.395m	-	212.8m
5	2	5M	95.3u	1.226m	-	96.33m
6	2	5M	92.6u	1.470m	-	303.7m
7	1	5M	82.6u	-	-	516.6m
8	1	5M	53.5u	-	-	141.6m
9	2	5M	57.4u	999.6u	-	95.05m
10	2	5M	96.4u	1.888m	-	567.5m
11	2	5M	66.0u	1.443m	-	271.3m
12	1	5M	98.5u	-	-	442.6m
13	2	5M	68.3u	1.114m	-	512.5m
14	2	5M	85.3u	1.613m	-	105.4m
15	3	5M	99.4u	1.752m	1.843m	647.8m
16	2	5M	97.8u	1.644m	-	259.0m
17	1	5M	77.1u	-	-	649.5m
18	1	5M	58.2u	-	-	539.5m

Long Pulse Radar Test Signal						
Test Signal Name: LP_Signal_12						
Number of Bursts in Trial: 16						
Chrip Center Frequency: 5501MHz						
Burst	Pulses per Burst	Chrip (Hz)	Pulse Width (s)	Pulse 1 to 2 Spacing (s)	Pulse 2 to 3 Spacing (s)	Start Location (s)
1	2	8M	50.8u	1.048m	-	635.9m
2	2	8M	70.8u	1.468m	-	352.0m
3	3	8M	68.7u	1.131m	1.113m	508.5m
4	3	8M	84.0u	960.0u	1.557m	350.7m
5	1	8M	84.2u	-	-	566.7m
6	1	8M	87.3u	-	-	579.0m
7	2	8M	73.0u	1.901m	-	701.4m
8	2	8M	91.1u	1.679m	-	488.0m
9	2	8M	51.0u	1.246m	-	601.8m
10	2	8M	95.4u	1.222m	-	729.3m
11	1	8M	56.7u	-	-	201.7m
12	2	8M	98.1u	1.743m	-	373.6m
13	2	8M	94.0u	1.634m	-	611.5m
14	3	8M	69.7u	1.922m	1.481m	560.7m
15	1	8M	63.3u	-	-	463.6m
16	3	8M	96.1u	964.9u	1.369m	190.4m

Long Pulse Radar Test Signal						
Test Signal Name: LP_Signal_13						
Number of Bursts in Trial: 13						
Chrip Center Frequency: 5499MHz						
Burst	Pulses per Burst	Chrip (Hz)	Pulse Width (s)	Pulse 1 to 2 Spacing (s)	Pulse 2 to 3 Spacing (s)	Start Location (s)
1	2	9M	61.5u	955.5u	-	640.4m
2	1	9M	92.5u	-	-	393.8m
3	3	9M	71.1u	1.724m	1.483m	227.5m
4	2	9M	79.5u	1.035m	-	625.6m
5	2	9M	75.3u	1.324m	-	302.7m
6	3	9M	71.1u	1.201m	1.880m	210.6m
7	2	9M	83.2u	1.845m	-	576.6m
8	2	9M	81.1u	1.333m	-	524.0m
9	2	9M	97.7u	1.050m	-	855.4m
10	2	9M	95.7u	1.224m	-	597.8m
11	2	9M	53.5u	1.334m	-	874.0m
12	3	9M	70.8u	1.735m	1.020m	510.2m
13	2	9M	95.7u	1.535m	-	870.2m

Long Pulse Radar Test Signal						
Test Signal Name: LP_Signal_14						
Number of Bursts in Trial: 10						
Chrip Center Frequency: 5498MHz						
Burst	Pulses per Burst	Chrip (Hz)	Pulse Width (s)	Pulse 1 to 2 Spacing (s)	Pulse 2 to 3 Spacing (s)	Start Location (s)
1	2	10M	77.1u	1.267m	-	774.1m
2	3	10M	99.8u	1.558m	1.032m	769.0m
3	2	10M	73.2u	1.204m	-	760.7m
4	3	10M	74.0u	1.642m	1.403m	202.1m
5	2	10M	61.7u	982.3u	-	236.2m
6	2	10M	68.4u	1.120m	-	889.3m
7	2	10M	98.4u	1.604m	-	192.4m
8	2	10M	72.5u	1.756m	-	721.2m
9	3	10M	52.4u	1.480m	1.691m	405.5m
10	3	10M	96.6u	1.397m	1.029m	235.6m

Long Pulse Radar Test Signal						
Test Signal Name: LP_Signal_15						
Number of Bursts in Trial: 19						
Chrip Center Frequency: 5502MHz						
Burst	Pulses per Burst	Chrip (Hz)	Pulse Width (s)	Pulse 1 to 2 Spacing (s)	Pulse 2 to 3 Spacing (s)	Start Location (s)
1	1	11M	83.2u	-	-	45.94m
2	2	11M	64.2u	1.124m	-	371.8m
3	2	11M	93.6u	1.066m	-	35.45m
4	2	11M	81.4u	1.900m	-	379.4m
5	2	11M	72.5u	1.373m	-	425.9m
6	2	11M	63.2u	1.827m	-	395.1m
7	3	11M	78.0u	1.366m	1.019m	157.6m
8	1	11M	70.4u	-	-	237.3m
9	3	11M	62.4u	1.269m	1.701m	582.7m
10	1	11M	85.8u	-	-	223.0m
11	3	11M	57.4u	1.075m	1.909m	626.8m
12	2	11M	66.5u	1.637m	-	578.6m
13	3	11M	52.8u	1.165m	1.623m	626.6m
14	3	11M	51.0u	1.021m	1.068m	482.0m
15	1	11M	52.0u	-	-	471.8m
16	2	11M	72.0u	1.694m	-	284.8m
17	2	11M	58.9u	1.920m	-	155.7m
18	3	11M	84.2u	1.879m	1.077m	352.7m
19	2	11M	51.5u	1.504m	-	605.5m

Long Pulse Radar Test Signal						
Test Signal Name: LP_Signal_16						
Number of Bursts in Trial: 15						
Chrip Center Frequency: 5503MHz						
Burst	Pulses per Burst	Chrip (Hz)	Pulse Width (s)	Pulse 1 to 2 Spacing (s)	Pulse 2 to 3 Spacing (s)	Start Location (s)
1	2	12M	81.6u	1.612m	-	637.0m
2	3	12M	90.9u	1.408m	1.477m	341.8m
3	3	12M	80.3u	1.062m	1.686m	433.0m
4	2	12M	75.5u	1.727m	-	214.7m
5	1	12M	60.4u	-	-	485.5m
6	2	12M	66.3u	1.927m	-	87.10m
7	2	12M	64.0u	1.316m	-	184.3m
8	1	12M	75.3u	-	-	392.1m
9	2	12M	99.4u	1.005m	-	9.492m
10	2	12M	68.8u	1.053m	-	492.9m
11	2	12M	87.1u	1.357m	-	641.1m
12	2	12M	58.8u	1.074m	-	519.2m
13	2	12M	58.6u	1.788m	-	219.9m
14	3	12M	99.7u	1.593m	1.282m	157.8m
15	3	12M	72.4u	1.515m	1.350m	755.6m

Long Pulse Radar Test Signal						
Test Signal Name: LP_Signal_17						
Number of Bursts in Trial: 20						
Chrip Center Frequency: 5497MHz						
Burst	Pulses per Burst	Chrip (Hz)	Pulse Width (s)	Pulse 1 to 2 Spacing (s)	Pulse 2 to 3 Spacing (s)	Start Location (s)
1	1	14M	62.6u	-	-	490.6m
2	1	14M	81.6u	-	-	556.2m
3	3	14M	65.5u	1.035m	1.815m	192.5m
4	2	14M	50.7u	1.570m	-	236.9m
5	2	14M	53.9u	1.924m	-	242.5m
6	2	14M	53.2u	1.547m	-	191.2m
7	2	14M	58.9u	1.657m	-	298.6m
8	2	14M	82.0u	1.601m	-	145.5m
9	2	14M	97.4u	1.696m	-	391.6m
10	2	14M	85.8u	1.322m	-	341.4m
11	2	14M	61.7u	1.848m	-	148.0m
12	3	14M	74.1u	1.325m	1.359m	358.1m
13	2	14M	68.5u	1.757m	-	90.44m
14	2	14M	63.9u	1.411m	-	12.42m
15	1	14M	81.0u	-	-	556.0m
16	3	14M	52.8u	1.265m	1.240m	269.4m
17	2	14M	53.5u	1.069m	-	141.3m
18	1	14M	84.6u	-	-	208.6m
19	2	14M	61.3u	1.361m	-	188.0m
20	1	14M	75.5u	-	-	379.3m

Long Pulse Radar Test Signal						
Test Signal Name: LP_Signal_18						
Number of Bursts in Trial: 19						
Chrip Center Frequency: 5496MHz						
Burst	Pulses per Burst	Chrip (Hz)	Pulse Width (s)	Pulse 1 to 2 Spacing (s)	Pulse 2 to 3 Spacing (s)	Start Location (s)
1	3	16M	57.4u	1.310m	1.063m	263.4m
2	3	16M	53.6u	1.063m	1.123m	239.3m
3	3	16M	82.4u	1.425m	1.371m	434.0m
4	2	16M	83.1u	1.514m	-	308.5m
5	3	16M	89.8u	1.210m	1.455m	259.5m
6	2	16M	95.6u	1.397m	-	66.09m
7	2	16M	70.5u	1.045m	-	558.6m
8	2	16M	89.0u	1.309m	-	92.83m
9	1	16M	83.7u	-	-	524.2m
10	3	16M	93.5u	1.004m	1.611m	438.4m
11	2	16M	54.3u	1.632m	-	338.8m
12	1	16M	72.4u	-	-	84.23m
13	3	16M	72.1u	1.064m	1.337m	270.5m
14	2	16M	77.9u	1.844m	-	230.5m
15	2	16M	89.1u	1.282m	-	173.5m
16	2	16M	70.0u	1.089m	-	189.6m
17	3	16M	87.1u	1.138m	1.322m	348.7m
18	1	16M	56.9u	-	-	486.2m
19	3	16M	79.4u	1.267m	1.580m	285.8m

Long Pulse Radar Test Signal						
Test Signal Name: LP_Signal_19						
Number of Bursts in Trial: 14						
Chrip Center Frequency: 5504MHz						
Burst	Pulses per Burst	Chrip (Hz)	Pulse Width (s)	Pulse 1 to 2 Spacing (s)	Pulse 2 to 3 Spacing (s)	Start Location (s)
1	2	19M	57.4u	1.572m	-	817.2m
2	3	19M	74.9u	1.651m	1.525m	728.1m
3	2	19M	61.0u	1.735m	-	456.8m
4	1	19M	51.0u	-	-	705.2m
5	1	19M	70.9u	-	-	416.2m
6	1	19M	74.4u	-	-	137.3m
7	2	19M	96.1u	1.248m	-	252.5m
8	2	19M	62.4u	1.425m	-	346.7m
9	3	19M	83.2u	1.202m	1.002m	4.653m
10	2	19M	75.3u	1.397m	-	392.0m
11	2	19M	59.8u	1.393m	-	455.0m
12	2	19M	59.2u	1.897m	-	349.0m
13	2	19M	84.7u	1.796m	-	755.0m
14	2	19M	61.9u	1.149m	-	413.6m

Long Pulse Radar Test Signal
 Test Signal Name: LP_Signal_20
 Number of Bursts in Trial: 10
 Chrip Center Frequency: 5505MHz

Burst	Pulses per Burst	Chrip (Hz)	Pulse Width (s)	Pulse 1 to 2 Spacing (s)	Pulse 2 to 3 Spacing (s)	Start Location (s)
1	2	20M	78.6u	1.551m	-	833.2m
2	2	20M	51.6u	990.4u	-	825.2m
3	2	20M	86.8u	1.097m	-	809.6m
4	1	20M	60.5u	-	-	792.9m
5	2	20M	54.9u	1.783m	-	491.4m
6	2	20M	75.7u	1.245m	-	717.7m
7	2	20M	55.0u	1.513m	-	1.155
8	2	20M	79.2u	955.8u	-	118.6m
9	1	20M	56.4u	-	-	881.1m
10	1	20M	97.7u	-	-	978.0m

Long Pulse Radar Test Signal						
Test Signal Name: LP_Signal_21						
Number of Bursts in Trial: 16						
Chrip Center Frequency: 5509MHz						
Burst	Pulses per Burst	Chrip (Hz)	Pulse Width (s)	Pulse 1 to 2 Spacing (s)	Pulse 2 to 3 Spacing (s)	Start Location (s)
1	1	5M	59.2u	-	-	243.0m
2	2	5M	94.5u	1.834m	-	299.3m
3	2	5M	95.4u	1.641m	-	566.0m
4	3	5M	59.5u	1.313m	1.332m	354.8m
5	2	5M	62.1u	1.158m	-	618.4m
6	3	5M	73.9u	1.671m	1.534m	629.7m
7	2	5M	50.4u	1.155m	-	384.7m
8	3	5M	62.7u	1.675m	1.571m	94.54m
9	1	5M	52.4u	-	-	45.93m
10	3	5M	55.9u	1.743m	1.537m	37.45m
11	2	5M	62.1u	1.725m	-	173.9m
12	3	5M	65.1u	1.567m	1.369m	549.6m
13	3	5M	80.3u	1.548m	1.117m	530.8m
14	2	5M	85.5u	1.063m	-	265.8m
15	3	5M	54.7u	1.134m	1.657m	49.43m
16	2	5M	85.8u	1.450m	-	382.0m

Long Pulse Radar Test Signal						
Test Signal Name: LP_Signal_22						
Number of Bursts in Trial: 15						
Chrip Center Frequency: 5509MHz						
Burst	Pulses per Burst	Chrip (Hz)	Pulse Width (s)	Pulse 1 to 2 Spacing (s)	Pulse 2 to 3 Spacing (s)	Start Location (s)
1	2	6M	69.2u	1.314m	-	24.08m
2	3	6M	64.8u	1.728m	1.057m	468.8m
3	3	6M	97.6u	1.542m	1.791m	197.1m
4	3	6M	74.6u	1.066m	1.733m	470.1m
5	2	6M	78.7u	1.223m	-	523.8m
6	2	6M	78.2u	930.8u	-	323.8m
7	3	6M	60.3u	1.747m	1.339m	682.0m
8	1	6M	54.2u	-	-	657.6m
9	3	6M	69.4u	1.235m	1.540m	17.13m
10	2	6M	85.5u	1.758m	-	498.6m
11	1	6M	58.0u	-	-	119.2m
12	3	6M	98.7u	1.490m	1.164m	172.5m
13	3	6M	81.0u	1.132m	1.051m	464.7m
14	2	6M	76.7u	1.635m	-	297.3m
15	2	6M	98.0u	990.0u	-	373.7m

Long Pulse Radar Test Signal						
Test Signal Name: LP_Signal_23						
Number of Bursts in Trial: 14						
Chrip Center Frequency: 5509MHz						
Burst	Pulses per Burst	Chrip (Hz)	Pulse Width (s)	Pulse 1 to 2 Spacing (s)	Pulse 2 to 3 Spacing (s)	Start Location (s)
1	3	7M	62.7u	1.678m	1.717m	280.1m
2	2	7M	77.5u	1.567m	-	308.4m
3	1	7M	98.3u	-	-	380.5m
4	2	7M	85.2u	1.831m	-	205.0m
5	3	7M	91.8u	1.520m	947.2u	688.8m
6	1	7M	91.4u	-	-	69.25m
7	2	7M	76.1u	1.384m	-	699.5m
8	2	7M	68.2u	1.336m	-	142.5m
9	1	7M	87.0u	-	-	439.3m
10	2	7M	85.3u	1.230m	-	171.5m
11	2	7M	75.6u	1.213m	-	309.9m
12	3	7M	82.8u	1.743m	1.125m	450.3m
13	2	7M	74.3u	1.667m	-	190.8m
14	1	7M	77.4u	-	-	385.5m

Long Pulse Radar Test Signal						
Test Signal Name: LP_Signal_24						
Number of Bursts in Trial: 14						
Chrip Center Frequency: 5508MHz						
Burst	Pulses per Burst	Chrip (Hz)	Pulse Width (s)	Pulse 1 to 2 Spacing (s)	Pulse 2 to 3 Spacing (s)	Start Location (s)
1	1	8M	63.5u	-	-	839.9m
2	3	8M	97.5u	1.416m	925.5u	48.28m
3	1	8M	91.8u	-	-	752.4m
4	1	8M	86.5u	-	-	143.7m
5	2	8M	71.1u	1.545m	-	601.8m
6	1	8M	82.8u	-	-	148.8m
7	1	8M	64.4u	-	-	386.1m
8	1	8M	53.6u	-	-	560.5m
9	1	8M	98.6u	-	-	725.7m
10	3	8M	85.5u	1.115m	1.136m	119.7m
11	1	8M	100.0u	-	-	278.8m
12	3	8M	87.8u	946.2u	1.112m	177.8m
13	2	8M	61.9u	1.555m	-	393.5m
14	3	8M	86.5u	1.084m	1.587m	38.97m

Long Pulse Radar Test Signal						
Test Signal Name: LP_Signal_25						
Number of Bursts in Trial: 13						
Chrip Center Frequency: 5507MHz						
Burst	Pulses per Burst	Chrip (Hz)	Pulse Width (s)	Pulse 1 to 2 Spacing (s)	Pulse 2 to 3 Spacing (s)	Start Location (s)
1	2	9M	57.9u	1.841m	-	422.7m
2	1	9M	69.6u	-	-	132.7m
3	3	9M	82.1u	1.128m	1.462m	793.5m
4	2	9M	93.4u	1.042m	-	520.9m
5	1	9M	64.5u	-	-	298.1m
6	3	9M	90.7u	1.633m	1.340m	663.6m
7	2	9M	59.5u	1.173m	-	23.35m
8	2	9M	98.2u	1.173m	-	471.2m
9	3	9M	89.6u	1.013m	999.4u	847.1m
10	2	9M	50.2u	1.240m	-	78.02m
11	1	9M	68.5u	-	-	52.96m
12	3	9M	97.3u	1.125m	1.776m	279.1m
13	3	9M	72.8u	1.805m	1.181m	911.6m

Long Pulse Radar Test Signal						
Test Signal Name: LP_Signal_26						
Number of Bursts in Trial: 11						
Chrip Center Frequency: 5507MHz						
Burst	Pulses per Burst	Chrip (Hz)	Pulse Width (s)	Pulse 1 to 2 Spacing (s)	Pulse 2 to 3 Spacing (s)	Start Location (s)
1	1	10M	91.0u	-	-	152.9m
2	1	10M	88.7u	-	-	731.5m
3	2	10M	77.2u	1.762m	-	910.5m
4	3	10M	81.6u	1.863m	1.496m	573.3m
5	3	10M	72.9u	986.1u	1.444m	11.51m
6	3	10M	73.5u	1.347m	1.641m	1.025
7	2	10M	50.4u	1.230m	-	94.46m
8	1	10M	51.6u	-	-	676.8m
9	2	10M	66.0u	1.122m	-	678.5m
10	1	10M	62.5u	-	-	504.3m
11	2	10M	67.9u	1.085m	-	1.058

Long Pulse Radar Test Signal						
Test Signal Name: LP_Signal_27						
Number of Bursts in Trial: 19						
Chrip Center Frequency: 5507MHz						
Burst	Pulses per Burst	Chrip (Hz)	Pulse Width (s)	Pulse 1 to 2 Spacing (s)	Pulse 2 to 3 Spacing (s)	Start Location (s)
1	3	11M	96.5u	1.829m	1.187m	257.3m
2	2	11M	99.8u	1.404m	-	484.9m
3	1	11M	84.9u	-	-	565.7m
4	1	11M	95.1u	-	-	204.2m
5	1	11M	81.9u	-	-	476.5m
6	2	11M	50.6u	1.513m	-	616.8m
7	3	11M	63.5u	1.643m	1.618m	483.6m
8	2	11M	72.0u	1.002m	-	339.2m
9	2	11M	60.6u	1.103m	-	26.51m
10	1	11M	82.4u	-	-	82.69m
11	2	11M	95.3u	1.615m	-	38.81m
12	2	11M	68.5u	1.465m	-	300.5m
13	2	11M	92.6u	1.379m	-	138.3m
14	1	11M	93.4u	-	-	357.2m
15	2	11M	61.8u	1.082m	-	257.1m
16	2	11M	96.0u	1.679m	-	471.1m
17	1	11M	66.4u	-	-	566.1m
18	2	11M	77.8u	1.409m	-	107.1m
19	1	11M	79.0u	-	-	395.6m

Long Pulse Radar Test Signal						
Test Signal Name: LP_Signal_28						
Number of Bursts in Trial: 12						
Chrip Center Frequency: 5506MHz						
Burst	Pulses per Burst	Chrip (Hz)	Pulse Width (s)	Pulse 1 to 2 Spacing (s)	Pulse 2 to 3 Spacing (s)	Start Location (s)
1	1	13M	98.7u	-	-	633.0m
2	1	13M	57.3u	-	-	438.3m
3	3	13M	68.6u	1.493m	1.610m	875.1m
4	2	13M	97.5u	1.612m	-	685.6m
5	1	13M	55.5u	-	-	747.3m
6	2	13M	62.8u	967.2u	-	788.4m
7	2	13M	80.7u	1.417m	-	652.7m
8	1	13M	65.9u	-	-	782.6m
9	3	13M	79.9u	1.732m	1.557m	410.0m
10	2	13M	76.4u	1.761m	-	78.51m
11	1	13M	58.1u	-	-	580.4m
12	2	13M	78.0u	961.0u	-	162.0m

Long Pulse Radar Test Signal						
Test Signal Name: LP_Signal_29						
Number of Bursts in Trial: 11						
Chrip Center Frequency: 5505MHz						
Burst	Pulses per Burst	Chrip (Hz)	Pulse Width (s)	Pulse 1 to 2 Spacing (s)	Pulse 2 to 3 Spacing (s)	Start Location (s)
1	1	15M	84.4u	-	-	558.9m
2	2	15M	74.4u	1.227m	-	40.96m
3	3	15M	59.9u	1.513m	1.461m	466.4m
4	1	15M	54.6u	-	-	934.1m
5	2	15M	56.2u	1.306m	-	791.5m
6	2	15M	80.1u	1.693m	-	378.4m
7	2	15M	50.2u	1.675m	-	844.0m
8	2	15M	89.6u	1.641m	-	762.8m
9	1	15M	81.8u	-	-	133.1m
10	1	15M	89.0u	-	-	56.12m
11	1	15M	62.1u	-	-	784.8m

Long Pulse Radar Test Signal						
Test Signal Name: LP_Signal_30						
Number of Bursts in Trial: 10						
Chrip Center Frequency: 5504MHz						
Burst	Pulses per Burst	Chrip (Hz)	Pulse Width (s)	Pulse 1 to 2 Spacing (s)	Pulse 2 to 3 Spacing (s)	Start Location (s)
1	1	18M	91.4u	-	-	1.193
2	2	18M	59.0u	1.416m	-	691.9m
3	3	18M	75.5u	1.576m	1.710m	949.0m
4	3	18M	57.2u	1.495m	1.274m	98.67m
5	2	18M	86.9u	1.499m	-	1.077
6	3	18M	59.2u	1.913m	1.856m	327.0m
7	1	18M	79.4u	-	-	681.2m
8	3	18M	98.1u	1.764m	1.499m	780.6m
9	2	18M	79.1u	1.785m	-	22.12m
10	3	18M	75.5u	1.187m	1.373m	229.5m

Type 6 Radar Statistical Performances				
Trial #	Pulses per Burst	Pulse Width (s)	PRI (s)	Detection
1	9	1.0u	333.0u	Yes
2	9	1.0u	333.0u	Yes
3	9	1.0u	333.0u	Yes
4	9	1.0u	333.0u	Yes
5	9	1.0u	333.0u	Yes
6	9	1.0u	333.0u	Yes
7	9	1.0u	333.0u	Yes
8	9	1.0u	333.0u	Yes
9	9	1.0u	333.0u	Yes
10	9	1.0u	333.0u	Yes
11	9	1.0u	333.0u	Yes
12	9	1.0u	333.0u	Yes
13	9	1.0u	333.0u	Yes
14	9	1.0u	333.0u	Yes
15	9	1.0u	333.0u	Yes
16	9	1.0u	333.0u	Yes
17	9	1.0u	333.0u	Yes
18	9	1.0u	333.0u	Yes
19	9	1.0u	333.0u	Yes
20	9	1.0u	333.0u	Yes
21	9	1.0u	333.0u	Yes
22	9	1.0u	333.0u	Yes
23	9	1.0u	333.0u	Yes
24	9	1.0u	333.0u	Yes
25	9	1.0u	333.0u	Yes
26	9	1.0u	333.0u	Yes
27	9	1.0u	333.0u	Yes
28	9	1.0u	333.0u	Yes
29	9	1.0u	333.0u	Yes
30	9	1.0u	333.0u	Yes
			Detection Rate: 100.0 %	

Type 6 Radar Statistical Performances		
Trial #	Hopping Frequency Sequence Name	Detection
1	HOP_FREQ_SEQ_01	Yes
2	HOP_FREQ_SEQ_02	Yes
3	HOP_FREQ_SEQ_03	Yes
4	HOP_FREQ_SEQ_04	Yes
5	HOP_FREQ_SEQ_05	Yes
6	HOP_FREQ_SEQ_06	Yes
7	HOP_FREQ_SEQ_07	Yes
8	HOP_FREQ_SEQ_08	Yes
9	HOP_FREQ_SEQ_09	Yes
10	HOP_FREQ_SEQ_10	Yes
11	HOP_FREQ_SEQ_11	Yes
12	HOP_FREQ_SEQ_12	Yes
13	HOP_FREQ_SEQ_13	Yes
14	HOP_FREQ_SEQ_14	Yes
15	HOP_FREQ_SEQ_15	Yes
16	HOP_FREQ_SEQ_16	Yes
17	HOP_FREQ_SEQ_17	Yes
18	HOP_FREQ_SEQ_18	Yes
19	HOP_FREQ_SEQ_19	Yes
20	HOP_FREQ_SEQ_20	Yes
21	HOP_FREQ_SEQ_21	Yes
22	HOP_FREQ_SEQ_22	Yes
23	HOP_FREQ_SEQ_23	Yes
24	HOP_FREQ_SEQ_24	Yes
25	HOP_FREQ_SEQ_25	Yes
26	HOP_FREQ_SEQ_26	Yes
27	HOP_FREQ_SEQ_27	Yes
28	HOP_FREQ_SEQ_28	Yes
29	HOP_FREQ_SEQ_29	Yes
30	HOP_FREQ_SEQ_30	Yes
		Detection Rate: 100.0 %

Hopping Frequency Sequence Name: HOP_FREQ_SEQ_01							
SEQ#	Frequency (Hz)	SEQ#	Frequency (Hz)	SEQ#	Frequency (Hz)	SEQ#	Frequency (Hz)
1	5.594G	2	5.685G	3	5.361G	4	5.582G
5	5.699G	6	5.598G	7	5.352G	8	5.301G
9	5.658G	10	5.311G	11	5.696G	12	5.278G
13	5.529G	14	5.462G	15	5.313G	16	5.655G
17	5.523G	18	5.390G	19	5.282G	20	5.273G
21	5.339G	22	5.595G	23	5.434G	24	5.300G
25	5.351G	26	5.617G	27	5.250G	28	5.436G
29	5.605G	30	5.508G	31	5.307G	32	5.636G
33	5.294G	34	5.401G	35	5.601G	36	5.460G
37	5.587G	38	5.324G	39	5.314G	40	5.349G
41	5.654G	42	5.576G	43	5.432G	44	5.413G
45	5.538G	46	5.336G	47	5.378G	48	5.702G
49	5.542G	50	5.417G	51	5.723G	52	5.374G
53	5.535G	54	5.485G	55	5.302G	56	5.635G
57	5.384G	58	5.503G	59	5.387G	60	5.575G
61	5.465G	62	5.297G	63	5.440G	64	5.602G
65	5.691G	66	5.715G	67	5.565G	68	5.579G
69	5.698G	70	5.500G	71	5.252G	72	5.649G
73	5.272G	74	5.589G	75	5.711G	76	5.712G
77	5.359G	78	5.592G	79	5.624G	80	5.671G
81	5.545G	82	5.402G	83	5.445G	84	5.514G
85	5.549G	86	5.291G	87	5.317G	88	5.299G
89	5.501G	90	5.554G	91	5.293G	92	5.285G
93	5.546G	94	5.253G	95	5.379G	96	5.551G
97	5.350G	98	5.550G	99	5.447G	100	5.358G

Hopping Frequency Sequence Name: HOP_FREQ_SEQ_02							
SEQ#	Frequency (Hz)	SEQ#	Frequency (Hz)	SEQ#	Frequency (Hz)	SEQ#	Frequency (Hz)
1	5.376G	2	5.709G	3	5.610G	4	5.380G
5	5.421G	6	5.506G	7	5.294G	8	5.373G
9	5.669G	10	5.716G	11	5.589G	12	5.307G
13	5.429G	14	5.651G	15	5.275G	16	5.478G
17	5.720G	18	5.667G	19	5.272G	20	5.534G
21	5.629G	22	5.405G	23	5.447G	24	5.543G
25	5.495G	26	5.279G	27	5.719G	28	5.444G
29	5.578G	30	5.512G	31	5.408G	32	5.250G
33	5.263G	34	5.372G	35	5.295G	36	5.433G
37	5.445G	38	5.586G	39	5.609G	40	5.381G
41	5.661G	42	5.655G	43	5.469G	44	5.273G
45	5.497G	46	5.717G	47	5.356G	48	5.611G
49	5.422G	50	5.439G	51	5.620G	52	5.260G
53	5.350G	54	5.282G	55	5.666G	56	5.701G
57	5.575G	58	5.633G	59	5.472G	60	5.367G
61	5.454G	62	5.416G	63	5.508G	64	5.340G
65	5.718G	66	5.561G	67	5.283G	68	5.274G
69	5.514G	70	5.568G	71	5.361G	72	5.605G
73	5.715G	74	5.639G	75	5.576G	76	5.658G
77	5.379G	78	5.300G	79	5.482G	80	5.311G
81	5.265G	82	5.501G	83	5.523G	84	5.480G
85	5.479G	86	5.722G	87	5.335G	88	5.359G
89	5.413G	90	5.425G	91	5.516G	92	5.532G
93	5.407G	94	5.343G	95	5.419G	96	5.703G
97	5.711G	98	5.527G	99	5.695G	100	5.546G

Hopping Frequency Sequence Name: HOP_FREQ_SEQ_03							
SEQ#	Frequency (Hz)	SEQ#	Frequency (Hz)	SEQ#	Frequency (Hz)	SEQ#	Frequency (Hz)
1	5.357G	2	5.382G	3	5.464G	4	5.556G
5	5.456G	6	5.458G	7	5.300G	8	5.616G
9	5.582G	10	5.499G	11	5.618G	12	5.402G
13	5.250G	14	5.684G	15	5.620G	16	5.723G
17	5.265G	18	5.379G	19	5.632G	20	5.486G
21	5.606G	22	5.496G	23	5.507G	24	5.411G
25	5.598G	26	5.435G	27	5.587G	28	5.373G
29	5.381G	30	5.344G	31	5.672G	32	5.480G
33	5.455G	34	5.296G	35	5.715G	36	5.409G
37	5.371G	38	5.539G	39	5.336G	40	5.557G
41	5.506G	42	5.254G	43	5.669G	44	5.405G
45	5.420G	46	5.714G	47	5.528G	48	5.701G
49	5.363G	50	5.626G	51	5.438G	52	5.542G
53	5.685G	54	5.568G	55	5.599G	56	5.595G
57	5.299G	58	5.580G	59	5.416G	60	5.372G
61	5.312G	62	5.629G	63	5.561G	64	5.393G
65	5.307G	66	5.313G	67	5.414G	68	5.417G
69	5.696G	70	5.719G	71	5.690G	72	5.627G
73	5.617G	74	5.636G	75	5.404G	76	5.593G
77	5.678G	78	5.399G	79	5.491G	80	5.304G
81	5.643G	82	5.608G	83	5.392G	84	5.263G
85	5.589G	86	5.466G	87	5.425G	88	5.553G
89	5.707G	90	5.453G	91	5.332G	92	5.590G
93	5.594G	94	5.272G	95	5.328G	96	5.708G
97	5.449G	98	5.298G	99	5.348G	100	5.365G

Hopping Frequency Sequence Name: HOP_FREQ_SEQ_04							
SEQ#	Frequency (Hz)	SEQ#	Frequency (Hz)	SEQ#	Frequency (Hz)	SEQ#	Frequency (Hz)
1	5.665G	2	5.500G	3	5.273G	4	5.495G
5	5.656G	6	5.481G	7	5.396G	8	5.355G
9	5.567G	10	5.431G	11	5.337G	12	5.473G
13	5.504G	14	5.320G	15	5.520G	16	5.685G
17	5.574G	18	5.638G	19	5.477G	20	5.306G
21	5.357G	22	5.255G	23	5.679G	24	5.258G
25	5.720G	26	5.564G	27	5.523G	28	5.696G
29	5.445G	30	5.290G	31	5.503G	32	5.681G
33	5.310G	34	5.446G	35	5.385G	36	5.551G
37	5.578G	38	5.279G	39	5.457G	40	5.430G
41	5.484G	42	5.657G	43	5.558G	44	5.518G
45	5.709G	46	5.492G	47	5.552G	48	5.597G
49	5.710G	50	5.527G	51	5.605G	52	5.266G
53	5.331G	54	5.300G	55	5.704G	56	5.667G
57	5.405G	58	5.352G	59	5.723G	60	5.269G
61	5.475G	62	5.659G	63	5.347G	64	5.555G
65	5.458G	66	5.628G	67	5.722G	68	5.646G
69	5.630G	70	5.340G	71	5.448G	72	5.391G
73	5.435G	74	5.612G	75	5.272G	76	5.314G
77	5.327G	78	5.476G	79	5.386G	80	5.381G
81	5.617G	82	5.443G	83	5.345G	84	5.607G
85	5.631G	86	5.374G	87	5.260G	88	5.261G
89	5.714G	90	5.287G	91	5.680G	92	5.451G
93	5.541G	94	5.265G	95	5.294G	96	5.399G
97	5.377G	98	5.432G	99	5.307G	100	5.707G

Hopping Frequency Sequence Name: HOP_FREQ_SEQ_05							
SEQ#	Frequency (Hz)	SEQ#	Frequency (Hz)	SEQ#	Frequency (Hz)	SEQ#	Frequency (Hz)
1	5.388G	2	5.353G	3	5.492G	4	5.545G
5	5.604G	6	5.585G	7	5.355G	8	5.720G
9	5.570G	10	5.403G	11	5.454G	12	5.258G
13	5.326G	14	5.573G	15	5.342G	16	5.562G
17	5.327G	18	5.348G	19	5.634G	20	5.499G
21	5.537G	22	5.451G	23	5.554G	24	5.260G
25	5.672G	26	5.627G	27	5.300G	28	5.712G
29	5.268G	30	5.603G	31	5.558G	32	5.387G
33	5.669G	34	5.619G	35	5.701G	36	5.504G
37	5.675G	38	5.709G	39	5.394G	40	5.589G
41	5.312G	42	5.459G	43	5.686G	44	5.599G
45	5.722G	46	5.445G	47	5.255G	48	5.270G
49	5.616G	50	5.567G	51	5.252G	52	5.430G
53	5.421G	54	5.310G	55	5.593G	56	5.569G
57	5.291G	58	5.611G	59	5.439G	60	5.356G
61	5.704G	62	5.538G	63	5.346G	64	5.607G
65	5.267G	66	5.295G	67	5.651G	68	5.527G
69	5.621G	70	5.311G	71	5.695G	72	5.697G
73	5.413G	74	5.693G	75	5.340G	76	5.673G
77	5.516G	78	5.321G	79	5.706G	80	5.333G
81	5.638G	82	5.301G	83	5.515G	84	5.389G
85	5.602G	86	5.698G	87	5.415G	88	5.369G
89	5.436G	90	5.711G	91	5.262G	92	5.650G
93	5.450G	94	5.419G	95	5.580G	96	5.282G
97	5.305G	98	5.618G	99	5.399G	100	5.581G

Hopping Frequency Sequence Name: HOP_FREQ_SEQ_06							
SEQ#	Frequency (Hz)	SEQ#	Frequency (Hz)	SEQ#	Frequency (Hz)	SEQ#	Frequency (Hz)
1	5.501G	2	5.702G	3	5.543G	4	5.629G
5	5.576G	6	5.687G	7	5.402G	8	5.504G
9	5.487G	10	5.293G	11	5.266G	12	5.562G
13	5.276G	14	5.282G	15	5.531G	16	5.535G
17	5.649G	18	5.361G	19	5.430G	20	5.529G
21	5.485G	22	5.523G	23	5.723G	24	5.471G
25	5.719G	26	5.253G	27	5.257G	28	5.414G
29	5.601G	30	5.621G	31	5.579G	32	5.600G
33	5.708G	34	5.469G	35	5.566G	36	5.552G
37	5.653G	38	5.612G	39	5.306G	40	5.557G
41	5.550G	42	5.321G	43	5.682G	44	5.415G
45	5.305G	46	5.505G	47	5.701G	48	5.433G
49	5.657G	50	5.404G	51	5.551G	52	5.545G
53	5.264G	54	5.339G	55	5.685G	56	5.442G
57	5.399G	58	5.636G	59	5.556G	60	5.525G
61	5.381G	62	5.666G	63	5.420G	64	5.389G
65	5.628G	66	5.397G	67	5.617G	68	5.400G
69	5.313G	70	5.391G	71	5.440G	72	5.615G
73	5.474G	74	5.307G	75	5.463G	76	5.611G
77	5.398G	78	5.340G	79	5.534G	80	5.330G
81	5.546G	82	5.284G	83	5.537G	84	5.625G
85	5.296G	86	5.259G	87	5.299G	88	5.401G
89	5.382G	90	5.547G	91	5.492G	92	5.518G
93	5.443G	94	5.376G	95	5.457G	96	5.473G
97	5.470G	98	5.539G	99	5.603G	100	5.290G

Hopping Frequency Sequence Name: HOP_FREQ_SEQ_07							
SEQ#	Frequency (Hz)	SEQ#	Frequency (Hz)	SEQ#	Frequency (Hz)	SEQ#	Frequency (Hz)
1	5.471G	2	5.572G	3	5.333G	4	5.307G
5	5.392G	6	5.555G	7	5.469G	8	5.531G
9	5.523G	10	5.339G	11	5.686G	12	5.538G
13	5.512G	14	5.520G	15	5.713G	16	5.621G
17	5.660G	18	5.434G	19	5.613G	20	5.430G
21	5.387G	22	5.589G	23	5.273G	24	5.385G
25	5.299G	26	5.619G	27	5.458G	28	5.563G
29	5.679G	30	5.446G	31	5.399G	32	5.321G
33	5.297G	34	5.647G	35	5.432G	36	5.668G
37	5.271G	38	5.503G	39	5.353G	40	5.290G
41	5.376G	42	5.326G	43	5.500G	44	5.675G
45	5.316G	46	5.580G	47	5.501G	48	5.677G
49	5.554G	50	5.415G	51	5.709G	52	5.498G
53	5.528G	54	5.288G	55	5.449G	56	5.630G
57	5.417G	58	5.536G	59	5.255G	60	5.639G
61	5.669G	62	5.482G	63	5.324G	64	5.591G
65	5.452G	66	5.502G	67	5.567G	68	5.542G
69	5.251G	70	5.718G	71	5.436G	72	5.695G
73	5.348G	74	5.525G	75	5.358G	76	5.466G
77	5.470G	78	5.712G	79	5.314G	80	5.394G
81	5.263G	82	5.391G	83	5.625G	84	5.483G
85	5.666G	86	5.537G	87	5.517G	88	5.653G
89	5.429G	90	5.305G	91	5.607G	92	5.298G
93	5.284G	94	5.687G	95	5.426G	96	5.623G
97	5.453G	98	5.388G	99	5.673G	100	5.608G

Hopping Frequency Sequence Name: HOP_FREQ_SEQ_08							
SEQ#	Frequency (Hz)	SEQ#	Frequency (Hz)	SEQ#	Frequency (Hz)	SEQ#	Frequency (Hz)
1	5.673G	2	5.401G	3	5.697G	4	5.716G
5	5.619G	6	5.251G	7	5.708G	8	5.499G
9	5.294G	10	5.565G	11	5.300G	12	5.593G
13	5.567G	14	5.549G	15	5.581G	16	5.598G
17	5.364G	18	5.571G	19	5.720G	20	5.589G
21	5.486G	22	5.534G	23	5.301G	24	5.569G
25	5.487G	26	5.652G	27	5.703G	28	5.586G
29	5.426G	30	5.509G	31	5.514G	32	5.525G
33	5.590G	34	5.453G	35	5.513G	36	5.685G
37	5.398G	38	5.602G	39	5.632G	40	5.377G
41	5.459G	42	5.664G	43	5.686G	44	5.408G
45	5.292G	46	5.307G	47	5.706G	48	5.387G
49	5.696G	50	5.298G	51	5.717G	52	5.721G
53	5.478G	54	5.381G	55	5.563G	56	5.468G
57	5.416G	58	5.325G	59	5.382G	60	5.680G
61	5.670G	62	5.681G	63	5.545G	64	5.316G
65	5.639G	66	5.614G	67	5.512G	68	5.419G
69	5.272G	70	5.302G	71	5.331G	72	5.659G
73	5.679G	74	5.526G	75	5.592G	76	5.576G
77	5.719G	78	5.397G	79	5.653G	80	5.551G
81	5.395G	82	5.353G	83	5.498G	84	5.405G
85	5.692G	86	5.374G	87	5.368G	88	5.434G
89	5.492G	90	5.271G	91	5.601G	92	5.273G
93	5.475G	94	5.322G	95	5.612G	96	5.350G
97	5.362G	98	5.517G	99	5.683G	100	5.712G

Hopping Frequency Sequence Name: HOP_FREQ_SEQ_09							
SEQ#	Frequency (Hz)	SEQ#	Frequency (Hz)	SEQ#	Frequency (Hz)	SEQ#	Frequency (Hz)
1	5.263G	2	5.355G	3	5.702G	4	5.382G
5	5.577G	6	5.648G	7	5.265G	8	5.516G
9	5.491G	10	5.566G	11	5.692G	12	5.363G
13	5.319G	14	5.469G	15	5.448G	16	5.507G
17	5.414G	18	5.708G	19	5.348G	20	5.644G
21	5.620G	22	5.449G	23	5.314G	24	5.674G
25	5.597G	26	5.723G	27	5.389G	28	5.509G
29	5.353G	30	5.317G	31	5.675G	32	5.392G
33	5.574G	34	5.568G	35	5.352G	36	5.659G
37	5.250G	38	5.408G	39	5.704G	40	5.681G
41	5.256G	42	5.388G	43	5.718G	44	5.466G
45	5.661G	46	5.270G	47	5.432G	48	5.683G
49	5.299G	50	5.627G	51	5.506G	52	5.343G
53	5.486G	54	5.366G	55	5.385G	56	5.406G
57	5.713G	58	5.709G	59	5.641G	60	5.714G
61	5.647G	62	5.460G	63	5.360G	64	5.544G
65	5.259G	66	5.722G	67	5.273G	68	5.457G
69	5.344G	70	5.303G	71	5.576G	72	5.498G
73	5.422G	74	5.439G	75	5.587G	76	5.454G
77	5.435G	78	5.676G	79	5.415G	80	5.285G
81	5.578G	82	5.545G	83	5.412G	84	5.624G
85	5.417G	86	5.530G	87	5.667G	88	5.338G
89	5.612G	90	5.266G	91	5.337G	92	5.476G
93	5.588G	94	5.690G	95	5.345G	96	5.482G
97	5.444G	98	5.295G	99	5.419G	100	5.426G

Hopping Frequency Sequence Name: HOP_FREQ_SEQ_10							
SEQ#	Frequency (Hz)	SEQ#	Frequency (Hz)	SEQ#	Frequency (Hz)	SEQ#	Frequency (Hz)
1	5.302G	2	5.691G	3	5.421G	4	5.695G
5	5.673G	6	5.539G	7	5.484G	8	5.367G
9	5.665G	10	5.344G	11	5.590G	12	5.321G
13	5.305G	14	5.292G	15	5.576G	16	5.718G
17	5.328G	18	5.573G	19	5.361G	20	5.331G
21	5.708G	22	5.516G	23	5.338G	24	5.629G
25	5.680G	26	5.415G	27	5.351G	28	5.264G
29	5.528G	30	5.488G	31	5.561G	32	5.541G
33	5.563G	34	5.723G	35	5.411G	36	5.591G
37	5.621G	38	5.668G	39	5.659G	40	5.623G
41	5.323G	42	5.373G	43	5.630G	44	5.538G
45	5.717G	46	5.453G	47	5.451G	48	5.520G
49	5.505G	50	5.575G	51	5.641G	52	5.554G
53	5.587G	54	5.669G	55	5.314G	56	5.420G
57	5.645G	58	5.459G	59	5.664G	60	5.329G
61	5.567G	62	5.464G	63	5.359G	64	5.706G
65	5.596G	66	5.434G	67	5.482G	68	5.313G
69	5.676G	70	5.529G	71	5.369G	72	5.504G
73	5.388G	74	5.315G	75	5.435G	76	5.483G
77	5.282G	78	5.704G	79	5.337G	80	5.307G
81	5.465G	82	5.412G	83	5.477G	84	5.372G
85	5.447G	86	5.322G	87	5.617G	88	5.707G
89	5.506G	90	5.310G	91	5.517G	92	5.527G
93	5.526G	94	5.425G	95	5.709G	96	5.386G
97	5.540G	98	5.259G	99	5.558G	100	5.345G

Hopping Frequency Sequence Name: HOP_FREQ_SEQ_11							
SEQ#	Frequency (Hz)	SEQ#	Frequency (Hz)	SEQ#	Frequency (Hz)	SEQ#	Frequency (Hz)
1	5.654G	2	5.398G	3	5.470G	4	5.660G
5	5.519G	6	5.321G	7	5.527G	8	5.513G
9	5.293G	10	5.600G	11	5.440G	12	5.302G
13	5.363G	14	5.491G	15	5.637G	16	5.450G
17	5.457G	18	5.683G	19	5.390G	20	5.535G
21	5.388G	22	5.546G	23	5.472G	24	5.534G
25	5.386G	26	5.595G	27	5.543G	28	5.394G
29	5.471G	30	5.320G	31	5.634G	32	5.458G
33	5.719G	34	5.566G	35	5.407G	36	5.677G
37	5.565G	38	5.524G	39	5.716G	40	5.681G
41	5.718G	42	5.486G	43	5.496G	44	5.709G
45	5.481G	46	5.482G	47	5.655G	48	5.572G
49	5.377G	50	5.704G	51	5.373G	52	5.528G
53	5.706G	54	5.666G	55	5.622G	56	5.614G
57	5.627G	58	5.349G	59	5.515G	60	5.422G
61	5.501G	62	5.617G	63	5.253G	64	5.281G
65	5.287G	66	5.526G	67	5.542G	68	5.673G
69	5.261G	70	5.498G	71	5.435G	72	5.480G
73	5.705G	74	5.668G	75	5.618G	76	5.536G
77	5.484G	78	5.529G	79	5.343G	80	5.374G
81	5.339G	82	5.552G	83	5.478G	84	5.475G
85	5.446G	86	5.329G	87	5.620G	88	5.447G
89	5.341G	90	5.304G	91	5.588G	92	5.591G
93	5.477G	94	5.664G	95	5.334G	96	5.357G
97	5.667G	98	5.579G	99	5.506G	100	5.412G

Hopping Frequency Sequence Name: HOP_FREQ_SEQ_12							
SEQ#	Frequency (Hz)	SEQ#	Frequency (Hz)	SEQ#	Frequency (Hz)	SEQ#	Frequency (Hz)
1	5.675G	2	5.480G	3	5.267G	4	5.630G
5	5.596G	6	5.633G	7	5.253G	8	5.317G
9	5.273G	10	5.362G	11	5.522G	12	5.594G
13	5.642G	14	5.547G	15	5.503G	16	5.672G
17	5.449G	18	5.316G	19	5.569G	20	5.555G
21	5.498G	22	5.710G	23	5.722G	24	5.682G
25	5.308G	26	5.598G	27	5.276G	28	5.495G
29	5.493G	30	5.593G	31	5.643G	32	5.377G
33	5.670G	34	5.294G	35	5.369G	36	5.714G
37	5.516G	38	5.648G	39	5.357G	40	5.621G
41	5.264G	42	5.261G	43	5.504G	44	5.392G
45	5.295G	46	5.334G	47	5.439G	48	5.305G
49	5.581G	50	5.624G	51	5.272G	52	5.297G
53	5.488G	54	5.629G	55	5.304G	56	5.368G
57	5.391G	58	5.379G	59	5.274G	60	5.263G
61	5.687G	62	5.285G	63	5.639G	64	5.347G
65	5.640G	66	5.579G	67	5.278G	68	5.705G
69	5.491G	70	5.250G	71	5.592G	72	5.344G
73	5.560G	74	5.321G	75	5.646G	76	5.563G
77	5.339G	78	5.453G	79	5.677G	80	5.507G
81	5.605G	82	5.617G	83	5.389G	84	5.462G
85	5.378G	86	5.390G	87	5.583G	88	5.469G
89	5.338G	90	5.568G	91	5.448G	92	5.329G
93	5.388G	94	5.380G	95	5.564G	96	5.418G
97	5.668G	98	5.303G	99	5.693G	100	5.404G

Hopping Frequency Sequence Name: HOP_FREQ_SEQ_13							
SEQ#	Frequency (Hz)	SEQ#	Frequency (Hz)	SEQ#	Frequency (Hz)	SEQ#	Frequency (Hz)
1	5.553G	2	5.630G	3	5.296G	4	5.685G
5	5.719G	6	5.441G	7	5.582G	8	5.386G
9	5.563G	10	5.689G	11	5.663G	12	5.610G
13	5.456G	14	5.352G	15	5.524G	16	5.586G
17	5.435G	18	5.270G	19	5.353G	20	5.534G
21	5.575G	22	5.470G	23	5.465G	24	5.671G
25	5.278G	26	5.604G	27	5.406G	28	5.475G
29	5.652G	30	5.550G	31	5.381G	32	5.443G
33	5.531G	34	5.307G	35	5.411G	36	5.634G
37	5.412G	38	5.568G	39	5.709G	40	5.626G
41	5.339G	42	5.621G	43	5.469G	44	5.327G
45	5.560G	46	5.501G	47	5.362G	48	5.314G
49	5.640G	50	5.667G	51	5.650G	52	5.710G
53	5.287G	54	5.544G	55	5.500G	56	5.617G
57	5.419G	58	5.334G	59	5.683G	60	5.533G
61	5.678G	62	5.447G	63	5.497G	64	5.715G
65	5.397G	66	5.356G	67	5.450G	68	5.658G
69	5.257G	70	5.618G	71	5.635G	72	5.696G
73	5.448G	74	5.371G	75	5.514G	76	5.579G
77	5.496G	78	5.439G	79	5.330G	80	5.250G
81	5.698G	82	5.482G	83	5.651G	84	5.564G
85	5.429G	86	5.494G	87	5.616G	88	5.676G
89	5.251G	90	5.253G	91	5.272G	92	5.644G
93	5.393G	94	5.628G	95	5.313G	96	5.665G
97	5.446G	98	5.624G	99	5.389G	100	5.484G

Hopping Frequency Sequence Name: HOP_FREQ_SEQ_14							
SEQ#	Frequency (Hz)	SEQ#	Frequency (Hz)	SEQ#	Frequency (Hz)	SEQ#	Frequency (Hz)
1	5.580G	2	5.447G	3	5.392G	4	5.691G
5	5.576G	6	5.444G	7	5.397G	8	5.477G
9	5.296G	10	5.288G	11	5.323G	12	5.608G
13	5.325G	14	5.313G	15	5.307G	16	5.350G
17	5.345G	18	5.396G	19	5.367G	20	5.648G
21	5.717G	22	5.577G	23	5.373G	24	5.401G
25	5.537G	26	5.438G	27	5.375G	28	5.689G
29	5.501G	30	5.498G	31	5.380G	32	5.439G
33	5.340G	34	5.645G	35	5.348G	36	5.636G
37	5.533G	38	5.437G	39	5.329G	40	5.291G
41	5.363G	42	5.278G	43	5.298G	44	5.255G
45	5.667G	46	5.379G	47	5.626G	48	5.354G
49	5.374G	50	5.364G	51	5.299G	52	5.552G
53	5.609G	54	5.459G	55	5.508G	56	5.516G
57	5.641G	58	5.446G	59	5.661G	60	5.700G
61	5.633G	62	5.346G	63	5.337G	64	5.642G
65	5.388G	66	5.265G	67	5.586G	68	5.435G
69	5.318G	70	5.674G	71	5.623G	72	5.594G
73	5.272G	74	5.680G	75	5.565G	76	5.721G
77	5.341G	78	5.338G	79	5.562G	80	5.409G
81	5.614G	82	5.369G	83	5.475G	84	5.544G
85	5.649G	86	5.411G	87	5.327G	88	5.651G
89	5.500G	90	5.520G	91	5.257G	92	5.551G
93	5.583G	94	5.424G	95	5.541G	96	5.723G
97	5.601G	98	5.322G	99	5.620G	100	5.557G

Hopping Frequency Sequence Name: HOP_FREQ_SEQ_15							
SEQ#	Frequency (Hz)	SEQ#	Frequency (Hz)	SEQ#	Frequency (Hz)	SEQ#	Frequency (Hz)
1	5.634G	2	5.567G	3	5.338G	4	5.557G
5	5.457G	6	5.390G	7	5.337G	8	5.443G
9	5.667G	10	5.418G	11	5.452G	12	5.349G
13	5.485G	14	5.437G	15	5.287G	16	5.377G
17	5.324G	18	5.583G	19	5.306G	20	5.578G
21	5.712G	22	5.684G	23	5.588G	24	5.343G
25	5.267G	26	5.657G	27	5.651G	28	5.496G
29	5.478G	30	5.671G	31	5.367G	32	5.462G
33	5.609G	34	5.624G	35	5.255G	36	5.332G
37	5.399G	38	5.703G	39	5.385G	40	5.545G
41	5.436G	42	5.266G	43	5.469G	44	5.560G
45	5.273G	46	5.431G	47	5.401G	48	5.600G
49	5.364G	50	5.687G	51	5.561G	52	5.625G
53	5.284G	54	5.468G	55	5.422G	56	5.376G
57	5.497G	58	5.615G	59	5.659G	60	5.523G
61	5.341G	62	5.455G	63	5.409G	64	5.479G
65	5.481G	66	5.498G	67	5.280G	68	5.704G
69	5.713G	70	5.470G	71	5.366G	72	5.356G
73	5.416G	74	5.607G	75	5.256G	76	5.454G
77	5.275G	78	5.420G	79	5.421G	80	5.627G
81	5.714G	82	5.542G	83	5.281G	84	5.289G
85	5.359G	86	5.311G	87	5.573G	88	5.645G
89	5.623G	90	5.690G	91	5.296G	92	5.465G
93	5.373G	94	5.509G	95	5.369G	96	5.282G
97	5.372G	98	5.348G	99	5.547G	100	5.681G

Hopping Frequency Sequence Name: HOP_FREQ_SEQ_16							
SEQ#	Frequency (Hz)	SEQ#	Frequency (Hz)	SEQ#	Frequency (Hz)	SEQ#	Frequency (Hz)
1	5.301G	2	5.473G	3	5.670G	4	5.364G
5	5.667G	6	5.471G	7	5.477G	8	5.508G
9	5.556G	10	5.320G	11	5.359G	12	5.558G
13	5.314G	14	5.581G	15	5.624G	16	5.656G
17	5.446G	18	5.502G	19	5.303G	20	5.361G
21	5.655G	22	5.485G	23	5.531G	24	5.406G
25	5.719G	26	5.565G	27	5.421G	28	5.657G
29	5.677G	30	5.307G	31	5.313G	32	5.537G
33	5.648G	34	5.542G	35	5.724G	36	5.689G
37	5.264G	38	5.611G	39	5.343G	40	5.405G
41	5.649G	42	5.414G	43	5.682G	44	5.325G
45	5.341G	46	5.296G	47	5.390G	48	5.614G
49	5.260G	50	5.567G	51	5.294G	52	5.444G
53	5.384G	54	5.275G	55	5.606G	56	5.460G
57	5.457G	58	5.373G	59	5.277G	60	5.713G
61	5.284G	62	5.602G	63	5.413G	64	5.478G
65	5.647G	66	5.544G	67	5.660G	68	5.626G
69	5.609G	70	5.439G	71	5.548G	72	5.358G
73	5.585G	74	5.643G	75	5.319G	76	5.597G
77	5.526G	78	5.554G	79	5.372G	80	5.493G
81	5.271G	82	5.340G	83	5.286G	84	5.506G
85	5.367G	86	5.662G	87	5.678G	88	5.467G
89	5.309G	90	5.424G	91	5.536G	92	5.632G
93	5.703G	94	5.386G	95	5.651G	96	5.570G
97	5.716G	98	5.253G	99	5.644G	100	5.491G

Hopping Frequency Sequence Name: HOP_FREQ_SEQ_17							
SEQ#	Frequency (Hz)	SEQ#	Frequency (Hz)	SEQ#	Frequency (Hz)	SEQ#	Frequency (Hz)
1	5.291G	2	5.604G	3	5.711G	4	5.721G
5	5.310G	6	5.283G	7	5.413G	8	5.623G
9	5.595G	10	5.570G	11	5.603G	12	5.338G
13	5.416G	14	5.439G	15	5.432G	16	5.523G
17	5.428G	18	5.468G	19	5.334G	20	5.656G
21	5.387G	22	5.611G	23	5.608G	24	5.385G
25	5.687G	26	5.363G	27	5.622G	28	5.682G
29	5.503G	30	5.696G	31	5.565G	32	5.336G
33	5.449G	34	5.321G	35	5.396G	36	5.300G
37	5.620G	38	5.599G	39	5.456G	40	5.673G
41	5.712G	42	5.315G	43	5.355G	44	5.613G
45	5.636G	46	5.590G	47	5.312G	48	5.557G
49	5.305G	50	5.380G	51	5.605G	52	5.384G
53	5.463G	54	5.400G	55	5.451G	56	5.643G
57	5.264G	58	5.724G	59	5.415G	60	5.640G
61	5.316G	62	5.579G	63	5.267G	64	5.375G
65	5.671G	66	5.547G	67	5.391G	68	5.318G
69	5.619G	70	5.537G	71	5.342G	72	5.271G
73	5.661G	74	5.542G	75	5.669G	76	5.710G
77	5.574G	78	5.586G	79	5.524G	80	5.378G
81	5.659G	82	5.423G	83	5.644G	84	5.258G
85	5.268G	86	5.377G	87	5.462G	88	5.529G
89	5.577G	90	5.684G	91	5.628G	92	5.648G
93	5.703G	94	5.543G	95	5.641G	96	5.531G
97	5.361G	98	5.365G	99	5.297G	100	5.362G

Hopping Frequency Sequence Name: HOP_FREQ_SEQ_18							
SEQ#	Frequency (Hz)	SEQ#	Frequency (Hz)	SEQ#	Frequency (Hz)	SEQ#	Frequency (Hz)
1	5.521G	2	5.365G	3	5.664G	4	5.548G
5	5.281G	6	5.534G	7	5.546G	8	5.276G
9	5.275G	10	5.292G	11	5.301G	12	5.597G
13	5.316G	14	5.595G	15	5.667G	16	5.641G
17	5.589G	18	5.269G	19	5.619G	20	5.611G
21	5.399G	22	5.274G	23	5.508G	24	5.333G
25	5.307G	26	5.605G	27	5.699G	28	5.604G
29	5.474G	30	5.435G	31	5.551G	32	5.693G
33	5.253G	34	5.700G	35	5.347G	36	5.405G
37	5.425G	38	5.309G	39	5.496G	40	5.343G
41	5.422G	42	5.341G	43	5.498G	44	5.433G
45	5.408G	46	5.633G	47	5.362G	48	5.639G
49	5.663G	50	5.550G	51	5.610G	52	5.487G
53	5.381G	54	5.349G	55	5.598G	56	5.657G
57	5.599G	58	5.300G	59	5.272G	60	5.383G
61	5.531G	62	5.560G	63	5.367G	64	5.417G
65	5.295G	66	5.661G	67	5.632G	68	5.557G
69	5.437G	70	5.416G	71	5.622G	72	5.704G
73	5.488G	74	5.370G	75	5.317G	76	5.583G
77	5.642G	78	5.407G	79	5.410G	80	5.715G
81	5.658G	82	5.466G	83	5.593G	84	5.532G
85	5.375G	86	5.252G	87	5.378G	88	5.578G
89	5.697G	90	5.413G	91	5.396G	92	5.293G
93	5.629G	94	5.371G	95	5.500G	96	5.411G
97	5.592G	98	5.460G	99	5.567G	100	5.288G

Hopping Frequency Sequence Name: HOP_FREQ_SEQ_19							
SEQ#	Frequency (Hz)	SEQ#	Frequency (Hz)	SEQ#	Frequency (Hz)	SEQ#	Frequency (Hz)
1	5.289G	2	5.358G	3	5.453G	4	5.440G
5	5.312G	6	5.469G	7	5.701G	8	5.292G
9	5.309G	10	5.467G	11	5.342G	12	5.695G
13	5.525G	14	5.473G	15	5.569G	16	5.529G
17	5.334G	18	5.588G	19	5.532G	20	5.592G
21	5.443G	22	5.722G	23	5.454G	24	5.508G
25	5.378G	26	5.487G	27	5.338G	28	5.496G
29	5.434G	30	5.663G	31	5.633G	32	5.531G
33	5.463G	34	5.616G	35	5.630G	36	5.333G
37	5.626G	38	5.468G	39	5.363G	40	5.279G
41	5.404G	42	5.311G	43	5.683G	44	5.416G
45	5.368G	46	5.484G	47	5.310G	48	5.702G
49	5.514G	50	5.542G	51	5.421G	52	5.268G
53	5.283G	54	5.520G	55	5.457G	56	5.438G
57	5.493G	58	5.323G	59	5.266G	60	5.331G
61	5.433G	62	5.715G	63	5.682G	64	5.582G
65	5.321G	66	5.388G	67	5.585G	68	5.330G
69	5.322G	70	5.314G	71	5.551G	72	5.365G
73	5.301G	74	5.623G	75	5.401G	76	5.370G
77	5.429G	78	5.284G	79	5.271G	80	5.672G
81	5.721G	82	5.658G	83	5.351G	84	5.361G
85	5.717G	86	5.287G	87	5.714G	88	5.606G
89	5.480G	90	5.684G	91	5.318G	92	5.693G
93	5.405G	94	5.261G	95	5.485G	96	5.417G
97	5.636G	98	5.448G	99	5.698G	100	5.295G

Hopping Frequency Sequence Name: HOP_FREQ_SEQ_20							
SEQ#	Frequency (Hz)	SEQ#	Frequency (Hz)	SEQ#	Frequency (Hz)	SEQ#	Frequency (Hz)
1	5.705G	2	5.525G	3	5.712G	4	5.547G
5	5.640G	6	5.681G	7	5.450G	8	5.352G
9	5.561G	10	5.469G	11	5.558G	12	5.674G
13	5.484G	14	5.536G	15	5.527G	16	5.444G
17	5.425G	18	5.327G	19	5.359G	20	5.570G
21	5.482G	22	5.512G	23	5.301G	24	5.330G
25	5.620G	26	5.355G	27	5.615G	28	5.318G
29	5.568G	30	5.313G	31	5.454G	32	5.552G
33	5.627G	34	5.542G	35	5.488G	36	5.545G
37	5.562G	38	5.716G	39	5.515G	40	5.508G
41	5.574G	42	5.315G	43	5.480G	44	5.294G
45	5.394G	46	5.537G	47	5.585G	48	5.328G
49	5.297G	50	5.688G	51	5.332G	52	5.581G
53	5.380G	54	5.576G	55	5.451G	56	5.284G
57	5.452G	58	5.422G	59	5.486G	60	5.507G
61	5.524G	62	5.575G	63	5.329G	64	5.283G
65	5.580G	66	5.291G	67	5.416G	68	5.643G
69	5.619G	70	5.589G	71	5.320G	72	5.711G
73	5.434G	74	5.473G	75	5.555G	76	5.504G
77	5.541G	78	5.260G	79	5.461G	80	5.350G
81	5.715G	82	5.456G	83	5.679G	84	5.676G
85	5.638G	86	5.478G	87	5.288G	88	5.277G
89	5.393G	90	5.466G	91	5.341G	92	5.386G
93	5.666G	94	5.453G	95	5.337G	96	5.358G
97	5.455G	98	5.413G	99	5.254G	100	5.414G

Hopping Frequency Sequence Name: HOP_FREQ_SEQ_21							
SEQ#	Frequency (Hz)	SEQ#	Frequency (Hz)	SEQ#	Frequency (Hz)	SEQ#	Frequency (Hz)
1	5.380G	2	5.680G	3	5.652G	4	5.398G
5	5.386G	6	5.422G	7	5.353G	8	5.369G
9	5.283G	10	5.578G	11	5.468G	12	5.405G
13	5.645G	14	5.605G	15	5.642G	16	5.312G
17	5.449G	18	5.464G	19	5.370G	20	5.383G
21	5.539G	22	5.653G	23	5.389G	24	5.570G
25	5.723G	26	5.697G	27	5.639G	28	5.598G
29	5.450G	30	5.676G	31	5.553G	32	5.257G
33	5.621G	34	5.296G	35	5.604G	36	5.366G
37	5.618G	38	5.318G	39	5.537G	40	5.626G
41	5.611G	42	5.499G	43	5.270G	44	5.359G
45	5.647G	46	5.409G	47	5.679G	48	5.686G
49	5.620G	50	5.555G	51	5.658G	52	5.334G
53	5.475G	54	5.328G	55	5.377G	56	5.674G
57	5.264G	58	5.517G	59	5.385G	60	5.254G
61	5.397G	62	5.443G	63	5.478G	64	5.584G
65	5.648G	66	5.547G	67	5.378G	68	5.687G
69	5.519G	70	5.396G	71	5.518G	72	5.597G
73	5.702G	74	5.348G	75	5.581G	76	5.567G
77	5.271G	78	5.454G	79	5.325G	80	5.573G
81	5.552G	82	5.374G	83	5.293G	84	5.544G
85	5.282G	86	5.448G	87	5.309G	88	5.612G
89	5.395G	90	5.557G	91	5.575G	92	5.323G
93	5.319G	94	5.536G	95	5.722G	96	5.387G
97	5.551G	98	5.259G	99	5.298G	100	5.582G

Hopping Frequency Sequence Name: HOP_FREQ_SEQ_22							
SEQ#	Frequency (Hz)	SEQ#	Frequency (Hz)	SEQ#	Frequency (Hz)	SEQ#	Frequency (Hz)
1	5.596G	2	5.649G	3	5.400G	4	5.522G
5	5.443G	6	5.391G	7	5.651G	8	5.535G
9	5.337G	10	5.268G	11	5.387G	12	5.587G
13	5.342G	14	5.274G	15	5.657G	16	5.351G
17	5.367G	18	5.565G	19	5.509G	20	5.523G
21	5.350G	22	5.280G	23	5.442G	24	5.584G
25	5.628G	26	5.422G	27	5.335G	28	5.372G
29	5.491G	30	5.462G	31	5.604G	32	5.363G
33	5.302G	34	5.658G	35	5.666G	36	5.578G
37	5.269G	38	5.263G	39	5.529G	40	5.308G
41	5.532G	42	5.287G	43	5.436G	44	5.528G
45	5.284G	46	5.689G	47	5.467G	48	5.665G
49	5.688G	50	5.333G	51	5.554G	52	5.722G
53	5.504G	54	5.285G	55	5.306G	56	5.551G
57	5.384G	58	5.580G	59	5.407G	60	5.361G
61	5.373G	62	5.676G	63	5.482G	64	5.347G
65	5.500G	66	5.710G	67	5.662G	68	5.623G
69	5.322G	70	5.612G	71	5.444G	72	5.429G
73	5.460G	74	5.629G	75	5.360G	76	5.313G
77	5.541G	78	5.416G	79	5.561G	80	5.619G
81	5.704G	82	5.300G	83	5.631G	84	5.611G
85	5.488G	86	5.618G	87	5.552G	88	5.250G
89	5.371G	90	5.258G	91	5.251G	92	5.633G
93	5.475G	94	5.639G	95	5.566G	96	5.632G
97	5.358G	98	5.617G	99	5.492G	100	5.498G

Hopping Frequency Sequence Name: HOP_FREQ_SEQ_23							
SEQ#	Frequency (Hz)	SEQ#	Frequency (Hz)	SEQ#	Frequency (Hz)	SEQ#	Frequency (Hz)
1	5.494G	2	5.369G	3	5.704G	4	5.580G
5	5.497G	6	5.598G	7	5.462G	8	5.435G
9	5.459G	10	5.591G	11	5.559G	12	5.495G
13	5.302G	14	5.558G	15	5.609G	16	5.306G
17	5.632G	18	5.639G	19	5.425G	20	5.702G
21	5.252G	22	5.263G	23	5.427G	24	5.330G
25	5.316G	26	5.253G	27	5.687G	28	5.266G
29	5.692G	30	5.472G	31	5.682G	32	5.708G
33	5.719G	34	5.716G	35	5.650G	36	5.717G
37	5.350G	38	5.452G	39	5.431G	40	5.429G
41	5.319G	42	5.393G	43	5.503G	44	5.620G
45	5.290G	46	5.400G	47	5.614G	48	5.312G
49	5.568G	50	5.373G	51	5.445G	52	5.636G
53	5.634G	54	5.331G	55	5.328G	56	5.483G
57	5.303G	58	5.700G	59	5.310G	60	5.505G
61	5.590G	62	5.533G	63	5.343G	64	5.711G
65	5.551G	66	5.506G	67	5.476G	68	5.407G
69	5.398G	70	5.357G	71	5.485G	72	5.292G
73	5.612G	74	5.584G	75	5.481G	76	5.694G
77	5.264G	78	5.683G	79	5.541G	80	5.475G
81	5.693G	82	5.388G	83	5.635G	84	5.555G
85	5.608G	86	5.283G	87	5.308G	88	5.493G
89	5.570G	90	5.260G	91	5.557G	92	5.411G
93	5.413G	94	5.295G	95	5.713G	96	5.507G
97	5.451G	98	5.254G	99	5.471G	100	5.709G

Hopping Frequency Sequence Name: HOP_FREQ_SEQ_24							
SEQ#	Frequency (Hz)	SEQ#	Frequency (Hz)	SEQ#	Frequency (Hz)	SEQ#	Frequency (Hz)
1	5.578G	2	5.505G	3	5.309G	4	5.599G
5	5.343G	6	5.532G	7	5.354G	8	5.671G
9	5.262G	10	5.602G	11	5.533G	12	5.250G
13	5.320G	14	5.632G	15	5.610G	16	5.308G
17	5.539G	18	5.717G	19	5.428G	20	5.707G
21	5.701G	22	5.442G	23	5.603G	24	5.375G
25	5.334G	26	5.706G	27	5.626G	28	5.702G
29	5.453G	30	5.703G	31	5.319G	32	5.478G
33	5.378G	34	5.520G	35	5.509G	36	5.447G
37	5.563G	38	5.678G	39	5.569G	40	5.346G
41	5.598G	42	5.596G	43	5.471G	44	5.680G
45	5.622G	46	5.306G	47	5.348G	48	5.468G
49	5.685G	50	5.633G	51	5.302G	52	5.665G
53	5.260G	54	5.494G	55	5.321G	56	5.480G
57	5.571G	58	5.661G	59	5.410G	60	5.394G
61	5.664G	62	5.570G	63	5.292G	64	5.630G
65	5.416G	66	5.545G	67	5.605G	68	5.639G
69	5.646G	70	5.593G	71	5.379G	72	5.648G
73	5.487G	74	5.625G	75	5.450G	76	5.301G
77	5.637G	78	5.549G	79	5.503G	80	5.564G
81	5.353G	82	5.662G	83	5.623G	84	5.565G
85	5.548G	86	5.467G	87	5.700G	88	5.445G
89	5.257G	90	5.360G	91	5.357G	92	5.543G
93	5.363G	94	5.519G	95	5.377G	96	5.463G
97	5.432G	98	5.328G	99	5.427G	100	5.281G

Hopping Frequency Sequence Name: HOP_FREQ_SEQ_25							
SEQ#	Frequency (Hz)	SEQ#	Frequency (Hz)	SEQ#	Frequency (Hz)	SEQ#	Frequency (Hz)
1	5.551G	2	5.406G	3	5.488G	4	5.357G
5	5.539G	6	5.635G	7	5.633G	8	5.518G
9	5.672G	10	5.636G	11	5.527G	12	5.450G
13	5.601G	14	5.279G	15	5.651G	16	5.641G
17	5.699G	18	5.323G	19	5.555G	20	5.274G
21	5.421G	22	5.505G	23	5.399G	24	5.674G
25	5.317G	26	5.306G	27	5.292G	28	5.609G
29	5.254G	30	5.686G	31	5.309G	32	5.537G
33	5.307G	34	5.523G	35	5.288G	36	5.632G
37	5.320G	38	5.715G	39	5.398G	40	5.335G
41	5.340G	42	5.509G	43	5.613G	44	5.458G
45	5.703G	46	5.506G	47	5.353G	48	5.375G
49	5.504G	50	5.623G	51	5.409G	52	5.516G
53	5.269G	54	5.610G	55	5.431G	56	5.554G
57	5.682G	58	5.679G	59	5.625G	60	5.696G
61	5.325G	62	5.534G	63	5.701G	64	5.478G
65	5.411G	66	5.347G	67	5.638G	68	5.430G
69	5.272G	70	5.657G	71	5.298G	72	5.700G
73	5.480G	74	5.680G	75	5.416G	76	5.376G
77	5.646G	78	5.587G	79	5.395G	80	5.514G
81	5.467G	82	5.343G	83	5.627G	84	5.316G
85	5.622G	86	5.559G	87	5.637G	88	5.541G
89	5.469G	90	5.662G	91	5.465G	92	5.466G
93	5.714G	94	5.310G	95	5.295G	96	5.337G
97	5.675G	98	5.293G	99	5.608G	100	5.558G

Hopping Frequency Sequence Name: HOP_FREQ_SEQ_26							
SEQ#	Frequency (Hz)	SEQ#	Frequency (Hz)	SEQ#	Frequency (Hz)	SEQ#	Frequency (Hz)
1	5.270G	2	5.280G	3	5.623G	4	5.597G
5	5.639G	6	5.290G	7	5.674G	8	5.438G
9	5.630G	10	5.284G	11	5.360G	12	5.389G
13	5.561G	14	5.530G	15	5.541G	16	5.604G
17	5.300G	18	5.704G	19	5.430G	20	5.564G
21	5.482G	22	5.675G	23	5.680G	24	5.590G
25	5.303G	26	5.268G	27	5.622G	28	5.508G
29	5.603G	30	5.474G	31	5.316G	32	5.497G
33	5.466G	34	5.660G	35	5.579G	36	5.450G
37	5.646G	38	5.415G	39	5.317G	40	5.707G
41	5.330G	42	5.322G	43	5.628G	44	5.484G
45	5.664G	46	5.700G	47	5.428G	48	5.371G
49	5.636G	50	5.377G	51	5.465G	52	5.481G
53	5.475G	54	5.665G	55	5.253G	56	5.591G
57	5.624G	58	5.609G	59	5.299G	60	5.440G
61	5.418G	62	5.384G	63	5.483G	64	5.582G
65	5.388G	66	5.666G	67	5.457G	68	5.708G
69	5.642G	70	5.411G	71	5.608G	72	5.627G
73	5.410G	74	5.499G	75	5.405G	76	5.544G
77	5.494G	78	5.718G	79	5.339G	80	5.442G
81	5.616G	82	5.261G	83	5.560G	84	5.373G
85	5.533G	86	5.263G	87	5.578G	88	5.509G
89	5.265G	90	5.691G	91	5.670G	92	5.369G
93	5.715G	94	5.283G	95	5.567G	96	5.407G
97	5.570G	98	5.645G	99	5.313G	100	5.306G

Hopping Frequency Sequence Name: HOP_FREQ_SEQ_27							
SEQ#	Frequency (Hz)	SEQ#	Frequency (Hz)	SEQ#	Frequency (Hz)	SEQ#	Frequency (Hz)
1	5.416G	2	5.254G	3	5.482G	4	5.523G
5	5.395G	6	5.387G	7	5.407G	8	5.685G
9	5.382G	10	5.352G	11	5.704G	12	5.721G
13	5.466G	14	5.348G	15	5.477G	16	5.540G
17	5.302G	18	5.568G	19	5.450G	20	5.521G
21	5.708G	22	5.326G	23	5.600G	24	5.411G
25	5.606G	26	5.278G	27	5.535G	28	5.616G
29	5.676G	30	5.536G	31	5.562G	32	5.662G
33	5.693G	34	5.688G	35	5.396G	36	5.461G
37	5.251G	38	5.417G	39	5.627G	40	5.598G
41	5.338G	42	5.555G	43	5.552G	44	5.362G
45	5.608G	46	5.316G	47	5.647G	48	5.397G
49	5.646G	50	5.331G	51	5.534G	52	5.250G
53	5.720G	54	5.480G	55	5.304G	56	5.611G
57	5.663G	58	5.405G	59	5.446G	60	5.700G
61	5.603G	62	5.515G	63	5.497G	64	5.341G
65	5.299G	66	5.376G	67	5.410G	68	5.545G
69	5.294G	70	5.711G	71	5.325G	72	5.285G
73	5.287G	74	5.644G	75	5.705G	76	5.690G
77	5.577G	78	5.363G	79	5.381G	80	5.588G
81	5.557G	82	5.436G	83	5.543G	84	5.378G
85	5.453G	86	5.589G	87	5.273G	88	5.615G
89	5.503G	90	5.559G	91	5.398G	92	5.621G
93	5.379G	94	5.394G	95	5.699G	96	5.619G
97	5.452G	98	5.502G	99	5.270G	100	5.255G

Hopping Frequency Sequence Name: HOP_FREQ_SEQ_28							
SEQ#	Frequency (Hz)	SEQ#	Frequency (Hz)	SEQ#	Frequency (Hz)	SEQ#	Frequency (Hz)
1	5.338G	2	5.353G	3	5.309G	4	5.401G
5	5.349G	6	5.659G	7	5.709G	8	5.679G
9	5.683G	10	5.544G	11	5.280G	12	5.382G
13	5.580G	14	5.379G	15	5.607G	16	5.551G
17	5.514G	18	5.260G	19	5.479G	20	5.714G
21	5.699G	22	5.494G	23	5.292G	24	5.316G
25	5.571G	26	5.691G	27	5.444G	28	5.655G
29	5.390G	30	5.584G	31	5.430G	32	5.393G
33	5.562G	34	5.633G	35	5.274G	36	5.368G
37	5.325G	38	5.436G	39	5.589G	40	5.472G
41	5.441G	42	5.285G	43	5.276G	44	5.478G
45	5.632G	46	5.535G	47	5.253G	48	5.581G
49	5.399G	50	5.255G	51	5.624G	52	5.715G
53	5.327G	54	5.340G	55	5.596G	56	5.323G
57	5.635G	58	5.261G	59	5.431G	60	5.331G
61	5.265G	62	5.394G	63	5.381G	64	5.626G
65	5.453G	66	5.308G	67	5.448G	68	5.582G
69	5.525G	70	5.644G	71	5.541G	72	5.687G
73	5.277G	74	5.304G	75	5.660G	76	5.618G
77	5.256G	78	5.366G	79	5.647G	80	5.565G
81	5.671G	82	5.252G	83	5.370G	84	5.496G
85	5.567G	86	5.395G	87	5.642G	88	5.588G
89	5.638G	90	5.389G	91	5.648G	92	5.458G
93	5.523G	94	5.563G	95	5.716G	96	5.597G
97	5.559G	98	5.426G	99	5.334G	100	5.534G

Hopping Frequency Sequence Name: HOP_FREQ_SEQ_29							
SEQ#	Frequency (Hz)	SEQ#	Frequency (Hz)	SEQ#	Frequency (Hz)	SEQ#	Frequency (Hz)
1	5.270G	2	5.282G	3	5.447G	4	5.316G
5	5.548G	6	5.334G	7	5.647G	8	5.576G
9	5.659G	10	5.314G	11	5.386G	12	5.345G
13	5.324G	14	5.290G	15	5.515G	16	5.597G
17	5.573G	18	5.470G	19	5.364G	20	5.712G
21	5.649G	22	5.461G	23	5.685G	24	5.320G
25	5.366G	26	5.413G	27	5.635G	28	5.411G
29	5.374G	30	5.351G	31	5.586G	32	5.286G
33	5.522G	34	5.390G	35	5.275G	36	5.349G
37	5.575G	38	5.258G	39	5.274G	40	5.662G
41	5.429G	42	5.658G	43	5.549G	44	5.449G
45	5.430G	46	5.634G	47	5.599G	48	5.695G
49	5.438G	50	5.454G	51	5.518G	52	5.384G
53	5.698G	54	5.525G	55	5.663G	56	5.672G
57	5.651G	58	5.279G	59	5.485G	60	5.631G
61	5.358G	62	5.406G	63	5.456G	64	5.622G
65	5.716G	66	5.620G	67	5.431G	68	5.460G
69	5.643G	70	5.359G	71	5.562G	72	5.288G
73	5.714G	74	5.289G	75	5.408G	76	5.572G
77	5.445G	78	5.577G	79	5.452G	80	5.371G
81	5.446G	82	5.262G	83	5.471G	84	5.656G
85	5.307G	86	5.574G	87	5.260G	88	5.362G
89	5.420G	90	5.674G	91	5.595G	92	5.629G
93	5.667G	94	5.387G	95	5.424G	96	5.709G
97	5.325G	98	5.507G	99	5.570G	100	5.513G

Hopping Frequency Sequence Name: HOP_FREQ_SEQ_30							
SEQ#	Frequency (Hz)	SEQ#	Frequency (Hz)	SEQ#	Frequency (Hz)	SEQ#	Frequency (Hz)
1	5.578G	2	5.337G	3	5.417G	4	5.700G
5	5.342G	6	5.667G	7	5.428G	8	5.415G
9	5.639G	10	5.525G	11	5.526G	12	5.533G
13	5.261G	14	5.631G	15	5.545G	16	5.577G
17	5.612G	18	5.498G	19	5.393G	20	5.574G
21	5.550G	22	5.718G	23	5.298G	24	5.520G
25	5.255G	26	5.387G	27	5.356G	28	5.444G
29	5.448G	30	5.353G	31	5.668G	32	5.402G
33	5.414G	34	5.637G	35	5.676G	36	5.363G
37	5.445G	38	5.354G	39	5.403G	40	5.267G
41	5.703G	42	5.560G	43	5.559G	44	5.680G
45	5.506G	46	5.257G	47	5.365G	48	5.317G
49	5.454G	50	5.629G	51	5.260G	52	5.543G
53	5.673G	54	5.620G	55	5.389G	56	5.627G
57	5.661G	58	5.386G	59	5.645G	60	5.373G
61	5.623G	62	5.456G	63	5.606G	64	5.289G
65	5.658G	66	5.258G	67	5.584G	68	5.446G
69	5.483G	70	5.427G	71	5.399G	72	5.457G
73	5.642G	74	5.299G	75	5.603G	76	5.552G
77	5.495G	78	5.576G	79	5.715G	80	5.652G
81	5.449G	82	5.410G	83	5.626G	84	5.651G
85	5.538G	86	5.687G	87	5.346G	88	5.250G
89	5.692G	90	5.252G	91	5.322G	92	5.632G
93	5.659G	94	5.681G	95	5.585G	96	5.426G
97	5.635G	98	5.657G	99	5.704G	100	5.297G

IEEE 802.11N 40MHz

Type 1 Radar Statistical Performances					
Trial #	Pulses per Burst	Pulse Width (s)	PRI (s)	Radar Frequency	Detection
1	102	1.0u	518.0u	5490	Yes
2	99	1.0u	538.0u	5491	Yes
3	95	1.0u	558.0u	5492	Yes
4	92	1.0u	578.0u	5493	Yes
5	89	1.0u	598.0u	5494	Yes
6	86	1.0u	618.0u	5496	Yes
7	83	1.0u	638.0u	5498	Yes
8	81	1.0u	658.0u	5500	Yes
9	78	1.0u	678.0u	5502	Yes
10	76	1.0u	698.0u	5504	Yes
11	74	1.0u	718.0u	5506	Yes
12	72	1.0u	738.0u	5507	Yes
13	70	1.0u	758.0u	5508	Yes
14	68	1.0u	778.0u	5509	Yes
15	62	1.0u	858.0u	5510	Yes
16	89	1.0u	579.0u	5511	Yes
17	71	1.0u	747.0u	5512	Yes
18	97	1.0u	549.0u	5513	Yes
19	75	1.0u	709.0u	5514	Yes
20	61	1.0u	869.0u	5515	Yes
21	75	1.0u	711.0u	5517	Yes
22	93	1.0u	573.0u	5519	Yes
23	73	1.0u	733.0u	5521	Yes
24	64	1.0u	833.0u	5523	Yes
25	58	1.0u	913.0u	5525	Yes
26	86	1.0u	615.0u	5526	Yes
27	72	1.0u	735.0u	5527	Yes
28	19	1.0u	2.853m	5528	Yes
29	78	1.0u	677.0u	5529	Yes
30	59	1.0u	897.0u	5530	Yes
					Detection Rate: 100.0 %

Type 2 Radar Statistical Performances					
Trial #	Pulses per Burst	Pulse Width (s)	PRI (s)	Radar Frequency	Detection
1	24	1.8u	180.0u	5490	Yes
2	23	4.8u	213.0u	5491	Yes
3	24	1.2u	177.0u	5492	Yes
4	27	2.4u	206.0u	5493	Yes
5	26	1.5u	153.0u	5494	Yes
6	26	1.0u	158.0u	5496	Yes
7	25	4.4u	193.0u	5498	Yes
8	27	4.9u	167.0u	5500	Yes
9	28	3.9u	197.0u	5502	Yes
10	26	3.4u	152.0u	5504	Yes
11	26	3.0u	175.0u	5506	Yes
12	25	1.1u	185.0u	5507	Yes
13	24	3.9u	174.0u	5508	Yes
14	24	1.4u	175.0u	5509	Yes
15	28	2.5u	188.0u	5510	Yes
16	24	3.8u	209.0u	5511	Yes
17	28	1.6u	200.0u	5512	Yes
18	25	1.7u	187.0u	5513	Yes
19	25	4.8u	164.0u	5514	No
20	25	2.5u	172.0u	5515	Yes
21	29	4.7u	179.0u	5517	Yes
22	26	4.1u	181.0u	5519	Yes
23	25	4.1u	223.0u	5521	Yes
24	29	1.4u	195.0u	5523	Yes
25	26	1.2u	185.0u	5525	Yes
26	26	2.8u	171.0u	5526	No
27	27	4.5u	156.0u	5527	No
28	25	1.1u	203.0u	5528	Yes
29	29	1.3u	180.0u	5529	Yes
30	28	2.4u	207.0u	5530	Yes
					Detection Rate: 90.0 %

Type 3 Radar Statistical Performances					
Trial #	Pulses per Burst	Pulse Width (s)	PRI (s)	Radar Frequency	Detection
1	17	7.6u	336.0u	5490	Yes
2	18	7.7u	499.0u	5491	Yes
3	17	7.4u	451.0u	5492	Yes
4	17	9.3u	319.0u	5493	Yes
5	17	9.1u	293.0u	5494	Yes
6	17	8.0u	403.0u	5496	Yes
7	16	9.7u	481.0u	5498	Yes
8	17	7.6u	333.0u	5500	No
9	18	8.6u	348.0u	5502	Yes
10	18	6.6u	487.0u	5504	Yes
11	17	6.4u	217.0u	5506	Yes
12	18	6.9u	472.0u	5507	Yes
13	17	9.6u	210.0u	5508	Yes
14	16	9.6u	349.0u	5509	Yes
15	16	6.1u	271.0u	5510	Yes
16	18	7.8u	306.0u	5511	Yes
17	18	9.1u	431.0u	5512	Yes
18	18	9.2u	267.0u	5513	Yes
19	18	9.0u	230.0u	5514	Yes
20	17	6.6u	363.0u	5515	Yes
21	17	8.0u	358.0u	5517	Yes
22	16	8.5u	496.0u	5519	Yes
23	16	8.5u	472.0u	5521	Yes
24	18	9.0u	392.0u	5523	Yes
25	18	9.8u	284.0u	5525	Yes
26	18	7.0u	231.0u	5526	No
27	17	8.6u	348.0u	5527	Yes
28	17	8.2u	293.0u	5528	Yes
29	17	8.9u	499.0u	5529	Yes
30	17	7.2u	264.0u	5530	Yes
					Detection Rate: 93.3 %

Type 4 Radar Statistical Performances					
Trial #	Pulses per Burst	Pulse Width (s)	PRI (s)	Radar Frequency	Detection
1	15	19.6u	390.0u	5490	Yes
2	12	12.2u	297.0u	5491	No
3	16	16.1u	379.0u	5492	Yes
4	14	12.9u	383.0u	5493	Yes
5	12	12.8u	409.0u	5494	Yes
6	16	18.7u	486.0u	5496	Yes
7	13	14.8u	490.0u	5498	Yes
8	13	12.8u	369.0u	5500	Yes
9	14	15.4u	298.0u	5502	Yes
10	14	13.8u	312.0u	5504	Yes
11	16	11.3u	472.0u	5506	Yes
12	15	16.1u	443.0u	5507	Yes
13	13	19.6u	317.0u	5508	Yes
14	14	12.4u	245.0u	5509	Yes
15	13	11.1u	277.0u	5510	Yes
16	14	16.6u	235.0u	5511	Yes
17	13	18.0u	204.0u	5512	Yes
18	16	11.8u	266.0u	5513	Yes
19	12	12.4u	318.0u	5514	Yes
20	12	14.3u	463.0u	5515	Yes
21	14	14.3u	472.0u	5517	No
22	12	15.2u	434.0u	5519	No
23	13	13.9u	395.0u	5521	No
24	13	15.0u	457.0u	5523	Yes
25	13	13.7u	335.0u	5525	No
26	14	13.2u	343.0u	5526	Yes
27	15	14.5u	387.0u	5527	Yes
28	16	11.4u	444.0u	5528	Yes
29	14	19.4u	317.0u	5529	Yes
30	16	16.4u	429.0u	5530	Yes
Detection Rate: 83.3 %					

Type 5 Radar Statistical Performances		
Trial #	Test Signal Name	Detection
1	LP_Signal_01	No
2	LP_Signal_02	Yes
3	LP_Signal_03	Yes
4	LP_Signal_04	Yes
5	LP_Signal_05	Yes
6	LP_Signal_06	Yes
7	LP_Signal_07	Yes
8	LP_Signal_08	Yes
9	LP_Signal_09	No
10	LP_Signal_10	No
11	LP_Signal_11	Yes
12	LP_Signal_12	Yes
13	LP_Signal_13	Yes
14	LP_Signal_14	Yes
15	LP_Signal_15	Yes
16	LP_Signal_16	Yes
17	LP_Signal_17	Yes
18	LP_Signal_18	Yes
19	LP_Signal_19	Yes
20	LP_Signal_20	No
21	LP_Signal_21	No
22	LP_Signal_22	Yes
23	LP_Signal_23	Yes
24	LP_Signal_24	Yes
25	LP_Signal_25	Yes
26	LP_Signal_26	Yes
27	LP_Signal_27	Yes
28	LP_Signal_28	Yes
29	LP_Signal_29	Yes
30	LP_Signal_30	Yes
		Detection Rate: 83.3 %

Long Pulse Radar Test Signal						
Test Signal Name: LP_Signal_01						
Number of Bursts in Trial: 19						
Chrip Center Frequency: 5493MHz						
Burst	Pulses per Burst	Chrip (Hz)	Pulse Width (s)	Pulse 1 to 2 Spacing (s)	Pulse 2 to 3 Spacing (s)	Start Location (s)
1	2	5M	50.4u	1.916m	-	334.6m
2	2	5M	54.2u	1.760m	-	40.17m
3	2	5M	66.7u	1.591m	-	375.0m
4	1	5M	81.8u	-	-	224.8m
5	3	5M	85.3u	1.562m	1.550m	598.5m
6	2	5M	50.9u	1.097m	-	247.8m
7	3	5M	71.5u	1.403m	1.250m	384.9m
8	1	5M	57.3u	-	-	545.1m
9	1	5M	99.4u	-	-	327.7m
10	2	5M	81.7u	1.762m	-	346.5m
11	3	5M	87.0u	1.625m	1.683m	237.2m
12	2	5M	94.9u	1.522m	-	585.4m
13	2	5M	83.5u	1.529m	-	480.1m
14	2	5M	66.1u	1.677m	-	545.9m
15	2	5M	52.9u	1.709m	-	563.8m
16	3	5M	51.5u	1.865m	1.887m	433.2m
17	1	5M	82.8u	-	-	4.846m
18	2	5M	84.6u	957.4u	-	397.1m
19	3	5M	70.6u	1.247m	1.791m	432.2m

Long Pulse Radar Test Signal						
Test Signal Name: LP_Signal_02						
Number of Bursts in Trial: 12						
Chrip Center Frequency: 5493MHz						
Burst	Pulses per Burst	Chrip (Hz)	Pulse Width (s)	Pulse 1 to 2 Spacing (s)	Pulse 2 to 3 Spacing (s)	Start Location (s)
1	1	6M	74.4u	-	-	870.4m
2	2	6M	73.0u	1.799m	-	254.4m
3	1	6M	69.1u	-	-	695.0m
4	2	6M	80.4u	1.729m	-	818.0m
5	2	6M	80.1u	1.222m	-	775.0m
6	3	6M	61.6u	1.022m	1.568m	773.7m
7	2	6M	72.5u	1.562m	-	260.7m
8	3	6M	69.9u	1.863m	1.712m	187.4m
9	2	6M	98.9u	1.750m	-	407.2m
10	1	6M	86.5u	-	-	242.1m
11	2	6M	67.5u	1.178m	-	608.3m
12	3	6M	85.8u	1.665m	1.754m	944.7m

Long Pulse Radar Test Signal						
Test Signal Name: LP_Signal_03						
Number of Bursts in Trial: 12						
Chrip Center Frequency: 5494MHz						
Burst	Pulses per Burst	Chrip (Hz)	Pulse Width (s)	Pulse 1 to 2 Spacing (s)	Pulse 2 to 3 Spacing (s)	Start Location (s)
1	2	7M	80.8u	1.909m	-	739.1m
2	3	7M	72.8u	1.611m	1.582m	706.3m
3	2	7M	90.5u	1.287m	-	462.3m
4	1	7M	63.9u	-	-	784.5m
5	2	7M	88.9u	1.779m	-	930.2m
6	3	7M	62.5u	1.149m	1.301m	45.25m
7	2	7M	80.7u	996.3u	-	723.7m
8	2	7M	53.8u	1.508m	-	526.5m
9	1	7M	60.9u	-	-	969.6m
10	3	7M	70.9u	1.208m	1.123m	654.9m
11	2	7M	60.0u	1.424m	-	233.5m
12	2	7M	80.6u	1.042m	-	8.643m

Long Pulse Radar Test Signal						
Test Signal Name: LP_Signal_04						
Number of Bursts in Trial: 9						
Chrip Center Frequency: 5495MHz						
Burst	Pulses per Burst	Chrip (Hz)	Pulse Width (s)	Pulse 1 to 2 Spacing (s)	Pulse 2 to 3 Spacing (s)	Start Location (s)
1	3	9M	67.5u	1.874m	1.749m	1.014
2	2	9M	52.7u	1.446m	-	898.7m
3	2	9M	78.3u	1.619m	-	302.3m
4	2	9M	80.3u	1.362m	-	195.1m
5	3	9M	74.5u	1.854m	1.629m	36.47m
6	1	9M	99.7u	-	-	578.0m
7	1	9M	52.7u	-	-	881.2m
8	1	9M	83.6u	-	-	702.5m
9	1	9M	55.4u	-	-	243.8m

Long Pulse Radar Test Signal						
Test Signal Name: LP_Signal_05						
Number of Bursts in Trial: 9						
Chrip Center Frequency: 5495MHz						
Burst	Pulses per Burst	Chrip (Hz)	Pulse Width (s)	Pulse 1 to 2 Spacing (s)	Pulse 2 to 3 Spacing (s)	Start Location (s)
1	3	10M	80.2u	1.716m	1.208m	458.3m
2	2	10M	99.0u	1.877m	-	80.24m
3	1	10M	70.5u	-	-	705.0m
4	1	10M	88.3u	-	-	69.65m
5	2	10M	56.4u	1.516m	-	922.0m
6	1	10M	100.0u	-	-	179.3m
7	2	10M	58.2u	994.8u	-	1.187
8	1	10M	98.0u	-	-	223.9m
9	1	10M	92.7u	-	-	927.1m

Long Pulse Radar Test Signal						
Test Signal Name: LP_Signal_06						
Number of Bursts in Trial: 12						
Chrip Center Frequency: 5495MHz						
Burst	Pulses per Burst	Chrip (Hz)	Pulse Width (s)	Pulse 1 to 2 Spacing (s)	Pulse 2 to 3 Spacing (s)	Start Location (s)
1	1	11M	51.0u	-	-	563.8m
2	2	11M	90.6u	980.4u	-	842.7m
3	2	11M	98.0u	1.517m	-	891.3m
4	1	11M	86.3u	-	-	18.60m
5	2	11M	83.6u	1.461m	-	229.3m
6	1	11M	69.2u	-	-	831.7m
7	1	11M	88.5u	-	-	690.5m
8	2	11M	52.0u	1.323m	-	189.2m
9	2	11M	93.8u	1.880m	-	173.7m
10	2	11M	93.5u	1.138m	-	816.3m
11	2	11M	67.3u	1.623m	-	196.4m
12	1	11M	92.5u	-	-	496.3m

Long Pulse Radar Test Signal						
Test Signal Name: LP_Signal_07						
Number of Bursts in Trial: 18						
Chrip Center Frequency: 5496MHz						
Burst	Pulses per Burst	Chrip (Hz)	Pulse Width (s)	Pulse 1 to 2 Spacing (s)	Pulse 2 to 3 Spacing (s)	Start Location (s)
1	2	12M	86.4u	1.763m	-	5.231m
2	2	12M	84.4u	1.841m	-	546.8m
3	1	12M	62.7u	-	-	648.5m
4	3	12M	77.1u	1.868m	1.513m	380.7m
5	2	12M	99.6u	1.304m	-	205.8m
6	2	12M	99.2u	1.534m	-	198.4m
7	2	12M	57.0u	1.343m	-	473.0m
8	2	12M	92.2u	1.240m	-	629.2m
9	2	12M	54.7u	1.338m	-	653.5m
10	2	12M	95.9u	1.771m	-	571.9m
11	2	12M	82.8u	1.713m	-	403.3m
12	3	12M	61.0u	1.144m	1.057m	92.42m
13	2	12M	72.4u	1.185m	-	365.5m
14	1	12M	86.4u	-	-	28.99m
15	2	12M	89.8u	1.119m	-	169.9m
16	3	12M	56.5u	958.5u	1.068m	439.0m
17	2	12M	80.4u	958.6u	-	474.9m
18	2	12M	93.3u	1.452m	-	398.0m

Long Pulse Radar Test Signal						
Test Signal Name: LP_Signal_08						
Number of Bursts in Trial: 17						
Chrip Center Frequency: 5497MHz						
Burst	Pulses per Burst	Chrip (Hz)	Pulse Width (s)	Pulse 1 to 2 Spacing (s)	Pulse 2 to 3 Spacing (s)	Start Location (s)
1	2	14M	54.4u	1.544m	-	171.5m
2	2	14M	93.6u	1.320m	-	246.1m
3	3	14M	89.8u	1.720m	1.895m	347.7m
4	1	14M	85.1u	-	-	489.6m
5	2	14M	61.4u	1.507m	-	311.2m
6	3	14M	55.4u	1.798m	1.313m	540.6m
7	2	14M	92.1u	1.250m	-	66.91m
8	2	14M	63.5u	1.130m	-	241.9m
9	1	14M	86.9u	-	-	447.3m
10	3	14M	80.5u	1.568m	1.605m	7.248m
11	3	14M	55.0u	1.245m	1.865m	527.1m
12	1	14M	63.9u	-	-	76.76m
13	3	14M	79.9u	1.689m	1.894m	16.80m
14	2	14M	55.4u	1.846m	-	214.0m
15	1	14M	93.7u	-	-	330.3m
16	2	14M	86.8u	1.529m	-	638.0m
17	2	14M	52.9u	1.784m	-	245.7m

Long Pulse Radar Test Signal						
Test Signal Name: LP_Signal_09						
Number of Bursts in Trial: 19						
Chrip Center Frequency: 5498MHz						
Burst	Pulses per Burst	Chrip (Hz)	Pulse Width (s)	Pulse 1 to 2 Spacing (s)	Pulse 2 to 3 Spacing (s)	Start Location (s)
1	3	17M	56.6u	1.081m	1.442m	264.5m
2	2	17M	77.0u	1.479m	-	411.6m
3	1	17M	64.7u	-	-	502.4m
4	2	17M	66.3u	1.533m	-	128.2m
5	2	17M	66.5u	1.654m	-	32.33m
6	2	17M	53.9u	1.723m	-	368.5m
7	2	17M	95.4u	1.678m	-	502.6m
8	2	17M	79.6u	1.481m	-	375.6m
9	2	17M	94.7u	1.774m	-	335.2m
10	3	17M	86.7u	1.256m	1.147m	567.5m
11	2	17M	65.2u	1.373m	-	55.52m
12	3	17M	53.6u	1.336m	1.086m	350.4m
13	1	17M	93.6u	-	-	549.5m
14	3	17M	99.9u	1.866m	961.1u	222.0m
15	2	17M	98.7u	1.242m	-	603.9m
16	3	17M	99.5u	992.5u	1.138m	514.9m
17	2	17M	88.7u	1.906m	-	388.1m
18	2	17M	98.4u	1.185m	-	429.7m
19	2	17M	84.8u	1.718m	-	344.7m

Long Pulse Radar Test Signal						
Test Signal Name: LP_Signal_10						
Number of Bursts in Trial: 17						
Chrip Center Frequency: 5499MHz						
Burst	Pulses per Burst	Chrip (Hz)	Pulse Width (s)	Pulse 1 to 2 Spacing (s)	Pulse 2 to 3 Spacing (s)	Start Location (s)
1	2	19M	78.0u	1.167m	-	269.8m
2	3	19M	82.8u	1.545m	1.544m	640.4m
3	2	19M	73.0u	1.679m	-	88.41m
4	2	19M	67.7u	1.793m	-	557.7m
5	2	19M	55.9u	1.359m	-	651.0m
6	2	19M	92.9u	1.029m	-	485.5m
7	3	19M	70.2u	1.756m	1.342m	179.1m
8	1	19M	55.1u	-	-	407.5m
9	3	19M	67.9u	1.910m	1.250m	285.0m
10	1	19M	50.3u	-	-	147.8m
11	3	19M	50.3u	1.543m	1.185m	550.6m
12	3	19M	93.9u	1.670m	1.112m	207.5m
13	3	19M	54.3u	1.260m	1.333m	689.3m
14	1	19M	73.3u	-	-	595.0m
15	2	19M	86.5u	1.506m	-	78.29m
16	3	19M	53.8u	1.088m	1.261m	105.6m
17	2	19M	89.3u	1.368m	-	145.9m

Long Pulse Radar Test Signal						
Test Signal Name: LP_Signal_11						
Number of Bursts in Trial: 19						
Chrip Center Frequency: 5500MHz						
Burst	Pulses per Burst	Chrip (Hz)	Pulse Width (s)	Pulse 1 to 2 Spacing (s)	Pulse 2 to 3 Spacing (s)	Start Location (s)
1	2	6M	63.4u	1.190m	-	443.9m
2	3	6M	80.5u	1.004m	1.265m	336.8m
3	3	6M	50.7u	1.606m	1.092m	55.57m
4	2	6M	79.5u	1.382m	-	212.2m
5	2	6M	94.6u	1.233m	-	328.1m
6	3	6M	55.0u	1.056m	1.768m	444.8m
7	3	6M	75.9u	1.371m	1.684m	593.3m
8	1	6M	77.9u	-	-	619.0m
9	2	6M	56.6u	1.414m	-	336.8m
10	2	6M	67.2u	1.523m	-	322.4m
11	2	6M	95.0u	1.424m	-	68.14m
12	1	6M	65.7u	-	-	445.9m
13	1	6M	90.7u	-	-	618.0m
14	3	6M	52.0u	1.175m	1.483m	346.1m
15	2	6M	61.0u	1.493m	-	358.6m
16	2	6M	75.0u	1.176m	-	461.7m
17	1	6M	63.3u	-	-	215.0m
18	1	6M	72.4u	-	-	83.81m
19	2	6M	52.0u	1.430m	-	198.0m

Long Pulse Radar Test Signal						
Test Signal Name: LP_Signal_12						
Number of Bursts in Trial: 9						
Chrip Center Frequency: 5501MHz						
Burst	Pulses per Burst	Chrip (Hz)	Pulse Width (s)	Pulse 1 to 2 Spacing (s)	Pulse 2 to 3 Spacing (s)	Start Location (s)
1	3	8M	71.1u	1.222m	1.413m	444.6m
2	2	8M	59.0u	1.893m	-	289.7m
3	2	8M	60.7u	1.211m	-	933.9m
4	3	8M	68.6u	1.430m	1.751m	827.1m
5	3	8M	78.0u	1.707m	1.351m	65.79m
6	3	8M	95.0u	1.577m	1.175m	1.235
7	2	8M	94.0u	1.043m	-	1.170
8	2	8M	82.2u	1.181m	-	463.7m
9	1	8M	55.8u	-	-	543.3m

Long Pulse Radar Test Signal						
Test Signal Name: LP_Signal_13						
Number of Bursts in Trial: 18						
Chrip Center Frequency: 5499MHz						
Burst	Pulses per Burst	Chrip (Hz)	Pulse Width (s)	Pulse 1 to 2 Spacing (s)	Pulse 2 to 3 Spacing (s)	Start Location (s)
1	3	10M	54.2u	1.942m	1.494m	592.2m
2	3	10M	71.2u	1.558m	1.925m	239.4m
3	2	10M	96.1u	1.640m	-	300.6m
4	3	10M	90.5u	1.811m	1.633m	351.7m
5	2	10M	76.9u	1.123m	-	637.0m
6	3	10M	50.0u	1.335m	1.347m	297.1m
7	1	10M	75.1u	-	-	128.3m
8	1	10M	67.8u	-	-	292.2m
9	2	10M	88.2u	1.658m	-	55.83m
10	2	10M	52.3u	1.229m	-	382.0m
11	1	10M	64.4u	-	-	649.6m
12	2	10M	80.0u	1.813m	-	186.8m
13	3	10M	71.2u	1.625m	1.030m	289.9m
14	3	10M	52.9u	1.884m	1.728m	105.0m
15	3	10M	72.4u	932.6u	1.559m	96.61m
16	2	10M	74.9u	1.418m	-	493.8m
17	1	10M	76.4u	-	-	528.7m
18	2	10M	62.3u	1.001m	-	468.6m

Long Pulse Radar Test Signal						
Test Signal Name: LP_Signal_14						
Number of Bursts in Trial: 18						
Chrip Center Frequency: 5498MHz						
Burst	Pulses per Burst	Chrip (Hz)	Pulse Width (s)	Pulse 1 to 2 Spacing (s)	Pulse 2 to 3 Spacing (s)	Start Location (s)
1	1	11M	56.6u	-	-	5.676m
2	2	11M	77.1u	1.058m	-	585.8m
3	3	11M	81.5u	1.661m	1.329m	451.6m
4	2	11M	97.9u	1.357m	-	206.6m
5	1	11M	84.7u	-	-	627.8m
6	1	11M	84.1u	-	-	252.8m
7	1	11M	53.3u	-	-	482.1m
8	1	11M	51.5u	-	-	86.47m
9	2	11M	98.0u	957.0u	-	299.9m
10	3	11M	96.3u	1.449m	1.373m	304.0m
11	1	11M	98.7u	-	-	220.4m
12	2	11M	60.5u	1.736m	-	138.8m
13	2	11M	57.3u	1.002m	-	462.9m
14	1	11M	73.5u	-	-	62.34m
15	3	11M	82.9u	1.787m	1.296m	105.5m
16	2	11M	92.5u	1.491m	-	78.23m
17	1	11M	63.3u	-	-	292.8m
18	1	11M	99.3u	-	-	28.14m

Long Pulse Radar Test Signal						
Test Signal Name: LP_Signal_15						
Number of Bursts in Trial: 18						
Chrip Center Frequency: 5502MHz						
Burst	Pulses per Burst	Chrip (Hz)	Pulse Width (s)	Pulse 1 to 2 Spacing (s)	Pulse 2 to 3 Spacing (s)	Start Location (s)
1	2	12M	86.4u	1.763m	-	5.231m
2	2	12M	84.4u	1.841m	-	546.8m
3	1	12M	62.7u	-	-	648.5m
4	3	12M	77.1u	1.868m	1.513m	380.7m
5	2	12M	99.6u	1.304m	-	205.8m
6	2	12M	99.2u	1.534m	-	198.4m
7	2	12M	57.0u	1.343m	-	473.0m
8	2	12M	92.2u	1.240m	-	629.2m
9	2	12M	54.7u	1.338m	-	653.5m
10	2	12M	95.9u	1.771m	-	571.9m
11	2	12M	82.8u	1.713m	-	403.3m
12	3	12M	61.0u	1.144m	1.057m	92.42m
13	2	12M	72.4u	1.185m	-	365.5m
14	1	12M	86.4u	-	-	28.99m
15	2	12M	89.8u	1.119m	-	169.9m
16	3	12M	56.5u	958.5u	1.068m	439.0m
17	2	12M	80.4u	958.6u	-	474.9m
18	2	12M	93.3u	1.452m	-	398.0m

Long Pulse Radar Test Signal						
Test Signal Name: LP_Signal_16						
Number of Bursts in Trial: 12						
Chrip Center Frequency: 5503MHz						
Burst	Pulses per Burst	Chrip (Hz)	Pulse Width (s)	Pulse 1 to 2 Spacing (s)	Pulse 2 to 3 Spacing (s)	Start Location (s)
1	1	13M	98.7u	-	-	633.0m
2	1	13M	57.3u	-	-	438.3m
3	3	13M	68.6u	1.493m	1.610m	875.1m
4	2	13M	97.5u	1.612m	-	685.6m
5	1	13M	55.5u	-	-	747.3m
6	2	13M	62.8u	967.2u	-	788.4m
7	2	13M	80.7u	1.417m	-	652.7m
8	1	13M	65.9u	-	-	782.6m
9	3	13M	79.9u	1.732m	1.557m	410.0m
10	2	13M	76.4u	1.761m	-	78.51m
11	1	13M	58.1u	-	-	580.4m
12	2	13M	78.0u	961.0u	-	162.0m

Long Pulse Radar Test Signal						
Test Signal Name: LP_Signal_17						
Number of Bursts in Trial: 19						
Chrip Center Frequency: 5496MHz						
Burst	Pulses per Burst	Chrip (Hz)	Pulse Width (s)	Pulse 1 to 2 Spacing (s)	Pulse 2 to 3 Spacing (s)	Start Location (s)
1	2	14M	94.8u	1.833m	-	253.8m
2	2	14M	94.0u	1.277m	-	188.2m
3	2	14M	73.4u	1.353m	-	312.0m
4	3	14M	72.4u	1.274m	1.237m	65.56m
5	1	14M	99.7u	-	-	153.2m
6	1	14M	72.3u	-	-	541.4m
7	1	14M	68.9u	-	-	226.9m
8	3	14M	76.0u	1.169m	1.912m	1.325m
9	3	14M	53.8u	1.926m	1.757m	118.8m
10	1	14M	93.7u	-	-	376.4m
11	2	14M	88.8u	1.386m	-	151.7m
12	3	14M	93.9u	1.399m	1.175m	51.10m
13	1	14M	53.5u	-	-	24.10m
14	2	14M	91.7u	1.059m	-	402.9m
15	2	14M	92.7u	1.304m	-	113.0m
16	1	14M	69.2u	-	-	473.0m
17	1	14M	77.9u	-	-	422.4m
18	1	14M	63.2u	-	-	591.5m
19	3	14M	74.1u	1.402m	1.848m	550.6m

Long Pulse Radar Test Signal						
Test Signal Name: LP_Signal_18						
Number of Bursts in Trial: 20						
Chrip Center Frequency: 5495MHz						
Burst	Pulses per Burst	Chrip (Hz)	Pulse Width (s)	Pulse 1 to 2 Spacing (s)	Pulse 2 to 3 Spacing (s)	Start Location (s)
1	3	16M	98.2u	1.077m	1.585m	592.3m
2	1	16M	79.3u	-	-	162.3m
3	2	16M	77.2u	1.088m	-	375.3m
4	2	16M	81.1u	1.530m	-	302.2m
5	3	16M	74.2u	1.573m	1.596m	49.31m
6	3	16M	97.4u	1.523m	1.198m	319.5m
7	2	16M	51.2u	1.709m	-	416.9m
8	2	16M	66.0u	1.111m	-	371.6m
9	3	16M	62.6u	1.384m	943.4u	70.93m
10	2	16M	56.2u	1.075m	-	33.71m
11	3	16M	59.4u	1.155m	1.871m	552.0m
12	2	16M	65.3u	1.262m	-	556.8m
13	2	16M	80.9u	1.317m	-	441.0m
14	3	16M	69.9u	1.450m	1.540m	346.3m
15	1	16M	62.1u	-	-	104.6m
16	3	16M	95.2u	1.573m	1.376m	413.7m
17	2	16M	63.6u	1.451m	-	489.3m
18	2	16M	77.5u	1.642m	-	286.8m
19	1	16M	69.7u	-	-	370.6m
20	2	16M	59.4u	1.193m	-	372.9m

Long Pulse Radar Test Signal						
Test Signal Name: LP_Signal_19						
Number of Bursts in Trial: 11						
Chrip Center Frequency: 5504MHz						
Burst	Pulses per Burst	Chrip (Hz)	Pulse Width (s)	Pulse 1 to 2 Spacing (s)	Pulse 2 to 3 Spacing (s)	Start Location (s)
1	1	18M	64.2u	-	-	494.2m
2	2	18M	97.0u	1.292m	-	114.8m
3	2	18M	52.3u	1.620m	-	1.064
4	2	18M	60.6u	1.251m	-	410.6m
5	3	18M	84.8u	1.723m	1.288m	300.7m
6	1	18M	50.7u	-	-	53.23m
7	3	18M	89.9u	1.262m	1.445m	710.3m
8	2	18M	97.5u	1.135m	-	685.6m
9	1	18M	64.6u	-	-	299.5m
10	3	18M	54.2u	1.045m	1.103m	829.1m
11	1	18M	71.8u	-	-	490.9m

Long Pulse Radar Test Signal						
Test Signal Name: LP_Signal_20						
Number of Bursts in Trial: 16						
Chrip Center Frequency: 5505MHz						
Burst	Pulses per Burst	Chrip (Hz)	Pulse Width (s)	Pulse 1 to 2 Spacing (s)	Pulse 2 to 3 Spacing (s)	Start Location (s)
1	2	20M	80.2u	1.739m	-	720.6m
2	3	20M	50.1u	1.816m	1.933m	558.9m
3	1	20M	96.2u	-	-	211.8m
4	3	20M	72.6u	1.275m	1.410m	628.1m
5	2	20M	92.6u	1.262m	-	295.1m
6	2	20M	70.1u	1.814m	-	404.0m
7	2	20M	96.2u	1.463m	-	89.45m
8	2	20M	78.6u	1.436m	-	275.4m
9	2	20M	85.9u	1.077m	-	726.5m
10	3	20M	86.3u	1.689m	1.395m	279.8m
11	1	20M	88.0u	-	-	142.6m
12	3	20M	58.3u	1.051m	995.7u	248.6m
13	2	20M	95.3u	1.642m	-	392.4m
14	3	20M	93.1u	1.100m	1.481m	639.1m
15	1	20M	96.7u	-	-	614.9m
16	2	20M	67.1u	1.370m	-	471.2m

Long Pulse Radar Test Signal						
Test Signal Name: LP_Signal_21						
Number of Bursts in Trial: 18						
Chrip Center Frequency: 5527MHz						
Burst	Pulses per Burst	Chrip (Hz)	Pulse Width (s)	Pulse 1 to 2 Spacing (s)	Pulse 2 to 3 Spacing (s)	Start Location (s)
1	1	5M	53.6u	-	-	504.6m
2	3	5M	97.1u	1.798m	1.565m	441.5m
3	3	5M	53.5u	1.548m	1.068m	291.7m
4	2	5M	52.2u	1.395m	-	212.8m
5	2	5M	95.3u	1.226m	-	96.33m
6	2	5M	92.6u	1.470m	-	303.7m
7	1	5M	82.6u	-	-	516.6m
8	1	5M	53.5u	-	-	141.6m
9	2	5M	57.4u	999.6u	-	95.05m
10	2	5M	96.4u	1.888m	-	567.5m
11	2	5M	66.0u	1.443m	-	271.3m
12	1	5M	98.5u	-	-	442.6m
13	2	5M	68.3u	1.114m	-	512.5m
14	2	5M	85.3u	1.613m	-	105.4m
15	3	5M	99.4u	1.752m	1.843m	647.8m
16	2	5M	97.8u	1.644m	-	259.0m
17	1	5M	77.1u	-	-	649.5m
18	1	5M	58.2u	-	-	539.5m

Long Pulse Radar Test Signal						
Test Signal Name: LP_Signal_22						
Number of Bursts in Trial: 15						
Chrip Center Frequency: 5527MHz						
Burst	Pulses per Burst	Chrip (Hz)	Pulse Width (s)	Pulse 1 to 2 Spacing (s)	Pulse 2 to 3 Spacing (s)	Start Location (s)
1	1	6M	68.7u	-	-	13.44m
2	1	6M	92.8u	-	-	618.8m
3	2	6M	73.7u	1.459m	-	424.4m
4	2	6M	97.6u	1.294m	-	736.2m
5	1	6M	93.2u	-	-	795.7m
6	2	6M	97.1u	1.871m	-	787.0m
7	2	6M	89.4u	948.6u	-	601.5m
8	2	6M	92.5u	922.5u	-	499.5m
9	2	6M	94.8u	1.066m	-	562.5m
10	2	6M	78.1u	1.629m	-	68.89m
11	1	6M	88.1u	-	-	749.7m
12	3	6M	98.0u	1.708m	999.0u	541.0m
13	2	6M	74.6u	1.001m	-	9.908m
14	1	6M	80.3u	-	-	107.8m
15	1	6M	66.7u	-	-	643.2m

Long Pulse Radar Test Signal						
Test Signal Name: LP_Signal_23						
Number of Bursts in Trial: 16						
Chrip Center Frequency: 5526MHz						
Burst	Pulses per Burst	Chrip (Hz)	Pulse Width (s)	Pulse 1 to 2 Spacing (s)	Pulse 2 to 3 Spacing (s)	Start Location (s)
1	2	8M	50.8u	1.048m	-	635.9m
2	2	8M	70.8u	1.468m	-	352.0m
3	3	8M	68.7u	1.131m	1.113m	508.5m
4	3	8M	84.0u	960.0u	1.557m	350.7m
5	1	8M	84.2u	-	-	566.7m
6	1	8M	87.3u	-	-	579.0m
7	2	8M	73.0u	1.901m	-	701.4m
8	2	8M	91.1u	1.679m	-	488.0m
9	2	8M	51.0u	1.246m	-	601.8m
10	2	8M	95.4u	1.222m	-	729.3m
11	1	8M	56.7u	-	-	201.7m
12	2	8M	98.1u	1.743m	-	373.6m
13	2	8M	94.0u	1.634m	-	611.5m
14	3	8M	69.7u	1.922m	1.481m	560.7m
15	1	8M	63.3u	-	-	463.6m
16	3	8M	96.1u	964.9u	1.369m	190.4m

Long Pulse Radar Test Signal						
Test Signal Name: LP_Signal_24						
Number of Bursts in Trial: 12						
Chrip Center Frequency: 5525MHz						
Burst	Pulses per Burst	Chrip (Hz)	Pulse Width (s)	Pulse 1 to 2 Spacing (s)	Pulse 2 to 3 Spacing (s)	Start Location (s)
1	2	9M	81.2u	1.556m	-	256.2m
2	1	9M	86.7u	-	-	131.1m
3	2	9M	77.8u	1.026m	-	504.6m
4	2	9M	55.6u	1.700m	-	485.5m
5	2	9M	92.8u	1.848m	-	535.0m
6	3	9M	54.8u	974.2u	1.487m	763.2m
7	2	9M	65.7u	1.884m	-	681.3m
8	2	9M	89.7u	1.572m	-	624.8m
9	2	9M	57.8u	1.208m	-	12.28m
10	2	9M	54.6u	1.123m	-	881.4m
11	1	9M	65.0u	-	-	637.4m
12	2	9M	72.7u	1.336m	-	662.2m

Long Pulse Radar Test Signal						
Test Signal Name: LP_Signal_25						
Number of Bursts in Trial: 17						
Chrip Center Frequency: 5525MHz						
Burst	Pulses per Burst	Chrip (Hz)	Pulse Width (s)	Pulse 1 to 2 Spacing (s)	Pulse 2 to 3 Spacing (s)	Start Location (s)
1	3	10M	57.7u	1.500m	1.773m	139.7m
2	1	10M	84.4u	-	-	463.8m
3	2	10M	95.4u	1.392m	-	560.7m
4	3	10M	78.1u	1.719m	1.868m	251.1m
5	2	10M	53.6u	1.058m	-	496.7m
6	3	10M	74.2u	1.825m	1.135m	60.31m
7	2	10M	76.2u	1.302m	-	261.3m
8	2	10M	61.3u	1.462m	-	272.8m
9	2	10M	81.2u	1.721m	-	336.6m
10	3	10M	82.5u	1.729m	1.073m	352.7m
11	3	10M	89.3u	1.642m	1.308m	46.89m
12	2	10M	81.2u	1.227m	-	477.2m
13	2	10M	85.9u	1.560m	-	14.30m
14	1	10M	50.7u	-	-	618.4m
15	1	10M	92.4u	-	-	463.8m
16	2	10M	96.5u	1.415m	-	505.9m
17	3	10M	71.5u	1.838m	1.303m	682.0m

Long Pulse Radar Test Signal						
Test Signal Name: LP_Signal_26						
Number of Bursts in Trial: 20						
Chrip Center Frequency: 5525MHz						
Burst	Pulses per Burst	Chrip (Hz)	Pulse Width (s)	Pulse 1 to 2 Spacing (s)	Pulse 2 to 3 Spacing (s)	Start Location (s)
1	3	11M	83.2u	1.644m	1.165m	247.3m
2	2	11M	59.0u	1.897m	-	528.2m
3	2	11M	65.4u	938.6u	-	344.7m
4	2	11M	81.5u	1.723m	-	322.6m
5	3	11M	76.3u	1.820m	1.145m	27.03m
6	2	11M	88.5u	1.700m	-	209.2m
7	2	11M	82.8u	1.612m	-	306.0m
8	1	11M	59.6u	-	-	204.1m
9	2	11M	51.5u	1.110m	-	235.1m
10	3	11M	93.5u	1.872m	1.143m	350.1m
11	2	11M	81.6u	1.092m	-	370.2m
12	3	11M	50.5u	1.928m	1.706m	363.2m
13	1	11M	53.1u	-	-	37.77m
14	1	11M	52.2u	-	-	316.9m
15	3	11M	58.3u	1.014m	1.238m	172.4m
16	2	11M	71.5u	1.270m	-	446.4m
17	3	11M	95.0u	1.172m	1.527m	127.9m
18	3	11M	76.8u	1.802m	1.280m	370.9m
19	2	11M	70.9u	1.096m	-	297.7m
20	3	11M	71.6u	1.254m	1.111m	489.0m

Long Pulse Radar Test Signal						
Test Signal Name: LP_Signal_27						
Number of Bursts in Trial: 12						
Chrip Center Frequency: 5524MHz						
Burst	Pulses per Burst	Chrip (Hz)	Pulse Width (s)	Pulse 1 to 2 Spacing (s)	Pulse 2 to 3 Spacing (s)	Start Location (s)
1	1	13M	98.7u	-	-	633.0m
2	1	13M	57.3u	-	-	438.3m
3	3	13M	68.6u	1.493m	1.610m	875.1m
4	2	13M	97.5u	1.612m	-	685.6m
5	1	13M	55.5u	-	-	747.3m
6	2	13M	62.8u	967.2u	-	788.4m
7	2	13M	80.7u	1.417m	-	652.7m
8	1	13M	65.9u	-	-	782.6m
9	3	13M	79.9u	1.732m	1.557m	410.0m
10	2	13M	76.4u	1.761m	-	78.51m
11	1	13M	58.1u	-	-	580.4m
12	2	13M	78.0u	961.0u	-	162.0m

Long Pulse Radar Test Signal						
Test Signal Name: LP_Signal_28						
Number of Bursts in Trial: 19						
Chrip Center Frequency: 5523MHz						
Burst	Pulses per Burst	Chrip (Hz)	Pulse Width (s)	Pulse 1 to 2 Spacing (s)	Pulse 2 to 3 Spacing (s)	Start Location (s)
1	2	14M	85.7u	1.367m	-	603.6m
2	3	14M	78.6u	1.641m	1.199m	161.4m
3	3	14M	80.1u	1.820m	1.882m	517.0m
4	2	14M	62.7u	979.3u	-	319.0m
5	2	14M	85.2u	1.237m	-	559.3m
6	3	14M	98.1u	1.761m	1.255m	106.3m
7	1	14M	72.0u	-	-	136.6m
8	2	14M	68.4u	1.583m	-	562.6m
9	1	14M	82.6u	-	-	591.2m
10	2	14M	82.9u	1.029m	-	339.8m
11	1	14M	66.1u	-	-	277.3m
12	2	14M	72.6u	1.029m	-	514.5m
13	1	14M	87.3u	-	-	169.0m
14	2	14M	77.9u	1.828m	-	416.6m
15	2	14M	69.3u	1.609m	-	602.9m
16	1	14M	56.2u	-	-	104.6m
17	1	14M	99.7u	-	-	399.8m
18	2	14M	53.6u	1.552m	-	494.2m
19	1	14M	79.0u	-	-	195.2m

Long Pulse Radar Test Signal						
Test Signal Name: LP_Signal_29						
Number of Bursts in Trial: 13						
Chrip Center Frequency: 5522MHz						
Burst	Pulses per Burst	Chrip (Hz)	Pulse Width (s)	Pulse 1 to 2 Spacing (s)	Pulse 2 to 3 Spacing (s)	Start Location (s)
1	2	17M	95.6u	1.309m	-	798.4m
2	2	17M	89.4u	1.847m	-	293.0m
3	2	17M	53.8u	1.798m	-	916.5m
4	1	17M	57.0u	-	-	912.5m
5	2	17M	73.3u	984.7u	-	502.7m
6	2	17M	78.4u	1.529m	-	428.2m
7	2	17M	69.4u	1.479m	-	250.3m
8	2	17M	70.0u	1.557m	-	822.3m
9	3	17M	66.9u	1.078m	952.1u	814.9m
10	3	17M	83.6u	1.564m	1.482m	788.7m
11	2	17M	51.3u	1.508m	-	757.3m
12	2	17M	52.7u	1.562m	-	875.4m
13	3	17M	64.5u	961.5u	1.073m	611.6m

Long Pulse Radar Test Signal						
Test Signal Name: LP_Signal_30						
Number of Bursts in Trial: 14						
Chrip Center Frequency: 5521MHz						
Burst	Pulses per Burst	Chrip (Hz)	Pulse Width (s)	Pulse 1 to 2 Spacing (s)	Pulse 2 to 3 Spacing (s)	Start Location (s)
1	1	19M	96.6u	-	-	363.1m
2	1	19M	51.9u	-	-	739.2m
3	1	19M	76.1u	-	-	386.4m
4	2	19M	73.2u	1.121m	-	703.9m
5	2	19M	63.6u	1.058m	-	622.0m
6	1	19M	79.6u	-	-	34.99m
7	3	19M	82.5u	1.213m	1.864m	794.1m
8	3	19M	53.7u	1.356m	1.081m	215.9m
9	1	19M	80.9u	-	-	611.8m
10	2	19M	95.4u	1.890m	-	620.4m
11	2	19M	50.1u	1.778m	-	549.3m
12	1	19M	78.5u	-	-	569.2m
13	2	19M	63.2u	1.648m	-	480.1m
14	2	19M	65.0u	965.0u	-	762.0m

Type 6 Radar Statistical Performances				
Trial #	Pulses per Burst	Pulse Width (s)	PRI (s)	Detection
1	9	1.0u	333.0u	Yes
2	9	1.0u	333.0u	Yes
3	9	1.0u	333.0u	Yes
4	9	1.0u	333.0u	Yes
5	9	1.0u	333.0u	Yes
6	9	1.0u	333.0u	Yes
7	9	1.0u	333.0u	Yes
8	9	1.0u	333.0u	Yes
9	9	1.0u	333.0u	Yes
10	9	1.0u	333.0u	Yes
11	9	1.0u	333.0u	Yes
12	9	1.0u	333.0u	Yes
13	9	1.0u	333.0u	Yes
14	9	1.0u	333.0u	Yes
15	9	1.0u	333.0u	Yes
16	9	1.0u	333.0u	Yes
17	9	1.0u	333.0u	Yes
18	9	1.0u	333.0u	Yes
19	9	1.0u	333.0u	Yes
20	9	1.0u	333.0u	Yes
21	9	1.0u	333.0u	Yes
22	9	1.0u	333.0u	Yes
23	9	1.0u	333.0u	Yes
24	9	1.0u	333.0u	Yes
25	9	1.0u	333.0u	Yes
26	9	1.0u	333.0u	Yes
27	9	1.0u	333.0u	Yes
28	9	1.0u	333.0u	Yes
29	9	1.0u	333.0u	Yes
30	9	1.0u	333.0u	Yes
			Detection Rate: 100.0 %	

Type 6 Radar Statistical Performances		
Trial #	Hopping Frequency Sequence Name	Detection
1	HOP_FREQ_SEQ_01	Yes
2	HOP_FREQ_SEQ_02	Yes
3	HOP_FREQ_SEQ_03	Yes
4	HOP_FREQ_SEQ_04	Yes
5	HOP_FREQ_SEQ_05	Yes
6	HOP_FREQ_SEQ_06	Yes
7	HOP_FREQ_SEQ_07	Yes
8	HOP_FREQ_SEQ_08	Yes
9	HOP_FREQ_SEQ_09	Yes
10	HOP_FREQ_SEQ_10	Yes
11	HOP_FREQ_SEQ_11	Yes
12	HOP_FREQ_SEQ_12	Yes
13	HOP_FREQ_SEQ_13	Yes
14	HOP_FREQ_SEQ_14	Yes
15	HOP_FREQ_SEQ_15	Yes
16	HOP_FREQ_SEQ_16	Yes
17	HOP_FREQ_SEQ_17	Yes
18	HOP_FREQ_SEQ_18	Yes
19	HOP_FREQ_SEQ_19	Yes
20	HOP_FREQ_SEQ_20	Yes
21	HOP_FREQ_SEQ_21	Yes
22	HOP_FREQ_SEQ_22	Yes
23	HOP_FREQ_SEQ_23	Yes
24	HOP_FREQ_SEQ_24	Yes
25	HOP_FREQ_SEQ_25	Yes
26	HOP_FREQ_SEQ_26	Yes
27	HOP_FREQ_SEQ_27	Yes
28	HOP_FREQ_SEQ_28	Yes
29	HOP_FREQ_SEQ_29	Yes
30	HOP_FREQ_SEQ_30	Yes
		Detection Rate: 100.0 %

Hopping Frequency Sequence Name: HOP_FREQ_SEQ_01							
SEQ#	Frequency (Hz)	SEQ#	Frequency (Hz)	SEQ#	Frequency (Hz)	SEQ#	Frequency (Hz)
1	5.661G	2	5.682G	3	5.347G	4	5.275G
5	5.582G	6	5.334G	7	5.691G	8	5.453G
9	5.693G	10	5.601G	11	5.713G	12	5.585G
13	5.341G	14	5.511G	15	5.445G	16	5.670G
17	5.666G	18	5.296G	19	5.465G	20	5.679G
21	5.256G	22	5.714G	23	5.494G	24	5.454G
25	5.317G	26	5.290G	27	5.376G	28	5.612G
29	5.648G	30	5.439G	31	5.474G	32	5.563G
33	5.416G	34	5.721G	35	5.351G	36	5.668G
37	5.435G	38	5.440G	39	5.664G	40	5.369G
41	5.600G	42	5.292G	43	5.534G	44	5.708G
45	5.624G	46	5.537G	47	5.652G	48	5.655G
49	5.374G	50	5.336G	51	5.643G	52	5.437G
53	5.533G	54	5.482G	55	5.285G	56	5.443G
57	5.501G	58	5.547G	59	5.274G	60	5.650G
61	5.683G	62	5.615G	63	5.280G	64	5.469G
65	5.628G	66	5.639G	67	5.426G	68	5.379G
69	5.393G	70	5.479G	71	5.706G	72	5.604G
73	5.315G	74	5.605G	75	5.371G	76	5.409G
77	5.282G	78	5.572G	79	5.333G	80	5.272G
81	5.645G	82	5.588G	83	5.402G	84	5.399G
85	5.442G	86	5.258G	87	5.673G	88	5.575G
89	5.309G	90	5.570G	91	5.313G	92	5.701G
93	5.678G	94	5.510G	95	5.622G	96	5.580G
97	5.700G	98	5.250G	99	5.456G	100	5.633G

Hopping Frequency Sequence Name: HOP_FREQ_SEQ_02							
SEQ#	Frequency (Hz)	SEQ#	Frequency (Hz)	SEQ#	Frequency (Hz)	SEQ#	Frequency (Hz)
1	5.414G	2	5.439G	3	5.282G	4	5.592G
5	5.714G	6	5.570G	7	5.685G	8	5.466G
9	5.529G	10	5.637G	11	5.396G	12	5.708G
13	5.298G	14	5.361G	15	5.663G	16	5.651G
17	5.601G	18	5.690G	19	5.522G	20	5.557G
21	5.589G	22	5.391G	23	5.511G	24	5.263G
25	5.636G	26	5.284G	27	5.615G	28	5.408G
29	5.721G	30	5.318G	31	5.463G	32	5.562G
33	5.290G	34	5.250G	35	5.706G	36	5.452G
37	5.526G	38	5.588G	39	5.400G	40	5.399G
41	5.357G	42	5.541G	43	5.269G	44	5.552G
45	5.431G	46	5.481G	47	5.697G	48	5.724G
49	5.461G	50	5.322G	51	5.474G	52	5.476G
53	5.330G	54	5.359G	55	5.698G	56	5.358G
57	5.464G	58	5.547G	59	5.346G	60	5.386G
61	5.676G	62	5.560G	63	5.673G	64	5.543G
65	5.275G	66	5.691G	67	5.581G	68	5.598G
69	5.616G	70	5.471G	71	5.374G	72	5.405G
73	5.254G	74	5.537G	75	5.442G	76	5.315G
77	5.546G	78	5.274G	79	5.342G	80	5.671G
81	5.416G	82	5.545G	83	5.658G	84	5.512G
85	5.555G	86	5.381G	87	5.567G	88	5.672G
89	5.296G	90	5.595G	91	5.421G	92	5.299G
93	5.540G	94	5.701G	95	5.411G	96	5.376G
97	5.494G	98	5.329G	99	5.264G	100	5.270G

Hopping Frequency Sequence Name: HOP_FREQ_SEQ_03							
SEQ#	Frequency (Hz)	SEQ#	Frequency (Hz)	SEQ#	Frequency (Hz)	SEQ#	Frequency (Hz)
1	5.679G	2	5.317G	3	5.547G	4	5.700G
5	5.503G	6	5.452G	7	5.250G	8	5.582G
9	5.521G	10	5.374G	11	5.535G	12	5.340G
13	5.686G	14	5.430G	15	5.264G	16	5.364G
17	5.306G	18	5.462G	19	5.309G	20	5.516G
21	5.499G	22	5.315G	23	5.639G	24	5.636G
25	5.724G	26	5.417G	27	5.335G	28	5.444G
29	5.458G	30	5.536G	31	5.432G	32	5.551G
33	5.477G	34	5.661G	35	5.677G	36	5.344G
37	5.675G	38	5.693G	39	5.441G	40	5.287G
41	5.681G	42	5.328G	43	5.712G	44	5.454G
45	5.357G	46	5.561G	47	5.271G	48	5.515G
49	5.608G	50	5.538G	51	5.506G	52	5.376G
53	5.584G	54	5.355G	55	5.705G	56	5.406G
57	5.260G	58	5.683G	59	5.422G	60	5.343G
61	5.605G	62	5.518G	63	5.316G	64	5.459G
65	5.722G	66	5.689G	67	5.577G	68	5.423G
69	5.702G	70	5.527G	71	5.500G	72	5.716G
73	5.587G	74	5.710G	75	5.528G	76	5.562G
77	5.568G	78	5.349G	79	5.523G	80	5.609G
81	5.481G	82	5.378G	83	5.637G	84	5.684G
85	5.261G	86	5.615G	87	5.299G	88	5.410G
89	5.358G	90	5.548G	91	5.715G	92	5.534G
93	5.370G	94	5.289G	95	5.600G	96	5.553G
97	5.525G	98	5.520G	99	5.572G	100	5.273G

Hopping Frequency Sequence Name: HOP_FREQ_SEQ_04							
SEQ#	Frequency (Hz)	SEQ#	Frequency (Hz)	SEQ#	Frequency (Hz)	SEQ#	Frequency (Hz)
1	5.400G	2	5.348G	3	5.316G	4	5.506G
5	5.301G	6	5.657G	7	5.382G	8	5.300G
9	5.524G	10	5.617G	11	5.349G	12	5.646G
13	5.273G	14	5.283G	15	5.446G	16	5.588G
17	5.330G	18	5.417G	19	5.669G	20	5.528G
21	5.580G	22	5.679G	23	5.628G	24	5.621G
25	5.673G	26	5.651G	27	5.391G	28	5.444G
29	5.564G	30	5.685G	31	5.361G	32	5.454G
33	5.404G	34	5.690G	35	5.439G	36	5.380G
37	5.614G	38	5.516G	39	5.535G	40	5.536G
41	5.302G	42	5.388G	43	5.658G	44	5.426G
45	5.561G	46	5.550G	47	5.513G	48	5.451G
49	5.393G	50	5.560G	51	5.365G	52	5.703G
53	5.671G	54	5.684G	55	5.337G	56	5.256G
57	5.332G	58	5.571G	59	5.372G	60	5.544G
61	5.274G	62	5.723G	63	5.456G	64	5.520G
65	5.472G	66	5.425G	67	5.634G	68	5.702G
69	5.309G	70	5.710G	71	5.670G	72	5.533G
73	5.366G	74	5.724G	75	5.680G	76	5.595G
77	5.517G	78	5.287G	79	5.375G	80	5.574G
81	5.495G	82	5.328G	83	5.548G	84	5.668G
85	5.407G	86	5.579G	87	5.682G	88	5.291G
89	5.315G	90	5.586G	91	5.529G	92	5.584G
93	5.263G	94	5.541G	95	5.359G	96	5.340G
97	5.523G	98	5.543G	99	5.480G	100	5.485G

Hopping Frequency Sequence Name: HOP_FREQ_SEQ_05							
SEQ#	Frequency (Hz)	SEQ#	Frequency (Hz)	SEQ#	Frequency (Hz)	SEQ#	Frequency (Hz)
1	5.319G	2	5.719G	3	5.506G	4	5.714G
5	5.382G	6	5.638G	7	5.336G	8	5.350G
9	5.416G	10	5.352G	11	5.309G	12	5.381G
13	5.517G	14	5.669G	15	5.534G	16	5.540G
17	5.705G	18	5.637G	19	5.551G	20	5.471G
21	5.287G	22	5.608G	23	5.541G	24	5.606G
25	5.709G	26	5.500G	27	5.689G	28	5.527G
29	5.422G	30	5.710G	31	5.568G	32	5.346G
33	5.575G	34	5.514G	35	5.347G	36	5.391G
37	5.362G	38	5.625G	39	5.640G	40	5.258G
41	5.398G	42	5.270G	43	5.511G	44	5.499G
45	5.684G	46	5.314G	47	5.272G	48	5.303G
49	5.647G	50	5.379G	51	5.476G	52	5.392G
53	5.494G	54	5.501G	55	5.377G	56	5.467G
57	5.507G	58	5.295G	59	5.686G	60	5.254G
61	5.306G	62	5.572G	63	5.290G	64	5.373G
65	5.302G	66	5.632G	67	5.320G	68	5.578G
69	5.539G	70	5.327G	71	5.487G	72	5.515G
73	5.571G	74	5.370G	75	5.666G	76	5.604G
77	5.368G	78	5.528G	79	5.414G	80	5.695G
81	5.429G	82	5.641G	83	5.436G	84	5.417G
85	5.269G	86	5.649G	87	5.529G	88	5.457G
89	5.283G	90	5.444G	91	5.603G	92	5.372G
93	5.664G	94	5.503G	95	5.680G	96	5.563G
97	5.712G	98	5.673G	99	5.650G	100	5.296G

Hopping Frequency Sequence Name: HOP_FREQ_SEQ_06							
SEQ#	Frequency (Hz)	SEQ#	Frequency (Hz)	SEQ#	Frequency (Hz)	SEQ#	Frequency (Hz)
1	5.464G	2	5.500G	3	5.454G	4	5.723G
5	5.711G	6	5.679G	7	5.623G	8	5.303G
9	5.639G	10	5.651G	11	5.289G	12	5.657G
13	5.435G	14	5.551G	15	5.608G	16	5.335G
17	5.321G	18	5.467G	19	5.503G	20	5.543G
21	5.584G	22	5.481G	23	5.618G	24	5.650G
25	5.306G	26	5.366G	27	5.695G	28	5.328G
29	5.533G	30	5.461G	31	5.452G	32	5.708G
33	5.477G	34	5.479G	35	5.412G	36	5.407G
37	5.548G	38	5.683G	39	5.620G	40	5.315G
41	5.495G	42	5.416G	43	5.317G	44	5.327G
45	5.457G	46	5.641G	47	5.526G	48	5.309G
49	5.665G	50	5.636G	51	5.266G	52	5.675G
53	5.422G	54	5.271G	55	5.569G	56	5.288G
57	5.434G	58	5.505G	59	5.272G	60	5.643G
61	5.534G	62	5.259G	63	5.252G	64	5.592G
65	5.662G	66	5.267G	67	5.382G	68	5.433G
69	5.485G	70	5.682G	71	5.688G	72	5.590G
73	5.332G	74	5.269G	75	5.716G	76	5.427G
77	5.549G	78	5.456G	79	5.348G	80	5.357G
81	5.458G	82	5.440G	83	5.692G	84	5.693G
85	5.638G	86	5.509G	87	5.567G	88	5.409G
89	5.307G	90	5.715G	91	5.552G	92	5.360G
93	5.292G	94	5.470G	95	5.441G	96	5.587G
97	5.444G	98	5.365G	99	5.310G	100	5.394G

Hopping Frequency Sequence Name: HOP_FREQ_SEQ_07							
SEQ#	Frequency (Hz)	SEQ#	Frequency (Hz)	SEQ#	Frequency (Hz)	SEQ#	Frequency (Hz)
1	5.458G	2	5.662G	3	5.310G	4	5.348G
5	5.655G	6	5.508G	7	5.547G	8	5.650G
9	5.415G	10	5.350G	11	5.550G	12	5.474G
13	5.551G	14	5.450G	15	5.722G	16	5.417G
17	5.494G	18	5.409G	19	5.499G	20	5.327G
21	5.699G	22	5.403G	23	5.390G	24	5.448G
25	5.561G	26	5.632G	27	5.564G	28	5.618G
29	5.513G	30	5.260G	31	5.339G	32	5.437G
33	5.463G	34	5.406G	35	5.446G	36	5.690G
37	5.671G	38	5.723G	39	5.588G	40	5.712G
41	5.709G	42	5.328G	43	5.451G	44	5.438G
45	5.428G	46	5.479G	47	5.320G	48	5.413G
49	5.529G	50	5.554G	51	5.517G	52	5.663G
53	5.642G	54	5.331G	55	5.715G	56	5.677G
57	5.528G	58	5.330G	59	5.526G	60	5.570G
61	5.675G	62	5.600G	63	5.654G	64	5.595G
65	5.361G	66	5.633G	67	5.540G	68	5.357G
69	5.278G	70	5.300G	71	5.641G	72	5.258G
73	5.373G	74	5.273G	75	5.656G	76	5.408G
77	5.649G	78	5.500G	79	5.421G	80	5.630G
81	5.396G	82	5.251G	83	5.533G	84	5.433G
85	5.370G	86	5.524G	87	5.386G	88	5.605G
89	5.353G	90	5.256G	91	5.640G	92	5.591G
93	5.488G	94	5.312G	95	5.295G	96	5.364G
97	5.646G	98	5.599G	99	5.697G	100	5.696G

Hopping Frequency Sequence Name: HOP_FREQ_SEQ_08							
SEQ#	Frequency (Hz)	SEQ#	Frequency (Hz)	SEQ#	Frequency (Hz)	SEQ#	Frequency (Hz)
1	5.495G	2	5.553G	3	5.386G	4	5.410G
5	5.686G	6	5.417G	7	5.287G	8	5.575G
9	5.292G	10	5.356G	11	5.537G	12	5.589G
13	5.291G	14	5.624G	15	5.453G	16	5.485G
17	5.607G	18	5.339G	19	5.650G	20	5.660G
21	5.601G	22	5.486G	23	5.431G	24	5.328G
25	5.515G	26	5.678G	27	5.448G	28	5.371G
29	5.556G	30	5.661G	31	5.659G	32	5.599G
33	5.536G	34	5.521G	35	5.261G	36	5.305G
37	5.337G	38	5.646G	39	5.588G	40	5.527G
41	5.574G	42	5.642G	43	5.695G	44	5.380G
45	5.358G	46	5.484G	47	5.713G	48	5.629G
49	5.676G	50	5.704G	51	5.267G	52	5.555G
53	5.293G	54	5.326G	55	5.461G	56	5.544G
57	5.499G	58	5.342G	59	5.420G	60	5.437G
61	5.290G	62	5.579G	63	5.597G	64	5.426G
65	5.277G	66	5.389G	67	5.257G	68	5.557G
69	5.593G	70	5.393G	71	5.341G	72	5.405G
73	5.644G	74	5.618G	75	5.594G	76	5.477G
77	5.696G	78	5.447G	79	5.577G	80	5.325G
81	5.474G	82	5.616G	83	5.647G	84	5.679G
85	5.309G	86	5.440G	87	5.652G	88	5.627G
89	5.428G	90	5.382G	91	5.419G	92	5.501G
93	5.637G	94	5.600G	95	5.306G	96	5.517G
97	5.387G	98	5.545G	99	5.497G	100	5.488G

Hopping Frequency Sequence Name: HOP_FREQ_SEQ_09							
SEQ#	Frequency (Hz)	SEQ#	Frequency (Hz)	SEQ#	Frequency (Hz)	SEQ#	Frequency (Hz)
1	5.307G	2	5.564G	3	5.439G	4	5.660G
5	5.654G	6	5.676G	7	5.652G	8	5.527G
9	5.422G	10	5.452G	11	5.378G	12	5.550G
13	5.387G	14	5.542G	15	5.563G	16	5.290G
17	5.431G	18	5.516G	19	5.575G	20	5.671G
21	5.470G	22	5.696G	23	5.580G	24	5.591G
25	5.599G	26	5.703G	27	5.421G	28	5.679G
29	5.688G	30	5.395G	31	5.257G	32	5.388G
33	5.335G	34	5.390G	35	5.364G	36	5.666G
37	5.535G	38	5.450G	39	5.322G	40	5.686G
41	5.677G	42	5.325G	43	5.578G	44	5.344G
45	5.655G	46	5.295G	47	5.430G	48	5.522G
49	5.331G	50	5.424G	51	5.508G	52	5.368G
53	5.457G	54	5.285G	55	5.673G	56	5.689G
57	5.362G	58	5.698G	59	5.401G	60	5.691G
61	5.624G	62	5.482G	63	5.473G	64	5.310G
65	5.610G	66	5.558G	67	5.365G	68	5.273G
69	5.298G	70	5.380G	71	5.567G	72	5.708G
73	5.600G	74	5.269G	75	5.303G	76	5.398G
77	5.308G	78	5.404G	79	5.718G	80	5.499G
81	5.373G	82	5.593G	83	5.358G	84	5.468G
85	5.311G	86	5.488G	87	5.606G	88	5.363G
89	5.533G	90	5.700G	91	5.485G	92	5.346G
93	5.642G	94	5.256G	95	5.415G	96	5.721G
97	5.500G	98	5.381G	99	5.576G	100	5.585G

Hopping Frequency Sequence Name: HOP_FREQ_SEQ_10							
SEQ#	Frequency (Hz)	SEQ#	Frequency (Hz)	SEQ#	Frequency (Hz)	SEQ#	Frequency (Hz)
1	5.512G	2	5.624G	3	5.511G	4	5.656G
5	5.314G	6	5.708G	7	5.617G	8	5.352G
9	5.544G	10	5.669G	11	5.391G	12	5.671G
13	5.416G	14	5.501G	15	5.568G	16	5.318G
17	5.643G	18	5.275G	19	5.661G	20	5.567G
21	5.424G	22	5.274G	23	5.650G	24	5.276G
25	5.581G	26	5.418G	27	5.290G	28	5.395G
29	5.550G	30	5.601G	31	5.413G	32	5.468G
33	5.358G	34	5.534G	35	5.285G	36	5.600G
37	5.553G	38	5.638G	39	5.625G	40	5.506G
41	5.559G	42	5.305G	43	5.526G	44	5.717G
45	5.539G	46	5.542G	47	5.427G	48	5.484G
49	5.251G	50	5.269G	51	5.715G	52	5.478G
53	5.454G	54	5.359G	55	5.252G	56	5.353G
57	5.514G	58	5.436G	59	5.316G	60	5.343G
61	5.255G	62	5.604G	63	5.626G	64	5.340G
65	5.310G	66	5.482G	67	5.450G	68	5.431G
69	5.546G	70	5.645G	71	5.447G	72	5.623G
73	5.572G	74	5.723G	75	5.566G	76	5.449G
77	5.477G	78	5.356G	79	5.459G	80	5.465G
81	5.547G	82	5.532G	83	5.517G	84	5.380G
85	5.437G	86	5.594G	87	5.648G	88	5.637G
89	5.503G	90	5.474G	91	5.422G	92	5.589G
93	5.655G	94	5.333G	95	5.344G	96	5.635G
97	5.412G	98	5.504G	99	5.652G	100	5.607G

Hopping Frequency Sequence Name: HOP_FREQ_SEQ_11							
SEQ#	Frequency (Hz)	SEQ#	Frequency (Hz)	SEQ#	Frequency (Hz)	SEQ#	Frequency (Hz)
1	5.652G	2	5.570G	3	5.614G	4	5.430G
5	5.628G	6	5.368G	7	5.343G	8	5.681G
9	5.266G	10	5.707G	11	5.389G	12	5.409G
13	5.426G	14	5.458G	15	5.309G	16	5.330G
17	5.428G	18	5.598G	19	5.300G	20	5.621G
21	5.694G	22	5.566G	23	5.600G	24	5.423G
25	5.543G	26	5.644G	27	5.673G	28	5.528G
29	5.351G	30	5.503G	31	5.577G	32	5.595G
33	5.303G	34	5.572G	35	5.499G	36	5.632G
37	5.688G	38	5.525G	39	5.396G	40	5.315G
41	5.615G	42	5.436G	43	5.620G	44	5.386G
45	5.468G	46	5.712G	47	5.537G	48	5.534G
49	5.394G	50	5.697G	51	5.280G	52	5.488G
53	5.668G	54	5.716G	55	5.316G	56	5.591G
57	5.502G	58	5.392G	59	5.366G	60	5.255G
61	5.308G	62	5.292G	63	5.427G	64	5.327G
65	5.671G	66	5.610G	67	5.254G	68	5.660G
69	5.556G	70	5.553G	71	5.533G	72	5.522G
73	5.719G	74	5.446G	75	5.364G	76	5.439G
77	5.407G	78	5.440G	79	5.624G	80	5.265G
81	5.538G	82	5.710G	83	5.563G	84	5.500G
85	5.259G	86	5.271G	87	5.613G	88	5.698G
89	5.262G	90	5.622G	91	5.561G	92	5.687G
93	5.506G	94	5.648G	95	5.419G	96	5.541G
97	5.575G	98	5.701G	99	5.649G	100	5.551G

Hopping Frequency Sequence Name: HOP_FREQ_SEQ_12							
SEQ#	Frequency (Hz)	SEQ#	Frequency (Hz)	SEQ#	Frequency (Hz)	SEQ#	Frequency (Hz)
1	5.711G	2	5.453G	3	5.383G	4	5.419G
5	5.398G	6	5.591G	7	5.470G	8	5.534G
9	5.411G	10	5.405G	11	5.306G	12	5.264G
13	5.354G	14	5.581G	15	5.406G	16	5.439G
17	5.340G	18	5.585G	19	5.697G	20	5.723G
21	5.274G	22	5.500G	23	5.368G	24	5.358G
25	5.446G	26	5.393G	27	5.332G	28	5.580G
29	5.283G	30	5.372G	31	5.300G	32	5.296G
33	5.321G	34	5.420G	35	5.499G	36	5.484G
37	5.661G	38	5.409G	39	5.478G	40	5.565G
41	5.437G	42	5.506G	43	5.634G	44	5.612G
45	5.289G	46	5.626G	47	5.445G	48	5.620G
49	5.495G	50	5.712G	51	5.665G	52	5.644G
53	5.386G	54	5.452G	55	5.527G	56	5.691G
57	5.288G	58	5.519G	59	5.337G	60	5.258G
61	5.388G	62	5.532G	63	5.394G	64	5.299G
65	5.702G	66	5.682G	67	5.327G	68	5.608G
69	5.267G	70	5.385G	71	5.466G	72	5.415G
73	5.362G	74	5.716G	75	5.647G	76	5.587G
77	5.455G	78	5.520G	79	5.704G	80	5.414G
81	5.444G	82	5.720G	83	5.713G	84	5.373G
85	5.604G	86	5.292G	87	5.593G	88	5.542G
89	5.689G	90	5.325G	91	5.632G	92	5.539G
93	5.594G	94	5.524G	95	5.347G	96	5.724G
97	5.281G	98	5.521G	99	5.605G	100	5.262G

Hopping Frequency Sequence Name: HOP_FREQ_SEQ_13							
SEQ#	Frequency (Hz)	SEQ#	Frequency (Hz)	SEQ#	Frequency (Hz)	SEQ#	Frequency (Hz)
1	5.329G	2	5.719G	3	5.325G	4	5.419G
5	5.606G	6	5.510G	7	5.281G	8	5.571G
9	5.690G	10	5.423G	11	5.716G	12	5.266G
13	5.696G	14	5.607G	15	5.435G	16	5.394G
17	5.308G	18	5.665G	19	5.322G	20	5.600G
21	5.508G	22	5.518G	23	5.348G	24	5.471G
25	5.603G	26	5.724G	27	5.630G	28	5.330G
29	5.318G	30	5.278G	31	5.598G	32	5.405G
33	5.294G	34	5.464G	35	5.649G	36	5.583G
37	5.523G	38	5.663G	39	5.364G	40	5.382G
41	5.358G	42	5.353G	43	5.384G	44	5.277G
45	5.699G	46	5.406G	47	5.527G	48	5.470G
49	5.451G	50	5.568G	51	5.416G	52	5.386G
53	5.656G	54	5.389G	55	5.356G	56	5.501G
57	5.301G	58	5.346G	59	5.480G	60	5.367G
61	5.711G	62	5.529G	63	5.434G	64	5.581G
65	5.547G	66	5.307G	67	5.655G	68	5.582G
69	5.272G	70	5.631G	71	5.713G	72	5.556G
73	5.251G	74	5.397G	75	5.540G	76	5.537G
77	5.392G	78	5.381G	79	5.585G	80	5.575G
81	5.365G	82	5.579G	83	5.459G	84	5.404G
85	5.520G	86	5.639G	87	5.496G	88	5.331G
89	5.366G	90	5.624G	91	5.360G	92	5.698G
93	5.625G	94	5.553G	95	5.669G	96	5.532G
97	5.641G	98	5.629G	99	5.491G	100	5.474G

Hopping Frequency Sequence Name: HOP_FREQ_SEQ_14							
SEQ#	Frequency (Hz)	SEQ#	Frequency (Hz)	SEQ#	Frequency (Hz)	SEQ#	Frequency (Hz)
1	5.564G	2	5.296G	3	5.603G	4	5.441G
5	5.598G	6	5.358G	7	5.287G	8	5.590G
9	5.672G	10	5.569G	11	5.412G	12	5.445G
13	5.377G	14	5.428G	15	5.385G	16	5.500G
17	5.512G	18	5.701G	19	5.258G	20	5.354G
21	5.432G	22	5.717G	23	5.436G	24	5.324G
25	5.298G	26	5.722G	27	5.525G	28	5.661G
29	5.602G	30	5.687G	31	5.562G	32	5.494G
33	5.716G	34	5.269G	35	5.348G	36	5.647G
37	5.585G	38	5.297G	39	5.684G	40	5.643G
41	5.253G	42	5.612G	43	5.375G	44	5.401G
45	5.664G	46	5.678G	47	5.433G	48	5.523G
49	5.652G	50	5.680G	51	5.314G	52	5.552G
53	5.670G	54	5.695G	55	5.316G	56	5.460G
57	5.535G	58	5.620G	59	5.450G	60	5.439G
61	5.359G	62	5.502G	63	5.313G	64	5.328G
65	5.368G	66	5.681G	67	5.263G	68	5.578G
69	5.294G	70	5.629G	71	5.310G	72	5.607G
73	5.322G	74	5.616G	75	5.534G	76	5.673G
77	5.411G	78	5.615G	79	5.536G	80	5.285G
81	5.648G	82	5.330G	83	5.498G	84	5.458G
85	5.374G	86	5.389G	87	5.610G	88	5.274G
89	5.676G	90	5.601G	91	5.495G	92	5.520G
93	5.644G	94	5.521G	95	5.407G	96	5.404G
97	5.437G	98	5.633G	99	5.654G	100	5.267G

Hopping Frequency Sequence Name: HOP_FREQ_SEQ_15							
SEQ#	Frequency (Hz)	SEQ#	Frequency (Hz)	SEQ#	Frequency (Hz)	SEQ#	Frequency (Hz)
1	5.371G	2	5.447G	3	5.295G	4	5.475G
5	5.315G	6	5.417G	7	5.576G	8	5.543G
9	5.274G	10	5.354G	11	5.487G	12	5.286G
13	5.495G	14	5.521G	15	5.527G	16	5.296G
17	5.458G	18	5.549G	19	5.476G	20	5.445G
21	5.613G	22	5.653G	23	5.510G	24	5.656G
25	5.383G	26	5.506G	27	5.273G	28	5.702G
29	5.312G	30	5.331G	31	5.492G	32	5.443G
33	5.522G	34	5.427G	35	5.338G	36	5.674G
37	5.638G	38	5.694G	39	5.636G	40	5.572G
41	5.570G	42	5.419G	43	5.715G	44	5.384G
45	5.645G	46	5.307G	47	5.300G	48	5.633G
49	5.707G	50	5.260G	51	5.683G	52	5.374G
53	5.632G	54	5.666G	55	5.689G	56	5.609G
57	5.563G	58	5.682G	59	5.435G	60	5.252G
61	5.272G	62	5.469G	63	5.375G	64	5.423G
65	5.639G	66	5.403G	67	5.542G	68	5.471G
69	5.512G	70	5.455G	71	5.278G	72	5.405G
73	5.253G	74	5.438G	75	5.473G	76	5.292G
77	5.626G	78	5.343G	79	5.667G	80	5.267G
81	5.498G	82	5.545G	83	5.400G	84	5.655G
85	5.451G	86	5.529G	87	5.285G	88	5.416G
89	5.577G	90	5.325G	91	5.554G	92	5.568G
93	5.519G	94	5.566G	95	5.380G	96	5.693G
97	5.479G	98	5.298G	99	5.481G	100	5.442G

Hopping Frequency Sequence Name: HOP_FREQ_SEQ_16							
SEQ#	Frequency (Hz)	SEQ#	Frequency (Hz)	SEQ#	Frequency (Hz)	SEQ#	Frequency (Hz)
1	5.517G	2	5.386G	3	5.347G	4	5.448G
5	5.356G	6	5.667G	7	5.291G	8	5.538G
9	5.714G	10	5.257G	11	5.387G	12	5.644G
13	5.293G	14	5.504G	15	5.657G	16	5.596G
17	5.480G	18	5.638G	19	5.631G	20	5.682G
21	5.699G	22	5.519G	23	5.696G	24	5.558G
25	5.721G	26	5.705G	27	5.358G	28	5.365G
29	5.641G	30	5.399G	31	5.462G	32	5.340G
33	5.625G	34	5.254G	35	5.713G	36	5.272G
37	5.343G	38	5.712G	39	5.686G	40	5.666G
41	5.264G	42	5.718G	43	5.273G	44	5.430G
45	5.453G	46	5.537G	47	5.630G	48	5.674G
49	5.385G	50	5.455G	51	5.433G	52	5.389G
53	5.550G	54	5.336G	55	5.577G	56	5.582G
57	5.529G	58	5.578G	59	5.408G	60	5.594G
61	5.524G	62	5.518G	63	5.307G	64	5.417G
65	5.299G	66	5.338G	67	5.393G	68	5.319G
69	5.405G	70	5.516G	71	5.391G	72	5.560G
73	5.411G	74	5.655G	75	5.653G	76	5.328G
77	5.499G	78	5.348G	79	5.722G	80	5.521G
81	5.341G	82	5.506G	83	5.422G	84	5.324G
85	5.645G	86	5.583G	87	5.597G	88	5.684G
89	5.271G	90	5.419G	91	5.672G	92	5.364G
93	5.279G	94	5.315G	95	5.366G	96	5.624G
97	5.494G	98	5.255G	99	5.382G	100	5.440G

Hopping Frequency Sequence Name: HOP_FREQ_SEQ_17							
SEQ#	Frequency (Hz)	SEQ#	Frequency (Hz)	SEQ#	Frequency (Hz)	SEQ#	Frequency (Hz)
1	5.506G	2	5.256G	3	5.686G	4	5.406G
5	5.443G	6	5.716G	7	5.719G	8	5.660G
9	5.519G	10	5.690G	11	5.569G	12	5.365G
13	5.645G	14	5.654G	15	5.417G	16	5.402G
17	5.625G	18	5.477G	19	5.277G	20	5.388G
21	5.580G	22	5.581G	23	5.682G	24	5.289G
25	5.607G	26	5.720G	27	5.634G	28	5.263G
29	5.395G	30	5.513G	31	5.511G	32	5.677G
33	5.692G	34	5.463G	35	5.383G	36	5.604G
37	5.687G	38	5.614G	39	5.315G	40	5.502G
41	5.309G	42	5.526G	43	5.662G	44	5.352G
45	5.495G	46	5.508G	47	5.487G	48	5.366G
49	5.313G	50	5.343G	51	5.599G	52	5.320G
53	5.430G	54	5.408G	55	5.629G	56	5.722G
57	5.585G	58	5.706G	59	5.280G	60	5.387G
61	5.415G	62	5.381G	63	5.510G	64	5.471G
65	5.299G	66	5.566G	67	5.550G	68	5.468G
69	5.563G	70	5.393G	71	5.691G	72	5.539G
73	5.721G	74	5.707G	75	5.681G	76	5.591G
77	5.536G	78	5.701G	79	5.708G	80	5.621G
81	5.453G	82	5.715G	83	5.446G	84	5.254G
85	5.649G	86	5.276G	87	5.449G	88	5.357G
89	5.396G	90	5.622G	91	5.638G	92	5.287G
93	5.616G	94	5.680G	95	5.610G	96	5.601G
97	5.259G	98	5.483G	99	5.596G	100	5.640G

Hopping Frequency Sequence Name: HOP_FREQ_SEQ_18							
SEQ#	Frequency (Hz)	SEQ#	Frequency (Hz)	SEQ#	Frequency (Hz)	SEQ#	Frequency (Hz)
1	5.710G	2	5.546G	3	5.289G	4	5.331G
5	5.419G	6	5.552G	7	5.663G	8	5.543G
9	5.467G	10	5.330G	11	5.435G	12	5.603G
13	5.724G	14	5.634G	15	5.469G	16	5.495G
17	5.259G	18	5.581G	19	5.487G	20	5.563G
21	5.610G	22	5.651G	23	5.407G	24	5.699G
25	5.398G	26	5.612G	27	5.387G	28	5.277G
29	5.712G	30	5.571G	31	5.444G	32	5.607G
33	5.290G	34	5.388G	35	5.601G	36	5.297G
37	5.293G	38	5.465G	39	5.349G	40	5.381G
41	5.723G	42	5.428G	43	5.448G	44	5.284G
45	5.510G	46	5.527G	47	5.504G	48	5.598G
49	5.609G	50	5.362G	51	5.640G	52	5.458G
53	5.393G	54	5.347G	55	5.478G	56	5.568G
57	5.451G	58	5.320G	59	5.459G	60	5.368G
61	5.644G	62	5.673G	63	5.449G	64	5.391G
65	5.375G	66	5.570G	67	5.309G	68	5.540G
69	5.692G	70	5.539G	71	5.698G	72	5.691G
73	5.285G	74	5.361G	75	5.281G	76	5.486G
77	5.628G	78	5.721G	79	5.573G	80	5.605G
81	5.295G	82	5.376G	83	5.298G	84	5.355G
85	5.536G	86	5.338G	87	5.709G	88	5.390G
89	5.575G	90	5.475G	91	5.429G	92	5.503G
93	5.505G	94	5.516G	95	5.464G	96	5.493G
97	5.574G	98	5.311G	99	5.319G	100	5.565G

Hopping Frequency Sequence Name: HOP_FREQ_SEQ_19							
SEQ#	Frequency (Hz)	SEQ#	Frequency (Hz)	SEQ#	Frequency (Hz)	SEQ#	Frequency (Hz)
1	5.538G	2	5.393G	3	5.323G	4	5.571G
5	5.643G	6	5.353G	7	5.660G	8	5.668G
9	5.459G	10	5.454G	11	5.665G	12	5.573G
13	5.400G	14	5.277G	15	5.498G	16	5.406G
17	5.424G	18	5.595G	19	5.696G	20	5.597G
21	5.664G	22	5.255G	23	5.639G	24	5.389G
25	5.514G	26	5.576G	27	5.536G	28	5.642G
29	5.366G	30	5.336G	31	5.431G	32	5.518G
33	5.482G	34	5.345G	35	5.532G	36	5.297G
37	5.321G	38	5.589G	39	5.474G	40	5.686G
41	5.445G	42	5.362G	43	5.702G	44	5.288G
45	5.456G	46	5.631G	47	5.259G	48	5.577G
49	5.282G	50	5.387G	51	5.372G	52	5.303G
53	5.593G	54	5.635G	55	5.477G	56	5.691G
57	5.339G	58	5.446G	59	5.275G	60	5.533G
61	5.697G	62	5.606G	63	5.414G	64	5.268G
65	5.652G	66	5.442G	67	5.687G	68	5.348G
69	5.318G	70	5.542G	71	5.319G	72	5.616G
73	5.250G	74	5.556G	75	5.486G	76	5.419G
77	5.695G	78	5.379G	79	5.545G	80	5.401G
81	5.485G	82	5.280G	83	5.548G	84	5.262G
85	5.363G	86	5.581G	87	5.516G	88	5.554G
89	5.579G	90	5.596G	91	5.376G	92	5.479G
93	5.563G	94	5.505G	95	5.298G	96	5.347G
97	5.549G	98	5.524G	99	5.410G	100	5.291G

Hopping Frequency Sequence Name: HOP_FREQ_SEQ_20							
SEQ#	Frequency (Hz)	SEQ#	Frequency (Hz)	SEQ#	Frequency (Hz)	SEQ#	Frequency (Hz)
1	5.674G	2	5.475G	3	5.290G	4	5.341G
5	5.404G	6	5.336G	7	5.428G	8	5.429G
9	5.583G	10	5.611G	11	5.608G	12	5.511G
13	5.427G	14	5.305G	15	5.701G	16	5.619G
17	5.303G	18	5.626G	19	5.684G	20	5.719G
21	5.614G	22	5.301G	23	5.355G	24	5.252G
25	5.327G	26	5.379G	27	5.682G	28	5.395G
29	5.576G	30	5.575G	31	5.293G	32	5.461G
33	5.538G	34	5.493G	35	5.348G	36	5.268G
37	5.665G	38	5.332G	39	5.699G	40	5.679G
41	5.598G	42	5.484G	43	5.307G	44	5.559G
45	5.331G	46	5.383G	47	5.660G	48	5.451G
49	5.328G	50	5.573G	51	5.693G	52	5.387G
53	5.636G	54	5.605G	55	5.285G	56	5.691G
57	5.506G	58	5.510G	59	5.597G	60	5.476G
61	5.666G	62	5.517G	63	5.600G	64	5.337G
65	5.500G	66	5.460G	67	5.703G	68	5.425G
69	5.670G	70	5.555G	71	5.564G	72	5.250G
73	5.570G	74	5.507G	75	5.596G	76	5.482G
77	5.519G	78	5.662G	79	5.257G	80	5.491G
81	5.412G	82	5.292G	83	5.400G	84	5.295G
85	5.525G	86	5.453G	87	5.560G	88	5.592G
89	5.364G	90	5.494G	91	5.687G	92	5.351G
93	5.297G	94	5.577G	95	5.612G	96	5.463G
97	5.349G	98	5.552G	99	5.492G	100	5.546G

Hopping Frequency Sequence Name: HOP_FREQ_SEQ_21							
SEQ#	Frequency (Hz)	SEQ#	Frequency (Hz)	SEQ#	Frequency (Hz)	SEQ#	Frequency (Hz)
1	5.270G	2	5.525G	3	5.527G	4	5.628G
5	5.402G	6	5.639G	7	5.615G	8	5.369G
9	5.302G	10	5.456G	11	5.250G	12	5.407G
13	5.362G	14	5.435G	15	5.252G	16	5.698G
17	5.660G	18	5.442G	19	5.385G	20	5.359G
21	5.685G	22	5.263G	23	5.404G	24	5.387G
25	5.661G	26	5.510G	27	5.449G	28	5.395G
29	5.704G	30	5.496G	31	5.467G	32	5.554G
33	5.257G	34	5.393G	35	5.305G	36	5.572G
37	5.700G	38	5.373G	39	5.548G	40	5.320G
41	5.392G	42	5.296G	43	5.274G	44	5.610G
45	5.611G	46	5.581G	47	5.409G	48	5.390G
49	5.451G	50	5.376G	51	5.417G	52	5.523G
53	5.282G	54	5.432G	55	5.546G	56	5.497G
57	5.355G	58	5.276G	59	5.342G	60	5.327G
61	5.637G	62	5.289G	63	5.293G	64	5.539G
65	5.627G	66	5.379G	67	5.299G	68	5.427G
69	5.595G	70	5.553G	71	5.315G	72	5.669G
73	5.709G	74	5.405G	75	5.587G	76	5.360G
77	5.663G	78	5.461G	79	5.565G	80	5.275G
81	5.308G	82	5.487G	83	5.620G	84	5.540G
85	5.469G	86	5.561G	87	5.545G	88	5.597G
89	5.536G	90	5.506G	91	5.318G	92	5.697G
93	5.295G	94	5.519G	95	5.560G	96	5.389G
97	5.719G	98	5.654G	99	5.336G	100	5.608G

Hopping Frequency Sequence Name: HOP_FREQ_SEQ_22							
SEQ#	Frequency (Hz)	SEQ#	Frequency (Hz)	SEQ#	Frequency (Hz)	SEQ#	Frequency (Hz)
1	5.288G	2	5.441G	3	5.682G	4	5.304G
5	5.313G	6	5.446G	7	5.442G	8	5.612G
9	5.345G	10	5.337G	11	5.557G	12	5.638G
13	5.427G	14	5.303G	15	5.298G	16	5.592G
17	5.267G	18	5.717G	19	5.568G	20	5.320G
21	5.697G	22	5.541G	23	5.667G	24	5.506G
25	5.423G	26	5.518G	27	5.575G	28	5.413G
29	5.527G	30	5.283G	31	5.709G	32	5.469G
33	5.554G	34	5.418G	35	5.250G	36	5.495G
37	5.366G	38	5.681G	39	5.716G	40	5.471G
41	5.302G	42	5.628G	43	5.534G	44	5.698G
45	5.439G	46	5.510G	47	5.673G	48	5.408G
49	5.624G	50	5.280G	51	5.473G	52	5.676G
53	5.582G	54	5.400G	55	5.648G	56	5.383G
57	5.626G	58	5.358G	59	5.296G	60	5.641G
61	5.690G	62	5.608G	63	5.365G	64	5.397G
65	5.629G	66	5.647G	67	5.620G	68	5.493G
69	5.417G	70	5.570G	71	5.596G	72	5.581G
73	5.285G	74	5.606G	75	5.654G	76	5.445G
77	5.318G	78	5.404G	79	5.553G	80	5.335G
81	5.378G	82	5.505G	83	5.694G	84	5.487G
85	5.715G	86	5.269G	87	5.552G	88	5.287G
89	5.315G	90	5.289G	91	5.422G	92	5.431G
93	5.569G	94	5.507G	95	5.478G	96	5.464G
97	5.702G	98	5.347G	99	5.275G	100	5.409G

Hopping Frequency Sequence Name: HOP_FREQ_SEQ_23							
SEQ#	Frequency (Hz)	SEQ#	Frequency (Hz)	SEQ#	Frequency (Hz)	SEQ#	Frequency (Hz)
1	5.521G	2	5.425G	3	5.711G	4	5.694G
5	5.679G	6	5.449G	7	5.723G	8	5.440G
9	5.279G	10	5.442G	11	5.700G	12	5.326G
13	5.286G	14	5.608G	15	5.664G	16	5.265G
17	5.395G	18	5.687G	19	5.258G	20	5.656G
21	5.348G	22	5.319G	23	5.306G	24	5.412G
25	5.624G	26	5.556G	27	5.420G	28	5.457G
29	5.404G	30	5.693G	31	5.640G	32	5.606G
33	5.627G	34	5.367G	35	5.387G	36	5.401G
37	5.441G	38	5.580G	39	5.398G	40	5.274G
41	5.323G	42	5.651G	43	5.386G	44	5.683G
45	5.300G	46	5.283G	47	5.655G	48	5.638G
49	5.487G	50	5.705G	51	5.358G	52	5.600G
53	5.559G	54	5.261G	55	5.614G	56	5.581G
57	5.409G	58	5.424G	59	5.322G	60	5.292G
61	5.263G	62	5.667G	63	5.682G	64	5.397G
65	5.264G	66	5.482G	67	5.713G	68	5.302G
69	5.650G	70	5.572G	71	5.464G	72	5.686G
73	5.351G	74	5.562G	75	5.573G	76	5.355G
77	5.724G	78	5.550G	79	5.476G	80	5.603G
81	5.450G	82	5.601G	83	5.684G	84	5.592G
85	5.354G	86	5.255G	87	5.359G	88	5.568G
89	5.702G	90	5.692G	91	5.336G	92	5.639G
93	5.484G	94	5.637G	95	5.477G	96	5.520G
97	5.327G	98	5.378G	99	5.461G	100	5.501G

Hopping Frequency Sequence Name: HOP_FREQ_SEQ_24							
SEQ#	Frequency (Hz)	SEQ#	Frequency (Hz)	SEQ#	Frequency (Hz)	SEQ#	Frequency (Hz)
1	5.461G	2	5.451G	3	5.572G	4	5.600G
5	5.561G	6	5.338G	7	5.515G	8	5.403G
9	5.527G	10	5.628G	11	5.654G	12	5.544G
13	5.367G	14	5.353G	15	5.665G	16	5.573G
17	5.377G	18	5.534G	19	5.432G	20	5.621G
21	5.302G	22	5.414G	23	5.560G	24	5.574G
25	5.381G	26	5.533G	27	5.546G	28	5.404G
29	5.700G	30	5.325G	31	5.355G	32	5.685G
33	5.588G	34	5.625G	35	5.294G	36	5.505G
37	5.344G	38	5.352G	39	5.630G	40	5.599G
41	5.430G	42	5.495G	43	5.431G	44	5.253G
45	5.714G	46	5.258G	47	5.691G	48	5.719G
49	5.287G	50	5.557G	51	5.623G	52	5.343G
53	5.682G	54	5.717G	55	5.408G	56	5.526G
57	5.569G	58	5.393G	59	5.452G	60	5.549G
61	5.705G	62	5.375G	63	5.271G	64	5.264G
65	5.470G	66	5.674G	67	5.312G	68	5.389G
69	5.341G	70	5.358G	71	5.394G	72	5.440G
73	5.493G	74	5.538G	75	5.604G	76	5.699G
77	5.554G	78	5.586G	79	5.380G	80	5.454G
81	5.662G	82	5.304G	83	5.443G	84	5.267G
85	5.649G	86	5.364G	87	5.487G	88	5.636G
89	5.276G	90	5.360G	91	5.722G	92	5.694G
93	5.616G	94	5.255G	95	5.351G	96	5.424G
97	5.279G	98	5.663G	99	5.382G	100	5.373G

Hopping Frequency Sequence Name: HOP_FREQ_SEQ_25							
SEQ#	Frequency (Hz)	SEQ#	Frequency (Hz)	SEQ#	Frequency (Hz)	SEQ#	Frequency (Hz)
1	5.536G	2	5.267G	3	5.257G	4	5.254G
5	5.720G	6	5.325G	7	5.329G	8	5.393G
9	5.689G	10	5.621G	11	5.601G	12	5.464G
13	5.700G	14	5.261G	15	5.418G	16	5.270G
17	5.417G	18	5.702G	19	5.341G	20	5.565G
21	5.573G	22	5.310G	23	5.537G	24	5.612G
25	5.495G	26	5.314G	27	5.714G	28	5.723G
29	5.292G	30	5.369G	31	5.401G	32	5.378G
33	5.716G	34	5.311G	35	5.667G	36	5.455G
37	5.467G	38	5.336G	39	5.520G	40	5.600G
41	5.535G	42	5.595G	43	5.604G	44	5.363G
45	5.696G	46	5.472G	47	5.677G	48	5.598G
49	5.425G	50	5.391G	51	5.660G	52	5.650G
53	5.352G	54	5.586G	55	5.360G	56	5.371G
57	5.532G	58	5.420G	59	5.692G	60	5.454G
61	5.579G	62	5.539G	63	5.617G	64	5.516G
65	5.498G	66	5.649G	67	5.452G	68	5.514G
69	5.412G	70	5.293G	71	5.668G	72	5.574G
73	5.547G	74	5.424G	75	5.326G	76	5.722G
77	5.524G	78	5.289G	79	5.258G	80	5.713G
81	5.451G	82	5.251G	83	5.618G	84	5.357G
85	5.446G	86	5.348G	87	5.427G	88	5.681G
89	5.544G	90	5.260G	91	5.606G	92	5.280G
93	5.501G	94	5.438G	95	5.474G	96	5.284G
97	5.382G	98	5.376G	99	5.444G	100	5.496G

Hopping Frequency Sequence Name: HOP_FREQ_SEQ_26							
SEQ#	Frequency (Hz)	SEQ#	Frequency (Hz)	SEQ#	Frequency (Hz)	SEQ#	Frequency (Hz)
1	5.635G	2	5.651G	3	5.269G	4	5.372G
5	5.328G	6	5.410G	7	5.344G	8	5.563G
9	5.250G	10	5.420G	11	5.549G	12	5.565G
13	5.346G	14	5.682G	15	5.548G	16	5.632G
17	5.573G	18	5.614G	19	5.376G	20	5.690G
21	5.495G	22	5.409G	23	5.348G	24	5.648G
25	5.469G	26	5.666G	27	5.272G	28	5.408G
29	5.584G	30	5.571G	31	5.553G	32	5.425G
33	5.512G	34	5.619G	35	5.386G	36	5.368G
37	5.318G	38	5.620G	39	5.609G	40	5.336G
41	5.560G	42	5.424G	43	5.610G	44	5.429G
45	5.433G	46	5.680G	47	5.313G	48	5.366G
49	5.576G	50	5.396G	51	5.669G	52	5.663G
53	5.283G	54	5.562G	55	5.270G	56	5.697G
57	5.481G	58	5.668G	59	5.533G	60	5.688G
61	5.487G	62	5.305G	63	5.389G	64	5.589G
65	5.296G	66	5.364G	67	5.597G	68	5.494G
69	5.419G	70	5.698G	71	5.427G	72	5.662G
73	5.397G	74	5.261G	75	5.444G	76	5.465G
77	5.678G	78	5.498G	79	5.684G	80	5.629G
81	5.464G	82	5.282G	83	5.251G	84	5.700G
85	5.473G	86	5.634G	87	5.567G	88	5.380G
89	5.460G	90	5.468G	91	5.362G	92	5.527G
93	5.539G	94	5.720G	95	5.439G	96	5.704G
97	5.438G	98	5.339G	99	5.583G	100	5.486G

Hopping Frequency Sequence Name: HOP_FREQ_SEQ_27							
SEQ#	Frequency (Hz)	SEQ#	Frequency (Hz)	SEQ#	Frequency (Hz)	SEQ#	Frequency (Hz)
1	5.370G	2	5.453G	3	5.644G	4	5.308G
5	5.373G	6	5.503G	7	5.257G	8	5.336G
9	5.387G	10	5.669G	11	5.319G	12	5.548G
13	5.273G	14	5.334G	15	5.663G	16	5.428G
17	5.492G	18	5.638G	19	5.295G	20	5.388G
21	5.512G	22	5.513G	23	5.455G	24	5.405G
25	5.496G	26	5.538G	27	5.596G	28	5.654G
29	5.368G	30	5.674G	31	5.279G	32	5.696G
33	5.277G	34	5.718G	35	5.600G	36	5.327G
37	5.660G	38	5.714G	39	5.723G	40	5.631G
41	5.539G	42	5.420G	43	5.482G	44	5.353G
45	5.345G	46	5.702G	47	5.390G	48	5.668G
49	5.349G	50	5.480G	51	5.534G	52	5.583G
53	5.256G	54	5.526G	55	5.643G	56	5.304G
57	5.435G	58	5.377G	59	5.264G	60	5.656G
61	5.450G	62	5.448G	63	5.298G	64	5.697G
65	5.282G	66	5.468G	67	5.586G	68	5.430G
69	5.561G	70	5.576G	71	5.401G	72	5.402G
73	5.553G	74	5.568G	75	5.323G	76	5.281G
77	5.285G	78	5.381G	79	5.270G	80	5.635G
81	5.577G	82	5.486G	83	5.684G	84	5.602G
85	5.374G	86	5.708G	87	5.501G	88	5.592G
89	5.499G	90	5.484G	91	5.682G	92	5.607G
93	5.507G	94	5.375G	95	5.678G	96	5.641G
97	5.646G	98	5.557G	99	5.588G	100	5.691G

Hopping Frequency Sequence Name: HOP_FREQ_SEQ_28							
SEQ#	Frequency (Hz)	SEQ#	Frequency (Hz)	SEQ#	Frequency (Hz)	SEQ#	Frequency (Hz)
1	5.347G	2	5.450G	3	5.355G	4	5.604G
5	5.544G	6	5.673G	7	5.325G	8	5.523G
9	5.721G	10	5.585G	11	5.703G	12	5.475G
13	5.390G	14	5.525G	15	5.337G	16	5.267G
17	5.285G	18	5.320G	19	5.322G	20	5.281G
21	5.682G	22	5.675G	23	5.718G	24	5.669G
25	5.279G	26	5.269G	27	5.265G	28	5.636G
29	5.677G	30	5.483G	31	5.376G	32	5.495G
33	5.535G	34	5.335G	35	5.601G	36	5.275G
37	5.349G	38	5.368G	39	5.552G	40	5.521G
41	5.411G	42	5.417G	43	5.457G	44	5.303G
45	5.366G	46	5.709G	47	5.437G	48	5.292G
49	5.536G	50	5.298G	51	5.405G	52	5.333G
53	5.658G	54	5.354G	55	5.657G	56	5.623G
57	5.403G	58	5.421G	59	5.534G	60	5.491G
61	5.582G	62	5.713G	63	5.546G	64	5.428G
65	5.459G	66	5.435G	67	5.512G	68	5.352G
69	5.280G	70	5.440G	71	5.338G	72	5.487G
73	5.426G	74	5.288G	75	5.722G	76	5.705G
77	5.704G	78	5.628G	79	5.538G	80	5.478G
81	5.602G	82	5.434G	83	5.710G	84	5.441G
85	5.315G	86	5.717G	87	5.714G	88	5.569G
89	5.592G	90	5.461G	91	5.344G	92	5.622G
93	5.511G	94	5.460G	95	5.409G	96	5.668G
97	5.264G	98	5.517G	99	5.584G	100	5.259G

Hopping Frequency Sequence Name: HOP_FREQ_SEQ_29							
SEQ#	Frequency (Hz)	SEQ#	Frequency (Hz)	SEQ#	Frequency (Hz)	SEQ#	Frequency (Hz)
1	5.449G	2	5.476G	3	5.473G	4	5.397G
5	5.508G	6	5.695G	7	5.656G	8	5.679G
9	5.435G	10	5.293G	11	5.618G	12	5.439G
13	5.468G	14	5.521G	15	5.563G	16	5.462G
17	5.633G	18	5.641G	19	5.533G	20	5.669G
21	5.486G	22	5.627G	23	5.403G	24	5.348G
25	5.614G	26	5.529G	27	5.671G	28	5.549G
29	5.638G	30	5.295G	31	5.518G	32	5.255G
33	5.432G	34	5.277G	35	5.709G	36	5.535G
37	5.286G	38	5.557G	39	5.619G	40	5.719G
41	5.259G	42	5.320G	43	5.639G	44	5.429G
45	5.451G	46	5.603G	47	5.382G	48	5.341G
49	5.357G	50	5.714G	51	5.377G	52	5.423G
53	5.580G	54	5.314G	55	5.335G	56	5.543G
57	5.278G	58	5.406G	59	5.676G	60	5.454G
61	5.591G	62	5.433G	63	5.632G	64	5.532G
65	5.697G	66	5.422G	67	5.478G	68	5.321G
69	5.381G	70	5.569G	71	5.398G	72	5.272G
73	5.500G	74	5.635G	75	5.280G	76	5.323G
77	5.516G	78	5.299G	79	5.710G	80	5.620G
81	5.675G	82	5.345G	83	5.362G	84	5.498G
85	5.322G	86	5.339G	87	5.552G	88	5.648G
89	5.541G	90	5.523G	91	5.337G	92	5.380G
93	5.650G	94	5.326G	95	5.418G	96	5.502G
97	5.351G	98	5.264G	99	5.626G	100	5.565G

Hopping Frequency Sequence Name: HOP_FREQ_SEQ_30							
SEQ#	Frequency (Hz)	SEQ#	Frequency (Hz)	SEQ#	Frequency (Hz)	SEQ#	Frequency (Hz)
1	5.672G	2	5.293G	3	5.512G	4	5.436G
5	5.415G	6	5.447G	7	5.336G	8	5.636G
9	5.316G	10	5.650G	11	5.392G	12	5.567G
13	5.600G	14	5.668G	15	5.696G	16	5.459G
17	5.305G	18	5.396G	19	5.574G	20	5.587G
21	5.623G	22	5.644G	23	5.724G	24	5.442G
25	5.294G	26	5.548G	27	5.253G	28	5.443G
29	5.542G	30	5.258G	31	5.261G	32	5.353G
33	5.515G	34	5.430G	35	5.648G	36	5.344G
37	5.296G	38	5.462G	39	5.514G	40	5.709G
41	5.562G	42	5.622G	43	5.540G	44	5.365G
45	5.417G	46	5.255G	47	5.513G	48	5.639G
49	5.621G	50	5.494G	51	5.358G	52	5.398G
53	5.700G	54	5.569G	55	5.378G	56	5.420G
57	5.444G	58	5.572G	59	5.362G	60	5.297G
61	5.712G	62	5.519G	63	5.303G	64	5.505G
65	5.486G	66	5.466G	67	5.597G	68	5.427G
69	5.448G	70	5.460G	71	5.310G	72	5.502G
73	5.590G	74	5.487G	75	5.625G	76	5.581G
77	5.431G	78	5.723G	79	5.545G	80	5.264G
81	5.651G	82	5.338G	83	5.301G	84	5.299G
85	5.346G	86	5.713G	87	5.282G	88	5.286G
89	5.559G	90	5.593G	91	5.533G	92	5.278G
93	5.266G	94	5.332G	95	5.380G	96	5.350G
97	5.483G	98	5.682G	99	5.414G	100	5.428G

IEEE 802.11AC 80MHz

Type 1 Radar Statistical Performances					
Trial #	Pulses per Burst	Pulse Width (s)	PRI (s)	Radar Frequency	Detection
1	99	1.0u	538.0u	5490	Yes
2	95	1.0u	558.0u	5492	Yes
3	89	1.0u	598.0u	5495	Yes
4	83	1.0u	638.0u	5498	Yes
5	81	1.0u	658.0u	5503	Yes
6	78	1.0u	678.0u	5508	Yes
7	76	1.0u	698.0u	5510	Yes
8	72	1.0u	738.0u	5513	Yes
9	65	1.0u	818.0u	5518	Yes
10	63	1.0u	838.0u	5523	Yes
11	62	1.0u	858.0u	5525	Yes
12	61	1.0u	878.0u	5527	Yes
13	59	1.0u	898.0u	5528	Yes
14	58	1.0u	918.0u	5529	Yes
15	57	1.0u	938.0u	5530	Yes
16	18	1.0u	3.066m	5530	Yes
17	83	1.0u	639.0u	5531	Yes
18	68	1.0u	787.0u	5532	Yes
19	97	1.0u	549.0u	5533	Yes
20	77	1.0u	689.0u	5535	Yes
21	60	1.0u	889.0u	5537	Yes
22	24	1.0u	2.215m	5542	Yes
23	77	1.0u	691.0u	5547	Yes
24	63	1.0u	851.0u	5550	Yes
25	96	1.0u	553.0u	5552	Yes
26	67	1.0u	793.0u	5557	Yes
27	99	1.0u	535.0u	5562	Yes
28	74	1.0u	715.0u	5565	Yes
29	19	1.0u	2.853m	5568	Yes
30	61	1.0u	877.0u	5570	Yes
Detection Rate: 100.0 %					

Type 2 Radar Statistical Performances					
Trial #	Pulses per Burst	Pulse Width (s)	PRI (s)	Radar Frequency	Detection
1	26	4.5u	178.0u	5490	Yes
2	28	2.4u	183.0u	5492	No
3	25	3.0u	208.0u	5495	No
4	26	3.5u	157.0u	5498	Yes
5	26	3.1u	189.0u	5503	Yes
6	29	2.9u	176.0u	5508	Yes
7	28	3.5u	177.0u	5510	Yes
8	27	4.3u	211.0u	5513	Yes
9	28	3.7u	168.0u	5518	Yes
10	26	2.7u	181.0u	5523	Yes
11	23	2.7u	217.0u	5525	Yes
12	27	3.8u	225.0u	5527	Yes
13	26	2.0u	216.0u	5528	Yes
14	25	4.3u	164.0u	5529	Yes
15	29	4.3u	170.0u	5530	Yes
16	28	4.9u	180.0u	5530	Yes
17	29	2.1u	196.0u	5531	Yes
18	28	4.5u	207.0u	5532	Yes
19	25	4.4u	157.0u	5533	Yes
20	26	2.6u	212.0u	5535	Yes
21	29	3.9u	184.0u	5537	Yes
22	26	3.9u	197.0u	5542	No
23	25	4.6u	157.0u	5547	Yes
24	28	1.3u	175.0u	5550	Yes
25	26	1.9u	212.0u	5552	Yes
26	26	3.1u	191.0u	5557	Yes
27	29	3.6u	174.0u	5562	Yes
28	25	4.0u	174.0u	5565	Yes
29	27	2.5u	197.0u	5568	Yes
30	27	3.2u	226.0u	5570	Yes
Detection Rate: 90.0 %					

Type 3 Radar Statistical Performances					
Trial #	Pulses per Burst	Pulse Width (s)	PRI (s)	Radar Frequency	Detection
1	16	7.5u	305.0u	5490	No
2	16	9.7u	274.0u	5492	Yes
3	17	7.6u	422.0u	5495	Yes
4	17	7.4u	436.0u	5498	Yes
5	17	8.7u	460.0u	5503	Yes
6	17	9.0u	389.0u	5508	Yes
7	17	8.3u	381.0u	5510	Yes
8	17	6.8u	273.0u	5513	Yes
9	17	9.4u	346.0u	5518	No
10	16	8.1u	342.0u	5523	Yes
11	17	9.8u	497.0u	5525	Yes
12	18	6.6u	254.0u	5527	No
13	17	9.7u	384.0u	5528	Yes
14	17	7.6u	243.0u	5529	No
15	18	7.5u	348.0u	5530	Yes
16	16	6.9u	284.0u	5530	Yes
17	17	8.0u	272.0u	5531	No
18	17	8.8u	395.0u	5532	Yes
19	17	7.5u	453.0u	5533	Yes
20	18	7.7u	263.0u	5535	Yes
21	17	9.1u	384.0u	5537	Yes
22	17	8.2u	226.0u	5542	Yes
23	17	6.7u	474.0u	5547	Yes
24	16	8.5u	429.0u	5550	Yes
25	16	7.3u	301.0u	5552	Yes
26	17	9.6u	271.0u	5557	Yes
27	18	9.3u	375.0u	5562	Yes
28	18	8.5u	254.0u	5565	Yes
29	16	9.2u	428.0u	5568	No
30	17	8.5u	318.0u	5570	Yes
Detection Rate: 80.0 %					

Type 4 Radar Statistical Performances					
Trial #	Pulses per Burst	Pulse Width (s)	PRI (s)	Radar Frequency	Detection
1	14	16.1u	359.0u	5490	Yes
2	12	19.9u	419.0u	5492	Yes
3	15	19.1u	300.0u	5495	No
4	12	16.5u	497.0u	5498	Yes
5	16	11.5u	347.0u	5503	Yes
6	15	17.7u	333.0u	5508	Yes
7	15	13.0u	396.0u	5510	Yes
8	16	12.4u	326.0u	5513	Yes
9	14	17.7u	309.0u	5518	Yes
10	14	17.9u	416.0u	5523	Yes
11	14	14.4u	441.0u	5525	Yes
12	14	11.4u	305.0u	5527	Yes
13	13	17.2u	203.0u	5528	Yes
14	16	16.1u	371.0u	5529	Yes
15	15	19.9u	204.0u	5530	Yes
16	12	12.8u	444.0u	5530	Yes
17	15	15.6u	415.0u	5531	No
18	14	19.7u	321.0u	5532	Yes
19	14	19.9u	499.0u	5533	Yes
20	13	13.1u	438.0u	5535	Yes
21	15	16.6u	432.0u	5537	Yes
22	13	18.1u	351.0u	5542	Yes
23	16	18.6u	382.0u	5547	Yes
24	15	19.2u	484.0u	5550	Yes
25	16	15.7u	496.0u	5552	Yes
26	15	13.7u	368.0u	5557	No
27	13	17.7u	311.0u	5562	Yes
28	13	13.8u	368.0u	5565	Yes
29	13	19.1u	404.0u	5568	Yes
30	13	15.2u	226.0u	5570	Yes
Detection Rate: 90.0 %					

Type 5 Radar Statistical Performances		
Trial #	Test Signal Name	Detection
1	LP_Signal_01	No
2	LP_Signal_02	No
3	LP_Signal_03	Yes
4	LP_Signal_04	Yes
5	LP_Signal_05	Yes
6	LP_Signal_06	Yes
7	LP_Signal_07	Yes
8	LP_Signal_08	Yes
9	LP_Signal_09	Yes
10	LP_Signal_10	Yes
11	LP_Signal_11	Yes
12	LP_Signal_12	Yes
13	LP_Signal_13	Yes
14	LP_Signal_14	Yes
15	LP_Signal_15	Yes
16	LP_Signal_16	Yes
17	LP_Signal_17	No
18	LP_Signal_18	No
19	LP_Signal_19	Yes
20	LP_Signal_20	Yes
21	LP_Signal_21	Yes
22	LP_Signal_22	Yes
23	LP_Signal_23	Yes
24	LP_Signal_24	Yes
25	LP_Signal_25	Yes
26	LP_Signal_26	Yes
27	LP_Signal_27	Yes
28	LP_Signal_28	Yes
29	LP_Signal_29	Yes
30	LP_Signal_30	Yes
		Detection Rate: 86.7 %

Long Pulse Radar Test Signal						
Test Signal Name: LP_Signal_01						
Number of Bursts in Trial: 19						
Chrip Center Frequency: 5493MHz						
Burst	Pulses per Burst	Chrip (Hz)	Pulse Width (s)	Pulse 1 to 2 Spacing (s)	Pulse 2 to 3 Spacing (s)	Start Location (s)
1	2	5M	50.4u	1.916m	-	334.6m
2	2	5M	54.2u	1.760m	-	40.17m
3	2	5M	66.7u	1.591m	-	375.0m
4	1	5M	81.8u	-	-	224.8m
5	3	5M	85.3u	1.562m	1.550m	598.5m
6	2	5M	50.9u	1.097m	-	247.8m
7	3	5M	71.5u	1.403m	1.250m	384.9m
8	1	5M	57.3u	-	-	545.1m
9	1	5M	99.4u	-	-	327.7m
10	2	5M	81.7u	1.762m	-	346.5m
11	3	5M	87.0u	1.625m	1.683m	237.2m
12	2	5M	94.9u	1.522m	-	585.4m
13	2	5M	83.5u	1.529m	-	480.1m
14	2	5M	66.1u	1.677m	-	545.9m
15	2	5M	52.9u	1.709m	-	563.8m
16	3	5M	51.5u	1.865m	1.887m	433.2m
17	1	5M	82.8u	-	-	4.846m
18	2	5M	84.6u	957.4u	-	397.1m
19	3	5M	70.6u	1.247m	1.791m	432.2m

Long Pulse Radar Test Signal						
Test Signal Name: LP_Signal_02						
Number of Bursts in Trial: 9						
Chrip Center Frequency: 5494MHz						
Burst	Pulses per Burst	Chrip (Hz)	Pulse Width (s)	Pulse 1 to 2 Spacing (s)	Pulse 2 to 3 Spacing (s)	Start Location (s)
1	3	8M	71.1u	1.222m	1.413m	444.6m
2	2	8M	59.0u	1.893m	-	289.7m
3	2	8M	60.7u	1.211m	-	933.9m
4	3	8M	68.6u	1.430m	1.751m	827.1m
5	3	8M	78.0u	1.707m	1.351m	65.79m
6	3	8M	95.0u	1.577m	1.175m	1.235
7	2	8M	94.0u	1.043m	-	1.170
8	2	8M	82.2u	1.181m	-	463.7m
9	1	8M	55.8u	-	-	543.3m

Long Pulse Radar Test Signal						
Test Signal Name: LP_Signal_03						
Number of Bursts in Trial: 15						
Chrip Center Frequency: 5495MHz						
Burst	Pulses per Burst	Chrip (Hz)	Pulse Width (s)	Pulse 1 to 2 Spacing (s)	Pulse 2 to 3 Spacing (s)	Start Location (s)
1	1	9M	89.4u	-	-	338.0m
2	3	9M	68.3u	1.753m	1.438m	613.1m
3	2	9M	63.6u	1.362m	-	303.8m
4	2	9M	80.5u	993.5u	-	595.4m
5	2	9M	73.6u	1.540m	-	78.46m
6	1	9M	87.3u	-	-	160.7m
7	2	9M	74.5u	1.600m	-	607.5m
8	2	9M	77.4u	1.693m	-	479.2m
9	2	9M	78.4u	989.6u	-	115.9m
10	2	9M	93.1u	1.366m	-	724.2m
11	1	9M	84.2u	-	-	81.00m
12	1	9M	74.9u	-	-	557.2m
13	2	9M	81.2u	1.048m	-	738.1m
14	2	9M	55.9u	1.240m	-	186.3m
15	3	9M	76.3u	1.412m	1.545m	715.8m

Long Pulse Radar Test Signal						
Test Signal Name: LP_Signal_04						
Number of Bursts in Trial: 9						
Chrip Center Frequency: 5495MHz						
Burst	Pulses per Burst	Chrip (Hz)	Pulse Width (s)	Pulse 1 to 2 Spacing (s)	Pulse 2 to 3 Spacing (s)	Start Location (s)
1	2	10M	71.0u	1.700m	-	593.5m
2	2	10M	88.3u	1.451m	-	88.29m
3	1	10M	85.0u	-	-	525.7m
4	2	10M	79.7u	1.341m	-	774.4m
5	3	10M	79.3u	1.573m	921.7u	729.8m
6	1	10M	66.1u	-	-	928.6m
7	2	10M	54.9u	1.834m	-	366.6m
8	3	10M	55.2u	1.238m	1.195m	1.308
9	2	10M	62.7u	1.728m	-	250.5m

Long Pulse Radar Test Signal						
Test Signal Name: LP_Signal_05						
Number of Bursts in Trial: 12						
Chrip Center Frequency: 5495MHz						
Burst	Pulses per Burst	Chrip (Hz)	Pulse Width (s)	Pulse 1 to 2 Spacing (s)	Pulse 2 to 3 Spacing (s)	Start Location (s)
1	1	11M	51.0u	-	-	563.8m
2	2	11M	90.6u	980.4u	-	842.7m
3	2	11M	98.0u	1.517m	-	891.3m
4	1	11M	86.3u	-	-	18.60m
5	2	11M	83.6u	1.461m	-	229.3m
6	1	11M	69.2u	-	-	831.7m
7	1	11M	88.5u	-	-	690.5m
8	2	11M	52.0u	1.323m	-	189.2m
9	2	11M	93.8u	1.880m	-	173.7m
10	2	11M	93.5u	1.138m	-	816.3m
11	2	11M	67.3u	1.623m	-	196.4m
12	1	11M	92.5u	-	-	496.3m

Long Pulse Radar Test Signal						
Test Signal Name: LP_Signal_06						
Number of Bursts in Trial: 20						
Chrip Center Frequency: 5496MHz						
Burst	Pulses per Burst	Chrip (Hz)	Pulse Width (s)	Pulse 1 to 2 Spacing (s)	Pulse 2 to 3 Spacing (s)	Start Location (s)
1	2	12M	56.8u	1.408m	-	81.99m
2	3	12M	70.9u	945.1u	1.661m	283.0m
3	3	12M	65.7u	1.142m	1.041m	439.5m
4	2	12M	58.0u	1.801m	-	349.9m
5	2	12M	73.9u	1.694m	-	397.3m
6	1	12M	96.2u	-	-	347.6m
7	3	12M	93.6u	1.448m	1.841m	14.77m
8	1	12M	60.5u	-	-	507.8m
9	2	12M	72.6u	1.175m	-	167.9m
10	2	12M	70.0u	1.656m	-	219.2m
11	1	12M	63.7u	-	-	97.59m
12	1	12M	77.8u	-	-	388.7m
13	2	12M	62.1u	1.154m	-	66.51m
14	1	12M	89.0u	-	-	281.6m
15	3	12M	85.7u	1.038m	1.800m	25.93m
16	2	12M	80.4u	1.201m	-	297.9m
17	2	12M	58.1u	1.088m	-	277.1m
18	2	12M	56.4u	1.441m	-	479.7m
19	2	12M	80.8u	983.2u	-	555.5m
20	1	12M	93.2u	-	-	46.87m

Long Pulse Radar Test Signal						
Test Signal Name: LP_Signal_07						
Number of Bursts in Trial: 12						
Chrip Center Frequency: 5496MHz						
Burst	Pulses per Burst	Chrip (Hz)	Pulse Width (s)	Pulse 1 to 2 Spacing (s)	Pulse 2 to 3 Spacing (s)	Start Location (s)
1	2	13M	71.5u	982.5u	-	86.36m
2	1	13M	89.8u	-	-	993.6m
3	1	13M	83.2u	-	-	30.83m
4	1	13M	59.2u	-	-	837.0m
5	1	13M	68.7u	-	-	229.0m
6	2	13M	96.4u	1.547m	-	543.5m
7	2	13M	84.2u	1.813m	-	108.2m
8	1	13M	61.5u	-	-	194.1m
9	2	13M	87.9u	1.451m	-	603.2m
10	1	13M	94.3u	-	-	285.9m
11	2	13M	61.6u	1.018m	-	423.4m
12	2	13M	55.8u	1.245m	-	287.7m

Long Pulse Radar Test Signal						
Test Signal Name: LP_Signal_08						
Number of Bursts in Trial: 8						
Chrip Center Frequency: 5497MHz						
Burst	Pulses per Burst	Chrip (Hz)	Pulse Width (s)	Pulse 1 to 2 Spacing (s)	Pulse 2 to 3 Spacing (s)	Start Location (s)
1	2	14M	100.0u	1.316m	-	574.2m
2	2	14M	67.5u	1.529m	-	280.0m
3	3	14M	52.4u	1.833m	955.6u	312.3m
4	3	14M	74.3u	1.451m	1.391m	1.205
5	2	14M	82.0u	1.489m	-	1.470
6	2	14M	65.4u	1.871m	-	1.159
7	2	14M	56.9u	1.758m	-	300.0m
8	1	14M	67.1u	-	-	431.5m

Long Pulse Radar Test Signal						
Test Signal Name: LP_Signal_09						
Number of Bursts in Trial: 15						
Chrip Center Frequency: 5498MHz						
Burst	Pulses per Burst	Chrip (Hz)	Pulse Width (s)	Pulse 1 to 2 Spacing (s)	Pulse 2 to 3 Spacing (s)	Start Location (s)
1	2	17M	83.3u	1.461m	-	505.3m
2	1	17M	80.8u	-	-	348.6m
3	2	17M	63.4u	1.265m	-	374.7m
4	2	17M	90.4u	949.6u	-	40.99m
5	3	17M	53.6u	1.350m	1.625m	117.0m
6	2	17M	83.2u	1.632m	-	58.99m
7	2	17M	58.1u	1.629m	-	501.3m
8	2	17M	79.4u	1.903m	-	759.4m
9	1	17M	53.6u	-	-	210.0m
10	1	17M	80.1u	-	-	651.0m
11	2	17M	76.2u	935.8u	-	650.7m
12	2	17M	82.5u	1.394m	-	582.6m
13	3	17M	68.6u	1.491m	1.582m	401.2m
14	1	17M	76.7u	-	-	703.8m
15	1	17M	79.2u	-	-	563.3m

Long Pulse Radar Test Signal						
Test Signal Name: LP_Signal_10						
Number of Bursts in Trial: 13						
Chrip Center Frequency: 5499MHz						
Burst	Pulses per Burst	Chrip (Hz)	Pulse Width (s)	Pulse 1 to 2 Spacing (s)	Pulse 2 to 3 Spacing (s)	Start Location (s)
1	3	20M	99.7u	1.511m	1.864m	57.55m
2	2	20M	62.6u	1.651m	-	208.8m
3	2	20M	78.6u	1.897m	-	188.5m
4	3	20M	92.7u	1.075m	1.701m	713.1m
5	2	20M	84.2u	1.551m	-	875.0m
6	2	20M	71.6u	1.165m	-	311.7m
7	1	20M	67.9u	-	-	735.6m
8	3	20M	54.0u	1.098m	1.873m	138.9m
9	1	20M	82.3u	-	-	262.2m
10	2	20M	63.4u	1.368m	-	14.73m
11	2	20M	64.4u	1.845m	-	637.0m
12	2	20M	90.9u	1.294m	-	356.2m
13	1	20M	96.9u	-	-	536.0m

Long Pulse Radar Test Signal						
Test Signal Name: LP_Signal_11						
Number of Bursts in Trial: 11						
Chrip Center Frequency: 5530MHz						
Burst	Pulses per Burst	Chrip (Hz)	Pulse Width (s)	Pulse 1 to 2 Spacing (s)	Pulse 2 to 3 Spacing (s)	Start Location (s)
1	3	5M	77.4u	928.6u	1.433m	748.0m
2	2	5M	76.8u	1.792m	-	106.4m
3	2	5M	80.6u	1.265m	-	687.9m
4	3	5M	91.4u	1.357m	1.842m	327.9m
5	3	5M	90.0u	1.712m	1.217m	846.9m
6	2	5M	64.2u	1.792m	-	764.9m
7	2	5M	97.3u	1.153m	-	266.8m
8	2	5M	52.9u	952.1u	-	132.9m
9	3	5M	95.0u	1.657m	1.029m	423.4m
10	2	5M	87.7u	1.304m	-	303.7m
11	3	5M	69.8u	1.737m	1.511m	612.5m

Long Pulse Radar Test Signal						
Test Signal Name: LP_Signal_12						
Number of Bursts in Trial: 10						
Chrip Center Frequency: 5531MHz						
Burst	Pulses per Burst	Chrip (Hz)	Pulse Width (s)	Pulse 1 to 2 Spacing (s)	Pulse 2 to 3 Spacing (s)	Start Location (s)
1	1	6M	63.2u	-	-	639.7m
2	3	6M	51.2u	1.477m	1.835m	678.8m
3	3	6M	64.0u	1.440m	1.154m	534.7m
4	2	6M	70.2u	1.135m	-	1.023
5	2	6M	82.2u	1.368m	-	565.5m
6	2	6M	90.8u	1.524m	-	59.60m
7	2	6M	61.5u	985.5u	-	1.004
8	1	6M	52.3u	-	-	775.3m
9	3	6M	75.8u	1.274m	1.399m	123.2m
10	1	6M	83.4u	-	-	1.109

Long Pulse Radar Test Signal						
Test Signal Name: LP_Signal_13						
Number of Bursts in Trial: 12						
Chrip Center Frequency: 5532MHz						
Burst	Pulses per Burst	Chrip (Hz)	Pulse Width (s)	Pulse 1 to 2 Spacing (s)	Pulse 2 to 3 Spacing (s)	Start Location (s)
1	2	8M	85.6u	1.082m	-	874.1m
2	2	8M	81.6u	1.669m	-	781.7m
3	2	8M	76.3u	1.051m	-	469.8m
4	2	8M	53.4u	1.109m	-	579.4m
5	2	8M	60.3u	1.288m	-	972.5m
6	1	8M	73.5u	-	-	379.7m
7	2	8M	90.0u	1.601m	-	302.6m
8	1	8M	58.0u	-	-	883.6m
9	2	8M	77.8u	1.348m	-	110.6m
10	2	8M	74.6u	1.921m	-	292.1m
11	1	8M	94.1u	-	-	793.6m
12	2	8M	52.0u	1.449m	-	437.9m

Long Pulse Radar Test Signal						
Test Signal Name: LP_Signal_14						
Number of Bursts in Trial: 10						
Chrip Center Frequency: 5533MHz						
Burst	Pulses per Burst	Chrip (Hz)	Pulse Width (s)	Pulse 1 to 2 Spacing (s)	Pulse 2 to 3 Spacing (s)	Start Location (s)
1	3	10M	81.8u	1.808m	1.698m	72.39m
2	3	10M	76.6u	1.509m	1.487m	279.1m
3	1	10M	97.8u	-	-	1.124
4	3	10M	91.4u	1.843m	1.006m	24.01m
5	2	10M	74.5u	1.380m	-	1.025
6	2	10M	59.7u	1.379m	-	870.2m
7	2	10M	79.5u	1.094m	-	565.8m
8	2	10M	86.0u	1.148m	-	702.2m
9	2	10M	61.7u	1.400m	-	1.076
10	3	10M	87.5u	1.460m	1.499m	297.4m

Long Pulse Radar Test Signal						
Test Signal Name: LP_Signal_15						
Number of Bursts in Trial: 19						
Chrip Center Frequency: 5529MHz						
Burst	Pulses per Burst	Chrip (Hz)	Pulse Width (s)	Pulse 1 to 2 Spacing (s)	Pulse 2 to 3 Spacing (s)	Start Location (s)
1	3	11M	53.1u	1.523m	1.293m	78.52m
2	3	11M	56.1u	1.129m	1.009m	582.4m
3	3	11M	60.5u	1.643m	1.002m	582.7m
4	1	11M	69.2u	-	-	92.56m
5	1	11M	85.3u	-	-	451.9m
6	2	11M	83.3u	1.132m	-	112.9m
7	2	11M	56.0u	1.460m	-	265.4m
8	2	11M	74.8u	1.526m	-	451.7m
9	2	11M	73.8u	1.249m	-	245.7m
10	2	11M	97.2u	1.449m	-	200.5m
11	1	11M	79.4u	-	-	423.5m
12	1	11M	58.5u	-	-	507.8m
13	2	11M	93.6u	1.176m	-	63.82m
14	2	11M	67.8u	1.019m	-	463.3m
15	2	11M	74.6u	1.168m	-	235.0m
16	2	11M	69.7u	1.319m	-	266.1m
17	3	11M	85.8u	964.2u	1.187m	47.90m
18	2	11M	56.8u	1.662m	-	222.1m
19	2	11M	99.2u	1.348m	-	254.0m

Long Pulse Radar Test Signal						
Test Signal Name: LP_Signal_16						
Number of Bursts in Trial: 19						
Chrip Center Frequency: 5528MHz						
Burst	Pulses per Burst	Chrip (Hz)	Pulse Width (s)	Pulse 1 to 2 Spacing (s)	Pulse 2 to 3 Spacing (s)	Start Location (s)
1	2	14M	94.8u	1.833m	-	253.8m
2	2	14M	94.0u	1.277m	-	188.2m
3	2	14M	73.4u	1.353m	-	312.0m
4	3	14M	72.4u	1.274m	1.237m	65.56m
5	1	14M	99.7u	-	-	153.2m
6	1	14M	72.3u	-	-	541.4m
7	1	14M	68.9u	-	-	226.9m
8	3	14M	76.0u	1.169m	1.912m	1.325m
9	3	14M	53.8u	1.926m	1.757m	118.8m
10	1	14M	93.7u	-	-	376.4m
11	2	14M	88.8u	1.386m	-	151.7m
12	3	14M	93.9u	1.399m	1.175m	51.10m
13	1	14M	53.5u	-	-	24.10m
14	2	14M	91.7u	1.059m	-	402.9m
15	2	14M	92.7u	1.304m	-	113.0m
16	1	14M	69.2u	-	-	473.0m
17	1	14M	77.9u	-	-	422.4m
18	1	14M	63.2u	-	-	591.5m
19	3	14M	74.1u	1.402m	1.848m	550.6m

Long Pulse Radar Test Signal						
Test Signal Name: LP_Signal_17						
Number of Bursts in Trial: 10						
Chrip Center Frequency: 5527MHz						
Burst	Pulses per Burst	Chrip (Hz)	Pulse Width (s)	Pulse 1 to 2 Spacing (s)	Pulse 2 to 3 Spacing (s)	Start Location (s)
1	2	15M	66.1u	1.398m	-	532.7m
2	3	15M	58.1u	1.693m	1.008m	686.4m
3	2	15M	71.5u	1.567m	-	1.058
4	2	15M	53.9u	1.265m	-	682.7m
5	2	15M	63.7u	1.637m	-	814.6m
6	2	15M	64.5u	1.031m	-	127.8m
7	1	15M	54.9u	-	-	1.015
8	1	15M	75.5u	-	-	1.122
9	2	15M	75.5u	1.551m	-	612.6m
10	2	15M	72.8u	1.435m	-	459.0m

Long Pulse Radar Test Signal						
Test Signal Name: LP_Signal_18						
Number of Bursts in Trial: 11						
Chrip Center Frequency: 5534MHz						
Burst	Pulses per Burst	Chrip (Hz)	Pulse Width (s)	Pulse 1 to 2 Spacing (s)	Pulse 2 to 3 Spacing (s)	Start Location (s)
1	2	17M	93.2u	1.823m	-	278.1m
2	3	17M	96.9u	1.005m	1.409m	588.9m
3	2	17M	66.9u	1.184m	-	447.4m
4	2	17M	56.3u	1.242m	-	234.3m
5	2	17M	55.9u	1.736m	-	1.059
6	3	17M	82.1u	1.679m	1.064m	608.4m
7	2	17M	82.4u	1.814m	-	24.27m
8	2	17M	50.5u	1.216m	-	789.1m
9	1	17M	95.4u	-	-	772.6m
10	2	17M	84.8u	1.071m	-	511.0m
11	2	17M	51.2u	1.552m	-	1.030

Long Pulse Radar Test Signal						
Test Signal Name: LP_Signal_19						
Number of Bursts in Trial: 17						
Chrip Center Frequency: 5526MHz						
Burst	Pulses per Burst	Chrip (Hz)	Pulse Width (s)	Pulse 1 to 2 Spacing (s)	Pulse 2 to 3 Spacing (s)	Start Location (s)
1	1	18M	99.1u	-	-	365.0m
2	2	18M	80.2u	1.073m	-	218.9m
3	1	18M	98.4u	-	-	62.40m
4	2	18M	79.9u	924.1u	-	28.38m
5	3	18M	85.7u	1.729m	1.103m	59.49m
6	3	18M	83.1u	1.033m	1.823m	360.0m
7	1	18M	93.9u	-	-	207.7m
8	2	18M	92.9u	1.657m	-	307.2m
9	2	18M	93.9u	1.164m	-	269.1m
10	3	18M	71.8u	1.516m	1.207m	433.3m
11	2	18M	60.1u	1.913m	-	334.1m
12	2	18M	65.1u	1.569m	-	471.0m
13	2	18M	70.1u	1.020m	-	403.4m
14	2	18M	54.7u	1.505m	-	537.2m
15	2	18M	71.7u	1.764m	-	569.9m
16	2	18M	98.5u	1.729m	-	505.7m
17	2	18M	90.2u	1.677m	-	644.0m

Long Pulse Radar Test Signal						
Test Signal Name: LP_Signal_20						
Number of Bursts in Trial: 17						
Chrip Center Frequency: 5525MHz						
Burst	Pulses per Burst	Chrip (Hz)	Pulse Width (s)	Pulse 1 to 2 Spacing (s)	Pulse 2 to 3 Spacing (s)	Start Location (s)
1	2	19M	78.0u	1.167m	-	269.8m
2	3	19M	82.8u	1.545m	1.544m	640.4m
3	2	19M	73.0u	1.679m	-	88.41m
4	2	19M	67.7u	1.793m	-	557.7m
5	2	19M	55.9u	1.359m	-	651.0m
6	2	19M	92.9u	1.029m	-	485.5m
7	3	19M	70.2u	1.756m	1.342m	179.1m
8	1	19M	55.1u	-	-	407.5m
9	3	19M	67.9u	1.910m	1.250m	285.0m
10	1	19M	50.3u	-	-	147.8m
11	3	19M	50.3u	1.543m	1.185m	550.6m
12	3	19M	93.9u	1.670m	1.112m	207.5m
13	3	19M	54.3u	1.260m	1.333m	689.3m
14	1	19M	73.3u	-	-	595.0m
15	2	19M	86.5u	1.506m	-	78.29m
16	3	19M	53.8u	1.088m	1.261m	105.6m
17	2	19M	89.3u	1.368m	-	145.9m

Long Pulse Radar Test Signal						
Test Signal Name: LP_Signal_21						
Number of Bursts in Trial: 18						
Chrip Center Frequency: 5568MHz						
Burst	Pulses per Burst	Chrip (Hz)	Pulse Width (s)	Pulse 1 to 2 Spacing (s)	Pulse 2 to 3 Spacing (s)	Start Location (s)
1	1	5M	53.6u	-	-	504.6m
2	3	5M	97.1u	1.798m	1.565m	441.5m
3	3	5M	53.5u	1.548m	1.068m	291.7m
4	2	5M	52.2u	1.395m	-	212.8m
5	2	5M	95.3u	1.226m	-	96.33m
6	2	5M	92.6u	1.470m	-	303.7m
7	1	5M	82.6u	-	-	516.6m
8	1	5M	53.5u	-	-	141.6m
9	2	5M	57.4u	999.6u	-	95.05m
10	2	5M	96.4u	1.888m	-	567.5m
11	2	5M	66.0u	1.443m	-	271.3m
12	1	5M	98.5u	-	-	442.6m
13	2	5M	68.3u	1.114m	-	512.5m
14	2	5M	85.3u	1.613m	-	105.4m
15	3	5M	99.4u	1.752m	1.843m	647.8m
16	2	5M	97.8u	1.644m	-	259.0m
17	1	5M	77.1u	-	-	649.5m
18	1	5M	58.2u	-	-	539.5m

Long Pulse Radar Test Signal						
Test Signal Name: LP_Signal_22						
Number of Bursts in Trial: 16						
Chrip Center Frequency: 5567MHz						
Burst	Pulses per Burst	Chrip (Hz)	Pulse Width (s)	Pulse 1 to 2 Spacing (s)	Pulse 2 to 3 Spacing (s)	Start Location (s)
1	2	6M	61.5u	1.386m	-	311.0m
2	3	6M	67.1u	1.513m	1.138m	208.0m
3	2	6M	96.6u	1.844m	-	387.8m
4	1	6M	82.7u	-	-	224.5m
5	2	6M	67.8u	1.718m	-	627.0m
6	2	6M	87.2u	1.177m	-	181.9m
7	2	6M	67.9u	1.705m	-	545.1m
8	3	6M	92.8u	1.251m	1.284m	255.7m
9	1	6M	68.4u	-	-	724.0m
10	3	6M	70.6u	1.617m	1.276m	638.6m
11	2	6M	79.2u	1.690m	-	1.461m
12	2	6M	66.8u	1.231m	-	710.1m
13	2	6M	79.3u	1.785m	-	297.6m
14	3	6M	52.6u	1.716m	1.394m	154.1m
15	1	6M	51.5u	-	-	341.0m
16	2	6M	60.8u	1.100m	-	636.3m

Long Pulse Radar Test Signal						
Test Signal Name: LP_Signal_23						
Number of Bursts in Trial: 15						
Chrip Center Frequency: 5566MHz						
Burst	Pulses per Burst	Chrip (Hz)	Pulse Width (s)	Pulse 1 to 2 Spacing (s)	Pulse 2 to 3 Spacing (s)	Start Location (s)
1	2	7M	53.0u	969.0u	-	746.8m
2	1	7M	63.4u	-	-	742.3m
3	2	7M	50.2u	1.509m	-	409.2m
4	3	7M	60.1u	1.447m	1.300m	473.9m
5	2	7M	80.0u	1.361m	-	541.6m
6	2	7M	54.0u	1.276m	-	751.9m
7	2	7M	86.4u	1.372m	-	5.669m
8	3	7M	67.1u	1.234m	1.548m	681.3m
9	1	7M	83.2u	-	-	569.4m
10	2	7M	89.6u	1.288m	-	710.9m
11	2	7M	68.4u	1.713m	-	305.7m
12	2	7M	98.4u	1.105m	-	659.4m
13	2	7M	53.8u	1.651m	-	260.7m
14	3	7M	90.7u	971.3u	1.297m	64.39m
15	3	7M	88.5u	1.396m	1.731m	619.3m

Long Pulse Radar Test Signal						
Test Signal Name: LP_Signal_24						
Number of Bursts in Trial: 12						
Chrip Center Frequency: 5565MHz						
Burst	Pulses per Burst	Chrip (Hz)	Pulse Width (s)	Pulse 1 to 2 Spacing (s)	Pulse 2 to 3 Spacing (s)	Start Location (s)
1	2	9M	81.2u	1.556m	-	256.2m
2	1	9M	86.7u	-	-	131.1m
3	2	9M	77.8u	1.026m	-	504.6m
4	2	9M	55.6u	1.700m	-	485.5m
5	2	9M	92.8u	1.848m	-	535.0m
6	3	9M	54.8u	974.2u	1.487m	763.2m
7	2	9M	65.7u	1.884m	-	681.3m
8	2	9M	89.7u	1.572m	-	624.8m
9	2	9M	57.8u	1.208m	-	12.28m
10	2	9M	54.6u	1.123m	-	881.4m
11	1	9M	65.0u	-	-	637.4m
12	2	9M	72.7u	1.336m	-	662.2m

Long Pulse Radar Test Signal						
Test Signal Name: LP_Signal_25						
Number of Bursts in Trial: 18						
Chrip Center Frequency: 5565MHz						
Burst	Pulses per Burst	Chrip (Hz)	Pulse Width (s)	Pulse 1 to 2 Spacing (s)	Pulse 2 to 3 Spacing (s)	Start Location (s)
1	3	10M	54.2u	1.942m	1.494m	592.2m
2	3	10M	71.2u	1.558m	1.925m	239.4m
3	2	10M	96.1u	1.640m	-	300.6m
4	3	10M	90.5u	1.811m	1.633m	351.7m
5	2	10M	76.9u	1.123m	-	637.0m
6	3	10M	50.0u	1.335m	1.347m	297.1m
7	1	10M	75.1u	-	-	128.3m
8	1	10M	67.8u	-	-	292.2m
9	2	10M	88.2u	1.658m	-	55.83m
10	2	10M	52.3u	1.229m	-	382.0m
11	1	10M	64.4u	-	-	649.6m
12	2	10M	80.0u	1.813m	-	186.8m
13	3	10M	71.2u	1.625m	1.030m	289.9m
14	3	10M	52.9u	1.884m	1.728m	105.0m
15	3	10M	72.4u	932.6u	1.559m	96.61m
16	2	10M	74.9u	1.418m	-	493.8m
17	1	10M	76.4u	-	-	528.7m
18	2	10M	62.3u	1.001m	-	468.6m

Long Pulse Radar Test Signal						
Test Signal Name: LP_Signal_26						
Number of Bursts in Trial: 17						
Chrip Center Frequency: 5564MHz						
Burst	Pulses per Burst	Chrip (Hz)	Pulse Width (s)	Pulse 1 to 2 Spacing (s)	Pulse 2 to 3 Spacing (s)	Start Location (s)
1	2	12M	64.3u	1.686m	-	488.5m
2	1	12M	83.8u	-	-	656.3m
3	2	12M	82.0u	1.771m	-	101.7m
4	2	12M	67.4u	993.6u	-	652.8m
5	1	12M	55.6u	-	-	667.4m
6	1	12M	72.0u	-	-	530.3m
7	2	12M	65.8u	1.161m	-	132.8m
8	2	12M	72.8u	1.137m	-	613.4m
9	2	12M	55.5u	1.051m	-	415.1m
10	2	12M	97.0u	1.184m	-	682.1m
11	1	12M	97.8u	-	-	245.7m
12	1	12M	68.8u	-	-	294.0m
13	2	12M	57.4u	1.581m	-	257.3m
14	2	12M	68.2u	1.423m	-	596.0u
15	2	12M	97.2u	1.703m	-	654.0m
16	2	12M	74.1u	1.138m	-	102.3m
17	1	12M	98.1u	-	-	550.1m

Long Pulse Radar Test Signal						
Test Signal Name: LP_Signal_27						
Number of Bursts in Trial: 11						
Chrip Center Frequency: 5564MHz						
Burst	Pulses per Burst	Chrip (Hz)	Pulse Width (s)	Pulse 1 to 2 Spacing (s)	Pulse 2 to 3 Spacing (s)	Start Location (s)
1	3	13M	51.2u	1.554m	1.600m	938.5m
2	2	13M	62.1u	1.523m	-	66.65m
3	2	13M	84.1u	1.237m	-	333.2m
4	1	13M	83.6u	-	-	226.5m
5	2	13M	94.4u	1.354m	-	662.1m
6	3	13M	73.6u	1.860m	1.455m	990.1m
7	1	13M	72.7u	-	-	690.2m
8	2	13M	84.4u	1.778m	-	809.3m
9	2	13M	72.2u	1.660m	-	636.3m
10	2	13M	95.6u	1.055m	-	474.9m
11	1	13M	70.9u	-	-	98.17m

Long Pulse Radar Test Signal						
Test Signal Name: LP_Signal_28						
Number of Bursts in Trial: 17						
Chrip Center Frequency: 5563MHz						
Burst	Pulses per Burst	Chrip (Hz)	Pulse Width (s)	Pulse 1 to 2 Spacing (s)	Pulse 2 to 3 Spacing (s)	Start Location (s)
1	2	14M	54.4u	1.544m	-	171.5m
2	2	14M	93.6u	1.320m	-	246.1m
3	3	14M	89.8u	1.720m	1.895m	347.7m
4	1	14M	85.1u	-	-	489.6m
5	2	14M	61.4u	1.507m	-	311.2m
6	3	14M	55.4u	1.798m	1.313m	540.6m
7	2	14M	92.1u	1.250m	-	66.91m
8	2	14M	63.5u	1.130m	-	241.9m
9	1	14M	86.9u	-	-	447.3m
10	3	14M	80.5u	1.568m	1.605m	7.248m
11	3	14M	55.0u	1.245m	1.865m	527.1m
12	1	14M	63.9u	-	-	76.76m
13	3	14M	79.9u	1.689m	1.894m	16.80m
14	2	14M	55.4u	1.846m	-	214.0m
15	1	14M	93.7u	-	-	330.3m
16	2	14M	86.8u	1.529m	-	638.0m
17	2	14M	52.9u	1.784m	-	245.7m

Long Pulse Radar Test Signal						
Test Signal Name: LP_Signal_29						
Number of Bursts in Trial: 10						
Chrip Center Frequency: 5563MHz						
Burst	Pulses per Burst	Chrip (Hz)	Pulse Width (s)	Pulse 1 to 2 Spacing (s)	Pulse 2 to 3 Spacing (s)	Start Location (s)
1	1	18M	91.4u	-	-	1.193
2	2	18M	59.0u	1.416m	-	691.9m
3	3	18M	75.5u	1.576m	1.710m	949.0m
4	3	18M	57.2u	1.495m	1.274m	98.67m
5	2	18M	86.9u	1.499m	-	1.077
6	3	18M	59.2u	1.913m	1.856m	327.0m
7	1	18M	79.4u	-	-	681.2m
8	3	18M	98.1u	1.764m	1.499m	780.6m
9	2	18M	79.1u	1.785m	-	22.12m
10	3	18M	75.5u	1.187m	1.373m	229.5m

Long Pulse Radar Test Signal						
Test Signal Name: LP_Signal_30						
Number of Bursts in Trial: 15						
Chrip Center Frequency: 5561MHz						
Burst	Pulses per Burst	Chrip (Hz)	Pulse Width (s)	Pulse 1 to 2 Spacing (s)	Pulse 2 to 3 Spacing (s)	Start Location (s)
1	1	20M	63.9u	-	-	77.33m
2	2	20M	94.7u	1.807m	-	47.69m
3	2	20M	55.2u	1.653m	-	235.8m
4	1	20M	88.6u	-	-	734.4m
5	3	20M	58.9u	1.448m	1.576m	594.5m
6	3	20M	80.2u	1.051m	1.328m	738.1m
7	2	20M	51.8u	1.771m	-	610.0m
8	1	20M	58.2u	-	-	187.6m
9	3	20M	51.5u	1.442m	1.642m	91.17m
10	2	20M	54.6u	1.066m	-	128.0m
11	3	20M	92.5u	1.718m	1.207m	337.4m
12	3	20M	88.1u	1.794m	1.583m	438.5m
13	2	20M	63.5u	1.643m	-	214.3m
14	2	20M	73.1u	959.9u	-	235.5m
15	1	20M	71.4u	-	-	509.1m

Type 6 Radar Statistical Performances				
Trial #	Pulses per Burst	Pulse Width (s)	PRI (s)	Detection
1	9	1.0u	333.0u	Yes
2	9	1.0u	333.0u	Yes
3	9	1.0u	333.0u	Yes
4	9	1.0u	333.0u	Yes
5	9	1.0u	333.0u	Yes
6	9	1.0u	333.0u	Yes
7	9	1.0u	333.0u	Yes
8	9	1.0u	333.0u	Yes
9	9	1.0u	333.0u	Yes
10	9	1.0u	333.0u	Yes
11	9	1.0u	333.0u	Yes
12	9	1.0u	333.0u	Yes
13	9	1.0u	333.0u	Yes
14	9	1.0u	333.0u	Yes
15	9	1.0u	333.0u	Yes
16	9	1.0u	333.0u	Yes
17	9	1.0u	333.0u	Yes
18	9	1.0u	333.0u	Yes
19	9	1.0u	333.0u	Yes
20	9	1.0u	333.0u	Yes
21	9	1.0u	333.0u	Yes
22	9	1.0u	333.0u	Yes
23	9	1.0u	333.0u	Yes
24	9	1.0u	333.0u	Yes
25	9	1.0u	333.0u	Yes
26	9	1.0u	333.0u	Yes
27	9	1.0u	333.0u	Yes
28	9	1.0u	333.0u	Yes
29	9	1.0u	333.0u	Yes
30	9	1.0u	333.0u	Yes
			Detection Rate: 100.0 %	

Type 6 Radar Statistical Performances		
Trial #	Hopping Frequency Sequence Name	Detection
1	HOP_FREQ_SEQ_01	Yes
2	HOP_FREQ_SEQ_02	Yes
3	HOP_FREQ_SEQ_03	Yes
4	HOP_FREQ_SEQ_04	Yes
5	HOP_FREQ_SEQ_05	Yes
6	HOP_FREQ_SEQ_06	Yes
7	HOP_FREQ_SEQ_07	Yes
8	HOP_FREQ_SEQ_08	Yes
9	HOP_FREQ_SEQ_09	Yes
10	HOP_FREQ_SEQ_10	Yes
11	HOP_FREQ_SEQ_11	Yes
12	HOP_FREQ_SEQ_12	Yes
13	HOP_FREQ_SEQ_13	Yes
14	HOP_FREQ_SEQ_14	Yes
15	HOP_FREQ_SEQ_15	Yes
16	HOP_FREQ_SEQ_16	Yes
17	HOP_FREQ_SEQ_17	Yes
18	HOP_FREQ_SEQ_18	Yes
19	HOP_FREQ_SEQ_19	Yes
20	HOP_FREQ_SEQ_20	Yes
21	HOP_FREQ_SEQ_21	Yes
22	HOP_FREQ_SEQ_22	Yes
23	HOP_FREQ_SEQ_23	Yes
24	HOP_FREQ_SEQ_24	Yes
25	HOP_FREQ_SEQ_25	Yes
26	HOP_FREQ_SEQ_26	Yes
27	HOP_FREQ_SEQ_27	Yes
28	HOP_FREQ_SEQ_28	Yes
29	HOP_FREQ_SEQ_29	Yes
30	HOP_FREQ_SEQ_30	Yes
		Detection Rate: 100.0 %

Hopping Frequency Sequence Name: HOP_FREQ_SEQ_01							
SEQ#	Frequency (Hz)	SEQ#	Frequency (Hz)	SEQ#	Frequency (Hz)	SEQ#	Frequency (Hz)
1	5.584G	2	5.650G	3	5.556G	4	5.372G
5	5.441G	6	5.637G	7	5.635G	8	5.288G
9	5.697G	10	5.412G	11	5.323G	12	5.452G
13	5.659G	14	5.460G	15	5.641G	16	5.681G
17	5.374G	18	5.301G	19	5.510G	20	5.468G
21	5.585G	22	5.486G	23	5.314G	24	5.677G
25	5.655G	26	5.570G	27	5.687G	28	5.675G
29	5.572G	30	5.583G	31	5.505G	32	5.698G
33	5.350G	34	5.551G	35	5.597G	36	5.707G
37	5.333G	38	5.617G	39	5.259G	40	5.663G
41	5.620G	42	5.398G	43	5.366G	44	5.685G
45	5.516G	46	5.630G	47	5.633G	48	5.445G
49	5.458G	50	5.345G	51	5.680G	52	5.592G
53	5.396G	54	5.463G	55	5.469G	56	5.672G
57	5.518G	58	5.648G	59	5.435G	60	5.297G
61	5.332G	62	5.526G	63	5.586G	64	5.609G
65	5.657G	66	5.430G	67	5.274G	68	5.471G
69	5.310G	70	5.504G	71	5.673G	72	5.281G
73	5.682G	74	5.498G	75	5.688G	76	5.544G
77	5.712G	78	5.634G	79	5.608G	80	5.282G
81	5.631G	82	5.415G	83	5.699G	84	5.360G
85	5.283G	86	5.316G	87	5.472G	88	5.449G
89	5.694G	90	5.269G	91	5.700G	92	5.294G
93	5.692G	94	5.286G	95	5.501G	96	5.689G
97	5.324G	98	5.588G	99	5.536G	100	5.579G

Hopping Frequency Sequence Name: HOP_FREQ_SEQ_02							
SEQ#	Frequency (Hz)	SEQ#	Frequency (Hz)	SEQ#	Frequency (Hz)	SEQ#	Frequency (Hz)
1	5.346G	2	5.501G	3	5.272G	4	5.295G
5	5.403G	6	5.712G	7	5.613G	8	5.429G
9	5.263G	10	5.351G	11	5.476G	12	5.323G
13	5.606G	14	5.355G	15	5.603G	16	5.402G
17	5.721G	18	5.330G	19	5.557G	20	5.354G
21	5.315G	22	5.465G	23	5.590G	24	5.704G
25	5.551G	26	5.303G	27	5.638G	28	5.493G
29	5.480G	30	5.709G	31	5.438G	32	5.255G
33	5.344G	34	5.256G	35	5.651G	36	5.460G
37	5.660G	38	5.343G	39	5.277G	40	5.436G
41	5.658G	42	5.370G	43	5.286G	44	5.446G
45	5.655G	46	5.517G	47	5.394G	48	5.360G
49	5.648G	50	5.425G	51	5.612G	52	5.620G
53	5.592G	54	5.570G	55	5.518G	56	5.298G
57	5.632G	58	5.600G	59	5.448G	60	5.258G
61	5.487G	62	5.701G	63	5.297G	64	5.449G
65	5.691G	66	5.450G	67	5.565G	68	5.348G
69	5.679G	70	5.629G	71	5.380G	72	5.453G
73	5.584G	74	5.335G	75	5.591G	76	5.705G
77	5.398G	78	5.270G	79	5.622G	80	5.514G
81	5.434G	82	5.369G	83	5.485G	84	5.301G
85	5.345G	86	5.618G	87	5.452G	88	5.441G
89	5.474G	90	5.250G	91	5.616G	92	5.710G
93	5.468G	94	5.513G	95	5.692G	96	5.334G
97	5.504G	98	5.347G	99	5.280G	100	5.400G

Hopping Frequency Sequence Name: HOP_FREQ_SEQ_03							
SEQ#	Frequency (Hz)	SEQ#	Frequency (Hz)	SEQ#	Frequency (Hz)	SEQ#	Frequency (Hz)
1	5.520G	2	5.463G	3	5.410G	4	5.684G
5	5.482G	6	5.448G	7	5.370G	8	5.610G
9	5.413G	10	5.667G	11	5.326G	12	5.381G
13	5.443G	14	5.583G	15	5.334G	16	5.642G
17	5.414G	18	5.457G	19	5.385G	20	5.412G
21	5.382G	22	5.578G	23	5.670G	24	5.465G
25	5.483G	26	5.257G	27	5.323G	28	5.674G
29	5.536G	30	5.384G	31	5.596G	32	5.722G
33	5.269G	34	5.643G	35	5.560G	36	5.628G
37	5.580G	38	5.415G	39	5.369G	40	5.636G
41	5.660G	42	5.477G	43	5.678G	44	5.492G
45	5.624G	46	5.337G	47	5.400G	48	5.698G
49	5.640G	50	5.260G	51	5.564G	52	5.403G
53	5.427G	54	5.627G	55	5.350G	56	5.611G
57	5.566G	58	5.691G	59	5.358G	60	5.648G
61	5.262G	62	5.429G	63	5.378G	64	5.590G
65	5.393G	66	5.278G	67	5.718G	68	5.312G
69	5.529G	70	5.305G	71	5.552G	72	5.650G
73	5.454G	74	5.330G	75	5.422G	76	5.341G
77	5.356G	78	5.485G	79	5.551G	80	5.588G
81	5.544G	82	5.716G	83	5.304G	84	5.659G
85	5.277G	86	5.703G	87	5.472G	88	5.575G
89	5.537G	90	5.294G	91	5.690G	92	5.380G
93	5.614G	94	5.362G	95	5.423G	96	5.311G
97	5.637G	98	5.540G	99	5.270G	100	5.302G

Hopping Frequency Sequence Name: HOP_FREQ_SEQ_04							
SEQ#	Frequency (Hz)	SEQ#	Frequency (Hz)	SEQ#	Frequency (Hz)	SEQ#	Frequency (Hz)
1	5.397G	2	5.383G	3	5.462G	4	5.338G
5	5.267G	6	5.261G	7	5.454G	8	5.500G
9	5.603G	10	5.568G	11	5.328G	12	5.467G
13	5.629G	14	5.612G	15	5.544G	16	5.375G
17	5.325G	18	5.507G	19	5.514G	20	5.433G
21	5.718G	22	5.526G	23	5.497G	24	5.520G
25	5.555G	26	5.389G	27	5.628G	28	5.511G
29	5.435G	30	5.424G	31	5.319G	32	5.453G
33	5.493G	34	5.311G	35	5.641G	36	5.415G
37	5.547G	38	5.655G	39	5.711G	40	5.579G
41	5.702G	42	5.260G	43	5.336G	44	5.278G
45	5.314G	46	5.587G	47	5.688G	48	5.598G
49	5.443G	50	5.719G	51	5.291G	52	5.428G
53	5.441G	54	5.377G	55	5.385G	56	5.315G
57	5.609G	58	5.274G	59	5.409G	60	5.546G
61	5.431G	62	5.288G	63	5.324G	64	5.341G
65	5.376G	66	5.689G	67	5.541G	68	5.422G
69	5.695G	70	5.679G	71	5.618G	72	5.465G
73	5.255G	74	5.590G	75	5.634G	76	5.388G
77	5.406G	78	5.420G	79	5.309G	80	5.362G
81	5.425G	82	5.605G	83	5.624G	84	5.374G
85	5.366G	86	5.360G	87	5.645G	88	5.297G
89	5.556G	90	5.554G	91	5.351G	92	5.596G
93	5.302G	94	5.470G	95	5.654G	96	5.299G
97	5.481G	98	5.606G	99	5.487G	100	5.343G

Hopping Frequency Sequence Name: HOP_FREQ_SEQ_05							
SEQ#	Frequency (Hz)	SEQ#	Frequency (Hz)	SEQ#	Frequency (Hz)	SEQ#	Frequency (Hz)
1	5.421G	2	5.644G	3	5.275G	4	5.412G
5	5.320G	6	5.350G	7	5.652G	8	5.620G
9	5.548G	10	5.601G	11	5.640G	12	5.450G
13	5.582G	14	5.702G	15	5.311G	16	5.349G
17	5.489G	18	5.605G	19	5.698G	20	5.407G
21	5.478G	22	5.545G	23	5.267G	24	5.658G
25	5.376G	26	5.707G	27	5.592G	28	5.696G
29	5.655G	30	5.504G	31	5.271G	32	5.416G
33	5.667G	34	5.673G	35	5.347G	36	5.700G
37	5.307G	38	5.723G	39	5.357G	40	5.522G
41	5.417G	42	5.257G	43	5.383G	44	5.419G
45	5.714G	46	5.393G	47	5.261G	48	5.508G
49	5.485G	50	5.260G	51	5.318G	52	5.628G
53	5.278G	54	5.430G	55	5.520G	56	5.392G
57	5.358G	58	5.270G	59	5.627G	60	5.557G
61	5.558G	62	5.305G	63	5.526G	64	5.314G
65	5.528G	66	5.555G	67	5.540G	68	5.380G
69	5.573G	70	5.268G	71	5.459G	72	5.482G
73	5.653G	74	5.353G	75	5.306G	76	5.324G
77	5.497G	78	5.693G	79	5.362G	80	5.514G
81	5.581G	82	5.415G	83	5.368G	84	5.599G
85	5.291G	86	5.704G	87	5.503G	88	5.564G
89	5.611G	90	5.634G	91	5.560G	92	5.300G
93	5.646G	94	5.561G	95	5.692G	96	5.633G
97	5.635G	98	5.492G	99	5.312G	100	5.690G

Hopping Frequency Sequence Name: HOP_FREQ_SEQ_06							
SEQ#	Frequency (Hz)	SEQ#	Frequency (Hz)	SEQ#	Frequency (Hz)	SEQ#	Frequency (Hz)
1	5.510G	2	5.475G	3	5.466G	4	5.512G
5	5.665G	6	5.493G	7	5.595G	8	5.412G
9	5.488G	10	5.435G	11	5.408G	12	5.263G
13	5.569G	14	5.713G	15	5.269G	16	5.687G
17	5.554G	18	5.392G	19	5.455G	20	5.592G
21	5.264G	22	5.670G	23	5.660G	24	5.614G
25	5.715G	26	5.560G	27	5.591G	28	5.461G
29	5.290G	30	5.278G	31	5.714G	32	5.365G
33	5.650G	34	5.307G	35	5.432G	36	5.641G
37	5.490G	38	5.417G	39	5.265G	40	5.457G
41	5.367G	42	5.598G	43	5.308G	44	5.669G
45	5.287G	46	5.413G	47	5.312G	48	5.389G
49	5.495G	50	5.530G	51	5.532G	52	5.525G
53	5.697G	54	5.619G	55	5.494G	56	5.577G
57	5.563G	58	5.342G	59	5.288G	60	5.313G
61	5.513G	62	5.636G	63	5.316G	64	5.428G
65	5.304G	66	5.326G	67	5.681G	68	5.584G
69	5.272G	70	5.363G	71	5.460G	72	5.468G
73	5.710G	74	5.362G	75	5.722G	76	5.262G
77	5.385G	78	5.482G	79	5.336G	80	5.390G
81	5.688G	82	5.277G	83	5.407G	84	5.393G
85	5.334G	86	5.372G	87	5.422G	88	5.322G
89	5.581G	90	5.559G	91	5.346G	92	5.380G
93	5.515G	94	5.258G	95	5.606G	96	5.406G
97	5.564G	98	5.444G	99	5.613G	100	5.526G

Hopping Frequency Sequence Name: HOP_FREQ_SEQ_07							
SEQ#	Frequency (Hz)	SEQ#	Frequency (Hz)	SEQ#	Frequency (Hz)	SEQ#	Frequency (Hz)
1	5.551G	2	5.676G	3	5.484G	4	5.572G
5	5.380G	6	5.718G	7	5.660G	8	5.644G
9	5.397G	10	5.438G	11	5.410G	12	5.256G
13	5.538G	14	5.542G	15	5.550G	16	5.480G
17	5.413G	18	5.461G	19	5.463G	20	5.369G
21	5.640G	22	5.383G	23	5.375G	24	5.488G
25	5.570G	26	5.281G	27	5.613G	28	5.282G
29	5.310G	30	5.273G	31	5.724G	32	5.622G
33	5.633G	34	5.267G	35	5.715G	36	5.523G
37	5.632G	38	5.620G	39	5.567G	40	5.589G
41	5.318G	42	5.263G	43	5.378G	44	5.716G
45	5.289G	46	5.568G	47	5.710G	48	5.516G
49	5.606G	50	5.337G	51	5.283G	52	5.717G
53	5.424G	54	5.651G	55	5.711G	56	5.707G
57	5.698G	58	5.462G	59	5.518G	60	5.445G
61	5.360G	62	5.653G	63	5.307G	64	5.341G
65	5.581G	66	5.457G	67	5.601G	68	5.345G
69	5.658G	70	5.431G	71	5.648G	72	5.253G
73	5.683G	74	5.384G	75	5.398G	76	5.459G
77	5.254G	78	5.607G	79	5.301G	80	5.417G
81	5.347G	82	5.643G	83	5.712G	84	5.514G
85	5.576G	86	5.610G	87	5.386G	88	5.381G
89	5.476G	90	5.680G	91	5.272G	92	5.477G
93	5.565G	94	5.450G	95	5.414G	96	5.343G
97	5.497G	98	5.405G	99	5.503G	100	5.577G

Hopping Frequency Sequence Name: HOP_FREQ_SEQ_08							
SEQ#	Frequency (Hz)	SEQ#	Frequency (Hz)	SEQ#	Frequency (Hz)	SEQ#	Frequency (Hz)
1	5.452G	2	5.443G	3	5.458G	4	5.492G
5	5.281G	6	5.280G	7	5.290G	8	5.685G
9	5.655G	10	5.636G	11	5.369G	12	5.320G
13	5.272G	14	5.644G	15	5.250G	16	5.695G
17	5.303G	18	5.268G	19	5.384G	20	5.351G
21	5.620G	22	5.588G	23	5.447G	24	5.283G
25	5.658G	26	5.566G	27	5.457G	28	5.476G
29	5.626G	30	5.325G	31	5.679G	32	5.590G
33	5.282G	34	5.538G	35	5.269G	36	5.539G
37	5.408G	38	5.400G	39	5.604G	40	5.371G
41	5.520G	42	5.499G	43	5.274G	44	5.352G
45	5.436G	46	5.505G	47	5.394G	48	5.617G
49	5.330G	50	5.652G	51	5.700G	52	5.317G
53	5.592G	54	5.473G	55	5.398G	56	5.573G
57	5.393G	58	5.674G	59	5.635G	60	5.546G
61	5.370G	62	5.542G	63	5.376G	64	5.561G
65	5.385G	66	5.606G	67	5.516G	68	5.613G
69	5.701G	70	5.510G	71	5.397G	72	5.332G
73	5.642G	74	5.651G	75	5.430G	76	5.551G
77	5.560G	78	5.316G	79	5.302G	80	5.382G
81	5.714G	82	5.341G	83	5.429G	84	5.693G
85	5.523G	86	5.470G	87	5.252G	88	5.420G
89	5.266G	90	5.563G	91	5.472G	92	5.601G
93	5.273G	94	5.340G	95	5.296G	96	5.333G
97	5.441G	98	5.550G	99	5.475G	100	5.678G

Hopping Frequency Sequence Name: HOP_FREQ_SEQ_09							
SEQ#	Frequency (Hz)	SEQ#	Frequency (Hz)	SEQ#	Frequency (Hz)	SEQ#	Frequency (Hz)
1	5.618G	2	5.628G	3	5.634G	4	5.468G
5	5.711G	6	5.257G	7	5.588G	8	5.445G
9	5.625G	10	5.675G	11	5.527G	12	5.470G
13	5.707G	14	5.438G	15	5.559G	16	5.499G
17	5.388G	18	5.662G	19	5.594G	20	5.394G
21	5.354G	22	5.678G	23	5.418G	24	5.332G
25	5.696G	26	5.716G	27	5.621G	28	5.450G
29	5.348G	30	5.434G	31	5.452G	32	5.368G
33	5.382G	34	5.254G	35	5.578G	36	5.377G
37	5.269G	38	5.554G	39	5.449G	40	5.430G
41	5.383G	42	5.623G	43	5.401G	44	5.399G
45	5.550G	46	5.586G	47	5.581G	48	5.308G
49	5.512G	50	5.275G	51	5.362G	52	5.363G
53	5.576G	54	5.671G	55	5.342G	56	5.381G
57	5.284G	58	5.390G	59	5.605G	60	5.455G
61	5.503G	62	5.547G	63	5.562G	64	5.429G
65	5.704G	66	5.426G	67	5.411G	68	5.613G
69	5.584G	70	5.311G	71	5.501G	72	5.537G
73	5.451G	74	5.717G	75	5.709G	76	5.695G
77	5.303G	78	5.369G	79	5.514G	80	5.570G
81	5.665G	82	5.592G	83	5.631G	84	5.253G
85	5.622G	86	5.463G	87	5.469G	88	5.518G
89	5.437G	90	5.642G	91	5.630G	92	5.398G
93	5.491G	94	5.367G	95	5.346G	96	5.425G
97	5.414G	98	5.640G	99	5.321G	100	5.393G

Hopping Frequency Sequence Name: HOP_FREQ_SEQ_10							
SEQ#	Frequency (Hz)	SEQ#	Frequency (Hz)	SEQ#	Frequency (Hz)	SEQ#	Frequency (Hz)
1	5.314G	2	5.430G	3	5.302G	4	5.313G
5	5.617G	6	5.493G	7	5.598G	8	5.300G
9	5.712G	10	5.573G	11	5.578G	12	5.340G
13	5.359G	14	5.593G	15	5.351G	16	5.451G
17	5.354G	18	5.389G	19	5.275G	20	5.625G
21	5.515G	22	5.574G	23	5.404G	24	5.552G
25	5.426G	26	5.561G	27	5.685G	28	5.555G
29	5.592G	30	5.363G	31	5.717G	32	5.347G
33	5.252G	34	5.701G	35	5.614G	36	5.608G
37	5.671G	38	5.449G	39	5.556G	40	5.371G
41	5.373G	42	5.652G	43	5.365G	44	5.304G
45	5.537G	46	5.634G	47	5.281G	48	5.647G
49	5.324G	50	5.544G	51	5.447G	52	5.437G
53	5.400G	54	5.289G	55	5.325G	56	5.505G
57	5.603G	58	5.279G	59	5.416G	60	5.446G
61	5.326G	62	5.419G	63	5.550G	64	5.409G
65	5.605G	66	5.316G	67	5.360G	68	5.540G
69	5.370G	70	5.495G	71	5.613G	72	5.467G
73	5.362G	74	5.514G	75	5.298G	76	5.559G
77	5.380G	78	5.636G	79	5.589G	80	5.470G
81	5.551G	82	5.428G	83	5.429G	84	5.716G
85	5.361G	86	5.330G	87	5.441G	88	5.402G
89	5.271G	90	5.297G	91	5.696G	92	5.691G
93	5.376G	94	5.424G	95	5.707G	96	5.307G
97	5.435G	98	5.385G	99	5.638G	100	5.563G

Hopping Frequency Sequence Name: HOP_FREQ_SEQ_11							
SEQ#	Frequency (Hz)	SEQ#	Frequency (Hz)	SEQ#	Frequency (Hz)	SEQ#	Frequency (Hz)
1	5.583G	2	5.494G	3	5.698G	4	5.598G
5	5.625G	6	5.370G	7	5.326G	8	5.606G
9	5.498G	10	5.328G	11	5.694G	12	5.709G
13	5.613G	14	5.481G	15	5.418G	16	5.677G
17	5.448G	18	5.343G	19	5.357G	20	5.554G
21	5.659G	22	5.396G	23	5.303G	24	5.419G
25	5.362G	26	5.428G	27	5.469G	28	5.268G
29	5.394G	30	5.492G	31	5.663G	32	5.720G
33	5.567G	34	5.356G	35	5.635G	36	5.372G
37	5.386G	38	5.345G	39	5.600G	40	5.412G
41	5.258G	42	5.411G	43	5.301G	44	5.618G
45	5.699G	46	5.604G	47	5.463G	48	5.542G
49	5.680G	50	5.670G	51	5.368G	52	5.589G
53	5.553G	54	5.515G	55	5.446G	56	5.304G
57	5.441G	58	5.424G	59	5.620G	60	5.263G
61	5.592G	62	5.629G	63	5.466G	64	5.556G
65	5.636G	66	5.722G	67	5.302G	68	5.656G
69	5.252G	70	5.286G	71	5.369G	72	5.723G
73	5.573G	74	5.569G	75	5.558G	76	5.250G
77	5.500G	78	5.457G	79	5.462G	80	5.562G
81	5.716G	82	5.614G	83	5.347G	84	5.565G
85	5.288G	86	5.627G	87	5.342G	88	5.696G
89	5.712G	90	5.337G	91	5.649G	92	5.538G
93	5.688G	94	5.549G	95	5.272G	96	5.447G
97	5.519G	98	5.323G	99	5.314G	100	5.706G

Hopping Frequency Sequence Name: HOP_FREQ_SEQ_12							
SEQ#	Frequency (Hz)	SEQ#	Frequency (Hz)	SEQ#	Frequency (Hz)	SEQ#	Frequency (Hz)
1	5.511G	2	5.597G	3	5.289G	4	5.670G
5	5.617G	6	5.438G	7	5.491G	8	5.682G
9	5.526G	10	5.298G	11	5.352G	12	5.714G
13	5.689G	14	5.688G	15	5.360G	16	5.431G
17	5.530G	18	5.549G	19	5.478G	20	5.411G
21	5.658G	22	5.356G	23	5.265G	24	5.345G
25	5.520G	26	5.624G	27	5.562G	28	5.674G
29	5.284G	30	5.707G	31	5.464G	32	5.502G
33	5.315G	34	5.297G	35	5.639G	36	5.469G
37	5.407G	38	5.353G	39	5.542G	40	5.458G
41	5.545G	42	5.367G	43	5.569G	44	5.687G
45	5.680G	46	5.722G	47	5.312G	48	5.465G
49	5.574G	50	5.319G	51	5.648G	52	5.702G
53	5.664G	54	5.515G	55	5.613G	56	5.504G
57	5.662G	58	5.251G	59	5.322G	60	5.448G
61	5.395G	62	5.582G	63	5.350G	64	5.563G
65	5.508G	66	5.261G	67	5.577G	68	5.393G
69	5.280G	70	5.374G	71	5.380G	72	5.519G
73	5.460G	74	5.587G	75	5.720G	76	5.653G
77	5.611G	78	5.657G	79	5.596G	80	5.642G
81	5.684G	82	5.604G	83	5.538G	84	5.415G
85	5.692G	86	5.423G	87	5.258G	88	5.336G
89	5.436G	90	5.349G	91	5.287G	92	5.427G
93	5.283G	94	5.711G	95	5.316G	96	5.638G
97	5.507G	98	5.691G	99	5.399G	100	5.610G

Hopping Frequency Sequence Name: HOP_FREQ_SEQ_13							
SEQ#	Frequency (Hz)	SEQ#	Frequency (Hz)	SEQ#	Frequency (Hz)	SEQ#	Frequency (Hz)
1	5.524G	2	5.546G	3	5.257G	4	5.323G
5	5.303G	6	5.498G	7	5.585G	8	5.653G
9	5.540G	10	5.413G	11	5.482G	12	5.462G
13	5.296G	14	5.656G	15	5.626G	16	5.631G
17	5.567G	18	5.711G	19	5.418G	20	5.374G
21	5.666G	22	5.623G	23	5.382G	24	5.408G
25	5.615G	26	5.394G	27	5.593G	28	5.657G
29	5.441G	30	5.395G	31	5.714G	32	5.607G
33	5.254G	34	5.612G	35	5.677G	36	5.717G
37	5.684G	38	5.660G	39	5.273G	40	5.415G
41	5.351G	42	5.484G	43	5.673G	44	5.610G
45	5.442G	46	5.478G	47	5.661G	48	5.563G
49	5.560G	50	5.617G	51	5.463G	52	5.459G
53	5.469G	54	5.417G	55	5.525G	56	5.555G
57	5.493G	58	5.371G	59	5.516G	60	5.663G
61	5.347G	62	5.288G	63	5.580G	64	5.350G
65	5.378G	66	5.700G	67	5.597G	68	5.324G
69	5.458G	70	5.471G	71	5.538G	72	5.599G
73	5.426G	74	5.310G	75	5.688G	76	5.333G
77	5.475G	78	5.258G	79	5.419G	80	5.701G
81	5.600G	82	5.590G	83	5.690G	84	5.528G
85	5.362G	86	5.342G	87	5.502G	88	5.414G
89	5.457G	90	5.297G	91	5.357G	92	5.509G
93	5.274G	94	5.451G	95	5.328G	96	5.539G
97	5.596G	98	5.479G	99	5.474G	100	5.284G

Hopping Frequency Sequence Name: HOP_FREQ_SEQ_14							
SEQ#	Frequency (Hz)	SEQ#	Frequency (Hz)	SEQ#	Frequency (Hz)	SEQ#	Frequency (Hz)
1	5.284G	2	5.688G	3	5.520G	4	5.344G
5	5.339G	6	5.657G	7	5.545G	8	5.607G
9	5.538G	10	5.297G	11	5.658G	12	5.600G
13	5.460G	14	5.285G	15	5.398G	16	5.264G
17	5.303G	18	5.465G	19	5.708G	20	5.443G
21	5.421G	22	5.630G	23	5.386G	24	5.357G
25	5.723G	26	5.684G	27	5.483G	28	5.551G
29	5.529G	30	5.275G	31	5.381G	32	5.444G
33	5.639G	34	5.345G	35	5.326G	36	5.506G
37	5.531G	38	5.679G	39	5.355G	40	5.649G
41	5.560G	42	5.377G	43	5.331G	44	5.428G
45	5.575G	46	5.500G	47	5.509G	48	5.656G
49	5.693G	50	5.376G	51	5.434G	52	5.327G
53	5.542G	54	5.368G	55	5.321G	56	5.349G
57	5.389G	58	5.353G	59	5.606G	60	5.494G
61	5.315G	62	5.568G	63	5.559G	64	5.278G
65	5.680G	66	5.288G	67	5.557G	68	5.405G
69	5.589G	70	5.634G	71	5.721G	72	5.350G
73	5.485G	74	5.481G	75	5.433G	76	5.296G
77	5.691G	78	5.544G	79	5.587G	80	5.599G
81	5.713G	82	5.632G	83	5.676G	84	5.307G
85	5.497G	86	5.328G	87	5.653G	88	5.578G
89	5.332G	90	5.608G	91	5.310G	92	5.445G
93	5.419G	94	5.576G	95	5.503G	96	5.549G
97	5.322G	98	5.683G	99	5.707G	100	5.698G

Hopping Frequency Sequence Name: HOP_FREQ_SEQ_15							
SEQ#	Frequency (Hz)	SEQ#	Frequency (Hz)	SEQ#	Frequency (Hz)	SEQ#	Frequency (Hz)
1	5.522G	2	5.425G	3	5.421G	4	5.722G
5	5.369G	6	5.553G	7	5.395G	8	5.265G
9	5.669G	10	5.543G	11	5.266G	12	5.490G
13	5.724G	14	5.250G	15	5.405G	16	5.579G
17	5.520G	18	5.608G	19	5.686G	20	5.404G
21	5.494G	22	5.560G	23	5.446G	24	5.367G
25	5.545G	26	5.388G	27	5.350G	28	5.402G
29	5.640G	30	5.286G	31	5.273G	32	5.680G
33	5.256G	34	5.292G	35	5.308G	36	5.481G
37	5.304G	38	5.600G	39	5.397G	40	5.299G
41	5.386G	42	5.586G	43	5.602G	44	5.444G
45	5.684G	46	5.505G	47	5.723G	48	5.613G
49	5.532G	50	5.319G	51	5.595G	52	5.370G
53	5.318G	54	5.314G	55	5.487G	56	5.531G
57	5.604G	58	5.272G	59	5.572G	60	5.598G
61	5.384G	62	5.591G	63	5.619G	64	5.695G
65	5.372G	66	5.452G	67	5.443G	68	5.269G
69	5.462G	70	5.568G	71	5.346G	72	5.422G
73	5.257G	74	5.523G	75	5.671G	76	5.307G
77	5.361G	78	5.416G	79	5.433G	80	5.617G
81	5.398G	82	5.351G	83	5.485G	84	5.650G
85	5.347G	86	5.334G	87	5.442G	88	5.276G
89	5.392G	90	5.360G	91	5.456G	92	5.468G
93	5.309G	94	5.328G	95	5.497G	96	5.337G
97	5.294G	98	5.261G	99	5.557G	100	5.665G

Hopping Frequency Sequence Name: HOP_FREQ_SEQ_16							
SEQ#	Frequency (Hz)	SEQ#	Frequency (Hz)	SEQ#	Frequency (Hz)	SEQ#	Frequency (Hz)
1	5.587G	2	5.395G	3	5.533G	4	5.319G
5	5.473G	6	5.361G	7	5.697G	8	5.549G
9	5.680G	10	5.507G	11	5.526G	12	5.374G
13	5.377G	14	5.723G	15	5.444G	16	5.457G
17	5.347G	18	5.517G	19	5.313G	20	5.412G
21	5.720G	22	5.719G	23	5.380G	24	5.410G
25	5.692G	26	5.323G	27	5.466G	28	5.506G
29	5.386G	30	5.286G	31	5.643G	32	5.681G
33	5.370G	34	5.333G	35	5.476G	36	5.498G
37	5.655G	38	5.368G	39	5.612G	40	5.254G
41	5.602G	42	5.627G	43	5.335G	44	5.404G
45	5.718G	46	5.656G	47	5.667G	48	5.431G
49	5.686G	50	5.651G	51	5.585G	52	5.649G
53	5.265G	54	5.474G	55	5.268G	56	5.631G
57	5.376G	58	5.260G	59	5.488G	60	5.521G
61	5.672G	62	5.618G	63	5.403G	64	5.610G
65	5.315G	66	5.556G	67	5.659G	68	5.420G
69	5.596G	70	5.270G	71	5.324G	72	5.546G
73	5.358G	74	5.675G	75	5.295G	76	5.568G
77	5.281G	78	5.630G	79	5.499G	80	5.263G
81	5.325G	82	5.541G	83	5.490G	84	5.371G
85	5.634G	86	5.464G	87	5.352G	88	5.326G
89	5.330G	90	5.606G	91	5.711G	92	5.381G
93	5.580G	94	5.280G	95	5.554G	96	5.362G
97	5.626G	98	5.510G	99	5.716G	100	5.441G

Hopping Frequency Sequence Name: HOP_FREQ_SEQ_17							
SEQ#	Frequency (Hz)	SEQ#	Frequency (Hz)	SEQ#	Frequency (Hz)	SEQ#	Frequency (Hz)
1	5.293G	2	5.283G	3	5.433G	4	5.556G
5	5.494G	6	5.344G	7	5.320G	8	5.656G
9	5.405G	10	5.606G	11	5.323G	12	5.358G
13	5.274G	14	5.521G	15	5.434G	16	5.546G
17	5.644G	18	5.487G	19	5.313G	20	5.676G
21	5.609G	22	5.297G	23	5.565G	24	5.377G
25	5.288G	26	5.397G	27	5.470G	28	5.299G
29	5.645G	30	5.292G	31	5.667G	32	5.473G
33	5.615G	34	5.513G	35	5.558G	36	5.447G
37	5.549G	38	5.362G	39	5.365G	40	5.465G
41	5.483G	42	5.370G	43	5.361G	44	5.702G
45	5.369G	46	5.723G	47	5.328G	48	5.278G
49	5.311G	50	5.539G	51	5.419G	52	5.554G
53	5.262G	54	5.379G	55	5.713G	56	5.493G
57	5.294G	58	5.603G	59	5.304G	60	5.340G
61	5.614G	62	5.350G	63	5.551G	64	5.626G
65	5.295G	66	5.671G	67	5.336G	68	5.694G
69	5.621G	70	5.540G	71	5.648G	72	5.391G
73	5.373G	74	5.682G	75	5.463G	76	5.672G
77	5.559G	78	5.477G	79	5.518G	80	5.607G
81	5.647G	82	5.442G	83	5.720G	84	5.590G
85	5.403G	86	5.580G	87	5.591G	88	5.637G
89	5.506G	90	5.411G	91	5.587G	92	5.543G
93	5.601G	94	5.455G	95	5.697G	96	5.668G
97	5.695G	98	5.271G	99	5.430G	100	5.514G

Hopping Frequency Sequence Name: HOP_FREQ_SEQ_18							
SEQ#	Frequency (Hz)	SEQ#	Frequency (Hz)	SEQ#	Frequency (Hz)	SEQ#	Frequency (Hz)
1	5.715G	2	5.594G	3	5.450G	4	5.473G
5	5.287G	6	5.338G	7	5.346G	8	5.288G
9	5.542G	10	5.306G	11	5.333G	12	5.472G
13	5.490G	14	5.551G	15	5.644G	16	5.651G
17	5.618G	18	5.434G	19	5.691G	20	5.666G
21	5.648G	22	5.558G	23	5.397G	24	5.316G
25	5.602G	26	5.545G	27	5.336G	28	5.701G
29	5.401G	30	5.582G	31	5.576G	32	5.429G
33	5.367G	34	5.527G	35	5.344G	36	5.286G
37	5.304G	38	5.660G	39	5.687G	40	5.631G
41	5.622G	42	5.677G	43	5.383G	44	5.296G
45	5.619G	46	5.503G	47	5.708G	48	5.482G
49	5.624G	50	5.599G	51	5.667G	52	5.298G
53	5.414G	54	5.349G	55	5.548G	56	5.615G
57	5.568G	58	5.424G	59	5.720G	60	5.271G
61	5.369G	62	5.559G	63	5.276G	64	5.356G
65	5.256G	66	5.681G	67	5.540G	68	5.263G
69	5.275G	70	5.629G	71	5.303G	72	5.433G
73	5.481G	74	5.523G	75	5.285G	76	5.407G
77	5.378G	78	5.512G	79	5.650G	80	5.278G
81	5.446G	82	5.546G	83	5.486G	84	5.564G
85	5.613G	86	5.390G	87	5.348G	88	5.468G
89	5.565G	90	5.518G	91	5.600G	92	5.311G
93	5.506G	94	5.484G	95	5.438G	96	5.381G
97	5.553G	98	5.364G	99	5.423G	100	5.343G

Hopping Frequency Sequence Name: HOP_FREQ_SEQ_19							
SEQ#	Frequency (Hz)	SEQ#	Frequency (Hz)	SEQ#	Frequency (Hz)	SEQ#	Frequency (Hz)
1	5.666G	2	5.487G	3	5.470G	4	5.359G
5	5.338G	6	5.472G	7	5.390G	8	5.708G
9	5.589G	10	5.366G	11	5.485G	12	5.519G
13	5.337G	14	5.659G	15	5.501G	16	5.405G
17	5.295G	18	5.369G	19	5.284G	20	5.425G
21	5.661G	22	5.447G	23	5.483G	24	5.267G
25	5.285G	26	5.549G	27	5.306G	28	5.473G
29	5.637G	30	5.578G	31	5.513G	32	5.605G
33	5.623G	34	5.573G	35	5.536G	36	5.663G
37	5.511G	38	5.479G	39	5.611G	40	5.510G
41	5.403G	42	5.301G	43	5.711G	44	5.706G
45	5.259G	46	5.554G	47	5.494G	48	5.254G
49	5.250G	50	5.497G	51	5.291G	52	5.543G
53	5.495G	54	5.376G	55	5.481G	56	5.325G
57	5.506G	58	5.697G	59	5.340G	60	5.378G
61	5.579G	62	5.558G	63	5.664G	64	5.364G
65	5.290G	66	5.467G	67	5.446G	68	5.417G
69	5.684G	70	5.700G	71	5.408G	72	5.545G
73	5.316G	74	5.305G	75	5.616G	76	5.329G
77	5.255G	78	5.601G	79	5.455G	80	5.486G
81	5.478G	82	5.383G	83	5.450G	84	5.358G
85	5.678G	86	5.407G	87	5.514G	88	5.718G
89	5.331G	90	5.468G	91	5.698G	92	5.507G
93	5.312G	94	5.719G	95	5.372G	96	5.570G
97	5.271G	98	5.528G	99	5.582G	100	5.644G

Hopping Frequency Sequence Name: HOP_FREQ_SEQ_20							
SEQ#	Frequency (Hz)	SEQ#	Frequency (Hz)	SEQ#	Frequency (Hz)	SEQ#	Frequency (Hz)
1	5.388G	2	5.645G	3	5.618G	4	5.275G
5	5.406G	6	5.363G	7	5.279G	8	5.639G
9	5.665G	10	5.617G	11	5.579G	12	5.691G
13	5.295G	14	5.602G	15	5.372G	16	5.484G
17	5.516G	18	5.345G	19	5.649G	20	5.597G
21	5.394G	22	5.404G	23	5.487G	24	5.483G
25	5.543G	26	5.722G	27	5.574G	28	5.353G
29	5.528G	30	5.522G	31	5.401G	32	5.467G
33	5.325G	34	5.585G	35	5.277G	36	5.264G
37	5.525G	38	5.586G	39	5.430G	40	5.350G
41	5.445G	42	5.635G	43	5.675G	44	5.285G
45	5.674G	46	5.307G	47	5.328G	48	5.338G
49	5.286G	50	5.540G	51	5.657G	52	5.313G
53	5.546G	54	5.370G	55	5.358G	56	5.611G
57	5.495G	58	5.410G	59	5.268G	60	5.640G
61	5.311G	62	5.513G	63	5.584G	64	5.562G
65	5.518G	66	5.572G	67	5.456G	68	5.680G
69	5.461G	70	5.348G	71	5.505G	72	5.340G
73	5.409G	74	5.699G	75	5.362G	76	5.714G
77	5.706G	78	5.684G	79	5.431G	80	5.463G
81	5.288G	82	5.418G	83	5.374G	84	5.270G
85	5.571G	86	5.414G	87	5.266G	88	5.322G
89	5.547G	90	5.272G	91	5.710G	92	5.327G
93	5.331G	94	5.282G	95	5.403G	96	5.560G
97	5.342G	98	5.321G	99	5.701G	100	5.504G

Hopping Frequency Sequence Name: HOP_FREQ_SEQ_21							
SEQ#	Frequency (Hz)	SEQ#	Frequency (Hz)	SEQ#	Frequency (Hz)	SEQ#	Frequency (Hz)
1	5.637G	2	5.337G	3	5.452G	4	5.302G
5	5.278G	6	5.606G	7	5.696G	8	5.579G
9	5.363G	10	5.285G	11	5.275G	12	5.484G
13	5.427G	14	5.468G	15	5.309G	16	5.607G
17	5.494G	18	5.684G	19	5.272G	20	5.697G
21	5.447G	22	5.367G	23	5.338G	24	5.504G
25	5.465G	26	5.381G	27	5.368G	28	5.471G
29	5.310G	30	5.455G	31	5.553G	32	5.626G
33	5.457G	34	5.420G	35	5.362G	36	5.621G
37	5.700G	38	5.599G	39	5.653G	40	5.615G
41	5.402G	42	5.379G	43	5.490G	44	5.715G
45	5.695G	46	5.595G	47	5.421G	48	5.609G
49	5.664G	50	5.642G	51	5.628G	52	5.674G
53	5.507G	54	5.617G	55	5.656G	56	5.493G
57	5.266G	58	5.714G	59	5.319G	60	5.441G
61	5.478G	62	5.444G	63	5.474G	64	5.575G
65	5.294G	66	5.282G	67	5.328G	68	5.462G
69	5.289G	70	5.724G	71	5.454G	72	5.306G
73	5.380G	74	5.332G	75	5.677G	76	5.374G
77	5.712G	78	5.387G	79	5.472G	80	5.542G
81	5.533G	82	5.426G	83	5.254G	84	5.669G
85	5.271G	86	5.577G	87	5.502G	88	5.403G
89	5.543G	90	5.571G	91	5.513G	92	5.479G
93	5.601G	94	5.482G	95	5.428G	96	5.614G
97	5.336G	98	5.372G	99	5.600G	100	5.470G

Hopping Frequency Sequence Name: HOP_FREQ_SEQ_22							
SEQ#	Frequency (Hz)	SEQ#	Frequency (Hz)	SEQ#	Frequency (Hz)	SEQ#	Frequency (Hz)
1	5.335G	2	5.570G	3	5.334G	4	5.433G
5	5.464G	6	5.451G	7	5.687G	8	5.586G
9	5.254G	10	5.634G	11	5.438G	12	5.722G
13	5.386G	14	5.607G	15	5.290G	16	5.262G
17	5.515G	18	5.441G	19	5.636G	20	5.270G
21	5.256G	22	5.279G	23	5.620G	24	5.447G
25	5.471G	26	5.417G	27	5.473G	28	5.708G
29	5.468G	30	5.362G	31	5.572G	32	5.563G
33	5.328G	34	5.601G	35	5.541G	36	5.629G
37	5.393G	38	5.667G	39	5.531G	40	5.313G
41	5.633G	42	5.403G	43	5.613G	44	5.553G
45	5.465G	46	5.716G	47	5.329G	48	5.356G
49	5.320G	50	5.391G	51	5.255G	52	5.276G
53	5.324G	54	5.271G	55	5.500G	56	5.646G
57	5.404G	58	5.265G	59	5.671G	60	5.616G
61	5.371G	62	5.606G	63	5.477G	64	5.467G
65	5.561G	66	5.359G	67	5.603G	68	5.407G
69	5.426G	70	5.715G	71	5.663G	72	5.680G
73	5.463G	74	5.274G	75	5.567G	76	5.721G
77	5.678G	78	5.657G	79	5.443G	80	5.338G
81	5.293G	82	5.325G	83	5.724G	84	5.402G
85	5.581G	86	5.478G	87	5.507G	88	5.669G
89	5.409G	90	5.495G	91	5.627G	92	5.519G
93	5.508G	94	5.322G	95	5.373G	96	5.382G
97	5.530G	98	5.589G	99	5.587G	100	5.580G

Hopping Frequency Sequence Name: HOP_FREQ_SEQ_23							
SEQ#	Frequency (Hz)	SEQ#	Frequency (Hz)	SEQ#	Frequency (Hz)	SEQ#	Frequency (Hz)
1	5.295G	2	5.251G	3	5.536G	4	5.257G
5	5.694G	6	5.615G	7	5.373G	8	5.529G
9	5.255G	10	5.542G	11	5.604G	12	5.280G
13	5.288G	14	5.479G	15	5.706G	16	5.600G
17	5.420G	18	5.640G	19	5.256G	20	5.260G
21	5.605G	22	5.349G	23	5.466G	24	5.576G
25	5.310G	26	5.696G	27	5.658G	28	5.284G
29	5.286G	30	5.651G	31	5.324G	32	5.570G
33	5.627G	34	5.610G	35	5.541G	36	5.505G
37	5.527G	38	5.481G	39	5.270G	40	5.301G
41	5.667G	42	5.516G	43	5.409G	44	5.299G
45	5.348G	46	5.482G	47	5.617G	48	5.586G
49	5.442G	50	5.297G	51	5.470G	52	5.296G
53	5.417G	54	5.282G	55	5.671G	56	5.676G
57	5.506G	58	5.421G	59	5.438G	60	5.345G
61	5.402G	62	5.350G	63	5.483G	64	5.577G
65	5.573G	66	5.537G	67	5.635G	68	5.426G
69	5.278G	70	5.303G	71	5.276G	72	5.591G
73	5.686G	74	5.568G	75	5.559G	76	5.712G
77	5.621G	78	5.414G	79	5.669G	80	5.398G
81	5.630G	82	5.521G	83	5.662G	84	5.619G
85	5.262G	86	5.578G	87	5.335G	88	5.401G
89	5.645G	90	5.312G	91	5.546G	92	5.292G
93	5.654G	94	5.663G	95	5.557G	96	5.628G
97	5.504G	98	5.305G	99	5.632G	100	5.624G

Hopping Frequency Sequence Name: HOP_FREQ_SEQ_24							
SEQ#	Frequency (Hz)	SEQ#	Frequency (Hz)	SEQ#	Frequency (Hz)	SEQ#	Frequency (Hz)
1	5.471G	2	5.508G	3	5.494G	4	5.442G
5	5.648G	6	5.621G	7	5.433G	8	5.405G
9	5.339G	10	5.302G	11	5.546G	12	5.502G
13	5.268G	14	5.607G	15	5.673G	16	5.406G
17	5.669G	18	5.307G	19	5.453G	20	5.670G
21	5.274G	22	5.570G	23	5.636G	24	5.484G
25	5.599G	26	5.458G	27	5.294G	28	5.595G
29	5.308G	30	5.606G	31	5.556G	32	5.402G
33	5.392G	34	5.626G	35	5.603G	36	5.416G
37	5.645G	38	5.709G	39	5.665G	40	5.407G
41	5.290G	42	5.298G	43	5.628G	44	5.314G
45	5.363G	46	5.366G	47	5.557G	48	5.321G
49	5.722G	50	5.525G	51	5.351G	52	5.390G
53	5.309G	54	5.614G	55	5.464G	56	5.281G
57	5.639G	58	5.293G	59	5.424G	60	5.413G
61	5.332G	62	5.478G	63	5.305G	64	5.398G
65	5.619G	66	5.507G	67	5.642G	68	5.299G
69	5.488G	70	5.480G	71	5.396G	72	5.682G
73	5.450G	74	5.592G	75	5.403G	76	5.374G
77	5.538G	78	5.287G	79	5.282G	80	5.537G
81	5.710G	82	5.641G	83	5.615G	84	5.358G
85	5.613G	86	5.438G	87	5.346G	88	5.386G
89	5.680G	90	5.255G	91	5.486G	92	5.379G
93	5.304G	94	5.320G	95	5.446G	96	5.720G
97	5.503G	98	5.690G	99	5.269G	100	5.306G

Hopping Frequency Sequence Name: HOP_FREQ_SEQ_25							
SEQ#	Frequency (Hz)	SEQ#	Frequency (Hz)	SEQ#	Frequency (Hz)	SEQ#	Frequency (Hz)
1	5.545G	2	5.281G	3	5.677G	4	5.635G
5	5.287G	6	5.663G	7	5.632G	8	5.290G
9	5.395G	10	5.614G	11	5.260G	12	5.396G
13	5.646G	14	5.538G	15	5.390G	16	5.611G
17	5.402G	18	5.647G	19	5.561G	20	5.397G
21	5.373G	22	5.444G	23	5.315G	24	5.300G
25	5.501G	26	5.407G	27	5.670G	28	5.514G
29	5.448G	30	5.343G	31	5.294G	32	5.382G
33	5.580G	34	5.606G	35	5.261G	36	5.329G
37	5.334G	38	5.527G	39	5.480G	40	5.666G
41	5.276G	42	5.422G	43	5.301G	44	5.639G
45	5.661G	46	5.684G	47	5.616G	48	5.369G
49	5.385G	50	5.317G	51	5.590G	52	5.253G
53	5.689G	54	5.375G	55	5.714G	56	5.693G
57	5.496G	58	5.596G	59	5.583G	60	5.529G
61	5.340G	62	5.477G	63	5.723G	64	5.656G
65	5.252G	66	5.662G	67	5.629G	68	5.622G
69	5.335G	70	5.592G	71	5.360G	72	5.333G
73	5.391G	74	5.603G	75	5.374G	76	5.665G
77	5.420G	78	5.681G	79	5.674G	80	5.368G
81	5.324G	82	5.312G	83	5.468G	84	5.319G
85	5.559G	86	5.518G	87	5.367G	88	5.275G
89	5.709G	90	5.262G	91	5.692G	92	5.582G
93	5.584G	94	5.473G	95	5.282G	96	5.331G
97	5.298G	98	5.565G	99	5.470G	100	5.626G

Hopping Frequency Sequence Name: HOP_FREQ_SEQ_26							
SEQ#	Frequency (Hz)	SEQ#	Frequency (Hz)	SEQ#	Frequency (Hz)	SEQ#	Frequency (Hz)
1	5.475G	2	5.337G	3	5.544G	4	5.723G
5	5.509G	6	5.506G	7	5.328G	8	5.327G
9	5.260G	10	5.716G	11	5.542G	12	5.256G
13	5.441G	14	5.349G	15	5.634G	16	5.680G
17	5.545G	18	5.661G	19	5.469G	20	5.704G
21	5.478G	22	5.446G	23	5.393G	24	5.521G
25	5.400G	26	5.306G	27	5.295G	28	5.280G
29	5.367G	30	5.557G	31	5.681G	32	5.471G
33	5.573G	34	5.637G	35	5.554G	36	5.444G
37	5.292G	38	5.552G	39	5.413G	40	5.588G
41	5.252G	42	5.447G	43	5.496G	44	5.582G
45	5.502G	46	5.373G	47	5.311G	48	5.415G
49	5.354G	50	5.412G	51	5.418G	52	5.685G
53	5.267G	54	5.483G	55	5.334G	56	5.626G
57	5.368G	58	5.600G	59	5.307G	60	5.498G
61	5.428G	62	5.341G	63	5.693G	64	5.569G
65	5.495G	66	5.647G	67	5.266G	68	5.481G
69	5.624G	70	5.477G	71	5.399G	72	5.422G
73	5.452G	74	5.689G	75	5.282G	76	5.296G
77	5.344G	78	5.333G	79	5.301G	80	5.595G
81	5.503G	82	5.501G	83	5.277G	84	5.358G
85	5.253G	86	5.419G	87	5.593G	88	5.456G
89	5.673G	90	5.629G	91	5.656G	92	5.671G
93	5.375G	94	5.650G	95	5.459G	96	5.678G
97	5.635G	98	5.615G	99	5.434G	100	5.575G

Hopping Frequency Sequence Name: HOP_FREQ_SEQ_27							
SEQ#	Frequency (Hz)	SEQ#	Frequency (Hz)	SEQ#	Frequency (Hz)	SEQ#	Frequency (Hz)
1	5.289G	2	5.560G	3	5.603G	4	5.697G
5	5.449G	6	5.529G	7	5.462G	8	5.262G
9	5.570G	10	5.701G	11	5.340G	12	5.274G
13	5.651G	14	5.673G	15	5.536G	16	5.712G
17	5.411G	18	5.566G	19	5.686G	20	5.376G
21	5.717G	22	5.531G	23	5.692G	24	5.295G
25	5.611G	26	5.719G	27	5.661G	28	5.667G
29	5.311G	30	5.470G	31	5.287G	32	5.561G
33	5.316G	34	5.517G	35	5.286G	36	5.604G
37	5.556G	38	5.398G	39	5.446G	40	5.350G
41	5.282G	42	5.380G	43	5.549G	44	5.480G
45	5.522G	46	5.408G	47	5.623G	48	5.416G
49	5.263G	50	5.352G	51	5.621G	52	5.674G
53	5.714G	54	5.644G	55	5.665G	56	5.412G
57	5.305G	58	5.315G	59	5.710G	60	5.251G
61	5.471G	62	5.302G	63	5.357G	64	5.575G
65	5.432G	66	5.630G	67	5.456G	68	5.720G
69	5.707G	70	5.513G	71	5.303G	72	5.330G
73	5.482G	74	5.296G	75	5.595G	76	5.457G
77	5.297G	78	5.371G	79	5.632G	80	5.643G
81	5.540G	82	5.687G	83	5.310G	84	5.684G
85	5.721G	86	5.658G	87	5.465G	88	5.341G
89	5.553G	90	5.506G	91	5.563G	92	5.463G
93	5.691G	94	5.417G	95	5.481G	96	5.472G
97	5.581G	98	5.500G	99	5.304G	100	5.568G

Hopping Frequency Sequence Name: HOP_FREQ_SEQ_28							
SEQ#	Frequency (Hz)	SEQ#	Frequency (Hz)	SEQ#	Frequency (Hz)	SEQ#	Frequency (Hz)
1	5.388G	2	5.252G	3	5.315G	4	5.290G
5	5.590G	6	5.638G	7	5.636G	8	5.550G
9	5.335G	10	5.642G	11	5.254G	12	5.566G
13	5.549G	14	5.640G	15	5.279G	16	5.499G
17	5.649G	18	5.267G	19	5.491G	20	5.587G
21	5.712G	22	5.309G	23	5.393G	24	5.260G
25	5.416G	26	5.271G	27	5.293G	28	5.366G
29	5.596G	30	5.446G	31	5.594G	32	5.624G
33	5.438G	34	5.343G	35	5.319G	36	5.313G
37	5.310G	38	5.341G	39	5.650G	40	5.263G
41	5.560G	42	5.403G	43	5.580G	44	5.508G
45	5.265G	46	5.272G	47	5.684G	48	5.479G
49	5.456G	50	5.701G	51	5.277G	52	5.620G
53	5.588G	54	5.289G	55	5.258G	56	5.611G
57	5.327G	58	5.300G	59	5.405G	60	5.564G
61	5.628G	62	5.409G	63	5.670G	64	5.255G
65	5.529G	66	5.497G	67	5.326G	68	5.496G
69	5.711G	70	5.717G	71	5.357G	72	5.724G
73	5.526G	74	5.618G	75	5.274G	76	5.441G
77	5.678G	78	5.544G	79	5.614G	80	5.418G
81	5.386G	82	5.721G	83	5.668G	84	5.379G
85	5.463G	86	5.396G	87	5.664G	88	5.353G
89	5.703G	90	5.298G	91	5.644G	92	5.307G
93	5.509G	94	5.553G	95	5.681G	96	5.589G
97	5.513G	98	5.547G	99	5.527G	100	5.295G

Hopping Frequency Sequence Name: HOP_FREQ_SEQ_29							
SEQ#	Frequency (Hz)	SEQ#	Frequency (Hz)	SEQ#	Frequency (Hz)	SEQ#	Frequency (Hz)
1	5.351G	2	5.612G	3	5.484G	4	5.268G
5	5.493G	6	5.636G	7	5.631G	8	5.693G
9	5.284G	10	5.413G	11	5.451G	12	5.706G
13	5.580G	14	5.382G	15	5.683G	16	5.344G
17	5.712G	18	5.288G	19	5.355G	20	5.361G
21	5.460G	22	5.305G	23	5.584G	24	5.594G
25	5.336G	26	5.358G	27	5.633G	28	5.335G
29	5.696G	30	5.386G	31	5.267G	32	5.517G
33	5.289G	34	5.489G	35	5.313G	36	5.568G
37	5.271G	38	5.514G	39	5.605G	40	5.511G
41	5.473G	42	5.270G	43	5.446G	44	5.626G
45	5.596G	46	5.378G	47	5.718G	48	5.582G
49	5.505G	50	5.297G	51	5.573G	52	5.672G
53	5.603G	54	5.639G	55	5.640G	56	5.346G
57	5.688G	58	5.678G	59	5.258G	60	5.657G
61	5.668G	62	5.512G	63	5.450G	64	5.254G
65	5.327G	66	5.308G	67	5.320G	68	5.434G
69	5.454G	70	5.495G	71	5.326G	72	5.457G
73	5.458G	74	5.577G	75	5.667G	76	5.622G
77	5.647G	78	5.274G	79	5.364G	80	5.628G
81	5.585G	82	5.620G	83	5.250G	84	5.609G
85	5.474G	86	5.420G	87	5.390G	88	5.638G
89	5.311G	90	5.463G	91	5.713G	92	5.412G
93	5.499G	94	5.306G	95	5.348G	96	5.279G
97	5.572G	98	5.559G	99	5.275G	100	5.680G

Hopping Frequency Sequence Name: HOP_FREQ_SEQ_30							
SEQ#	Frequency (Hz)	SEQ#	Frequency (Hz)	SEQ#	Frequency (Hz)	SEQ#	Frequency (Hz)
1	5.673G	2	5.315G	3	5.496G	4	5.668G
5	5.371G	6	5.565G	7	5.279G	8	5.577G
9	5.487G	10	5.664G	11	5.641G	12	5.649G
13	5.386G	14	5.545G	15	5.687G	16	5.393G
17	5.455G	18	5.467G	19	5.480G	20	5.642G
21	5.362G	22	5.602G	23	5.704G	24	5.499G
25	5.260G	26	5.591G	27	5.357G	28	5.605G
29	5.459G	30	5.403G	31	5.328G	32	5.586G
33	5.651G	34	5.520G	35	5.684G	36	5.384G
37	5.677G	38	5.601G	39	5.259G	40	5.251G
41	5.502G	42	5.432G	43	5.346G	44	5.648G
45	5.353G	46	5.612G	47	5.283G	48	5.718G
49	5.321G	50	5.349G	51	5.369G	52	5.627G
53	5.524G	54	5.708G	55	5.381G	56	5.274G
57	5.544G	58	5.409G	59	5.611G	60	5.380G
61	5.580G	62	5.498G	63	5.468G	64	5.257G
65	5.584G	66	5.266G	67	5.509G	68	5.629G
69	5.305G	70	5.324G	71	5.395G	72	5.676G
73	5.533G	74	5.688G	75	5.449G	76	5.388G
77	5.703G	78	5.603G	79	5.262G	80	5.686G
81	5.394G	82	5.661G	83	5.450G	84	5.342G
85	5.355G	86	5.483G	87	5.540G	88	5.538G
89	5.401G	90	5.276G	91	5.526G	92	5.400G
93	5.457G	94	5.654G	95	5.559G	96	5.377G
97	5.513G	98	5.678G	99	5.549G	100	5.301G