

WMI 2 (wireless mobile interface) User manual



Valid for Valeo Peiker product IDs:

WMI2-W167	2609-090-206-51 (trucks basic)
WMI2-W205	2609-090-306-51 (W205)
WMI2-W205-M1	2609-090-356-51 (W205 w/o)
WMI2-W167-M1	2609-090-406-51 (W167)
WMI2-W167-M2	2609-090-456-51 (W167 w/o)
WMI2-W167-M3	2609-090-556-51 (W167 Fd)

Revision: 1.7
Date: Jun 2018

Revision History

Date	Revision	Name	Comment
13.12.2017	1.0	Uha	Initial document
15.12.2017	1.2	Uha	
19.12.2017	1.3	SSa	Update serial numbers
19.12.2017	1.4	SSa	Update point 3 & 4
10.01.2018	1.5	sho	Update chapter 4.4 (distance from 20cm to 5cm), Insert FCC Statements
15.01.2018	1.6	Uha	Updates 2.3.1
06.06.2018	1.7	Uha	Updates 2.9 Device detection mode
11.06.2018	1.8	Uha	Updates 4.5 Further Notes

Inhalt

1. Introduction	4
1.1 Scope	4
1.2 Audience	4
1.3 Contact information, Support	4
2. Product Overview	5
2.1 Product Variants	5
2.2 Technologies	5
2.3 Supported Technology/Frequency Bands	5
2.4 Features	7
2.5 Equipment list:	10
2.6 Technical Setup	11
2.7 Computer Setup	12
2.8 Operating Modes	18
2.9 Operational Modes Device Detection – Qi	20
3. Safety Recommendations according to EN62368-1	21
4. RED / FCC / IC Regulatory Notices	22
4.1 Modifications	22
4.2 Interference	22
4.3 FCC Class B Digital Device	23
4.4 OEM Responsibilities	24
4.5 Further Notes	24

1. INTRODUCTION

1.1 SCOPE

This document gives an overview about electrical, mechanical and functional details of the Valeo peiker WMI 2 wireless charging modules.

1.2 AUDIENCE

Information to integrate the module in some other applications.

1.3 CONTACT INFORMATION, SUPPORT

peiker acustic GmbH
Max-Planck Street 32
D-61381 Friedrichsdorf / Ts.
Germany

<http://www.peiker.de>
info@peiker.de

2. PRODUCT OVERVIEW

2.1 PRODUCT VARIANTS

The WMI 2 module family consists of six variants:

Model-name	Valeo Peiker product #	Module configuration
WMI2-W167	2609-090-206-51	DAG trucks basic, with couple function
WMI2-W205	2609-090-306-51	DAG W205, with couple function
WMI2-W205-M1	2609-090-356-51	DAG W205, without couple function
WMI2-W167-M1	2609-090-406-51	DAG W167, with couple function
WMI2-W167-M2	2609-090-456-51	DAG W167, without couple function
WMI2-W167-M3	2609-090-556-51	DAG W167, fond variant, without couple function

2.2 TECHNOLOGIES

- Wireless charging equal to Qi Standard
- Connecting to device via NFC
- Proximity sensor description
- The device is detected by a ping algorithm via NFC

2.3 SUPPORTED TECHNOLOGY/FREQUENCY BANDS

2.3.1 Frequencies

NFC	13,56 MHz
Magnetic, modulated, according Qi Standard 1.0	125 kHz
<ul style="list-style-type: none"> ○ Downlink (from cell-phone/test receiver to WMI) <ul style="list-style-type: none"> ▪ the receiver is using load modulation of 125kHz modulated with 2kHz to send information to the WMI. ○ Uplink (from WMI to cell phone/test receiver) <ul style="list-style-type: none"> ▪ The WMI is using frequency modulation of the 125kHz to send information to the receiver. ○ Concerning wireless charging there is no other communication channel. 	

2.3.2 Data Rates

- CAN:
 - 250kBaud
 - 500kBaud

- NFC:
 - Modulated 115kBaud
 - Modulated 230kBaud
 - Modulated 440kBaud

2.3.3 Interfaces, customizable

- CAN
 - SPI (internal)
- Contact information, Support

2.3.4 Power level

- Charging mode
 - Max power consumption 9,25 Watts each coil
 - The device charge the mobile device with a power of 5 Watts
 - The transfer system includes 3 coils. This includes charging systems that have three coils and clients that are able to detect and allow coupling only between individual pairs of coils
 - Only one coil is active
- Ping mode
 - Max power consumption 0,25 Watts

2.3.5 Data Rates

- CAN:
 - 250kBaud
 - 500kBaud
- NFC:
 - Modulated 115kBaud
 - Modulated 230kBaud
 - Modulated 440kBaud

2.3.6 Dimension and Weight

- Dimensions: 160mm x 95mm x 27mm
- Weight < 395 grams

2.3.7 Application

- Only vehicular Environment
- The system is installed only in vehicles

2.3.8 Power

- Nominal voltage: 12V
- Max. current consumption: 0,8A
- Operating Voltage Range: 8V – 16V

2.4 FEATURES

2.4.1 FBS (exchange of relevant security information)

2.4.2 Charging

2.4.3 Couple Function, passiv only

- Powerful application processor from NXP may contain and run complete application software and CAN-software

2.4.4 Supply Voltage

Absolute minimum/maximum supply voltages	8V – 16V
Nominal supply voltage	12V
Recommended supply voltage	12V
Voltage drop @ GSM power burst (33dBm)	< 100mV

2.4.5 Power Consumption

$$T_A = +25^{\circ}\text{C}, P = 9,25\text{W}$$

2.4.6 Environmental Specification

2.4.7 Temperature Range

Range		
Operating temp. range	-20°C ... +60°C	Wireless Charging
Extended operating temp. range	-20°C ... +80°C	Operational CAN communication
Storage temp. range	-40°C ... +85°C	

2.4.8 Connectors, external interfaces

The WMI is connected with a permanent 12V and the CAN bus, various control signals from the CAN bus control the WMI and thus bring it into different working modes. In terms of driving readiness, the WMI represents an interface between the head unit (Can with 250kbaud) and a standard mobile phone from the driver of the vehicle. To support NFC telematics functions including identification and data transmission to the vehicle head unit, for example for data exchange with NFC vCards.

To support these functions, there is a coupling antenna in WMI that fulfills the following functions:

- Interface to the GSM mobile phone via the coupling antenna
- Interface to the NFC enabled mobile phone via the internal NFC antenna
- Interface to the vehicle antenna via the GSM plug connection

2.4.9 NFC vs. Charging

While entering the vehicle and putting down the mobile on to the WMI the mobile will initiate to the WMI (start of system), while transferring some CAN commands from the car to the WMI.

During the misalignment of the NFC-antenna, no specific NFC-Commands will be send. Once activated, the WMI tries to detect any device, if an object was placed on the surface. After a succesful detection of a Qi device, the system switch to Qi-detection-mode.

If the detection-mode has found a mobile with Qi-standard charging possibility on the WMI, the power contract is established and a charging process will start. If the mobile is removed during charging from the WMI, charging process is stopped immediately.

The WMI was designed following the Qi standard to charge mobiles prepared for Qi-charging. Current versions of the WMI do not fulfill the whole Qi-standard, therefore no Qi Logo is declared on the WMI and no Qi-certification exists.

2.4.10 Module Pin-out

Table 1 Module Pin-out

MWCT1014S		Signal name (used in the schematic)	Description
Port / Pin	Selected function		
PTB4 / 28	PTB4	μC2NFC-DWL-REQ	Active state: High level After a reset the NFC controller NCF3340 starts the download mode sequence. Passive state: Low level After reset no download sequence will be started by the NFC controller
PTD10 / 36	PTD10	LED-ON-FEHLER	Active state: High level The LED on the Debug PCB is switched on Passive state: Low level The LED on the Debug PCB is switched off
PTD11 / 35	PTD11	LED-ON-LADEN	Active state: High level The LED on the Debug PCB is switched on Passive state: Low level The LED on the Debug PCB is switched off

MWCT1014S		Signal name (used in the schematic)	Description
Port / Pin	Selected function		
PTE3 / 18	PTE3	μ C2NFC-ANT-CTRL	Active state: High level The RF input of the NCF controller NFC3340 (IC16) is connected to the external NFC antenna Passive state: Low level The RF input of the NCF controller NFC3340 (IC16) is connected to the internal NFC antenna
PTA14 / 88	PTA14	Capsensor2 μ C-EN	Active state: High level A change in capacitance on the sensing plates is detected. Passive state: Low level
PTE14 / 17	PTE14	SW-MODE	Default state: High level Alternative state: Low level

Note: Pins should be grounded when not used in design.

2.5 EQUIPMENT LIST:

Wireless Charger



USB Can Adapte



Chargeable Wireless Medium NXP LDO 1500 Test Receiver or AVID Test Receiver

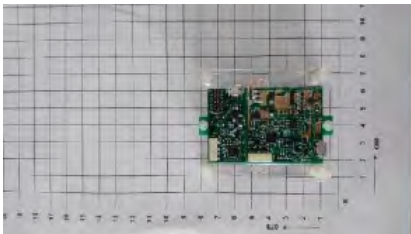

Voltmeter & Power Supply



System Harness

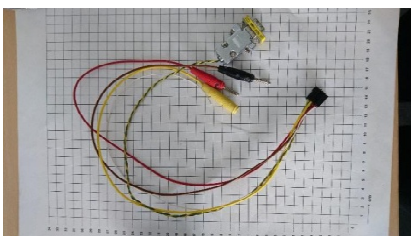

2.6 TECHNICAL SETUP

Pre-Caution:

Before testing the unit make sure that the power supply system doesn't exceed a voltage over 12V to avoid short-circuit.



Connect the wireless charger with the power supply system by using the red and black cables (the yellow cable is irrelevant).

Connect the wireless charger with the USB Can adapter via the green/yellow cable.

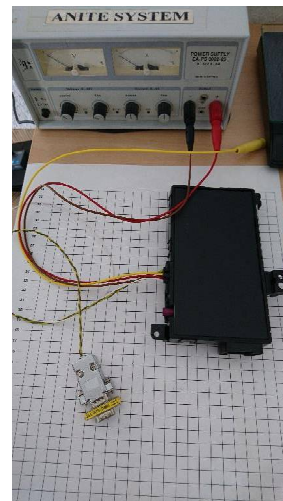

Connect the USB Can adapter with a computer. Turn on the power supply system.

Note: The LEDs of the CAN-Adapter are going on and off several times. This process is uncritical

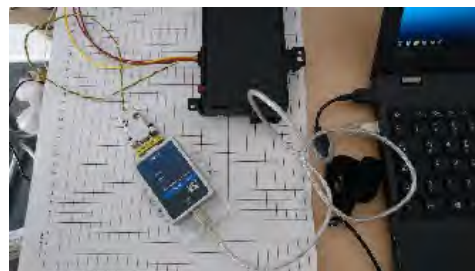

2.7 COMPUTER SETUP

Note: Ideal is the use of a Windows 7 as 64-bit system

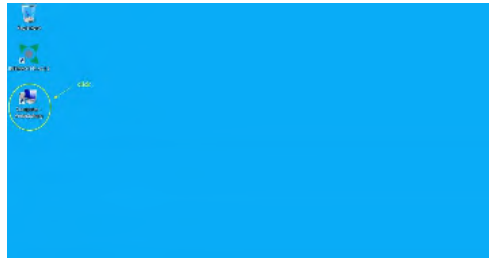

Open the Computer >> Connection

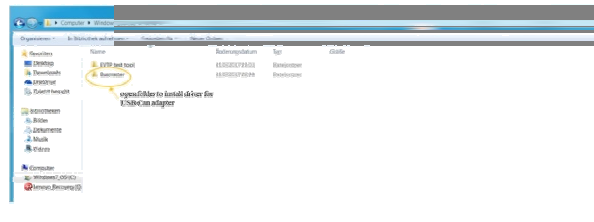

Open the Windows7_OS hard drive

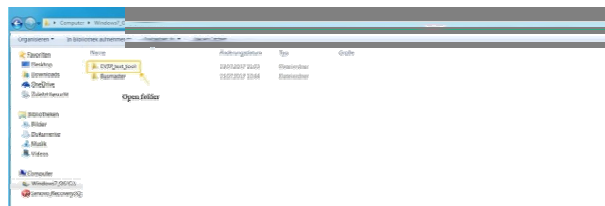

Open the WMI folder



Install Busmaster driver
Go back into *WMI* and open the *EVTP_test_tool* folder

teraterm	11.07.2017 13:08	Dateiordner	
USBCAN-Adapter	11.07.2017 13:08	Dateiordner	
YAT_2.0_Gamma_2_Version_1.99.52_x64_(64-b...	11.07.2017 13:08	Dateiordner	
EVTP über CAN - Einrichtung und Betrieb	28.11.2016 14:05	Microsoft Word-Dok...	103 KB
EvtProxy	06.04.2017 11:58	Anwendung	179 KB
EvtProxyConfigWMI	28.04.2017 12:09	XML-Dokument	1 KB
msocr100.dll	11.06.2011 04:47	Anwendungserweite...	7.470 KB
setup_com0com_W7_x64_signed	19.09.2016 12:28	Anwendung	290 KB
StartEvtProxyWMI	14.10.2016 15:29	Windows-Batchdatei	1 KB
StartUartCanProxy_Inbetriebnahme	08.03.2017 12:04	Windows-Batchdatei	1 KB
StartUartCanProxy_WMI_Cars	15.11.2016 14:16	Windows-Batchdatei	1 KB
StartUartCanProxy_WMI_Trucks	15.11.2016 14:16	Windows-Batchdatei	1 KB
UartCanProxy	<9.06.2017 15:37	Anwendung	617 KB
UartCanProxy.exe_old	22.05.2017 16:10	EXE_OLD-Datei	617 KB
UartCanProxyConfig_Inbetriebnahme	08.03.2017 12:03	XML-Dokument	1 KB
UartCanProxyConfig_WMI_Cars	15.11.2016 14:20	XML-Dokument	1 KB
UartCanProxyConfig_WMI_Trucks	15.11.2016 14:04	XML-Dokument	1 KB
vs_can_api.dll	03.02.2014 15:37	Anwendungserweite...	116 KB
vs_can_search	11.12.2008 18:01	Anwendung	56 KB
WMI_EVTP_command_set_020617	08.06.2017 08:08	Adobe Acrobat Doc...	591 KB
WMI_EVTP_Test.yst	20.06.2017 10:17	YAT-Datei	23 KB
YAT_2.0_Gamma_2_Version_1.99.52_x64_(64 b...	28.11.2016 07:49	ZIP-komprimierter D...	7.813 KB

generate connection to desktop

Generate connection to desktop

Note for *setup_com0com_W7_x64_signed*: Please install the virtual comport driver only for CNCA0 and CNCB0 for Win 7 32-bit system. A driver can be found in the internet

Note for *StartUart CanProxy_WMI_Cars*: Depending on the device (W167 (trucks), W167-M1 (cars), 205 (cars) etc...) please use either the cars or the truck files

Note for *UartCanProxyConfigWMI_Cars*: Please use the newest version

teraterm	11.07.2017 13:08	Dateiordner	
USBCAN-Adapter	11.07.2017 13:08	Dateiordner	
YAT_2.0_Gamma_2_Version_1.99.52_x64_(64-b...	11.07.2017 13:08	Dateiordner	
EVTP über CAN - Einrichtung und Betrieb	28.11.2016 14:05	Microsoft Word-Dok...	103 KB
EvtProxy	06.04.2017 11:58	Anwendung	179 KB
EvtProxyConfigWMI	28.04.2017 12:09	XML-Dokument	1 KB
msocr100.dll	11.06.2011 04:47	Anwendungserweite...	7.470 KB
setup_com0com_W7_x64_signed	19.09.2016 12:28	Anwendung	290 KB
StartEvtProxyWMI	14.10.2016 15:29	Windows-Batchdatei	1 KB
StartUartCanProxy_Inbetriebnahme	08.03.2017 12:04	Windows-Batchdatei	1 KB
StartUartCanProxy_WMI_Cars	15.11.2016 14:16	Windows-Batchdatei	1 KB
StartUartCanProxy_WMI_Trucks	15.11.2016 14:16	Windows-Batchdatei	1 KB
UartCanProxy	20.06.2017 15:37	Anwendung	617 KB
UartCanProxy.exe_old	22.05.2017 16:10	EXE_OLD-Datei	617 KB
UartCanProxyConfig_Inbetriebnahme	08.03.2017 12:03	XML-Dokument	1 KB
UartCanProxyConfig_WMI_Cars	15.11.2016 14:20	XML-Dokument	1 KB
UartCanProxyConfig_WMI_Trucks	15.11.2016 14:04	XML-Dokument	1 KB
vs_can_api.dll	03.02.2014 15:37	Anwendungserweite...	116 KB
vs_can_search	11.12.2008 18:01	Anwendung	56 KB
WMI_EVTP_command_set_020617	08.06.2017 08:08	Adobe Acrobat Doc...	591 KB
WMI_EVTP_Test.yst	20.06.2017 10:17	YAT-Datei	23 KB
YAT_2.0_Gamma_2_Version_1.99.52_x64_(64 b...	28.11.2016 07:49	ZIP-komprimierter D...	7.813 KB

open folder

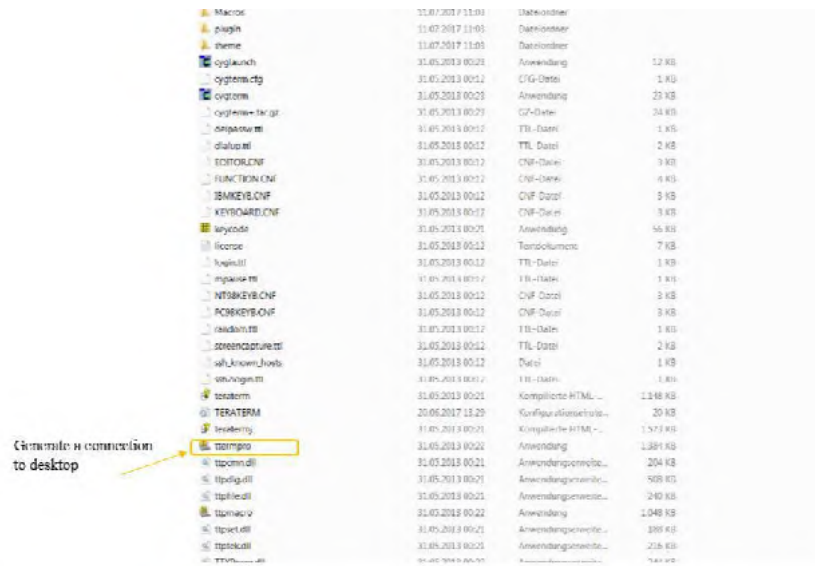

Open folder *teraterm*

Generate a connection to desktop

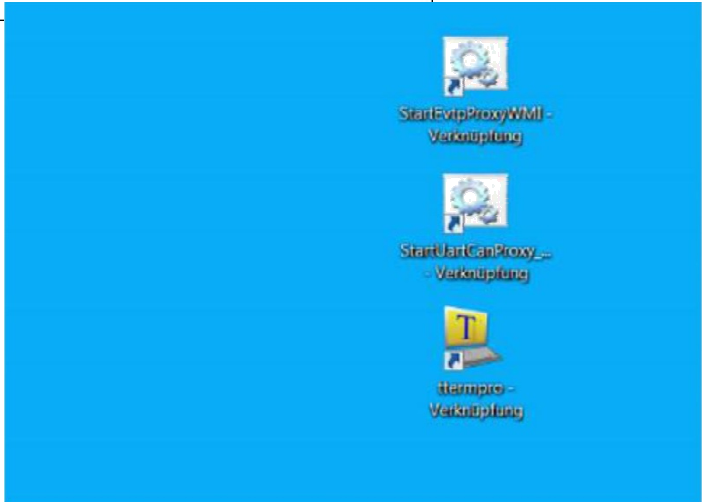

Please start with the *StartEvtProxy WMI* first

Depending on the device, please start with *StartUartProxy* as 2nd

Please start *ttermpro* as last

All Programs stay unclosed

Open the tools successively in following order:
StartEvtProxyWMI

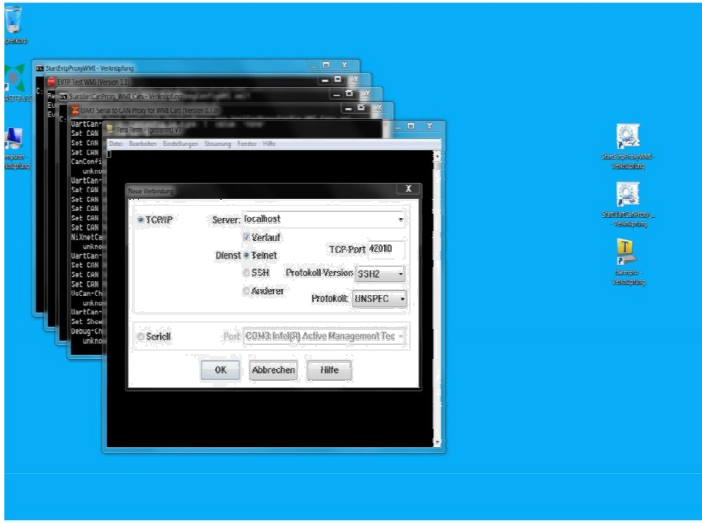

StartUartCanProxy *ttermpro* and press *OK* afterwards

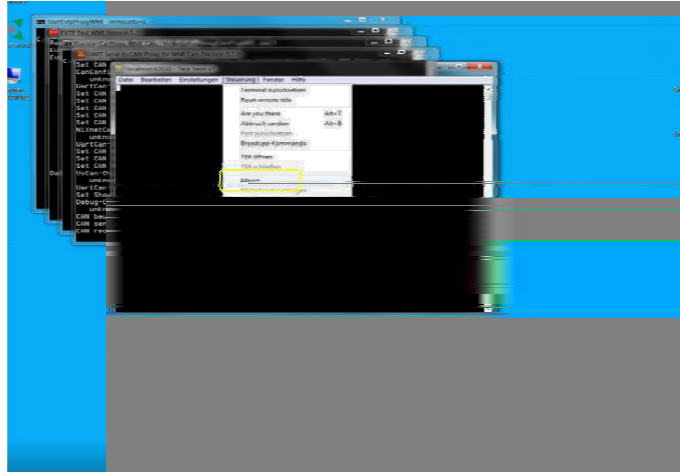

Click on navigation and afterwards open the macro menu

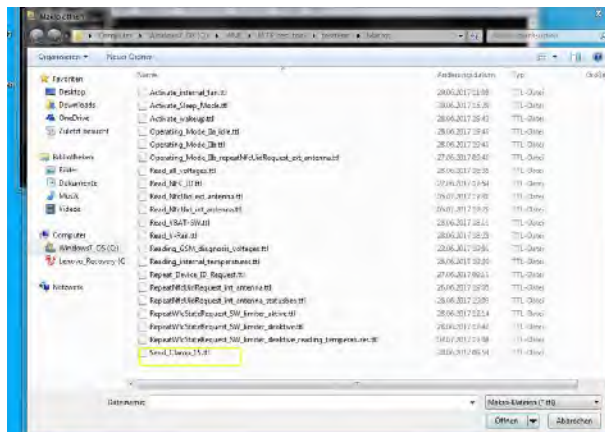

Open *Send_clamp_15ttl*

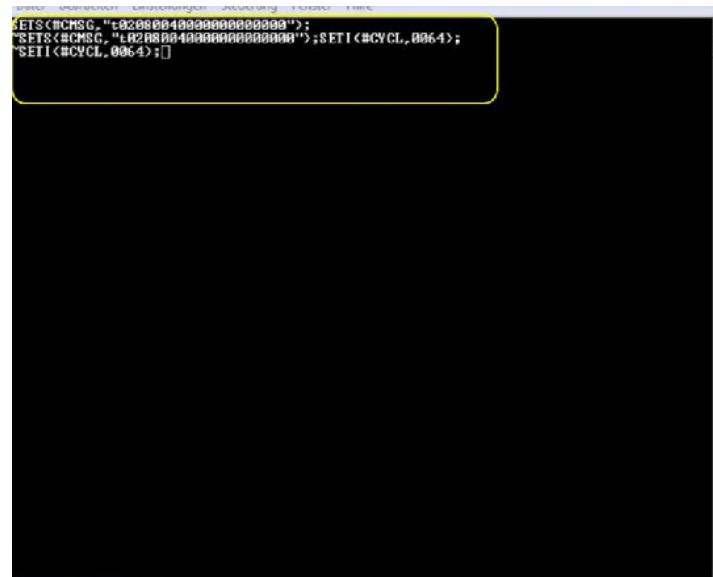

Attention: wait until the third line appears

For NFC use the following macros:

Internal: *Read_NFCUid_int_Antenna.ttl*
 External: *Read_NFCUid_ext_Antenna.ttl*

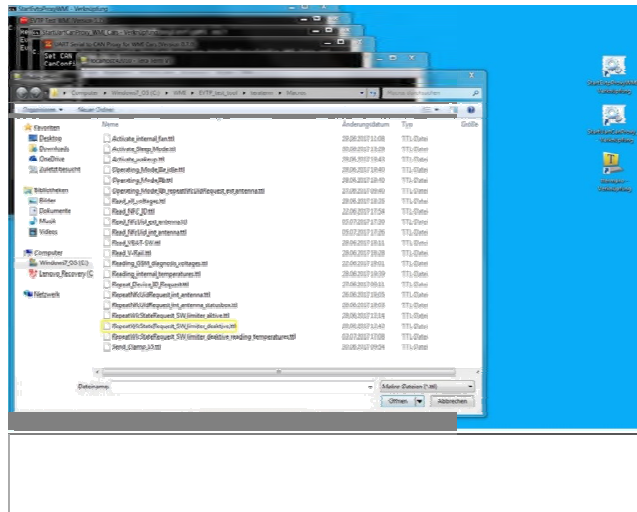

The process for **an internal** NFC-antenna is as follows:

1. activate
2. "Send_Clamp_15.ttl"
3. "Read_NFCUid_int_Antenna.ttl"
4. deactivate
5. "Activate_Sleep_Mode.ttl"

The process for **an external** NFC-antenna is as follows:

1. activate
2. "Send_Clamp_15.ttl"
3. "Read_NFCUid_ext_Antenna.ttl"
4. Deactivate
5. "Activate_Sleep_Mode.ttl"

Attention: You can ignore the error message "Wireless charging is off! If the error message "No EVTP response!" appears, it means that the device is not responding

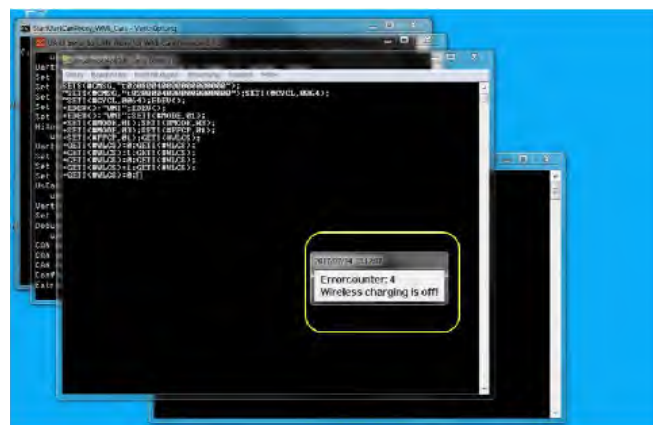

The process for **wireless charging** is as follows:

1. activate
2. "Send_Clamp_15.ttl"
3. " RepeatWlcStateRequest_SW_limiter_deaktive.ttl"
4. Now place the Chargeable Wireless Medium onto the centre of the Wireless Charger
5. During charging a light indicates a successful functional capability.
6. This could take a few moments.
8. During the test the LED should permanently glow
9. Deactivate
10. "Activate_Sleep_Mode.ttl"

Note: a rubber mat should be placed between the wireless charger and the wireless charging receiver or the NFC-tag

A light indicates a successful functional capability; this could take a few moments.

Click on navigation, open the Macro Display, and click on *Finish*

Click on navigation and open macro menu. Click on *Activate_Sleep_Mode.ttl*. You can now close all Windows and remove the Wireless Charger

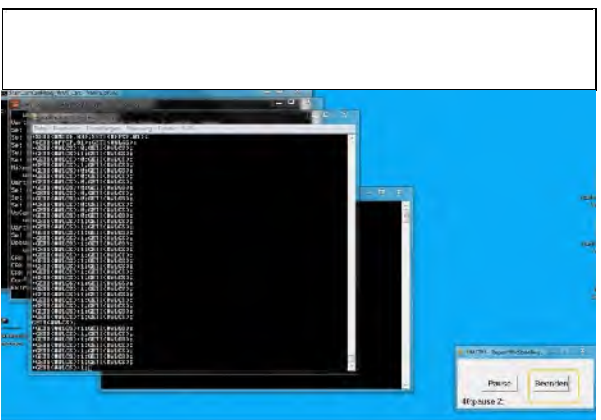
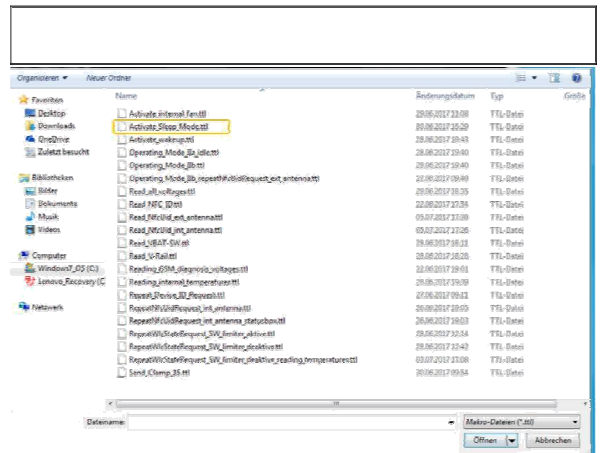
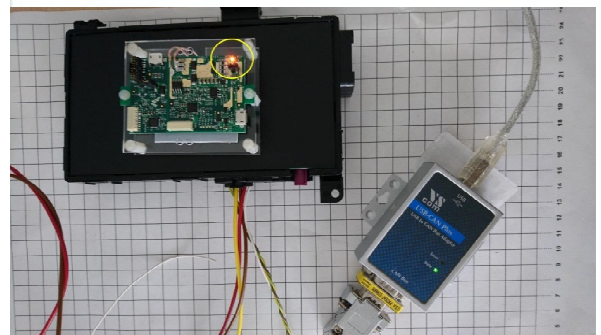
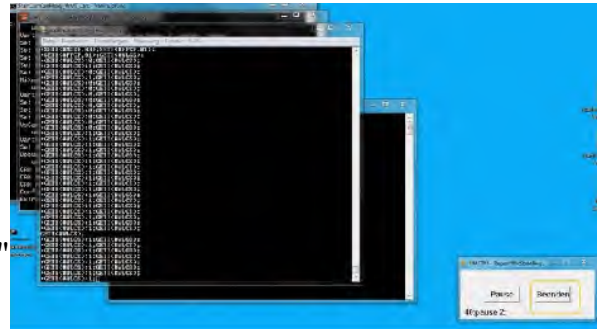

2.8 OPERATING MODES

The system controller of the SBC manages register configuration and controls the internal functions. The system controller is a state machine. The SBC operating modes and the state transitions are shown in Figure 2.8-1. A detailed hardware characterization of the SBC operating modes by functional block is listed in the following Table 2.8-1

Block	Operating mode							
	Off	Forced Normal	Standby	Normal	Sleep	Reset	Overload	FSP
V1	off	on	on	on	off	on	off	on
V2/VEXT	off	on	V2C ^[1]	V2C ^[1]	V2C ^[1]	V2C ^[1]	off	V2C ^[1]
HVION ^[2]	off	off	HVION control register; low-side drivers disabled ^[3]	HVION control register ^[3]	HVION control register; low-side drivers disabled ^[3]	HVION control register; low-side drivers disabled ^[3]	fail-safe state ^[4]	HVION control register; low-side drivers disabled ^[3]
SMPS	off	on (default voltage)	SMPS control register ^[5]	SMPS control register ^[5]	SMPS control register ^[5]	on	off	on
CAN	CAN Off	CAN Active/ CAN Listen-only	CAN Offline/ CAN Offline Bias/ CAN Listen-only ^[6]	CAN Active/ CAN Offline/ CAN Offline Bias/ CAN Listen-only/ CAN Off if CAN shut down condition true ^[6]	CAN Offline/ CAN Offline Bias	CAN Offline/ CAN Offline Bias	CAN Off	CAN Offline/ CAN Offline Bias
LIN1/ LIN2 ^[7]	LIN Off	LIN Active	LIN Offline/ LIN Listen-only ^[8]	LIN Active/ LIN Listen-only/ LIN Offline ^[8]	LIN Offline	LIN Offline	LIN Off	LIN Offline
EN	off	off	ENC/ENDC ^[9]	ENC/ENDC ^[9]	ENC/ ENDC ^{[9][10]}	ENC/ ENDC ^[9]	off	ENC/ ENDC ^[9]
RSTN	LOW	HIGH	HIGH	HIGH	LOW	LOW	LOW	LOW
LIMP	floating	floating	LHC ^[11]	LHC ^[11]	LHC ^[11]	LHC ^[11]	LHC = 1	LHC = 1
RXDC	pull-up to V1	CAN status	pull-up to V1; LOW if CAN wake-up; CAN status if CMC = 11	CAN status if CMC = 01/10; otherwise same as Standby	pull-up to V1	pull-up to V1/LOW if CAN wake-up	pull-up to V1	pull-up to V1
RXDL1/ RXDL2 ^[7]	pull-up to V1	LIN status	pull-up to V1; LOW if LIN wake-up; LIN status if LMC = 11	LIN status if LMC = 01/10; otherwise same as Standby	pull-up to V1	pull-up to V1/LOW if LIN wake-up	pull-up to V1	pull-up to V1
SPI	disabled	limited access	active	active	disabled	disabled	disabled	disabled
Watchdog	off	off	WMC ^[12]	WMC ^[12]	WMC ^[12]	off	off	off

- [1.] Determined by the setting of bits V2C in the regulator control register
- [2.] HVIO availability depends on the device variant
- [3.] Determined by the settings in the relevant HVIO control register
- [4.] See data sheet of the UJA1131HW/3V3. Determined by the settings in the SMPS control register
- [5.] Determined by the setting of bits CMC in the CAN control register
- [6.] Availability of LIN2 depends on the device variant
- [7.] Determined by the setting of bits LMCn in the LIN control register
- [8.] Determined by the settings of bits ENC and ENDC in the fail-safe control register
- [9.] Since V1 is off, EN can only operate as open-drain output in Sleep mode
- [10.] Determined by the setting of bit LHC in the Fail-safe control register
- [11.] Determined by the setting of bits WMC in the Watchdog control register

Table 2.8-1: Hardware characterization by functional block

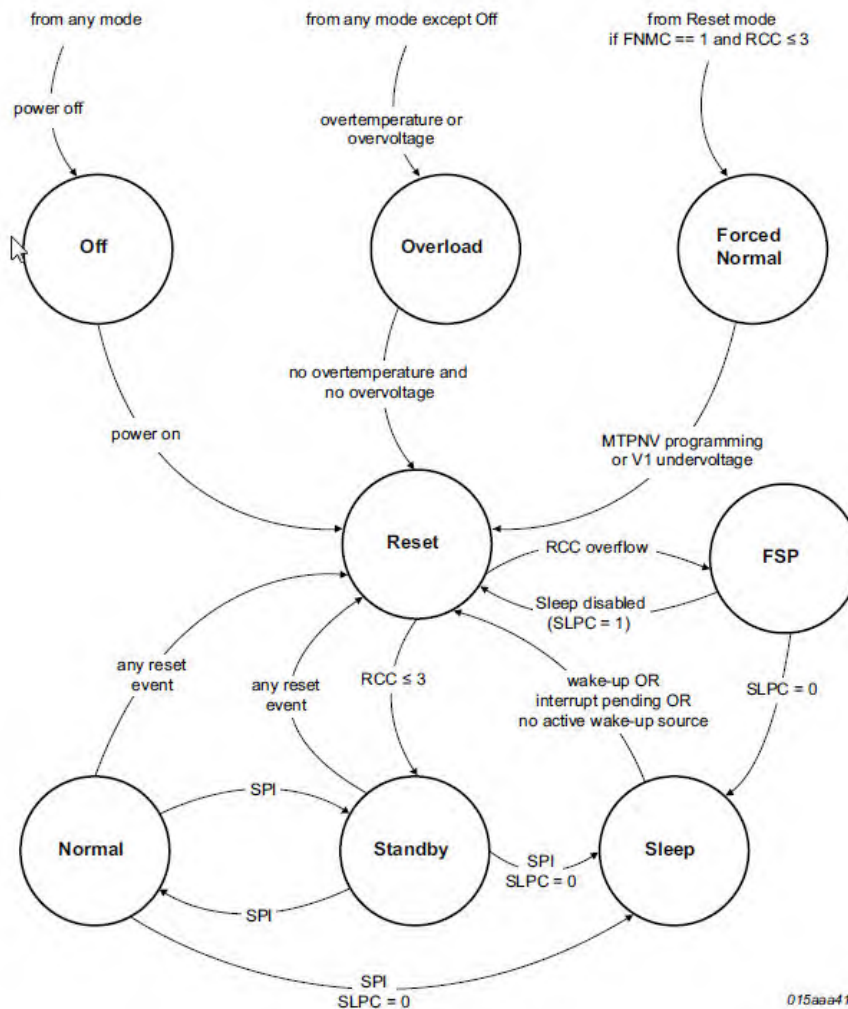

Figure 2.8-1: Operating modes of the System Basis Chip UJA1131HW/3V3

Via SPI2 interface the MWCT1014S is able to sent commands to the SBC so that the SBC can change the operating mode. The operating mode is selected via bits MC in the Mode Control register, see Table 2.8-2.

SPI address of the Mode Control register: **0x01**

Bit	Symbol	Access	Value	Description
7:3	reserved	R	-	
2:0	MC	RW	001	Sleep mode
			100	Standby mode
			111	Normal mode

Table 2.8-2: Mode Control register

The SBC operating modes are described in the data sheet of the UJA1131HW/3V3, **Fehler! Verweisquelle konnte nicht gefunden werden.**, section 7.1.1, page 12.

2.9 OPERATIONAL MODES DEVICE DETECTION – Qi

After putting the mobile on the WMI surface, the WMI will start up exchanging some CAN commands from the car .

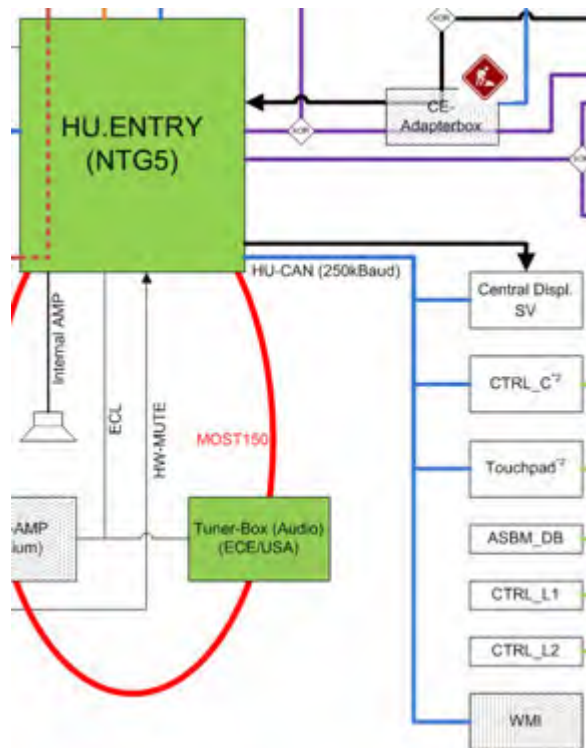

After initial start the WMI tries to detect via NFC, if an object was placed on the surface (at this time the process does not send out NFC-Commands)

When the device detection was successful, the system switch to Qi-detection-mode. If the Qi-detection-mode has found a mobile (acc. Qi-standard) then charging process will start. The WMI was designed following the Qi standard to charge mobiles prepared for Qi-charging. Because the WMI2 does not fulfill the whole Qi-standard, therefore no Qi Logo is placed on the WMI and no Qi-certification has been processed.

If you remove the mobile during charging from the WMI, charging process is stopped immediately.

3. SAFETY RECOMMENDATIONS ACCORDING TO EN62368-1

The WMI2-W167, WMI2-W167-M1, WMI2-W167-M2, WMI2-W167-M3, WMI2-W205, WMI2-W205-M1 devices must be supplied by a limited power source according to EN 62368-1.

4. RED / FCC / IC REGULATORY NOTICES

4.1 MODIFICATIONS

WARNING: peiker acustic GmbH has not approved any changes or modifications to the V1222-0 device by the user. Any changes or modifications could void the user's authority to operate the equipment.

AVERTISSEMENT: peiker acustic GmbH n'a approuvé aucun changement ou modification de l'appareil V1222-0 par l'utilisateur. Tout changement ou modification peut annuler l'autorité de l'utilisateur à utiliser l'équipement.

4.2 INTERFERENCE

This devices WMI2-W167, WMI2-W167-M1, WMI2-W167-M2, WMI2-W167-M3, WMI2-W205, WMI2-W205-M1 complies with Part 15 of the FCC Rules and with Industry Canada licence-exempt RSS standard(s).

Operation is subject to the following two conditions:

- (1) this device may not cause harmful interference, and
- (2) this device must accept any interference received, including interference that may cause undesired operation.

Le présent appareil WMI2-W167, WMI2-W167-M1, WMI2-W167-M2, WMI2-W167-M3, WMI2-W205, WMI2-W205-M1 est conforme aux CNR d'Industrie Canada applicables aux appareils radio exempts de licence. L'exploitation est autorisée aux deux conditions suivantes:

- (1) l'appareil ne doit pas produire de brouillage, et
- (2) l'appareil doit accepter tout brouillage radioélectrique subi, même si le brouillage est susceptible d'en compromettre le fonctionnement.

4.3 FCC CLASS B DIGITAL DEVICE

The WMI2-W167, WMI2-W167-M1, WMI2-W167-M2, WMI2-W167-M3, WMI2-W205, WMI2-W205-M1 has been tested and found to comply with the limits for a Class B digital device, pursuant to part 15 of the FCC Rules. These limits are designed to provide reasonable protection against harmful interference in a residential installation. This equipment generates, uses, and can radiate radio frequency energy and, if not installed and used in accordance with the instructions, may cause harmful interference to radio communications. However, there is no guarantee that interference will not occur in a particular installation. If this equipment does cause harmful interference to radio or television reception, which can be determined by turning the equipment off and on, the user is encouraged to try to correct the interference by one or more of the following measures:

- Reorient or relocate the transmitting antenna.
- Consult the dealer or an experienced radio/TV technician for help.

Les modèles WMI2-W167, WMI2-W167-M1, WMI2-W167-M2, WMI2-W167-M3, WMI2-W205, WMI2-W205-M1 ont été testés et jugés conformes aux limites d'un appareil numérique de classe B, conformément à la partie 15 des règles de la FCC. Ces limites sont conçues pour fournir une protection raisonnable contre les interférences nuisibles dans une installation résidentielle. Cet équipement génère, utilise et peut émettre de l'énergie radiofréquence et, s'il n'est pas installé et utilisé conformément aux instructions, peut causer des interférences nuisibles aux communications radio. Cependant, il n'y a aucune garantie que des interférences ne se produiront pas dans une installation particulière. Si cet équipement cause des interférences nuisibles à la réception radio ou télévision, ce qui peut être déterminé en éteignant et en rallumant l'équipement, l'utilisateur est encouragé à essayer de corriger l'interférence par une ou plusieurs des mesures suivantes:

- Réorienter ou déplacer l'antenne d'émission.
- Consulter le revendeur ou un technicien radio / TV expérimenté pour obtenir de l'aide.

4.4 OEM RESPONSIBILITIES

Antenna / Coils

- The systems antenna(s) / coils must be installed such that 5 cm is maintained between the antenna(s) and the body of the user or nearby persons.

Power Supply

- The power supply of the host device embedding a WMI2-W167, WMI2-W167-M1, WMI2-W167-M2, WMI2-W167-M3, WMI2-W205, WMI2-W205-M1 must fulfill the following requirements:
 - o Nominal supply voltage: 12V
 - o Operating voltage range: 8V – 16V
 - o The above operating voltage range MUST never, under any circumstances (including overshoot voltage and voltage drop), be exceeded.

FCC Labeling

No additional Labeling requirements

IC Labeling

No additional Labeling requirements

4.5 FURTHER NOTES

This device is intended to be used only in vehicles (cars).

This device will be installed in the vehicles in the factory when the vehicle will be manufactured by the professional workers.

This device is not intended for resale or for 3rd parties.