**CETECOM™****CETECOM ICT Services**
consulting - testing - certification >>>**TEST REPORT**

Test report no.: 1-0438/15-01-02-B

Deutsche
Akkreditierungsstelle
D-PL-12076-01-01**Testing laboratory****CETECOM ICT Services GmbH**

Untertuerkheimer Strasse 6 – 10

66117 Saarbruecken / Germany

Phone: + 49 681 5 98 - 0

Fax: + 49 681 5 98 - 9075

Internet: <http://www.cetecom.com>e-mail: ict@cetecom.com**Accredited Testing Laboratory:**

The testing laboratory (area of testing) is accredited according to DIN EN ISO/IEC 17025 (2005) by the Deutsche Akkreditierungsstelle GmbH (DAkkS)

The accreditation is valid for the scope of testing procedures as stated in the accreditation certificate with the registration number: D-PL-12076-01-01

Applicant**peiker acustic GmbH & Co. KG**

Max-Planck Str. 28-32

61381 Friedrichsdorf / GERMANY

Phone: -/-

Fax: +49 6172-767-220

Contact: Philippe Seguret

e-mail: philippe.seguret@peiker.de

Phone: +49 6172 767- 1754

Manufacturer**peiker acustic GmbH & Co. KG**

Max-Planck Str. 28-32

61381 Friedrichsdorf / GERMANY

Test standard/s

47 CFR Part 22

Title 47 of the Code of Federal Regulations; Chapter I; Part 22 - Public mobile services

47 CFR Part 24

Title 47 of the Code of Federal Regulations; Chapter I; Part 24 - Personal communications services

RSS - 132 Issue 3

Spectrum Management and Telecommunications Radio Standards Specification - Cellular Telephone Systems Operating in the Bands 824-849 MHz and 869-894 MHz

For further applied test standards please refer to section 3 of this test report.

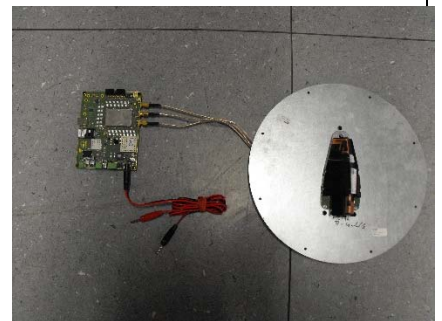
Test Item**Kind of test item:** NAD Module**Model name:** V1140-104-1**FCC ID:** QWY-V1140-104-1**Frequency:** GSM: 824.2 – 848.8 MHz, 1850.2 – 1909.8 MHz
UMTS: 826.4 – 848.6 MHz**Technology tested:** GSM GPRS & EGPRS, UMTS FDD5**Antenna:** External antenna**Power supply:** 3.8 V DC**Temperature range:** -30°C to +50°C

This test report is electronically signed and valid without handwriting signature. For verification of the electronic signatures, the public keys can be requested at the testing laboratory.

Test report authorized:Andreas Luckenbill
Lab Manager
Radio Communications & EMC**Test performed:**Tobias Wittenmeier
Testing Manager
Radio Communications & EMC

1	Table of contents	2
1	Table of contents.....	2
2	General information	4
2.1	Notes and disclaimer	4
2.2	Application details.....	4
3	Test standard/s	4
3.1	Measurement guidance.....	5
4	Test environment.....	6
5	Test item	6
5.1	General description.....	6
5.2	Additional information	6
6	Test laboratories sub-contracted	6
7	Description of the test setup.....	7
7.1	Shielded fully anechoic chamber	8
7.2	Radiated measurements > 12.75 GHz.....	9
7.3	Conducted measurements normal and extreme conditions.....	10
8	Measurement uncertainty	11
9	Sequence of testing	12
9.1	Sequence of testing radiated spurious 9 kHz to 30 MHz.....	12
9.2	Sequence of testing radiated spurious 30 MHz to 1 GHz.....	13
9.3	Sequence of testing radiated spurious 1 GHz to 12.75 GHz	14
9.4	Sequence of testing radiated spurious above 12.75 GHz	15
10	Summary of measurement results.....	16
10.1	GSM 850.....	16
10.2	PCS 1900.....	16
10.3	UMTS band V.....	17
11	RF measurements.....	18
11.1	Results GSM 850.....	18
11.1.1	RF output power	18
11.1.2	Frequency stability	24
11.1.3	Spurious emissions radiated.....	26
11.1.4	Spurious emissions conducted	30
11.1.5	Block edge compliance	36
11.1.6	Occupied bandwidth	39
11.2	Results PCS 1900.....	47
11.2.1	RF output power	47
11.2.2	Frequency stability	53
11.2.3	Spurious emissions radiated.....	55
11.2.4	Spurious emissions conducted	61
11.2.5	Block edge compliance	67
11.2.6	Occupied bandwidth	70
11.3	Results UMTS band V	78
11.3.1	RF output power	78
11.3.2	Frequency stability	82
11.3.3	Spurious emissions radiated.....	84
11.3.4	Spurious emissions conducted	87
11.3.5	Block edge compliance	91
11.3.6	Occupied bandwidth	93

12	Observations	97
Annex A	Document history	98
Annex B	Further information.....	98
Annex C	Accreditation Certificate	99

2 General information

2.1 Notes and disclaimer

The test results of this test report relate exclusively to the test item specified in this test report. CETECOM ICT Services GmbH does not assume responsibility for any conclusions and generalizations drawn from the test results with regard to other specimens or samples of the type of the equipment represented by the test item.

The test report may only be reproduced or published in full. Reproduction or publication of extracts from the report requires the prior written approval of CETECOM ICT Services GmbH.

The testing service provided by CETECOM ICT Services GmbH has been rendered under the current "General Terms and Conditions for CETECOM ICT Services GmbH".

CETECOM ICT Services GmbH will not be liable for any loss or damage resulting from false, inaccurate, inappropriate or incomplete product information provided by the customer.

Under no circumstances does the CETECOM ICT Services GmbH test report include any endorsement or warranty regarding the functionality, quality or performance of any other product or service provided.

Under no circumstances does the CETECOM ICT Services GmbH test report include or imply any product or service warranties from CETECOM ICT Services GmbH, including, without limitation, any implied warranties of merchantability, fitness for purpose, or non-infringement, all of which are expressly disclaimed by CETECOM ICT Services GmbH.

All rights and remedies regarding vendor's products and services for which CETECOM ICT Services GmbH has prepared this test report shall be provided by the party offering such products or services and not by CETECOM ICT Services GmbH.

In no case this test report can be considered as a Letter of Approval.

This test report is electronically signed and valid without handwritten signature. For verification of the electronic signatures, the public keys can be requested at the testing laboratory.

This test report replaces the test report with the number 1-0438/15-01-02-A and dated 2016-05-12-

2.2 Application details

Date of receipt of order:	2015-09-28
Date of receipt of test item:	2015-09-28
Start of test:	2015-10-02
End of test:	2015-10-28
Person(s) present during the test:	-/-

3 Test standard/s

Test standard	Date	Test standard description
47 CFR Part 22		Title 47 of the Code of Federal Regulations; Chapter I; Part 22 - Public mobile services
47 CFR Part 24		Title 47 of the Code of Federal Regulations; Chapter I; Part 24 - Personal communications services
RSS - 132 Issue 3	January 2013	Spectrum Management and Telecommunications Radio Standards Specification - Cellular Telephone Systems Operating in the Bands 824-849 MHz and 869-894 MHz
RSS - 133 Issue 6	January 2013	Spectrum Management and Telecommunications Policy - Radio Standards Specifications, 2 GHz Personal Communication Services

3.1 Measurement guidance

Guidance	Version	Description
ANSI C63.4-2014	-/-	American national standard for methods of measurement of radio-noise emissions from low-voltage electrical and electronic equipment in the range of 9 kHz to 40 GHz

7 Description of the test setup

Typically, the calibrations of the test apparatus are commissioned to and performed by an accredited calibration laboratory. The calibration intervals are determined in accordance with the DIN EN ISO/IEC 17025. In addition to the external calibrations, the laboratory executes comparison measurements with other calibrated test systems or effective verifications. Weekly chamber inspections and range calibrations are performed. Where possible, RF generating and signaling equipment as well as measuring receivers and analyzers are connected to an external high-precision 10 MHz reference (GPS-based or rubidium frequency standard).

In order to simplify the identification of the equipment used at some special tests, some items of test equipment and ancillaries can be provided with an identifier or number in the equipment list below (Lab/Item).

Agenda: Kind of Calibration

k	calibration / calibrated	EK	limited calibration
ne	not required (k, ev, izw, zw not required)	zw	cyclical maintenance (external cyclical maintenance)
ev	periodic self verification	izw	internal cyclical maintenance
Ve	long-term stability recognized	g	blocked for accredited testing
v/k!	Attention: extended calibration interval		
NK!	Attention: not calibrated	*)	next calibration ordered / currently in progress

7.1 Shielded fully anechoic chamber

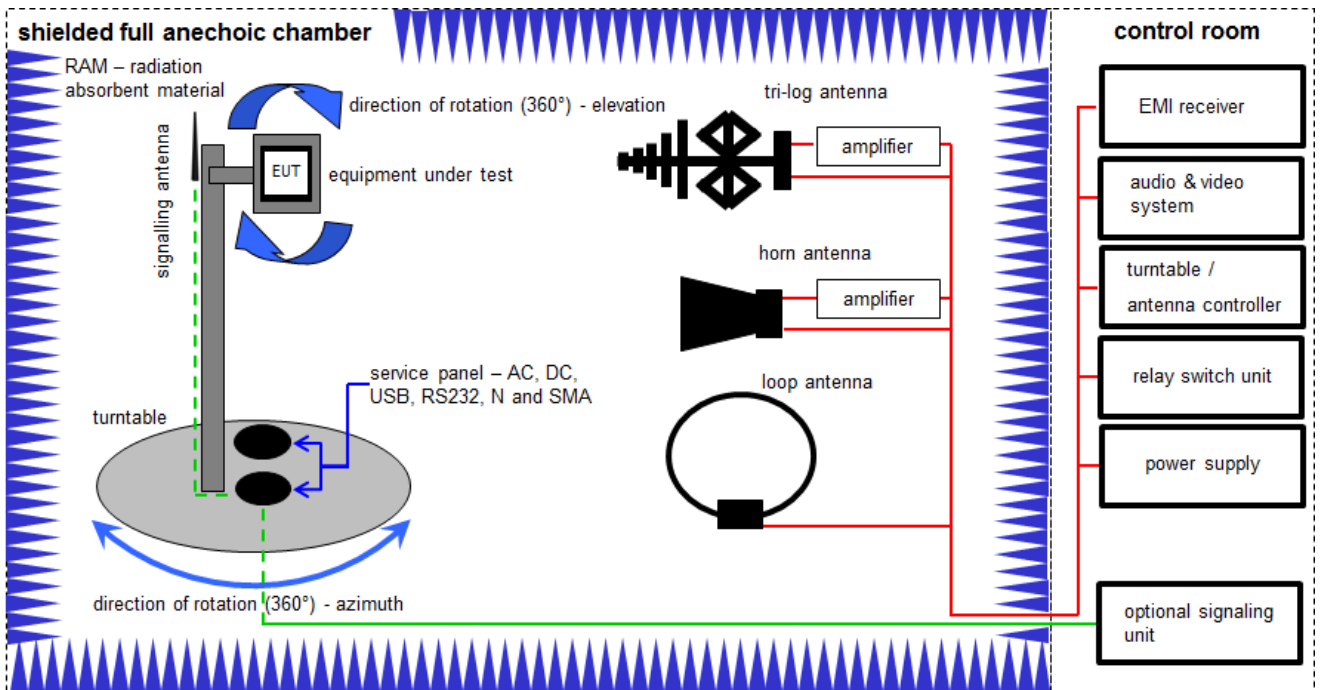

OP = AV + D - G + CA
 (OP-output power; AV-analyzer value; D-distance; G-antenna gain+amplifier gain; CA-loss signal path)

Example calculation:

OP [dBm] = -11.0 [dBm] + 47 [dB] - 8 [dB] + 5 [dB] = 33 [dBm] (2 W)

Equipment table:

No.	Lab / Item	Equipment	Type	Manufact.	Serial No.	INV. No Cetecom	Kind of Calibration	Last Calibration	Next Calibration
1	A	Power Supply 0-20V	6632A	HP	2851A01814	300000924	ne	09.11.2005	
2	A	Double-Ridged Waveguide Horn Antenna 1-18.0GHz	3115	EMCO	9709-5290	300000212	k	13.08.2015	13.08.2017
3	A	EMI Test Receiver 20Hz-26,5GHz	ESU26	R&S	100037	300003555	k	22.01.2015	22.01.2016
4	A	Highpass Filter	WHK1.1/15G-10SS	Wainwright	37	400000148	ne		
5	A	Highpass Filter	WHKX7.0/18G-8SS	Wainwright	18	300003789	ne		
6	A	TRILOG Broadband Test-Antenna 30 MHz - 3 GHz	VULB9163	Schwarzbeck	318	300003696	k	22.04.2014	22.04.2017
7	A	4U RF Switch Platform	L4491A	Agilent Technologies	MY50000032	300004510	ne		
8	A	Messrechner und Monitor	Intel Core i3 3220/3,3 GHz, Prozessor	Agilent Technologies	2V2403033A54 21	300004591	ne		
9	A	NEXIO EMV-Software	BAT EMC	EMCO	2V2403033A54 21	300004682	ne		
10	A	Active Loop Antenna 10 kHz to 30 MHz	6502	EMCO/2	8905-2342	300000256	k	24.06.2015	24.06.2017
11	A	Universal Communication Tester	CMU200	R&S	106240	300003321	vIKI!	12.06.2015	12.06.2017

7.2 Radiated measurements > 12.75 GHz

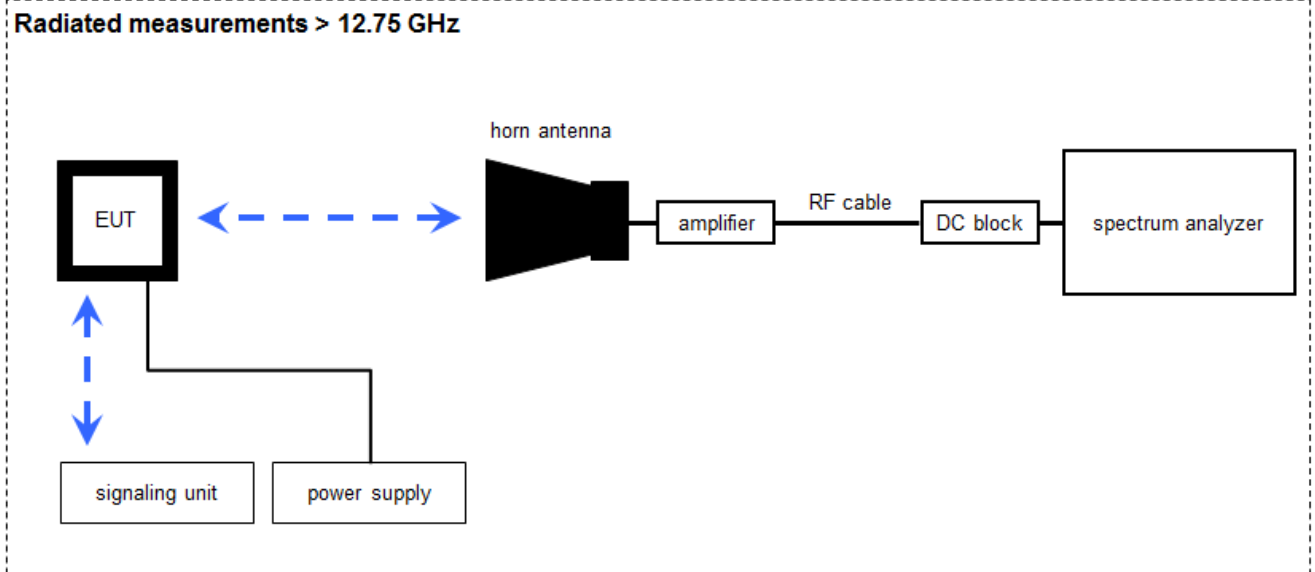

Measurement distance: horn antenna 25 cm

$$OP = AV + D - G + CA$$

(OP-radiated output power; AV-analyzer value; D-free field attenuation of measurement distance; G-antenna gain+amplifier gain; CA-loss signal path)

Example calculation:

$$OP \text{ [dBm]} = -59.0 \text{ [dBm]} + 44.0 \text{ [dB]} - 20.0 \text{ [dBi]} + 5.0 \text{ [dB]} = -30 \text{ [dBm]} \text{ (1 } \mu\text{W)}$$

Equipment table:

No.	Lab / Item	Equipment	Type	Manufact.	Serial No.	INV. No Cetecom	Kind of Calibration	Last Calibration	Next Calibration
1	A	Signal Analyzer 40 GHz	FSV40	R&S	101042	300004517	k	22.01.2015	22.01.2016
2	A	Power Supply 0-20V, 0-5A	6632B	Agilent Technologies	GB42110541	400000562	vKI!	10.01.2013	10.01.2016
3	A	Amplifier 2-40 GHz	JS32-02004000-57-5P	MITEQ	1777200	300004541	ev		
4	A	RF-Cable	ST18/SMAm/SMAm/60	Huber & Suhner	Batch no. 606844	400001181	ev		
5	A	RF-Cable	ST18/SMAm/SMAm/48	Huber & Suhner	Batch no. 600918	400001182	ev		
6	A	DC-Blocker 0.1-40 GHz	8141A	Inmet	Batch no. 600918	400001185	ev		
7	A	Std. Gain Horn Antenna 12.4 to 18.0 GHz	639	Narda	8402	300000787	k	14.08.2015	14.08.2017
8	A	Std. Gain Horn Antenna 18.0 to 26.5 GHz	638	Narda	8205	300002442	k	19.07.2015	19.07.2017
9	A	Universal Communication Tester	CMU200	R&S	106240	300003321	vKI!	12.06.2015	12.06.2017

7.3 Conducted measurements normal and extreme conditions

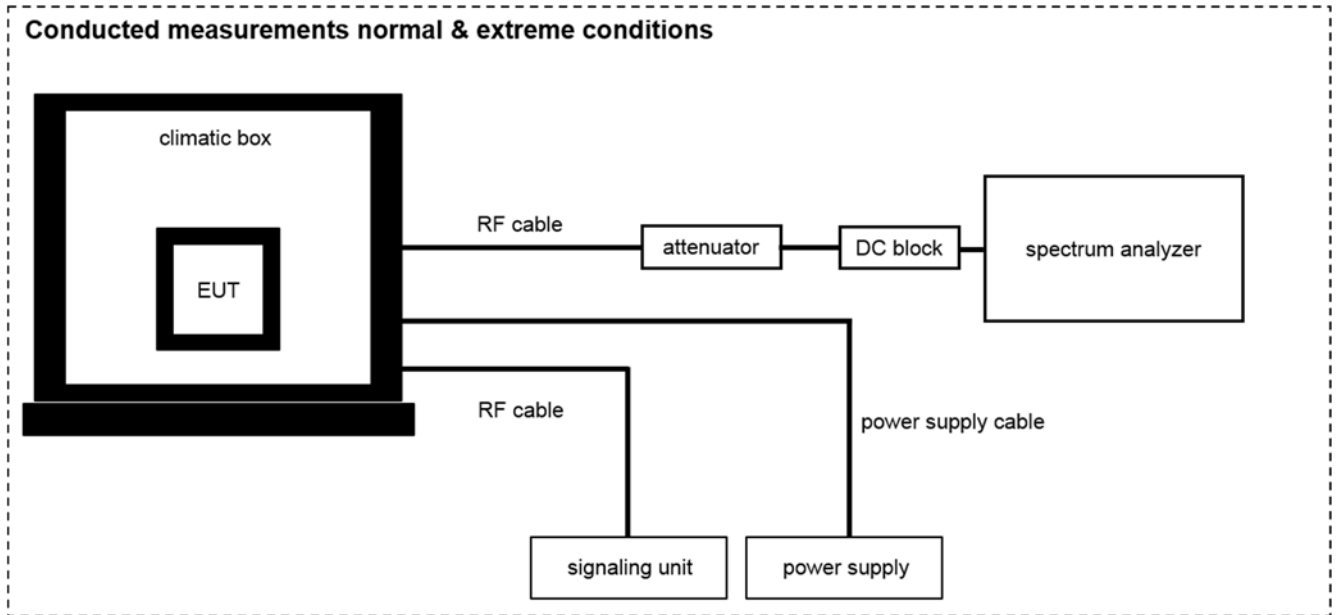

OP = AV + CA
 (OP-output power; AV-analyzer value; CA-loss signal path)

Example calculation:

OP [dBm] = 6.0 [dBm] + 11.7 [dB] = 17.7 [dBm] (58.88 mW)

Equipment table:

No.	Lab / Item	Equipment	Type	Manufact.	Serial No.	INV. No Cetecom	Kind of Calibration	Last Calibration	Next Calibration
1	A, B	Switch / Control Unit	3488A	HP	2605e08770	300001443	ne		
2	A, B	Signal Analyzer 40 GHz	FSV40	R&S	101042	300004517	k	22.01.2015	22.01.2016
3	A, B	Power Supply 0-20V; 0-5A	6632B	HP	US37478366	400000117	vIKI!	20.01.2015	20.01.2017
4	A,B	Universal Communication Tester	CMU200	R&S	106240	300003321	vIKI!	12.06.2015	12.06.2017
5	B	Temperature Test Chamber	VT 4002	Heraeus Voetsch	521/83761	300002326	Ve	26.09.2015	26.09.2017
6	A, B	RF-Cable	ST18/SMAm/SMAm/72	Huber & Suhner	Batch no. 699714	400001184	ev		
7	A, B	DC-Blocker 0.1-40 GHz	8141A	Inmet		400001185	ev		
8	A, B	Coax Attenuator 10 dB 2W 0-40 GHz	MCL BW-K10-2W44+	Mini Circuits		400001186	ev		

8 Measurement uncertainty

Measurement uncertainty	
Test case	Uncertainty
RF output power conducted	± 1 dB
RF output power radiated	± 3 dB
Frequency stability	± 20 Hz
Spurious emissions radiated below 30 MHz	± 3 dB
Spurious emissions radiated 30 MHz to 1 GHz	± 3 dB
Spurious emissions radiated 1 GHz to 12.75 GHz	± 3.7 dB
Spurious emissions radiated above 12.75 GHz	± 4.5 dB
Spurious emissions conducted	± 3 dB
Block edge compliance	± 3 dB
Occupied bandwidth	± RBW

9 Sequence of testing

9.1 Sequence of testing radiated spurious 9 kHz to 30 MHz

Setup

- The equipment is set up to simulate normal operation mode as described in the user manual or defined by the manufacturer.
- If the EUT is a tabletop system, a 2-axis positioner with 1.5 m height is used.
- If the EUT is a floor standing device, it is placed directly on the turn table.
- Auxiliary equipment and cables are positioned to simulate normal operation conditions as described in ANSI C 63.4.
- The AC power port of the EUT (if available) is connected to a power outlet below the turntable.
- Measurement distance is 3 m (see ANSI C 63.4) – see test details.
- EUT is set into operation.

Premeasurement

- The turntable rotates from 0° to 315° using 45° steps.
- The antenna height is 1.5 m.
- At each turntable position the analyzer sweeps with positive-peak detector to find the maximum of all emissions.

Final measurement

- Identified emissions during the premeasurement are maximized by the software by rotating the turntable from 0° to 360°. In case of the 2-axis positioner is used the elevation axis is also rotated from 0° to 360°.
- The final measurement is done in the position (turntable and elevation) causing the highest emissions with quasi-peak (as described in ANSI C 63.4).
- Final levels, frequency, measuring time, bandwidth, turntable position, correction factor, margin to the limit and limit will be recorded. A plot with the graph of the premeasurement and the limit is stored.

9.2 Sequence of testing radiated spurious 30 MHz to 1 GHz

Setup

- The equipment is set up to simulate normal operation mode as described in the user manual or defined by the manufacturer.
- If the EUT is a tabletop system, a table with 0.8 m height is used, which is placed on the ground plane.
- If the EUT is a floor standing device, it is placed on the ground plane with insulation between both.
- Auxiliary equipment and cables are positioned to simulate normal operation conditions as described in ANSI C 63.4.
- The AC power port of the EUT (if available) is connected to a power outlet below the turntable.
- Measurement distance is 10 m or 3 m (see ANSI C 63.4) – see test details.
- EUT is set into operation.

Premeasurement

- The turntable rotates from 0° to 315° using 45° steps.
- The antenna is polarized vertical and horizontal.
- The antenna height changes from 1 m to 3 m.
- At each turntable position, antenna polarization and height the analyzer sweeps three times in peak to find the maximum of all emissions.

Final measurement

- The final measurement is performed for at least six highest peaks according to the requirements of the ANSI C63.4.
- Based on antenna and turntable positions at which the peak values are measured the software maximize the peaks by changing turntable position $\pm 45^\circ$ and antenna height between 1 and 4 m.
- The final measurement is done with quasi-peak detector (as described in ANSI C 63.4).
- Final levels, frequency, measuring time, bandwidth, antenna height, antenna polarization, turntable angle, correction factor, margin to the limit and limit are recorded. A plot with the graph of the premeasurement with marked maximum final results and the limit is stored.

9.3 Sequence of testing radiated spurious 1 GHz to 12.75 GHz

Setup

- The equipment is set up to simulate normal operation mode as described in the user manual or defined by the manufacturer.
- If the EUT is a tabletop system, a 2-axis positioner with 1.5 m height is used.
- If the EUT is a floor standing device, it is placed directly on the turn table.
- Auxiliary equipment and cables are positioned to simulate normal operation conditions as described in ANSI C 63.4.
- The AC power port of the EUT (if available) is connected to a power outlet below the turntable.
- Measurement distance is 3 m (see ANSI C 63.4) – see test details.
- EUT is set into operation.

Premeasurement

- The turntable rotates from 0° to 315° using 45° steps.
- The antenna is polarized vertical and horizontal.
- The antenna height is 1.5 m.
- At each turntable position and antenna polarization the analyzer sweeps with positive peak detector to find the maximum of all emissions.

Final measurement

- The final measurement is performed for at least six highest peaks according to the requirements of the ANSI C63.4.
- Based on antenna and turntable positions at which the peak values are measured the software maximizes the peaks by rotating the turntable from 0° to 360°. This measurement is repeated for different EUT-table positions (0° to 150° in 30°-steps) and for both antenna polarizations.
- The final measurement is done in the position (turntable, EUT-table and antenna polarization) causing the highest emissions with Peak and RMS detector (as described in ANSI C 63.4).
- Final levels, frequency, measuring time, bandwidth, turntable position, EUT-table position, antenna polarization, correction factor, margin to the limit and limit are recorded. A plot with the graph of the premeasurement with marked maximum final results and the limit is stored.

9.4 Sequence of testing radiated spurious above 12.75 GHz

Setup

- The equipment is set up to simulate normal operation mode as described in the user manual or defined by the manufacturer.
- Auxiliary equipment and cables are positioned to simulate normal operation conditions as described in ANSI C 63.4.
- The AC power port of the EUT (if available) is connected to a power outlet.
- The measurement distance is as appropriate (e.g. 0.5 m).
- The EUT is set into operation.

Premeasurement

- The test antenna is handheld and moved carefully over the EUT to cover the EUT's whole sphere and different polarizations of the antenna.

Final measurement

- The final measurement is performed at the position and antenna orientation causing the highest emissions with Peak and RMS detector (as described in ANSI C 63.4).
- Final levels, frequency, measuring time, bandwidth, correction factor, margin to the limit and limit are recorded. A plot with the graph of the premeasurement and the limit is stored.

10 Summary of measurement results

<input checked="" type="checkbox"/>	No deviations from the technical specifications were ascertained
<input type="checkbox"/>	There were deviations from the technical specifications ascertained
<input type="checkbox"/>	This test report is only a partial test report. The content and verdict of the performed test cases are listed below.

TC identifier	Description	verdict	date	Remark
RF-Testing	CFR Part 22, 24 RSS 132, 133	passed	2016-05-31	-/-

10.1 GSM 850

Test Case	temperature conditions	power source voltages	C	NC	NA	NP	Remark
RF Output Power	Nominal	Nominal	<input checked="" type="checkbox"/>	<input type="checkbox"/>	<input type="checkbox"/>	<input type="checkbox"/>	-/-
Frequency Stability	Nominal & Extreme	Nominal	<input checked="" type="checkbox"/>	<input type="checkbox"/>	<input type="checkbox"/>	<input type="checkbox"/>	-/-
Spurious Emissions Radiated	Nominal	Nominal	<input checked="" type="checkbox"/>	<input type="checkbox"/>	<input type="checkbox"/>	<input type="checkbox"/>	-/-
Spurious Emissions Conducted	Nominal	Nominal	<input checked="" type="checkbox"/>	<input type="checkbox"/>	<input type="checkbox"/>	<input type="checkbox"/>	-/-
Block Edge Compliance	Nominal	Nominal	<input checked="" type="checkbox"/>	<input type="checkbox"/>	<input type="checkbox"/>	<input type="checkbox"/>	-/-
Occupied Bandwidth	Nominal	Nominal	<input checked="" type="checkbox"/>	<input type="checkbox"/>	<input type="checkbox"/>	<input type="checkbox"/>	-/-

Note: C = Compliant; NC = Not compliant; NA = Not applicable; NP = Not performed

10.2 PCS 1900

Test Case	temperature conditions	power source voltages	C	NC	NA	NP	Remark
RF Output Power	Nominal	Nominal	<input checked="" type="checkbox"/>	<input type="checkbox"/>	<input type="checkbox"/>	<input type="checkbox"/>	-/-
Frequency Stability	Nominal & Extreme	Nominal	<input checked="" type="checkbox"/>	<input type="checkbox"/>	<input type="checkbox"/>	<input type="checkbox"/>	-/-
Spurious Emissions Radiated	Nominal	Nominal	<input checked="" type="checkbox"/>	<input type="checkbox"/>	<input type="checkbox"/>	<input type="checkbox"/>	-/-
Spurious Emissions Conducted	Nominal	Nominal	<input checked="" type="checkbox"/>	<input type="checkbox"/>	<input type="checkbox"/>	<input type="checkbox"/>	-/-
Block Edge Compliance	Nominal	Nominal	<input checked="" type="checkbox"/>	<input type="checkbox"/>	<input type="checkbox"/>	<input type="checkbox"/>	-/-
Occupied Bandwidth	Nominal	Nominal	<input checked="" type="checkbox"/>	<input type="checkbox"/>	<input type="checkbox"/>	<input type="checkbox"/>	-/-

Note: C = Compliant; NC = Not compliant; NA = Not applicable; NP = Not performed

10.3 UMTS band V

Test Case	temperature conditions	power source voltages	C	NC	NA	NP	Remark
RF Output Power	Nominal	Nominal	<input checked="" type="checkbox"/>	<input type="checkbox"/>	<input type="checkbox"/>	<input type="checkbox"/>	-/-
Frequency Stability	Nominal & Extreme	Nominal	<input checked="" type="checkbox"/>	<input type="checkbox"/>	<input type="checkbox"/>	<input type="checkbox"/>	-/-
Spurious Emissions Radiated	Nominal	Nominal	<input checked="" type="checkbox"/>	<input type="checkbox"/>	<input type="checkbox"/>	<input type="checkbox"/>	-/-
Spurious Emissions Conducted	Nominal	Nominal	<input checked="" type="checkbox"/>	<input type="checkbox"/>	<input type="checkbox"/>	<input type="checkbox"/>	-/-
Block Edge Compliance	Nominal	Nominal	<input checked="" type="checkbox"/>	<input type="checkbox"/>	<input type="checkbox"/>	<input type="checkbox"/>	-/-
Occupied Bandwidth	Nominal	Nominal	<input checked="" type="checkbox"/>	<input type="checkbox"/>	<input type="checkbox"/>	<input type="checkbox"/>	-/-

Note: C = Compliant; NC = Not compliant; NA = Not applicable; NP = Not performed

11 RF measurements

11.1 Results GSM 850

All GSM-band measurements are done in GSM mode only.
 All relevant tests have been repeated using 8-PSK modulation if EDGE mode is supported. All tests were performed with one timeslot in uplink activated and one timeslot in downlink activated. For each mode the highest output power was determined and used.

11.1.1 RF output power

Description:

This paragraph contains average power, peak output power, PAPR and ERP measurements for the mobile station.

The plots in this test report represents only an example of the measurements. All plots of this chapter are available on request.

The red line in the measurements indicates the ideal Gaussian distribution for the measured amplitude range.

Measurement:

The mobile was set up for the maximum output power with pseudo random data modulation.

To determine the Peak-To-Average Power Ratio (PAPR) the measurement was performed with the Power Complementary Cumulative Distribution Function (CCDF).

Measurement parameters	
Detector:	Sample
AQT:	15.6 ms
Resolution bandwidth:	40 MHz
Used equipment:	see chapter 7.1 – A and chapter 7.3 – A
Measurement uncertainty:	see chapter 8

Limits:

FCC	IC
Nominal Peak Output Power	
+38.45 dBm	
In measuring transmissions in this band using an average power technique, the peak-to-average ratio (PAR) of the transmission may not exceed 13 dB.	

Results:

Output Power (conducted) GMSK mode			
Frequency (MHz)	Peak Output Power (dBm)	Average Output Power (dBm)	Peak to Average Ratio (dB) CCDF
824.2	32.25	32.01	0.24
836.4	32.21	31.97	0.24
848.8	32.63	32.30	0.32
Measurement uncertainty	± 0.5 dB		

Output Power (conducted) 8-PSK mode			
Frequency (MHz)	Peak Output Power (dBm)	Average Output Power (dBm)	Peak to Average Ratio (dB) CCDF
824.2	26.04	19.75	6.29
836.4	23.36	19.86	3.50
848.8	23.88	20.40	3.48
Measurement uncertainty	± 0.5 dB		

Output Power (radiated) GMSK mode	
Frequency (MHz)	Average Output Power (dBm) - ERP
824.2	29.6
836.4	31.2
848.8	30.9
Measurement uncertainty	± 2.0 dB

Output Power (radiated) 8-PSK mode	
Frequency (MHz)	Average Output Power (dBm) - ERP
824.2	17.3
836.4	19.1
848.8	19.0
Measurement uncertainty	± 2.0 dB

Plots GMSK:

Plot 1: Channel 128

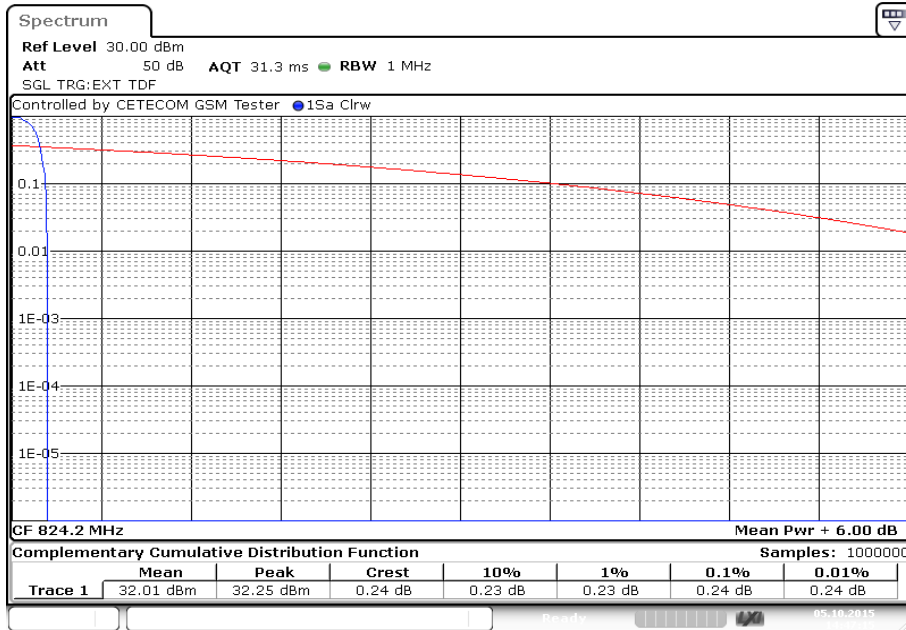

Date: 5.OCT.2015 14:47:15

Plot 2: Channel 189

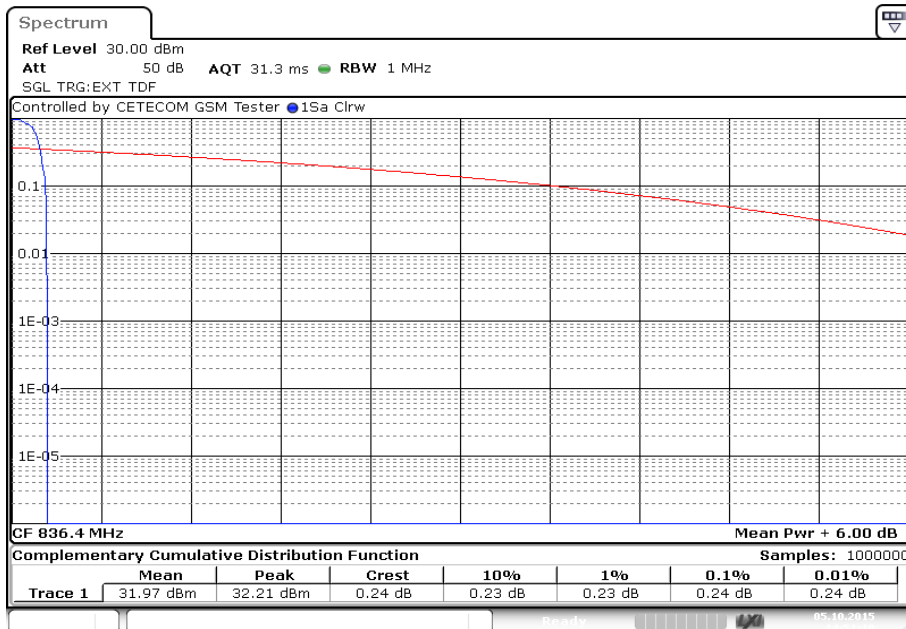

Date: 5.OCT.2015 14:51:10

Plot 3: Channel 251

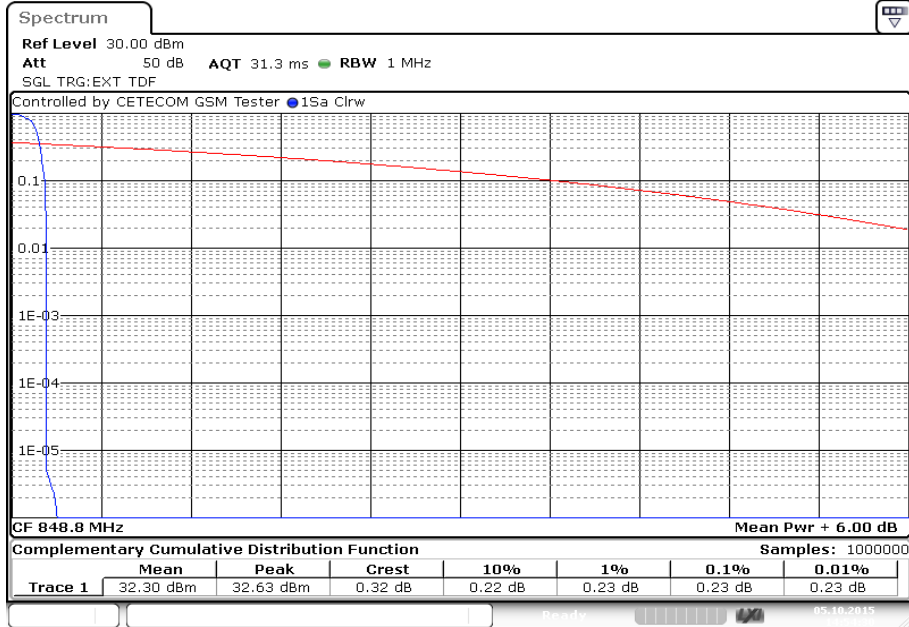

Date: 5.OCT.2015 14:54:30

Plots 8-PSK:

Plot 1: Channel 128

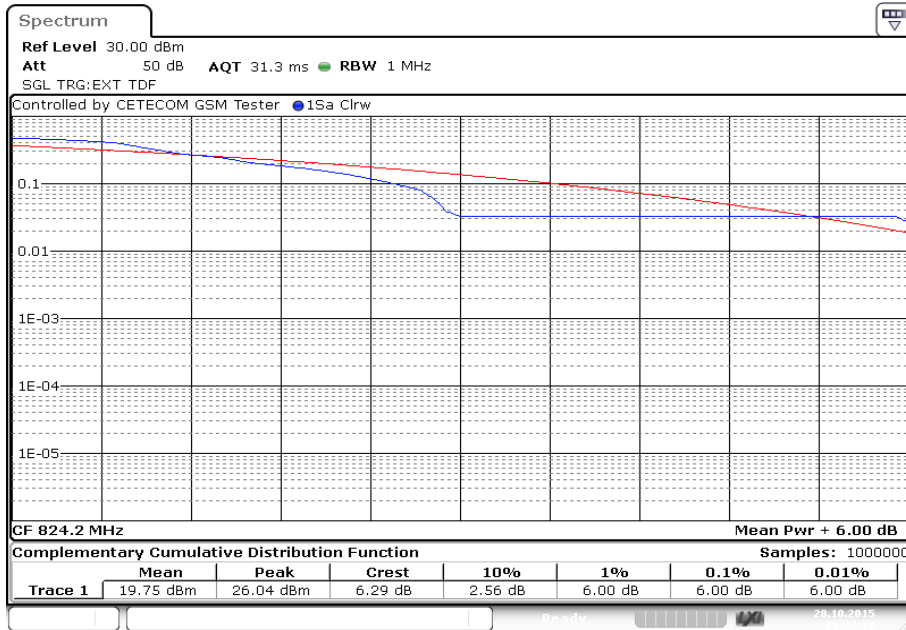

Date: 28.OCT.2015 09:27:31

Plot 2: Channel 189

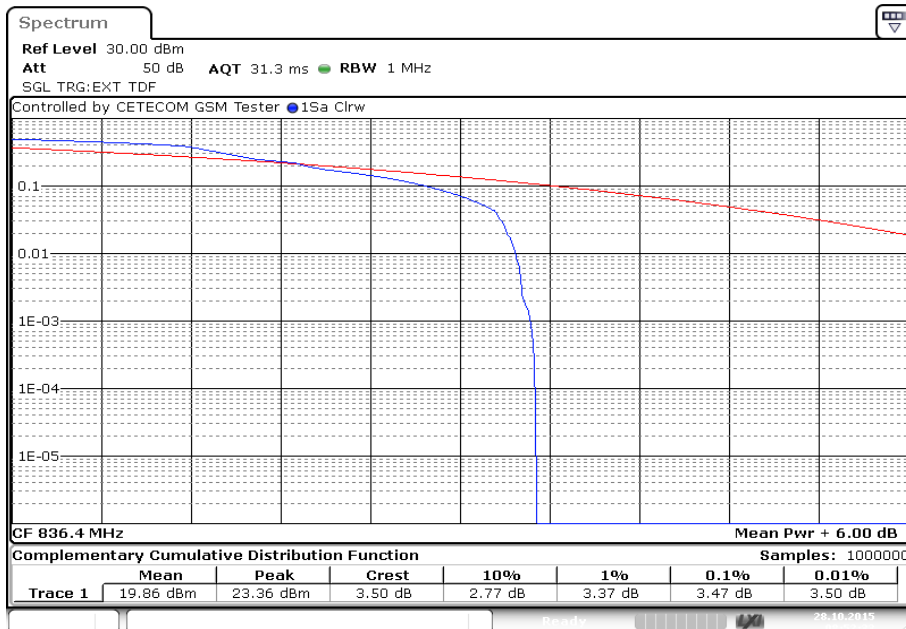

Date: 28.OCT.2015 08:52:33

Plot 3: Channel 251

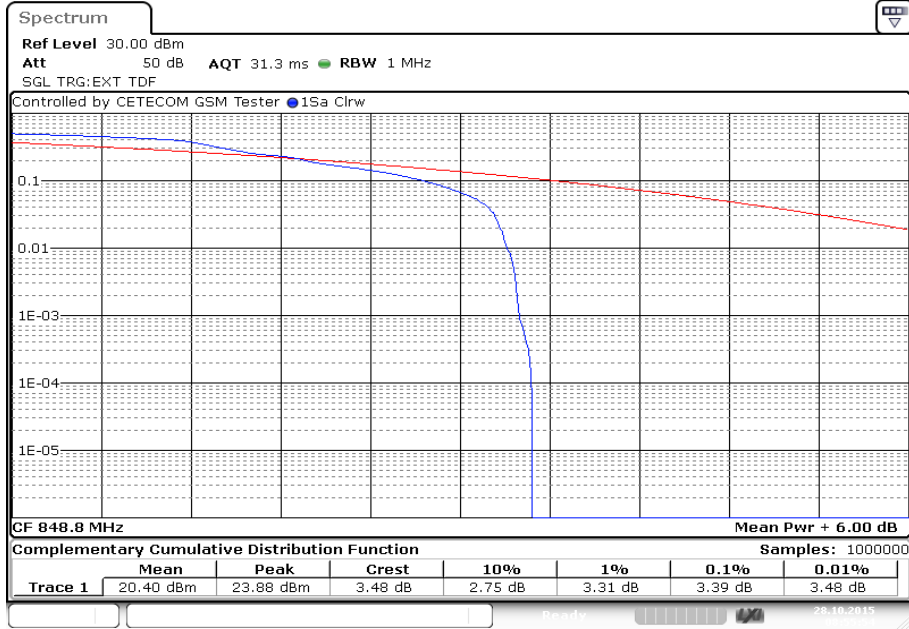

Date: 28.OCT.2015 08:55:54

11.1.2 Frequency stability

Description:

In order to measure the carrier frequency under normal conditions it is necessary to make measurements with the mobile station connected to R&S CMU200 Wideband Radio Communication Tester.

1. Measure the carrier frequency at room temperature.
2. Subject the mobile station to overnight soak at -30 C.
3. With the mobile station powered with V_{nom} connected to the CMU200 on the centre channel. Measure the carrier frequency. These measurements should be made within two minutes of powering up the mobile station to prevent significant self warming.
4. Repeat the above measurements at 10°C increments from -30°C to +50°C. Allow at least 15 minutes at each temperature unpowered before making measurements.
5. At all temperature levels hold the temperature to +/- 0.5°C during the measurement procedure.

Measurement:

Measurement parameters	
Detector:	Measured with CMU200
Sweep time:	
Video bandwidth:	
Resolution bandwidth:	
Span:	
Trace-Mode:	
Test setup:	see chapter chapter 7.3 – B
Measurement uncertainty:	see chapter 8

Limits:

FCC	IC
Frequency Stability	
± 2.5 ppm	

Results:**FREQ ERROR versus VOLTAGE**

Voltage (V)	Frequency Error (Hz)	Frequency Error (%)	Frequency Error (ppm)
3.8*	+11	0.000013	0.0132

* The module requires an external stabilized power supply.

FREQ ERROR versus TEMPERATURE

Temperature (°C)	Frequency Error (Hz)	Frequency Error (%)	Frequency Error (ppm)
-30	+10	0.000012	0.0120
-20	+10	0.000012	0.0120
-10	+10	0.000012	0.0120
± 0	+14	0.000017	0.0167
+10	+15	0.000017	0.0167
+20	+14	0.000017	0.0167
+30	+11	0.000013	0.0132
+40	+14	0.000017	0.0167
+50	+12	0.000014	0.0143

11.1.3 Spurious emissions radiated

Description:

The following steps outline the procedure used to measure the radiated emissions from the mobile station. The site is constructed in accordance with ANSI C63.4:2009 requirements and is recognized by the FCC to be in compliance for a 3 and a 10 meter site. The spectrum was scanned from 30 MHz to the 10th harmonic of the highest frequency generated within the equipment, which is the transmitted carrier that can be as high as 848.8 MHz. This was rounded up to 12 GHz. The resolution bandwidth is set as outlined in Part 22.917. The spectrum was scanned with the mobile station transmitting at carrier frequencies that pertain to low, mid and high channels of the GSM-850 band.

Measurement:

Measurement parameters	
Detector:	Peak
Sweep time:	2 sec.
Video bandwidth:	Below 1 GHz: 100 kHz Above 1 GHz: 1 MHz
Resolution bandwidth:	Below 1 GHz: 100 kHz Above 1 GHz: 1 MHz
Span:	100 MHz Steps
Trace-Mode:	Max Hold
Used equipment:	see chapter 7.1 – A
Measurement uncertainty:	see chapter 8

Limits:

FCC	IC
Spurious Emissions Radiated	
Attenuation $\geq 43 + 10\log(P)$ (P, Power in Watts)	
-13 dBm	

Results GPRS & EGPRS:

Radiated emissions measurements were made only at the upper, center, and lower carrier frequencies of the GSM-850 band (824.2 MHz, 836.4 MHz and 848.8 MHz). It was decided that measurements at these three carrier frequencies would be sufficient to demonstrate compliance with emissions limits because it was seen that all the significant spurs occur well outside the band and no radiation was seen from a carrier in one block of the GSM-850 band into any of the other blocks. The equipment must still, however, meet emissions requirements with the carrier at all frequencies over which it is capable of operating and it is the manufacturer's responsibility to verify this.

The final open field radiated levels are presented on the next pages. All measurements were done in horizontal and vertical polarization; the plots show the worst case. The plots show only the middle channel. If spurious were detected, the lowest and highest channel were checked too. The found values are stated in the table below.

As can be seen from this data, the emissions from the test item were within the specification limit.

Spurious Emission Level (dBm)								
Harmonic	Ch. 128 Freq. (MHz)	Level [dBm]	Harmonic	Ch. 189 Freq. (MHz)	Level [dBm]	Harmonic	Ch. 251 Freq. (MHz)	Level [dBm]
2	1648.4	-	2	1672.8	-54.7	2	1697.6	-
3	2472.6	-	3	2509.2	-36.1	3	2546.4	-
4	3296.8	-	4	3345.6	-	4	3395.2	-
5	4121.0	-	5	4182.0	-	5	4244.0	-
6	4945.2	-	6	5018.4	-	6	5092.8	-
7	5769.4	-	7	5854.8	-	7	5941.6	-
8	6593.6	-	8	6691.2	-	8	6790.4	-
9	7417.8	-	9	7527.6	-	9	7639.2	-
10	8242.0	-	10	8364.0	-	10	8488.0	-
Measurement uncertainty					± 3dB			

Plots GMSK:

Plot 1: Channel 189 (Traffic mode up to 30 MHz)

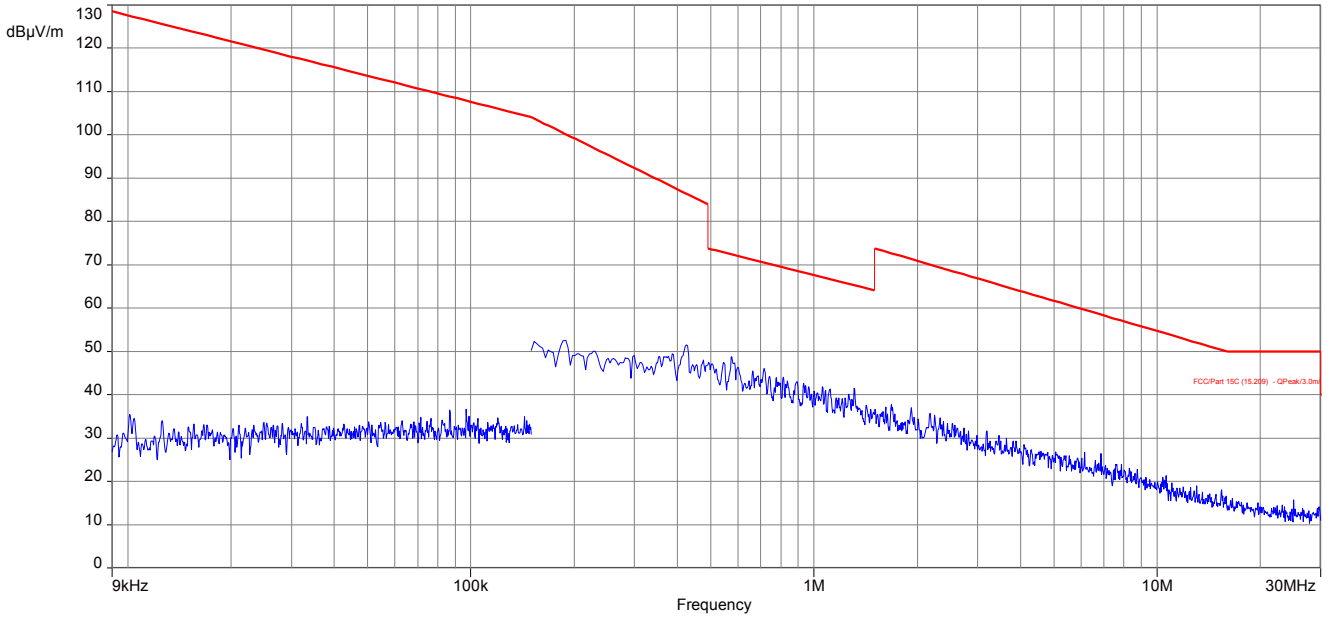

Plot 2: Channel 189 (30 MHz – 12.75 GHz)

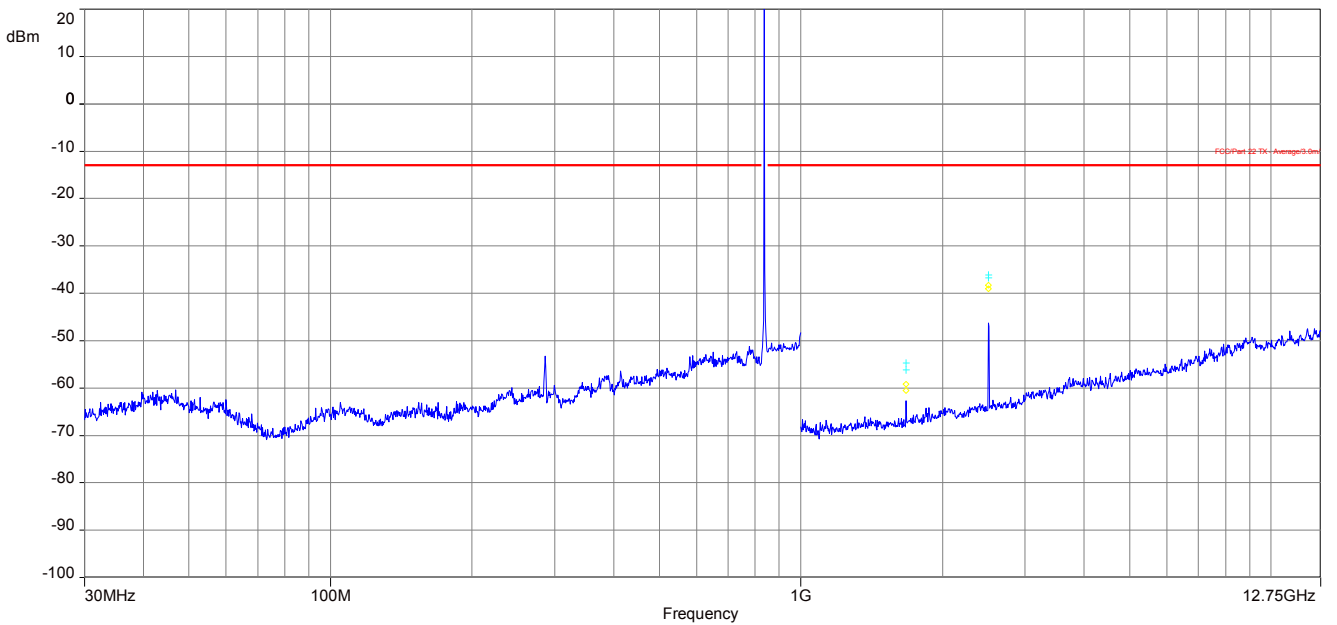

Plots 8-PSK:

Plot 1: Channel 189 (Traffic mode up to 30 MHz)

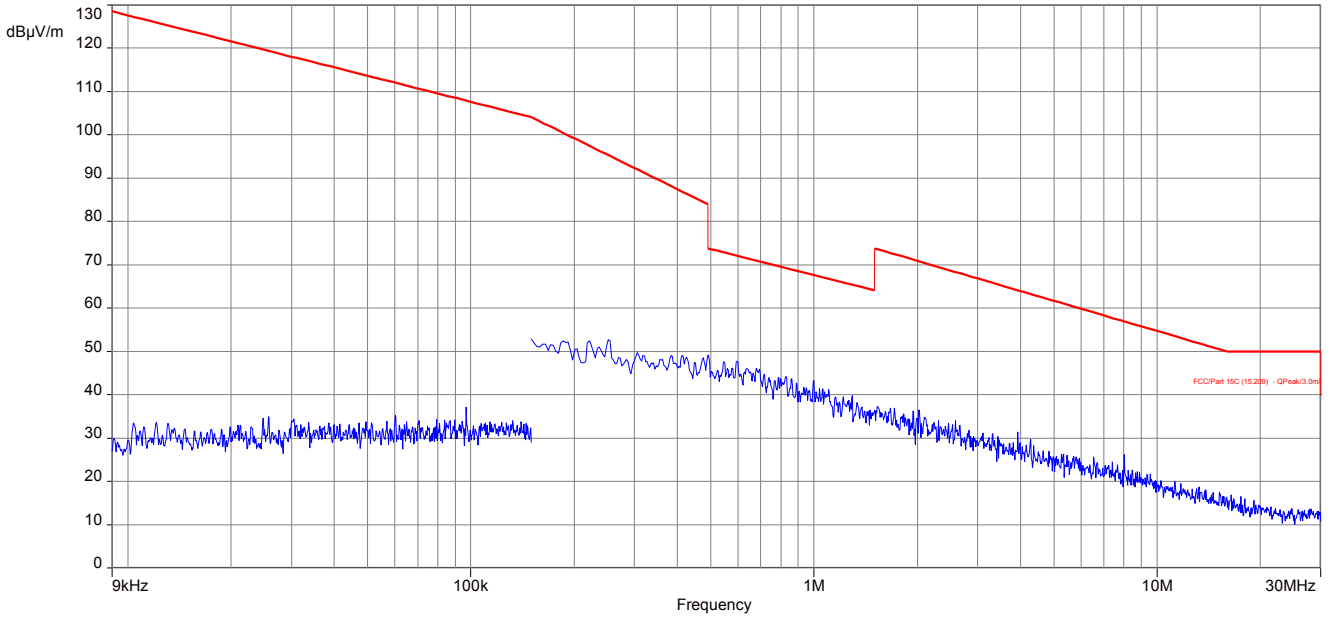

Plot 2: Channel 189 (30 MHz – 12.75 GHz)

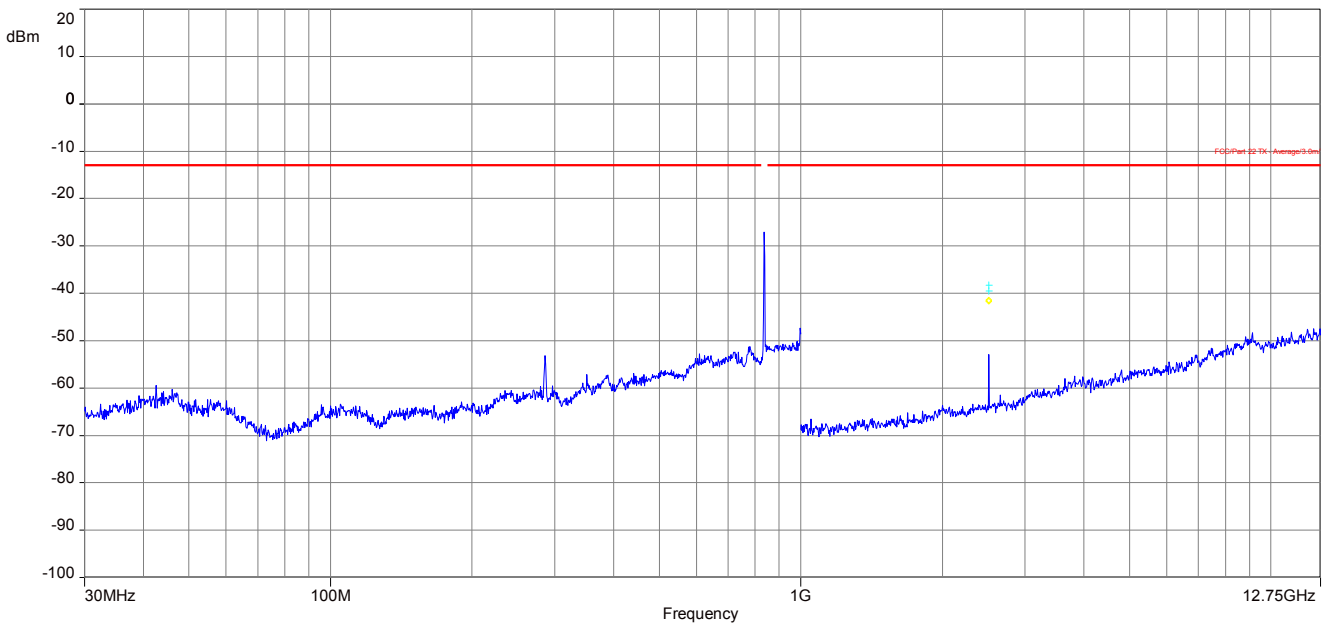

11.1.4 Spurious emissions conducted

Description:

The following steps outline the procedure used to measure the conducted emissions from the mobile station.

1. Determine frequency range for measurements: From CFR 2.1057 the spectrum should be investigated from the lowest radio frequency generated in the equipment up to at least the 10th harmonic of the carrier frequency. For the mobile station equipment tested, this equates to a frequency range of 13 MHz to 9 GHz, data taken from 10 MHz to 26 GHz.
2. Determine mobile station transmits frequencies: below outlines the band edge frequencies pertinent to conducted emissions testing.

GSM-850 Transmitter Channel Frequency

- 128 824.2 MHz
- 189 836.4 MHz
- 251 848.8 MHz

Measurement:

Measurement parameters	
Detector:	Peak
Sweep time:	Auto
Video bandwidth:	Pre-measurement with 1 MHz On spurious detection re-measurement below 1 GHz with 100 kHz Above 1 GHz with 1 MHz
Resolution bandwidth:	Pre-measurement with 1 MHz On spurious detection re-measurement below 1 GHz with 100 kHz Above 1 GHz with 1 MHz
Span:	10 MHz – 26 GHz
Trace-Mode:	Max Hold
Used equipment:	see chapter 7.3 - A
Measurement uncertainty:	see chapter 8

Limits:

FCC	IC
Spurious Emissions Conducted	
Attenuation $\geq 43 + 10\log(P)$ (P, Power in Watts)	
-13 dBm	

Results GPRS & EGPRS:

Spurious Emission Level (dBm)								
Harmonic	Ch. 128 Freq. (MHz)	Level [dBm]	Harmonic	Ch. 189 Freq. (MHz)	Level [dBm]	Harmonic	Ch. 251 Freq. (MHz)	Level [dBm]
2	1648.4	-	2	1672.8	-	2	1697.6	-
3	2472.6	-	3	2509.2	-	3	2546.4	-
4	3296.8	-	4	3345.6	-	4	3395.2	-
5	4121.0	-	5	4182.0	-	5	4244.0	-
6	4945.2	-	6	5018.4	-	6	5092.8	-
7	5769.4	-	7	5854.8	-	7	5941.6	-
8	6593.6	-	8	6691.2	-	8	6790.4	-
9	7417.8	-	9	7527.6	-	9	7639.2	-
10	8242.0	-	10	8364.0	-	10	8488.0	-
Measurement uncertainty					± 3dB			

Plots GMSK:

Plot 1: Channel 128 (10 MHz - 26 GHz)

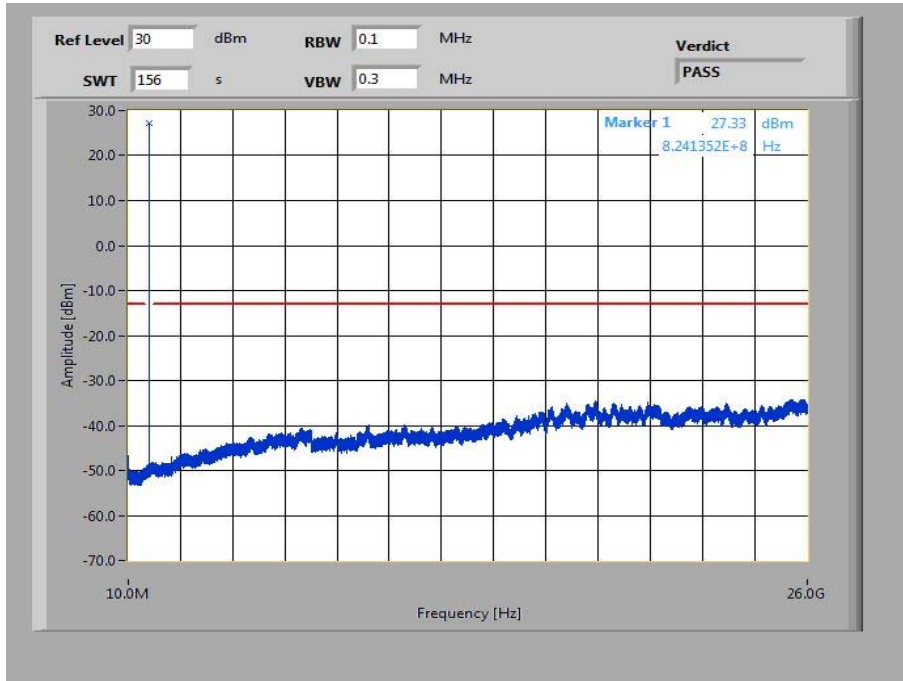

Plot 2: Channel 189 (10 MHz - 26 GHz)

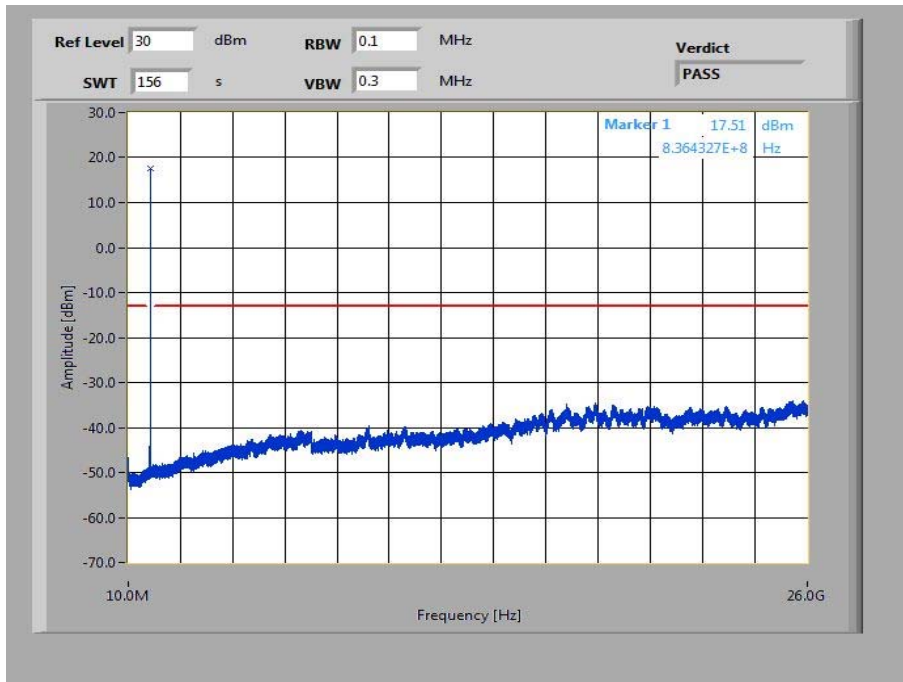

Plot 3: Channel 251 (10 MHz - 26 GHz)

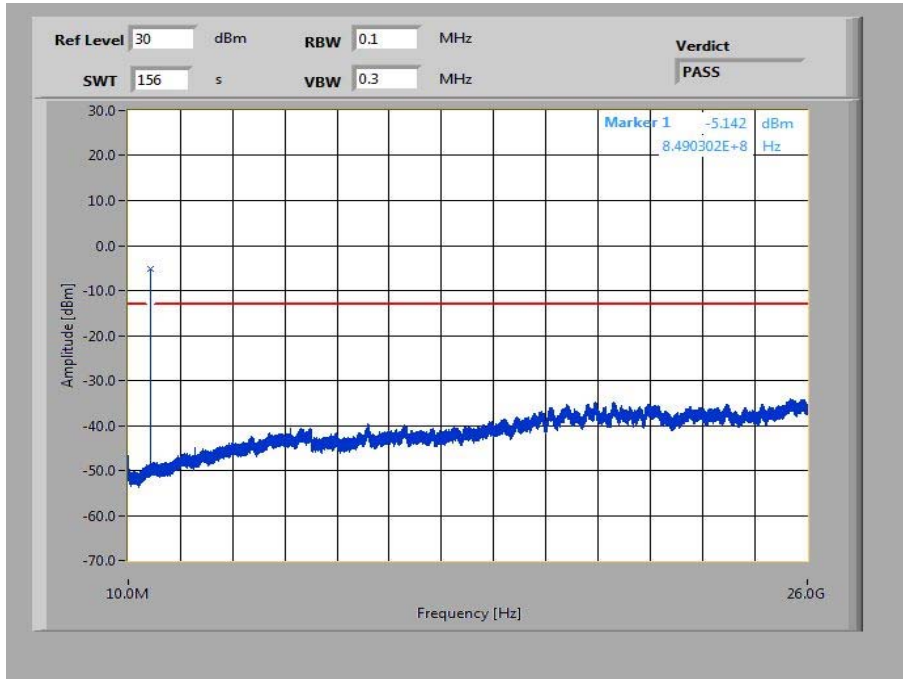

Plots 8-PSK:

Plot 1: Channel 128 (10 MHz - 26 GHz)

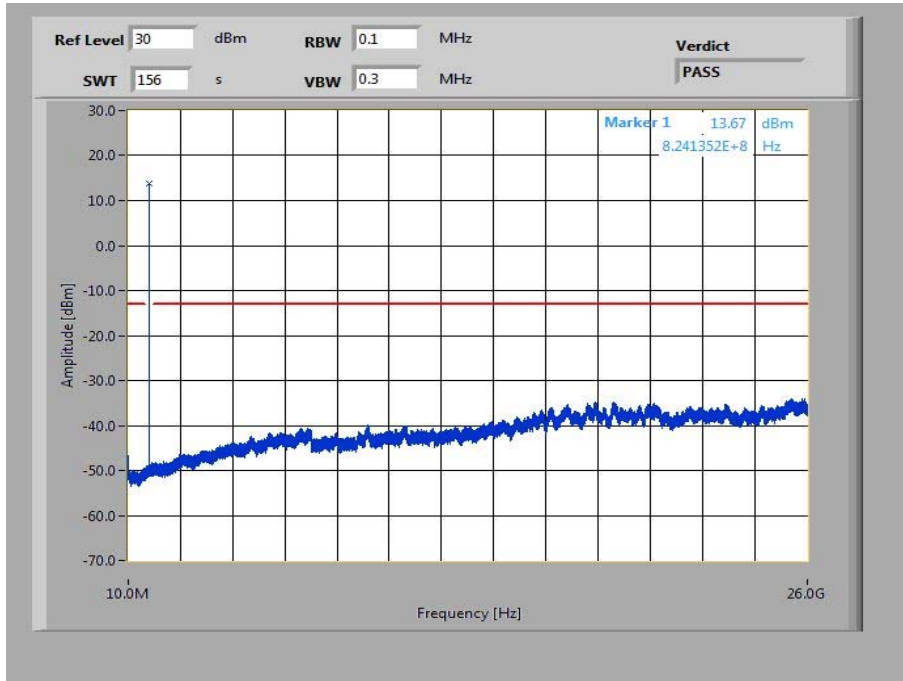

Plot 2: Channel 189 (10 MHz - 26 GHz)

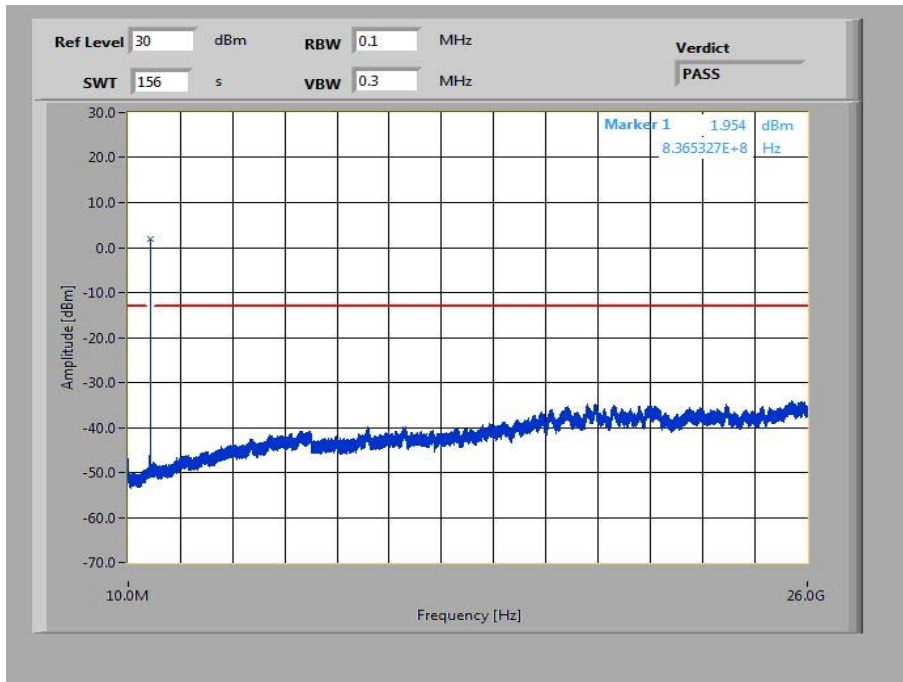

Plot 3: Channel 251 (10 MHz - 26 GHz)

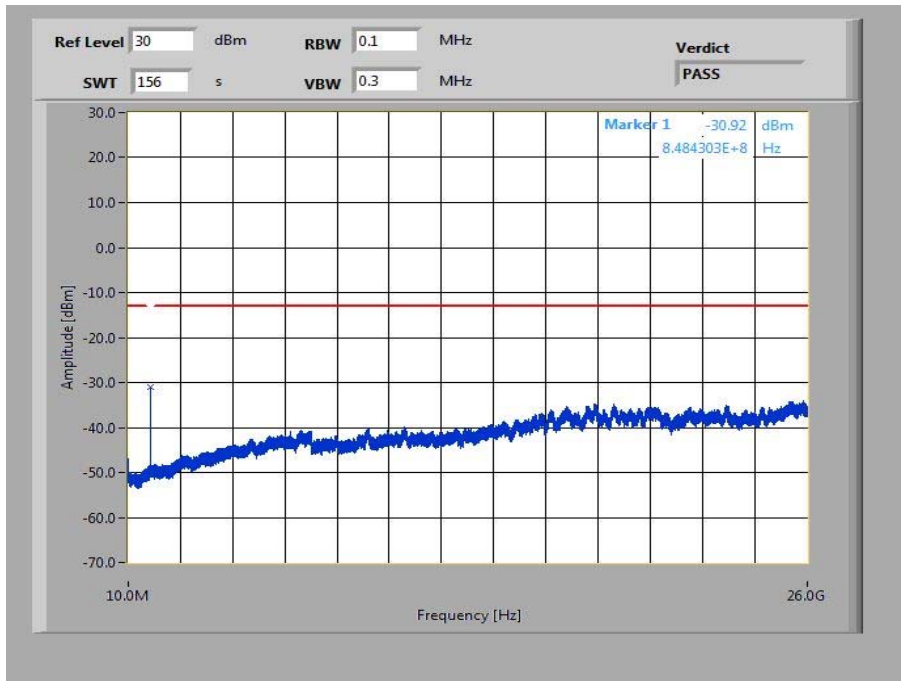

11.1.5 Block edge compliance

Description:

The spectrum at the band edges must comply with the spurious emissions limits.

Measurement:

Measurement parameters	
Detector:	RMS
Sweep time:	30 sec.
Video bandwidth:	1% - 5% of the OBW
Resolution bandwidth:	$\geq 3 \times \text{RBW}$
Span:	5 MHz
Trace-Mode:	Max Hold
Used equipment:	see chapter 7.3 - A
Measurement uncertainty:	see chapter 8

Limits:

FCC	IC
Block Edge Compliance	
Attenuation $\geq 43 + 10\log(P)$ (P, Power in Watts)	
-13 dBm	

Plots GMSK:

Plot 1: Channel 128

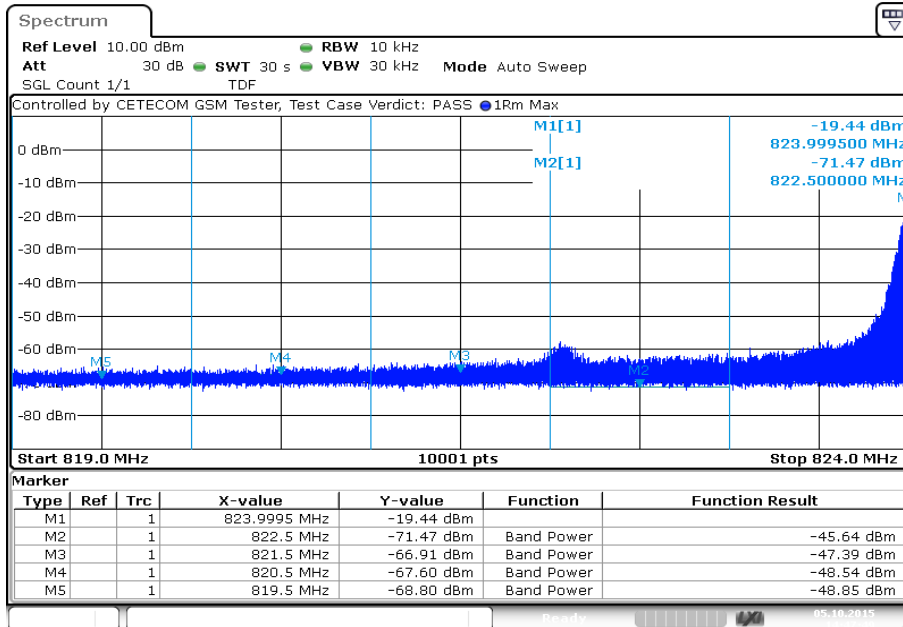

Date: 5.OCT.2015 14:47:49

Plot 2: Channel 251

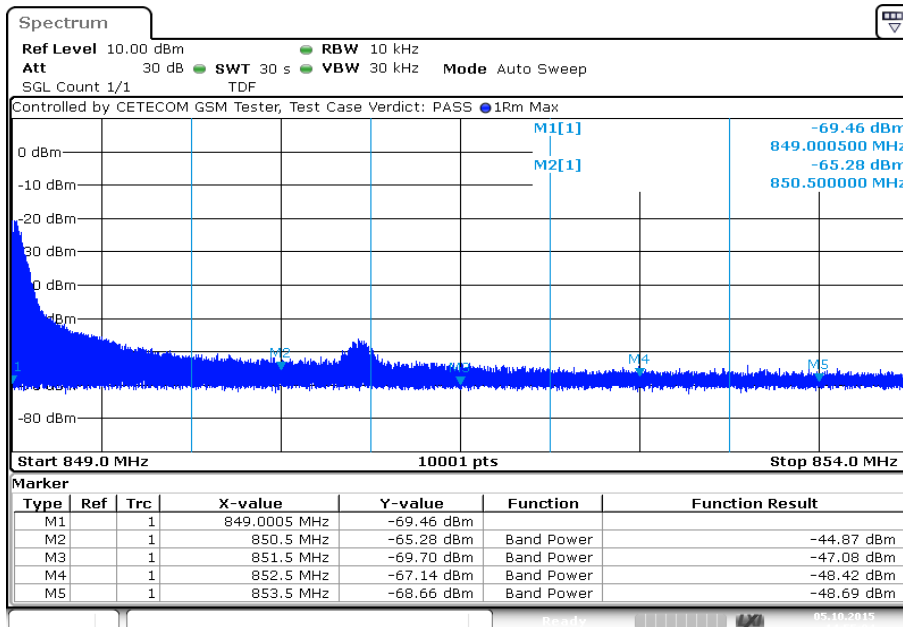

Date: 5.OCT.2015 14:55:04

Plots 8-PSK:

Plot 1: Channel 128

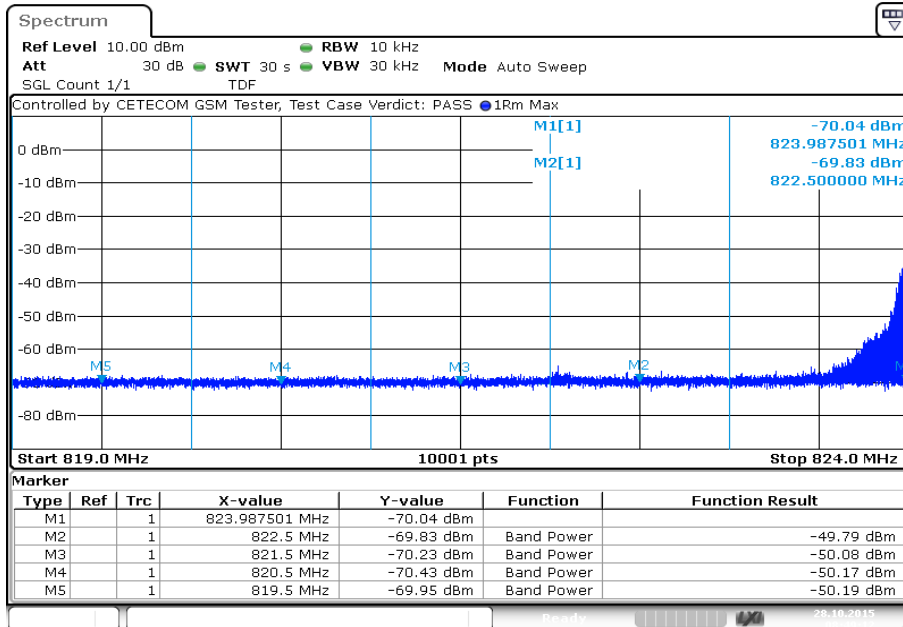

Date: 28.OCT.2015 08:49:12

Plot 2: Channel 251

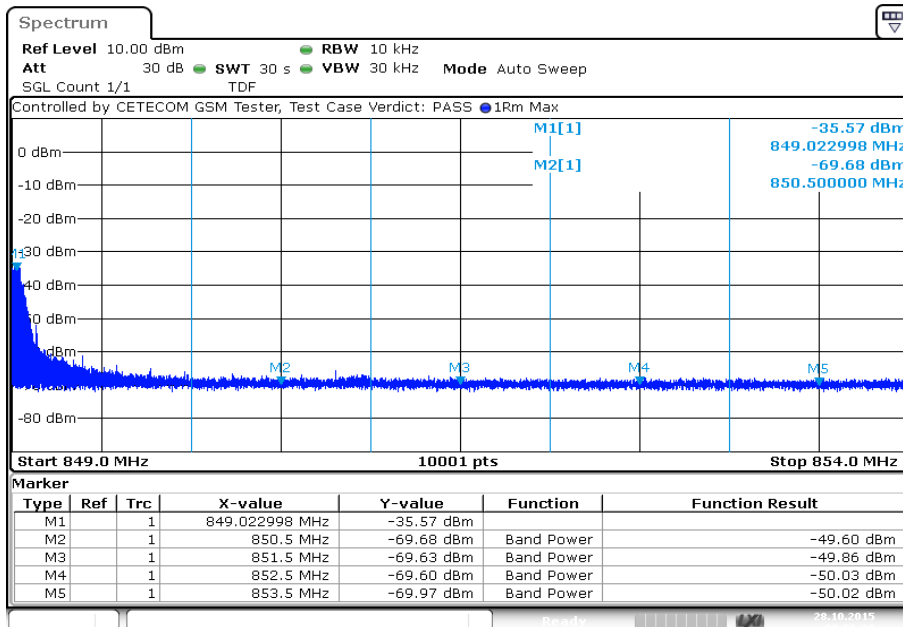

Date: 28.OCT.2015 08:56:28

11.1.6 Occupied bandwidth

Description:

Measurement of the occupied bandwidth of the transmitted signal.

Measurement:

Similar to conducted emissions, occupied bandwidth measurements are only provided for selected frequencies in order to reduce the amount of submitted data. Data were taken at the extreme and mid frequencies of the GSM-850 frequency band. The table below lists the measured 99% power and -26dBc occupied bandwidths. Spectrum analyzer plots are included on the following pages.

Measurement parameters	
Detector:	Peak
Sweep time:	Auto
Resolution bandwidth:	1% - 5% of the OBW
Video bandwidth:	≥ 3xRBW
Span:	2 x nominal BW
Trace-Mode:	Max Hold
Used equipment:	see chapter 7.3
Measurement uncertainty:	see chapter 8

Limits:

FCC	IC
Occupied Bandwidth	
Spectrum must fall completely in the specified band	

Results:

Occupied Bandwidth - GMSK mode		
Frequency (MHz)	99% OBW (kHz)	-26 dBc BW (kHz)
824.2	245.28	316.17
836.4	246.58	315.07
848.8	243.38	315.28
Measurement uncertainty	± 3 kHz	

Occupied Bandwidth – 8-PSK mode		
Frequency (MHz)	99% OBW (kHz)	-26 dBc BW (kHz)
824.2	239.08	301.70
836.4	241.98	316.07
848.8	238.38	313.47
Measurement uncertainty	± 3 kHz	

Plots GMSK:

Plot 1: Channel 128 (99% - OBW)

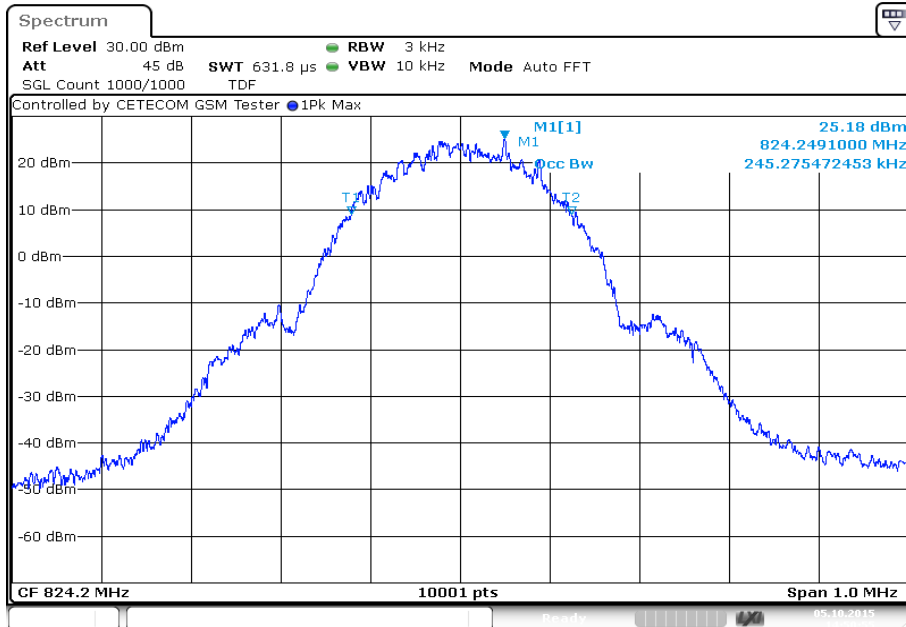

Date: 5.OCT.2015 14:50:55

Plot 2: Channel 128 (-26 dBc BW)

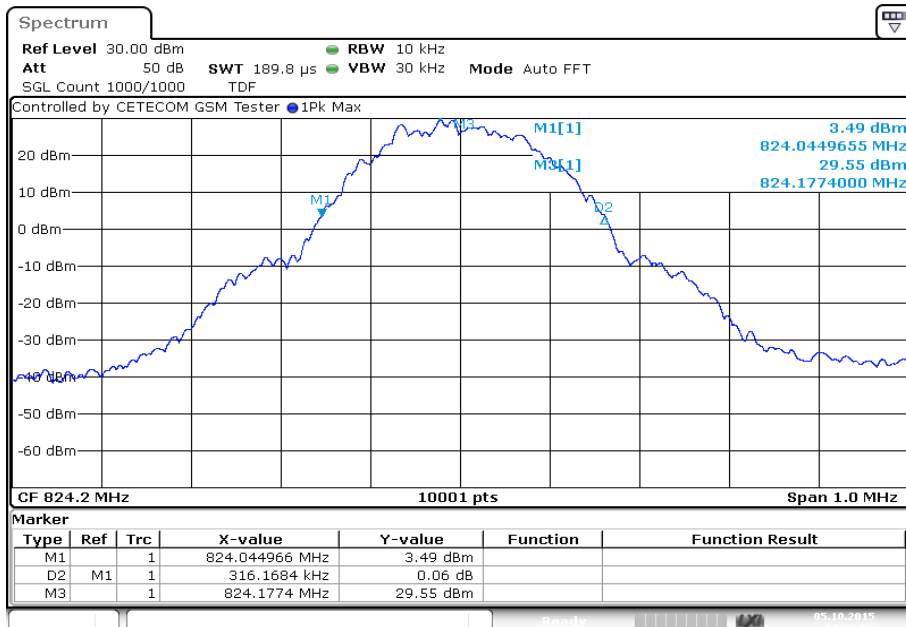

Date: 5.OCT.2015 14:51:01

Plot 3: Channel 189 (99% - OBW)

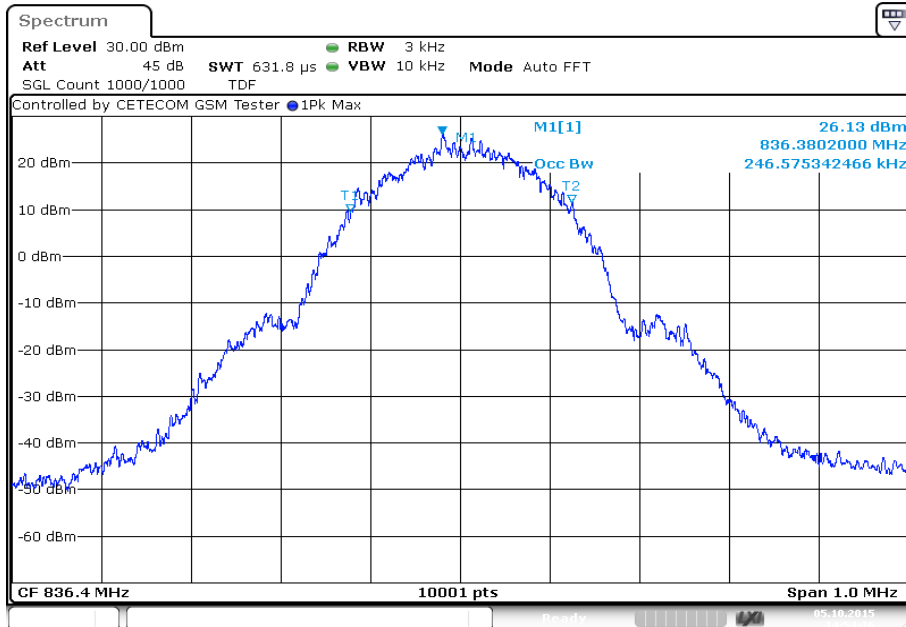

Date: 5.OCT.2015 14:54:16

Plot 4: Channel 189 (-26 dBc BW)

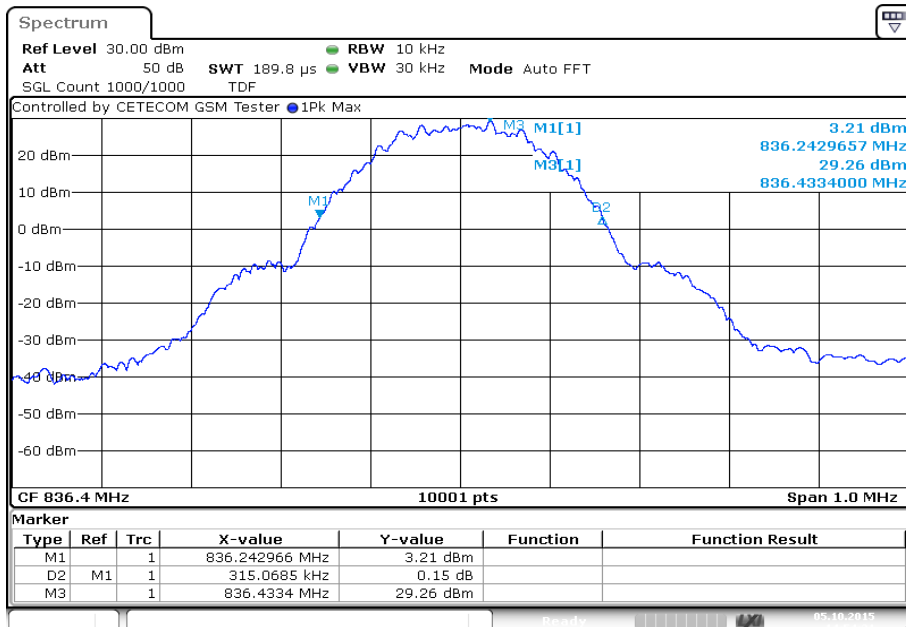

Date: 5.OCT.2015 14:54:21

Plot 5: Channel 251 (99% - OBW)

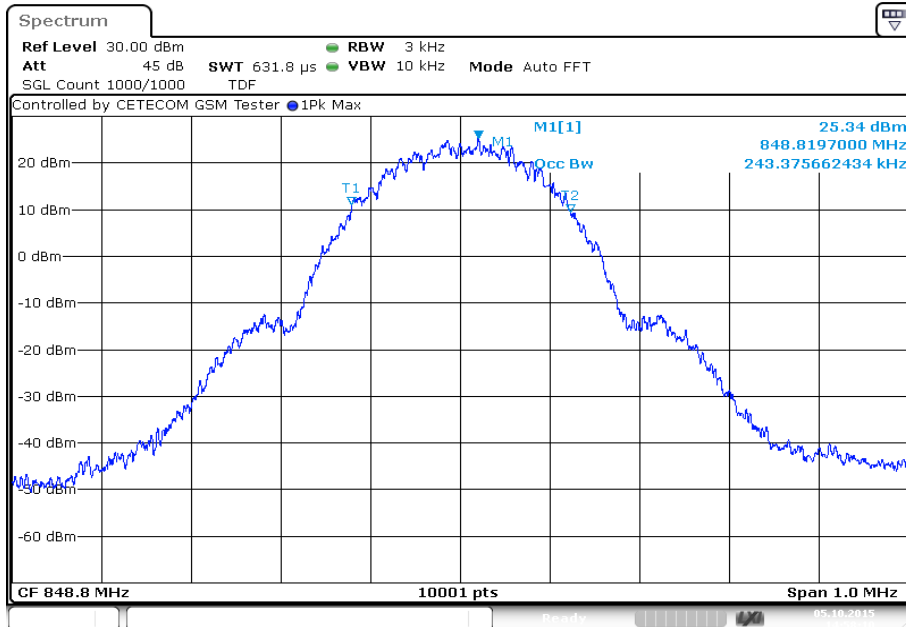

Date: 5.OCT.2015 14:58:10

Plot 6: Channel 251 (-26 dBc BW)

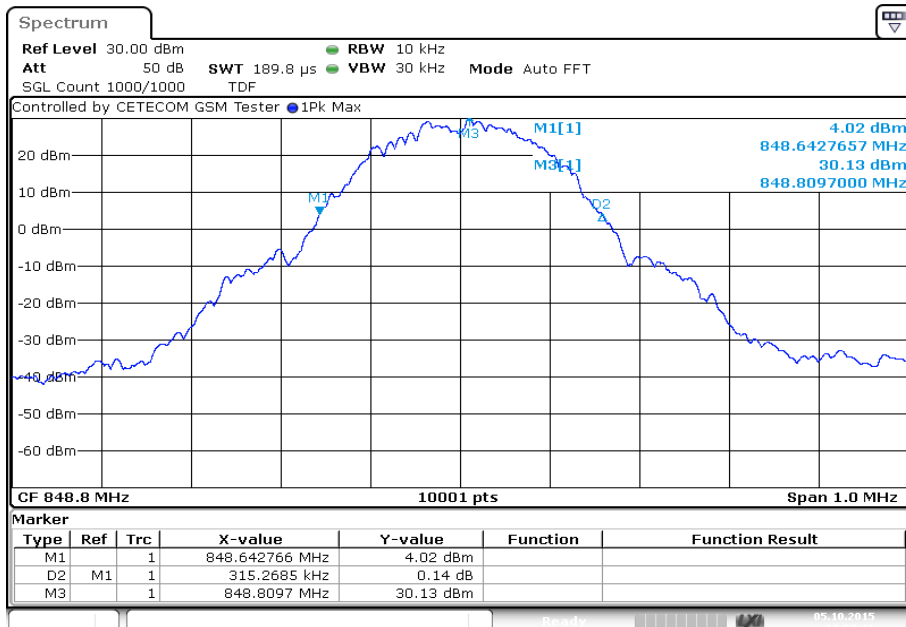

Date: 5.OCT.2015 14:58:16

Plots 8-PSK:

Plot 1: Channel 128 (99% - OBW)

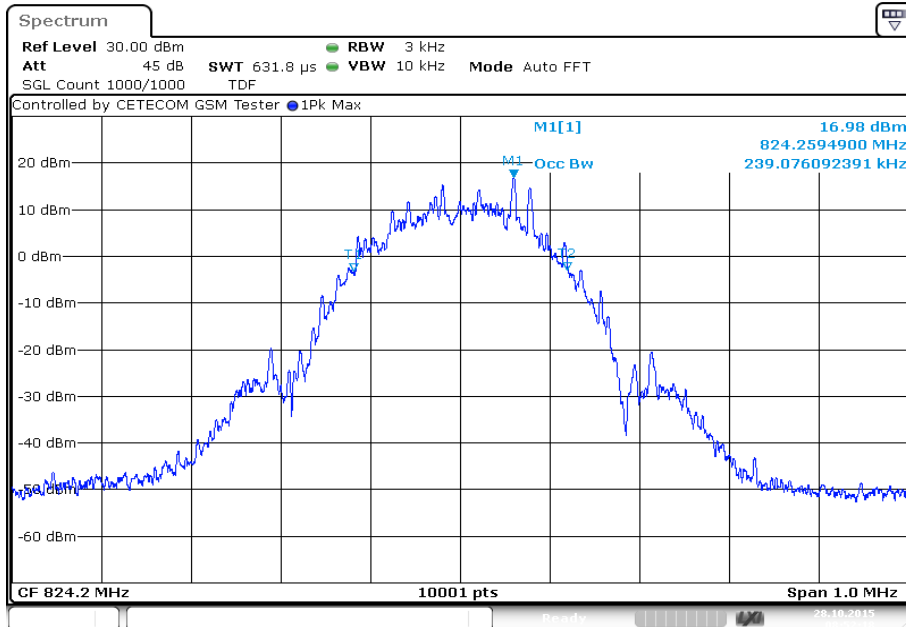

Date: 28.OCT.2015 08:52:18

Plot 2: Channel 128 (-26 dBc BW)

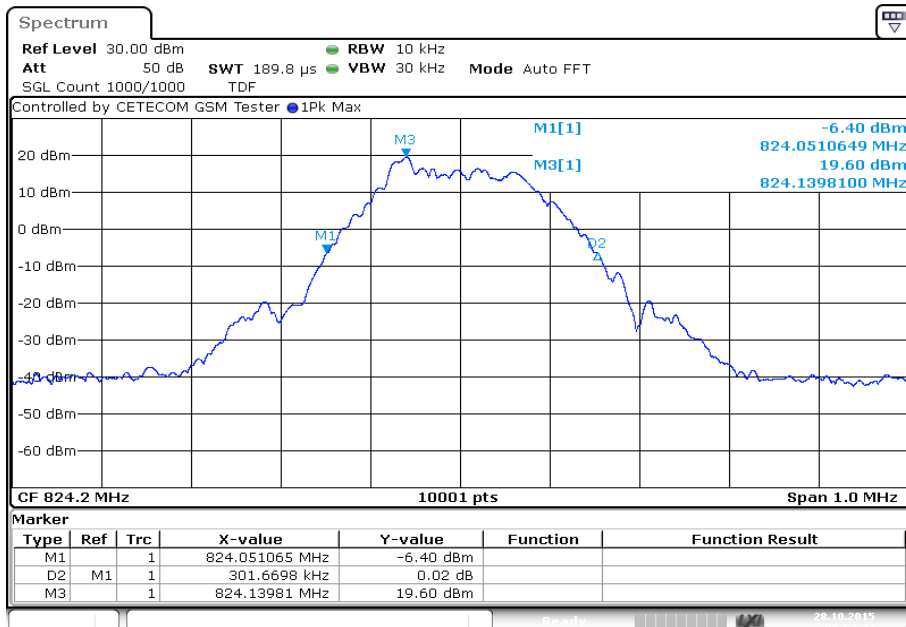

Date: 28.OCT.2015 08:52:24

Plot 3: Channel 189 (99% - OBW)

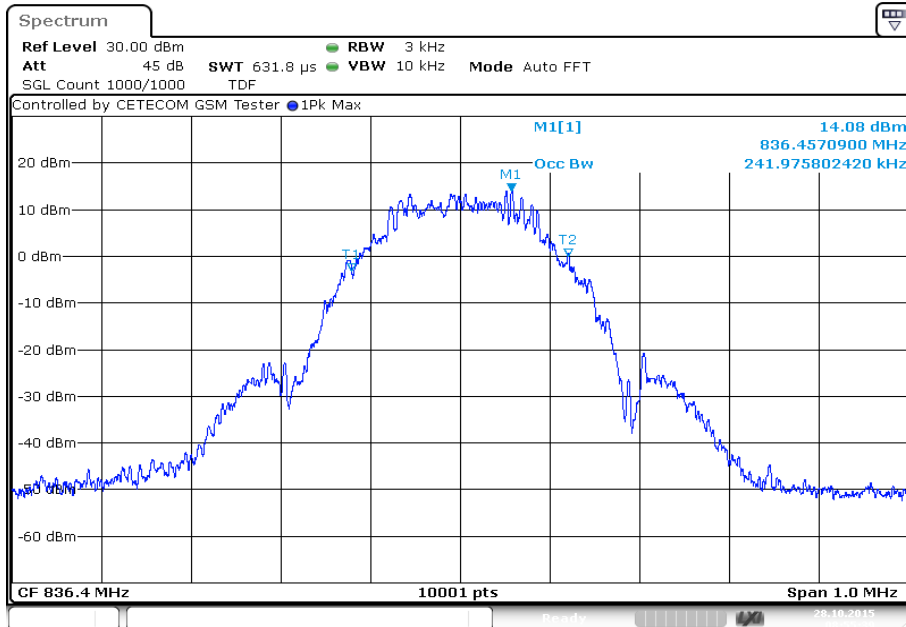

Date: 28.OCT.2015 08:55:39

Plot 4: Channel 189 (-26 dBc BW)

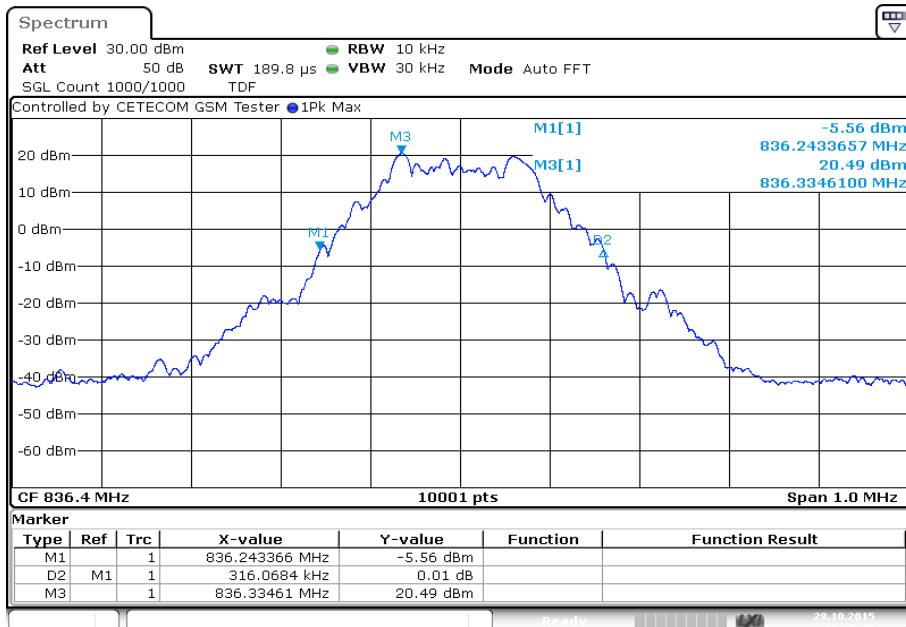

Date: 28.OCT.2015 08:55:45

Plot 5: Channel 251 (99% - OBW)

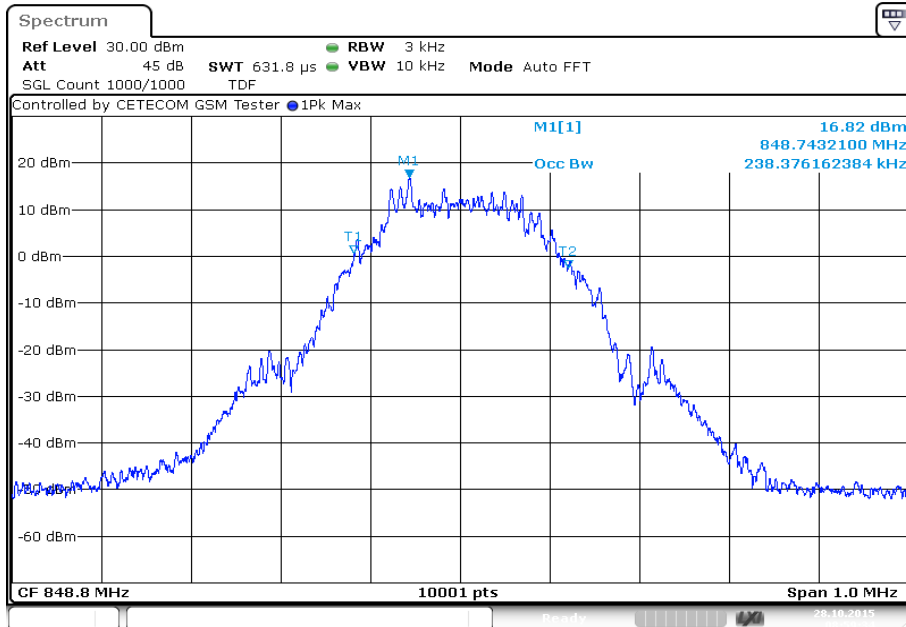

Date: 28.OCT.2015 08:59:34

Plot 6: Channel 251 (-26 dBc BW)

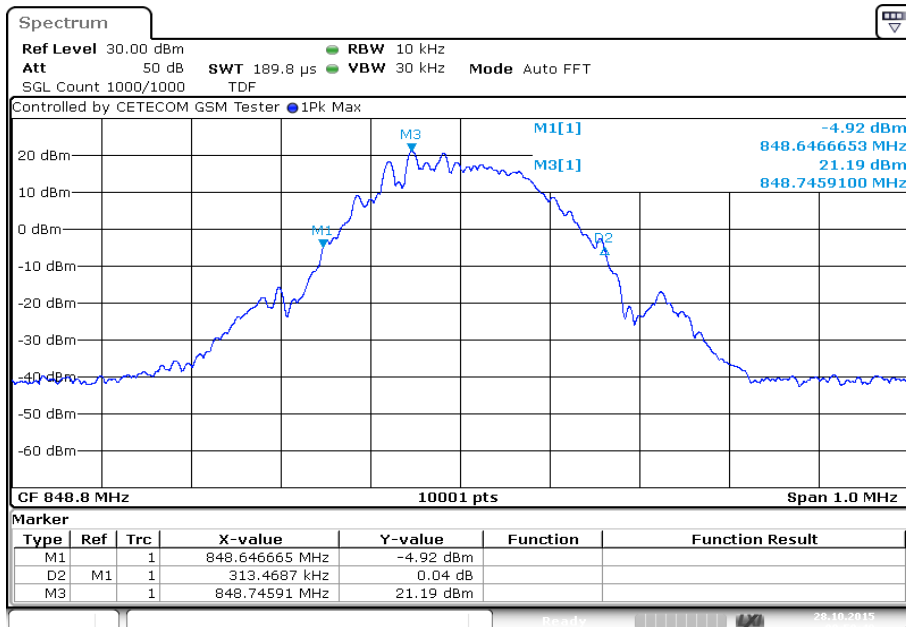

Date: 28.OCT.2015 08:59:40

11.2 Results PCS 1900

All GSM-band measurements are done in GSM mode only (circuit switched). All relevant tests have been repeated using 8-PSK modulation if EDGE mode is supported. All tests were performed with one timeslot in uplink activated and one timeslot in downlink activated. For each mode the highest output power was determined and used.

11.2.1 RF output power

Description:

This paragraph contains average power, peak output power, PAPR and ERP measurements for the mobile station.

The plots in this test report represents only an example of the measurements. All plots of this chapter are available on request.

The red line in the measurements indicates the ideal Gaussian distribution for the measured amplitude range.

Measurement:

The mobile was set up for the maximum output power with pseudo random data modulation.

To determine the Peak-To-Average Power Ratio (PAPR) the measurement was performed with the Power Complementary Cumulative Distribution Function (CCDF).

Measurement parameters	
Detector:	Sample
AQT:	15.6 ms
Resolution bandwidth:	40 MHz
Used equipment:	see chapter 7.1 – A and chapter 7.3 – A
Measurement uncertainty:	see chapter 8

Limits:

FCC	IC
Nominal Peak Output Power	
+33.00 dBm	
In measuring transmissions in this band using an average power technique, the peak-to-average ratio (PAR) of the transmission may not exceed 13 dB.	

Results:

Output Power (conducted) GMSK mode			
Frequency (MHz)	Peak Output Power (dBm)	Average Output Power (dBm)	Peak to Average Ratio (dB) CCDF
1850.2	29.41	28.26	1.14
1880.0	29.24	28.93	0.32
1909.8	29.22	28.91	0.31
Measurement uncertainty	± 0.5 dB		

Output Power (conducted) 8-PSK mode			
Frequency (MHz)	Peak Output Power (dBm)	Average Output Power (dBm)	Peak to Average Ratio (dB) CCDF
1850.2	27.15	22.75	4.40
1880.0	26.80	23.19	3.61
1909.8	28.19	23.64	4.55
Measurement uncertainty	± 0.5 dB		

Output Power (radiated) GMSK mode	
Frequency (MHz)	Average Output Power (dBm) - EIRP
1850.2	26.0
1880.0	25.9
1909.8	27.2
Measurement uncertainty	± 2.0 dB

Output Power (radiated) 8-PSK mode	
Frequency (MHz)	Average Output Power (dBm) - EIRP
1850.2	20.5
1880.0	20.2
1909.8	21.9
Measurement uncertainty	± 2.0 dB

Plots GMSK:

Plot 1: Channel 512

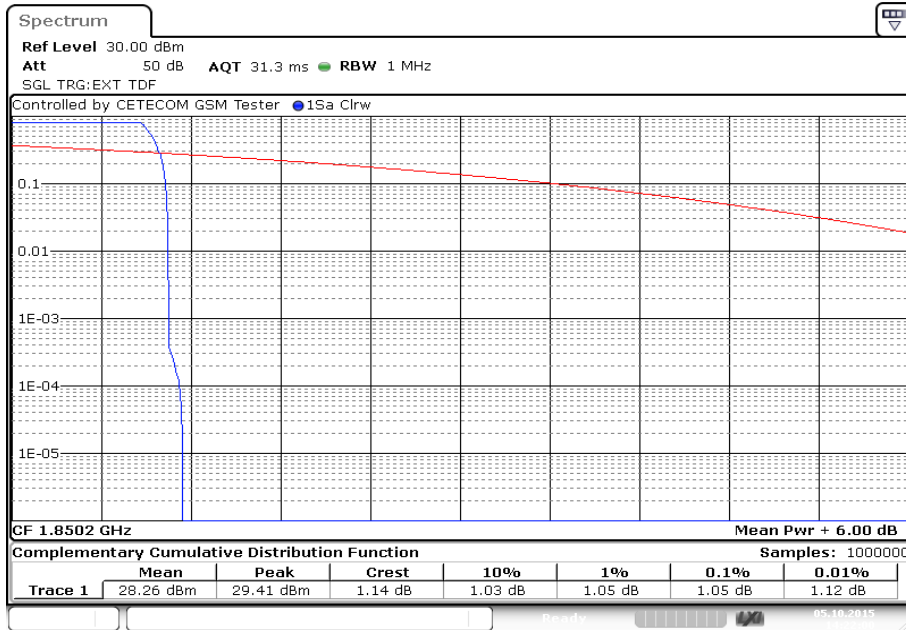

Plot 2: Channel 661

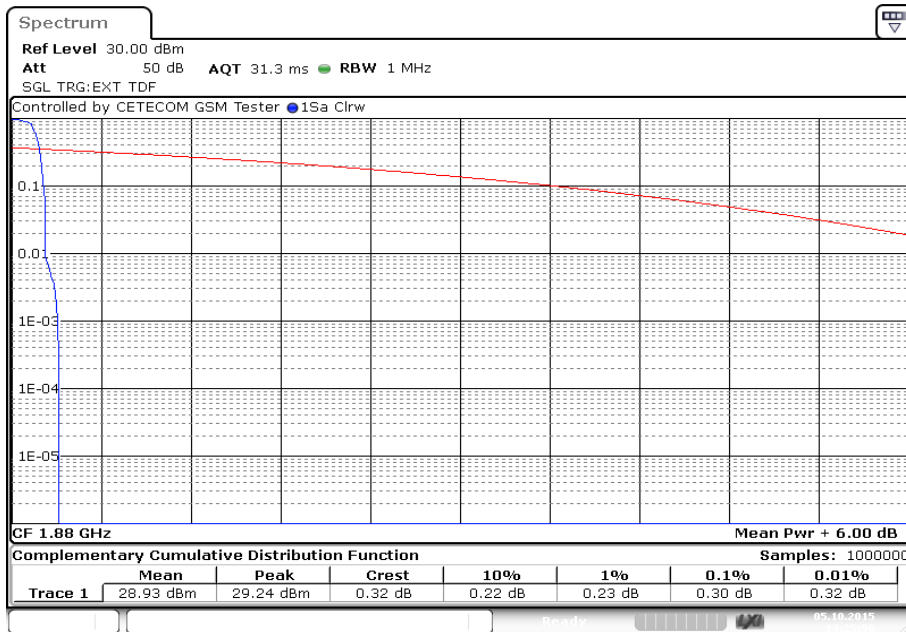

Plot 3: Channel 810

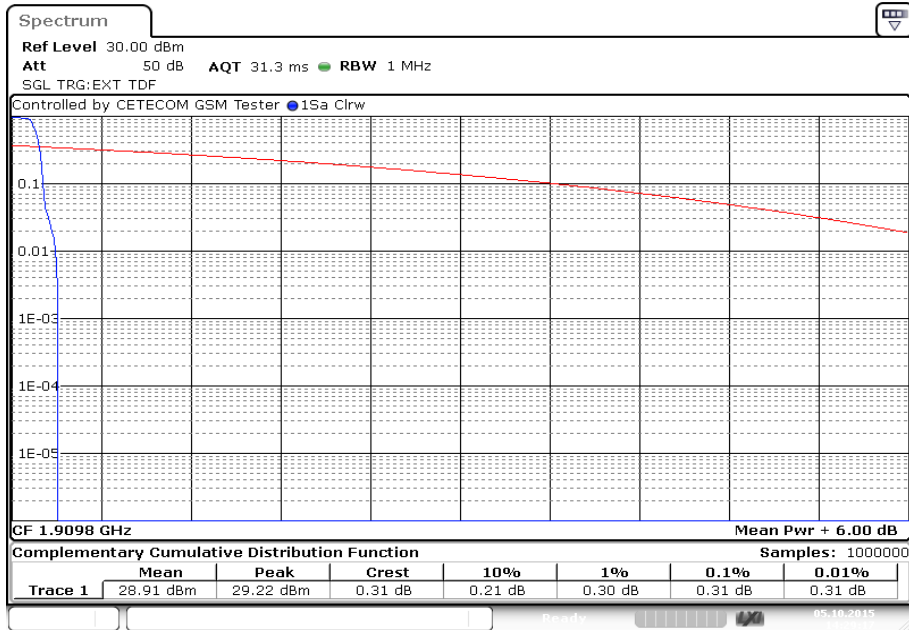

Date: 5.OCT.2015 14:29:17

Plots 8-PSK:

Plot 1: Channel 512

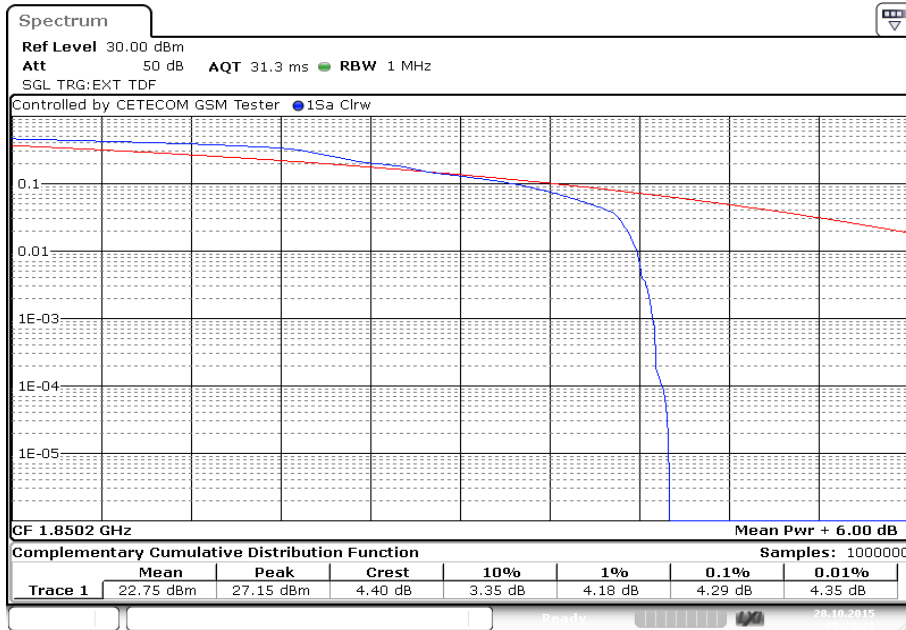

Date: 28.OCT.2015 09:23:21

Plot 2: Channel 661

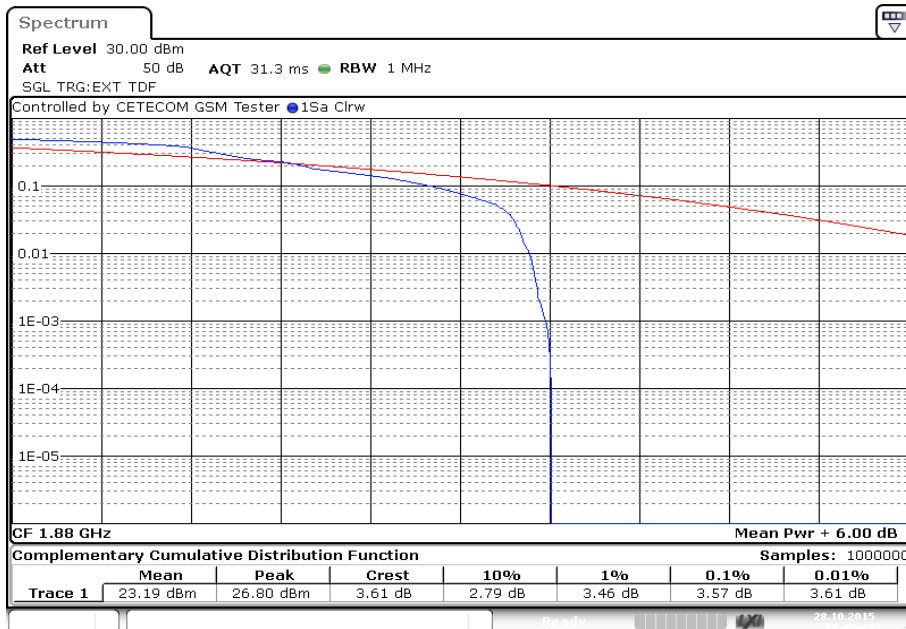

Date: 28.OCT.2015 09:05:13

Plot 3: Channel 810

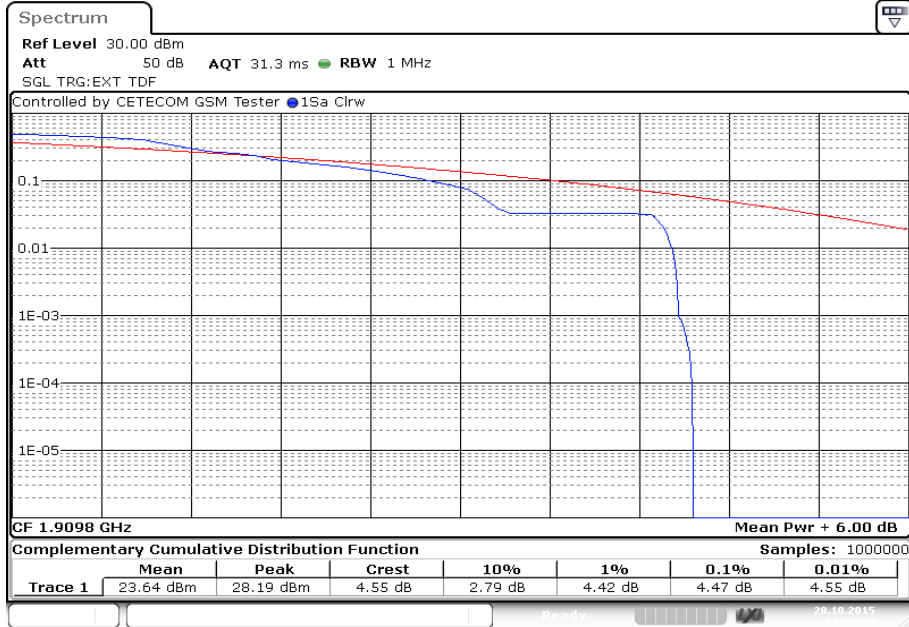

Date: 28.OCT.2015 09:08:33

11.2.2 Frequency stability

Description:

In order to measure the carrier frequency under normal conditions it is necessary to make measurements with the mobile station connected to a R&S CMU200 Wideband Radio Communication Tester.

1. Measure the carrier frequency at room temperature.
2. Subject the mobile station to overnight soak at -30 C.
3. With the mobile station powered with V_{nom} connected to the CMU200 on the centre channel. Measure the carrier frequency. These measurements should be made within two minutes of powering up the mobile station to prevent significant self warming.
4. Repeat the above measurements at 10°C increments from -30°C to +50°C. Allow at least 15 minutes at each temperature unpowered before making measurements.
5. At all temperature levels hold the temperature to +/- 0.5°C during the measurement procedure.

Measurement:

Measurement parameters	
Detector:	Measured with CMU200
Sweep time:	
Video bandwidth:	
Resolution bandwidth:	
Span:	
Trace-Mode:	
Test setup:	see chapter chapter 7.3 – B
Measurement uncertainty:	see chapter 8

Limits:

FCC	IC
Frequency Stability	
The frequency stability shall be sufficient to ensure that the fundamental emission stays within the authorized frequency block.	

Results:**FREQ ERROR versus VOLTAGE**

Voltage (V)	Frequency Error (Hz)	Frequency Error (%)	Frequency Error (ppm)
3.8*	-8	-0.00000043	-0.0043

* The module requires an external stabilized power supply.

FREQ ERROR versus TEMPERATURE

Temperature (°C)	Frequency Error (Hz)	Frequency Error (%)	Frequency Error (ppm)
-30	-16	-0.00000085	-0.0085
-20	-11	-0.00000059	-0.0059
-10	-12	-0.00000064	-0.0064
± 0	-12	-0.00000064	-0.0064
10	-13	-0.00000069	-0.0069
20	-13	-0.00000069	-0.0069
30	-14	-0.00000074	-0.0074
40	-15	-0.00000080	-0.0080
50	-16	-0.00000085	-0.0085

11.2.3 Spurious emissions radiated

Description:

The following steps outline the procedure used to measure the radiated emissions from the mobile station. The site is constructed in accordance with ANSI C63.4:2009 requirements and is recognized by the FCC to be in compliance for a 3 and a 10 meter site. The spectrum was scanned from 30 MHz to the 10th harmonic of the highest frequency generated within the equipment, which is the transmitted carrier that can be as high as 1910 MHz. Measurement made up to 25 GHz. The resolution bandwidth is set as outlined in Part 24.238. The spectrum was scanned with the mobile station transmitting at carrier frequencies that pertain to low, mid and high channels of the PCS1900 band.

Measurement:

Measurement parameters	
Detector:	Peak
Sweep time:	2 sec.
Video bandwidth:	Below 1 GHz: 100 kHz Above 1 GHz: 1 MHz
Resolution bandwidth:	Below 1 GHz: 100 kHz Above 1 GHz: 1 MHz
Span:	100 MHz Steps
Trace-Mode:	Max Hold
Used equipment:	see chapter 7.1 – A & 7.2A
Measurement uncertainty:	see chapter 8

Limits:

FCC	IC
Spurious Emissions Radiated	
Attenuation $\geq 43 + 10\log(P)$ (P, Power in Watts)	
-13 dBm	

Results GPRS & EGPRS:

Radiated emissions measurements were made only at the upper, center, and lower carrier frequencies of the PCS1900 band (1850.2 MHz, 1880.0 MHz and 1909.8 MHz). It was decided that measurements at these three carrier frequencies would be sufficient to demonstrate compliance with emissions limits because it was seen that all the significant spurs occur well outside the band and no radiation was seen from a carrier in one block of the PCS1900 band into any of the other blocks. The equipment must still, however, meet emissions requirements with the carrier at all frequencies over which it is capable of operating and it is the manufacturer's responsibility to verify this.

The final open field radiated levels are presented on the next pages. All measurements were done in horizontal and vertical polarization; the plots show the worst case. The plots show only the middle channel. If spurious were detected, the lowest and highest channel were checked too. The found values are stated in the table below.

As can be seen from this data, the emissions from the test item were within the specification limit.

Spurious Emission Level (dBm)								
Harmonic	Ch. 512 Freq. (MHz)	Level [dBm]	Harmonic	Ch. 661 Freq. (MHz)	Level [dBm]	Harmonic	Ch. 810 Freq. (MHz)	Level [dBm]
2	3700.4	-	2	3760.0	-	2	3819.6	-
3	5550.6	-	3	5640.0	-	3	5729.4	-
4	7400.8	-	4	7520.0	-	4	7639.2	-
5	9251.0	-	5	9400.0	-	5	9549.0	-
6	11101.2	-	6	11280.0	-	6	11458.8	-
7	12951.4	-	7	13160.0	-	7	13368.6	-
8	14801.6	-	8	15040.0	-	8	15278.4	-
9	16651.8	-	9	16920.0	-	9	17188.2	-
10	18502.0	-	10	18800.0	-	10	19098.0	-
Measurement uncertainty					± 3dB			

Plots GMSK:

Plot 1: Channel 661 (Traffic mode up to 30 MHz)

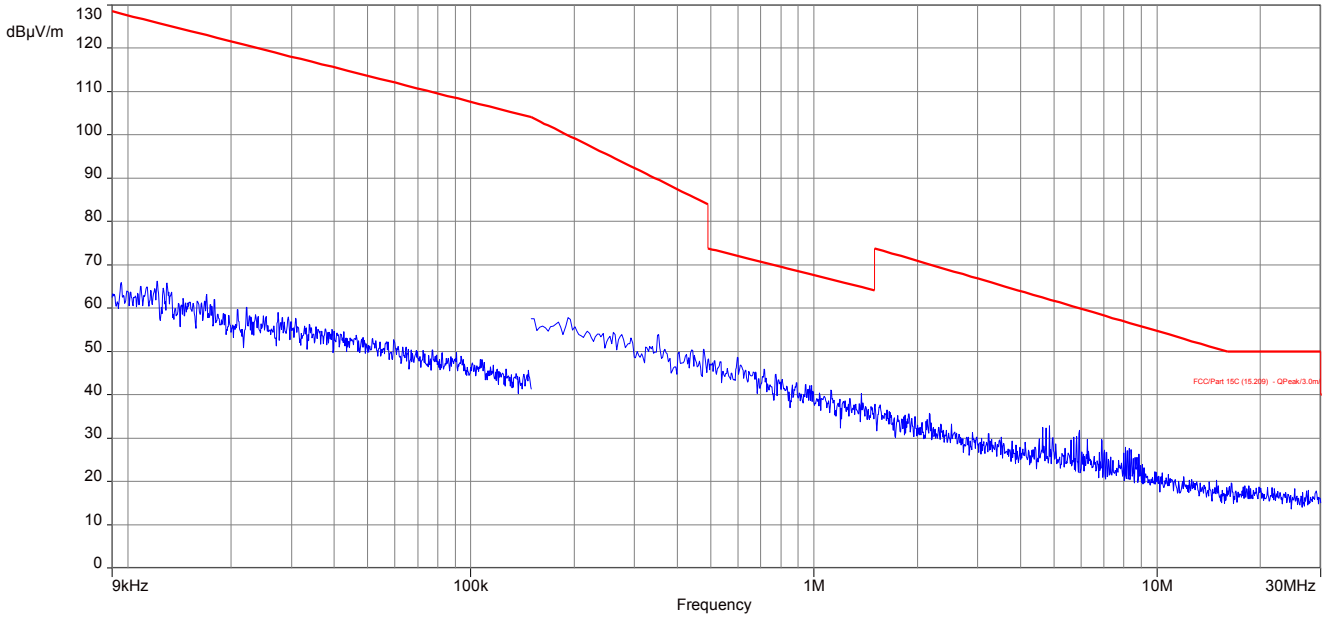

Plot 2: Channel 661 (30 MHz – 12.75 GHz)

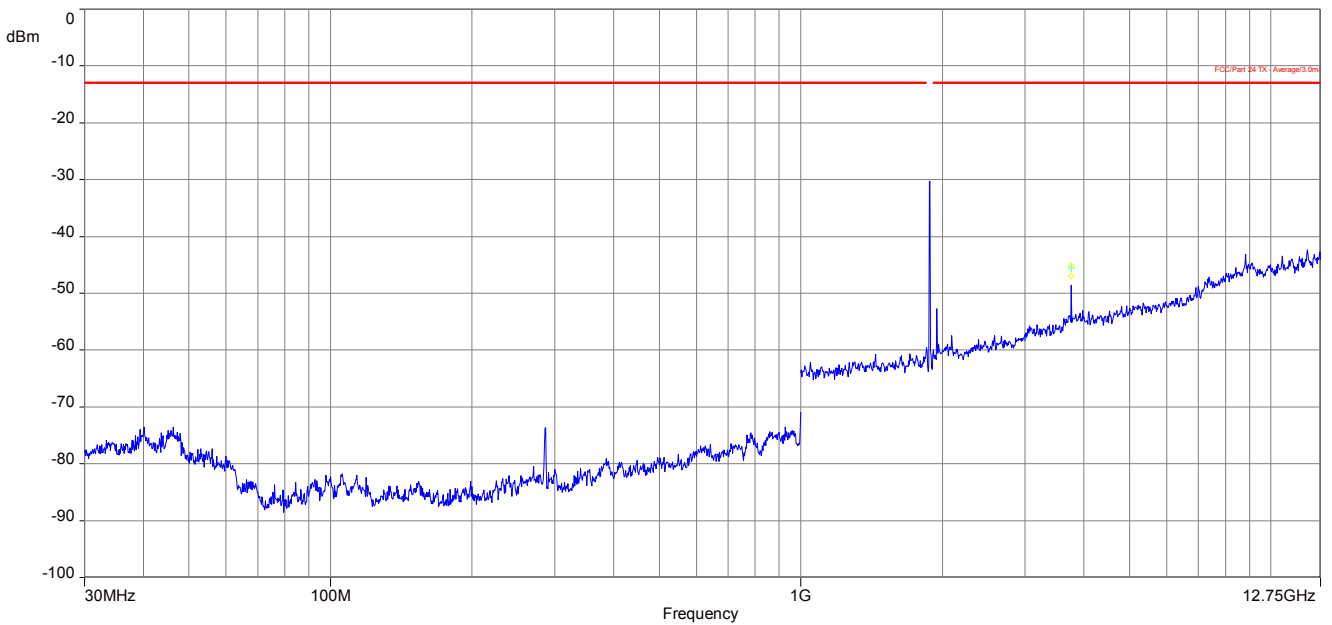

Carrier notched with 1.9 GHz rejection filter

Plot 3: Channel 661 (12 GHz - 18 GHz)

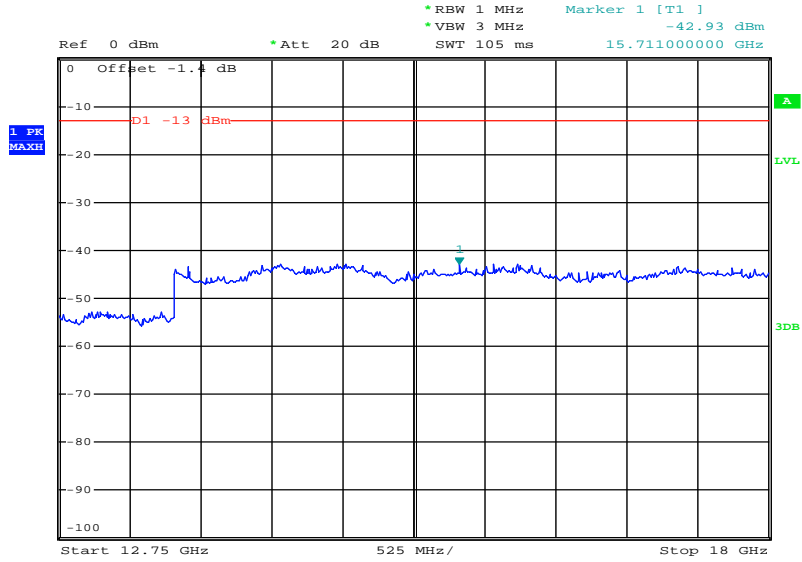

Date: 30.OCT.2015 12:01:20

Plot 4: Channel 661 (18 GHz - 26 GHz)

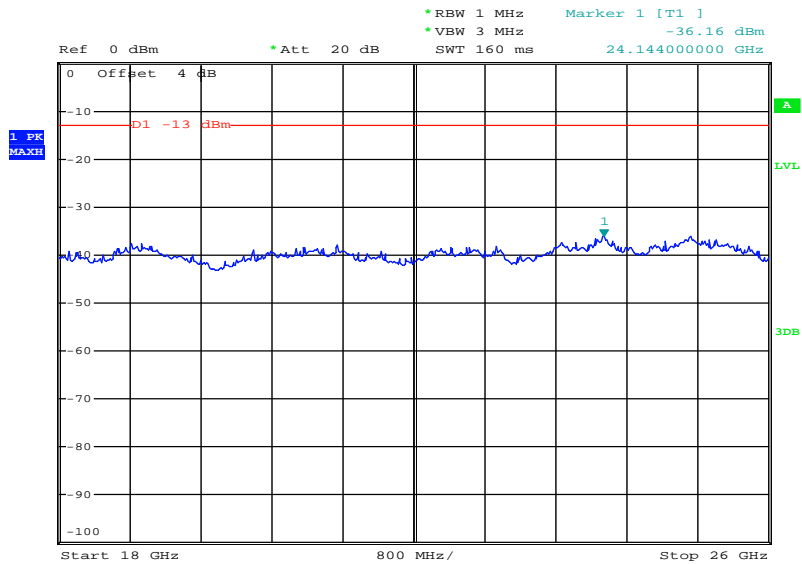

Date: 30.OCT.2015 12:02:51

Plots 8-PSK:

Plot 1: Channel 661 (Traffic mode up to 30 MHz)

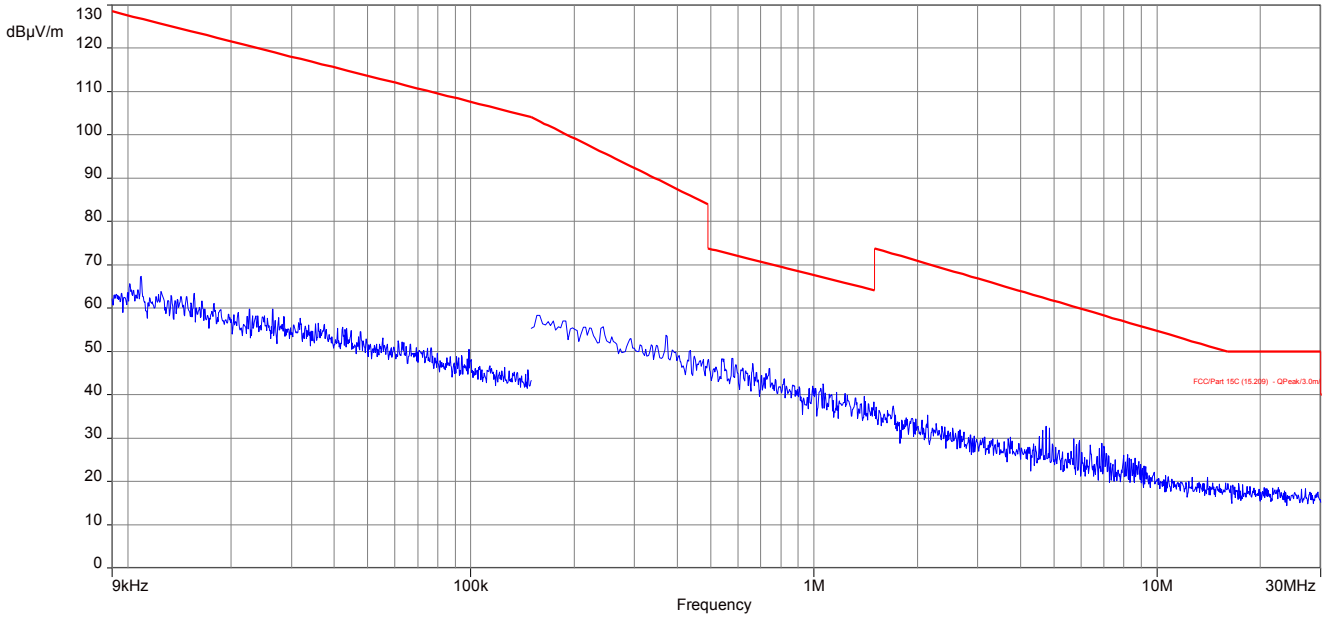

Plot 2: Channel 661 (30 MHz – 12.75 GHz)

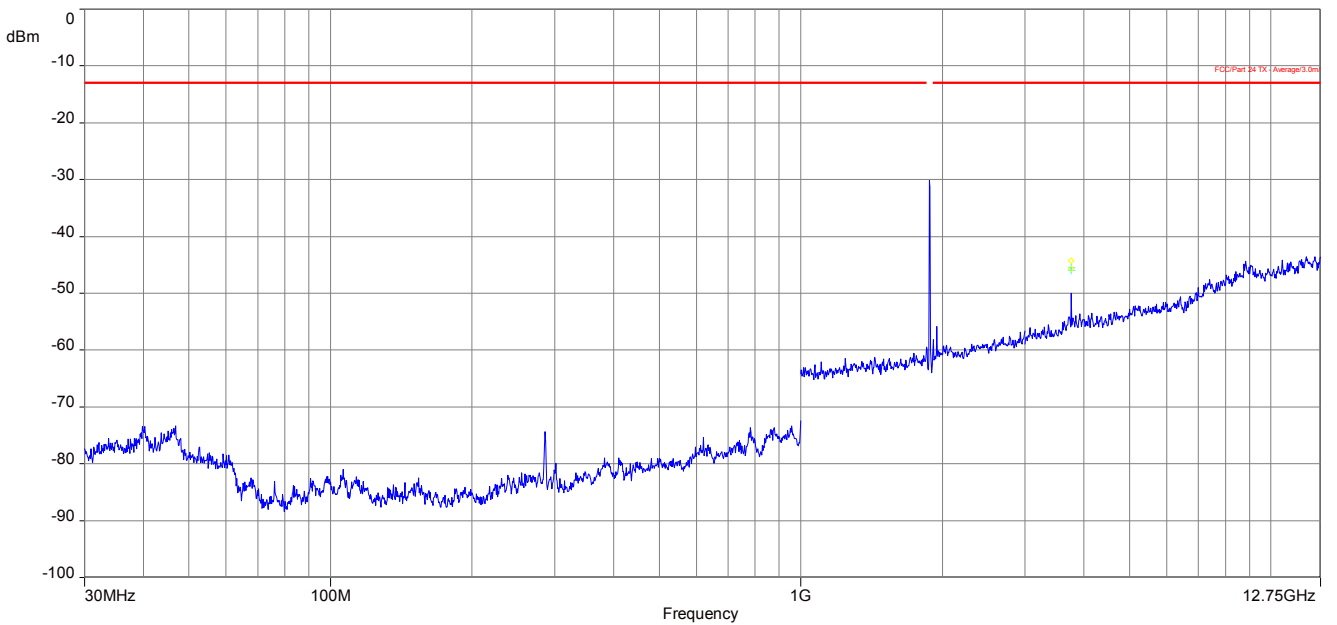

Carrier notched with 1.9 GHz rejection filter

Plot 3: Channel 661 (12 GHz - 18 GHz)

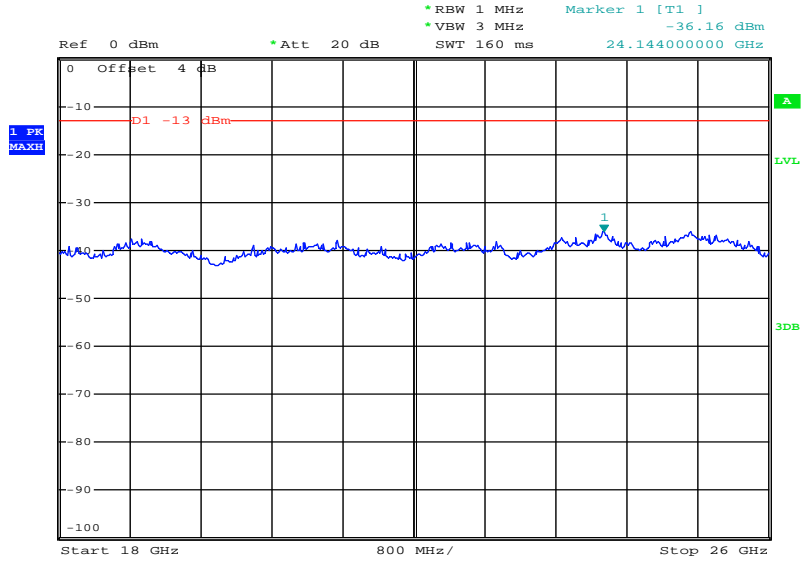

Date: 30.OCT.2015 12:02:51

Plot 4: Channel 661 (18 GHz - 26 GHz)

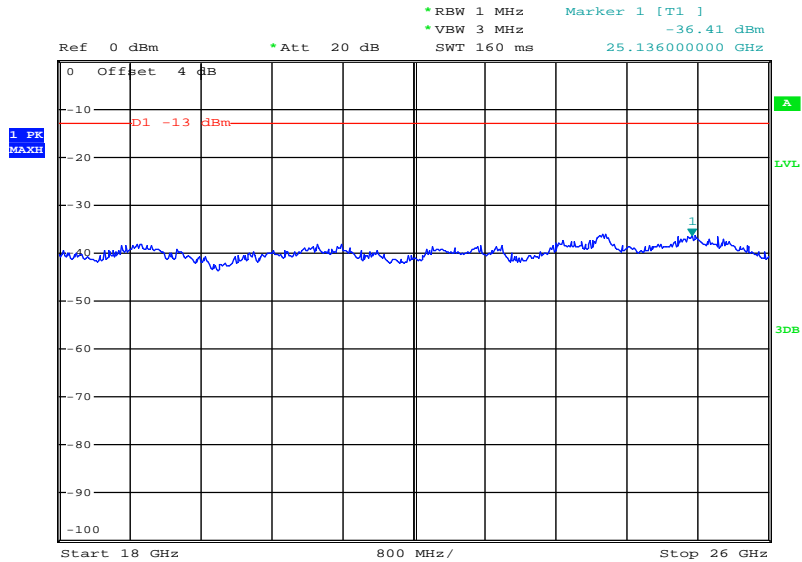

Date: 30.OCT.2015 12:02:30

11.2.4 Spurious emissions conducted

Description:

The following steps outline the procedure used to measure the conducted emissions from the mobile station.

1. Determine frequency range for measurements: From CFR 2.1057 the spectrum should be investigated from the lowest radio frequency generated in the equipment up to at least the 10th harmonic of the carrier frequency. For the mobile station equipment tested, this equates to a frequency range of 13 MHz to 19.1 GHz, data taken from 10 MHz to 25 GHz.
2. Determine mobile station transmits frequencies: below outlines the band edge frequencies pertinent to conducted emissions testing.

PCS1900 Transmitter Channel Frequency
 512 1850.2 MHz
 661 1880.0 MHz
 810 1909.8 MHz

Measurement:

Measurement parameters	
Detector:	Peak
Sweep time:	Auto
Video bandwidth:	Pre-measurement with 1 MHz On spurious detection re-measurement below 1 GHz with 100 kHz Above 1 GHz with 1 MHz
Resolution bandwidth:	Pre-measurement with 1 MHz On spurious detection re-measurement below 1 GHz with 100 kHz Above 1 GHz with 1 MHz
Span:	10 MHz – 26 GHz
Trace-Mode:	Max Hold
Used equipment:	see chapter 7.3 - A
Measurement uncertainty:	see chapter 8

Limits:

FCC	IC
Spurious Emissions Conducted	
Attenuation $\geq 43 + 10\log(P)$ (P, Power in Watts)	
-13 dBm	

Results GMSK & 8-PSK:

Spurious Emission Level (dBm)								
Harmonic	Ch. 512 Freq. (MHz)	Level [dBm]	Harmonic	Ch. 661 Freq. (MHz)	Level [dBm]	Harmonic	Ch. 810 Freq. (MHz)	Level [dBm]
2	3700.4	-	2	3760.0	-	2	3819.6	-
3	5550.6	-	3	5640.0	-	3	5729.4	-
4	7400.8	-	4	7520.0	-	4	7639.2	-
5	9251.0	-	5	9400.0	-	5	9549.0	-
6	11101.2	-	6	11280.0	-	6	11458.8	-
7	12951.4	-	7	13160.0	-	7	13368.6	-
8	14801.6	-	8	15040.0	-	8	15278.4	-
9	16651.8	-	9	16920.0	-	9	17188.2	-
10	18502.0	-	10	18800.0	-	10	19098.0	-
Measurement uncertainty					± 3dB			

Plots GMSK:

Plot 1: Channel 512 (10 MHz - 26 GHz)

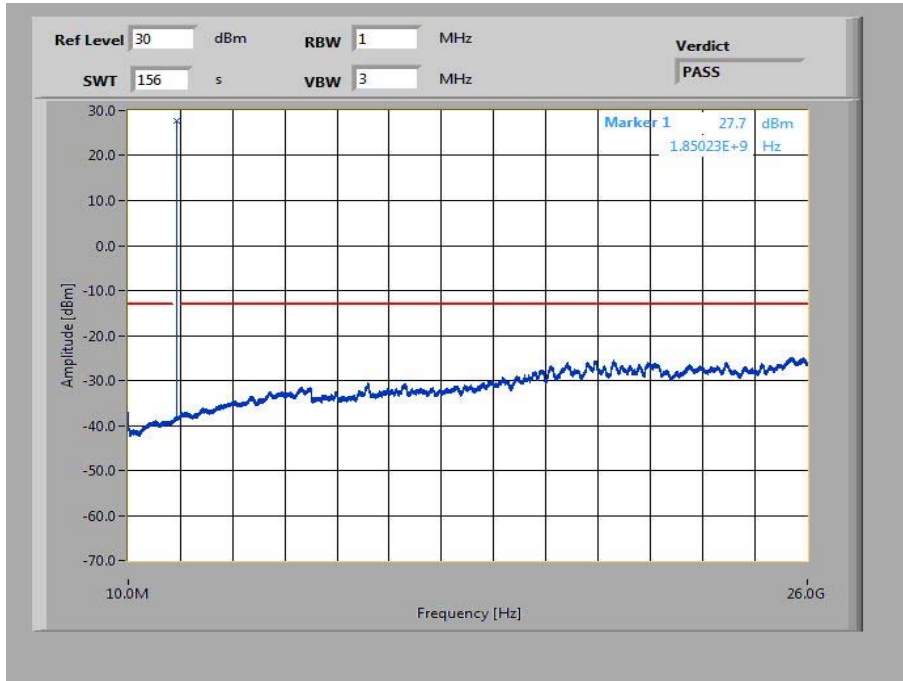

Plot 2: Channel 661 (10 MHz - 26 GHz)

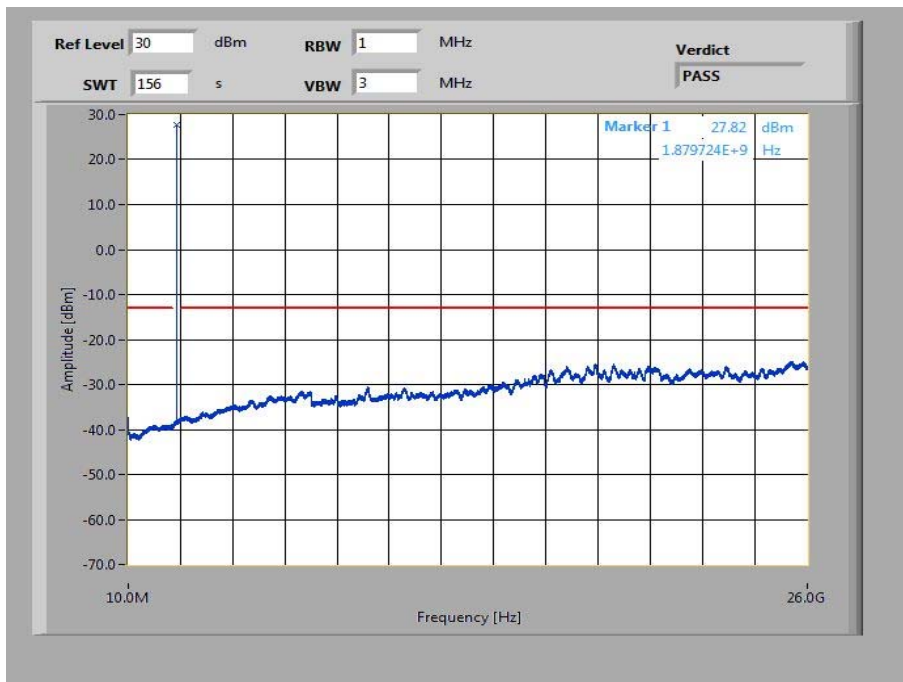

Plot 3: Channel 810 (10 MHz - 26 GHz)

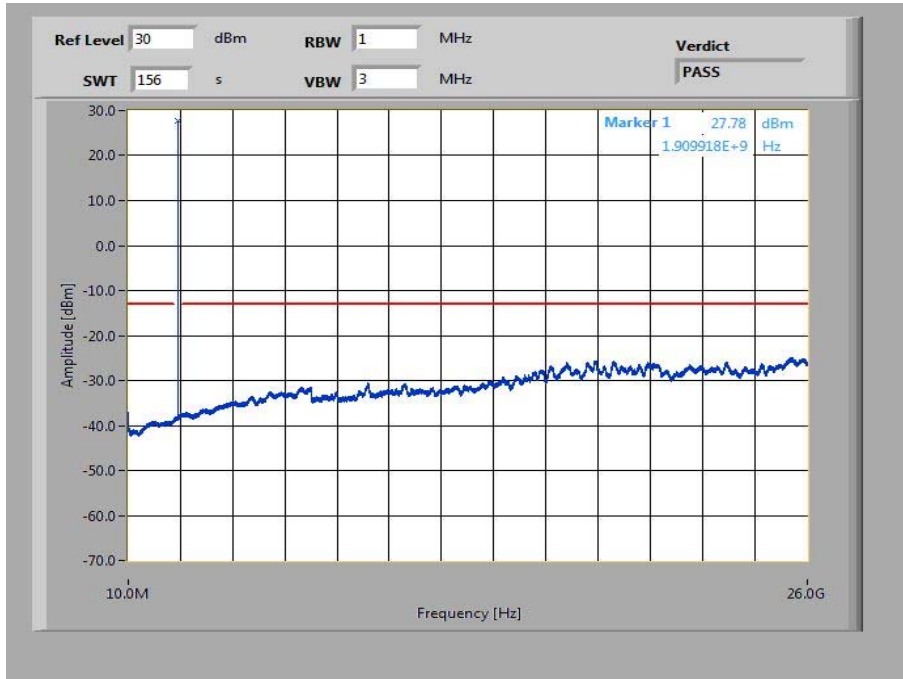

Plots 8-PSK:

Plot 1: Channel 512 (10 MHz - 26 GHz)

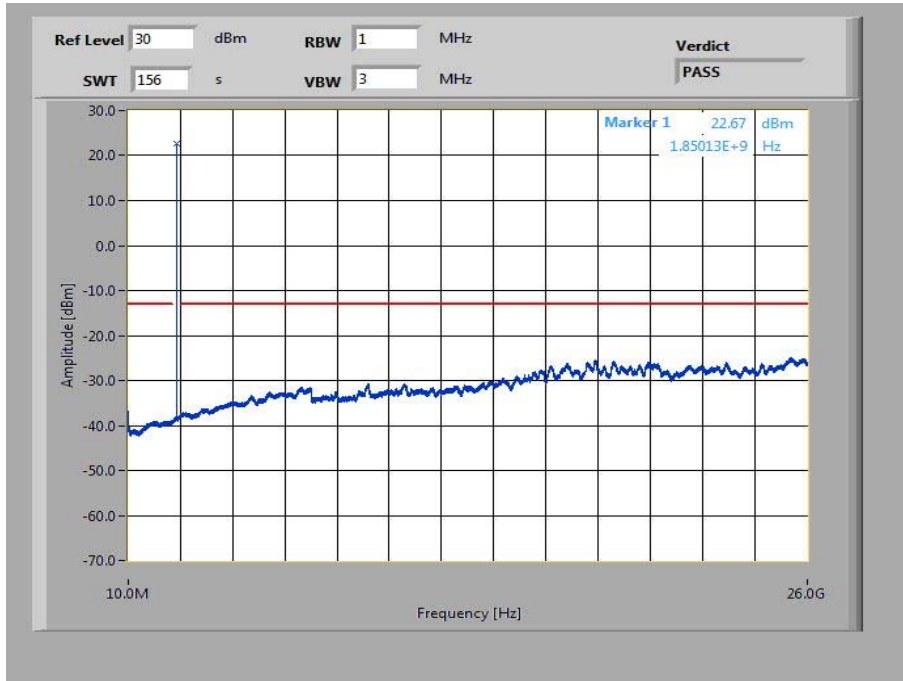

Plot 2: Channel 661 (10 MHz - 26 GHz)

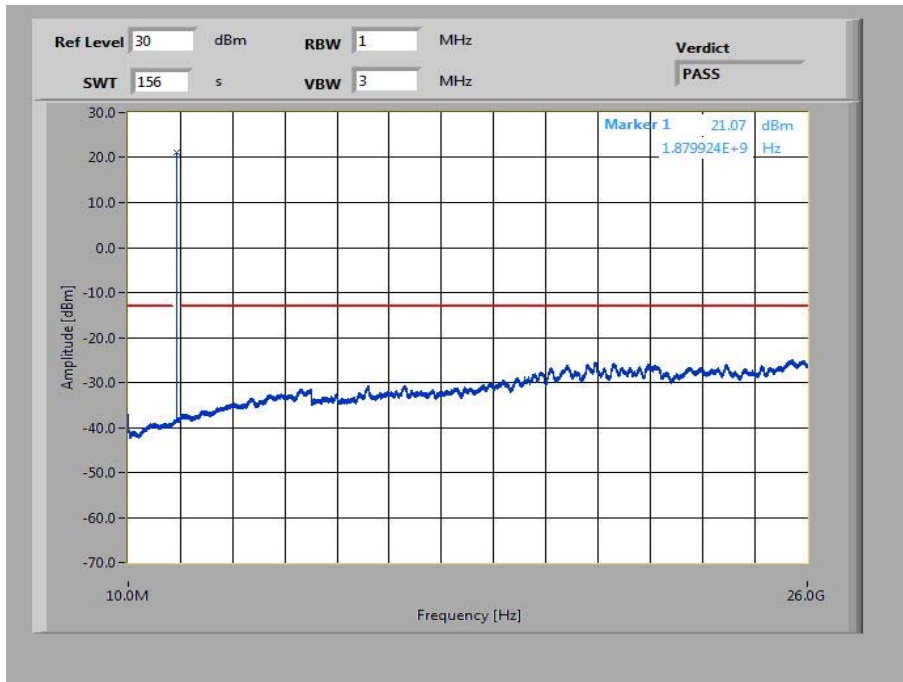

Plot 3: Channel 810 (10 MHz - 26 GHz)

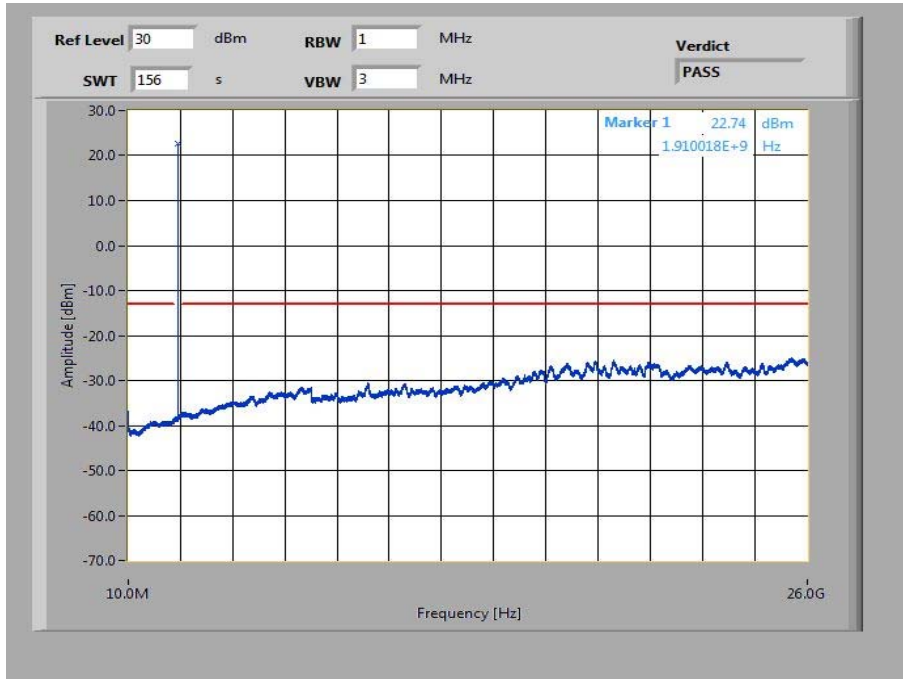

11.2.5 Block edge compliance

Description:

The spectrum at the band edges must comply with the spurious emissions limits.

Measurement:

Measurement parameters	
Detector:	RMS
Sweep time:	30 sec.
Video bandwidth:	1% - 5% of the OBW
Resolution bandwidth:	$\geq 3 \times \text{RBW}$
Span:	5 MHz
Trace-Mode:	Max Hold
Used equipment:	see chapter 7.3 - A
Measurement uncertainty:	see chapter 8

Limits:

FCC	IC
Block Edge Compliance	
Attenuation $\geq 43 + 10\log(P)$ (P, Power in Watts)	
-13 dBm	

Plots GMSK:

Plot 1: Channel 512

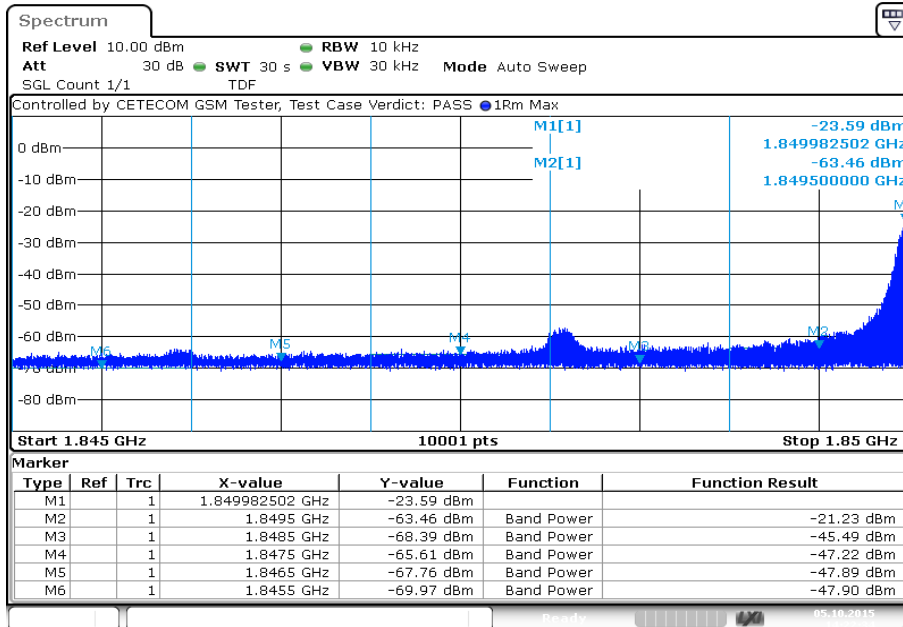

Date: 5.OCT.2015 14:22:34

Plot 2: Channel 810

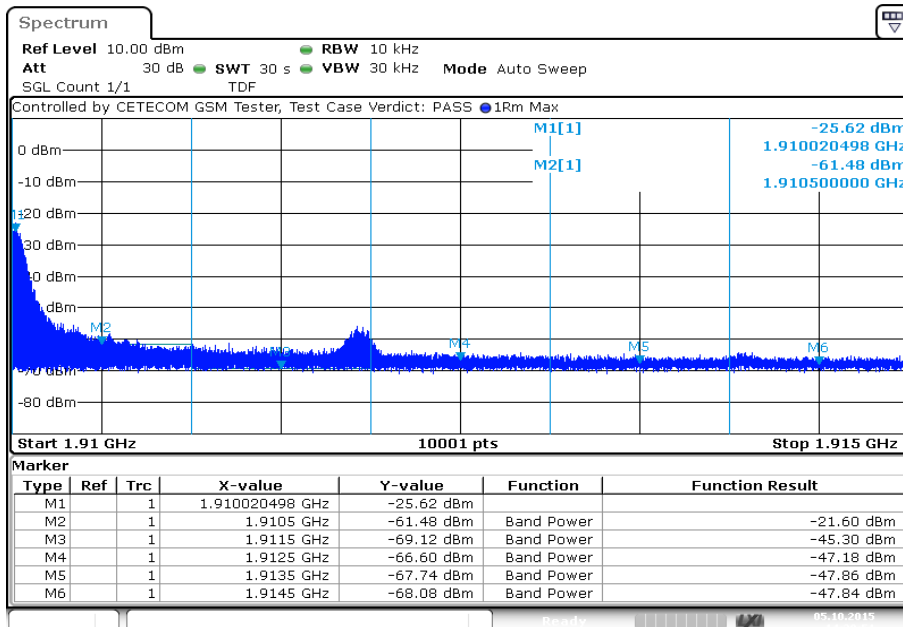

Date: 5.OCT.2015 14:29:51

Plots 8-PSK:

Plot 1: Channel 512

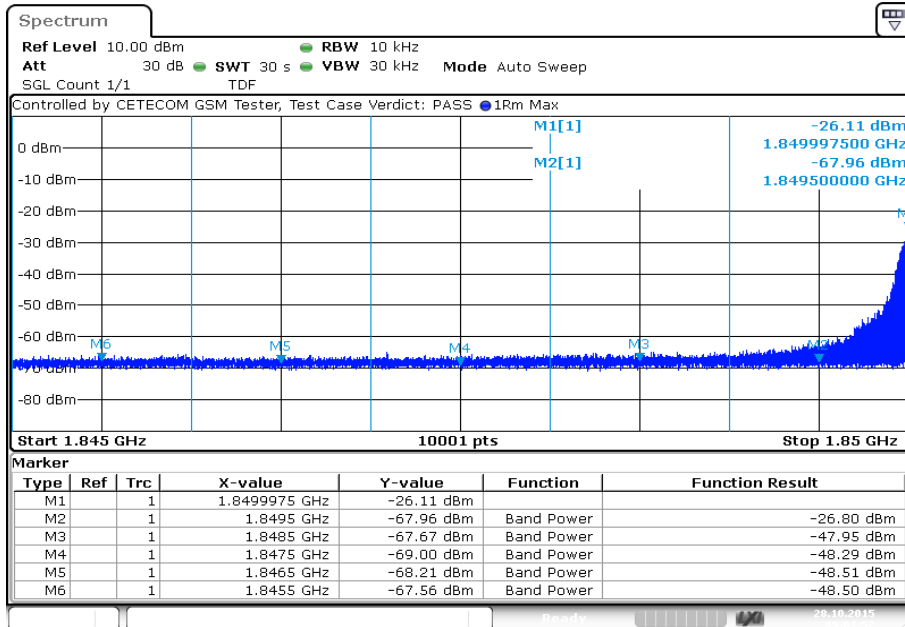

Date: 28.OCT.2015 09:01:52

Plot 2: Channel 810

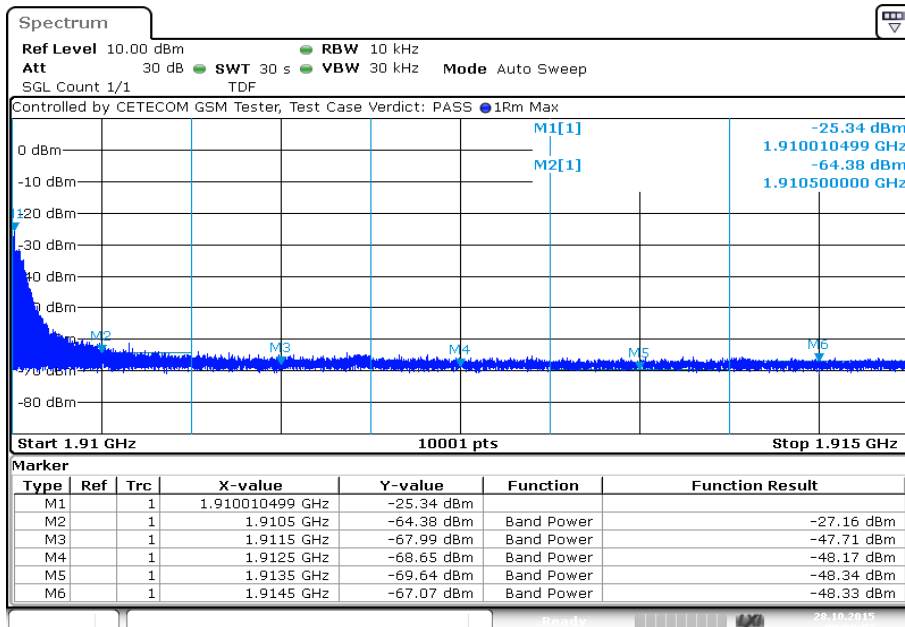

Date: 28.OCT.2015 09:09:07

11.2.6 Occupied bandwidth

Description:

Measurement of the occupied bandwidth of the transmitted signal.

Measurement:

Similar to conducted emissions, occupied bandwidth measurements are only provided for selected frequencies in order to reduce the amount of submitted data. Data were taken at the extreme and mid frequencies of the PCS1900 frequency band. The table below lists the measured 99% power and -26dBc occupied bandwidths. Spectrum analyzer plots are included on the following pages.

Measurement parameters	
Detector:	Peak
Sweep time:	Auto
Resolution bandwidth:	1% - 5% of the OBW
Video bandwidth:	≥ 3xRBW
Span:	2 x nominal BW
Trace-Mode:	Max Hold
Used equipment:	see chapter 7.3-A
Measurement uncertainty:	see chapter 8

Limits:

FCC	IC
Occupied Bandwidth	
Spectrum must fall completely in the specified band	

Results:

Occupied Bandwidth - GMSK mode		
Frequency (MHz)	99% OBW (kHz)	-26 dBc BW (kHz)
1850.2	246.88	321.18
1880.0	242.68	316.57
1909.8	245.98	320.97
Measurement uncertainty	± 3 kHz	

Occupied Bandwidth – 8-PSK mode		
Frequency (MHz)	99% OBW (kHz)	-26 dBc BW (kHz)
1850.2	241.08	306.87
1880.0	240.88	315.57
1909.8	242.48	316.37
Measurement uncertainty	± 3 kHz	

Plots GSMK:

Plot 1: Channel 512 (99% - OBW)

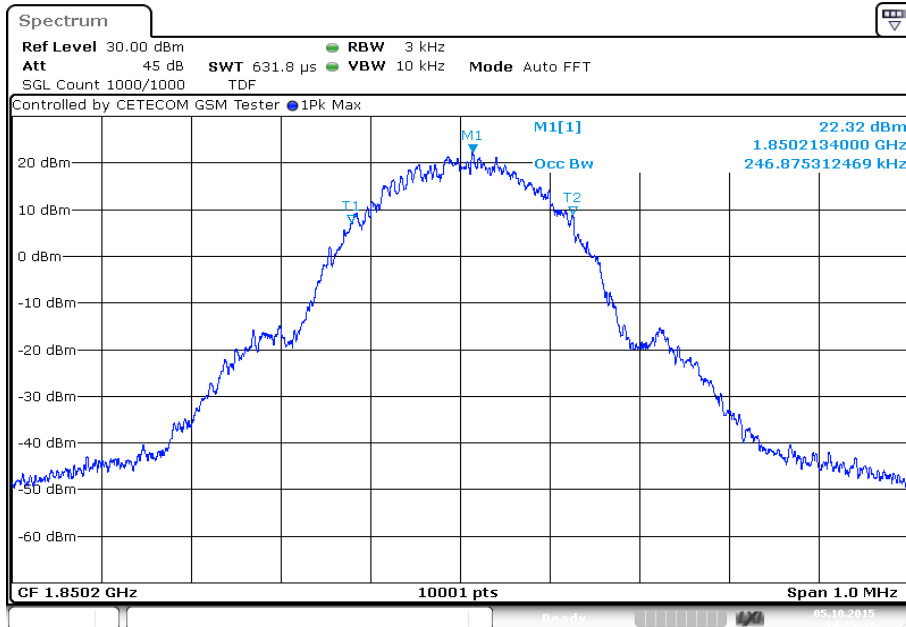

Date: 5.OCT.2015 14:25:41

Plot 2: Channel 512 (-26 dBc BW)

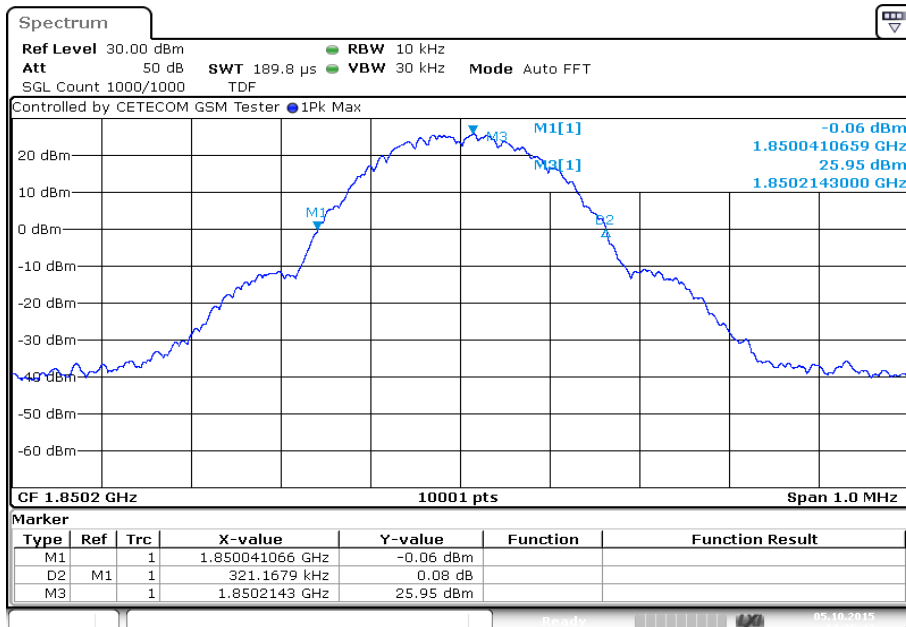

Date: 5.OCT.2015 14:25:47

Plot 3: Channel 661 (99% - OBW)

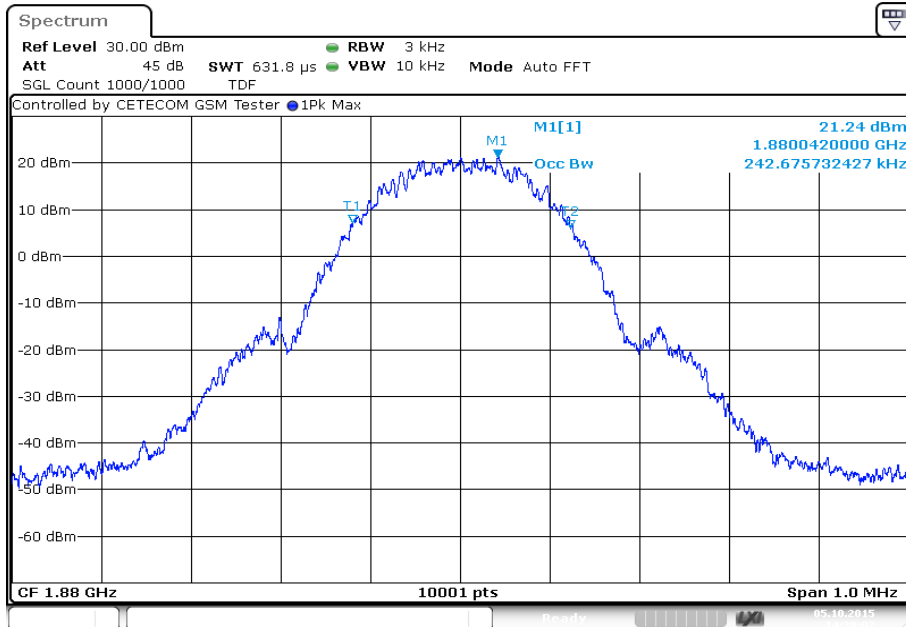

Date: 5.OCT.2015 14:29:02

Plot 4: Channel 661 (-26 dBc BW)

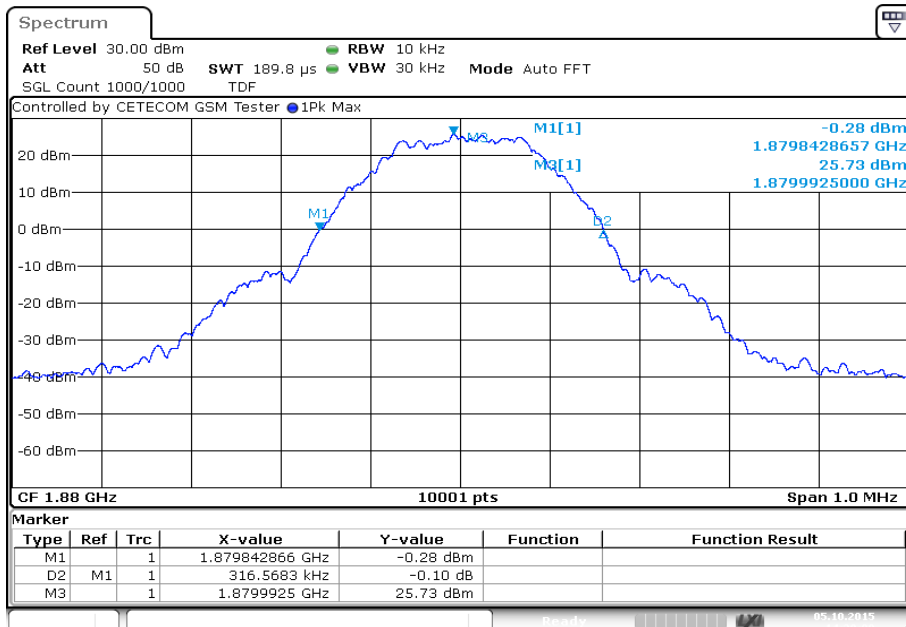

Date: 5.OCT.2015 14:29:08

Plot 5: Channel 810 (99% - OBW)

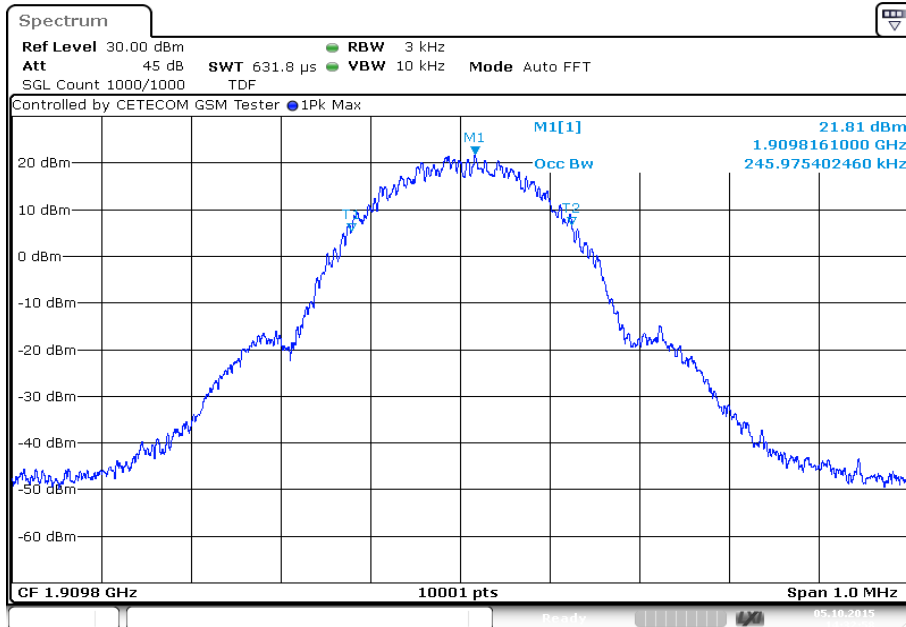

Date: 5.OCT.2015 14:32:58

Plot 6: Channel 810 (-26 dBc BW)

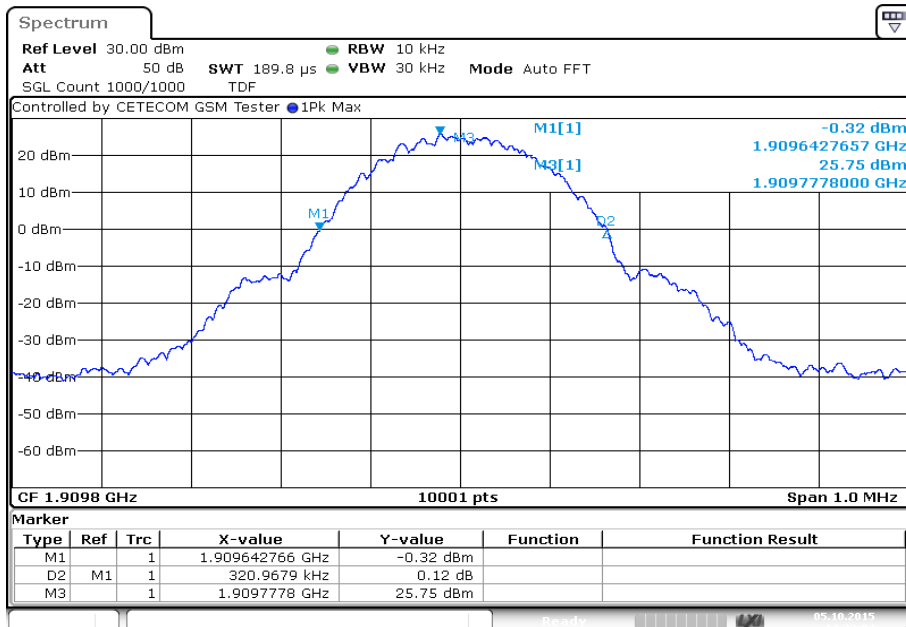

Date: 5.OCT.2015 14:33:04

Plots 8-PSK:

Plot 1: Channel 512 (99% - OBW)

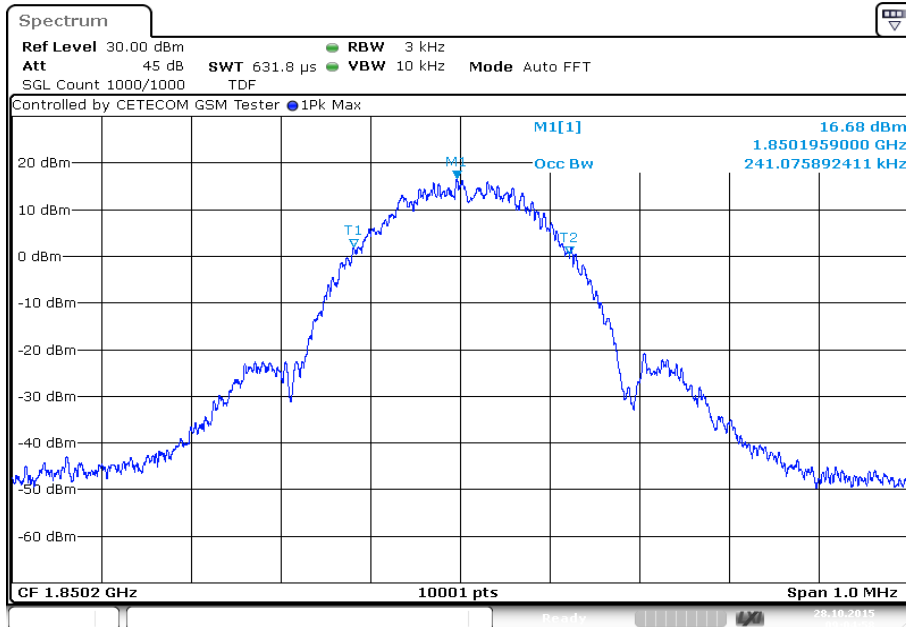

Date: 28.OCT.2015 09:04:58

Plot 2: Channel 512 (-26 dBc BW)

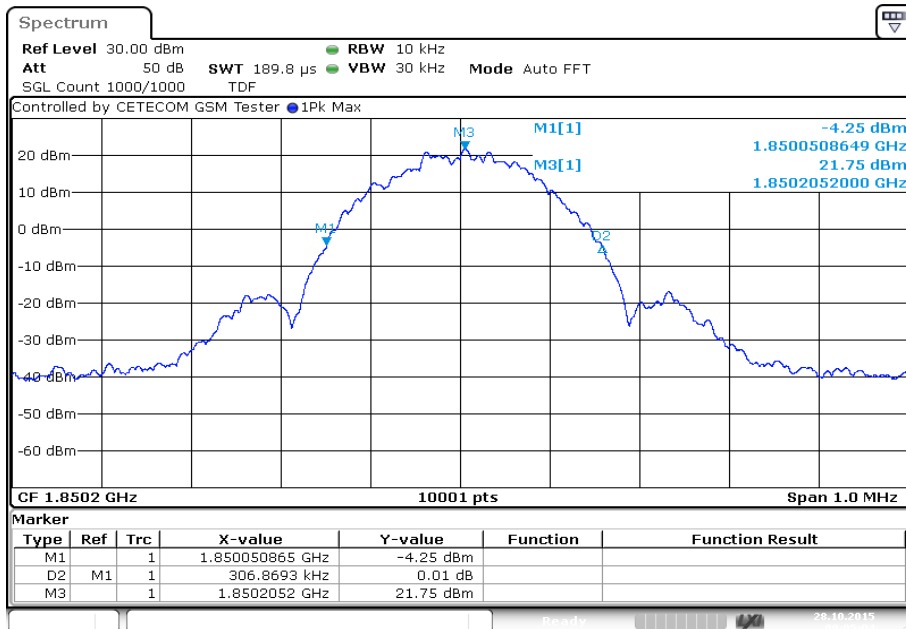

Date: 28.OCT.2015 09:05:04

Plot 3: Channel 661 (99% - OBW)

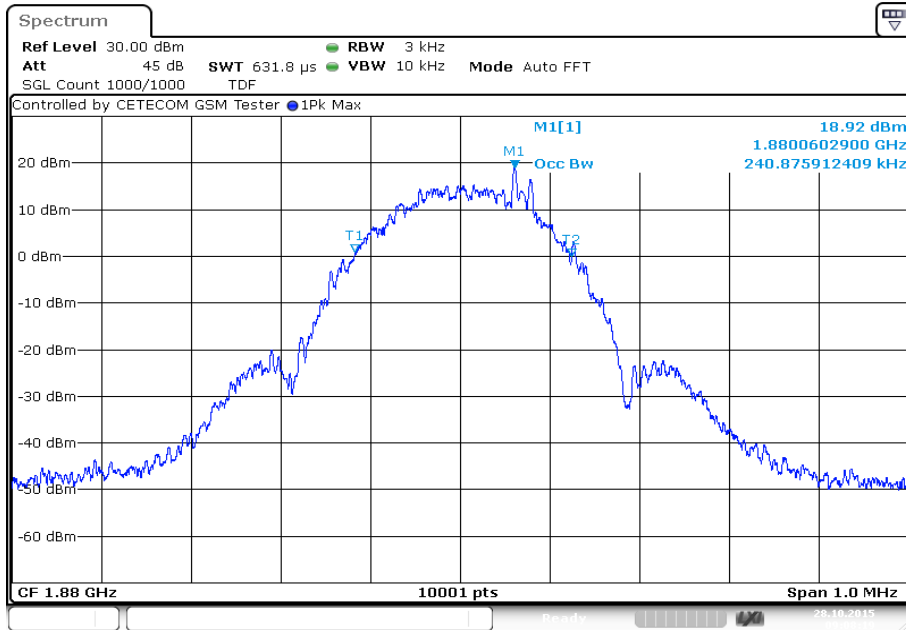

Date: 28.OCT.2015 09:08:19

Plot 4: Channel 661 (-26 dBc BW)

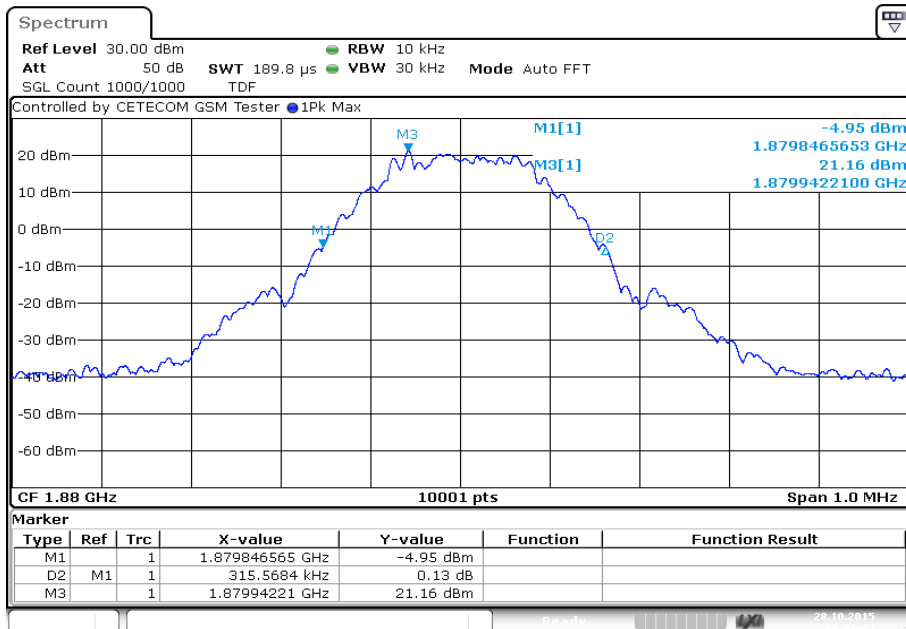

Date: 28.OCT.2015 09:08:24

Plot 5: Channel 810 (99% - OBW)

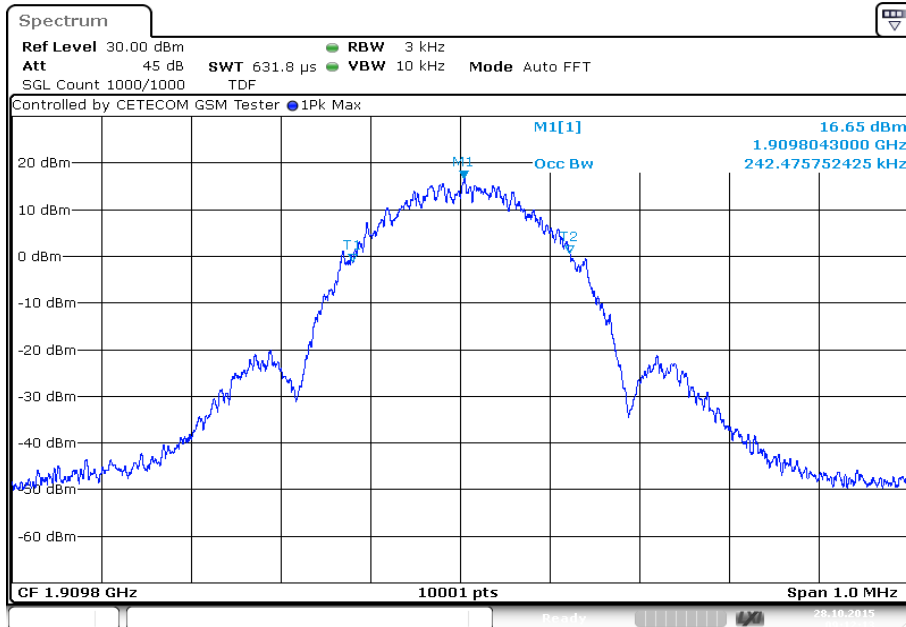

Date: 28.OCT.2015 09:12:13

Plot 6: Channel 810 (-26 dBc BW)

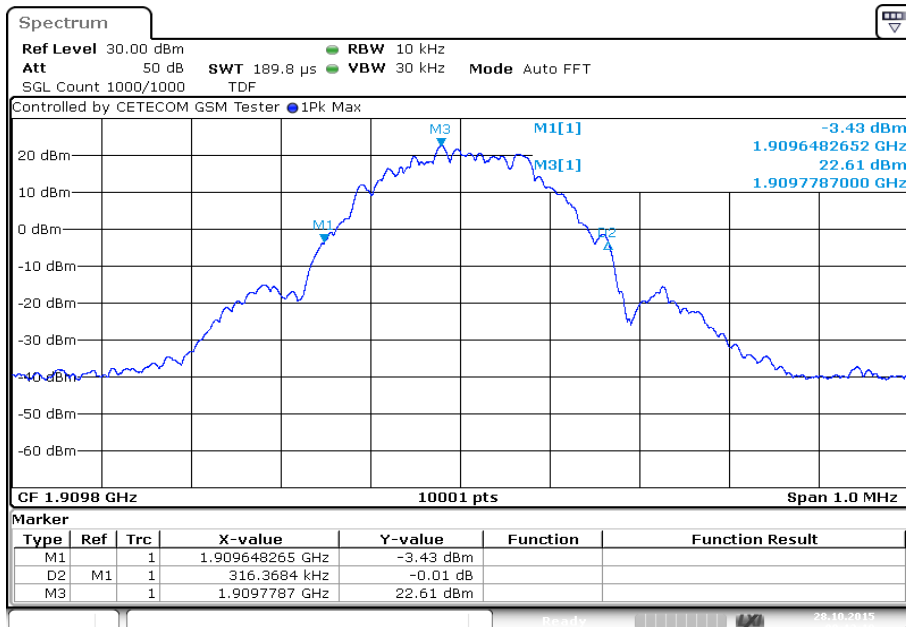

Date: 28.OCT.2015 09:12:19

11.3 Results UMTS band V

All UMTS-band measurements are done in WCDMA mode only.
 The connection was established with the following setup: WCDMA CS-RMC, Max Power (All Bit up)

11.3.1 RF output power

Description:

This paragraph contains average power, peak output power, PAPR and ERP measurements for the mobile station.

The plots in this test report represents only an example of the measurements. All plots of this chapter are available on request.
 The red line in the measurements indicates the ideal Gaussian distribution for the measured amplitude range.

Measurement:

The mobile was set up for the maximum output power with pseudo random data modulation.

To determine the Peak-To-Average Power Ratio (PAPR) the measurement was performed with the Power Complementary Cumulative Distribution Function (CCDF).

Measurement parameters	
Detector:	Sample
AQT:	15.6 ms
Resolution bandwidth:	40 MHz
Used equipment:	see chapter 7.1 – A and chapter 7.3 – A
Measurement uncertainty:	see chapter 8

Limits:

FCC	IC
Nominal Peak Output Power	
+38.45 dBm	
In measuring transmissions in this band using an average power technique, the peak-to-average ratio (PAR) of the transmission may not exceed 13 dB.	

Results:

Output Power (conducted) WCDMA mode			
Frequency (MHz)	Peak Output Power (dBm)	Average Output Power (dBm)	Peak to Average Ratio (dB) CCDF
826.4	26.82	23.05	3.77
836.0	27.16	23.25	3.92
846.6	27.01	23.16	3.85
Measurement uncertainty	± 0.5 dB		

Output Power (radiated) WCDMA mode	
Frequency (MHz)	Average Output Power (dBm) - ERP
826.4	20.6
836.0	22.5
846.6	21.8
Measurement uncertainty	± 2.0 dB

Plots:

Plot 1: Channel 4132

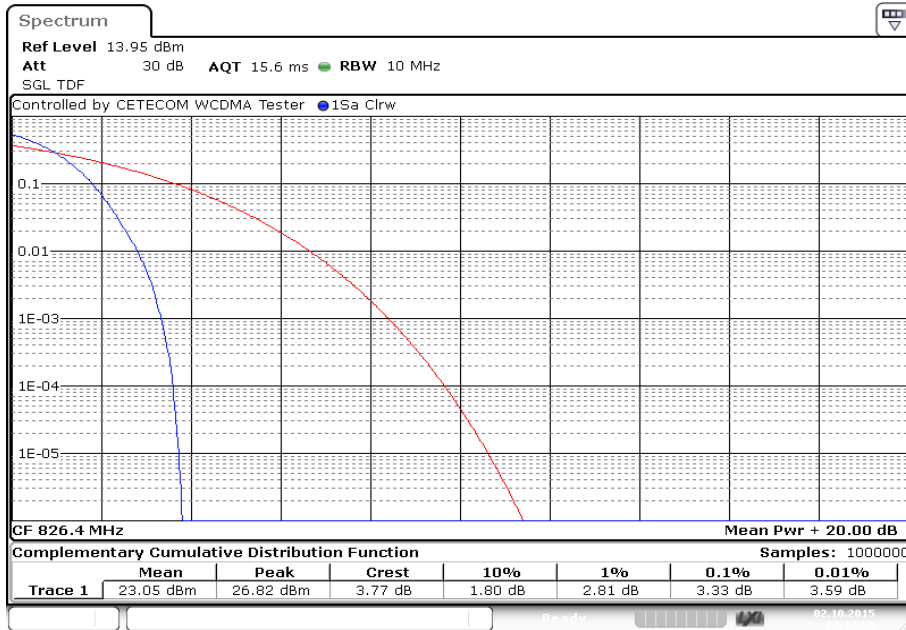

Date: 2.OCT.2015 07:37:50

Plot 2: Channel 4180

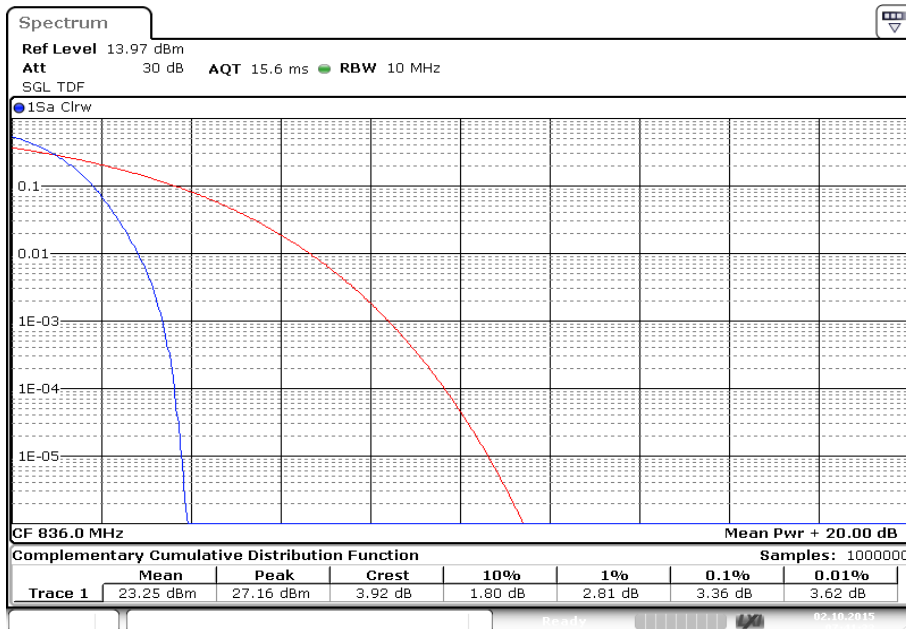

Date: 2.OCT.2015 07:41:33

Plot 3: Channel 4233

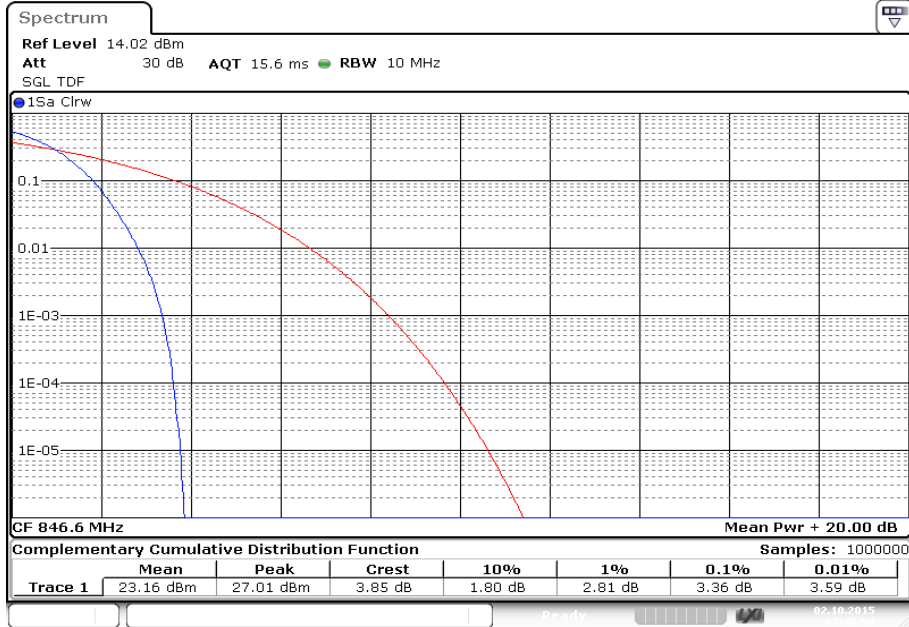

Date: 2.OCT.2015 07:45:50

11.3.2 Frequency stability

Description:

In order to measure the carrier frequency under normal conditions it is necessary to make measurements with the mobile station connected to a R&S CMU200 Wideband Radio Communication Tester.

1. Measure the carrier frequency at room temperature.
2. Subject the mobile station to overnight soak at -30 C.
3. With the mobile station, powered with V_{nom} , connected to the CMU200 on the centre channel. Measure the carrier frequency. These measurements should be made within two minutes of powering up the mobile station to prevent significant self warming.
4. Repeat the above measurements at 10°C increments from -30°C to +50°C. Allow at least 15 minutes at each temperature, unpowered before making measurements.
5. At all temperature levels hold the temperature to +/- 0.5°C during the measurement procedure.

Measurement:

Measurement parameters	
Detector:	Measured with CMU200
Sweep time:	
Video bandwidth:	
Resolution bandwidth:	
Span:	
Trace-Mode:	
Test setup:	see chapter chapter 7.3 – B
Measurement uncertainty:	see chapter 8

Limits:

FCC	IC
Frequency Stability	
± 0.1 ppm	

Results:**FREQ ERROR versus VOLTAGE**

Voltage (V)	Frequency Error (Hz)	Frequency Error (%)	Frequency Error (ppm)
3.8*	-4	-0.00000048	-0.0048

* The module requires an external stabilized power supply.

FREQ ERROR versus TEMPERATURE

Temperature (°C)	Frequency Error (Hz)	Frequency Error (%)	Frequency Error (ppm)
-30	-9	-0.00000108	-0.0108
-20	-4	-0.00000048	-0.0048
-10	-5	-0.00000060	-0.0060
± 0	-7	-0.00000084	-0.0084
10	-7	-0.00000084	-0.0084
20	-6	-0.00000072	-0.0072
30	-5	-0.00000060	-0.0060
40	-6	-0.00000072	-0.0072
50	-4	-0.00000048	-0.0048

11.3.3 Spurious emissions radiated

Description:

The following steps outline the procedure used to measure the radiated emissions from the mobile station. The site is constructed in accordance with ANSI C63.4:2009 requirements and is recognized by the FCC to be in compliance for a 3 and a 10 meter site. The spectrum was scanned from 30 MHz to the 10th harmonic of the highest frequency generated within the equipment, which is the transmitted carrier that can be as high as 846.6 MHz. This was rounded up to 12 GHz. The resolution bandwidth is set as outlined in Part 22.917. The spectrum was scanned with the mobile station transmitting at carrier frequencies that pertain to low, mid and high channels of the UMTS band V.

Measurement:

Measurement parameters	
Detector:	Peak
Sweep time:	2 sec.
Video bandwidth:	Below 1 GHz: 100 kHz Above 1 GHz: 1 MHz
Resolution bandwidth:	Below 1 GHz: 100 kHz Above 1 GHz: 1 MHz
Span:	100 MHz Steps
Trace-Mode:	Max Hold
Used equipment:	see chapter 7.1 – A
Measurement uncertainty:	see chapter 8

Limits:

FCC	IC
Spurious Emissions Radiated	
Attenuation $\geq 43 + 10\log(P)$ (P, Power in Watts)	
-13 dBm	

Results:

Radiated emissions measurements were made only at the upper, center, and lower carrier frequencies of the UMTS band V (826.4 MHz, 836.0 MHz and 846.6 MHz). It was decided that measurements at these three carrier frequencies would be sufficient to demonstrate compliance with emissions limits because it was seen that all the significant spurs occur well outside the band and no radiation was seen from a carrier in one block of the UMTS band V into any of the other blocks. The equipment must still, however, meet emissions requirements with the carrier at all frequencies over which it is capable of operating and it is the manufacturer's responsibility to verify this.

The final open field radiated levels are presented on the next pages.

All measurements were done in horizontal and vertical polarization; the plots show the worst case.

The plots show only the middle channel. If spurious were detected, the lowest and highest channel were checked too. The found values are stated in the table below.

As can be seen from this data, the emissions from the test item were within the specification limit.

Spurious Emission Level (dBm)								
Harmonic	Ch. 4132 Freq. (MHz)	Level [dBm]	Harmonic	Ch. 4180 Freq. (MHz)	Level [dBm]	Harmonic	Ch. 4233 Freq. (MHz)	Level [dBm]
2	1652.8	-	2	1672.0	-	2	1693.2	-
3	2479.2	-	3	2508.0	-	3	2539.8	-
4	3305.6	-	4	3344.0	-	4	3386.4	-
5	4132.0	-	5	4180.0	-	5	4233.0	-
6	4958.4	-	6	5016.0	-	6	5079.6	-
7	5784.8	-	7	5852.0	-	7	5926.2	-
8	6611.2	-	8	6688.0	-	8	6772.8	-
9	7437.6	-	9	7524.0	-	9	7619.4	-
10	8264.0	-	10	8360.0	-	10	8466.0	-
Measurement uncertainty					± 3dB			

Plots:

Plot 1: Channel 4180 (Traffic mode up to 30 MHz)

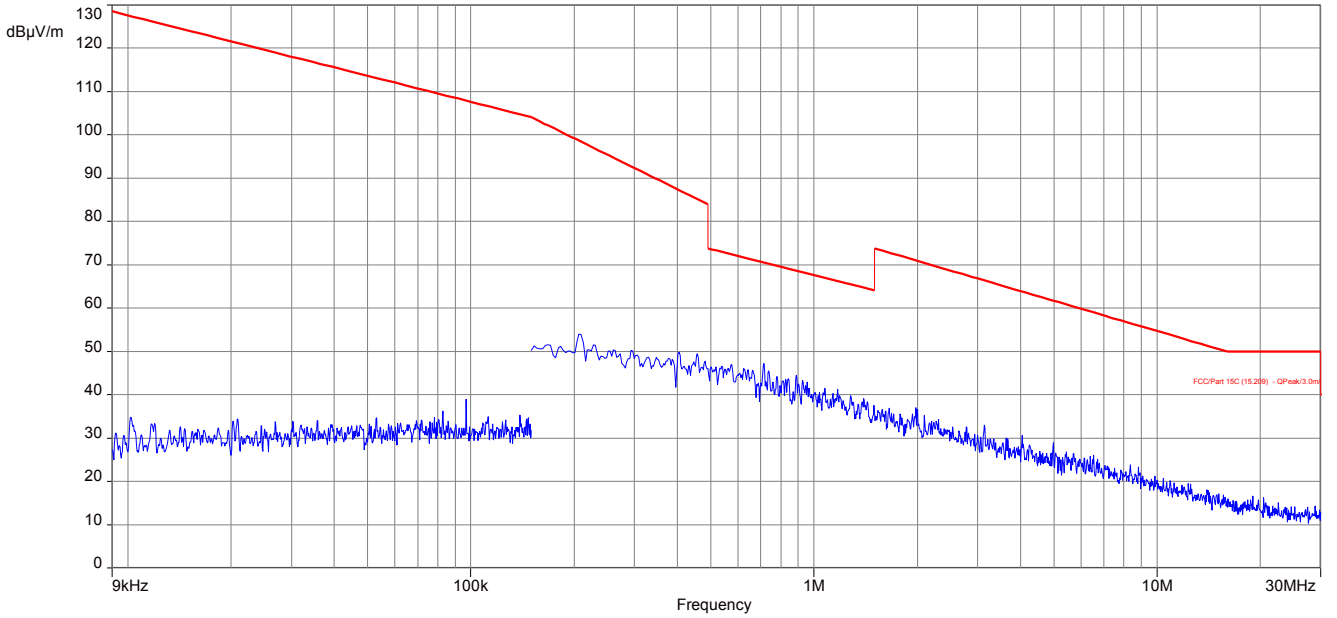

Plot 2: Channel 4180 (30 MHz – 12.75 GHz)

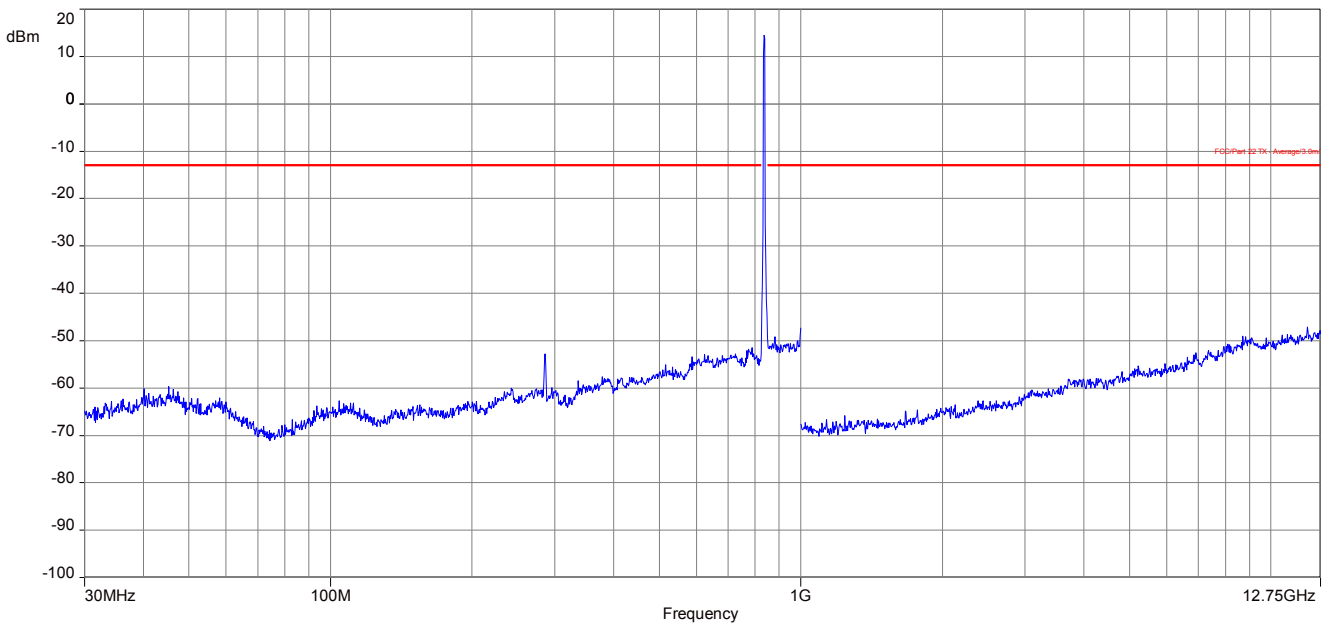

11.3.4 Spurious emissions conducted

Description:

The following steps outline the procedure used to measure the conducted emissions from the mobile station.

1. Determine frequency range for measurements: From CFR 2.1057 the spectrum should be investigated from the lowest radio frequency generated in the equipment up to at least the 10th harmonic of the carrier frequency. For the mobile station equipment tested, this equates to a frequency range of 13 MHz to 9 GHz, data taken from 10 MHz to 12 GHz.
2. Determine mobile station transmits frequencies: below outlines the band edge frequencies pertinent to conducted emissions testing.

UMTS band V Transmitter Channel Frequency

- 4132 826.4 MHz
- 4180 836.0 MHz
- 4233 846.6 MHz

Measurement:

Measurement parameters	
Detector:	Peak
Sweep time:	Auto
Video bandwidth:	Pre-measurement with 1 MHz On spurious detection re-measurement below 1 GHz with 100 kHz Above 1 GHz with 1 MHz
Resolution bandwidth:	Pre-measurement with 1 MHz On spurious detection re-measurement below 1 GHz with 100 kHz Above 1 GHz with 1 MHz
Span:	10 MHz – 26 GHz
Trace-Mode:	Max Hold
Used equipment:	see chapter 7.3 - A
Measurement uncertainty:	see chapter 8

Limits:

FCC	IC
Spurious Emissions Conducted	
Attenuation $\geq 43 + 10\log(P)$ (P, Power in Watts)	
-13 dBm	

Results:

Spurious Emission Level (dBm)								
Harmonic	Ch. 4132 Freq. (MHz)	Level [dBm]	Harmonic	Ch. 4180 Freq. (MHz)	Level [dBm]	Harmonic	Ch. 4233 Freq. (MHz)	Level [dBm]
2	1652.8	-	2	1672.0	-	2	1693.2	-
3	2479.2	-	3	2508.0	-	3	2539.8	-
4	3305.6	-	4	3344.0	-	4	3386.4	-
5	4132.0	-	5	4180.0	-	5	4233.0	-
6	4958.4	-	6	5016.0	-	6	5079.6	-
7	5784.8	-	7	5852.0	-	7	5926.2	-
8	6611.2	-	8	6688.0	-	8	6772.8	-
9	7437.6	-	9	7524.0	-	9	7619.4	-
10	8264.0	-	10	8360.0	-	10	8466.0	-
Measurement uncertainty					± 3dB			

Plots:

Plot 1: Channel 4132 (10 MHz - 26 GHz)

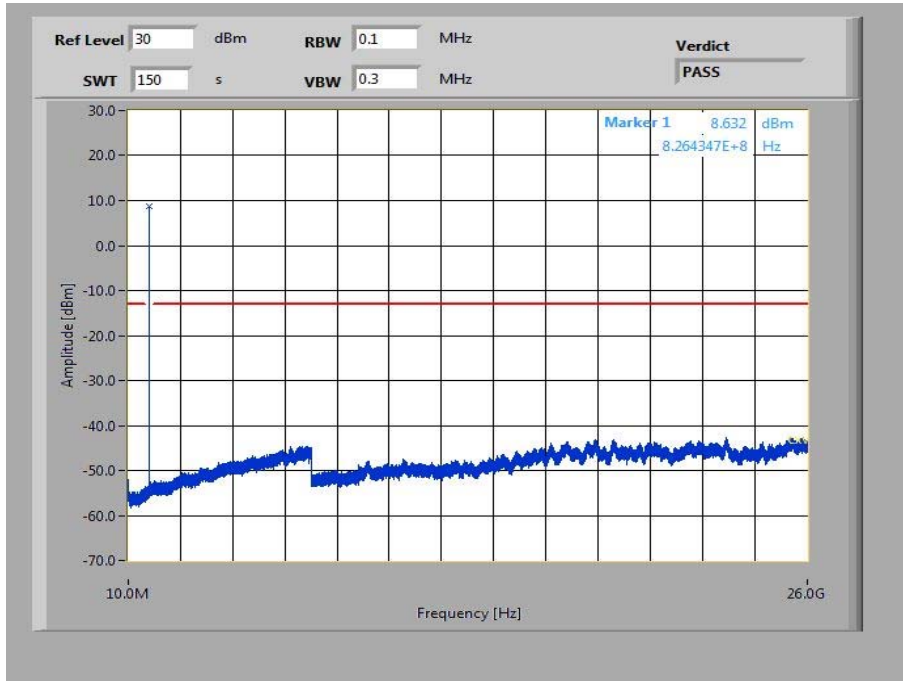

Plot 2: Channel 4180 (10 MHz - 26 GHz)

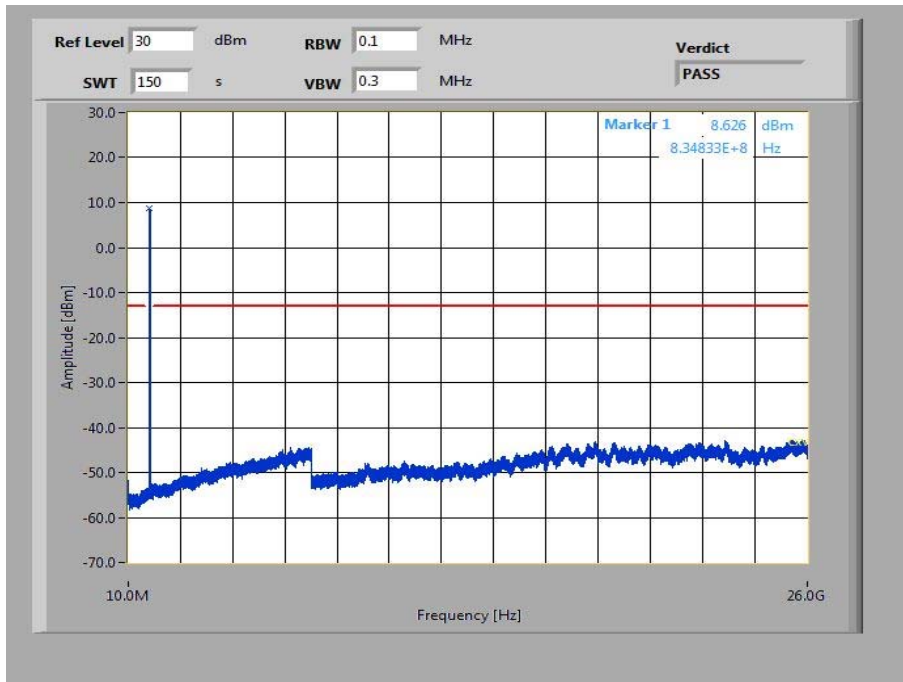

Plot 3: Channel 4233 (10 MHz - 26 GHz)

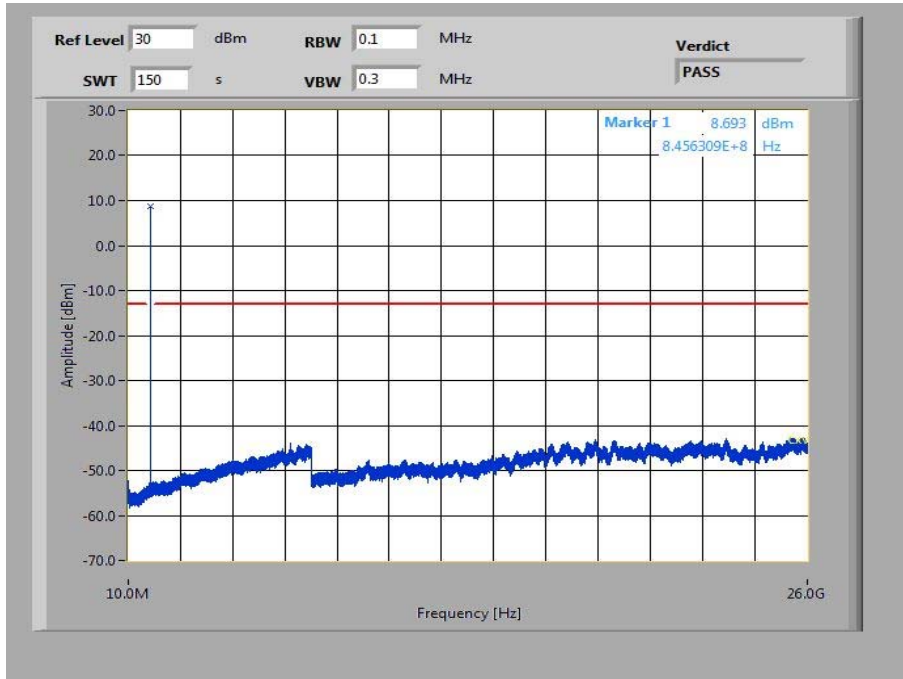

11.3.5 Block edge compliance

Description:

The spectrum at the band edges must comply with the spurious emissions limits.

Measurement:

Measurement parameters	
Detector:	RMS
Sweep time:	30 sec.
Video bandwidth:	1% - 5% of the OBW
Resolution bandwidth:	$\geq 3 \times \text{RBW}$
Span:	5 MHz
Trace-Mode:	Max Hold
Used equipment:	see chapter 7.3 - A
Measurement uncertainty:	see chapter 8

Limits:

FCC	IC
Block Edge Compliance	
Attenuation $\geq 43 + 10\log(P)$ (P, Power in Watts)	
-13 dBm	

Plots:

Plot 1: Channel 4132

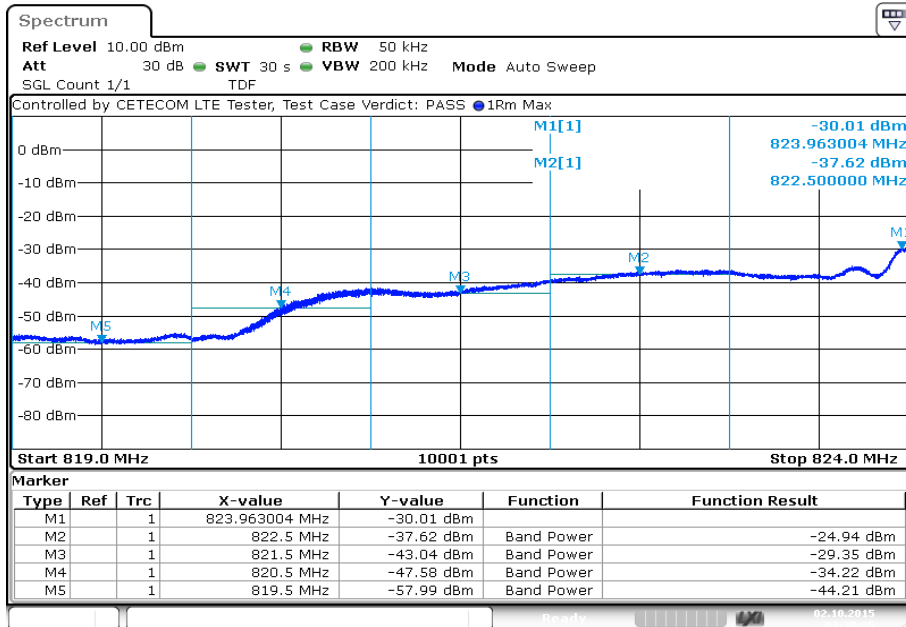

Date: 2.OCT.2015 07:38:25

Plot 2: Channel 4233

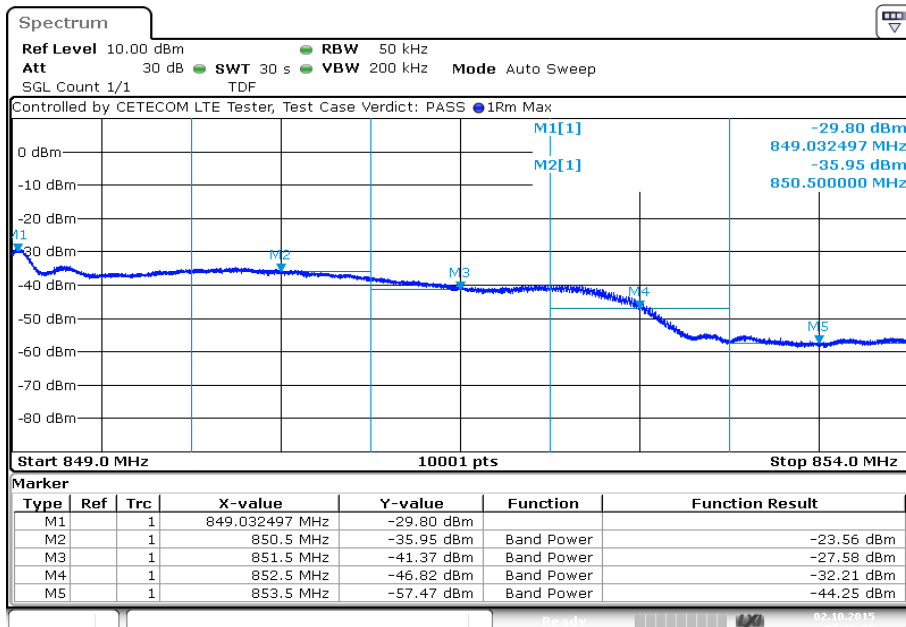

Date: 2.OCT.2015 07:46:25

11.3.6 Occupied bandwidth

Description:

Measurement of the occupied bandwidth of the transmitted signal.

Measurement:

Similar to conducted emissions, occupied bandwidth measurements are only provided for selected frequencies in order to reduce the amount of submitted data. Data were taken at the extreme and mid frequencies of the UMTS band V. The table below lists the measured 99% power and -26dBc occupied bandwidths. Spectrum analyzer plots are included on the following pages.

Measurement parameters	
Detector:	Peak
Sweep time:	Auto
Resolution bandwidth:	1% - 5% of the OBW
Video bandwidth:	≥ 3xRBW
Span:	2 x nominal BW
Trace-Mode:	Max Hold
Used equipment:	see chapter 7.3
Measurement uncertainty:	see chapter 8

Limits:

FCC	IC
Occupied Bandwidth	
Spectrum must fall completely in the specified band	

Results:

Occupied Bandwidth		
Frequency (MHz)	99% OBW (kHz)	-26 dBc BW (kHz)
826.4	4150	4617
836.0	4152	4612
846.6	4152	4613
Measurement uncertainty	± 100 kHz	

Plots:

Plot 1: Channel 4132 (99% - OBW)

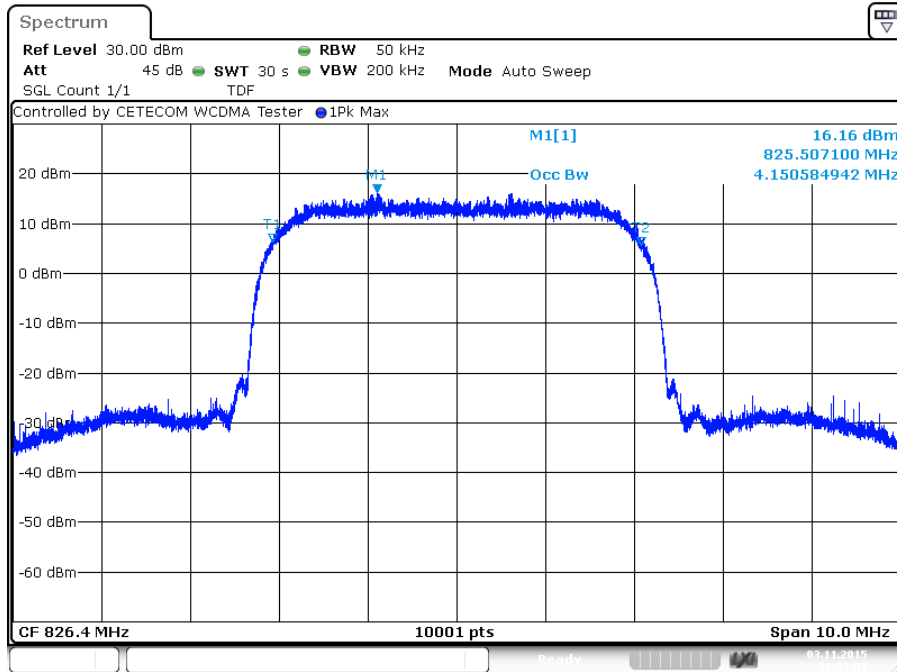

Plot 2: Channel 4132 (-26 dBc BW)

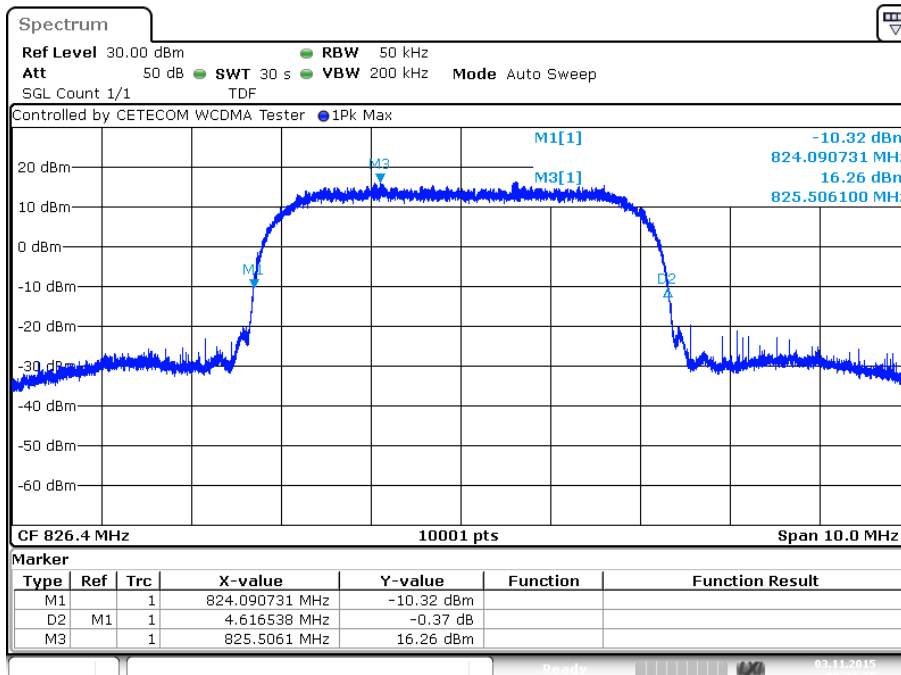

Plot 3: Channel 4180 (99% - OBW)

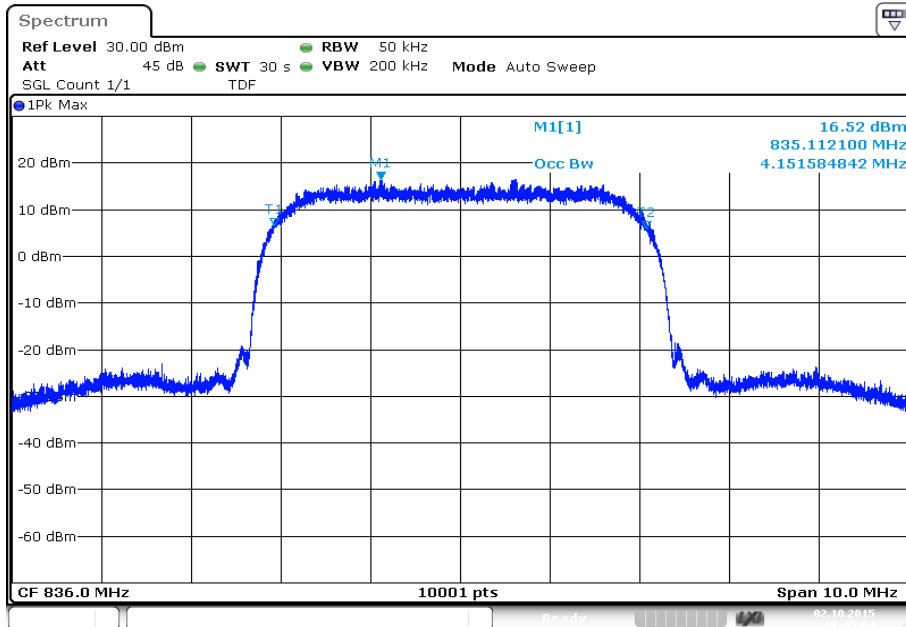

Date: 2.OCT.2015 07:45:04

Plot 4: Channel 4180 (-26 dBc BW)

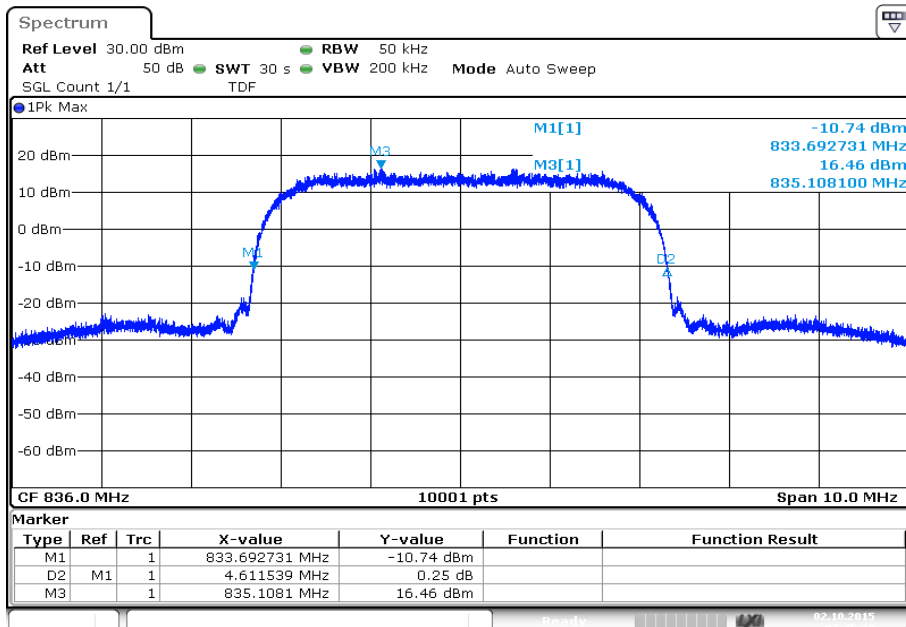

Date: 2.OCT.2015 07:45:39

Plot 5: Channel 4233 (99% - OBW)

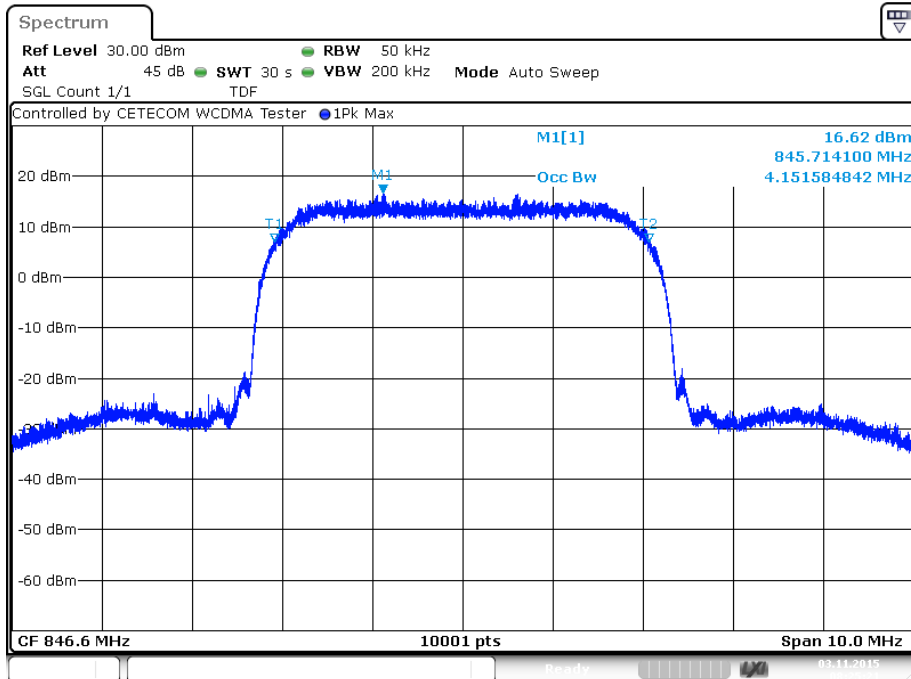

Plot 6: Channel 4233 (-26 dBc BW)

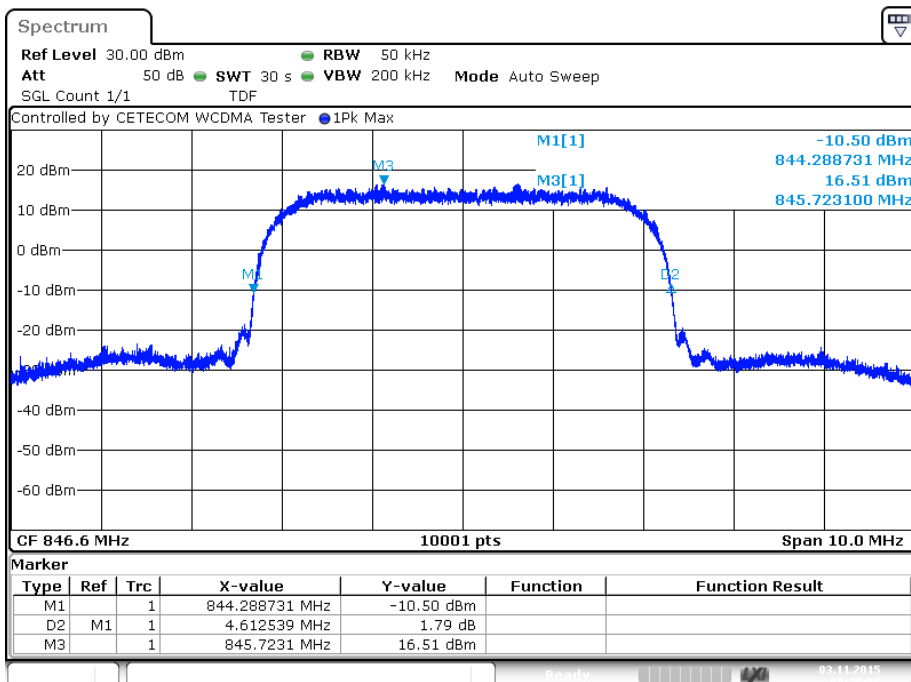

12 Observations

No observations except those reported with the single test cases have been made.

Annex A Document history

Version	Applied changes	Date of release
	Initial release	2015-11-12
-A	IC number removed; contact person changed	2016-05-12
-B	Correction of power supply conditions	2016-05-31

Annex B Further information**Glossary**

AVG	-	Average
DUT	-	Device under test
EMC	-	Electromagnetic Compatibility
EN	-	European Standard
EUT	-	Equipment under test
ETSI	-	European Telecommunications Standard Institute
FCC	-	Federal Communication Commission
FCC ID	-	Company Identifier at FCC
HW	-	Hardware
IC	-	Industry Canada
Inv. No.	-	Inventory number
N/A	-	Not applicable
PP	-	Positive peak
QP	-	Quasi peak
S/N	-	Serial number
SW	-	Software
PMN		Product marketing name
HMN		Host marketing name
HVIN		Hardware version identification number
FVIN		Firmware version identification number

Annex C Accreditation Certificate

Front side of certificate

Back side of certificate



Deutsche Akkreditierungsstelle GmbH

Befehle gemäß § 8 Absatz 1 AkkStelleG i.V.m. § 1 Absatz 1 AkkStelleGBV
 Unterzeichnerin der Multilateralen Abkommen
 von EA, ILAC und IAF zur gegenseitigen Anerkennung

Akkreditierung



Die Deutsche Akkreditierungsstelle GmbH bestätigt hiermit, dass das Prüflaboratorium

CETECOM ICT Services GmbH
 Untertürkheimer Straße 6-10, 66117 Saarbrücken

die Kompetenz nach DIN EN ISO/IEC 17025:2005 besitzt, Prüfungen in folgenden Bereichen durchzuführen:

- Funk
- Mobilfunk (GSM / DCS) + OTA
- Elektromagnetische Verträglichkeit (EMV)
- Produktsicherheit
- SAR / EMF
- Umwelt
- Smart Card Technology
- Bluetooth®
- Automotive
- Wi-Fi-Services
- Kanadische Anforderungen
- US-Anforderungen
- Akustik
- Near Field Communication (NFC)

Die Akkreditierungsurkunde gilt nur in Verbindung mit dem Bescheid vom 04.05.2016 mit der Akkreditierungsnummer D-PL-12076-01 und ist gültig bis 17.01.2018. Sie besteht aus diesem Deckblatt, der Rückseite des Deckblatts und der folgenden Anlage mit insgesamt 63 Seiten.

Registrierungsnummer der Urkunde: D-PL-12076-01-01

Frankfurt, 04.05.2016

Siehe Hinweise auf der Rückseite

RSE
 Im Auftrag Dir. Ing. (FH) Ralf Eigner
 Abteilungsleiter

Deutsche Akkreditierungsstelle GmbH

Standort Berlin
 Spittelmarkt 10
 10117 Berlin

Standort Frankfurt am Main
 Europa-Allee 52
 60327 Frankfurt am Main

Standort Braunschweig
 Bundesallee 100
 38116 Braunschweig

Die auszugsweise Veröffentlichung der Akkreditierungsurkunde bedarf der vorherigen schriftlichen Zustimmung der Deutsche Akkreditierungsstelle GmbH (DAkkS). Ausgenommen davon ist die separate Weiterverbreitung des Deckblattes durch die umseitig genannte Konformitätsbewertungsstelle in unveränderter Form.

Es darf nicht der Anschein erweckt werden, dass sich die Akkreditierung auch auf Bereiche erstreckt, die über den durch die DAkkS bestätigten Akkreditierungsbereich hinausgehen.

Die Akkreditierung erfolgte gemäß des Gesetzes über die Akkreditierungsstelle (AkkStelleG) vom 31. Juli 2009 (BGBl. I S. 2625) sowie der Verordnung (EG) Nr. 765/2008 des Europäischen Parlaments und des Rates vom 9. Juli 2008 über die Vorschriften für die Akkreditierung und Marktüberwachung im Zusammenhang mit der Vermarktung von Produkten (Abt. L 218 vom 9. Juli 2008, S. 30). Die DAkkS ist Unterzeichnerin der Multilateralen Abkommen zur gegenseitigen Anerkennung der European co-operation for Accreditation (EA), des International Accreditation Forum (IAF) und der International Laboratory Accreditation Cooperation (ILAC). Die Unterzeichner dieser Abkommen erkennen ihre Akkreditierungen gegenseitig an.

Der aktuelle Stand der Mitgliedschaft kann folgenden Webseiten entnommen werden:
 EA: www.european-accreditation.org
 ILAC: www.ilac.org
 IAF: www.iaf.nu

Note:

The current certificate including annex can be received from CETECOM ICT Services GmbH on request.