

Mercedes-Benz

**Zubehör • Accessories
Accessoires**

Montageanleitung

Halter Mobiltelefon

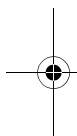

Installation Instructions

Mobile telephone cradle

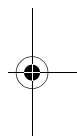

Instructions de montage

Support de téléphone portable

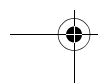
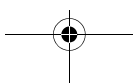
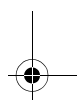
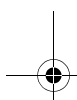



D

Halter Mobiltelefon
Seite 1

GB

Mobile telephone cradle
Page 15

F

Support de téléphone portable
Page 29

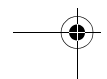
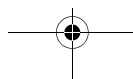
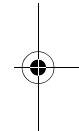
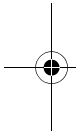

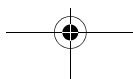
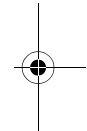
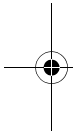
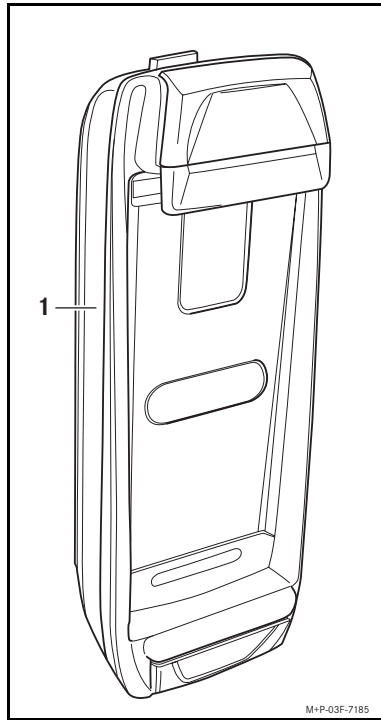



Gültigkeit

Diese Montageanleitung ist gültig für Fahrzeuge mit

- Vorrüstung Mobiltelefon mit Schnittstelle (Code 386) oder
- Mercedes-Benz Mobiltelefon (Code 388)

in Verbindung mit einem Mobiltelefon Nokia 6500.

Einzelteile

- (1) Halter Mobiltelefon

Nachfolgend als Halter bezeichnet.

Hinweise

Falls bei der Montage Schwierigkeiten auftreten, wenden Sie sich bitte an eine qualifizierte Fachwerkstatt. Mercedes-Benz empfiehlt Ihnen hierfür einen Mercedes-Benz Service-Stützpunkt.

Änderungen von technischen Details gegenüber Abbildungen der Montageanleitung sind vorbehalten.

In dieser Montageanleitung wird auf die COMAND-, Audio- bzw. Fahrzeug-Betriebsanleitung und die Betriebsanleitung des Mobiltelefons verwiesen. Bitte halten Sie diese bereit.

Bei hohen Umgebungstemperaturen kann der Halter während des Betriebs, wie der Fahrzeuginnenraum auch, sehr heiß werden.

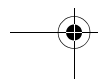
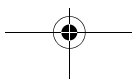
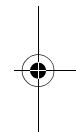
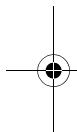



Inhaltsverzeichnis

Halter montieren	Seite 4
Mobiltelefon einsetzen	Seite 5
Mobiltelefon mit Halter koppeln	Seite 6
Mobiltelefon mit Halter verbinden	Seite 8
• manuell verbinden	Seite 9
• automatisch verbinden	Seite 9
In Freisprechmodus wechseln	Seite 10
Kfz-Profil anlegen	Seite 11
Allgemeine Bedienungshinweise	Seite 12
Schnellwahltasten	Seite 13
Mobiltelefon entnehmen	Seite 14
Halter demontieren	Seite 14

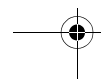
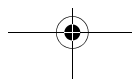
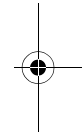



Unfallgefahr

Beachten Sie beim Betrieb des Telefons im Fahrzeug die gesetzlichen Bestimmungen des Landes, in dem Sie sich momentan aufhalten.

Ist die Bedienung eines Telefons während der Fahrt gesetzlich zugelassen, so bedienen Sie dieses nur, wenn es die Verkehrssituation zulässt. Sie könnten sonst vom Verkehrsgeschehen abgelenkt werden, einen Unfall verursachen und sich und andere verletzen.

Benutzen Sie während der Fahrt aus Sicherheitsgründen nur die Freisprecheinrichtung zum Telefonieren.

Wenn Sie mit der Freisprecheinrichtung telefonieren, fahren Sie aufmerksam, schließen Sie alle Fenster und vermeiden Sie alle störenden Geräusche.

Halten oder parken Sie, wenn Sie zum Telefonieren nicht die Freisprecheinrichtung benutzen wollen. Halten oder parken Sie nicht im Halte- oder Parkverbot.

Montieren und koppeln Sie das Telefon-Modul nur bei Fahrzeugstillstand. Sie könnten sonst vom Straßenverkehr abgelenkt werden und einen Unfall verursachen.

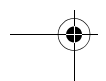
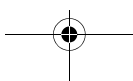
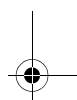
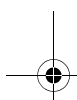
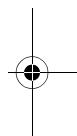
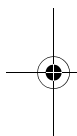



Halter montieren

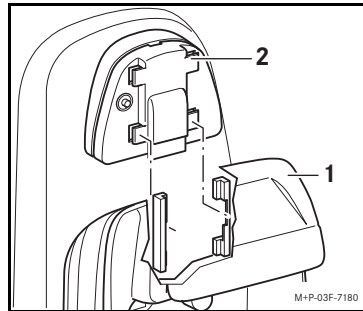

1. Halter (1) auf die Kontaktplatte (2) schieben, bis er hörbar einrastet.

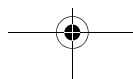
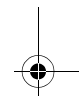
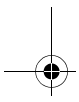
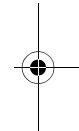
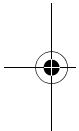



Mobiltelefon einsetzen

Die Nutzung der Freisprecheinrichtung und der Telefonfunktionen über das Bediensystem/den Bordcomputer ist nur möglich, wenn sich das Mobiltelefon im Halter befindet und eine Bluetooth®-Verbindung aufgebaut ist.

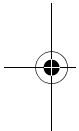
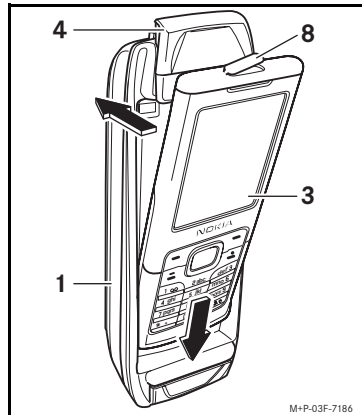

1. Abdeckung (8) entfernen.
2. Mobiltelefon (3) wie abgebildet im Halter (1) einrasten.

Hinweis

Darauf achten, dass die Verriegelung (4) korrekt am Mobiltelefon (3) einrastet, da ansonsten keine Verbindung zwischen Mobiltelefon und Halter besteht. Das Mobiltelefon gegebenenfalls erneut einsetzen.

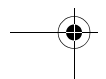
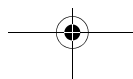
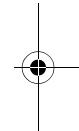



Mobiltelefon mit Halter Mobiltelefon koppeln

Zum Koppeln kann sich das Mobiltelefon im Halter oder außerhalb des Halters im Fahrzeug befinden.

1. Zündschlüssel in Stellung 1, 2 oder 3 drehen, siehe Fahrzeug-Betriebsanleitung.
2. „Menü“ → „Einstellungen“ → „Verbindungen“ → „Bluetooth“ → „Ein“ am Mobiltelefon wählen, siehe Betriebsanleitung Mobiltelefon.

Hinweis (Fahrzeuge der C-Klasse W/S 204)

Das Mobiltelefon sollte zum koppeln in den Halter eingesetzt werden.

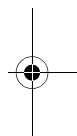
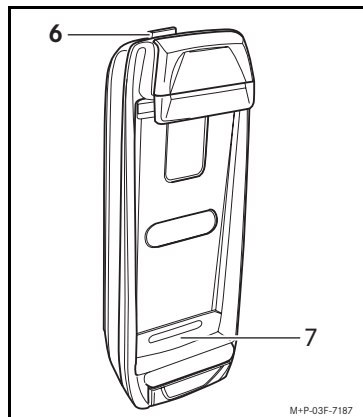
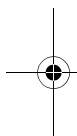

3. Bluetooth[®]-Taste (6) ca. 2 Sekunden drücken. Die Leuchtdiode (7) blinkt in schneller Frequenz.
Der Halter ist ca. 2 Minuten für suchende Geräte sichtbar und kann vom Mobiltelefon erkannt werden.

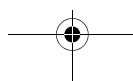
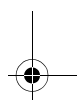
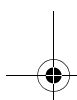



4. „Menü“ → „Einstellungen“ → „Verbindungen“ → „Bluetooth“ → „Audio Zubehör such.“ am Mobiltelefon wählen, siehe Betriebsanleitung Mobiltelefon. Das Mobiltelefon beginnt mit der Suche nach dem Halter.

Wurde der Halter vom Mobiltelefon gefunden, erscheint „MB N6500Cradle“ im Display des Mobiltelefons.

Hinweis

Es wird empfohlen die Anfrage: „Telefon für alle suchenden Geräte sichtbar machen?“ mit „Nein“ abzulehnen, siehe Betriebsanleitung Mobiltelefon.

5. „MB N6500Cradle“ am Mobiltelefon wählen.

Im Display des Mobiltelefons erscheint eine Passkey-Abfrage.

6. Passkey 62872 am Mobiltelefon eingeben und mit „OK“ bestätigen.

7. „Automatisches Herstellen einer Verbindung durch das Gerät zulassen?“ mit „Ja“ bestätigen, um einen automatischen Verbindungsaufbau zwischen Mobiltelefon und Halter zu ermöglichen.

Hinweis

Der gewählte Gerätename des Halters darf im Speicher des Mobiltelefons noch nicht existieren, ansonsten meldet das Mobiltelefon „Bluetooth-Verbindung fehlgeschlagen“. Der bereits im Speicher des Mobiltelefons existierende Halter muss umbenannt oder aus dem Speicher gelöscht werden, siehe Betriebsanleitung Mobiltelefon.

Sobald der Passkey eingegeben und akzeptiert wurde, bestätigt das Mobiltelefon den Verbindungsaufbau. Die Verbindung zwischen Mobiltelefon und Halter wird automatisch getrennt, wenn das Mobiltelefon zum koppeln nicht in den Halter eingesetzt war.





8. Das Mobiltelefon ist nun bereit für die Nutzung in der Freisprecheinrichtung.

Hinweis

Es können maximal 4 Mobiltelefone mit dem Halter gekoppelt werden. Wird ein fünftes Mobiltelefon mit dem Halter gekoppelt, so wird das zuerst gekoppelte Mobiltelefon aus dem Speicher gelöscht.

Mobiltelefon mit Halter Mobiltelefon verbinden

Nach dem Koppeln erfolgt der Verbindungsaufbau zwischen Mobiltelefon und Halter automatisch, sobald das Mobiltelefon in den Halter eingesetzt wird. Die Leuchtdiode am Halter leuchtet dauerhaft.

Für eine korrekte Funktion der Freisprecheinrichtung darf das in den Halter eingesetzte Mobiltelefon nicht zeitgleich mit der Bluetooth[®]-Schnittstelle des COMAND- oder Audio-Systems verbunden sein, siehe COMAND- bzw. Audio-Betriebsanleitung.

Mobiltelefon in den Halter einsetzen und Zündschlüssel in Stellung 1, 2 oder 3 drehen, siehe Fahrzeug-Betriebsanleitung.

Hinweise

Es ist immer nur das Mobiltelefon mit dem Halter verbunden, welches eingesetzt ist.

Zur Nutzung der Freisprecheinrichtung muss das Mobiltelefon in den Halter eingesetzt sein.

Erfolgt keine automatische Verbindung zwischen Mobiltelefon und Halter, so kann diese manuell hergestellt werden, siehe Seite 9.

Der Akku des Mobiltelefons wird in Zündschlüsselstellung 1, 2 oder 3 geladen.

Es kann nicht jeder Klingelton über COMAND oder das Bediensystem/den Bordcomputer wiedergegeben werden.

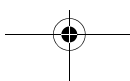
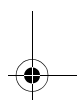
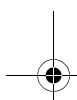
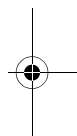
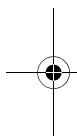



Während einer aktiven Verbindung zwischen Mobiltelefon und Halter erscheint im Bediensystem/Bordcomputer der Name des Mobilfunkanbieters, insofern Netzempfang besteht.



Mobiltelefon mit Halter Mobiltelefon manuell verbinden

1. Mobiltelefon in den Halter einlegen.
 2. Bluetooth[®]-Taste am Halter drücken.
- oder:

Bei Fahrzeugen der S-Klasse, W/V 221, und der CL-Klasse, C 216,

- mit dem COMAND-Controller
„Tel“ → „Tel“ → „Telefon“ wählen,
siehe Fahrzeug-Betriebsanleitung.

Bei einigen Baureihen

- Taste **TEL** drücken, siehe COMAND- oder Audio-Betriebsanleitung.

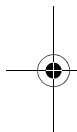

Hinweis

Vor dem manuellen Verbinden muss das Mobiltelefon mit dem Halter gekoppelt sein, siehe Seite 6.

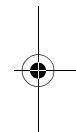

Mobiltelefon mit Halter Mobiltelefon automatisch verbinden

1. „Menü“ → „Einstellungen“ → „Verbindungen“ → „Bluetooth“ → „Gekoppelte Geräte“ am Mobiltelefon wählen, siehe Betriebsanleitung Mobiltelefon.
2. „MB N6500Cradle“ am Mobiltelefon wählen.
3. „Optionen“ → „Einstellungen“ → „Aut. Verb. ohne Best.“ am Mobiltelefon wählen und mit „Ja“ bestätigen, siehe Betriebsanleitung Mobiltelefon.

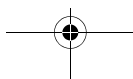



In den Freisprechmodus wechseln

Für eine korrekte Funktion der Freisprecheinrichtung muss das eingesetzte und eingeschaltete Mobiltelefon automatisch in den Freisprech-Modus wechseln.

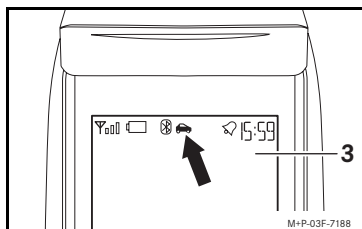

Im Display des Mobiltelefons erscheint ein kleines Fahrzeugsymbol (Pfeil). Ist dies nicht der Fall, Mobiltelefon (3) entnehmen und erneut einsetzen.

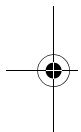

Hinweise

Die Bluetooth®-Verbindung zwischen Mobiltelefon und Halter wird nach Entnahme des Mobiltelefons aus dem Halter automatisch getrennt.

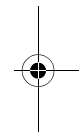

Nach automatischer Trennung der Bluetooth®-Verbindung zwischen Mobiltelefon und Halter wird ein aktives Gespräch am Mobiltelefon fortgeführt.

Ein aktives Gespräch wird durch Einstecken des Mobiltelefons in den Halter im Fahrzeug automatisch mit der Freisprecheinrichtung verbunden. Es erfolgt keine Rufnummernanzeige im COMAND- bzw. Audio-System.

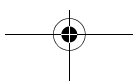



Kfz-Profil anlegen

Nach erstmaligem Koppeln und Verbinden zwischen Mobiltelefon und Halter legt das Mobiltelefon automatisch ein eigenes Profil für den Freisprech-Modus an, in welches das Mobiltelefon beim Einsetzen in den Halter automatisch wechselt, siehe Betriebsanleitung Mobiltelefon.

Im Profil für den Freisprech-Modus können Rufton und Ruftonlautstärke auf das Fahrzeug abgestimmt werden.

Hinweise

Sollten Sie im Profil für den Freisprech-Modus „Aktives Profil“ eingestellt und als normales Profil „Lautlos“ aktiviert haben, erfolgt auch bei in den Halter eingesetztem Mobiltelefon keine Rufтонwiedergabe.

Sollten Sie das Profil „Flug“ aktiviert haben, erfolgt kein Verbindungsaufbau zwischen Halter und eingesetztem Mobiltelefon, siehe Betriebsanleitung Mobiltelefon.

1. Profil bearbeiten: Am Mobiltelefon unter „Menü“ → „Einstellungen“ → „Zubehör“ → „Freisprechen“ → „Standardprofil“ → z.B. „Mein Profil 1“ einstellen.

2. Klingellautstärke einstellen: Am Mobiltelefon unter „Menü“ → „Einstellungen“ → „Profile“ → „Mein Profil 1“ → „Ändern“ → „Rufтонlautstärke“ die Lautstärke einstellen.

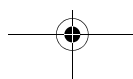





Allgemeine Bedienhinweise

Beim Mobiltelefon Nokia 6500 muss im Menü „Einstellungen“ → „Telefon“ → „Netzmodus“ → „GSM“ eingestellt werden.

Am Mobiltelefon darf die „Flug-Anfrage“ nicht eingeschaltet sein, da ansonsten kein Verbindungsaufbau zwischen Halter und eingesetztem Mobiltelefon erfolgt, siehe Betriebsanleitung Mobiltelefon.

Zur Bedienung des Mobiltelefons über das Multifunktionslenkrad siehe COMAND-, Audio- bzw. Fahrzeug-Betriebsanleitung.

Mit  oder  kann während eines Telefonats die Lautstärke verändert werden.

Die Einstellung der Rufnummernübertragung wechselt beim eingesetzten Mobiltelefon in die Einstellung „Netzabhängig“, siehe Betriebsanleitung Mobiltelefon. Eine Übertragung der Rufnummer im Freisprechmodus muss beim Netzbetreiber bzw. Dienstanbieter eingestellt werden. Für diese Einstellung wenden Sie sich bitte an Ihren Netzbetreiber bzw. Dienstanbieter.

In neueren Fahrzeugen können die 30 aktuellsten Kurzmitteilungen am COMAND- bzw. Audio-System angezeigt werden.

Im Eingangsortner des Mobiltelefons sollten nicht zu viele Kurzmitteilungen gespeichert sein, siehe Betriebsanleitung Mobiltelefon.

Es wird empfohlen das Mobiltelefon mindestens einmal im Monat auszuschalten, siehe Betriebsanleitung Mobiltelefon.

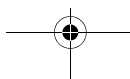
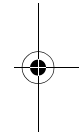
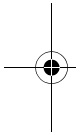



Schnellwahltasten

Schnellwahltaste für Mailbox

Die Taste **1** abc kann als Schnellwahltaste für die Mailbox belegt werden.

Schnellwahltaste belegen

1. Taste **1** abc am Mobiltelefon ca. 3 Sekunden drücken. Im Display des Mobiltelefons erscheint die Meldung „*Erst Nummer für Sprachmailbox speichern*“, dann eine Aufforderung zur Eingabe der Telefonnummer der Mailbox.
2. Am Mobiltelefon die Telefonnummer der Mailbox eingeben und bestätigen.

Schnellwahltaste abrufen

Am COMAND- bzw. Audio-System Taste **1** abc ca. 3 Sekunden drücken.

Andere Schnellwahltasten (Kurzwahl)

Bei einigen Baureihen kann über die Tasten **2** abc bis **9** wxyz am COMAND- bzw. Audio-System auf die Speicherplätze 2 bis 9 der SIM-Karte zugegriffen werden.

Hinweis

Die Speicherplätze 2 bis 9 der SIM-Karte müssen entsprechend Ihren Wünschen belegt sein. Bei Nokia-Mobiltelefonen des Typs 6500 wird der Speicherplatz auf der SIM-Karte nicht angezeigt. Durch Drücken der Tasten **2** abc bis **9** wxyz am Bediensystem wird die entsprechende Telefonnummer angezeigt. Soll z.B. eine Telefonnummer auf die Schnellwahltaste **3** def gelegt werden, muss diese am Ziffernblock des Bediensystems gewählt und kann dann bei Bedarf am Mobiltelefon umbenannt werden, siehe Betriebsanleitung Mobiltelefon.

Schnellwahltaste abrufen

Am COMAND- bzw. Audio-System entsprechende Taste ca. 3 Sekunden drücken.

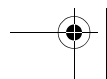
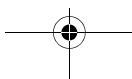
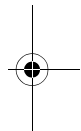
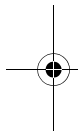



Mobiltelefon entnehmen

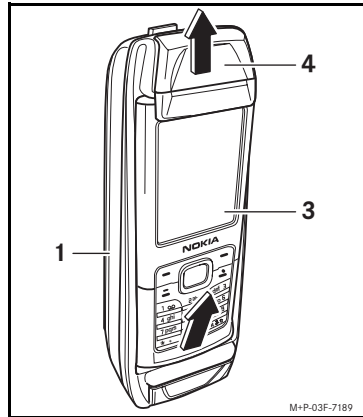

1. Verriegelung (4) nach oben schieben, und Mobiltelefon (3) aus dem Halter (1) nehmen.

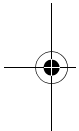

Halter Mobiltelefon demontieren

1. Mobiltelefon aus dem Halter entnehmen (siehe oben).

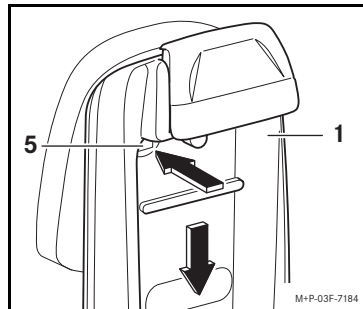
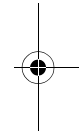

2. Entriegelungsknopf (5) drücken, Halter (1) nach unten schieben und abnehmen.

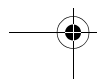
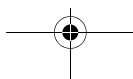



Validity

These installation instructions are valid for vehicles equipped with a

- Mobile phone fitting with interface (Code 386) or
- Mercedes-Benz mobile phone (code 388)

- Each in combination with Nokia mobile phone 6500.

Components

- (1) Mobile phone cradle

In the following text, this will be referred to as "cradle".

Notes

Please contact a qualified specialist workshop if you encounter difficulties when fitting the telephone module.

Mercedes-Benz recommends that you use a Mercedes-Benz Service Centre for this purpose.

The manufacturer reserves the right to change technical details from those shown in the illustrations contained in these installation instructions.

These installation instructions also refer to the COMAND and Audio Operating Instructions, the vehicle Owner's Manual and the mobile phone operating instructions. Please keep them handy for reference.

At high outside temperatures, the cradle can become very hot when in operation, as is the case with the vehicle interior itself.

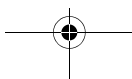
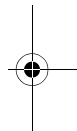
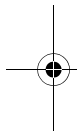



Contents

Fitting the holder	Page 18
Inserting the mobile phone	Page 19
Pairing the mobile phone with the cradle	Page 20
Connecting the mobile phone to the cradle	Page 22
• Connecting the mobile phone manually	Page 23
• Connecting the mobile phone automatically	Page 23
Switching to hands-free mode	Page 24
Setting up the vehicle profile	Page 25
General notes on operation	Page 26
Speed-dial keys	Page 27
Removing the mobile phone	Page 28
Removing the cradle	Page 28

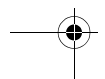
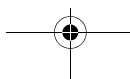
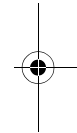
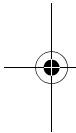



 **Risk of accident**

Please comply with the legal regulations of the country in which you are driving when you are using the telephone inside the vehicle.

If it is legally permissible to use the telephone while driving, only do so when traffic conditions allow for it. You may otherwise become distracted from the traffic, which may lead to an accident in which you or others may be injured.

For safety reasons, only use the hands-free system when making calls while driving.

When you are using the mobile phone via the hands-free system, drive with extra caution, close all windows and try to eliminate background noise.

Please pull over or park the car if you do not wish to use the hands-free system to make a call. Do not stop the vehicle or park where it is prohibited to do so.

Place the telephone module into the cradle only while the vehicle is at a standstill. You could otherwise be distracted and cause an accident.

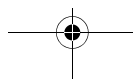
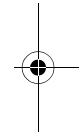
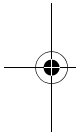



Fitting the holder

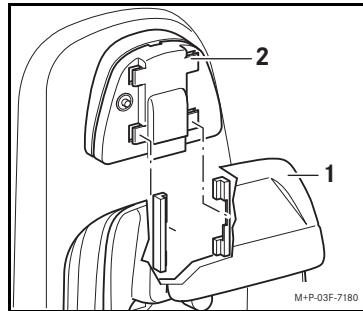

1. Slide the cradle (1) onto the contact plate (2) until it audibly engages.

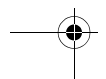
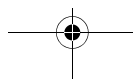
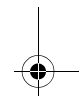
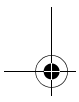
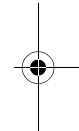
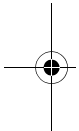



Inserting the mobile phone

It is only possible to use the hands-free system and the telephone functions via the operating system/on-board computer when the mobile phone is in the cradle and a Bluetooth® connection is established.

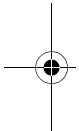
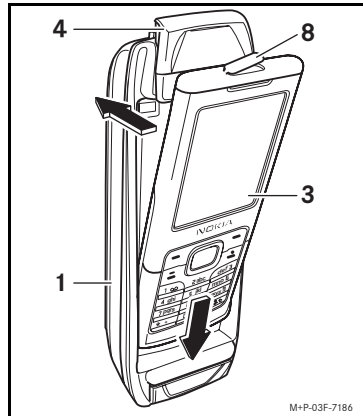

1. Remove the cover (8).
2. Insert the mobile phone (3) into the cradle (1) as shown.

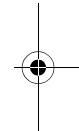

Note

Make sure that the locking tab (4) is correctly engaged on the mobile phone (3), as otherwise there is no connection between the mobile phone and the cradle. If necessary, reinsert the mobile phone.

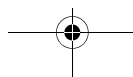



Pairing the mobile phone with the cradle

For pairing, the mobile phone must not be in the cradle, but it must be in the vehicle.

1. Turn the ignition key to position 1, 2 or 3. (Please refer to the vehicle Owner's Manual.)
2. Select *Menu* → *Settings* → *Connections* → *Bluetooth* → *ON* on the mobile phone. (Please refer to the mobile phone operating instructions.)

Note: For C-class vehicles, W/S 204

The mobile phone should always be inserted in the cradle for pairing.

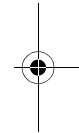
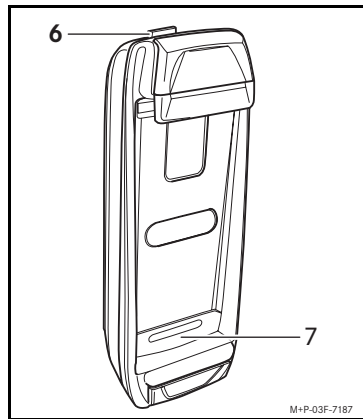
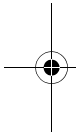

3. Press the Bluetooth® button (6) for approximately 2 seconds. The LED (7) flashes rapidly.

The cradle is visible to searching devices for approx. 2 minutes and can be detected by the mobile phone.

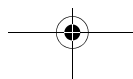



4. Select *Menu* → *Settings* → *Connections* → *Bluetooth* → *Search for audio devices* on the mobile phone. (Please refer to the mobile phone operating instructions.)
The mobile phone begins searching for the cradle. When the mobile phone finds the cradle, *MB N6500Cradle* appears in the mobile phone display.

Note

When you receive the request: *Make phone visible to all devices?* it is recommended to reject the request with *No*. (Please refer to the mobile phone operating instructions.)

5. Select "*MB N6500Cradle*" on the mobile phone.

A passkey prompt appears in the display of the mobile phone.

6. Enter the number 62872 (passkey) on the mobile phone and confirm with "*ok*".

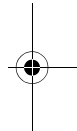
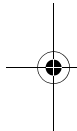

7. Confirm the request *Allow automatic establishing of a connection via the device?* with *Yes* in order to make an automatic connection between the mobile phone and the cradle possible.

Note

The selected device name of the cradle must not already be used in the memory of the mobile phone, as otherwise the mobile phone issues the message "*Bluetooth connection failed*". The cradle which is already in the memory of the mobile phone must be renamed or deleted from the memory. (Please refer to the mobile phone operating instructions.)

As soon as the passkey has been entered and accepted, the mobile phone confirms the connection setup. The connection between the mobile phone and cradle is terminated automatically if the mobile phone is not in the cradle during the pairing procedure.





8. The mobile phone is now ready to be used with the hands-free system.



Note

A maximum of 4 mobile phones may be paired with the cradle. If a fifth mobile phone is paired with the mobile phone cradle, the mobile phone that was paired first is deleted.

Connecting the mobile phone to the cradle

After the pairing, the connection between the mobile phone and the cradle is established automatically as soon as the mobile phone is inserted in the cradle. The LED on the cradle lights up continuously.

In order for the hands-free system to function properly, the phone which is in the cradle may not be connected with the Bluetooth[®] interface of COMAND or the Audio System. Please refer to the separate Operating Instructions of COMAND or the Audio System.

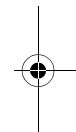
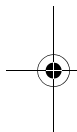

Insert the mobile phone in the cradle and turn the ignition key to position 1, 2 or 3. (Please refer to the vehicle Owner's Manual.)

Notes

Only the mobile phone which is inserted in the cradle is connected to the cradle.

In order to use the hands-free system, the mobile phone must be inserted in the cradle.

If the mobile phone cradle and the mobile phone are not connected automatically, the connection can be established manually (see page 23).

The mobile phone battery is charged when the ignition key is in position 1, 2 or 3.

Not every ring tone can be issued by COMAND or the vehicle's operating system/ on-board computer.

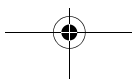



While there is a connection between the mobile phone and the cradle, the name of the mobile service provider is displayed in the operating system/on-board computer, as long as there is sufficient reception.



Manually connecting the mobile phone with the mobile phone cradle

1. Insert the mobile phone in the cradle.
2. Push the Bluetooth® button on the cradle.

Or:

For S-Class vehicles, W/V 22 1, and CL-Class vehicles, C 2 16:

- Select *Tel* → *Tel* → *Telephone* using the COMAND controller. (Please refer to the vehicle Owner's Manual.)

On some model series

- Press the **TEL** button. (Refer to the COMAND or Audio Operating Instructions.)

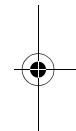
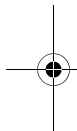

Note

Before being manually connected, the mobile phone must be paired with the cradle (see page 20).

Automatically connecting the mobile phone with the mobile phone cradle

1. Select *Menu* → *Settings* → *Connections* → *Bluetooth* → *Paired devices* on the mobile phone. (Please refer to the mobile phone operating instructions.)
2. Select *MB N6500Cradle* on the mobile phone.
3. Select *Options* → *Settings* → *Auth. Conn. w/o Conf.* on the mobile phone and confirm with *Yes*. (Please refer to the mobile phone operating instructions.)

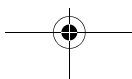



Switching to hands-free mode

For the hands-free system to operate properly, the mobile phone has to be inserted and switched on, and hands-free mode has to be activated.

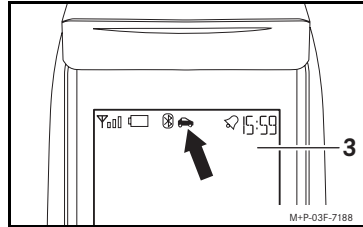

A small vehicle (arrow) appears in the display. If the small vehicle does not appear: remove and re-insert the mobile phone (3).

Notes

The Bluetooth® connection between the mobile phone and the cradle is interrupted automatically when the mobile phone is removed from the cradle.

After the Bluetooth® connection between the mobile phone and the cradle is interrupted automatically, if there is an active call it will continue on the mobile phone.

An active call is automatically connected with the hands-free system when you insert the mobile phone in the cradle in the vehicle. The telephone number is not displayed in COMAND or the audio system.

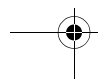
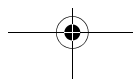
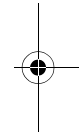
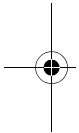



Setting up the vehicle profile

After pairing and setting up a connection between the mobile phone and cradle for the first time, the mobile phone automatically creates its own profile for the hands-free mode. The mobile phone switches automatically to this mode when inserted in the cradle. (Please refer to the mobile phone operating instructions.)

The ring tone and ring tone volume can be adapted to the vehicle in the hands-free mode profile.

Note

If you have not set "*Current profile*" in the profile for the hands-free mode and have enabled "*Silent*" as the normal profile, no ringtone sounds even if the mobile phone is inserted in the cradle.

If you have activated the *Flight* profile, no connection will be established between the cradle and the inserted mobile phone. (Please refer to the mobile phone operating instructions.)

1. Editing a profile: On the mobile phone in *Menu* → *Settings* → *Accessories* → *Handsfree* → *Default profile* → set, for example, *My style 1*.
2. Setting the ring tone volume: Set the ring tone volume on the mobile phone in *Menu* → *Settings* → *Profile* → *My profile 1* → *Change* → *Ring tone volume*.

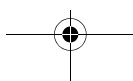
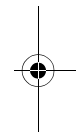
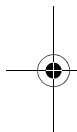



General notes on operation

On the Nokia 6500 mobile phone, open the menu and set "Settings" → "Phone" → "Network mode" → "GSM".

On the mobile phone, the *Flight request* function must not be activated, otherwise the connection between the cradle and the inserted mobile phone will not be established. (Please refer to the mobile phone operating instructions.)

For information on operating the mobile phone via the multi-function steering wheel, see the COMAND and/or Audio Operating instructions and/or the vehicle Owner's Manual.

Press the **+** or **-** buttons to adjust the volume during a telephone call.

The setting for transmitting and displaying the telephone number switches to „Set by network“ when the mobile phone is placed in the cradle. (Please refer to the mobile phone operating instructions.) The settings for the transmission of the telephone number in hands-free mode must be made by the network provider or the service provider. To make these settings, please contact the network provider or the service provider.

In newer vehicles, the 30 most recent text messages (SMS) can be displayed in the COMAND or Audio system.

You should not store too many text messages (SMS) in the Inbox of the mobile phone. (Please refer to the mobile phone operating instructions.)

It is recommendable to switch off the mobile phone at least once a month. (Please refer to the mobile phone operating instructions.)

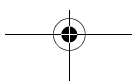
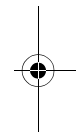
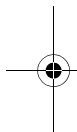



Speed-dial keys

Speed-dial key for mailbox

The  key can be programmed as a speed-dial key for your mailbox.



To program the speed-dial key:

1. Press button  on the mobile phone for approximately 3 seconds. In the mobile phone display the message „Save voice mailbox number first“ appears, then a request for you to enter the telephone number of the mailbox.
2. Enter the voice mailbox number on the mobile phone and confirm.



Calling up a speed-dial key

Press the  button on COMAND and/or the Audio system for approx. 3 seconds.

Other speed-dial keys

On some vehicle model series it is possible to access the SIM card memory keys 2 to 9 via the buttons  to  on COMAND and/or the Audio system.

Note

You must save numbers on memory keys 2 to 9 on the SIM card according to your preference. On Nokia mobile phone 6500, the SIM card memory keys are not displayed. Press buttons  to  on the operating system in order to show the corresponding number. If, for example, a telephone number is saved on speed-dial key , then this number must be selected on the operating system keypad and may, if necessary, be renamed on the mobile phone. (Please refer to the mobile phone operating instructions.)

Calling up a speed-dial key

Press and hold the corresponding button on COMAND or the Audio system for approx. 3 seconds.

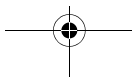
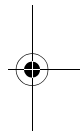
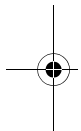



Removing the mobile phone

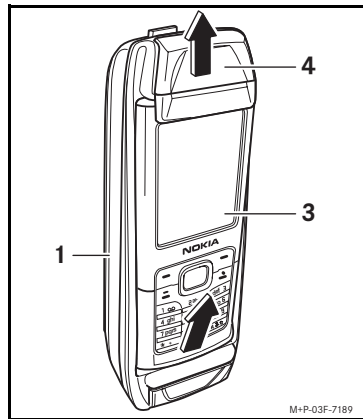

1. Slide the locking tab (4) upwards and remove the mobile phone (3) from the cradle (1).

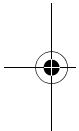

Detaching the mobile phone cradle

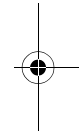

1. Remove the mobile phone from the cradle (see above).

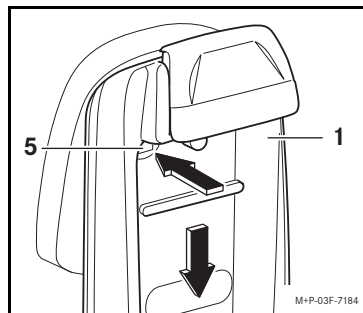

2. Press the release button (5), slide the cradle (1) downwards and remove.

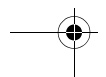
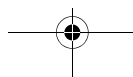



F



Validité

Ces instructions de montage s'appliquent aux véhicules dotés

- du prééquipement pour téléphone portable avec interface (code 386),
- du téléphone portable Mercedes-Benz (code 388)

en liaison avec un téléphone portable Nokia 6500.

Détail des pièces

- (1) Support de téléphone portable ci-après dénommé « support ».

Nota

En cas de difficultés lors du montage, veuillez vous adresser à un atelier qualifié. Mercedes-Benz vous recommande pour cela de vous adresser à un point de service Mercedes-Benz.

Sous réserve de modification de détails techniques par rapport aux illustrations de ces instructions de montage.

Ces instructions de montage renvoient à la notice d'utilisation du système COMAND, du système audio ou du véhicule, ainsi qu'à celle du téléphone portable. Veuillez tenir celles-ci à portée de main.

Lorsque la température ambiante est élevée, le support pendant son utilisation, ainsi que l'habitacle, peuvent devenir très chauds.

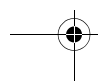
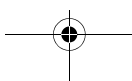
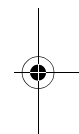
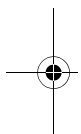
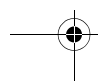
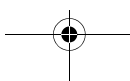
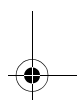
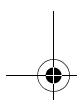
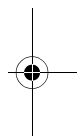
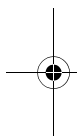



Table des matières

Montage du support	Page 32
Mise en place du téléphone portable	Page 33
Couplage du téléphone portable avec le support de téléphone portable	Page 34
Connexion du téléphone portable au support de téléphone portable	Page 36
• Connexion manuelle	Page 38
• Connexion automatique	Page 38
Passage au mode mains libres	Page 39
Création du profil Véhicule	Page 40
Instructions d'utilisation générales	Page 41
Touches d'accès rapide	Page 42
Dépose du téléphone portable	Page 44
Dépose du support	Page 44





Risque d'accident

Lorsque vous téléphonez en conduisant, tenez compte des dispositions légales du pays dans lequel vous vous trouvez.

Si l'utilisation d'un téléphone pendant la marche est autorisée par la loi, téléphonez uniquement lorsque les conditions de circulation le permettent. Sinon, votre attention risque d'être détournée de la circulation et vous risquez de provoquer un accident, de vous blesser et de blesser d'autres personnes.

Pour des raisons de sécurité, utilisez impérativement le dispositif mains libres pour téléphoner lorsque vous conduisez.

Si vous téléphonez en utilisant le dispositif mains libres, restez attentif à la conduite, fermez toutes les vitres et évitez tous les bruits qui pourraient vous gêner.

Arrêtez ou stationnez le véhicule si vous souhaitez téléphoner sans utiliser le dispositif mains libres. Ne vous arrêtez pas ou ne stationnez pas aux endroits où l'arrêt ou le stationnement sont interdits.

Procédez au montage et au couplage du module de téléphone uniquement lorsque le véhicule est à l'arrêt. Sinon, votre attention risque d'être détournée de la circulation et vous risquez de provoquer un accident.

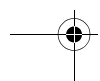
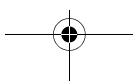
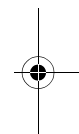
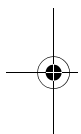



Montage du support

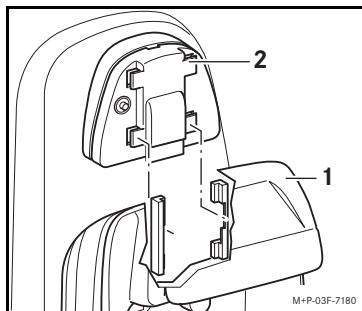

1. Engagez le support (1) sur la plaque de contact (2) jusqu'à ce qu'il s'enclenche de manière audible.

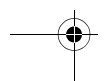
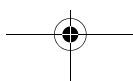
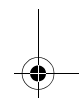
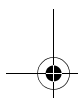
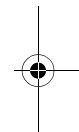
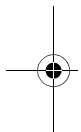



Mise en place du téléphone portable

L'utilisation du dispositif mains libres et des fonctions du téléphone via le système de commande/l'ordinateur de bord n'est possible que si le téléphone portable se trouve dans son support et qu'une liaison Bluetooth® est établie.

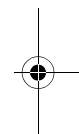
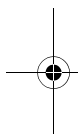
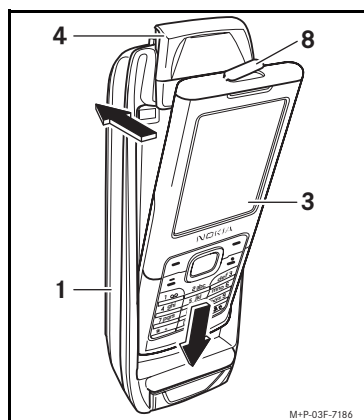

1. Retirez le cache (8).
2. Enclenchez le téléphone portable (3) sur le support (1), comme indiqué sur l'illustration.

Nota

Veillez à ce que le dispositif de verrouillage (4) s'enclenche correctement sur le téléphone portable (3). Sinon, il n'y a aucune connexion entre le téléphone portable et le support. Si nécessaire, remettez le téléphone portable en place dans le support.

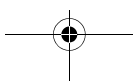



Couplage du téléphone portable avec le support de téléphone portable



Pour que le couplage soit possible, le téléphone portable doit se trouver dans le véhicule, placé ou non sur le support.

1. Tournez la clé en position 1, 2 ou 3 dans le contacteur d'allumage (voir la notice d'utilisation du véhicule).
2. Sélectionnez « *Menu* » → « *Param.* » → « *Connectivité* » → « *Bluetooth* » → « *Activé* » sur le téléphone portable (voir la notice d'utilisation du téléphone portable).

Remarque (modèles de la Classe C W/S 204)

Pour le couplage, vous devez placer le téléphone dans le support.

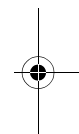
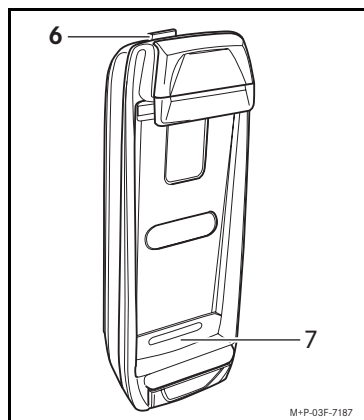
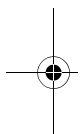

3. Appuyez sur la touche Bluetooth® (6) pendant environ 2 secondes. La diode (7) clignote rapidement.

Le support de téléphone portable est alors visible pendant 2 minutes environ pour les autres appareils Bluetooth et peut ainsi être détecté par le téléphone portable.

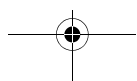



4. Sélectionnez « *Menu* » → « *Param.* » → « *Connectivité* » → « *Bluetooth* » → « *Chercher access. aud.* » sur le téléphone portable (voir la notice d'utilisation du téléphone portable). Le téléphone portable lance la recherche du support de téléphone portable. Lorsque le téléphone portable détecte le support, le message « *MB N6500Cradle* » s'affiche sur le visuel du téléphone portable.



Nota

Il est recommandé de répondre à la question « *Rendre le téléphone visible à tous les équipements de recherche?* » par « *Non* » (voir la notice d'utilisation du téléphone portable).

5. Sélectionnez « *MB N6500Cradle* » sur le téléphone portable.

Un message vous demandant de saisir le code d'accès apparaît sur le visuel du téléphone portable.

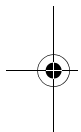

6. Entrez le code d'accès 62872 sur le téléphone portable, puis confirmez avec « *ok* ».

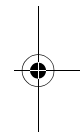

7. Validez le message « *Autoriser cet appareil à se connecter automatiquement?* » avec « *Oui* » pour permettre l'établissement automatique d'une connexion entre le téléphone portable et le support.

Nota

Le nom d'appareil sélectionné pour le support ne doit pas avoir été mémorisé dans la mémoire du téléphone portable, sinon le message « *La connexion Bluetooth a échoué* » Bluetooth s'affiche sur le téléphone portable. Si le nom d'un support existe déjà dans la mémoire du téléphone portable, il faut le renommer ou l'effacer (voir la notice d'utilisation du téléphone portable).

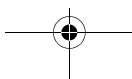



Une fois le code d'accès saisi et accepté, le téléphone portable confirme l'établissement de la connexion. La connexion entre le téléphone portable et le support est automatiquement interrompue si le téléphone portable à coupler ne se trouve pas dans le support.



8. Vous pouvez maintenant utiliser le téléphone portable par l'intermédiaire du dispositif mains libres.

Nota

Vous pouvez coupler jusqu'à 4 téléphones portables avec le support. Si un cinquième téléphone portable est couplé avec le support, le téléphone portable qui a été couplé en premier est effacé de la mémoire.

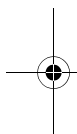

Connexion du téléphone portable au support de téléphone portable

Une fois que le couplage est terminé, la connexion entre le téléphone portable et le support est automatiquement établie lorsque le téléphone portable est placé dans le support. La diode qui se trouve sur le support de téléphone portable s'allume en continu.

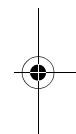

Pour que le dispositif mains libres fonctionne correctement, le téléphone portable inséré dans le support ne doit pas être connecté en même temps à l'interface Bluetooth® du système COMAND ou du système audio (voir la notice d'utilisation du système COMAND ou du système audio).

Placez le téléphone portable dans le support et tournez la clé en position 1, 2 ou 3 dans le contacteur d'allumage (voir la notice d'utilisation du véhicule).

Nota

Seul le téléphone portable placé dans le support est effectivement connecté au support.

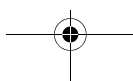
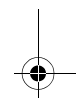
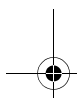



Le téléphone portable doit se trouver dans le support pour que vous puissiez utiliser le dispositif mains libres.



Si le support et le téléphone portable ne sont pas connectés automatiquement, la connexion peut être établie manuellement (voir page 38).

La batterie du téléphone portable se charge quand la clé de contact est en position 1, 2 ou 3.

Le système COMAND ou le système de commande/l'ordinateur de bord ne peut pas rendre toutes les sonneries.

Lorsque la connexion entre le téléphone portable et le support est active, le nom de l'opérateur de téléphonie mobile s'affiche sur le système de commande/l'ordinateur de bord si vous disposez d'une couverture réseau.

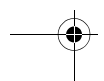
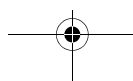
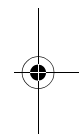
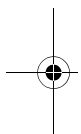



Connexion manuelle du téléphone portable au support de téléphone portable

1. Placez le téléphone portable dans le support.
2. Appuyez sur la touche Bluetooth® qui se trouve sur le support de téléphone portable.

Autre possibilité:

Pour les véhicules de la Classe S, W/V 221, et de la Classe CL, C 216

- Sélectionnez «*Tél*» → «*Tél*» → «*Téléphone*» à l'aide du sélecteur COMAND (voir la notice d'utilisation du véhicule).

Sur certaines séries

- Appuyez sur la touche **TEL** (voir la notice d'utilisation du système COMAND ou celle du système audio).

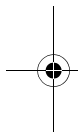

Nota

Pour pouvoir être connecté manuellement, le téléphone portable doit être couplé avec le support (voir page 34).

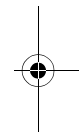

Connexion automatiquement du téléphone portable au support de téléphone portable

1. Sélectionnez «*Menu*» → «*Param.*» → «*Connectivité*» → «*Bluetooth*» → «*Equipements reliés*» sur le téléphone portable (voir la notice d'utilisation du téléphone portable).
2. Sélectionnez «*MB N6500Cradle*» sur le téléphone portable.
3. Sélectionnez «*Options*» → «*Param.*» → «*Conn. aut. sans conf.*» sur le téléphone portable et confirmez avec «*Oui*» (voir la notice d'utilisation du téléphone portable).

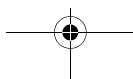



Passage au mode mains libres

Pour que le dispositif mains libres fonctionne correctement, il faut que le téléphone portable soit inséré sur le support, allumé et qu'il passe automatiquement en mode mains libres.

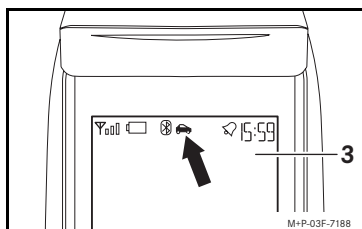

Un symbole représentant un véhicule (flèche) apparaît sur le visuel du téléphone portable. Si ce n'est pas le cas, retirez le téléphone portable (3) du support, puis remettez-le en place.

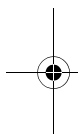

Nota

La connexion Bluetooth® entre le téléphone portable et le support est automatiquement interrompue lorsque le téléphone portable est retiré du support.

Lorsque la connexion Bluetooth® entre le téléphone portable et le support est interrompue automatiquement, la communication en cours peut être poursuivie par l'intermédiaire du téléphone portable.

Lorsque vous insérez le téléphone portable dans le support, la communication en cours est automatiquement transmise au dispositif mains libres. Le numéro d'appel n'est pas affiché dans le cas du système COMAND et du système audio.

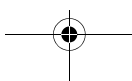
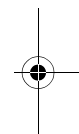



Création du profil Véhicule

Une fois que le téléphone portable et le support ont été couplés une première fois et qu'une première connexion a été établie, le téléphone portable crée automatiquement un profil spécifique pour le mode mains libres. Le téléphone portable passe automatiquement sur ce mode lorsqu'il est placé dans le support (voir la notice d'utilisation du téléphone portable).

Dans le profil propre au mode mains libre, vous pouvez définir la tonalité d'appel et son volume en fonction du véhicule.

Nota

Si « Mode actuel » est paramétré dans le profil pour le mode mains libres et que « *Silencieux* » est activé comme profil normal, aucune tonalité n'est audible même lorsque le téléphone portable est placé dans le support.

Si vous avez activé le profil « *Avion* », aucune connexion ne sera établie entre le support et le téléphone portable qui y est placé (voir la notice d'utilisation du téléphone portable).

1. Modification du profil : sélectionnez par exemple „*Mon style 1* » sous « *Menu* » → « *Paramètres* » → « *Accessoires* » → « *Mains libres* » → « *Mode par défaut* » sur le téléphone portable.

2. Réglage du volume de la sonnerie : réglez le volume sous « *Menu* » → « *Param.* » → « *Modes* » → « *Mon style 1* » → « *Personnaliser* » → « *Volume de la sonnerie* » sur le téléphone portable.

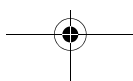
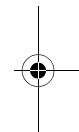
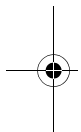



Instructions d'utilisation générales

Sur le modèle Nokia 6500, il faut effectuer le réglage sous « *Param.* » → « *Téléphone* » → « *Mode réseau* » → « *GSM* ».

L'option « *Invite mode Avion* » ne doit pas être activée sur le téléphone portable, sinon aucune connexion ne pourra être établie entre le support et le téléphone portable qui s'y trouve (voir la notice d'utilisation du téléphone portable).

Pour de plus amples informations sur l'utilisation du téléphone portable par le biais du volant multifonction, consultez la notice d'utilisation du système COMAND, du système audio ou du véhicule.

Appuyez sur la touche **+** ou la touche **-** pour régler le volume pendant la conversation.

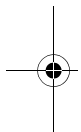

Lorsque le téléphone portable est placé sur le support, le transfert du numéro d'appel est remplacé par le paramètre „*Défini par réseau*” (voir la notice d'utilisation du téléphone portable). Vous devez convenir du transfert du numéro d'appel en mode mains libres auprès de votre opérateur ou prestataire de services. Adressez-vous pour cela à votre opérateur ou prestataire de services.

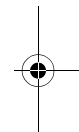

Sur les véhicules les plus récents, il est possible d'afficher les 30 derniers SMS sur le système COMAND ou le système audio.

Le dossier de réception du téléphone portable ne doit pas contenir trop de SMS (voir la notice d'utilisation du téléphone portable).

Il est recommandé d'éteindre le téléphone portable au moins une fois par mois (voir la notice d'utilisation du téléphone portable).

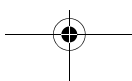



Touches d'accès rapide

Touche d'accès rapide à la boîte vocale

Il est possible d'attribuer la fonction de touche d'accès rapide à la boîte vocale à la touche

Attribution de fonction de la touche d'accès rapide

1. Appuyez sur la touche du téléphone portable pendant 3 secondes environ. Le message „Enregistrez d'abord le numéro de la boîte aux lettres vocale“ apparaît sur le visuel du téléphone portable, puis vous êtes invité à entrer le numéro de téléphone de la boîte vocale.
2. Entrez le numéro de téléphone de la boîte vocale sur le téléphone, puis confirmez.

Appel de la touche d'accès rapide

Appuyez sur la touche du système COMAND ou du système audio pendant 3 secondes environ.

Autres touches d'accès rapide (numérotation abrégée)

Sur certaines séries, il est possible d'accéder aux positions mémoire 2 à 9 de la carte SIM via les touches à du système COMAND ou du système audio.

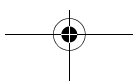
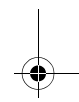
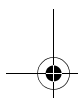
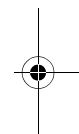
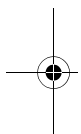



Nota

Vous pouvez attribuer les positions mémoire 3 à 9 de la carte SIM selon vos souhaits. Sur le téléphone portable Nokia 6500, la position mémoire sur la carte SIM n'est pas affichée. Le numéro de téléphone correspondant s'affiche lorsque vous appuyez sur les touches **2** ABC à **9** WXYZ sur le système de commande. Si un numéro de téléphone doit être attribué à la touche d'accès rapide **3** DEF, vous devez le composer sur le pavé numérique du système de commande et pouvez le renommer si nécessaire sur le téléphone portable (voir la notice d'utilisation du téléphone).

Appel de la touche d'accès rapide

Appuyez sur la touche correspondante du système COMAND ou du système audio pendant 3 secondes environ.

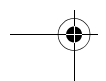
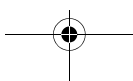
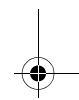
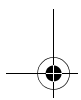
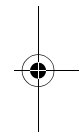
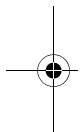



Dépose du téléphone portable

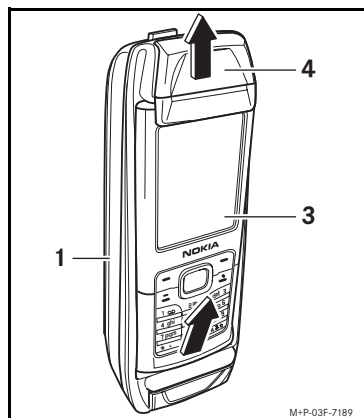

1. Poussez le dispositif de déverrouillage (4) vers le haut et retirez le téléphone portable (3) du support (1).

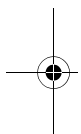

Dépose du support de téléphone portable

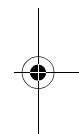

1. Retirez le téléphone portable du support (voir ci-dessus).

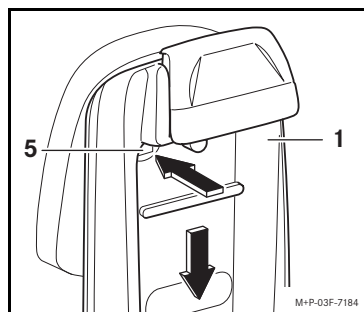

2. Appuyez sur le bouton de déverrouillage (5), poussez le support (1) vers le bas et dégagez-le de sa fixation.



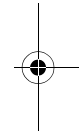
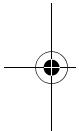

© 2008, Mercedes-Benz Accessories GmbH
Nachdruck, Vervielfältigung oder Über-
setzung, auch auszugsweise, nicht erlaubt.

Mercedes-Benz Accessories GmbH,
Stuttgart · Ein Unternehmen der Daimler AG

06/08
03F007-08

