

TEST REPORT

No.: 16-1-0050601T39a

According to:
FCC Regulations
 Part 22, Part 24

IC-Regulations
 RSS-132 Issue 3, RSS-133 Issue 6,
 RSS-Gen Issue 4

for

peiker acoustic GmbH & Co. KG

GSM/ WCDMA/ LTE Telematics US Module
 V1231-0

FCC-ID: QWY-V1231-0
 ISED ID: 6588A-V12310
 PMN: V1231-0
 HVIN: V1231-0







Laboratory Accreditation and Listings		
 <p>Deutsche Akkreditierungsstelle D-PL-12047-01-01</p> <p>Accredited EMC-Test Laboratory</p>	 <p>Industry Canada</p> <p>Reg. No.: 3462D-1 Reg. No.: 3462D-2 Reg. No.: 3462D-3</p>	 <p>Voluntary Controls for Electromagnetic Emissions</p> <p>Reg. No.: R-20013, C-20009, T-20006, G-20013</p>
 <p>AUTHORIZED RF LABORATORY</p>	 <p>Lab Code: 20011130-00</p>	 <p>MRA US-EU 0003</p>
accredited according to DIN EN ISO/IEC 17025		
<p align="center">CETECOM GmbH Laboratory Radio Communications & Electromagnetic Compatibility Im Teelbruch 116 • 45219 Essen • Germany Registered in Essen, Germany, Reg. No.: HRB Essen 8984 Tel.: + 49 (0) 20 54 / 95 19-954 • Fax: + 49 (0) 20 54 / 95 19-964 E-mail: info@cetecom.com • Internet: www.cetecom.com</p>		
Laboratory Accreditation and Listings		

Table of contents

1. SUMMARY OF TEST RESULTS	3
1.1. TX mode, Test overview of FCC and Canada ISED (RSS) Standards	3
1.2. RX mode, tests overview according FCC Part 15B and Canadian ISED (RSS) Standards	4
1.3. Attestation:	4
2. ADMINISTRATIVE DATA	5
2.1. Identification of the testing laboratory	5
2.2. Test location	5
2.3. Organizational items	5
2.4. Applicant's details	5
2.5. Manufacturer's details	5
3. EQUIPMENT UNDER TEST (EUT)	6
3.1. TECHNICAL DATA OF MAIN EUT DECLARED BY APPLICANT	6
3.2. EUT: Type, S/N etc. and short descriptions used in this test report	8
3.3. Auxiliary Equipment (AE): Type, S/N etc. and short descriptions	8
3.4. EUT set-ups	8
3.5. Configuration of cables used for testing	9
3.6. EUT operating modes	10
3.7. Parameter Settings on mobile phone and base station CMU200	11
4. DESCRIPTION OF TEST SYSTEM SET-UP'S	12
4.1. Test system set-up for conducted measurements on antenna port	12
4.2. Test system set-up for radiated magnetic field measurements below 30 MHz	15
4.3. Test system set-up for radiated spurious emission measurements	16
5. MEASUREMENTS	17
5.1. RF-Parameter - RF Peak power output conducted and PAPR-value	17
5.2. RF-Parameter - Occupied bandwidth and emission bandwidth	19
5.3. RF-Parameter - Conducted out of Band RF emissions and Band Edge	20
5.4. RF-Parameter - Radiated out of Band RF emissions and Band Edge	24
5.5. RF-Parameter - Frequency stability on temperature and voltage variations	26
5.6. Measurement uncertainties	35
6. ABBREVIATIONS USED IN THIS REPORT	36
7. ACCREDITATION DETAILS OF CETECOM'S LABORATORIES AND TEST SITES	36
8. INSTRUMENTS AND ANCILLARY	37
9. VERSIONS OF TEST REPORTS (CHANGE HISTORY)	41

Table of annex

Total pages

Annex 1: Test result diagrams (separate document) CETECOM_TR16-1-0050601T39a-A1	75
Annex 2: External photographs of EUT (separate document) CETECOM_TR16_1_0050601T43a-A2	6
Annex 3: Internal photographs of EUT (separate document)	--
Annex 4: Test set-up photographs (separate document) CETECOM_TR16_1_0050601T43a-A4	5

The listed attachments are an integral part of this report.

1. Summary of test results

The test results apply exclusively to the test samples as presented in this Report. The CETECOM GmbH does not assume responsibility for any conclusions and generalizations taken in conjunction with other specimens or samples of the type of the item presented to tests.

The test results apply exclusively to the test samples as presented in this Report. The CETECOM GmbH does not assume responsibility for any conclusions and generalizations taken in conjunction with other specimens or samples of the type of the item presented to tests. Also we refer on special conditions which the applicant should fulfill according §2.927 to §2.948, special focus regarding modification of the equipment and availability of sample equipment for market surveillance tests.

The Equipment Under Test (in this report, hereinafter referred as EUT) supports radiofrequency technologies. This test report shows results for GPRS and (E)GPRS technologies only. Other implemented wireless technologies were not considered within this test report.

Following tests have been performed to show compliance with applicable FCC Part 2, Part 22, Subpart H, Part 24, Subpart E (Broadband PCS) of the FCC CFR Title 47 Rules, Edition 4th November 2016 and Canada RSS-132 Issue 3, RSS-133 Issue 6 and RSS-Gen Issue 4 standards.

1.1. TX mode, Test overview of FCC and Canada ISED (RSS) Standards

No. of Diagram group	Test Cases	Port	References & Limits			EUT set-up	EUT op-mode	Result
			FCC Standard	RSS Section	Test limit			
1	Emissions AC-Power lines conducted (0.15 to 30 MHz)	AC-Power lines	§15.207	RSS-Gen, Issue 4: Chapter 8.8	§15.207 limits IC: Table 3, Chapter 8.8	--	--	Remark 1.)
2	General field strength emissions radiated - (9 kHz to 30 MHz)	Enclosure + Inter-connecting cables (radiated)	§15.209(a)	RSS-Gen, Issue 4: Chapter 8.9, Table 5	2400/F(kHz) μ V/m 24000/F(kHz) μ V/m 30 μ V/m	2	2+5	passed
7	RF-Power (ERP/EIRP) radiated		§2.1046 §22.913(a)(2)	RSS-132: 5.4 SRSP-503: 5.1.3	< 11.5 Watt (EIRP) (mobile stations)	--	--	passed (calculated)
8	Spurious emissions radiated (30 MHz to... *tenth-times of the fundamental frequency)		§24.232(c)	RSS-133: 4.1/6.4 SRSP-510: 5.1.2	< 2 Watt (EIRP)	2	2+5	passed
			§2.1053(a) §2.1057 §22.917(a)(b) §24.238(a)(b)	RSS-132: 5.5(i)(ii) RSS-133: 6.5.1(i)(ii)	Required attenuation below P(dBW): 43+10log(P) dBc			
9	Band-Edge compliance				2	2+5	passed	

30	RF Power	Antenna terminal	§2.1046	RSS-132: 5.4 SRSP-503: 5.1.3	< 11.5 Watt (EIRP) (mobile stations)	1	2+3+5+ 6	passed
34	26dB Emission bandwidth		§2.202 §2.1049(h)	RSS-Gen, Issue 4: Chapter 6.6	< 2 Watt (EIRP)	1	2+5	passed
35	99% Occupied bandwidth		§22.917(a) §24.238(a)					
36	Spurious emissions		§2.1051 §2.1057	RSS-132: 5.5(i)(ii)	Required attenuation below P(dBW): 43+10log(P) dBc	1	2+5	passed
37	Band-Edge compliance		§22.917(a)(b) §24.238(a)(b)	RSS-133: 6.5.1(i)(ii)				
38	Frequency stability		§22.355, table C-1 §24.235 §2.1055(a)(2)	RSS-132: 5.3 RSS-133: 6.3	< ±2.5ppm <±0.1 ppm	3	2+5	passed Remark 3.)

Remarks: 1.) not applicable since car environment
 2.) calculated with declared antenna gain
 3.) Tests only performed across extreme voltage rang for information: limited approval
 OEM integrators should consult grant and applicants recommendations on power supply design rules.

1.2. RX mode, tests overview according FCC Part 15B and Canadian ISED (RSS) Standards

No. of Diagram group	Test case	Port	References & Limits			EUT set-up	EUT op-mode	Result
			FCC Standard	RSS Section	Test limit			
1	AC-Power Lines conducted Emissions	AC-Power lines	§15.107 §15.207	RSS-Gen, Issue4: Chapter 8.8	FCC §15.107 class B limits §15.207 limits RSS-Gen: Table 3	--	--	Not applicable 1.)
3	Receiver radiated emissions	Cabinet + Interconnec ting cables	§15.109 §15.33 §15.35	RSS-132, Issue 3: 6.6 RSS-Gen, Issue 4: 5.3 RSS 133, Issue 6: 6.6	FCC 15.109 class B limits RSS-Gen: Chapter 5.3+Chapter 7.1.2	--	--	Passed Remark 2

Remark:
 1.) EUT intended for car environment only
 2.) See separate test report CETECOM_TR16_1_0050601T43a for measurements according Part 15, Subpart B.

1.3. Attestation:

I declare that all measurements were performed by me or under my supervision and that all measurements have been performed and are correct to my best knowledge and belief to Industry Canada standards. All requirements as shown in above table are met in accordance with enumerated standards.

Digital unterschrieben von Rachid Acharkaoui
 DN: cn=Rachid Acharkaoui,
 o=CETECOM GmbH,
 ou=RC&EMC,
 email=rachid.acharkaoui@cetecom.com, c=DE
 Datum: 2017.09.13 08:56:21 +02'00'

Dipl.-Ing. Rachid Acharkaoui
 Responsible for test section

Digitally signed
 by Martin Nunier
 Date: 2017.09.12
 15:54:16 +02'00'

M. Nunier
 Responsible for test report

2. Administrative Data

2.1. Identification of the testing laboratory

Company name:	CETECOM GmbH
Address:	Im Teelbruch 116 45219 Essen - Kettwig Germany
Responsible for testing laboratory:	Dipl.-Ing. Rachid Acharkaoui
Deputy:	Dipl.-Ing. Niels Jeß

2.2. Test location

2.2.1. Test laboratory "CTC"

Company name:	see chapter 2.1. Identification of the testing laboratory
---------------	---

2.3. Organizational items

Project leader:	Dipl.-Ing. Mario Schmidt-Mecklenbrauck
Responsible for test report:	M. Nunier
Receipt of EUT:	2017-01-18
Date(s) of test:	2017-01-20 to 2017-07-14
Date of report:	2017-08-24

Version of template:	13.02

2.4. Applicant's details

Applicant's name:	peiker acoustic GmbH & Co. KG
Address:	Max-Planck-Straße 28-32 61381 Friedrichsdorf/ts. Germany
Contact person:	Philippe Seguret

2.5. Manufacturer's details

Manufacturer's name:	please see Applicant's details
Address:	please see Applicant's details

3. Equipment under test (EUT)

3.1. TECHNICAL DATA OF MAIN EUT DECLARED BY APPLICANT

GSM Frequency range (US/Canada -bands)	<input checked="" type="checkbox"/> GSM 850: 824 – 849 MHz (Uplink), 869-894 MHz (Downlink) <input checked="" type="checkbox"/> GSM1900: 1850-1910 MHz (Uplink), 1930-1990 MHz (Downlink)
Type of modulation	<input checked="" type="checkbox"/> GSM,GPRS: GMSK <input checked="" type="checkbox"/> EGPRS-Mode: 8-PSK
Number of channels (USA/Canada -bands)	<input checked="" type="checkbox"/> GSM 850: 128 – 251, 125 channels <input checked="" type="checkbox"/> GSM1900: 512 – 810, 300 channels
Test Channel frequencies	<input checked="" type="checkbox"/> GSM/E-GPRS 850 MHz Band: Channel 128/192/251 <input checked="" type="checkbox"/> GSM/E-GPRS 1900 MHz Band: Channel 512/661/810
Emission designator(s)	245KGXW (GSM850) 247KGXW (EDGE850) 245KG7W (GSM1900) 245KG7W (EDGE 1900)
Antenna Type	<input type="checkbox"/> Integrated (enclosure) <input type="checkbox"/> External - dedicated, no RF- connector <input checked="" type="checkbox"/> External, separate RF-connector
Antenna Gain Tx (main)	<input type="checkbox"/> Not applicable <input checked="" type="checkbox"/> from data sheet “BMW_Multibandantenna_Max Gain Tel GNSS_en” 699MHz – 716MHz: 8.3dBi 824MHz – 849MHz: 7.8dBi 1710MHz – 1755MHz: 7.3dBi 1850MHz – 1910MHz: 8.9dBi 2500MHz – 2570MHz: 6.8dBi <input type="checkbox"/> No information from customer
Path Losses	<input checked="" type="checkbox"/> from data sheet “TEL1_NAD_to_TEL1_TRUNK_table” GSM 850: 3.04dB GSM 1900: 5.74dB

Measured Output Power [dBm]: Conducted GSM 850 Conducted EDGE850	AV: 31.95/ PK: 32.57 AV: 26.44/ PK: 29.40		
Measured Output Power [dBm]: Conducted GSM 1900 Conducted EDGE 1900	AV:29.24 / PK:29.75 AV:25.15 / PK:28.06		
Peak EIRP [dBm]: GSM 850 EDGE850	(Peak Output Power + Antenna Gain – Path losses) 31.95dBm + 7.8dBi-3.04dB= 36.71dBm 29.40dBm + 7.8dBi-3.04dB= 34.16dBm		
Peak ERP [dBm]: GSM 850 EDGE850	(Peak EIRP – 2.15 = ERP) 36.71dBm – 2.15 = 34.56dBm 34.16dBm – 2.15 = 32.01dBm		
Peak EIRP [dBm]: GSM 1900 EDGE 1900	(Peak Output Power + Antenna Gain – Path losses) 29.75dBm + 8.9dBi-5.74dB= 32.91dBm 28.06dBm + 8.9dBi-5.74dB= 31.22dBm		
Installed options	<input checked="" type="checkbox"/> GSM 900 and GSM 1800 Bands (not usable in USA/Canada) <input checked="" type="checkbox"/> W-CDMA Band I and Band VIII (not usable in USA/Canada) <input checked="" type="checkbox"/> GPS (not tested within this test report)		
Power supply	<input checked="" type="checkbox"/> DC power only: 12Volt		
Special EMI components	--		
Does EUT contain devices susceptible to magnetic fields, e.g. Hall elements, electrodynamic microphones, etc.?	<input checked="" type="checkbox"/> yes <input type="checkbox"/> no		
Highest radio frequency signal	Assumed to be highest TX carrier frequency: 1908.8MHz (Ch810)		
EUT sample type	<input type="checkbox"/> Production	<input checked="" type="checkbox"/> Pre-Production	<input type="checkbox"/> Engineering
FCC label attached	<input type="checkbox"/> yes	<input checked="" type="checkbox"/> no	

3.2. EUT: Type, S/N etc. and short descriptions used in this test report

Short description*)	EUT	Type	S/N serial number	HW hardware status	SW software status
EUT A	GSM/ WCDMA/ LTE Telematics US Module	V1231-0	004402580040446	V1231-0_Ver.1	MPSS.TH.2.0.2-00256
EUT B	Kathrein Cellular/GNSS antenna	Model No: 9396828	50110256	--	--
EUT C	Kathrein Cellular antenna	Model No: 9396827	50110255	--	--
EUT D	GSM/WCDMA/LTE Telematics US Module	V1231-0	004402580040248	V1231-0_Ver.1	MPSS.TH.2.0.2.c4-00018

*) EUT short description is used to simplify the identification of the EUT in this test report.

3.3. Auxiliary Equipment (AE): Type, S/N etc. and short descriptions

AE short description *)	Auxiliary Equipment	Type	S/N serial number	HW hardware status	SW software status
AE 1	Loudspeaker	KL3 / 4-Ohm	-	-	-
AE 2	Microphone	ME 39	-	-	-
AE 3	DC cable	--	--	--	--
AE 4	Dell Laptop Computer	DELL Latitude D610	EMC#3	Pentium IV Centrino	Windows XP Professional

*) AE short description is used to simplify the identification of the auxiliary equipment in this test report.

3.4. EUT set-ups

EUT set-up no. *)	Combination of EUT and AE	Remarks
set. 1	EUT A + AE 3	RF-Conducted Measurement set-up
set. 2	EUT A + EUT 2 + EUT 3+ AE 1 + AE 2 + AE 3	RF-radiated measurement set-up
set. 3	EUT D + AE3	Frequency stability measurement set-up

*) EUT set-up no. is used to simplify the identification of the EUT set-up in this test report.

3.5. Configuration of cables used for testing

Cable number	Item	Type	S/N serial number	HW hardware status	Cable length
Cable 1	DC line	--	--	--	<3m
Cable 2	Microphone line	--	--	--	<3m
Cable 3	Speaker line	--	--	--	<3m
Cable 4	GPS antenna cable	--	--	--	<3m
Cable 5	Antenna cable TRX	--	--	--	<3m
Cable 6	Antenna cable DRX	--	--	--	<3m

3.6. EUT operating modes

EUT operating mode no.)*	Description of operating modes	Additional information
op. 1	GSM 850-Voice Traffic channels = 128/192/251	A communication link is established between the mobile station and the test simulator. The transmitter is operated at its maximum rated output power: 33 dBm (power class 4; power control level 5). The input signal to the receiver is modulated with normal test modulation. The wanted RF input signal level to the receiver of the mobile station is set to a level to provide a stable communication link.
op. 2	GPRS 850 Data Traffic channels = 128/192/251	A communication link is established between the mobile station and the test simulator. The transmitter is operated at its maximum rated output power: 33 dBm (power class 4; power control level 5). USF_Duty CYCLE set to 100%, coding scheme CS-1 for GMSK modulation, slot 3 active, uplink gamma: 3 (33 dBm). The input signal to the receiver is modulated with normal test modulation. The wanted RF input signal level to the receiver of the mobile station is set to a level to provide a stable communication link.
op. 3	E-GPRS 850 Data Traffic channels = 128/192/251	A communication link is established between the mobile station and the test simulator. The transmitter is operated at its maximum rated output power: 33 dBm (power class 4; power control level 5). USF_Duty CYCLE set to 100%, coding scheme MCS-5 for 8PSK modulation, slot 3 active, uplink gamma: 6 (27dBm). The input signal to the receiver is modulated with normal test modulation. The wanted RF input signal level to the receiver of the mobile station is set to a level to provide a stable communication link.
op. 4	GSM1900-Voice Traffic channels = 512/661/810	A communication link is established between the mobile station and the test simulator. The transmitter is operated at its maximum rated output power: 30 dBm (power class 1; power control level 0). The input signal to the receiver is modulated with normal test modulation. The wanted RF input signal level to the receiver of the mobile station is set to a level to provide a stable communication link
op. 5	GPRS 1900 Data Traffic channels = 512/661/810	A communication link is established between the mobile station and the test simulator. The transmitter is operated at its maximum rated output power: 30 dBm (power class 1; power control level 0). USF_Duty CYCLE set to 100%, coding scheme CS-1 for GMSK modulation, slot 3 active, uplink gamma: 3 (30 dBm). The input signal to the receiver is modulated with normal test modulation. The wanted RF input signal level to the receiver of the mobile station is set to a level to provide a stable communication link
op. 6	E-GPRS 1900 Data traffic channels = 512/661/810	A communication link is established between the mobile station and the test simulator. The transmitter is operated at its maximum rated output power: 30 dBm (power class 1; power control level 0). USF_Duty CYCLE set to 100%, coding scheme MCS-5 for 8-PSK modulation, slot 3 active, uplink gamma: 5 (26 dBm). The input signal to the receiver is modulated with normal test modulation. The wanted RF input signal level to the receiver of the mobile station is set to a level to provide a stable communication link.

*) EUT operating mode no. is used to simplify the test report.

3.7. Parameter Settings on mobile phone and base station CMU200

Following settings apply to the MS during the measurements in **GSM/(E)GPRS-Mode** only:

Parameter	Traffic Mode	Idle Mode
Traffic Channels mobile station (EUT)	GSM 850: TCH _{MS} = 128/ 192 /251 GSM 1900: TCH _{MS} = 512 / 661 / 810	--
maximum power level (PCL)	GSM 850: PCL = 5 (2 Watt) GSM 1900: PCL = 0 (1 Watt)	--
Modulation	GSM/GPRS: GMSK-Modulation Scheme EDGE: 8-PSK Modulation Scheme	--
DTX	off	--
Bitstream	PRBS 2E9-1 (pseudo-random-sequence) – CCITT 0.153	
Timeslot(s) in Uplink	3	
Hopping	off	
Timeslot (slot mode)	GSM-Mode: single GPRS-Mode: slot no. 3 active uplink	
Maximum data transmission rate, single time slot	GSM: 9,6 kbit/s Slot GPRS: 17,6 kbit/s Slot EDGE: 59,2 kBit/s Slot	
Speech transcoding (Traffic Mode)	Full rate Version 1	
Speed rate	130 Kb/s	
Mode	BCCH and TCH	
BCCH – base station (CMU,CMD)	GSM 850: 182 GSM 1900: 651	
TCH – base station (CMD, CMU)	auto	
Power level TCH – base station (used timeslot level)	- 70 dBm	
Power level BCCH – base station (control channel level)	- 80 dBm	
External attenuation RF/AF-Input/Output	Accord. calibration prior to measurements	
Mobile Country Code	310	310
Domain	CS	
BS_AG_BLKS_RES	Not applicable	0
Paging reorganisation		Off (0)
Signalling channel		SDCCH
Location Update		Auto
Cell access		Disabled (barred)

Settings for CMU (general)

Repetition	Continuous	
Stop condition	None	
Display mode	Max./Min	
Statistic Count	1000 Bursts	
Decoder	Standard	

Additional settings on the base stations CMU200 for frequency stability measurements

4. Description of test system set-up's

4.1. Test system set-up for conducted measurements on antenna port

Cellular Conducted RF-Setup 1 (Cel-1 Set-up)

Tests Specification: Conducted spurious emissions, Emission Bandwidth

General Description: The EUT's RF-signal is coupled out by a suitable antenna coupling connector (1). The signal is first attenuated (2) before it is 0° divided by a power divider (3). One of the RF-signal path is connected to the test unit communication tester (4), other RF-path is connected to the spectrum – analyzer (5) for specific RF-measurements. The specific attenuation losses for both signal paths/branches are determined prior to the measurement within a set-up calibration. These are then taken into account by correcting the measurement readings on the spectrum-analyzer.

Schematic:

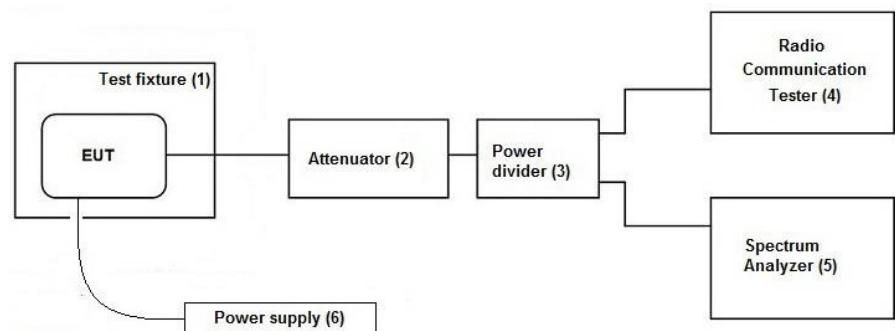

Used Equipment:

Passive Elements	Test Equipment	Remark:
<input checked="" type="checkbox"/> 10 dB Attenuator (#530)	<input checked="" type="checkbox"/> CMU200 Communication Test-Unit for GSM/W-CDMA	See List of equipment under each test case and chapter 8 for calibration info
<input checked="" type="checkbox"/> Low loss RF-cables	<input checked="" type="checkbox"/> DC-Power Supply	
<input checked="" type="checkbox"/> 6 dB resistive power divider/coupler (#529)	<input checked="" type="checkbox"/> Spectrum-Analyser	

Testing method: ANSI C63.10:2013, KDB 971168 D01 v02r02

Measurement uncertainty: See chapter Measurement Uncertainties (Cel-1)

In case an external connector is available (test fixture), following set-up is used for measurements of frequency error.

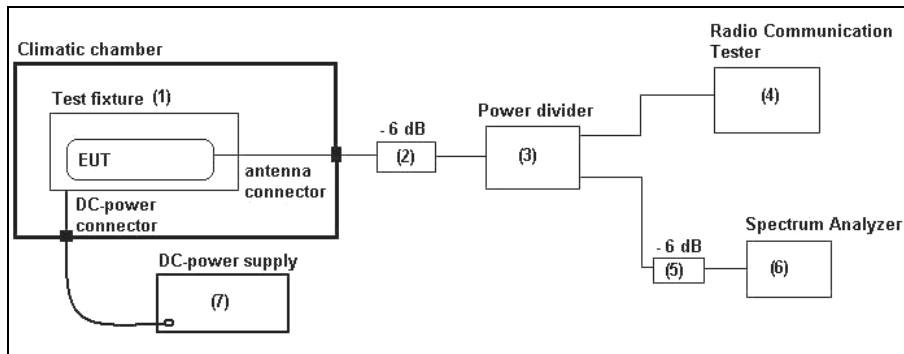

Schematic: Test set-up conducted within climatic chamber

Cellular Conducted RF-Setup 2 (Cel-2 Set-up)

Tests Specification: Conducted Carrier power, Frequency Error

Schematic: Following modified test set-up apply for tests performed inside the climatic chamber (frequency stability) or conducted RF-carrier power-measurement. The EUT RF-Signal is directly connected over suitable RF-connector over low-loss cable and an attenuator (2) to the cellular radio communication test-unit. (5)

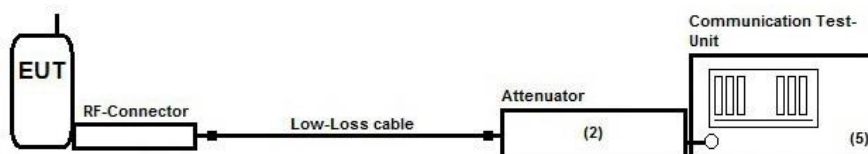

Testing method: ANSI C63.10:2013, KDB 971168 D01 v02r02

Used Equipment	Passive Elements	Test Equipment	Remark:
	<input checked="" type="checkbox"/> 20 dB Attenuator (#613)	<input checked="" type="checkbox"/> CMU200 Communication Test-Unit for GSM/W-CDMA	See List of equipment under each test case and chapter 8 for calibration info
	<input checked="" type="checkbox"/> Low loss RF-cables	<input checked="" type="checkbox"/> DC-Power Supply	

Measurement uncertainty See chapter Measurement Uncertainties (Cel-2)

4.2. Test system set-up for radiated magnetic field measurements below 30 MHz

Specification: ANSI C63.4-2014 §5.3, §8.2.1, §8.3.1.1+§8.3.2.1 , ANSI C63.10-2013 chapter 6.4 (§6.4.4.2)

General Description: Evaluating the radiated field emissions are done first by an exploratory emission measurement and a final measurement for most critical frequencies determined.

The loop antenna was placed at 1 m height above ground plane and 3 m measurement distance from set-up for investigations. Because of reduced measurement distance, correction data were applied, as stated in chapter “General Limit - Radiated field strength emissions below 30 MHz“. The tests are performed in the semi anechoic room recognized by the regulatory commission.

Schematic:

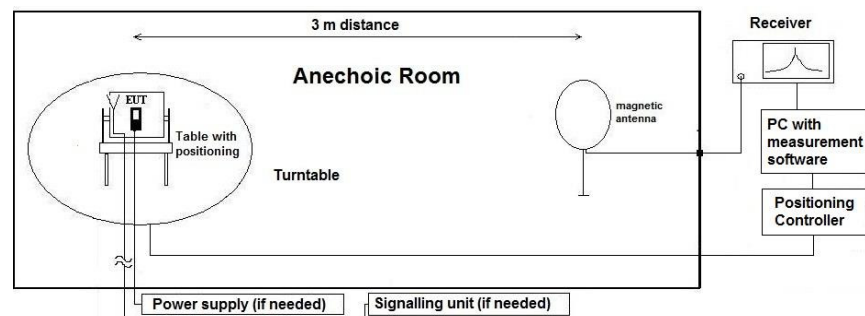

Testing method:

Exploratory, preliminary measurement

The EUT and its associated accessories are placed on a non-conductive position manipulator (tipping device) of 0.8 m height which is placed on the turntable. By rotating the turntable (step 90°, range 0° to 360°) and the EUT itself either on 3-orthogonal axis (portable equipment) or 2-orthogonal axis (defined operational position of EUT), the emission spectrum was recorded. The loop antenna was moved at least to 2-perpendicular axes (antenna vector in direction of EUT and parallel to EUT) in order to maximize the emissions. The results are documented in a diagram. Critical frequencies (low margin to limit) are saved within a data reduction table for further investigations. If various operating modes are supported, further investigations are made to find the worst-case. Also the interconnection cables and equipment position were varied in order to maximize the emissions.

Final measurement on critical frequencies

Based on the exploratory measurements, the most critical frequencies are re-measured by maintaining the EUT's worst-case operation mode, cable position, etc.

First a frequency zoom around the critical frequency is done to locate the frequency more precisely. After this step, for all identified critical frequencies, the maximum peak was determined.

Following parameters were varied: the turntable angle continuously in the range 0 to 360 degree, the EUT itself either over 3-orthogonal axis (not defined usage position) or 2-orthogonal axis (defined usage position).

On the determined worst-case position, a final measurement with necessary bandwidth and detector according standard has been carried out.

Formula:

$$E_C = E_R + AF + C_L + D_F - G_A$$

$$M = L_T - E_C$$

AF = Antenna factor

C_L = Cable loss

D_F = Distance correction factor

E_C = Electrical field – corrected value

E_R = Receiver reading

G_A = Gain of pre-amplifier (if used)

L_T = Limit

M = Margin

All units are dB-units, positive margin means value is below limit.

Distance correction:

Reference for applied correction (extrapolating) factors due to reduced measurement distance:

ANSI C63.10:2013, §6.4.4.2 - Equations (2) + (3) + (4)

4.3. Test system set-up for radiated spurious emission measurements

Specification: ANSI C63.4-2014 chapter 8.3, ANSI C63.10-2013 chapter 6.6.3.3 & 6.6.4, ANSI C63.26-2015, Chapter 4.6.3.3

General Description: Evaluating the emissions have to be done first by an exploratory emissions measurement and a final measurement for most critical frequencies. The tests are performed in a CISPR 16-1-4:2010 compliant fully anechoic room (FAR) recognized by the regulatory commission. The measurement distance was set to 3 meter for frequencies up to 18 GHz and 2 meter above 18 GHz. A logarithmic periodic antenna is used for the frequency range 30 MHz to 1 GHz. Horn antennas are used for frequency range 1 GHz to 40 GHz. The EUT is aligned within 3 dB beam width of the measurement antenna with three orthogonal axis measurements on the EUT.

Schematic:

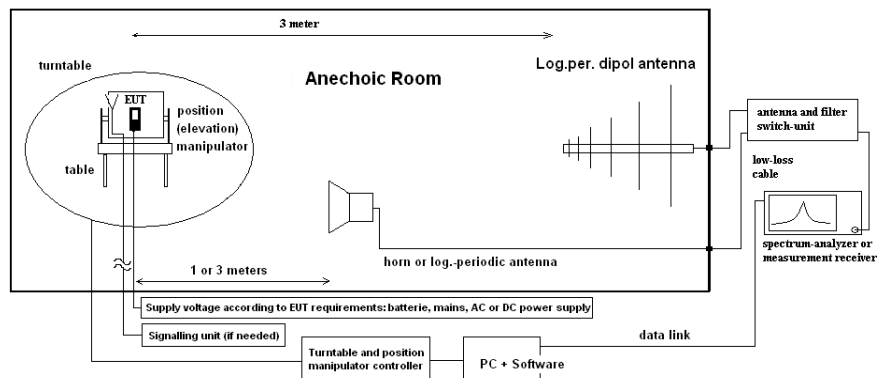

Testing method:

Exploratory, preliminary measurements

The EUT and its associated accessories are placed on a non-conductive position manipulator (tipping device) of 1.50 m height which is placed on the turntable. By rotating the turntable (range 0° to 360°, step 45°) and the EUT itself on 3-orthogonal axis (the emission spectrum and its characteristics was recorded with an EMI-receiver, broadband antenna and software. The measurements are performed in horizontal and vertical polarization of the measurement antennas. The results are documented in a diagram. Critical frequencies (low margin to limit) are saved within a table for further investigations. If various operating modes are supported, further investigations are made to find the worst-case of them. Also the interconnection cables and equipment position were varied in order to maximize the emissions.

Final measurement on critical frequencies

Based on the exploratory measurements, the most critical frequencies are re-measured by maintaining the EUT’s worst-case operation mode, cable position, etc. First a frequency zoom around the critical frequency is done to locate the frequency more precisely. After this step, for all identified critical frequencies, the maximum peak was determined. Following parameters were varied: the turntable angle continuously in the range 0 to 360 degree, the EUT itself over 3-orthogonal axis and the height for EUT with large dimensions. On the determined worst-case position, a final measurement with necessary bandwidth and detector according standard has been carried out. The readings on the spectrum analyzer are corrected with conversion value between field strength and E(I)RP, so the readings shown are equivalent to ERP/EIRP values. Critical measurements near the limit are re-measured with a substitution method accord. ANSI/TIA/EIA 603 C/D

Formula:

$$E_C = E_R + AF + C_L + D_F - G_A \quad (1)$$

$$E_{CE(I)RP} = E_C - 95.2 \text{ dB}$$

$$M = L_T - E_{CE(I)RP}$$

- E_C = Electrical field – corrected value
- E_R = Receiver reading
- M = Margin
- L_T = Limit
- AF = Antenna factor
- C_L = Cable loss
- D_F = Distance correction factor (if used)
- G_A = Gain of pre-amplifier (if used)
- $E_{CE(I)RP}$ = Electrical field corrected for E(I)RP

All units are dB-units, positive margin means value is below limit.

5. Measurements

5.1. RF-Parameter - RF Peak power output conducted and PAPR-value

5.1.1. Test location and equipments

test location	<input checked="" type="checkbox"/> CETECOM Essen (Chapter. 2.2.1)	<input type="checkbox"/> Please see Chapter. 2.2.2			
test site	<input checked="" type="checkbox"/> 347 Radio.lab. 1	<input type="checkbox"/> Radio.lab. 2			
spectr. analys.	<input type="checkbox"/> 584 FSU	<input checked="" type="checkbox"/> 489 ESU 40	<input type="checkbox"/> 264 FSEK	<input type="checkbox"/> 620 ESU 26	
signaling	<input type="checkbox"/> 392 MT8820A	<input checked="" type="checkbox"/> 436 CMU	<input type="checkbox"/> 547 CMU		
otherwise	<input type="checkbox"/> 110 USB LWL				
DC power	<input type="checkbox"/> 456 EA 3013A	<input checked="" type="checkbox"/> 463 HP3245A	<input type="checkbox"/> 459 EA 2032-50	<input type="checkbox"/> 268 EA- 3050	<input type="checkbox"/> 494 AG6632A <input type="checkbox"/> 498 NGPE 40
otherwise	<input type="checkbox"/> 331 HC 4055	<input checked="" type="checkbox"/> 630 10 dB Att.	<input checked="" type="checkbox"/> 529 6dB-Power divider	<input checked="" type="checkbox"/> - cable OTA20	
line voltage	<input type="checkbox"/> 230 V 50 Hz via public mains		<input type="checkbox"/> 060 120 V/ 60 Hz via PAS 5000		

5.1.2. Requirements and limits

FCC	§2.1046(a)
ISED	RSS-132 : 5.4 + SRSP 503 :5.1.3 for GSM 850 RSS-133 4.1/6.4 + SRSP-510 :5.1.2 for GSM 1900
ANSI	C63.26-2015
Limit	Maximum conducted output power of the transmitter should be determined while measured on RF output terminal.
	Limit GSM850: 7 Watt (38.4 dBm)
	Limit GSM1900: 2 Watt (33.0 dBm)
	PAPR≤13 dB

5.1.3. Test condition and test set-up

Climatic conditions	Temperature: (22±3°C)	Rel. humidity: (40±20)%
Test system set-up	Please see chapter "Test system set-up for conducted measurements on antenna port"	
Measurement method	<p>The measurements were performed with the integrated power measurement function of the „radio communication tester CMU200 from Rohde&Schwarz company. In this way spectrum-analyzers instrument limitations can be avoided or minimized. Instead, CMU manufacturers declared measurement error can be considered for this measurement.</p> <p>The attenuation (insertion loss) at the RF Inputs/Outputs of CMU were set according the path loss of the test set-up, determined in a step before starting the measurements. A suitable artificial antenna or RF-connector is provided by the applicant in order to perform the conducted measurements. Any data provided with the artificial antenna or connector, have been taken in account in order to correct the measurement data. (typical 0.3dB for attenuation of antenna connector)</p> <p>Peak and Average Values have been recorded for each channel on test set-up Cel-2. The Peak-to - Average-Power Ratio is determined on test set-up Cel-1 with corresponding settings. (see plots). The guideline in ANSIC63.26-2016 is taken into account.</p>	
Mobile phone settings	<p>A call was established with settings according chapter "Parameter settings on mobile phone and base station CMU200"</p> <p>UE Power should be set to maximum, continuous transmission. DTX or other power saving techniques have been disabled</p> <p>The measurements were made at the low, middle and high carrier frequencies of each of the supported operating band. Choosing three TX-carrier frequencies of the mobile phone, should be sufficient to demonstrate compliance.</p>	

5.1.4. Measurement results

Op. Mode 2, Set-up 1

Op. Mode	Carrier Channel		Peak Output Power [dBm]	Average Output Power [dBm]	PAPR-Ratio on 0.1% probability [dB]	Peak power Limit [dBm]	PAPR-Limit [dB]	Result
	Range	No.						
GSM 850	Low	128	32.57	31.95	0.62	38.4	13	Passed
	Middle	192	32.50	31.85	0.63			
	High	251	32.57	31.93	0.63			

Remark: --

Op. Mode 3, Set-up 1

Op. Mode	Carrier Channel		Peak Output Power [dBm]	Average Output Power [dBm]	PAPR-Ratio on 0.1% probability [dB]	Peak power Limit [dBm]	PAPR-Limit [dB]	Result
	Range	No.						
E-GPRS 850	Low	128	29.40	26.44	2.95	38.4	13	Passed
	Middle	192	29.18	26.19	2.97			
	High	251	29.33	26.17	3.13			

Remark: --

Op. Mode 5, Set-up 1

Op. Mode	Carrier Channel		Peak Output Power [dBm]	Average Output Power [dBm]	PAPR-Ratio on 0.1% probability [dB]	Peak power Limit [dBm]	PAPR-Limit [dB]	Result
	Range	No.						
GSM 1900	Low	512	29.75	29.24	0.50	33.0	13	Passed
	Middle	661	29.25	28.72	0.53			
	High	810	28.83	28.33	0.50			

Remark: --

Op. Mode 6, Set-up 1

Op. Mode	Carrier Channel		Peak Output Power [dBm]	Average Output Power [dBm]	PAPR-Ratio on 0.1% probability [dB]	Peak power Limit [dBm]	PAPR-Limit [dB]	Result
	Range	No.						
E-GPRS 1900	Low	512	28.06	25.15	2.89	33.0	13	Passed
	Middle	661	27.63	24.51	3.10			
	High	810	27.21	24.18	3.03			

Remark: --

Benutzte Geräte:	Geräte:	10dB #630		
		Kabel SMA/SMA no. 1201/1m lang		
	Datum:	05.04.2017	CMU200 #670	
	DUT:	NIWJG46I001MC01		

5.2. RF-Parameter - Occupied bandwidth and emission bandwidth

5.2.1. Test location and equipments

(for reference numbers please see chapter 'List of test equipment')						
test site	<input checked="" type="checkbox"/> 347 Radio.lab. 1	<input type="checkbox"/> Radio.lab. 2				
spectr. analys.	<input type="checkbox"/> 584 FSU	<input checked="" type="checkbox"/> 489 ESU40	<input type="checkbox"/> 264 FSEK	<input type="checkbox"/> 620 ESU26		
signaling	<input type="checkbox"/> 392 MT8820A	<input type="checkbox"/> 436 CMU	<input checked="" type="checkbox"/> 547 CMU			
DC Power	<input type="checkbox"/> 463 HP3245A	<input type="checkbox"/> 087 EA3013	<input checked="" type="checkbox"/> 354 NGPE 40	<input type="checkbox"/> 086 LNG50-10		
otherwise	<input checked="" type="checkbox"/> 529 6dB divider	<input checked="" type="checkbox"/> 530 10dB Att.	<input type="checkbox"/> 431 Near field			
line voltage	<input type="checkbox"/> 230 V 50 Hz via public mains		<input type="checkbox"/> 060 120 V/ 60 Hz via PAS 5000			

5.2.2. Requirements and Limits

FCC	§2.202(a), §2.1049(h), §22.917(b), §24.238(b)	„the occupied bandwidth is the frequency bandwidth, such that, below it lower and above it upper frequency limits, the mean powers radiated are each equal to 0.5 percent of the total mean power radiated”
ISED	RSS-Gen, Issue 4: §6.6	
ANSI	C63.26-2015, Chapter 5.4	

5.2.3. Test condition and test set-up

Climatic conditions		Temperature: (22±3°C)	Rel. humidity: (40±20)%
Test system set-up		Please see chapter “Test system set-up for conducted measurements at antenna port”	
Spectrum Analyzer Settings	Parameter	Occupied bandwidth:	Emission bandwidth
	Scan Mode Span RBW VBW Sweep time Sweep mode Detector	Spectrum analyser mode 1 MHz 3 kHz 30 kHz Coupled Repetitive, max-hold Peak	Spectrum analyser mode 1 MHz 3 kHz 30 kHz Coupled Repetitive, max-hold Peak
Measurement method		The used spectrum analyzer FSE or ESU from Rohde & Schwarz contains an integrated function to calculate the occupied bandwidth automatically. From left and right display margin, the upper and lower frequency points where the accumulated power becomes 0.5% of the total power, are calculated. Subtracting the previous determined two frequency points, yields the occupied bandwidth.	Bandwidth defined between 2 markers with are 26dBc compared to highest In-Band Peak Emission.
EUT settings		Provisions with the requirements is based on the fact, that GSM modulation scheme is GMSK Modulation for GSM equipment with a maximum data transmission rate of 17,6 kBit/s per Slot. Provisions with the requirements is based on the fact, that EDGE modulation scheme is 8-PSK Modulation for EDGE equipment with a maximum data transmission rate of 69,2 kBit/s per Slot. A call was established with settings according chapter “Parameter settings on wireless device and base station CMU200”	

5.2.4. Measurement results

Operating mode/band Set-up	Carrier Channel		Occupied 99% bandwidth [kHz]	26 dBc Emission bandwidth [kHz]
	Range	No.		
Set-up 1, Op-Mode 2				
GSM 850	Low	128	245.1923	317.3076
	Middle	192	245.1923	317.3076
	High	251	243.5897	317.3076
Set-up 1, Op-Mode 3				
E-GPRS 850	Low	128	246.7948	314.1025
	Middle	192	243.5897	314.1025
	High	251	246.7948	315.7051
Set-up 1, Op-Mode 5				
GSM 1900	Low	512	245.1923	317.3076
	Middle	661	243.5897	315.7051
	High	810	243.5897	309.2948
Set-up 1, Op-Mode 6				
E-GPRS 1900	Low	512	245.1923	310.8974
	Middle	661	245.1923	315.7051
	High	810	245.1923	309.2948

Remarks: see annex diagrams

5.3. RF-Parameter - Conducted out of Band RF emissions and Band Edge

5.3.1. Test location and equipments (for reference numbers please see chapter 'List of test equipment')

test location	<input checked="" type="checkbox"/> CETECOM Essen (Chapter. 2.2.1)	<input type="checkbox"/> Please see Chapter. 2.2.2	<input type="checkbox"/> Please see Chapter. 2.2.3
test site	<input type="checkbox"/> 347 Radio.lab. 1	<input checked="" type="checkbox"/> Radio.lab. 2	
spectr. analys.	<input type="checkbox"/> 584 FSU	<input type="checkbox"/> 120 FSEM	<input type="checkbox"/> 264 FSEK <input checked="" type="checkbox"/> 489 ESU <input type="checkbox"/> 620 ESU26
signaling	<input type="checkbox"/> 017 CMD 65	<input type="checkbox"/> 323 CMD 55	<input type="checkbox"/> 340 CMD 55
signaling	<input type="checkbox"/> 392 MT8820A	<input type="checkbox"/> 436 CMU	<input checked="" type="checkbox"/> 547 CMU
power supply	<input checked="" type="checkbox"/> 463 HP3245A	<input type="checkbox"/> 457 EA 3013A	<input type="checkbox"/> 459 EA 2032-50 <input type="checkbox"/> 268 EA- 3050 <input type="checkbox"/> 494 AG6632A <input type="checkbox"/> 498 NGPE 40
otherwise	<input checked="" type="checkbox"/> 529 6dB divider	<input checked="" type="checkbox"/> 530 10dB Att.	<input type="checkbox"/> 431 Near field
line voltage	<input type="checkbox"/> 230 V 50 Hz via public mains	<input type="checkbox"/> 060 120 V/ 60 Hz via PAS 5000	

5.3.2. Requirements and limits

FCC	<input checked="" type="checkbox"/> Part 2.1051, Part2.1057(a)(1) <input checked="" type="checkbox"/> Part 22 Subpart H, §22.917(a)(b)(c)(d) <input checked="" type="checkbox"/> Part 24 Subpart E, §24.238(a)(b)(c)(d)
IC	<input checked="" type="checkbox"/> RSS-132, Issue 3: 5.5(i)(ii) <input checked="" type="checkbox"/> RSS-133, Issue 6: 6.5.1(i)(ii)
ANSI	C63.26-2015, Chapter 5.7
Limit	§22.917(a) & §24.238(a): “The power of any emission outside of the authorized operating frequency ranges must be attenuated below the transmitting power (P) by a factor of at least $43 + 10 \log(P)$ dB” Resulting Limit of-13dBm for all Power Control Levels of the cellular equipment

5.3.3. Test condition and test set-up

Climatic conditions	Temperature: (22±3°C)	Rel. humidity: (40±20)%
Test system set-up	Please see chapter “Test system set-up for conducted measurements on antenna port”	
Measurement method	<p>“§ 2.1057 Frequency spectrum to be investigated. (a) In all of the measurements set forth in § 2.1051 and 2.1053, the spectrum shall be investigated from the lowest radio frequency signal generated in the equipment, without going below 9 kHz”</p> <p>The spectrum was scanned from 9 kHz (depend on the equipment, s. §2.1057) to the 10th harmonic of the highest frequency generated within the equipment. A PEAK detector was used except measurements near the block-edge where also a AVERAGE detector can be applied.</p> <p>A suitable artificial antenna or RF-connector is provided by the applicant in order to perform the conducted measurements. Any data provided with the artificial antenna or connector, have been taken in account in order to correct the measurement data. (typical 0.3dB for attenuation of antenna connector)</p>	
Spectrum-Analyzer settings	See below tables	
EUT settings	<p>A call was established with settings according chapter “Parameter settings on mobile phone and base station CMU200”</p> <p>UE Power should be set to maximum, continuous transmission. DTX or other power saving techniques have been disabled.</p> <p>The measurements were made at the low, middle and high carrier frequencies of each of the supported operating band. Choosing three TX-carrier frequencies of the wireless device, should be sufficient to demonstrate compliance.</p>	

5.3.4. Spectrum-Analyzer settings for GPRS/E-GPRS 850

Sweep No.	Start freq. MHz	Stop freq. MHz	R-BW MHz	V-BW MHz	Sweep time sec.	Att. [dB]	Detector
Sweep 1 (subrange 1)	0.009	1	0.001	0.01	10	25	PK or RMS
Sweep 1 (subrange 2)	1	30	0.1	1	5	25	PK or RMS
Sweep 2 (subrange 1)	30	1000	0.1	1	10	35	PK or RMS
Sweep 2 (subrange 2)	1000	2800	0.1	1	2	45	PK or RMS
Sweep 2 (subrange 3)	2800	9000	1	10	100	35	PK or RMS
Sweep 3a (Band-Edge)	823	824	0.003	0.01	70	35	PK
Sweep 3b (Band-Edge)	823	824	0.003	0.01	70	35	RMS
Sweep 4a (Band-Edge)	849	850	0.003	0.01	70	35	PK
Sweep 4b (Band-Edge)	849	850	0.003	0.01	70	35	RMS

5.3.5. Spectrum-Analyzer Settings GPRS/E-GPRS 1900

	Start freq. MHz	Stop freq. MHz	R-BW MHz	V-BW MHz	Sweep time sec.	Att.	Detector
Sweep 1 (subrange 1)	0.009	1	0.001	0.01	10	25	PK or RMS
Sweep 1 (subrange 2)	1	30	0.1	1	5	25	PK or RMS
Sweep 2 (subrange 1)	30	1000	1	10	100	35	PK or RMS
Sweep 2 (subrange 2)	1000	2500	1	10	15	35	PK or RMS
Sweep 2 (subrange 3)	2500	19500	1	10	150	35	PK or RMS
Sweep 3a (Band-Edge)	1849	1850	0.003	0.01	70	35	PK
Sweep 3b (Band-Edge)	1849	1850	0.003	0.01	70	35	RMS
Sweep 4a (Band-Edge)	1910	1911	0.003	0.01	70	35	PK
Sweep 4b (Band-Edge)	1910	1911	0.003	0.01	70	35	RMS

5.3.6. Results

The results are presented below in summary form only. For more information please see each diagram enclosed in annex 4 diagrams.

5.3.7. GPRS850: Set-up 1

Diagram no.	Carrier Channel		Frequency range	OP-mode no.	Remark	Used detector			Result
	Range	No.				PK	AV	QP	
36.01_CSE_Ch128_GSM_Sweep1	Low	128	9 kHz – 30 MHz	2	--	<input checked="" type="checkbox"/>	<input type="checkbox"/>	<input type="checkbox"/>	passed
36.02_CSE_Ch128_GSM_Sweep2	Low		30MHz – 9 GHz		Carrier visible on diagram, not relevant for result	<input checked="" type="checkbox"/>	<input type="checkbox"/>	<input type="checkbox"/>	passed
37.01_BE_Ch128_GSM	Low		823-824 MHz		Band Edge Compliance	<input type="checkbox"/>	<input checked="" type="checkbox"/>	<input type="checkbox"/>	passed
36.03_CSE_Ch192_GSM_Sweep1	Middle	192	9 kHz – 30 MHz		--	<input checked="" type="checkbox"/>	<input type="checkbox"/>	<input type="checkbox"/>	passed
36.04_CSE_Ch192_GSM_Sweep2	Middle		30MHz – 9 GHz		Carrier visible on diagram, not relevant for result	<input checked="" type="checkbox"/>	<input type="checkbox"/>	<input type="checkbox"/>	passed
36.05_CSE_Ch251_GSM_Sweep1	High	251	9 kHz – 30 MHz		--	<input checked="" type="checkbox"/>	<input type="checkbox"/>	<input type="checkbox"/>	passed
36.06_CSE_Ch251_GSM_Sweep2	High		30MHz – 9 GHz		Carrier visible on diagram, not relevant for result	<input checked="" type="checkbox"/>	<input type="checkbox"/>	<input type="checkbox"/>	passed
37.02_BE_Ch251_GSM	High		849–850 MHz		Band-Edge compliance	<input type="checkbox"/>	<input checked="" type="checkbox"/>	<input type="checkbox"/>	passed

Remark:--

5.3.8. E-GPRS 850: Set-up 1

Diagram no.	Carrier Channel		Frequency range	OP-mode no.	Remark	Used detector			Result
	Range	No.				PK	AV	QP	
36.07_CSE_Ch128_EGPRS_Sweep1	Low	128	9 kHz – 30 MHz	3	--	<input checked="" type="checkbox"/>	<input type="checkbox"/>	<input type="checkbox"/>	passed
36.08_CSE_Ch128_EGPRS_Sweep2	Low		30MHz – 9 GHz		Carrier visible on diagram, not relevant for result	<input checked="" type="checkbox"/>	<input type="checkbox"/>	<input type="checkbox"/>	passed
37.03_BE_Ch128_EGPRS	Low		823 - 824 MHz		Band Edge Compliance	<input type="checkbox"/>	<input checked="" type="checkbox"/>	<input type="checkbox"/>	passed
36.09_CSE_Ch192_EGPRS_Sweep1	Middle	192	9 kHz – 30 MHz		--	<input checked="" type="checkbox"/>	<input type="checkbox"/>	<input type="checkbox"/>	passed
36.10_CSE_Ch192_EGPRS_Sweep2	Middle		30MHz – 9 GHz		Carrier visible on diagram, not relevant for result	<input checked="" type="checkbox"/>	<input type="checkbox"/>	<input type="checkbox"/>	passed
36.11_CSE_Ch251_EGPRS_Sweep1	High	251	9 kHz – 30 MHz		--	<input checked="" type="checkbox"/>	<input type="checkbox"/>	<input type="checkbox"/>	passed
36.12_CSE_Ch251_EGPRS_Sweep2	High		30MHz – 9 GHz		Carrier visible on diagram, not relevant for result	<input checked="" type="checkbox"/>	<input type="checkbox"/>	<input type="checkbox"/>	passed
37.04_BE_Ch251_EGPRS	High		849 – 850 MHz		Band-Edge compliance	<input type="checkbox"/>	<input checked="" type="checkbox"/>	<input type="checkbox"/>	passed

Remark:

5.3.9. GPRS 1900: Set-up 1

Diagram no.	Carrier Channel		Frequency range	OP-mode no.	Remark	Used detector			Result
	Range	No.				PK	AV	QP	
36.20_CSE_Ch512_GSM_Sweep1	Low	512	9 kHz – 30 MHz	5	--	<input checked="" type="checkbox"/>	<input type="checkbox"/>	<input type="checkbox"/>	passed
36.21_CSE_Ch512_GSM_Sweep1	Low		30MHz – 19.5 GHz		Carrier visible on diagram, not relevant for result	<input checked="" type="checkbox"/>	<input type="checkbox"/>	<input type="checkbox"/>	passed
37.10_BE_Ch512_GSM	Low		1849 – 1850 MHz		Band Edge Compliance	<input checked="" type="checkbox"/>	<input type="checkbox"/>	<input type="checkbox"/>	passed
36.22_CSE_Ch661_GSM_Sweep1	Middle	661	9 kHz – 30 MHz		--	<input checked="" type="checkbox"/>	<input type="checkbox"/>	<input type="checkbox"/>	passed
36.23_CSE_Ch661_GSM_Sweep1	Middle		30MHz – 19.5 GHz		Carrier visible on diagram, not relevant for result	<input checked="" type="checkbox"/>	<input type="checkbox"/>	<input type="checkbox"/>	passed
36.24_CSE_Ch810_GSM_Sweep1	High	810	9 kHz – 30 MHz		--	<input checked="" type="checkbox"/>	<input type="checkbox"/>	<input type="checkbox"/>	passed
36.25_CSE_Ch810_GSM_Sweep1	High		30MHz – 19.5 GHz		Carrier visible on diagram, not relevant for result	<input checked="" type="checkbox"/>	<input type="checkbox"/>	<input type="checkbox"/>	passed
37.11_BE_Ch810_GSM	High		1910 – 1911 MHz		Band-Edge compliance	<input checked="" type="checkbox"/>	<input type="checkbox"/>	<input type="checkbox"/>	passed

Remark: --

5.3.10. E-GPRS 1900: Set-up 1

Diagram no.	Carrier Channel		Frequency range	OP-mode no.	Remark	Used detector			Result
	Range	No.				PK	AV	QP	
36.26_RSE_Ch512_EGPRS_Sweep 1	Low	512	9 kHz – 30 MHz	6	--	<input checked="" type="checkbox"/>	<input type="checkbox"/>	<input type="checkbox"/>	passed
36.27_RSE_Ch512_EGPRS_Sweep 2	Low		30MHz – 19.5GHz		Carrier visible on diagram, not relevant for result	<input checked="" type="checkbox"/>	<input type="checkbox"/>	<input type="checkbox"/>	passed
37.12_BE_Ch512_EGPRS_PK	Low		1849 – 1850 MHz		Band Edge Compliance	<input checked="" type="checkbox"/>	<input type="checkbox"/>	<input type="checkbox"/>	passed
36.28_CSE_Ch661_EGPRS_Sweep 1	Middle	661	9 kHz – 30 MHz		--	<input checked="" type="checkbox"/>	<input type="checkbox"/>	<input type="checkbox"/>	passed
36.29_CSE_Ch661_EGPRS_Sweep 2	Middle		30MHz – 19.5 GHz		Carrier visible on diagram, not relevant for result	<input checked="" type="checkbox"/>	<input type="checkbox"/>	<input type="checkbox"/>	passed
36.30_CSE_Ch810_EGPRS_Sweep 1	High	810	9 kHz – 30 MHz		--	<input checked="" type="checkbox"/>	<input type="checkbox"/>	<input type="checkbox"/>	passed
36.31_CSE_Ch810_EGPRS_Sweep 2	High		30MHz – 19.5 GHz		Carrier visible on diagram, not relevant for result	<input checked="" type="checkbox"/>	<input type="checkbox"/>	<input type="checkbox"/>	passed
37.13_BE_Ch810_EGPRS_PK	High		1910 – 1911 MHz		Band-Edge compliance	<input checked="" type="checkbox"/>	<input type="checkbox"/>	<input type="checkbox"/>	passed

Remark: --

5.4. RF-Parameter - Radiated out of Band RF emissions and Band Edge

5.4.1. Test location and equipments (for reference numbers please see chapter 'List of test equipment')

test location	<input checked="" type="checkbox"/> CETECOM Essen (Chapter. 2.2.1)	<input type="checkbox"/> Please see Chapter. 2.2.2	<input type="checkbox"/> Please see Chapter. 2.2.3
test site	<input type="checkbox"/> 441 EMI SAR	<input type="checkbox"/> 487 SAR NSA	<input checked="" type="checkbox"/> 443 FAR
receiver	<input type="checkbox"/> 377 ESCS30	<input type="checkbox"/> 001 ESS	<input type="checkbox"/> 489 ESU 40
spectr. analys.	<input type="checkbox"/> 584 FSU	<input type="checkbox"/> 120 FSEM	<input checked="" type="checkbox"/> 264 FSEK
antenna	<input checked="" type="checkbox"/> 439 HL 562	<input checked="" type="checkbox"/> 549 HL 025	<input type="checkbox"/> 302 BBHA9170
signaling	<input type="checkbox"/> 017 CMD 65	<input type="checkbox"/> 323 CMD 55	<input type="checkbox"/> 340 CMD 55
signaling	<input type="checkbox"/> 392 MT8820A	<input checked="" type="checkbox"/> 546 CMU	<input type="checkbox"/> 547 CMU
power supply	<input checked="" type="checkbox"/> 463 HP3245A	<input type="checkbox"/> 457 EA 3013A	<input type="checkbox"/> 459 EA 2032-50
otherwise	<input type="checkbox"/> 529 6dB divider	<input type="checkbox"/> 530 6dB Att.	<input type="checkbox"/> 110 USB LWL
line voltage	<input type="checkbox"/> 230 V 50 Hz via public mains	<input type="checkbox"/> 060 120 V/ 60 Hz via PAS 5000	<input type="checkbox"/> 268 EA- 3050
			<input type="checkbox"/> 494 AG6632A
			<input type="checkbox"/> 498 NGPE 40
			<input type="checkbox"/> 030 HFH-Z2
			<input type="checkbox"/> 477 GPS

5.4.2. Requirements and limits (Variante RF-Parameter)

FCC	<input checked="" type="checkbox"/> Part 2.1053(a), Part2.1057(a)(1) <input checked="" type="checkbox"/> Part 22 Subpart H, §22.917(a)(b) <input checked="" type="checkbox"/> Part 24 Subpart E, §24.238(a)(b)
IC	<input checked="" type="checkbox"/> RSS-132, Issue 3: 5.5(i)(ii) <input checked="" type="checkbox"/> RSS-133, Issue 6: 6.5.1(i)(ii)
Limit	§22.917(a) & §24.238(a): “The power of any emission outside of the authorized operating frequency ranges must be attenuated below the transmitting power (P) by a factor of at least 43 + 10 log(P) dB” Limit: -13dBm for all Power Control Levels of the cellular equipment

5.4.3. Test condition and test set-up

link to test system (if used):	<input checked="" type="checkbox"/> air link	<input type="checkbox"/> cable connection
EUT-grounding	<input checked="" type="checkbox"/> none	<input type="checkbox"/> with power supply
Equipment set up	<input checked="" type="checkbox"/> table top	<input type="checkbox"/> floor standing
Climatic conditions	Temperature: (22±3°C)	Rel. humidity: (40±20)%
Test system set-up	Please see chapter “Test system set-up for radiated spurious emission measurements up to 20 GHz”	
Measurement method	<p>“§ 2.1057 Frequency spectrum to be investigated. (a) In all of the measurements set forth in § 2.1051 and 2.1053, the spectrum shall be investigated from the lowest radio frequency signal generated in the equipment, without going below 9 kHz”</p> <p>The spectrum was scanned from 9 kHz (depend on the equipment, s. §2.1057) to the 10th harmonic of the highest frequency generated within the equipment. A PEAK detector was used except measurements near the block-edge where a AVERAGE detector applied.</p> <p>According chapter “Test system set-up for electric field measurement in the range 30-1000MHz and 1 to 40GHz” and additionally: the readings on the spectrum analyzer are corrected with annually performed chamber path calibration values so the readings shown are equivalent to ERP/EIRP values. Critical measurements near the limit are re-measured with a substitution method accord. ANSI/TIA/EIA 603.</p>	
EUT settings	<p>A call was established with settings according chapter “Parameter settings on mobile phone and base station CMU200”</p> <p>The UE and used accessories (if any used) were set to work according their intended use/specification stated as by the applicant</p> <p>The measurements were made at the low, middle and high carrier frequencies of each of the supported operating band. Choosing three TX-carrier frequencies of the wireless device, should be sufficient to demonstrate compliance.</p>	

Spectrum-Analyzer settings for GSM/GPRS/E-GPRS 850 Mode

Sweep no.	Start freq. MHz	Stop freq. MHz	R-BW MHz	V-BW MHz	Sweep time sec.	Att. [dB]	Detector
Sweep 1 (subrange 1)	30	1000	0.1	0.3	10	10	MaxH-PK
Sweep 2 (subrange 2)	1000	2800	0.1	0.3	15	10	MaxH-PK
Sweep 3 (subrange 3)	2800	9000	0.1	0.3	60	10	MaxH-PK
Sweep 4a (Band-Edge)	823	824	0.003	0.01	30	10	MaxH-PK
Sweep 4b (Band-Edge)	849	850	0.003	0.01	30	10	MaxH-PK

Spectrum-analyzer settings for GSM/GPRS/E-GPRS 1900 Mode

Sweep no.	Start freq. MHz	Stop freq. MHz	R-BW MHz	V-BW MHz	Sweep time sec.	Att.	Detector
Sweep 1 (subrange 1)	30	1000	1	3	10	10	MaxH-PK
Sweep 2 (subrange 2)	1000	2800	1	3	15	10	MaxH-PK
Sweep 3 (subrange 3)	2800	20000	1	3	160	10	MaxH-PK
Sweep 4a (Band-Edge)	1849	1850	0.003	0.01	30	10	MaxH-PK
Sweep 4b (Band-Edge)	1910	1911	0.003	0.01	30	10	MaxH-AV

5.4.4. Measurement results

The results are presented below in summary form only. For more information please see each diagram enclosed in annex 4.

5.4.4.1. GPRS 850: Set-up 2

Diagram no.	Carrier Channel		Frequency range	OP-mode no.	Remark	Used detector			Result
	Range	No.				PK	AV	QP	
8.01a_RSE_R_Ch128_GPRS 8.01b_RSE_R_Ch128_GPRS	Low	128	30 MHz – 9 GHz	2	Carrier on diagram, not relevant for results	<input checked="" type="checkbox"/>	<input type="checkbox"/>	<input type="checkbox"/>	passed
9.01a_RSE_R_Ch128_GPRS 9.01b_RSE_R_Ch128_GPRS	Low		823 – 824 MHz		Band Edge Compliance	<input checked="" type="checkbox"/>	<input checked="" type="checkbox"/>	<input type="checkbox"/>	passed
8.02a_RSE_R_Ch192_GPRS 8.02b_RSE_R_Ch192_GPRS	Middle	192	30 MHz – 9 GHz		Carrier on diagram, not relevant for results	<input checked="" type="checkbox"/>	<input type="checkbox"/>	<input type="checkbox"/>	passed
8.03a_RSE_R_Ch251_GPRS 8.03b_RSE_R_Ch251_GPRS	High	251	30 MHz – 9 GHz		Carrier on diagram, not relevant for results	<input checked="" type="checkbox"/>	<input type="checkbox"/>	<input type="checkbox"/>	passed
9.02a_RSE_R_Ch251_GPRS 9.02b_RSE_R_Ch251_GPRS	High		849 – 850 MHz		Band-Edge compliance	<input checked="" type="checkbox"/>	<input checked="" type="checkbox"/>	<input type="checkbox"/>	passed

Remark: separate sweeps for positioned set-up: laying and standing

5.4.4.2. GPRS 1900: Set-up 2

Diagram no.	Carrier Channel		Frequency range	OP-mode no.	Remark	Used detector			Result
	Range	No.				PK	AV	QP	
8.10_RSE_R_Ch512_GPRS 8.13_RSE_R_Ch512_GPRS	Low	512	30 MHz – 18 GHz	5	Carrier on diagram, not relevant for results	<input checked="" type="checkbox"/>	<input type="checkbox"/>	<input type="checkbox"/>	passed
9.09a_BE_R_Ch512_GPRS 9.09b_BE_R_Ch512_GPRS	Low		1849 – 1850 MHz		Band Edge Compliance	<input checked="" type="checkbox"/>	<input checked="" type="checkbox"/>	<input type="checkbox"/>	passed
8.11_RSE_R_Ch661_GPRS 8.14_RSE_R_Ch661_GPRS	Middle	661	30 MHz – 18 GHz		Carrier on diagram, not relevant for results	<input checked="" type="checkbox"/>	<input type="checkbox"/>	<input type="checkbox"/>	passed
8.12_RSE_R_Ch810_GPRS 8.15_RSE_R_Ch810_GPRS	High	810	30 MHz – 18 GHz		Carrier on diagram, not relevant for results	<input checked="" type="checkbox"/>	<input type="checkbox"/>	<input type="checkbox"/>	passed
9.10a_BE_R_Ch810_GPRS 9.10b_BE_R_Ch810_GPRS	High		1910 – 1911 MHz		Band-Edge compliance	<input checked="" type="checkbox"/>	<input checked="" type="checkbox"/>	<input type="checkbox"/>	passed

Remark: separate sweeps for positioned set-up: laying and standing

5.5. RF-Parameter - Frequency stability on temperature and voltage variations

5.5.1. Test location and equipments (for reference numbers please see chapter 'List of test equipment')

test location	<input checked="" type="checkbox"/> CETECOM Essen (Chapter. 2.2.1)	<input type="checkbox"/> Please see Chapter. 2.2.2	<input type="checkbox"/> Please see Chapter. 2.2.3
test site	<input checked="" type="checkbox"/> 347 Radio.lab.1	<input checked="" type="checkbox"/> Radio.lab.2	<input type="checkbox"/>
spectr. analys.	<input type="checkbox"/> 584 FSU	<input type="checkbox"/> 489 ESU 40	<input type="checkbox"/> 264 FSEK <input type="checkbox"/> 620 ESU 26
signaling	<input type="checkbox"/> 392 MT8820A	<input type="checkbox"/> 436 CMU	<input checked="" type="checkbox"/> 547 CMU
DC power	<input type="checkbox"/> 456 EA 3013A	<input type="checkbox"/> 457 EA 3013A	<input type="checkbox"/> 459 EA 2032-50 <input type="checkbox"/> 268 EA- 3050 <input type="checkbox"/> 494 AG6632A <input type="checkbox"/> 498 NGPE 40
otherwise	<input checked="" type="checkbox"/> 529 6dB divider	<input checked="" type="checkbox"/> 530 10dB Att.	<input type="checkbox"/> 431 Near field
Climatic test chamber	<input checked="" type="checkbox"/> 331 HC 4055	<input checked="" type="checkbox"/> 627 OPUS 1	
line voltage	<input type="checkbox"/> 230 V 50 Hz via public mains		<input type="checkbox"/> 060 120 V/ 60 Hz via PAS 5000

5.5.2. Requirements and limits

FCC	<input checked="" type="checkbox"/> §2.1055(a)(1) (d) <input checked="" type="checkbox"/> §22.355 <input checked="" type="checkbox"/> §24.235
ISED	<input checked="" type="checkbox"/> RSS-Gen, Issue 3 <input checked="" type="checkbox"/> RSS-132: 5.3 <input checked="" type="checkbox"/> RSS-133: 6.3
Limit	<i>"The frequency stability shall be sufficient to ensure that the fundamental emission stays within the authorized frequency block"</i>

5.5.3. Test condition and test set-up

Test system set-up	Please see chapter "Test system set-up for conducted measurements on antenna port" In order to maintain the voltage constant over the time period of the tests, a dummy battery was connected to a laboratory power supply. The power supply voltage was controlled on the input of the power supply terminals of the EUT under operating conditions.
Measurement method	The GSM RF Channel spacing is 200 kHz according GSM-Spec, with a guard band of 200 kHz of each band of the sub-bands. The purpose of the EUT is to function under all extreme conditions within authorized sub-bands in regard to temperature and voltage variations. The frequency deviation was recorded with base station's build in capability. (CMU) As the standard requires that the fundamental emissions stays within the authorized band, a limit of 0.1ppm is considered low enough to ensure this.
EUT settings	A call was established with settings according chapter "Parameter settings on mobile phone and base station CMU200" The measurements were made at the low, middle and high carrier frequencies of each of the supported operating band. Choosing three TX-carrier frequencies of the wireless device , should be sufficient to demonstrate compliance.

5.5.4. Measurement results

5.5.4.1. Frequency shift of carrier against a voltage range at constant nominal temperature of 20° Celsius

Tests only performed across extreme voltage range for information: limited approval

OEM integrators should consult grant and applicants recommendations on power supply design rules.

- 1.) determine the carrier frequency for the lowest and highest channel at room temperature and nominal voltage [20°C]
- 2.) The voltage was reduced in 0.1 Volt steps to the lower end point, where the mobile phone stops working. (this shall be specified by the manufacturer) Record the carrier frequency shift within 2 minutes after powering on the mobile phone, to prevent for self-heating effects.
- 3.) The voltage was increased in 0.1 Volt steps to the upper declared voltage of the battery. Record the carrier frequency shift within 2 minutes after powering on the mobile phone, to prevent for self-heating effects.

5.5.4.1.1. GSM 850 Mode: set-up 1

Channel 128: GMSK				
Voltage [V]	Nominal Frequency [MHz]	Maximum frequency error		Verdict Limit= +/-0.1ppm
		[Hz]	[ppm]	
3,9	8,24E+08	21,05	0,026	passed
4,0		19,86	0,024	
4,1		25,44	0,031	

Channel 128: 8-PSK				
Voltage [V]	Nominal Frequency [MHz]	Maximum frequency error		Verdict Limit= +/-0.1ppm
		[Hz]	[ppm]	
3,9	8,24E+08	26,86	0,033	passed
4,0		33,32	0,040	
4,1		33,19	0,040	

Channel 192: GMSK				
Voltage [V]	Nominal Frequency [MHz]	Maximum frequency error		Verdict Limit= +/-0.1ppm
		[Hz]	[ppm]	
3,9	8,37E+08	21,57	0,026	passed
4,0		23,37	0,028	
4,1		22,89	0,027	

Channel 192: 8-PSK				
Voltage [V]	Nominal Frequency [MHz]	Maximum frequency error		Verdict Limit= +/-0.1ppm
		[Hz]	[ppm]	
3,9	8,37E+08	28,54	0,034	passed
4,0		26,99	0,032	
4,1		31,9	0,038	

Channel 251: GMSK				
Voltage [V]	Nominal Frequency [MHz]	Maximum frequency error		Verdict Limit= +/-0.1ppm
		[Hz]	[ppm]	
3,9	8,49E+08	25,57	0,030	passed
4,0		22,63	0,027	
4,1		20,66	0,024	

Channel 251: 8-PSK				
Voltage [V]	Nominal Frequency [MHz]	Maximum frequency error		Verdict Limit= +/-0.1ppm
		[Hz]	[ppm]	
3,9	8,49E+08	29,25	0,034	passed
4,0		26,28	0,031	
4,1		30,15	0,036	

5.5.4.1.2. GSM 1900 Mode: set-up 1

Channel 512: GMSK				
Voltage [V]	Nominal Frequency [MHz]	Maximum frequency error		Verdict Limit= +/-0.1ppm
		[Hz]	[ppm]	
3,9	1,85E+09	39,91	0,022	passed
4,0		37,03	0,020	
4,1		36,35	0,020	

Channel 512: 8-PSK				
Voltage [V]	Nominal Frequency [MHz]	Maximum frequency error		Verdict Limit= +/-0.1ppm
		[Hz]	[ppm]	
3,9	1,85E+09	36,1	0,020	passed
4,0		35,71	0,019	
4,1		35,13	0,019	

Channel 661: GMSK				
Voltage [V]	Nominal Frequency [MHz]	Maximum frequency error		Verdict Limit= +/-0.1ppm
		[Hz]	[ppm]	
3,9	1,88E+09	41,26	0,022	passed
4,0		38	0,020	
4,1		37,26	0,020	

Channel 661: 8-PSK				
Voltage [V]	Nominal Frequency [MHz]	Maximum frequency error		Verdict Limit= +/-0.1ppm
		[Hz]	[ppm]	
3,9	1,88E+09	41,39	0,022	passed
4,0		42,94	0,023	
4,1		39,07	0,021	

Channel 810: GMSK				
Voltage [V]	Nominal Frequency [MHz]	Maximum frequency error		Verdict Limit= +/-0.1ppm
		[Hz]	[ppm]	
3,9	1,91E+09	29,25	0,015	passed
4,0		27,25	0,014	
4,1		29,8	0,016	

Channel 810: 8-PSK				
Voltage [V]	Nominal Frequency [MHz]	Maximum frequency error		Verdict Limit= +/-0.1ppm
		[Hz]	[ppm]	
3,9	1,91E+09	34,87	0,018	passed
4,0		37,9	0,020	
4,1		34,74	0,018	

5.5.4.2. Frequency shift of carrier against temperature at constant power supply voltage

- 1.) determine the carrier frequency for the lowest, middle and highest channel at room temperature and nominal voltage [20°C]
- 2.) expose the mobile station to -30°C, wait sufficient time to have constant temperature.
- 3.) Perform the carrier frequencies measurements in 10°C increments from -30°C to +60°C. For about half hour at the specified temperature the mobile was powered-off. After powering-on, the measurements were made within 2 minute for the channel lower channel, in order to prevent self-warming of the mobile.

5.5.4.2.1. GSM 850 Mode: Op. Mode 2, set-up 1

Temperature	Maximum frequency error						Verdict Limit=±0.1ppm
	Channel 128	Channel 192	Channel 251	Channel 128	Channel 192	Channel 251	
	[Hz]			[ppm]			
-40	31,58	32,54	30,99	0,038	0,039	0,037	PASS
-30	30,74	30,03	33,13	0,037	0,036	0,039	
-20	31,12	28,09	34,74	0,038	0,034	0,041	
-10	32,22	24,92	30,67	0,039	0,030	0,036	
0	30,09	33,32	28,09	0,037	0,040	0,033	
10	25,51	30,03	25,31	0,031	0,036	0,030	
20	30,67	30,93	31,32	0,037	0,037	0,037	
30	27,70	21,76	22,99	0,034	0,026	0,027	
40	21,70	31,64	28,80	0,026	0,038	0,034	
50	29,19	25,83	35,58	0,035	0,031	0,042	
60	29,70	33,25	30,22	0,036	0,040	0,036	
70	38,23	22,47	34,03	0,046	0,027	0,040	
80	37,13	28,02	42,94	0,045	0,033	0,051	

MAX	38,23	33,32	42,94
MIN	21,7	21,76	22,99

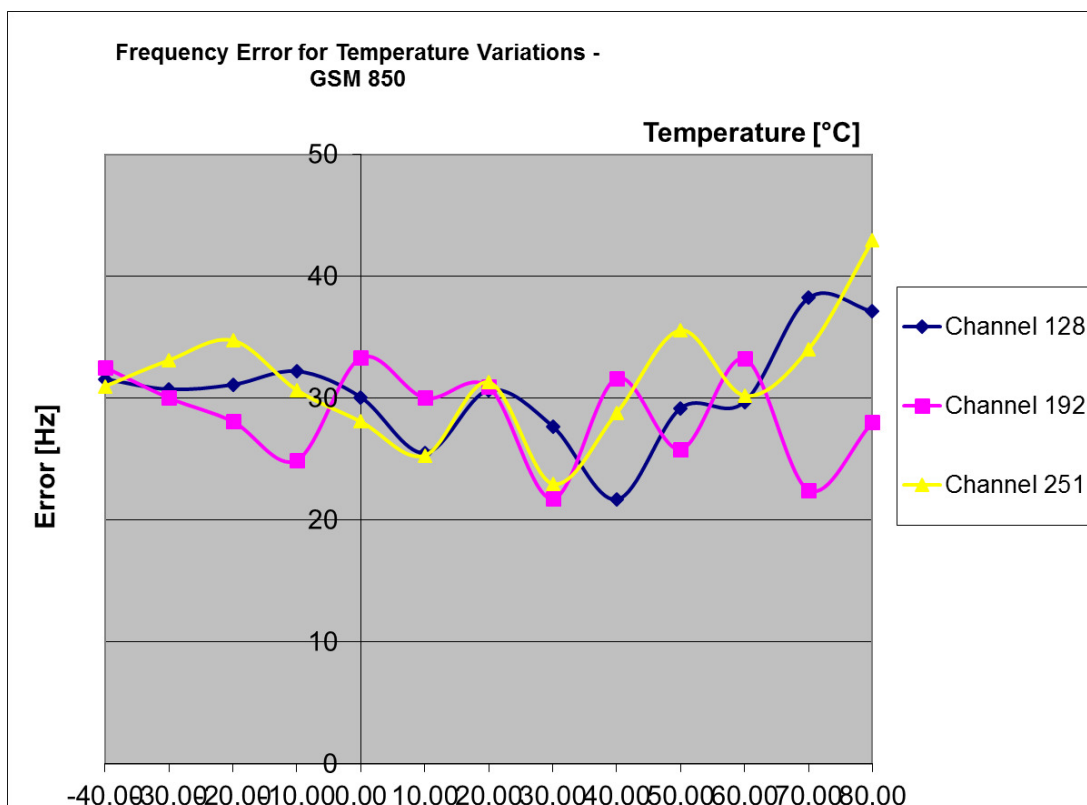

5.5.4.2.2. E-GPRS 850 Mode: Op. Mode 3, set-up 1

Temperature	Maximum frequency error						Verdict Limit=±0.1ppm
	Channel 128	Channel 192	Channel 251	Channel 128	Channel 192	Channel 251	
	[Hz]			[ppm]			
-40	25,63	25,86	23,67	0,031	0,031	0,028	PASS
-30	22,7	30,45	29,25	0,028	0,036	0,034	
-20	30,54	25,09	31,12	0,037	0,030	0,037	
-10	25,76	21,08	28,28	0,031	0,025	0,033	
0	30,48	21,92	23,92	0,037	0,026	0,028	
10	22,41	23,6	20,89	0,027	0,028	0,025	
20	27,41	24,63	19,47	0,033	0,029	0,023	
30	23,44	28,57	17,37	0,028	0,034	0,020	
40	19,92	24,12	27,18	0,024	0,029	0,032	
50	27,67	24,15	27,77	0,034	0,029	0,033	
60	22,99	27,28	28,25	0,028	0,033	0,033	
70	31,19	27,73	28,41	0,038	0,033	0,033	
80	28,7	22,47	34,22	0,035	0,027	0,040	

MAX	31,19	30,45	34,22
MIN	19,92	21,08	17,37

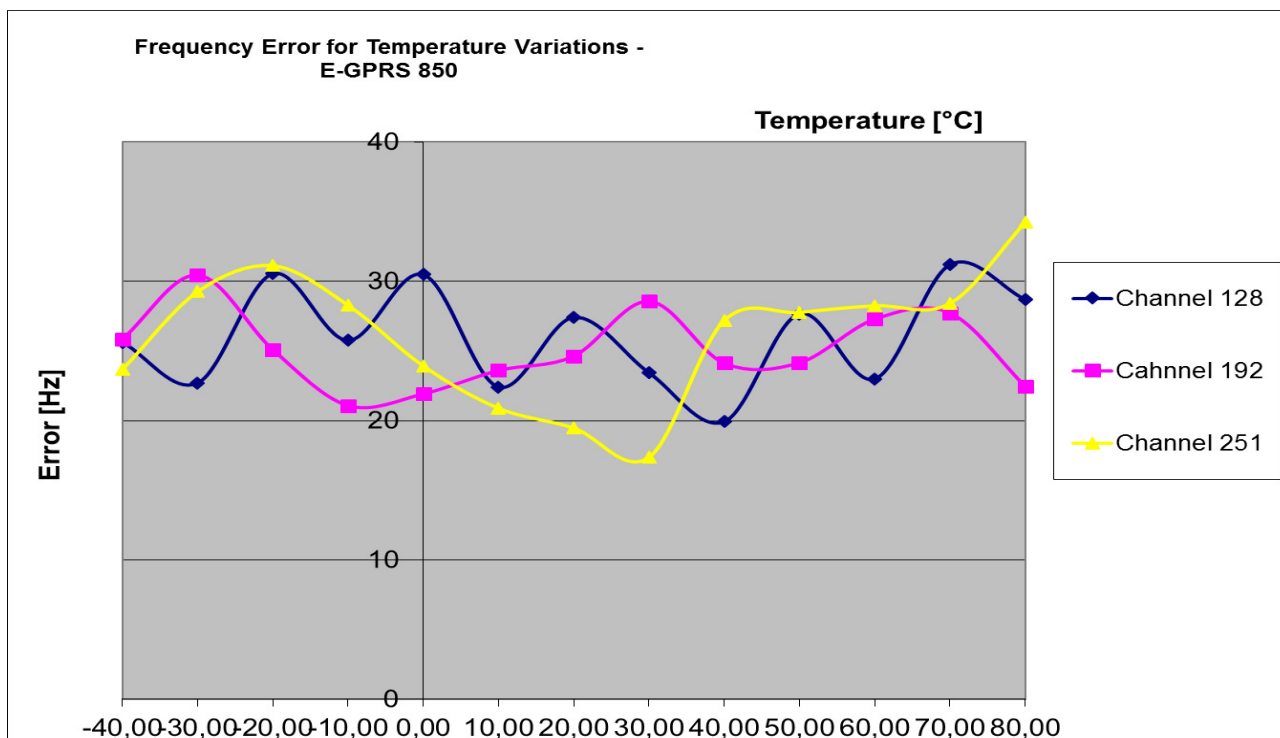

5.5.4.2.3. Band 850: Canada requirement regarding emission/occupied bandwidth

Measurement Method:

With results of chapter 5.5.4.4.1/5.4.4.4.2 (frequency error) and of chapter 5.2. (occupied bandwidth) a calculation should show that the occupied/emissions bandwidth remains within the authorized band. Negative frequency error shifts the carrier (T1) more closer to the left band-edge (824MHz), positive frequency error shifts the carrier (T2 points) more closer to the right band-edge (849MHz). Following table shows the results calculated with above presumptions:

LOW-Band EDGE:

from occupied bandwidth diagrams point (T1)

Modulation -Scheme	FL [MHz]	Low Band-Edge [MHz]	Margin to band-Edge except Frequency Error [MHz]	Frequency Deviation during climatic tests [MHz]	Margin to Low-Band-Edge including climatic conditions [MHz]	Verdict
GMSK	824,0766026	824	0,076602564	0,00002170	0,07662426	pass
8-PSK	824,325	824	0,325	0,00001992	0,32501992	pass

High-Band EDGE:

from occupied bandwidth diagrams point (T2)

Modulation -Scheme	FH [MHz]	High Band-Edge [MHz]	Margin to band-Edge except Frequency Error [MHz]	Frequency of Deviation during climatic tests [MHz]	Margin to Low-Band-Edge including climatic conditions [MHz]	Verdict
GMSK	848,921794872	849	0,078205128	0,00004294	0,07816219	pass
8-PSK	848,923397436	849	0,076602564	0,00003422	0,07656834	pass

5.5.4.2.4. GSM 1900 Mode: Op. Mode 5, set-up 1

Temperature	Maximum frequency error						Verdict Limit=±0.1ppm
	Channel 512	Channel 661	Channel 810	Channel 512	Channel 661	Channel 810	
	[Hz]			[ppm]			
-40	30,41	42,75	33,06	0,016	0,023	0,017	PASS
-30	33,45	54,89	36,22	0,018	0,029	0,019	
-20	38,10	41,07	36,55	0,021	0,022	0,019	
-10	41,26	46,04	32,03	0,022	0,024	0,017	
0	47,2	50,37	39,97	0,026	0,027	0,021	
10	49,46	33,84	37,58	0,027	0,018	0,020	
20	34,74	33,64	44,81	0,019	0,018	0,023	
30	20,28	24,09	26,67	0,011	0,013	0,014	
40	34,42	56,24	33,58	0,019	0,030	0,018	
50	36,22	40,16	32,41	0,020	0,021	0,017	
60	29,70	31,77	43,33	0,016	0,017	0,023	
70	41,58	47,59	55,21	0,022	0,025	0,029	
80	71,22	48,49	55,79	0,038	0,026	0,029	

MAX	71,22	56,24	55,79
MIN	20,28	24,09	26,67

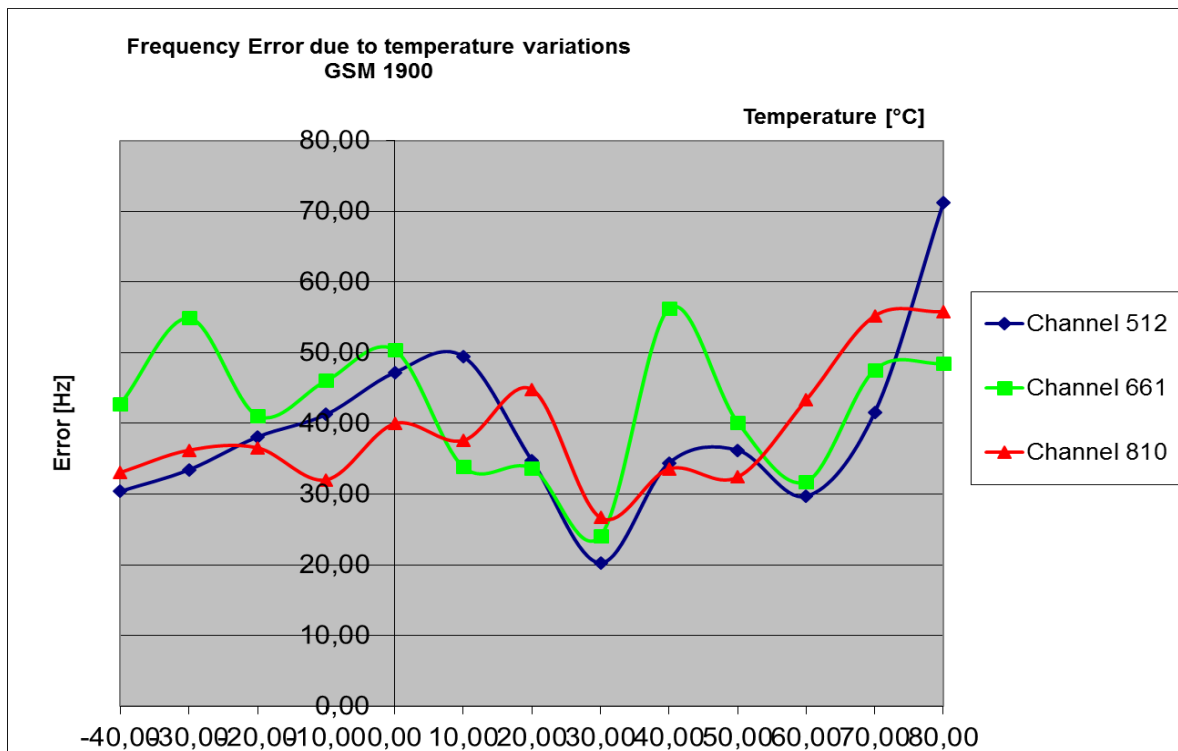

5.5.4.2.5. E-GPRS 1900 Mode: Op. Mode 6, set-up 1

Temperature	Maximum frequency error						Verdict Limit=±0.1ppm
	Channel 512	Channel 661	Channel 810	Channel 512	Channel 661	Channel 810	
	[Hz]			[ppm]			
-40	20,66	38,94	38,94	0,011	0,021	0,020	PASS
-30	33,8	51,69	24,89	0,018	0,027	0,013	
-20	37,03	34,77	32,93	0,020	0,018	0,017	
-10	36,68	40,29	30,48	0,020	0,021	0,016	
0	41,81	45,56	31,80	0,023	0,024	0,017	
10	46,59	24,02	31,48	0,025	0,013	0,016	
20	33,61	31,48	35,9	0,018	0,017	0,019	
30	19,73	23,99	20,76	0,011	0,013	0,011	
40	36,55	48,14	28,28	0,020	0,026	0,015	
50	33,71	34,35	16,24	0,018	0,018	0,009	
60	27,48	42,65	35,00	0,015	0,023	0,018	
70	37,84	42,13	43,04	0,020	0,022	0,023	
80	56,24	32,74	43,88	0,030	0,017	0,023	

MAX	56,24	51,69	43,88
MIN	19,73	23,99	16,24

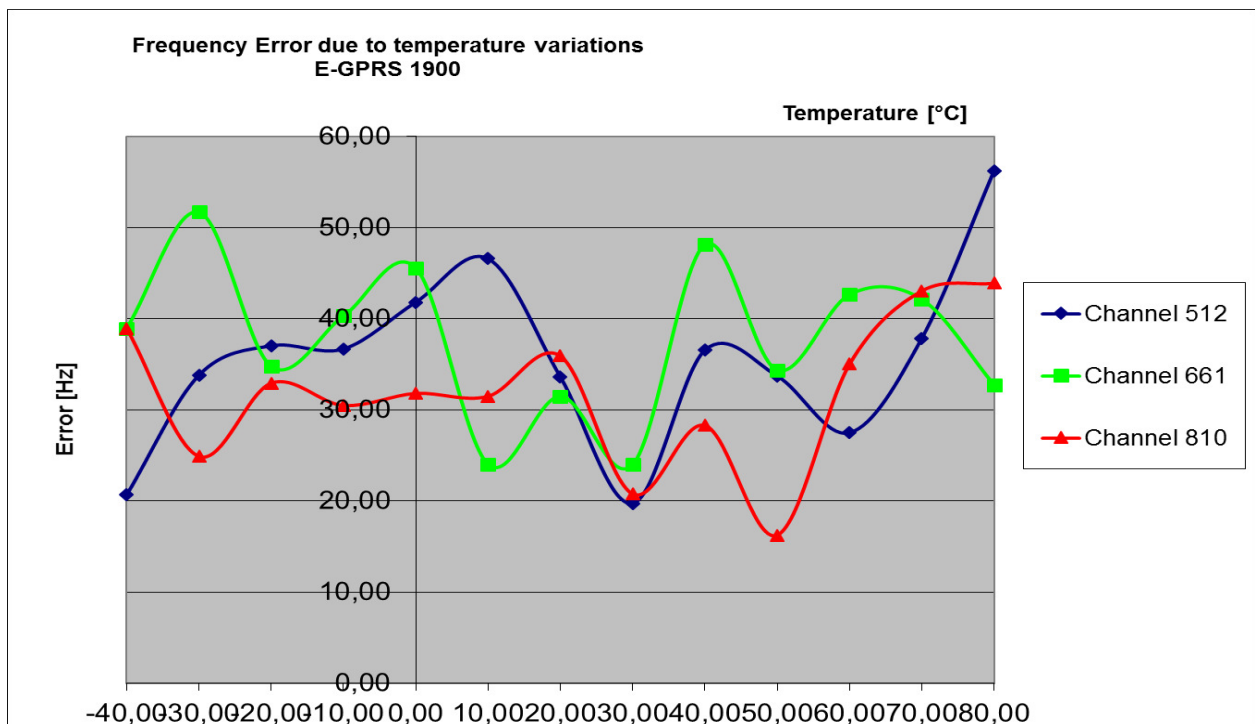

5.5.4.2.6. Band 1900: Canada requirement regarding emission/occupied bandwidth

Measurement Method:

With results of chapter 5.5.4.4.4/5.4.4.4.5 (frequency error) and of chapter 5.2. (occupied bandwidth) a calculation should show that the occupied/emissions bandwidth remains within the authorized band. Negative frequency error shifts the carrier (T1) more closer to the left band-edge (1850MHz), positive frequency error shifts the carrier (T2 points) more closer to the right band-edge (1910MHz). Following table shows the results calculated with above presumptions:

LOW-Band EDGE:

from occupied bandwidth diagrams point (T1)

Modulation -Scheme	FL [MHz]	Low Band-Edge [MHz]	Margin to band-Edge except Frequency Error [MHz]	Frequency of Deviation during climatic tests [MHz]	Margin to Low-Band-Edge including climatic conditions [MHz]	Verdict
GMSK	1850,076603	1850	0,076603	0,00002028	0,076623280	pass
8-PSK	1850,078205	1850	0,078205	0,00001973	0,078224730	pass

High-Band EDGE:

from occupied bandwidth diagrams point (T2)

Modulation -Scheme	FH [MHz]	High Band-Edge [MHz]	Margin to band-Edge except Frequency Error [MHz]	Frequency of Deviation during climatic tests [MHz]	Margin to Low-Band-Edge including climatic conditions [MHz]	Verdict
GMSK	1909,921796000	1910	0,078204000	0,00005579	0,07814821	pass
8-PSK	1909,921795000	1910	0,078205000	0,00004388	0,07816112	pass

5.6. Measurement uncertainties

The reported uncertainties are calculated based on the standard uncertainty multiplied with the appropriate coverage factor **k**, such that a confidence level of approximately 95% is achieved.

For uncertainty determination, each component used in the concrete measurement set-up was taken in account and its contribution to the overall uncertainty according to its statistical distribution calculated.

Following table shows expectable uncertainties for each measurement type performed.

RF-Measurement	Reference	Frequency range	Calculated uncertainty based on a confidence level of 95%						Remarks
Conducted emissions (U _{CISPR})	CISPR 16-2-1	9 kHz - 150 kHz 150 kHz - 30 MHz	4.0 dB 3.6 dB						-
Radiated emissions Enclosure	CISPR 16-2-3	30 MHz - 1 GHz 1 GHz - 18 GHz	4.2 dB 5.1 dB						E-Field
Disturbance power	CISPR 16-2-2	30 MHz - 300 MHz	-						-
Power Output radiated	-	30 MHz - 4 GHz	3.17 dB						Substitution method
Power Output conducted	-	Set-up No.	Cel-C1	Cel-C2	BT1	W1	W2	--	-
		9 kHz - 12.75 GHz	N/A	0.60	0.7	0.25	N/A	--	
		12.75 - 26.5GHz	N/A	0.82	--	N/A	N/A	--	
Conducted emissions on RF-port	-	9 kHz - 2.8 GHz	0.70	N/A	0.70	N/A	0.69	--	N/A - not applicable
		2.8 GHz - 12.75GHz	1.48	N/A	1.51	N/A	1.43	--	
		12.75 GHz - 18GHz	1.81	N/A	1.83	N/A	1.77	--	
		18 GHz - 26.5GHz	1.83	N/A	1.85	N/A	1.79	--	
Power density	-	1 - 2.8GHz	1.40 dB						--
Occupied bandwidth	-	9 kHz - 4 GHz	0.1272 ppm (Delta Marker)						Frequency error
			1.0 dB						Power
Emission bandwidth	-	9 kHz - 4 GHz	0.1272 ppm (Delta Marker)						Frequency error
			See above: 0.70 dB						Power
Frequency stability	-	9 kHz - 20 GHz	0.0636 ppm						-
Radiated emissions Enclosure	-	150 kHz - 30 MHz	5.0 dB						Magnetic field E-field Substitution
		30 MHz - 1 GHz	4.2 dB						
		1 GHz - 20 GHz	3.17 dB						

Table: measurement uncertainties, valid for conducted/radiated measurements

6. Abbreviations used in this report

The abbreviations	
ANSI	American National Standards Institute
AV , AVG, CAV	Average detector
EIRP	Equivalent isotropically radiated power, determined within a separate measurement
EGPRS	Enhanced General Packet Radio Service
EUT	Equipment Under Test
FCC	Federal Communications Commission, USA
IC	Industry Canada
n.a.	not applicable
Op-Mode	Operating mode of the equipment
PK	Peak
RBW	resolution bandwidth
RF	Radio frequency
RSS	Radio Standards Specification, Dokuments from Industry Canada
Rx	Receiver
TCH	Traffic channel
Tx	Transmitter
QP	Quasi peak detector
VBW	Video bandwidth
ERP	Effective radiated power

7. Accreditation details of CETECOM's laboratories and test sites

Ref.-No.	Accreditation Certificate	Valid for laboratory area or test site	Accreditation Body
-	D-PL-12047-01-01	All laboratories and test sites of CETECOM GmbH, Essen	DAkKS, Deutsche Akkreditierungsstelle GmbH
337 487 558 348 348	(MRA US-EU 0003)	Radiated Measurements 30 MHz to 1 GHz, 3 m / 10 m (OATS) Radiated Measurements 30 MHz to 1 GHz, 3 m (SAR) Radiated Measurements above 1 GHz, 3 m (FAR) Mains Ports Conducted Interference Measurements Telecommunication Ports Conducted Interference Measurment.	FCC, Federal Communications Commission Laboratory Division, USA
337 487 550 558	-- 3462D-2 3462D-2 3462D-3	Radiated Measurements 30 MHz to 1 GHz, 3 m / 10 m (OATS) Radiated Measurements 30 MHz to 1 GHz, 3 m (SAR) Radiated Measurements 1 GHz to 6 GHz, 3 m (SAR) Radiated Measurements above 1 GHz, 3 m (FAR)	IC, Industry Canada Certification and Engineering Bureau
487 550 348 348	R-2666 G-301 C-2914 T-1967	Radiated Measurements 30 MHz to 1 GHz, 3 m (SAR) Radiated Measurements 1 GHz to 6 GHz, 3 m (SAR) Mains Ports Conducted Interference Measurements Telecommunication Ports Conducted Interference Measurment.	VCCI, Voluntary Control Council for Interference by Information Technology Equipment, Japan

OATS = Open Area Test Site, SAR = Semi Anechoic Room, FAR = Fully Anechoic Room

8. Instruments and Ancillary

The “Ref.-No” in the left column of the following tables allows the clear identification of the laboratory equipment.

8.1. Used equipment “CTC”

The “Ref.-No” in the left column of the following tables allows the clear identification of the laboratory equipment.

8.1.1. Test software and firmware of equipment

Ref.-No.	Equipment	Type	Serial-No.	Version of Firmware or Software during the test
001	EMI Test Receiver	ESS	825132/017	Firm.= 1.21 , OTP=2.0, GRA=2.0
012	Signal Generator (EMS-cond.)	SMY 01	839069/027	Firm.= V 2.02
013	Power Meter (EMS cond.)	NRVD	839111/003	Firm.= V 1.51
017	Digital Radiocommunication Tester	CMD 60 M	844365/014	Firmware = V 3.52 .22.01.99, DECT = D2.87 13.01.99
053	Audio Analyzer	UPA3	860612/022	Firm. V 4.3
119	RT Harmonics Analyzer dig. Flickermeter	B10	G60547	Firm.= V 3.1DHG
140	Signal Generator	SMHU	831314/006	Firm.= 3.21
261	Thermal Power Sensor	NRV-Z55	825083/0008	EPROM-Datum 02.12.04, SE EE 1 B
262	Power Meter	NRV-S	825770/0010	Firm.= 2.6
263	Signal Generator	SMP 04	826190/0007	Firm.=3.21
295	Racal Digital Radio Test Set	6103	1572	UNIT Firmware= 4.04, SW-Main=4.04, SW-BBP=1.04, SW-DSP=1.02, Hardboot=1.02, Softboot=2.02
298	Univ. Radio Communication Tester	CMU 200	832221/091	R&S Test Firmware =3.53 /3.54 (current Testsoftw. f. all band used
323	Digital Radiocommunication Tester	CMD 55	825878/0034	Firm.= 3.52 .22.01.99
335	CTC-EMS-Conducted	System EMS Conducted	-	EMC 32 V 8.52
340	Digital Radiocommunication Tester	CMD 55	849709/037	Firm.= 3.52 .22.01.99
355	Power Meter	URV 5	891310/027	Firm.= 1.31
365	10V Insertion Unit 50 Ohm	URV5-Z2	100880	Eprom Data = 31.03.08
366	Ultra Compact Simulator	UCS 500 M4	V0531100594	Firm. UCS 500=001925/3.06a02, rc=ISMIEC 4.10
371	Bluetooth Tester	CBT32	100153	CBT V5.30+ SW-Option K55, K57
377	EMI Test Receiver	ESCS 30	100160	Firm.= 2.30, OTP= 02.01, GRA= 02.36
378	Broadband RF Field Monitor	RadiSense III	03D00013SNO-08	Firm.= V.03D13
389	Digital Multimeter	Keithley 2000	0583926	Firm. = A13 (Mainboard) A02 (Display)
392	Radio Communication Tester	MT8820A	6K00000788	Firm. = 4.50 #005, IPL=4.01#001, OS=4.02#001, GSM=4.41#013, W-CDMA= 4.54#004, scenario= 4.52#002
436	Univ. Radio Communication Tester	CMU 200	103083	R&S Test Firmware Base=5.14, Mess-Software= GSM:5.14 WCDMA:5.14 (current Testsoftw. F. all band
441	CTC-SAR-EMI Cable Loss	System EMI field (SAR)	-	EMC 32 Version 8.52
442	CTC-SAR-EMS	System EMS field (SAR)	-	EMC 32 Version 8.40
443	CTC-FAR-EMI-RSE	System CTC-FAR-EMI-RSE	-	Spuri 7.2.5 or EMC 32 Ver. 9.15.00
444	CTC-FAR-EMS field	System-EMS-Field (FAR)	-	EMC 32 Version 9.15.00
460	Univ. Radio Communication Tester	CMU 200	108901	R&S Test Firmware Base=5.14, GSM=5.14 WCDMA=5.14 (current Testsoftw.,f. all band to be used,
489	EMI Test Receiver	ESU40	1000-30	Firmware=4.43 SP3, Bios=V5.1-16-3, Spec. =01.00
491	ESD Simulator dito	ESD dito	dito307022	V 2.30
524	Voltage Drop Simulator	VDS 200	0196-16	Software Nr: 000037 Version V4.20a01
526	Burst Generator	EFT 200 A	0496-06	Software Nr. 000034 Version V2.32
527	Micro Pulse Generator	MPG 200 B	0496-05	Software-Nr. 000030 Version V2.43
528	Load Dump Simulator	LD 200B	0496-06	Software-Nr. 000031 Version V2.35a01
546	Univ. Radio Communication Tester	CMU 200	106436	R&S Test Firmware Base=5.14, GSM=5.14 WCDMA=5.14 (current Testsoftw.,f. all band to be used
547	Univ. Radio Communication Tester	CMU 200	835390/014	R&S Test Firmware Base=V5.1403 (current Testsoftw., f. all band used, GSM = 5.14 WCDMA: = 5.14
584	Spectrum Analyzer	FSU 8	100248	2.82_SP3
597	Univ. Radio Communication Tester	CMU 200	100347	R&S Test Firmware Base=5.01, GSM=5.02 WCDMA= not installed, Mainboard= µP1=V.850
598	Spectrum Analyzer	FSEM 30 (Reserve)	831259/013	Firmware Bios 3.40 , Analyzer 3.40 Sp 2
620	EMI Test Receiver	ESU 26	100362	4.43_SP3
642	Wideband Radio Communication Tester	CMW 500	126089	Setup V03.26, Test programm component V03.02.20
670	Univ. Radio Communication Tester	CMU 200	106833	µP1 =V8.50, Firmware = V.20
689	Vector Signal Generator	SMU200	100970	02.20.360.142
692	Bluetooth Tester	CBT 32	100236	CBT V 5.40, FW: V.2.41 (FPGA Digital, V. 3.09 FPGA RF)

8.1.2. Single instruments and test systems

Ref.-No.	Equipment	Type	Serial-No.	Manufacturer	Interval of calibration	Remark	Cal due
001	EMI Test Receiver	ESS	825132/017	Rohde & Schwarz	12 M	-	16.05.2018
005	AC - LISN (50 Ohm/50µH, test site 1)	ESH2-Z5	861741/005	Rohde & Schwarz	12 M	-	15.05.2018
007	Single-Line V-Network (50 Ohm/5µH)	ESH3-Z6	892563/002	Rohde & Schwarz	12 M	-	17.05.2018
009	Power Meter (EMS-radiated)	NRV	863056/017	Rohde & Schwarz	24 M	-	15.05.2019
016	Line Impedance Simulating Network	Op. 24-D	B6366	Spitzenberger+Spies	36 M	-	30.05.2019
020	Horn Antenna 18 GHz (Subst 1)	3115	9107-3699	EMCO	36/12 M	-	31.07.2017
021	Loop Antenna (H-Field)	6502	9206-2770	EMCO	36 M	-	30.04.2018
030	Loop Antenna (H-field)	HFH-Z2	879604/026	Rohde & Schwarz	36 M	-	30.04.2018
033	RF-current probe (100kHz-30MHz)	ESH2-Z1	879581/18	Rohde & Schwarz	24 M	-	15.05.2019
057	relay-switch-unit (EMS system)	RSU	494440/002	Rohde & Schwarz	pre-m	1a	
060	power amplifier (DC-2kHz)	PAS 5000	B6363	Spitzenberger+Spies	-	3	
066	notch filter (WCDMA; FDD1)	WRCT 1900/2200-5/40-10EEK	5	Wainwright GmbH	12 M	1g	30.06.2017
086	DC - power supply, 0 -10 A	LNG 50-10	-	Heinzinger Electronic	pre-m	2	
087	DC - power supply, 0 -5 A	EA-3013 S	-	Elektro Automatik	pre-m	2	
091	USB-LWL-Converter	OLS-1	007/2006	Ing. Büro Scheiba	-	4	
099	passive voltage probe	ESH2-Z3	299.7810.52	Rohde & Schwarz	36 M	-	30.04.2018
100	passive voltage probe	Probe TK 9416	without	Schwarzbeck	36 M	-	30.04.2018
110	USB-LWL-Converter	OLS-1	-	Ing. Büro Scheiba	-	4	
119	RT Harmonics Analyzer dig. Flickermeter	B10	G60547	BOCONSULT	36 M	-	30.05.2019
133	horn antenna 18 GHz (Meas 1)	3115	9012-3629	EMCO	36 M	1c	10.03.2020
134	horn antenna 18 GHz (Subst 2)	3115	9005-3414	EMCO	36 M	-	10.03.2020
136	adjustable dipole antenna (Dipole 1)	3121C-DB4	9105-0697	EMCO	36 M	-	30.04.2018
140	Signal Generator	SMHU	831314/006	Rohde & Schwarz	24 M	-	30.05.2018
248	attenuator	SMA 6dB 2W	-	Radiall	pre-m	2	
249	attenuator	SMA 10dB 10W	-	Radiall	pre-m	2	
252	attenuator	N 6dB 12W	-	Radiall	pre-m	2	
256	attenuator	SMA 3dB 2W	-	Radiall	pre-m	2	
257	hybrid	4031C	04491	Narda	pre-m	2	
260	hybrid coupler	4032C	11342	Narda	pre-m	2	
261	Thermal Power Sensor	NRV-Z55	825083/0008	Rohde & Schwarz	24 M	-	30.05.2018
262	Power Meter	NRV-S	825770/0010	Rohde & Schwarz	24 M	-	30.05.2018
263	Signal Generator	SMP 04	826190/0007	Rohde & Schwarz	36 M	-	30.05.2019
265	peak power sensor	NRV-Z33, Model 04	840414/009	Rohde & Schwarz	24 M	-	30.05.2018
266	Peak Power Sensor	NRV-Z31, Model 04	843383/016	Rohde & Schwarz	24 M	-	30.05.2018
267	notch filter GSM 850	WRCA 800/960-6EEK	9	Wainwright GmbH	pre-m	2	
270	termination	1418 N	BB6935	Weinschel	pre-m	2	
271	termination	1418 N	BE6384	Weinschel	pre-m	2	
272	attenuator (20 dB) 50 W	Model 47	BF6239	Weinschel	pre-m	2	
273	attenuator (10 dB) 100 W	Model 48	BF9229	Weinschel	pre-m	2	
274	attenuator (10 dB) 50 W	Model 47 (10 dB) 50 W	BG0321	Weinschel	pre-m	2	
275	DC-Block	Model 7003 (N)	C5129	Weinschel	pre-m	2	
276	DC-Block	Model 7006 (SMA)	C7061	Weinschel	pre-m	2	
279	power divider	1515 (SMA)	LH855	Weinschel	pre-m	2	
287	pre-amplifier 25MHz - 4GHz	AMF-2D-100M4G-35-10P	379418	Miteq	12 M	1c	30.06.2017
291	high pass filter GSM 850/900	WHJ 2200-4EE	14	Wainwright GmbH	12 M	1c	30.06.2017
298	Univ. Radio Communication Tester	CMU 200	832221/091	Rohde & Schwarz	pre-m	3	
300	AC LISN (50 Ohm/50µH, 1-phase)	ESH3-Z5	892 239/020	Rohde & Schwarz	12 M	-	17.05.2018
301	attenuator (20 dB) 50W, 18GHz	47-20-33	AW0272	Lucas Weinschel	pre-m	2	
302	horn antenna 40 GHz (Meas 1)	BBHA9170	155	Schwarzbeck	36 M	-	14.03.2020
303	horn antenna 40 GHz (Subst 1)	BBHA9170	156	Schwarzbeck	36 M	-	20.03.2020
331	Climatic Test Chamber -40/+180 Grad	HC 4055	43146	Heraeus Vötsch	24 M	-	30.10.2018
341	Digital Multimeter	Fluke 112	81650455	Fluke	24 M	-	30.05.2018
342	Digital Multimeter	Voltcraft M-4660A	IB 255466	Voltcraft	24 M	-	17.05.2019
347	laboratory site	radio lab.	-	-	-	5	
348	laboratory site	EMI conducted	-	-	-	5	
354	DC - Power Supply 40A	NGPE 40/40	448	Rohde & Schwarz	pre-m	2	
355	Power Meter	URV 5	891310/027	Rohde & Schwarz	24 M	-	30.05.2018
357	power sensor	NRV-Z1	861761/002	Rohde & Schwarz	24 M	-	24.05.2019
371	Bluetooth Tester	CBT32	100153	R&S	36 M	-	30.05.2019
373	Single-Line V-Network (50 Ohm/5µH)	ESH3-Z6	100535	Rohde & Schwarz	12 M	-	17.05.2018
377	EMI Test Receiver	ESCS 30	100160	Rohde & Schwarz	12 M	-	15.05.2018
389	Digital Multimeter	Keithley 2000	0583926	Keithley	24 M	-	31.12.2017
392	Radio Communication Tester	MT8820A	6K00000788	Anritsu	12 M	-	18.05.2018
405	Thermo-/Hygrometer	OPUS 10 THI	126.0604.0003.3.3.3.2 2	LUFFT Mess u. Regeltechnik	24 M	-	30.03.2019
431	Model 7405	Near-Field Probe Set	9305-2457	EMCO	-	4	
436	Univ. Radio Communication Tester	CMU 200	103083	Rohde & Schwarz	12 M	-	24.05.2018
439	UltraLog-Antenna	HL 562	100248	Rohde & Schwarz	36 M	-	10.03.2020

Ref.-No.	Equipment	Type	Serial-No.	Manufacturer	Interval of calibration	Remark	Cal due
441	CTC-SAR-EMI Cable Loss	System EMI field (SAR) Cable	-	CETECOM	12 M	5	31.12.2017
443	CTC-FAR-EMI-RSE	System CTC-FAR-EMI-RSE	-	ETS-Lindgren / CETECOM	12 M	5	31.12.2017
448	notch filter WCDMA_FDD II	WRCT 1850.0/2170.0-5/40-	5	Wainwright Instruments GmbH	12 M	1c	31.12.2017
449	notch filter WCDMA FDD V	WRCT 824.0/894.0-5/40-8SSK	1	Wainwright	12 M	1c	31.12.2017
454	Oscilloscope	HM 205-3	9210 P 29661	Hameg	-	4	
456	DC-Power supply 0-5 A	EA 3013 S	207810	Elektro Automatik	pre-m	2	
459	DC -Power supply 0-5 A , 0-32 V	EA-PS 2032-50	910722	Elektro Automatik	pre-m	2	
460	Univ. Radio Communication Tester	CMU 200	108901	Rohde & Schwarz	12 M	-	16.06.2018
463	Universal source	HP3245A	2831A03472	Agilent	-	4	
466	Digital Multimeter	Fluke 112	89210157	Fluke USA	24 M	-	30.05.2018
467	Digital Multimeter	Fluke 112	89680306	Fluke USA	36 M	-	30.04.2018
468	Digital Multimeter	Fluke 112	90090455	Fluke USA	36 M	-	30.04.2018
477	ReRadiating GPS-System	AS-47	-	Automotive Cons. Fink	-	3	
480	power meter (Fula)	NRVS	838392/031	Rohde & Schwarz	24 M	-	16.05.2019
482	filter matrix	Filter matrix SAR 1	-	CETECOM (Brl)	-	1d	
484	pre-amplifier 2,5 - 18 GHz	AMF-5D-02501800-25-10P	1244554	Miteq	12 M	-	30.07.2017
487	System CTC NSA-Verification SAR-EMI	System EMI field (SAR) NSA	-	ETS Lindgren / CETECOM	24 M	-	31.03.2019
489	EMI Test Receiver	ESU40	1000-30	Rohde & Schwarz	12 M	-	18.05.2019
502	band reject filter	WRCG 1709/1786-1699/1796-	SN 9	Wainwright	pre-m	2	
503	band reject filter	WRCG 824/849-814/859-	SN 5	Wainwright	pre-m	2	
512	notch filter GSM 850	WRCA 800/960-02/40-6EEK	SN 24	Wainwright	12 M	1c	31.12.2017
517	relais switch matrix	HF Relais Box Keithley	SE 04	Keithley	pre-m	2	
523	Digital Multimeter	L4411A	MY46000154	Agilent	24 M	-	18.05.2019
529	6 dB Broadband resistive power divider	Model 1515	LH 855	Weinschel	pre-m	2	
530	10 dB Broadband resistive power divider	R 416110000	LOT 9828	-	pre-m	2	
546	Univ. Radio Communication Tester	CMU 200	106436	R&S	12 M	-	30.03.2018
547	Univ. Radio Communication Tester	CMU 200	835390/014	Rohde & Schwarz	12 M	-	05.07.2018
549	Log.Per-Antenna	HL025	1000060	Rohde & Schwarz	36/12 M	-	31.07.2018
550	System CTC S-VSWR Verification SAR-EMI	System EMI Field SAR S-VSWR	-	ETS Lindgren/CETECOM	24 M	-	30.03.2019
552	high pass filter 2,8-18GHz	WHKX 2.8/18G-10SS	4	Wainwright	12 M	1c	31.12.2017
557	System CTC-OTA-2	R&S TS8991	-	Rohde & Schwarz	12 M	5	31.12.2017
558	System CTC FAR S-VSWR	System CTC FAR S-VSWR	-	CTC	24 M	-	08.08.2019
574	Biconilog Hybrid Antenna	BTA-L	980026L	Frankonia	36/12 M	-	31.03.2019
584	Spectrum Analyzer	FSU 8	100248	Rohde & Schwarz	pre-m	-	
594	Wideband Radio Communication Tester	CMW 500	101757	Rohde & Schwarz	12 M	-	30.04.2017
597	Univ. Radio Communication Tester	CMU 200	100347	Rohde & Schwarz	pre-m	-	
600	power meter	NRVD (Reserve)	834501/018	Rohde & Schwarz	24 M	-	17.05.2019
601	medium-sensitivity diode sensor	NRV-Z5 (Reserve)	8435323/003	Rohde & Schwarz	24 M	-	15.05.2019
602	peak power sensor	NRV-Z32 (Reserve)	835080	Rohde & Schwarz	24 M	-	
611	DC power supply	E3632A	KR 75305854	Agilent	pre-m	2	
612	DC power supply	E3632A	MY 40001321	Agilent	pre-m	2	
613	Attenuator	R416120000 20dB 10W	Lot. 9828	Radiall	pre-m	2	
616	Digitalmultimeter	Fluke 177	88900339	Fluke	24 M	-	30.05.2018
617	Power Splitter/Combiner	ZFSC-2-2-S+	S F987001108	Mini Circuits	-	2	
618	Power Splitter/Combiner	50PD-634	600994	JFW Industries USA	-	2	
619	Power Splitter/Combiner	50PD-634	600995	JFW Industries, USA	-	3	
620	EMI Test Receiver	ESU 26	100362	Rohde-Schwarz	12 M	-	16.05.2018
621	Step Attenuator 0-139 dB	RSP	100017	Rohde & Schwarz	pre-m	2	
625	Generic Test Load USB	Generic Test Load USB	-	CETECOM	-	2	
627	data logger	OPUS 1	201.0999.9302.6.4.1.4 3	G. Luft GmbH	24 M	-	30.03.2019
634	Spectrum Analyzer	FSM (HF-Unit)	826188/010	Rohde & Schwarz	pre-m	2	
637	High Speed HDMI with Ethernet 1m	HDMI cable with Ethernet 1m	-	Kogilink	-	2	
638	HDMI Kabel with Ethernet 1,5 m flach	HDMI cable with Ethernet	-	Reichelt	-	2	
640	HDMI cable 2m rund	HDMI cable 2m rund	-	Reichelt	-	2	
641	HDMI cable with Ethernet	Certified HDMI cable with	-	PureLink	-	2	
642	Wideband Radio Communication Tester	CMW 500	126089	Rohde&Schwarz	12 M	-	24.05.2018
644	Amplifierer	ZX60-2534M+	SN865701299	Mini-Circuits	-	-	
670	Univ. Radio Communication Tester	CMU 200	106833	Rohde & Schwarz	24 M	-	30.05.2018
671	DC-power supply 0-5 A	EA-3013S	-	Elektro Automatik	pre-m	2	
678	Power Meter	NRP	101638	Rohde&Schwarz	pre-m	-	
683	Spectrum Analyzer	FSU 26	200571	Rohde & Schwarz	12 M	-	17.05.2018

Ref.-No.	Equipment	Type	Serial-No.	Manufacturer	Interval of calibration	Remark	Cal due
686	Field Analyzer	EHP-200A	160WX30702	Narda Safety Test Solutions	24 M	-	29.03.2019
687	Signal Generator	SMF 100A	102073	Rohde&Schwarz	12 M	-	17.05.2018
688	Pre Amp	JS-18004000-40-8P	1750117	Miteq	pre-m	-	
690	Spectrum Analyzer	FSU	100302/026	Rohde&Schwarz	12 M	-	16.05.2018
691	OSP120 Base Unit	OSP120	101183	Rohde & Schwarz	12 M	-	22.05.2018
692	Bluetooth Tester	CBT 32	100236	Rohde & Schwarz	36 M	-	29.05.2020
693	TS8997	CTC-Radio Lab 1_TS8997	-	Rohde&Schwarz	12 M	5	31.12.2017
697	Power Splitter	ZN4PD-642W-S+	165001445	Mini-Circuits	-	2	
701	CMW500 wide. Radio Comm.	CMW500	158150	Rohde & Schwarz	12 M	-	31.12.2017
703	INNCO Antennen Mast	MA 4010-KT080-XPET-ZSS3	MA4170-KT100-XPET-	INNCO	pre-m	-	
704	INNCON Controller	CO 3000-4port	CO3000/933/38410516/L	INNCO Systems GmBh	pre-m	-	
711	Harmonic Mixer 90 GHz - 140GHz	RPG FS-Z140	101004	RPG	12 M	-	22.02.2018
712	Harmonic Mixer 75 GHz - 110GHz	FS-Z110	101468	Rohde & Schwarz	12 M	-	22.02.2018
713	Harmonic Mixer, 50 GHz - 75GHz	FS-Z75	101022	Rohde & Schwarz	12 M	-	22.05.2018
714	Signal Analyzer 67GHz	FSW67	104023	Rohde & Schwarz	24 M	-	03.03.2019
715	Harmonic Mixer, 140 GHz - 220GHz	FS-Z220	101009	RPG Radiometer Physics	12 M	-	03.08.2018
716	Harmonic Mixer 220 GHz to 325 GHz	FS-Z325	101005	RPG Radiometer Physics	12 M	-	13.02.2018
747	Spectrum Analyzer	FSU 26	200152	Rohde & Schwarz	12 M	-	18.05.2018
748	Pickett-Potter Horn Antenna	FH-PP 4060	010001	Radiometer Physics	-	-	
749	Pickett-potter Horn Antenna	FH-PP 60-90	010003	Radiometer Physics	-	-	
750	Pickett-Potter Horn Antenna	FH-PP 140-220	010011	Radiometer Physics	-	-	

8.1.3. Legend

Note / remarks		Calibrated during system calibration:
	1a	System CTC-SAR-EMS (Ref.-No. 442)
	1b	System-CTC-EMS-Conducted (Ref.-No. 335)
	1c	System CTC-FAR-EMI-RSE (Ref.-No. 443)
	1d	System CTC-SAR-EMI (Ref.-No. 441)
	1e	System CTC-OATS (EMI radiated) (Ref.-No. 337)
	1 f	System CTC-CTIA-OTA (Ref.-No. 420)
	1 g	System CTC-FAR-EMS (Ref.-No. 444)
	2	Calibration or equipment check immediately before measurement
	3	Regulatory maintained equipment for functional check or support purpose
	4	Ancillary equipment without calibration e.g. mechanical equipment or monitoring equipment
	5	Test System

Interval of calibration	12 M	12 month
	24 M	24 month
	36 M	36 month
	24/12 M	Calibration every 24 months, between this every 12 months internal validation
	36/12 M	Calibration every 36 months, between this every 12 months internal validation
	Pre-m	Check before starting the measurement
	-	Without calibration

9. Versions of test reports (change history)

Version	Applied changes	Date of release
--	Initial release	2017-08-24
--	--	--
--	--	--