



A D T

# FCC TEST REPORT (15.407)

**REPORT NO.:** RF990419C03-1

**MODEL NO.:** APL21-083

**RECEIVED:** Apr. 19, 2010

**TESTED:** Apr. 23 ~ May 03, 2010

**ISSUED:** May 06, 2010

**APPLICANT:** Sonicwall, Inc.

**ADDRESS:** 2001 Logic Drive San Jose, CA 95124, USA

**ISSUED BY:** Bureau Veritas Consumer Products Services  
(H.K.) Ltd., Taoyuan Branch

**LAB ADDRESS:** No. 47, 14th Ling, Chia Pau Tsuen, Lin Kou  
Hsiang, Taipei Hsien 244, Taiwan, R.O.C.

**TEST LOCATION:** No. 19, Hwa Ya 2nd Rd, Wen Hwa Tsuen, Kwei  
Shan Hsiang, Taoyuan Hsien 333, Taiwan,  
R.O.C.

This test report consists of 68 pages. It may be duplicated completely for legal use with the approval of the applicant. It should not be reproduced except in full, without the written approval of our laboratory. The client should not use it to claim product endorsement by TAF or any government agencies. The test results in the report only apply to the tested sample.





## TABLE OF CONTENTS

1.	CERTIFICATION.....	4
2.	SUMMARY OF TEST RESULTS .....	5
2.1	MEASUREMENT UNCERTAINTY .....	5
3.	GENERAL INFORMATION.....	6
3.1	GENERAL DESCRIPTION OF EUT .....	6
3.2	DESCRIPTION OF TEST MODES .....	8
3.2.1	CONFIGURATION OF SYSTEM UNDER TEST .....	8
3.2.2	TEST MODE APPLICABILITY AND TESTED CHANNEL DETAIL .....	9
3.3	GENERAL DESCRIPTION OF APPLIED STANDARDS .....	11
3.4	DESCRIPTION OF SUPPORT UNITS .....	11
4.	TEST TYPES AND RESULTS .....	12
4.1	RADIATED EMISSION MEASUREMENT .....	12
4.1.1	LIMITS OF RADIATED EMISSION MEASUREMENT .....	12
4.1.2	LIMITS OF UNWANTED EMISSION OUT OF THE RESTRICTED BANDS .....	12
4.1.3	TEST INSTRUMENTS.....	13
4.1.4	TEST PROCEDURES .....	14
4.1.5	DEVIATION FROM TEST STANDARD.....	14
4.1.6	TEST SETUP .....	15
4.1.7	EUT OPERATING CONDITION.....	15
4.1.8	TEST RESULTS .....	16
4.2	CONDUCTED EMISSION MEASUREMENT .....	25
4.2.1	LIMITS OF CONDUCTED EMISSION MEASUREMENT .....	25
4.2.2	TEST INSTRUMENTS.....	25
4.2.3	TEST PROCEDURES .....	26
4.2.4	DEVIATION FROM TEST STANDARD.....	26
4.2.5	TEST SETUP.....	27
4.2.6	EUT OPERATING CONDITIONS .....	27
4.2.7	TEST RESULTS .....	28
4.3	MAXIMUM CONDUCTED OUTPUT POWER MEASUREMENT .....	30
4.3.1	LIMITS OF MAXIMUM CONDUCTED OUTPUT POWER MEASUREMENT.....	30
4.3.2	TEST INSTRUMENTS.....	30
4.3.3	TEST PROCEDURE.....	31
4.3.4	DEVIATION FROM TEST STANDARD.....	31
4.3.5	TEST SETUP.....	31
4.3.6	EUT OPERATING CONDITIONS .....	31
4.3.7	TEST RESULTS .....	32
4.4	PEAK POWER EXCURSION MEASUREMENT .....	36
4.4.1	LIMITS OF PEAK POWER EXCURSION MEASUREMENT .....	36
4.4.2	TEST INSTRUMENTS.....	36
4.4.3	TEST PROCEDURE.....	36
4.4.4	DEVIATION FROM TEST STANDARD.....	37
4.4.5	TEST SETUP .....	37
4.4.6	EUT OPERATING CONDITIONS .....	37
4.4.7	TEST RESULTS .....	38
4.5	PEAK POWER SPECTRAL DENSITY MEASUREMENT .....	44
4.5.1	LIMITS OF PEAK POWER SPECTRAL DENSITY MEASUREMENT .....	44
4.5.2	TEST INSTRUMENTS.....	44
4.5.3	TEST PROCEDURES .....	44



A D T

4.5.4	DEVIATION FROM TEST STANDARD.....	45
4.5.5	TEST SETUP.....	45
4.5.6	EUT OPERATING CONDITIONS.....	45
4.5.7	TEST RESULTS.....	46
4.6	FREQUENCY STABILITY.....	49
4.6.1	LIMITS OF FREQUENCY STABILITY MEASUREMENT.....	49
4.6.2	TEST INSTRUMENTS.....	49
4.6.3	TEST PROCEDURE.....	49
4.6.4	DEVIATION FROM TEST STANDARD.....	50
4.6.5	TEST SETUP.....	50
4.6.6	EUT OPERATING CONDITION.....	50
4.6.7	TEST RESULTS.....	51
4.7	BAND EDGES MEASUREMENT.....	52
4.7.1	TEST INSTRUMENTS.....	52
4.7.2	TEST PROCEDURE.....	53
4.7.3	EUT OPERATING CONDITION.....	53
4.7.4	TEST RESULTS.....	54
5.	PHOTOGRAPHS OF THE TEST CONFIGURATION.....	66
6.	INFORMATION ON THE TESTING LABORATORIES.....	67
7.	APPENDIX A - MODIFICATIONS RECORDERS FOR ENGINEERING CHANGES TO THE EUT BY THE LAB.....	68



A D T

## 1. CERTIFICATION

**PRODUCT:** Access Point 802.11 a/b/g/n

**MODEL NO.:** APL21-083

**BRAND:** SonicWALL

**APPLICANT:** Sonicwall, Inc.

**TEST SAMPLE:** ENGINEERING SAMPLE

**TESTED:** Apr. 23 ~ May 03, 2010

**STANDARDS: FCC Part 15, Subpart E (Section 15.407)**

ANSI C63.4-2003

The above equipment (Model: APL21-083) has been tested by **Bureau Veritas Consumer Products Services (H.K.) Ltd., Taoyuan Branch**, and found compliance with the requirement of the above standards. The test record, data evaluation & Equipment Under Test (EUT) configurations represented herein are true and accurate accounts of the measurements of the sample's EMC characteristics under the conditions specified in this report.

**PREPARED BY** : Andrea Hsia , **DATE:** May 06, 2010  
Andrea Hsia / Specialist

**TECHNICAL ACCEPTANCE** : Long Chen , **DATE:** May 06, 2010  
Responsible for RF Long Chen / Senior Engineer

**APPROVED BY** : Gary Chang , **DATE:** May 06, 2010  
Gary Chang / Assistant Manager



## 2. SUMMARY OF TEST RESULTS

The EUT has been tested according to the following specifications:

APPLIED STANDARD: FCC PART 15, SUBPART E (SECTION 15.407)			
STANDARD SECTION	TEST TYPE AND LIMIT	RESULT	REMARK
15.407(b)(5)	AC Power Conducted Emission	PASS	Meet the requirement of limit. Minimum passing margin is -19.71dB at 3.813MHz.
15.407(b)(1/2/3) (b)(5)	Electric Field Strength Spurious Emissions, 30MHz ~ 40000MHz	PASS	Meet the requirement of limit. Minimum passing margin is -2.7dB at 527.09MHz.
15.407(a)(1/2/3)	Peak Transmit Power	PASS	Meet the requirement of limit.
15.407(a)(6)	Peak Power Excursion	PASS	Meet the requirement of limit.
15.407(a)(1/2/3)	Peak Power Spectral Density	PASS	Meet the requirement of limit.
15.407(g)	Frequency Stability	PASS	Meet the requirement of limit.
15.203	Antenna Requirement	PASS	Antenna connector is IPEX not a standard connector.
2.1091	Radiofrequency Radiation Exposure Evaluation	PASS	Meet the requirement of limit.

### 2.1 MEASUREMENT UNCERTAINTY

Where relevant, the following measurement uncertainty levels have been estimated for tests performed on the EUT as specified in CISPR 16-4-2:

MEASUREMENT	FREQUENCY	UNCERTAINTY
Conducted emissions	9kHz~30MHz	2.44 dB
Radiated emissions	30MHz ~ 200MHz	2.93 dB
	200MHz ~1000MHz	2.95 dB
	1GHz ~ 18GHz	2.26 dB
	18GHz ~ 40GHz	1.94 dB

This uncertainty represents an expanded uncertainty expressed at approximately the 95% confidence level using a coverage factor of  $k = 2$ .



### 3. GENERAL INFORMATION

#### 3.1 GENERAL DESCRIPTION OF EUT

<b>PRODUCT</b>	Access Point 802.11 a/b/g/n
<b>MODEL NO.</b>	APL21-083
<b>FCC ID</b>	QWU-083
<b>NOMINAL VOLTAGE</b>	48Vdc (POE)
<b>MODULATION TYPE</b>	64QAM, 16QAM, QPSK, BPSK for OFDM
<b>MODULATION TECHNOLOGY</b>	OFDM
<b>TRANSFER RATE</b>	802.11a: 54.0/ 48.0/ 36.0/ 24.0/ 18.0/ 12.0/ 9.0/ 6.0Mbps 802.11n: up to 300.0Mbps
<b>OPERATING FREQUENCY</b>	5180.0 ~ 5240.0MHz
<b>NUMBER OF CHANNEL</b>	4 for 802.11a, 802.11n (20MHz) 2 for 802.11n (40MHz)
<b>OUTPUT POWER</b>	48.7mW
<b>ANTENNA TYPE</b>	PIFA antenna with 4.0dBi gain
<b>ANTENNA CONNECTER</b>	IPEX
<b>DATA CABLE</b>	NA
<b>I/O PORTS</b>	RJ45, Console
<b>ACCESSORY DEVICES</b>	NA

**NOTE:**

1. The EUT is an Access Point 802.11 a/b/g/n. The functions of EUT listed as below:

	TEST STANDARD	REFERENCE REPORT
WLAN 802.11b/g, 802.11n	FCC Part 15, Subpart C (Section 15.247)	RF990419C03
WLAN 802.11a, 802.11n (5745~5825 MHz)		
WLAN 802.11a, 802.11n (5180~ 5240MHz)	FCC Part 15, Subpart E (Section 15.407)	RF990419C03-1

2. The frequency bands used in this EUT are listed as follows:

Frequency Band (MHz)	2412~2462	5180~5240	5745~5825
802.11b	√		
802.11g	√		
802.11a		√	√
802.11n (20MHz)	√	√	√
802.11n (40MHz)	√	√	√

3. The EUT incorporates a MIMO function. Physically, the EUT provides three completed transmitters and three receivers.

MODULATION MODE	TX FUNCTION
802.11b	3TX
802.11g	3TX
802.11a	3TX
802.11n (20MHz)	3TX
802.11n (40MHz)	3TX

4. The EUT uses following POE:

POE	
BRAND	EnGenius
MODEL	NPE-7530G
OUTPUT POWER	48Vdc

POE's Adapter	
BRAND	MW
MODEL	ES18U48-480
INPUT POWER	100-240Vac, 50/60Hz, 0.5A
OUTPUT POWER	48Vdc, 0.375A, 18W
POEWR LINE	1.8 m non-shielded cable with one core

\*\*POE & POE's adapter were for the optional accessories

5. The above EUT information was declared by manufacturer and for more detailed features description, please refer to the manufacturer's specifications or user's manual.

### 3.2 DESCRIPTION OF TEST MODES

4 channels are provided for 802.11a and 802.11n (20MHz):

CHANNEL	FREQUENCY	CHANNEL	FREQUENCY
36	5180MHz	44	5220MHz
40	5200MHz	48	5240MHz

2 channels are provided for 802.11n (40MHz):

CHANNEL	FREQUENCY	CHANNEL	FREQUENCY
38	5190MHz	46	5230MHz

#### 3.2.1 CONFIGURATION OF SYSTEM UNDER TEST

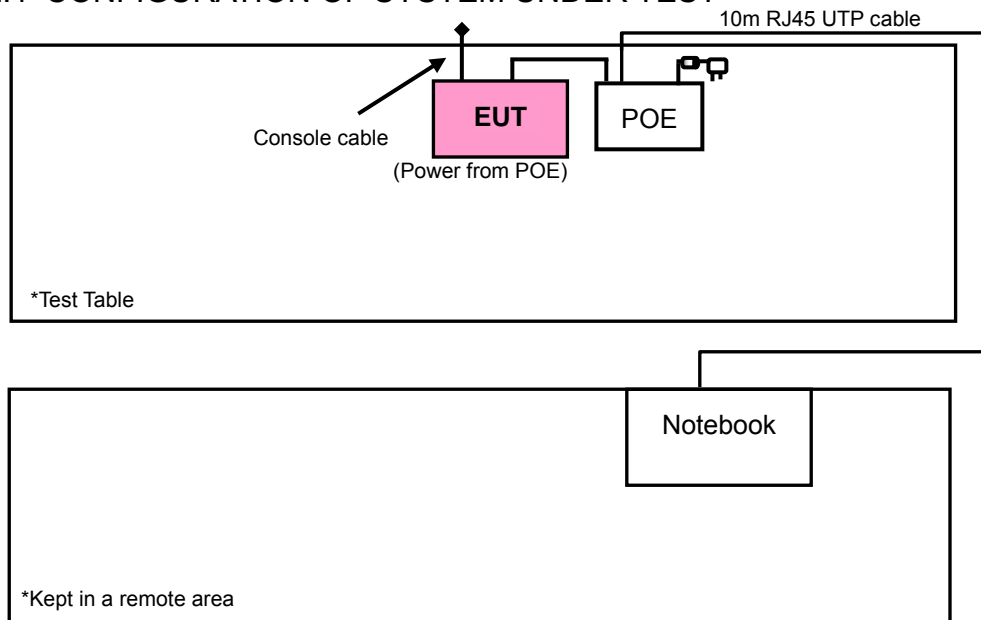



### 3.2.2 TEST MODE APPLICABILITY AND TESTED CHANNEL DETAIL

EUT CONFIGURE MODE	APPLICABLE TO				DESCRIPTION
	RE $\geq$ 1G	RE $<$ 1G	PLC	APCM	
-	√	√	√	√	-

Where **RE $\geq$ 1G**: Radiated Emission above 1GHz      **RE $<$ 1G**: Radiated Emission below 1GHz  
**PLC**: Power Line Conducted Emission      **APCM**: Antenna Port Conducted Measurement

#### **RADIATED EMISSION TEST (ABOVE 1GHz):**

- Pre-Scan has been conducted to determine the worst-case mode from all possible combinations between available modulations, data rates and antenna ports (if EUT with antenna diversity architecture).
- Following channel(s) was (were) selected for the final test as listed below.

MODE	AVAILABLE CHANNEL	TESTED CHANNEL	MODULATION TECHNOLOGY	MODULATION TYPE	DATA RATE (Mbps)
802.11a	36 to 48	36, 40, 48	OFDM	BPSK	6.0
802.11n (20MHz)	36 to 48	36, 40, 48	OFDM	BPSK	7.2
802.11n (40MHz)	38 to 46	38, 46	OFDM	BPSK	15.0

#### **RADIATED EMISSION TEST (BELOW 1GHz):**

- Pre-Scan has been conducted to determine the worst-case mode from all possible combinations between available modulations, data rates and antenna ports (if EUT with antenna diversity architecture).
- Following channel(s) was (were) selected for the final test as listed below.

MODE	AVAILABLE CHANNEL	TESTED CHANNEL	MODULATION TECHNOLOGY	MODULATION TYPE	DATA RATE (Mbps)
802.11a	36 to 48	40	OFDM	BPSK	6.0

#### **POWER LINE CONDUCTED EMISSION TEST:**

- Pre-Scan has been conducted to determine the worst-case mode from all possible combinations between available modulations, data rates and antenna ports (if EUT with antenna diversity architecture).
- Following channel(s) was (were) selected for the final test as listed below.

MODE	AVAILABLE CHANNEL	TESTED CHANNEL	MODULATION TECHNOLOGY	MODULATION TYPE	DATA RATE (Mbps)
802.11a	36 to 48	40	OFDM	BPSK	6.0



**BANDEDGE MEASUREMENT:**

- Pre-Scan has been conducted to determine the worst-case mode from all possible combinations between available modulations, data rates and antenna ports (if EUT with antenna diversity architecture).
- Following channel(s) was (were) selected for the final test as listed below.

MODE	AVAILABLE CHANNEL	TESTED CHANNEL	MODULATION TECHNOLOGY	MODULATION TYPE	DATA RATE (Mbps)
802.11a	36 to 48	36, 48	OFDM	BPSK	6.0
802.11n (20MHz)	36 to 48	36, 48	OFDM	BPSK	7.2
802.11n (40MHz)	38 to 46	38, 46	OFDM	BPSK	15.0

**ANTENNA PORT CONDUCTED MEASUREMENT:**

- This item includes all test value of each mode, but only includes spectrum plot of worst value of each mode.
- Pre-Scan has been conducted to determine the worst-case mode from all possible combinations between available modulations, data rates and antenna ports (if EUT with antenna diversity architecture).
- Following channel(s) was (were) selected for the final test as listed below.

MODE	AVAILABLE CHANNEL	TESTED CHANNEL	MODULATION TECHNOLOGY	MODULATION TYPE	DATA RATE (Mbps)
802.11a	36 to 48	36, 40, 48	OFDM	BPSK	6.0
802.11n (20MHz)	36 to 48	36, 40, 48	OFDM	BPSK	7.2
802.11n (40MHz)	38 to 46	38, 46	OFDM	BPSK	15.0

**TEST CONDITION:**

APPLICABLE TO	ENVIRONMENTAL CONDITIONS	INPUT POWER (SYSTEM)	TESTED BY
RE≥1G	23deg. C, 65%RH, 1020 hPa	120Vac, 60Hz	Dean Wang
RE<1G	25deg. C, 65%RH, 1020 hPa	120Vac, 60Hz	Brad Wu
PLC	24deg. C, 60%RH, 1020 hPa	120Vac, 60Hz	Mick Chou
APCM	23deg. C, 70%RH, 1020 hPa	120Vac, 60Hz	Brad Wu



### 3.3 GENERAL DESCRIPTION OF APPLIED STANDARDS

The EUT is a RF Product. According to the specifications of the manufacturer, it must comply with the requirements of the following standards:

#### FCC Part 15, Subpart E (15.407)

#### ANSI C63.4-2003

All test items have been performed and recorded as per the above standards.

**NOTE:** The EUT is also considered as a kind of computer peripheral, because the connection to computer is necessary for typical use. It has been verified to comply with the requirements of FCC Part 15, Subpart B, Class B (DoC). The test report has been issued separately.

### 3.4 DESCRIPTION OF SUPPORT UNITS

The EUT has been tested as an independent unit together with other necessary accessories or support units. The following support units or accessories were used to form a representative test configuration during the tests.

NO.	PRODUCT	BRAND	MODEL NO.	SERIAL NO.	FCC ID
1	NOTEBOOK	DELL	PP05L	25191592336	E2K24CLNS
2	POE	EnGenius	NPE-7530G	NA	NA

NO.	SIGNAL CABLE DESCRIPTION OF THE ABOVE SUPPORT UNITS
1	10m UTP RJ45 cable
2	3m UTP RJ45 cable

**NOTE:** 1. All power cords of the above support units are non shielded (1.8m).  
2. Item 1 acted as a communication partner to transfer data.  
3. Item 2 was supplied from client.



## 4. TEST TYPES AND RESULTS

### 4.1 RADIATED EMISSION MEASUREMENT

#### 4.1.1 LIMITS OF RADIATED EMISSION MEASUREMENT

Emissions radiated outside of the specified bands, shall be according to the general radiated limits in 15.209 as following:

FREQUENCIES (MHz)	FIELD STRENGTH (microvolts/meter)	MEASUREMENT DISTANCE (meters)
0.009 ~ 0.490	2400/F(kHz)	300
0.490 ~ 1.705	24000/F(kHz)	30
1.705 ~ 30.0	30	30
30 ~ 88	100	3
88 ~ 216	150	3
216 ~ 960	200	3
Above 960	500	3

**NOTE:**

1. The lower limit shall apply at the transition frequencies.
2. Emission level (dBuV/m) = 20 log Emission level (uV/m).
3. As shown in 15.35(b), for frequencies above 1000MHz, the field strength limits are based on average detector, however, the peak field strength of any emission shall not exceed the maximum permitted average limits, specified above by more than 20dB under any condition of modulation.

#### 4.1.2 LIMITS OF UNWANTED EMISSION OUT OF THE RESTRICTED BANDS

FREQUENCIES (MHz)	EIRP LIMIT (dBm)	EQUIVALENT FIELD STRENGTH AT 3m (dBµV/m) *NOTE 3
	PK	PK
5150 ~ 5250	-27	68.3

**NOTE:** The following formula is used to convert the equipment isotropic radiated power (eirp) to field strength:

$$E = \frac{1000000\sqrt{30P}}{3} \mu\text{V/m, where P is the eirp (Watts).}$$



A D T

#### 4.1.3 TEST INSTRUMENTS

DESCRIPTION & MANUFACTURER	MODEL NO.	SERIAL NO.	DATE OF CALIBRATION	DUE DATE OF CALIBRATION
Test Receiver ROHDE & SCHWARZ	ESIB7	100212	May 25, 2009	May 24, 2010
Spectrum Analyzer ROHDE & SCHWARZ	FSP40	100040	Jul. 07, 2009	Jul. 06, 2010
BILOG Antenna SCHWARZBECK	VULB9168	9168-156	Apr. 30, 2010	Apr. 29, 2011
HORN Antenna SCHWARZBECK	BBHA 9120 D	9120D-563	Aug. 10, 2009	Aug. 09, 2010
HORN Antenna SCHWARZBECK	BBHA 9170	BBHA9170242	Dec. 25, 2009	Dec. 24, 2010
Preamplifier Agilent	8449B	3008A01910	Sep. 11, 2009	Sep. 10, 2010
Preamplifier Agilent	8447D	2944A10638	Dec. 21, 2009	Dec. 20, 2010
RF signal cable HUBER+SUHNNER	SUCOFLEX 104	218190/4 231241/4	May 13, 2009	May 12, 2010
RF signal cable Worken	8D-FB	Cable-HYCH9-01	Aug. 17, 2009	Aug. 16, 2010
Software	ADT_Radiated_ V7.6.15.9.2	NA	NA	NA
Antenna Tower EMCO	2070/2080	512.835.4684	NA	NA
Turn Table EMCO	2087-2.03	NA	NA	NA
Antenna Tower & Turn Table Controller EMCO	2090	NA	NA	NA
26GHz ~ 40GHz Amplifier	EM26400	07026401	Aug. 27, 2009	Aug. 26, 2010

- NOTE:**
1. The calibration interval of the above test instruments is 12 months and the calibrations are traceable to NML/ROC and NIST/USA.
  2. The test was performed in HwaYa Chamber 9.
  3. The horn antenna and HP preamplifier (model: 8449B) are used only for the measurement of emission frequency above 1GHz if tested.
  4. The FCC Site Registration No. is 460141.
  5. The IC Site Registration No. is IC 7450F-4.



A D T

#### 4.1.4 TEST PROCEDURES

- a. The EUT was placed on the top of a rotating table 0.8 meters above the ground at a 3 meter semi-anechoic chamber. The table was rotated 360 degrees to determine the position of the highest radiation.
- b. The EUT was set 3 meters away from the interference-receiving antenna, which was mounted on the top of a variable-height antenna tower.
- c. The antenna is a broadband antenna, and its height is varied from one meter to four meters above the ground to determine the maximum value of the field strength. Both horizontal and vertical polarizations of the antenna are set to make the measurement.
- d. For each suspected emission, the EUT was arranged to its worst case and then the antenna was tuned to heights from 1 meter to 4 meters and the rotatable table was turned from 0 degrees to 360 degrees to find the maximum reading.
- e. The test-receiver system was set to Peak Detect Function and Specified Bandwidth with Maximum Hold Mode.
- f. If the emission level of the EUT in peak mode was 10dB lower than the limit specified, then testing could be stopped and the peak values of the EUT would be reported. Otherwise the emissions that did not have 10dB margin would be re-tested one by one using peak, quasi-peak or average method as specified and then reported in a data sheet.

**NOTE:**

1. The resolution bandwidth and video bandwidth of test receiver/spectrum analyzer is 120kHz for Peak detection (PK) and Quasi-peak detection (QP) at frequency below 1GHz.
2. The resolution bandwidth of test receiver/spectrum analyzer is 1MHz and video bandwidth is 3MHz for Peak detection at frequency above 1GHz.
3. The resolution bandwidth of test receiver/spectrum analyzer is 1MHz and the video bandwidth is 10Hz for Average detection (AV) at frequency above 1GHz.
4. All modes of operation were investigated and the worst-case emissions are reported.

#### 4.1.5 DEVIATION FROM TEST STANDARD

No deviation

#### 4.1.6 TEST SETUP

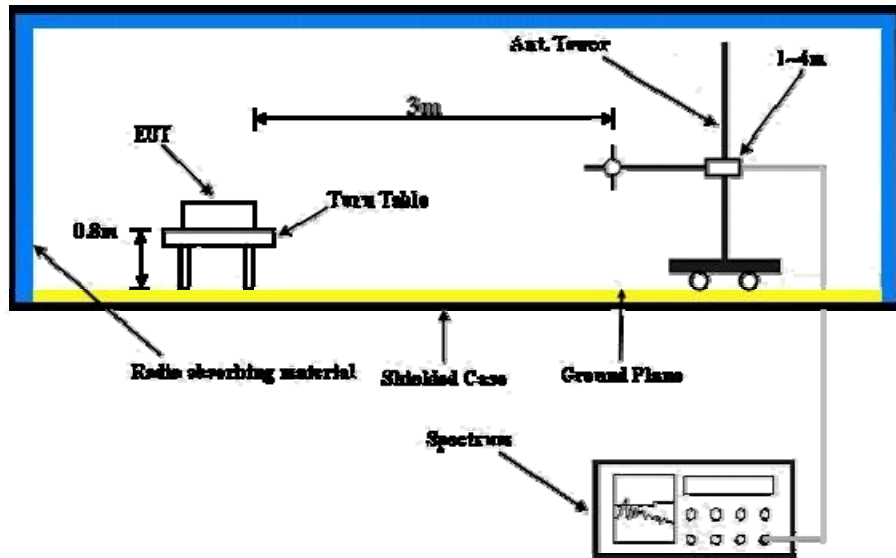

For the actual test configuration, please refer to the attached file (Test Setup Photo).

#### 4.1.7 EUT OPERATING CONDITION

- a. Placed the EUT on the testing table.
- b. Prepared notebook systems to act as a communication partner and placed them outside of testing area.
- c. The communication partners connected with EUT via a UTP cable and run a test program (provided by manufacturer) to enable EUT under transmission condition continuously at specific channel frequency.
- d. The communication partners sent data to EUT by command "PING".



#### 4.1.8 TEST RESULTS

##### 802.11a

EUT TEST CONDITION		MEASUREMENT DETAIL	
CHANNEL	Channel 36	FREQUENCY RANGE	1 ~ 40GHz
INPUT POWER (SYSTEM)	120Vac, 60 Hz	DETECTOR FUNCTION	Peak (PK) Average (AV)
ENVIRONMENTAL CONDITIONS	23deg. C, 65%RH 1020 hPa	TESTED BY	Dean Wang

ANTENNA POLARITY & TEST DISTANCE: HORIZONTAL AT 3 M								
NO.	FREQ. (MHz)	EMISSION LEVEL (dBuV/m)	LIMIT (dBuV/m)	MARGIN (dB)	ANTENNA HEIGHT (m)	TABLE ANGLE (Degree)	RAW VALUE (dBuV)	CORRECTION FACTOR (dB/m)
1	5150.00	50.4 PK	74.0	-23.6	1.09 H	352	11.40	39.00
2	5150.00	36.9 AV	54.0	-17.1	1.09 H	352	-2.10	39.00
3	*5180.00	107.2 PK			1.02 H	153	68.20	39.00
4	*5180.00	97.1 AV			1.02 H	153	58.10	39.00
5	#6906.00	54.6 PK	68.3	-13.7	1.31 H	193	10.90	43.70
6	#10360.00	58.4 PK	68.3	-9.9	1.04 H	276	9.70	48.70
ANTENNA POLARITY & TEST DISTANCE: VERTICAL AT 3 M								
NO.	FREQ. (MHz)	EMISSION LEVEL (dBuV/m)	LIMIT (dBuV/m)	MARGIN (dB)	ANTENNA HEIGHT (m)	TABLE ANGLE (Degree)	RAW VALUE (dBuV)	CORRECTION FACTOR (dB/m)
1	5150.00	60.4 PK	74.0	-13.6	1.03 V	1	21.40	39.00
2	5150.00	41.5 AV	54.0	-12.5	1.03 V	1	2.50	39.00
3	*5180.00	111.0 PK			1.02 V	11	72.00	39.00
4	*5180.00	100.9 AV			1.02 V	11	61.90	39.00
5	#6906.00	57.5 PK	68.3	-10.8	1.02 V	128	13.80	43.70
6	#10360.00	62.5 PK	68.3	-5.8	1.54 V	20	13.80	48.70

- REMARKS:**
1. Emission level (dBuV/m) = Raw Value (dBuV) + Correction Factor (dB/m).
  2. Correction Factor (dB/m) = Antenna Factor (dB/m) + Cable Factor (dB).
  3. The other emission levels were very low against the limit.
  4. Margin value = Emission level – Limit value.
  5. “ \* “: Fundamental frequency.
  6. "#":The radiated frequency is out the restricted band.





A D T

EUT TEST CONDITION		MEASUREMENT DETAIL	
CHANNEL	Channel 40	FREQUENCY RANGE	1 ~ 40GHz
INPUT POWER (SYSTEM)	120Vac, 60 Hz	DETECTOR FUNCTION	Peak (PK) Average (AV)
ENVIRONMENTAL CONDITIONS	23deg. C, 65%RH 1020 hPa	TESTED BY	Dean Wang

ANTENNA POLARITY & TEST DISTANCE: HORIZONTAL AT 3 M								
NO.	FREQ. (MHz)	EMISSION LEVEL (dBuV/m)	LIMIT (dBuV/m)	MARGIN (dB)	ANTENNA HEIGHT (m)	TABLE ANGLE (Degree)	RAW VALUE (dBuV)	CORRECTION FACTOR (dB/m)
1	*5200.00	107.4 PK			1.05 H	149	68.40	39.00
2	*5200.00	97.3 AV			1.05 H	149	58.30	39.00
3	#6933.00	54.3 PK	68.3	-14.0	1.27 H	89	10.60	43.70
4	#10400.00	58.8 PK	68.3	-9.5	1.00 H	31	10.10	48.70
ANTENNA POLARITY & TEST DISTANCE: VERTICAL AT 3 M								
NO.	FREQ. (MHz)	EMISSION LEVEL (dBuV/m)	LIMIT (dBuV/m)	MARGIN (dB)	ANTENNA HEIGHT (m)	TABLE ANGLE (Degree)	RAW VALUE (dBuV)	CORRECTION FACTOR (dB/m)
1	*5200.00	111.2 PK			1.01 V	11	72.20	39.00
2	*5200.00	101.1 AV			1.01 V	11	62.10	39.00
3	#6933.00	57.4 PK	68.3	-10.9	1.60 V	97	13.70	43.70
4	#10400.00	62.8 PK	68.3	-5.5	1.31 V	21	14.10	48.70

- REMARKS:**
1. Emission level (dBuV/m) = Raw Value (dBuV) + Correction Factor (dB/m).
  2. Correction Factor (dB/m) = Antenna Factor (dB/m) + Cable Factor (dB).
  3. The other emission levels were very low against the limit.
  4. Margin value = Emission level – Limit value.
  5. “ \* “: Fundamental frequency.
  6. “#”:The radiated frequency is out the restricted band.



A D T

EUT TEST CONDITION		MEASUREMENT DETAIL	
CHANNEL	Channel 48	FREQUENCY RANGE	1 ~ 40GHz
INPUT POWER (SYSTEM)	120Vac, 60 Hz	DETECTOR FUNCTION	Peak (PK) Average (AV)
ENVIRONMENTAL CONDITIONS	23deg. C, 65%RH 1020 hPa	TESTED BY	Dean Wang

ANTENNA POLARITY & TEST DISTANCE: HORIZONTAL AT 3 M								
NO.	FREQ. (MHz)	EMISSION LEVEL (dBuV/m)	LIMIT (dBuV/m)	MARGIN (dB)	ANTENNA HEIGHT (m)	TABLE ANGLE (Degree)	RAW VALUE (dBuV)	CORRECTION FACTOR (dB/m)
1	*5240.00	107.6 PK			1.02 H	155	68.50	39.10
2	*5240.00	97.5 AV			1.02 H	155	58.40	39.10
3	5350.00	48.7 PK	74.0	-25.3	1.00 H	337	9.40	39.30
4	5350.00	36.8 AV	54.0	-17.2	1.00 H	337	-2.50	39.30
5	#6986.00	54.2 PK	68.3	-14.1	1.00 H	192	10.30	43.90
6	#10480.00	58.5 PK	68.3	-9.8	1.00 H	12	9.60	48.90
ANTENNA POLARITY & TEST DISTANCE: VERTICAL AT 3 M								
NO.	FREQ. (MHz)	EMISSION LEVEL (dBuV/m)	LIMIT (dBuV/m)	MARGIN (dB)	ANTENNA HEIGHT (m)	TABLE ANGLE (Degree)	RAW VALUE (dBuV)	CORRECTION FACTOR (dB/m)
1	*5240.00	111.1 PK			1.02 V	8	72.00	39.10
2	*5240.00	100.9 AV			1.02 V	8	61.80	39.10
3	5350.00	50.1 PK	74.0	-23.9	1.08 V	35	10.80	39.30
4	5350.00	37.3 AV	54.0	-16.7	1.08 V	35	-2.00	39.30
5	#6986.00	56.8 PK	68.3	-11.5	1.62 V	31	12.90	43.90
6	#10480.00	63.6 PK	68.3	-4.7	1.43 V	26	14.70	48.90

- REMARKS:**
1. Emission level (dBuV/m) = Raw Value (dBuV) + Correction Factor (dB/m).
  2. Correction Factor (dB/m) = Antenna Factor (dB/m) + Cable Factor (dB).
  3. The other emission levels were very low against the limit.
  4. Margin value = Emission level – Limit value.
  5. “ \* “: Fundamental frequency.
  6. “#“: The radiated frequency is out the restricted band.



A D T

802.11n (20MHz)

EUT TEST CONDITION		MEASUREMENT DETAIL	
CHANNEL	Channel 36	FREQUENCY RANGE	1 ~ 40GHz
INPUT POWER (SYSTEM)	120Vac, 60 Hz	DETECTOR FUNCTION	Peak (PK) Average (AV)
ENVIRONMENTAL CONDITIONS	23deg. C, 65%RH 1020 hPa	TESTED BY	Dean Wang

ANTENNA POLARITY & TEST DISTANCE: HORIZONTAL AT 3 M								
NO.	FREQ. (MHz)	EMISSION LEVEL (dBuV/m)	LIMIT (dBuV/m)	MARGIN (dB)	ANTENNA HEIGHT (m)	TABLE ANGLE (Degree)	RAW VALUE (dBuV)	CORRECTION FACTOR (dB/m)
1	5150.00	50.2 PK	74.0	-23.8	1.03 H	164	11.20	39.00
2	5150.00	36.6 AV	54.0	-17.4	1.03 H	164	-2.40	39.00
3	*5180.00	106.6 PK			1.01 H	162	67.60	39.00
4	*5180.00	96.1 AV			1.01 H	162	57.10	39.00
5	#6906.00	54.4 PK	68.3	-13.9	1.28 H	187	10.70	43.70
6	#10360.00	58.2 PK	68.3	-10.1	1.02 H	258	9.50	48.70
ANTENNA POLARITY & TEST DISTANCE: VERTICAL AT 3 M								
NO.	FREQ. (MHz)	EMISSION LEVEL (dBuV/m)	LIMIT (dBuV/m)	MARGIN (dB)	ANTENNA HEIGHT (m)	TABLE ANGLE (Degree)	RAW VALUE (dBuV)	CORRECTION FACTOR (dB/m)
1	5150.00	60.1 PK	74.0	-13.9	1.00 V	4	21.10	39.00
2	5150.00	41.2 AV	54.0	-12.8	1.00 V	4	2.20	39.00
3	*5180.00	110.3 PK			1.01 V	7	71.30	39.00
4	*5180.00	99.8 AV			1.01 V	7	60.80	39.00
5	#6906.00	57.4 PK	68.3	-10.9	1.00 V	132	13.70	43.70
6	#10360.00	62.2 PK	68.3	-6.1	1.28 V	11	13.50	48.70

- REMARKS:**
1. Emission level (dBuV/m) = Raw Value (dBuV) + Correction Factor (dB/m).
  2. Correction Factor (dB/m) = Antenna Factor (dB/m) + Cable Factor (dB).
  3. The other emission levels were very low against the limit.
  4. Margin value = Emission level – Limit value.
  5. “ \* “: Fundamental frequency.
  6. “#”:The radiated frequency is out the restricted band.



A D T

EUT TEST CONDITION		MEASUREMENT DETAIL	
CHANNEL	Channel 40	FREQUENCY RANGE	1 ~ 40GHz
INPUT POWER (SYSTEM)	120Vac, 60 Hz	DETECTOR FUNCTION	Peak (PK) Average (AV)
ENVIRONMENTAL CONDITIONS	23deg. C, 65%RH 1020 hPa	TESTED BY	Dean Wang

ANTENNA POLARITY & TEST DISTANCE: HORIZONTAL AT 3 M								
NO.	FREQ. (MHz)	EMISSION LEVEL (dBuV/m)	LIMIT (dBuV/m)	MARGIN (dB)	ANTENNA HEIGHT (m)	TABLE ANGLE (Degree)	RAW VALUE (dBuV)	CORRECTION FACTOR (dB/m)
1	*5200.00	106.8 PK			1.03 H	152	67.80	39.00
2	*5200.00	96.4 AV			1.03 H	152	57.40	39.00
3	#6933.00	54.2 PK	68.3	-14.1	1.21 H	93	10.50	43.70
4	#10400.00	58.6 PK	68.3	-9.7	1.00 H	28	9.90	48.70
ANTENNA POLARITY & TEST DISTANCE: VERTICAL AT 3 M								
NO.	FREQ. (MHz)	EMISSION LEVEL (dBuV/m)	LIMIT (dBuV/m)	MARGIN (dB)	ANTENNA HEIGHT (m)	TABLE ANGLE (Degree)	RAW VALUE (dBuV)	CORRECTION FACTOR (dB/m)
1	*5200.00	110.7 PK			1.02 V	13	71.70	39.00
2	*5200.00	100.2 AV			1.02 V	13	61.20	39.00
3	#6933.00	57.2 PK	68.3	-11.1	1.57 V	102	13.50	43.70
4	#10400.00	62.5 PK	68.3	-5.8	1.28 V	16	13.80	48.70

- REMARKS:**
1. Emission level (dBuV/m) = Raw Value (dBuV) + Correction Factor (dB/m).
  2. Correction Factor (dB/m) = Antenna Factor (dB/m) + Cable Factor (dB).
  3. The other emission levels were very low against the limit.
  4. Margin value = Emission level – Limit value.
  5. “ \* “: Fundamental frequency.
  6. “#”:The radiated frequency is out the restricted band.



A D T

EUT TEST CONDITION		MEASUREMENT DETAIL	
CHANNEL	Channel 48	FREQUENCY RANGE	1 ~ 40GHz
INPUT POWER (SYSTEM)	120Vac, 60 Hz	DETECTOR FUNCTION	Peak (PK) Average (AV)
ENVIRONMENTAL CONDITIONS	23deg. C, 65%RH 1020 hPa	TESTED BY	Dean Wang

ANTENNA POLARITY & TEST DISTANCE: HORIZONTAL AT 3 M								
NO.	FREQ. (MHz)	EMISSION LEVEL (dBuV/m)	LIMIT (dBuV/m)	MARGIN (dB)	ANTENNA HEIGHT (m)	TABLE ANGLE (Degree)	RAW VALUE (dBuV)	CORRECTION FACTOR (dB/m)
1	*5240.00	106.9 PK			1.01 H	153	67.80	39.10
2	*5240.00	96.4 AV			1.01 H	153	57.30	39.10
3	5350.00	48.6 PK	74.0	-25.4	1.00 H	167	9.30	39.30
4	5350.00	36.7 AV	54.0	-17.3	1.00 H	167	-2.60	39.30
5	#6986.00	54.0 PK	68.3	-14.3	1.00 H	189	10.10	43.90
6	#10480.00	58.4 PK	68.3	-9.9	1.00 H	18	9.50	48.90
ANTENNA POLARITY & TEST DISTANCE: VERTICAL AT 3 M								
NO.	FREQ. (MHz)	EMISSION LEVEL (dBuV/m)	LIMIT (dBuV/m)	MARGIN (dB)	ANTENNA HEIGHT (m)	TABLE ANGLE (Degree)	RAW VALUE (dBuV)	CORRECTION FACTOR (dB/m)
1	*5240.00	110.6 PK			1.03 V	5	71.50	39.10
2	*5240.00	100.1 AV			1.03 V	5	61.00	39.10
3	5350.00	49.9 PK	74.0	-24.1	1.02 V	27	10.60	39.30
4	5350.00	37.2 AV	54.0	-16.8	1.02 V	27	-2.10	39.30
5	#6986.00	56.5 PK	68.3	-11.8	1.58 V	25	12.60	43.90
6	#10480.00	63.4 PK	68.3	-4.9	1.37 V	21	14.50	48.90

- REMARKS:**
1. Emission level (dBuV/m) = Raw Value (dBuV) + Correction Factor (dB/m).
  2. Correction Factor (dB/m) = Antenna Factor (dB/m) + Cable Factor (dB).
  3. The other emission levels were very low against the limit.
  4. Margin value = Emission level – Limit value.
  5. “ \* “: Fundamental frequency.
  6. “#“: The radiated frequency is out the restricted band.



A D T

802.11n (40MHz)

EUT TEST CONDITION		MEASUREMENT DETAIL	
CHANNEL	Channel 38	FREQUENCY RANGE	1 ~ 40GHz
INPUT POWER (SYSTEM)	120Vac, 60 Hz	DETECTOR FUNCTION	Peak (PK) Average (AV)
ENVIRONMENTAL CONDITIONS	23deg. C, 65%RH 1020 hPa	TESTED BY	Dean Wang

ANTENNA POLARITY & TEST DISTANCE: HORIZONTAL AT 3 M								
NO.	FREQ. (MHz)	EMISSION LEVEL (dBuV/m)	LIMIT (dBuV/m)	MARGIN (dB)	ANTENNA HEIGHT (m)	TABLE ANGLE (Degree)	RAW VALUE (dBuV)	CORRECTION FACTOR (dB/m)
1	5150.00	60.1 PK	74.0	-13.9	1.05 H	343	21.10	39.00
2	5150.00	42.6 AV	54.0	-11.4	1.05 H	343	3.60	39.00
3	*5190.00	104.4 PK			1.03 H	166	65.40	39.00
4	*5190.00	94.3 AV			1.03 H	166	55.30	39.00
5	#6906.00	54.2 PK	68.3	-14.1	1.27 H	186	10.50	43.70
6	#10360.00	58.2 PK	68.3	-10.1	1.00 H	237	9.50	48.70
ANTENNA POLARITY & TEST DISTANCE: VERTICAL AT 3 M								
NO.	FREQ. (MHz)	EMISSION LEVEL (dBuV/m)	LIMIT (dBuV/m)	MARGIN (dB)	ANTENNA HEIGHT (m)	TABLE ANGLE (Degree)	RAW VALUE (dBuV)	CORRECTION FACTOR (dB/m)
1	5150.00	68.5 PK	74.0	-5.5	1.03 V	32	29.50	39.00
2	5150.00	47.8 AV	54.0	-6.2	1.03 V	32	8.80	39.00
3	*5190.00	108.3 PK			1.03 V	7	69.30	39.00
4	*5190.00	98.2 AV			1.03 V	7	59.20	39.00
5	#6920.00	57.9 PK	68.3	-10.4	1.85 V	181	14.20	43.70
6	#10380.00	60.5 PK	68.3	-7.8	1.43 V	22	11.80	48.70

- REMARKS:**
1. Emission level (dBuV/m) = Raw Value (dBuV) + Correction Factor (dB/m).
  2. Correction Factor (dB/m) = Antenna Factor (dB/m) + Cable Factor (dB).
  3. The other emission levels were very low against the limit.
  4. Margin value = Emission level – Limit value.
  5. “ \* “: Fundamental frequency.
  6. “#”:The radiated frequency is out the restricted band.



A D T

EUT TEST CONDITION		MEASUREMENT DETAIL	
CHANNEL	Channel 46	FREQUENCY RANGE	1 ~ 40GHz
INPUT POWER (SYSTEM)	120Vac, 60 Hz	DETECTOR FUNCTION	Peak (PK) Average (AV)
ENVIRONMENTAL CONDITIONS	23deg. C, 65%RH 1020 hPa	TESTED BY	Dean Wang

ANTENNA POLARITY & TEST DISTANCE: HORIZONTAL AT 3 M								
NO.	FREQ. (MHz)	EMISSION LEVEL (dBuV/m)	LIMIT (dBuV/m)	MARGIN (dB)	ANTENNA HEIGHT (m)	TABLE ANGLE (Degree)	RAW VALUE (dBuV)	CORRECTION FACTOR (dB/m)
1	*5230.00	104.5 PK			1.01 H	155	65.40	39.10
2	*5230.00	94.3 AV			1.01 H	155	55.20	39.10
3	5350.00	52.9 PK	74.0	-21.1	1.02 H	149	13.60	39.30
4	5350.00	40.1 AV	54.0	-13.9	1.02 H	149	0.80	39.30
5	#6973.00	54.5 PK	68.3	-13.8	1.00 H	183	10.60	43.90
6	#10480.00	58.3 PK	68.3	-10.0	1.00 H	205	9.40	48.90
ANTENNA POLARITY & TEST DISTANCE: VERTICAL AT 3 M								
NO.	FREQ. (MHz)	EMISSION LEVEL (dBuV/m)	LIMIT (dBuV/m)	MARGIN (dB)	ANTENNA HEIGHT (m)	TABLE ANGLE (Degree)	RAW VALUE (dBuV)	CORRECTION FACTOR (dB/m)
1	*5230.00	108.2 PK			1.01 V	28	69.10	39.10
2	*5230.00	98.1 AV			1.01 V	28	59.00	39.10
3	5350.00	57.3 PK	74.0	-16.7	1.02 V	34	18.00	39.30
4	5350.00	44.2 AV	54.0	-9.8	1.02 V	34	4.90	39.30
5	#6973.00	57.1 PK	68.3	-11.2	1.51 V	34	13.20	43.90
6	#10460.00	61.7 PK	68.3	-6.6	1.35 V	39	12.80	48.90

- REMARKS:**
1. Emission level (dBuV/m) = Raw Value (dBuV) + Correction Factor (dB/m).
  2. Correction Factor (dB/m) = Antenna Factor (dB/m) + Cable Factor (dB).
  3. The other emission levels were very low against the limit.
  4. Margin value = Emission level – Limit value.
  5. “ \* “: Fundamental frequency.
  6. “#”:The radiated frequency is out the restricted band.



**A D T**

**BELOW 1GHz WORST-CASE DATA : 802.11a**

EUT TEST CONDITION		MEASUREMENT DETAIL	
CHANNEL	Channel 40	FREQUENCY RANGE	Below 1000MHz
INPUT POWER (SYSTEM)	120Vac, 60 Hz	DETECTOR FUNCTION	Quasi-Peak
ENVIRONMENTAL CONDITIONS	25deg. C, 65%RH 1020 hPa	TESTED BY	Brad Wu

ANTENNA POLARITY & TEST DISTANCE: HORIZONTAL AT 3 M								
NO.	FREQ. (MHz)	EMISSION LEVEL (dBuV/m)	LIMIT (dBuV/m)	MARGIN (dB)	ANTENNA HEIGHT (m)	TABLE ANGLE (Degree)	RAW VALUE (dBuV)	CORRECTION FACTOR (dB/m)
1	162.11	39.0 QP	43.5	-4.5	2.00 H	70	24.80	14.20
2	247.66	40.4 QP	46.0	-5.6	1.00 H	268	26.70	13.70
3	263.21	40.1 QP	46.0	-5.9	1.00 H	274	26.30	13.80
4	<b>527.09</b>	<b>43.3 QP</b>	<b>46.0</b>	<b>-2.7</b>	<b>1.48 H</b>	<b>175</b>	<b>22.30</b>	<b>21.00</b>
5	624.85	43.1 QP	46.0	-2.9	1.00 H	28	20.00	23.10
6	875.67	41.9 QP	46.0	-4.1	2.00 H	10	14.40	27.50
ANTENNA POLARITY & TEST DISTANCE: VERTICAL AT 3 M								
NO.	FREQ. (MHz)	EMISSION LEVEL (dBuV/m)	LIMIT (dBuV/m)	MARGIN (dB)	ANTENNA HEIGHT (m)	TABLE ANGLE (Degree)	RAW VALUE (dBuV)	CORRECTION FACTOR (dB/m)
1	125.17	37.7 QP	43.5	-5.8	1.00 V	337	25.90	11.80
2	152.39	37.7 QP	43.5	-5.8	1.00 V	94	23.60	14.10
3	259.33	39.5 QP	46.0	-6.5	2.00 V	133	25.60	13.90
4	517.92	39.2 QP	46.0	-6.8	2.00 V	124	18.30	20.90
5	624.85	40.1 QP	46.0	-5.9	2.00 V	334	17.00	23.10
6	875.67	41.2 QP	46.0	-4.8	1.50 V	343	13.70	27.50

- REMARKS:**
1. Emission level (dBuV/m) = Raw Value (dBuV) + Correction Factor (dB/m).
  2. Correction Factor (dB/m) = Antenna Factor (dB/m) + Cable Factor (dB).
  3. The other emission levels were very low against the limit.
  4. Margin value = Emission level – Limit value.





A D T

## 4.2 CONDUCTED EMISSION MEASUREMENT

### 4.2.1 LIMITS OF CONDUCTED EMISSION MEASUREMENT

FREQUENCY OF EMISSION (MHz)	CONDUCTED LIMIT (dB $\mu$ V)	
	Quasi-peak	Average
0.15 ~ 0.5	66 to 56	56 to 46
0.5 ~ 5	56	46
5 ~ 30	60	50

- NOTE:** 1. The lower limit shall apply at the transition frequencies.  
2. The limit decreases in line with the logarithm of the frequency in the range of 0.15 to 0.50MHz.  
3. All emanations from a class A/B digital device or system, including any network of conductors and apparatus connected thereto, shall not exceed the level of field strengths specified above.

### 4.2.2 TEST INSTRUMENTS

DESCRIPTION & MANUFACTURER	MODEL NO.	SERIAL NO.	DATE OF CALIBRATION	DUE DATE OF CALIBRATION
Test Receiver ROHDE & SCHWARZ	ESCS30	100288	Sep. 24, 2009	Sep. 23, 2010
RF signal cable Woken	5D-FB	Cable-HYCO2-01	Dec. 31, 2009	Dec. 30, 2010
LISN ROHDE & SCHWARZ	ESH2-Z5	100100	Aug. 24, 2009	Aug. 23, 2010
LISN ROHDE & SCHWARZ	ESH3-Z5	100311	Jul. 29, 2009	Jul. 28, 2010
Software ADT	ADT_Cond_ V7.3.7	NA	NA	NA

- NOTE:** 1. The calibration interval of the above test instruments is 12 months and the calibrations are traceable to NML/ROC and NIST/USA.  
2. The test was performed in HwaYa Shielded Room 2.  
3. The VCCI Site Registration No. is C-2047.



A D T

#### 4.2.3 TEST PROCEDURES

- a. The EUT was placed 0.4 meters from the conducting wall of the shielded room with EUT being connected to the power mains through a line impedance stabilization network (LISN). Other support units were connected to the power mains through another LISN. The two LISNs provide 50 ohm/ 50uH of coupling impedance for the measuring instrument.
- b. Both lines of the power mains connected to the EUT were checked for maximum conducted interference.
- c. The frequency range from 150kHz to 30MHz was searched. Emission levels under (Limit - 20dB) was not recorded.

#### 4.2.4 DEVIATION FROM TEST STANDARD

No deviation

#### 4.2.5 TEST SETUP

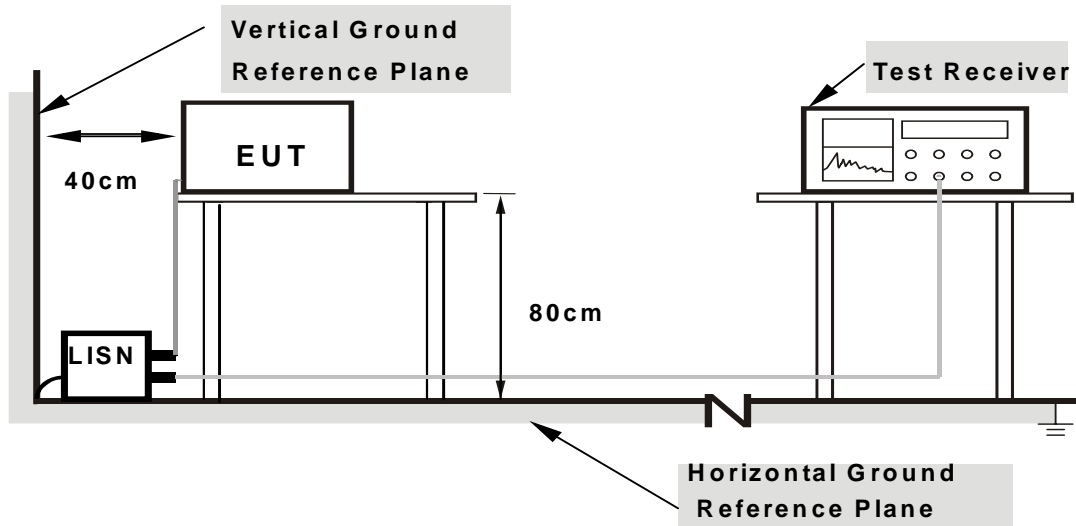

**Note: 1. Support units were connected to second LISN.**

**2. Both of LISNs (AMN) are 80 cm from EUT and at least 80 from other units and other metal planes**

For the actual test configuration, please refer to the attached file (Test Setup Photo).

#### 4.2.6 EUT OPERATING CONDITIONS

Same as 4.1.6.

### 4.2.7 TEST RESULTS

**CONDUCTED WORST-CASE DATA : 802.11a**

<b>PHASE</b>	Line 1	<b>6dB BANDWIDTH</b>	9kHz
--------------	--------	----------------------	------

No	Freq. [MHz]	Corr. Factor [dB]	Reading Value		Emission Level		Limit		Margin	
			[dB (uV)]		[dB (uV)]		[dB (uV)]		(dB)	
			Q.P.	AV.	Q.P.	AV.	Q.P.	AV.	Q.P.	AV.
1	0.185	0.16	38.96	-	39.12	-	64.25	54.25	-25.13	-
2	0.455	0.18	33.71	-	33.89	-	56.79	46.79	-22.89	-
3	0.908	0.22	34.94	-	35.16	-	56.00	46.00	-20.84	-
<b>4</b>	<b>3.813</b>	<b>0.35</b>	<b>35.94</b>	-	<b>36.29</b>	-	<b>56.00</b>	<b>46.00</b>	<b>-19.71</b>	-
5	4.355	0.35	34.19	-	34.54	-	56.00	46.00	-21.46	-
6	12.734	0.43	37.20	-	37.63	-	60.00	50.00	-22.37	-

- REMARKS:**
1. Q.P. and AV. are abbreviations of quasi-peak and average individually.
  2. "-": The Quasi-peak reading value also meets average limit and measurement with the average detector is unnecessary.
  3. The emission levels of other frequencies were very low against the limit.
  4. Margin value = Emission level - Limit value
  5. Correction factor = Insertion loss + Cable loss
  6. Emission Level = Correction Factor + Reading Value.

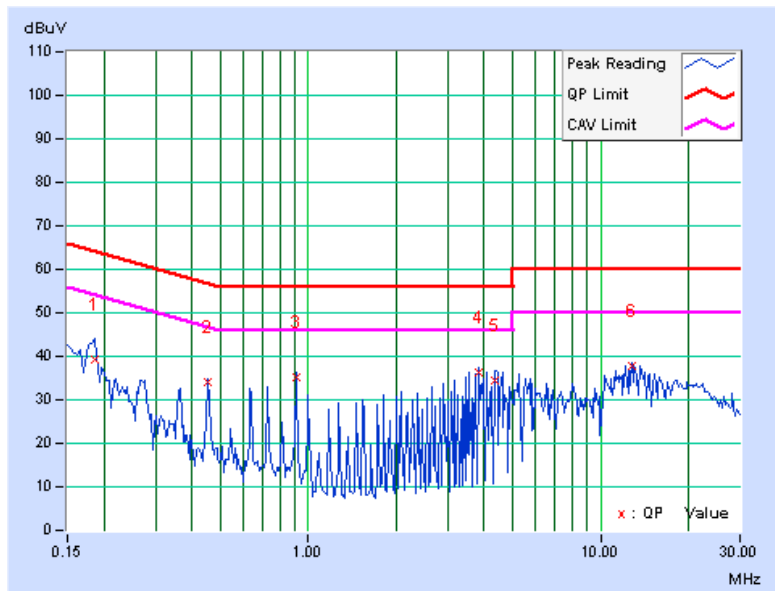

PHASE	Line 2	6dB BANDWIDTH	9kHz
-------	--------	---------------	------

No	Freq. [MHz]	Corr. Factor (dB)	Reading Value		Emission Level		Limit		Margin	
			[dB (uV)]		[dB (uV)]		[dB (uV)]		(dB)	
			Q.P.	AV.	Q.P.	AV.	Q.P.	AV.	Q.P.	AV.
1	0.185	0.13	39.14	-	39.27	-	64.25	54.25	-24.98	-
2	0.455	0.17	30.54	-	30.71	-	56.79	46.79	-26.08	-
3	0.908	0.21	29.30	-	29.51	-	56.00	46.00	-26.49	-
4	3.813	0.35	35.86	-	36.21	-	56.00	46.00	-19.79	-
5	4.355	0.36	35.32	-	35.68	-	56.00	46.00	-20.32	-
6	12.719	0.56	37.28	-	37.84	-	60.00	50.00	-22.16	-

- REMARKS:**
1. Q.P. and AV. are abbreviations of quasi-peak and average individually.
  2. "-": The Quasi-peak reading value also meets average limit and measurement with the average detector is unnecessary.
  3. The emission levels of other frequencies were very low against the limit.
  4. Margin value = Emission level - Limit value
  5. Correction factor = Insertion loss + Cable loss
  6. Emission Level = Correction Factor + Reading Value.

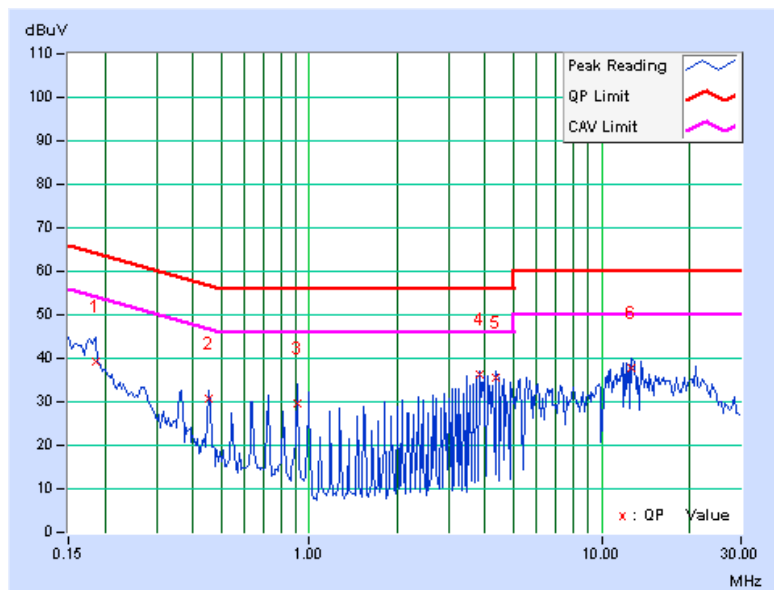



### 4.3 MAXIMUM CONDUCTED OUTPUT POWER MEASUREMENT

#### 4.3.1 LIMITS OF MAXIMUM CONDUCTED OUTPUT POWER MEASUREMENT

FREQUENCY BAND	LIMIT
5.15 ~ 5.25GHz	The lesser of 50mW (17dBm) or 4dBm + 10logB

**NOTE:** Where B is the 26dB emission bandwidth in MHz.

#### 4.3.2 TEST INSTRUMENTS

##### FOR POWER OUTPUT MEASUREMENT

DESCRIPTION & MANUFACTURER	MODEL NO.	SERIAL NO.	DATE OF CALIBRATION	CALIBRATED UNTIL
High Speed Peak Power Meter	ML2495A	0824012	Aug. 10, 2009	Aug. 09, 2010
Power Sensor	MA2411B	0738138	Aug. 10, 2009	Aug. 09, 2010

**Note:**

1. The calibration interval of the above test instruments is 12 months and the calibrations are traceable to NML/ROC and NIST/USA.
2. Measurement Bandwidth of ML2495A is 65MHz greater than 26dB bandwidth of emission.

##### FOR 26dB OCCUPIED BANDWIDTH

DESCRIPTION & MANUFACTURER	MODEL NO.	SERIAL NO.	DATE OF CALIBRATION	DUE DATE OF CALIBRATION
R&S SPECTRUM ANALYZER	FSP40	100040	Jul. 07, 2009	Jul. 06, 2010

**NOTE:** The calibration interval of the above test instruments is 12 months and the calibrations are traceable to NML/ROC and NIST/USA.

### 4.3.3 TEST PROCEDURE

#### FOR POWER OUTPUT MEASUREMENT

A power sensor was used on the output port of the EUT. A power meter was used to read the response of the power sensor. Record the power level.

#### FOR 26dB OCCUPIED BANDWIDTH

The transmitter output was connected to the spectrum analyzer through an attenuator. The bandwidth of the fundamental frequency was measured by spectrum analyzer with 300kHz RBW and 1MHz VBW. The 26dB bandwidth is defined as the total spectrum the power of which is higher than peak power minus 26dB.

### 4.3.4 DEVIATION FROM TEST STANDARD

No deviation

### 4.3.5 TEST SETUP

#### FOR POWER OUTPUT MEASUREMENT

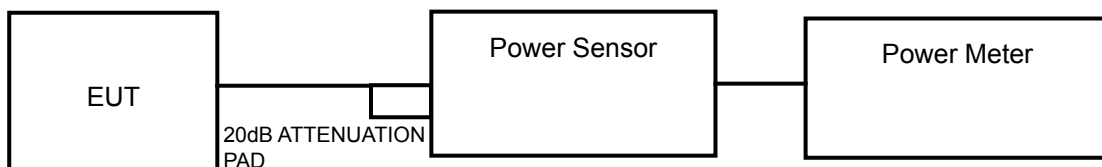

#### FOR 26dB OCCUPIED BANDWIDTH

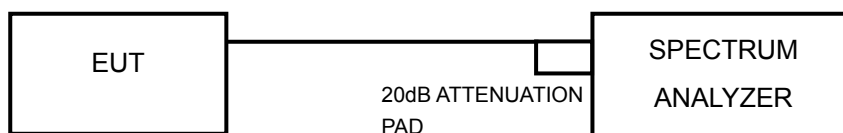

### 4.3.6 EUT OPERATING CONDITIONS

The software provided by client to enable the EUT under transmission condition continuously at specific channel frequencies individually.

### 4.3.7 TEST RESULTS

#### POWER OUTPUT: 802.11a

CHAN.	CHAN. FREQ. (MHz)	POWER OUTPUT (dBm)			TOTAL POWER (mW)	TOTAL POWER (dBm)	POWER LIMIT (dBm)	PASS / FAIL
		CHAIN 0	CHAIN 1	CHAIN 2				
36	5180	12.2	12.4	11.5	48.1	16.8	17	PASS
40	5200	12.1	12.2	12.0	48.7	16.9	17	PASS
48	5240	12.5	11.7	11.6	47.0	16.7	17	PASS

#### 802.11n (20MHz)

CHAN.	CHAN. FREQ. (MHz)	POWER OUTPUT (dBm)			TOTAL POWER (mW)	TOTAL POWER (dBm)	POWER LIMIT (dBm)	PASS / FAIL
		CHAIN 0	CHAIN 1	CHAIN 2				
36	5180	12.4	12.1	11.6	48.1	16.8	17	PASS
40	5200	11.8	12.2	11.6	46.2	16.6	17	PASS
48	5240	12.5	12.0	11.7	48.4	16.9	17	PASS

#### 802.11n (40MHz)

CHAN.	CHAN. FREQ. (MHz)	POWER OUTPUT (dBm)			TOTAL POWER (mW)	TOTAL POWER (dBm)	POWER LIMIT (dBm)	PASS / FAIL
		CHAIN 0	CHAIN 1	CHAIN 2				
38	5190	11.9	12.2	12.1	48.3	16.8	17	PASS
46	5230	12.1	12.2	11.6	47.3	16.7	17	PASS





A D T

### 26dB OCCUPIED BANDWIDTH: 802.11a

CHANNEL	CHANNEL FREQUENCY (MHz)	26dBc OCCUPIED BANDWIDTH (MHz)			PASS / FAIL
		CHAIN 0	CHAIN 1	CHAIN 2	
36	5180	23.64	22.83	23.49	PASS
40	5200	23.81	23.56	23.64	PASS
48	5240	23.72	23.86	23.85	PASS

### FOR CHAIN 1: CH 48

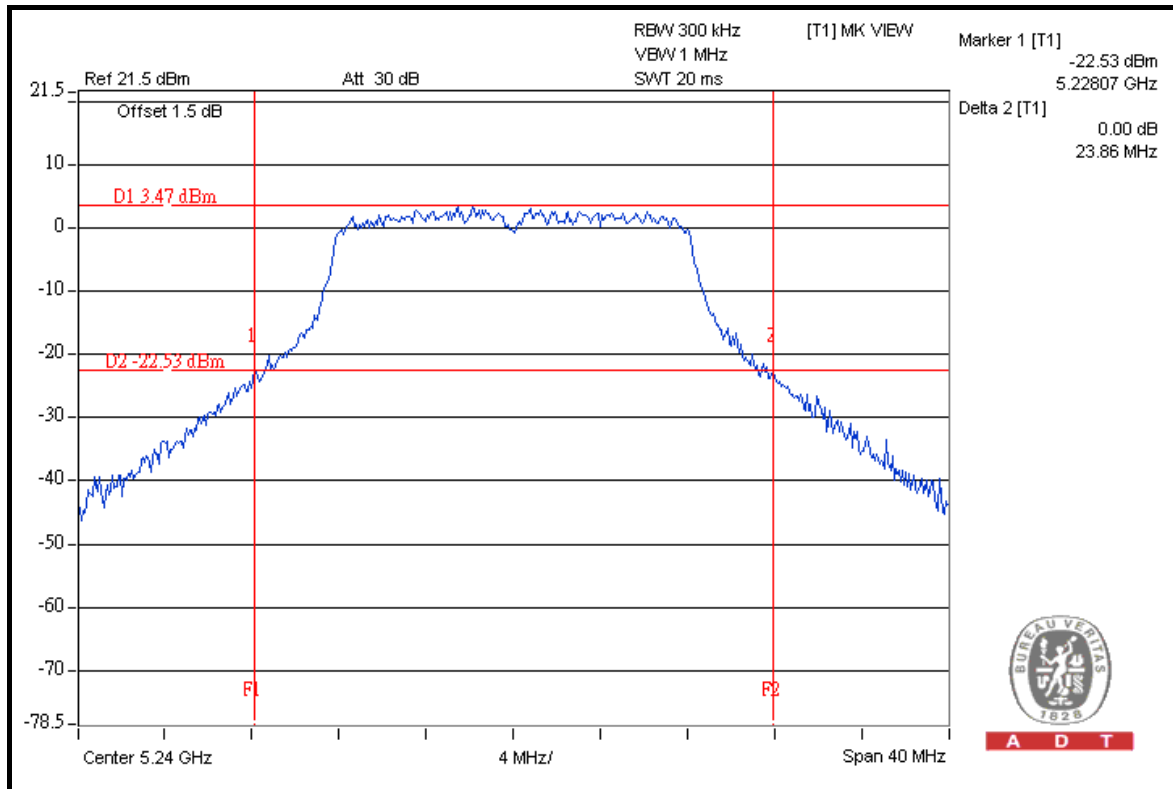



A D T

**DRAFT 802.11n (20MHz)**

CHANNEL	CHANNEL FREQUENCY (MHz)	26dBc OCCUPIED BANDWIDTH (MHz)			PASS / FAIL
		CHAIN 0	CHAIN 1	CHAIN 2	
36	5180	24.81	24.40	25.16	PASS
40	5200	24.57	23.99	25.08	PASS
48	5240	24.88	24.94	24.93	PASS

**FOR CHAIN 2: CH 36**

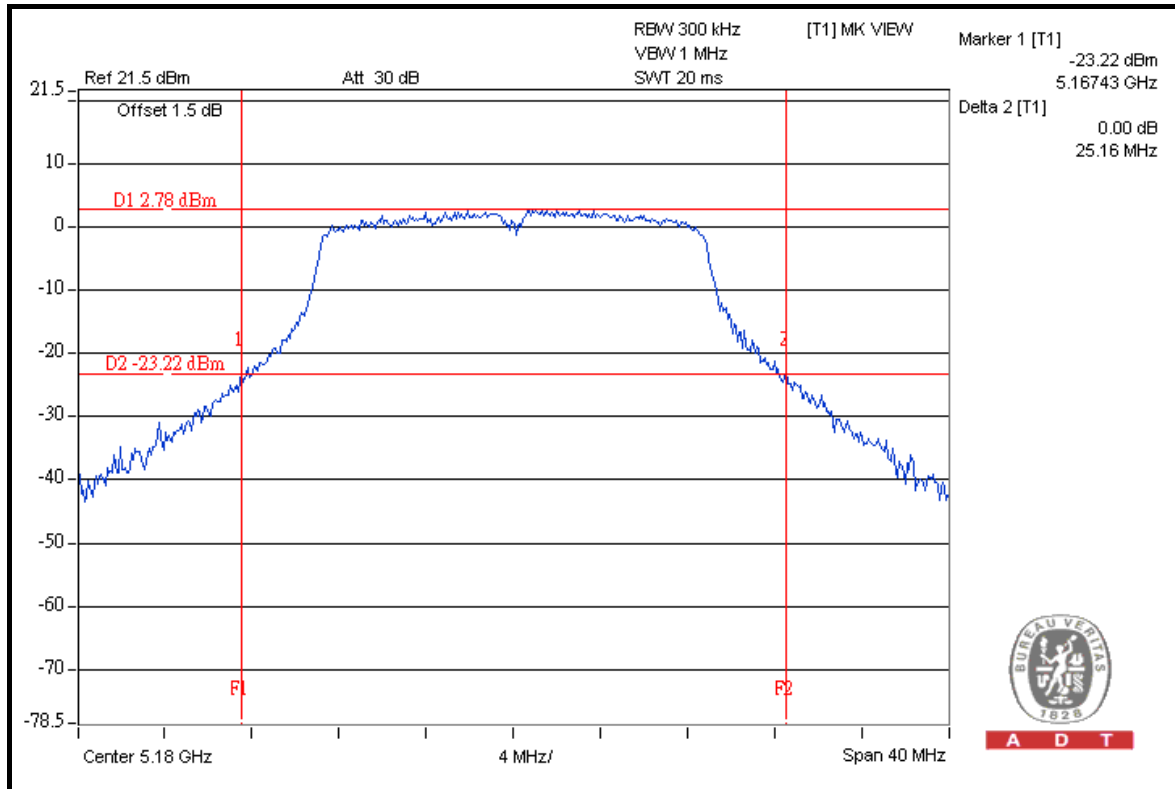



A D T

### 802.11n (40MHz)

CHANNEL	CHANNEL FREQUENCY (MHz)	26dBc OCCUPIED BANDWIDTH (MHz)			PASS / FAIL
		CHAIN 0	CHAIN 1	CHAIN 2	
38	5190	46.58	45.27	45.79	PASS
46	5230	45.93	45.42	45.87	PASS

### FOR CHAIN 0: CH 38

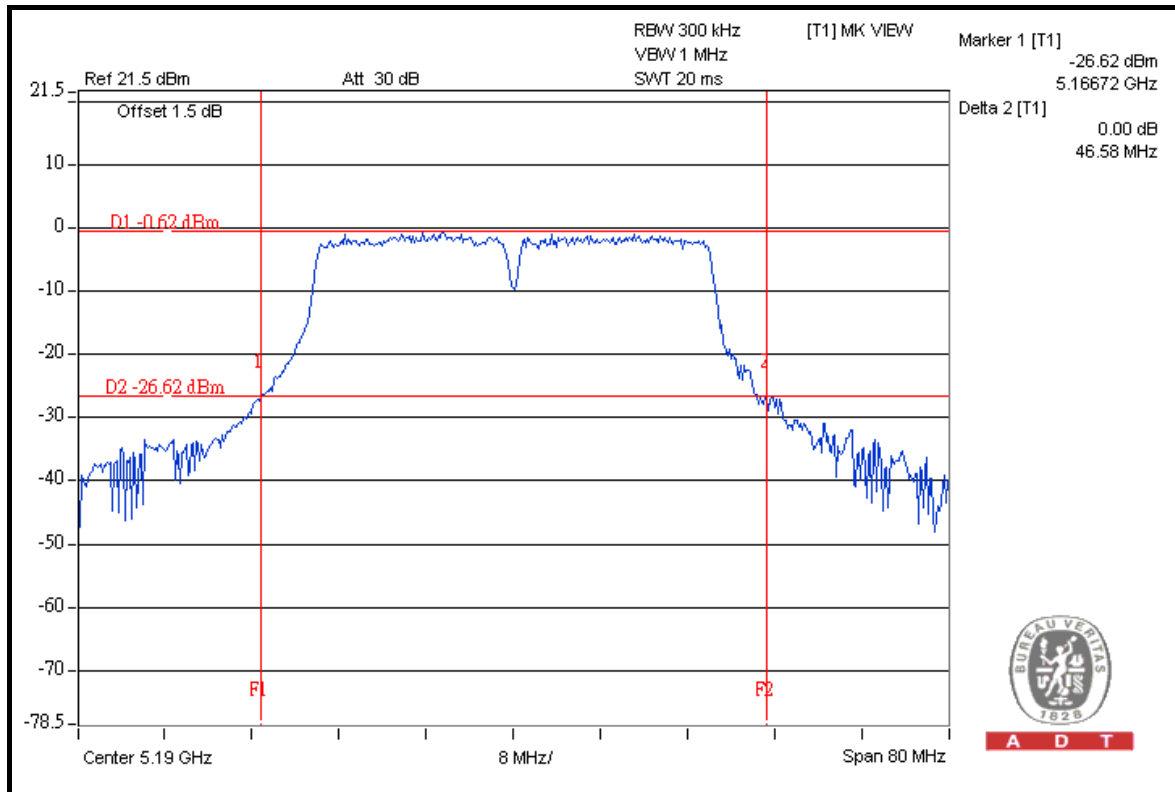



A D T

#### 4.4 PEAK POWER EXCURSION MEASUREMENT

##### 4.4.1 LIMITS OF PEAK POWER EXCURSION MEASUREMENT

FREQUENCY BAND	LIMIT
5.15 ~ 5.25GHz	13dB

##### 4.4.2 TEST INSTRUMENTS

DESCRIPTION & MANUFACTURER	MODEL NO.	SERIAL NO.	DATE OF CALIBRATION	DUE DATE OF CALIBRATION
R&S SPECTRUM ANALYZER	FSP40	100040	Jul. 07, 2009	Jul. 06, 2010

**NOTE:** The calibration interval of the above test instruments is 12 months and the calibrations are traceable to NML/ROC and NIST/USA.

##### 4.4.3 TEST PROCEDURE

- a. The transmitter output was connected to the spectrum analyzer.
- b. Set the spectrum bandwidth span to view the entire spectrum.
- c. Using peak detector and Max-hold function for Trace 1 (RB = 1MHz, VB = 3MHz) and 2 (RB = 1MHz, VB = 300kHz).
- d. The differences between Trace1 and Trace 2 in any 1MHz band at f1 to f2 range were recorded and showed to another trace.

#### 4.4.4 DEVIATION FROM TEST STANDARD

No deviation

#### 4.4.5 TEST SETUP



#### 4.4.6 EUT OPERATING CONDITIONS

The software provided by client to enable the EUT under transmission condition continuously at specific channel frequencies individually.



A D T

#### 4.4.7 TEST RESULTS

##### 802.11a

CHANNEL	CHANNEL FREQUENCY (MHz)	PEAK POWER EXCURSION (dB)			PEAK to AVERAGE EXCURSION LIMIT (dB)	PASS/FAIL
		CHAIN 0	CHAIN 1	CHAIN 2		
36	5180	8.69	8.11	10.00	13	PASS
40	5200	9.64	9.46	8.60	13	PASS
48	5240	9.71	9.08	9.73	13	PASS



A D T

### FOR CHAIN 2: CH 36

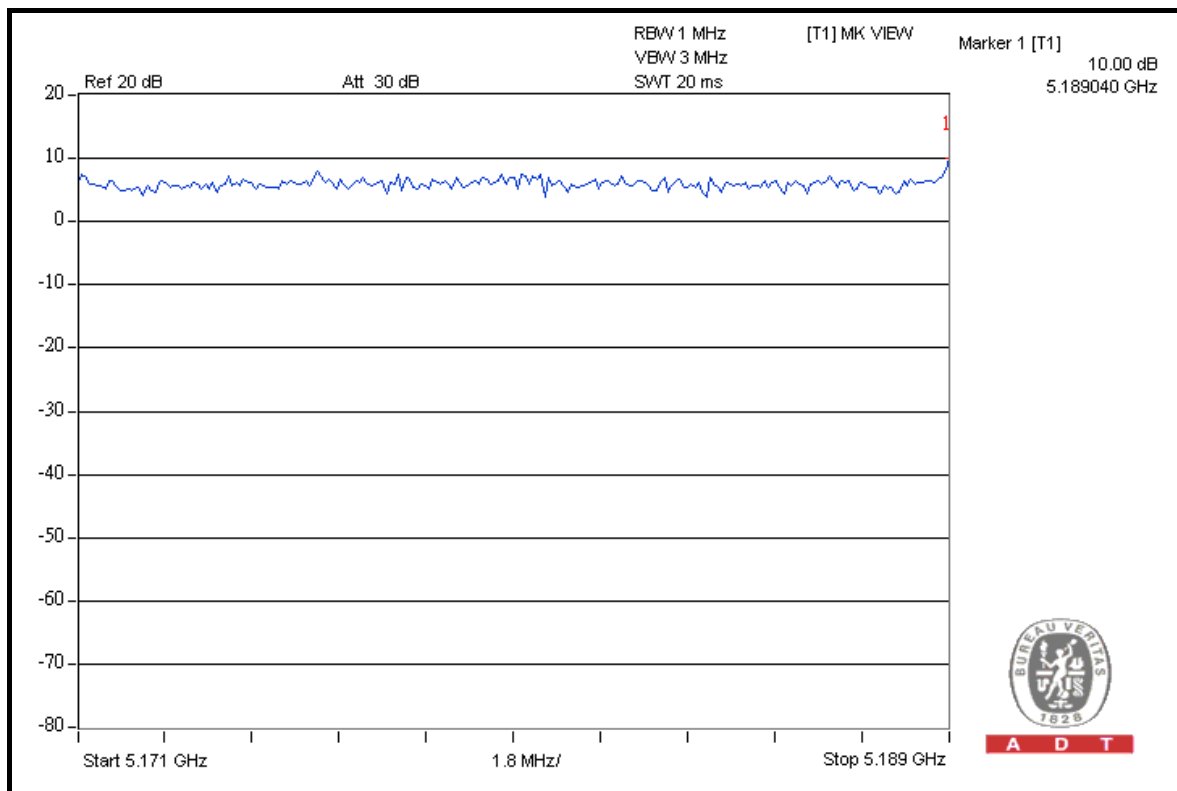
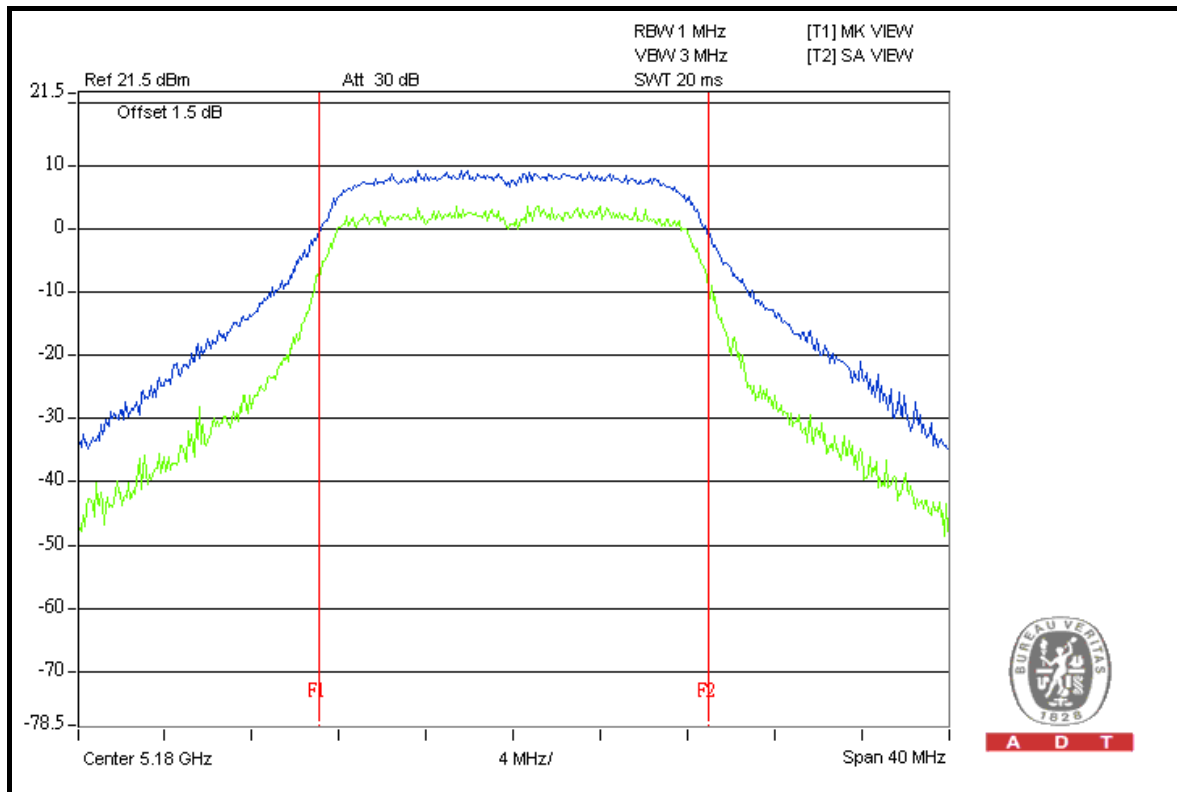



A D T

802.11n (20MHz)

CHANNEL	CHANNEL FREQUENCY (MHz)	PEAK POWER EXCURSION (dB)			PEAK to AVERAGE EXCURSION LIMIT (dB)	PASS/FAIL
		CHAIN 0	CHAIN 1	CHAIN 2		
36	5180	7.64	7.65	7.90	13	PASS
40	5200	7.68	8.26	7.53	13	PASS
48	5240	8.10	7.90	7.63	13	PASS





A D T

### FOR CHAIN 1: CH 40

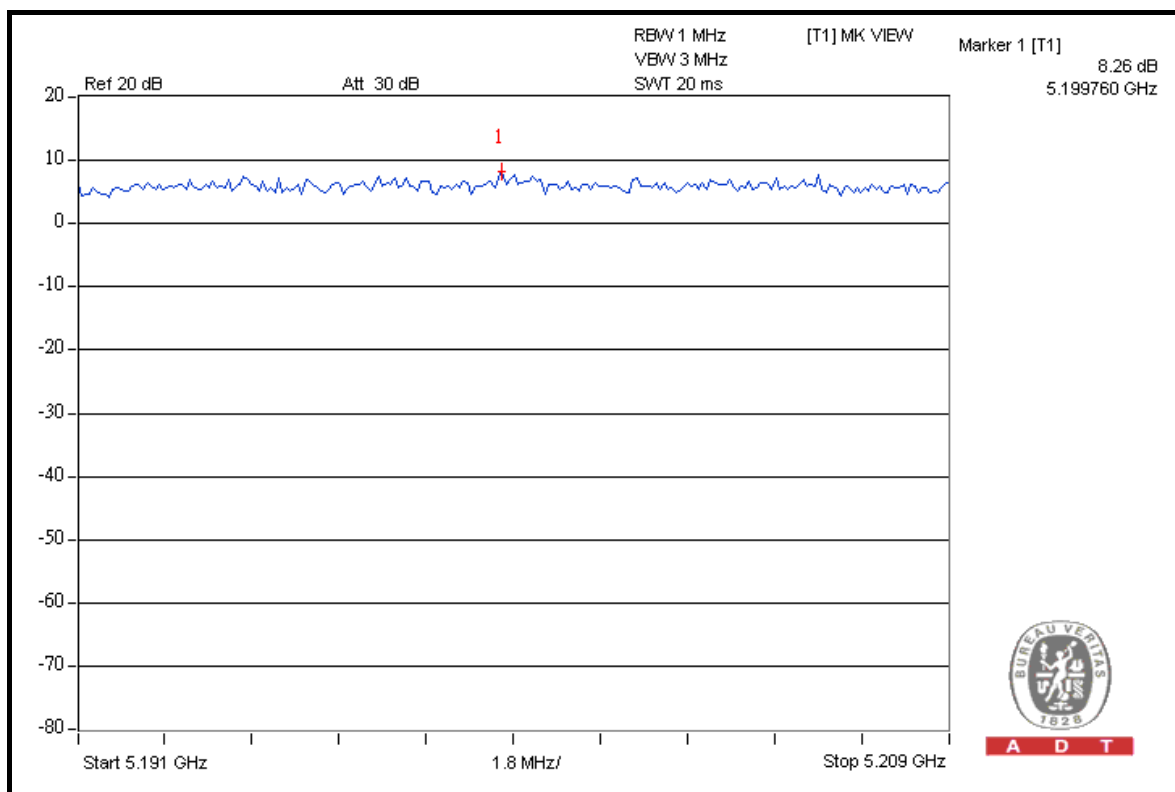
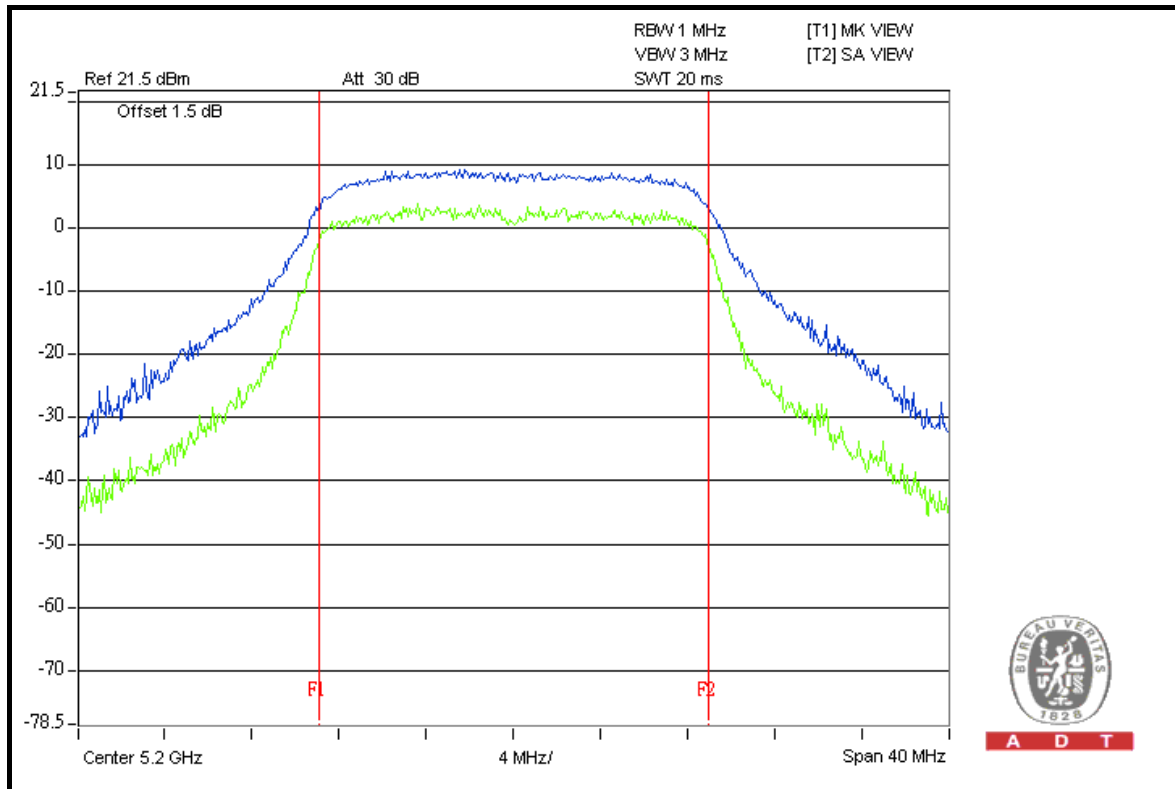



A D T

802.11n (40MHz)

CHANNEL	CHANNEL FREQUENCY (MHz)	PEAK POWER EXCURSION (dB)			PEAK to AVERAGE EXCURSION LIMIT (dB)	PASS/FAIL
		CHAIN 0	CHAIN 1	CHAIN 2		
38	5190	9.66	8.36	10.58	13	PASS
46	5230	8.65	9.00	10.00	13	PASS



A D T

### FOR CHAIN 2: CH 38

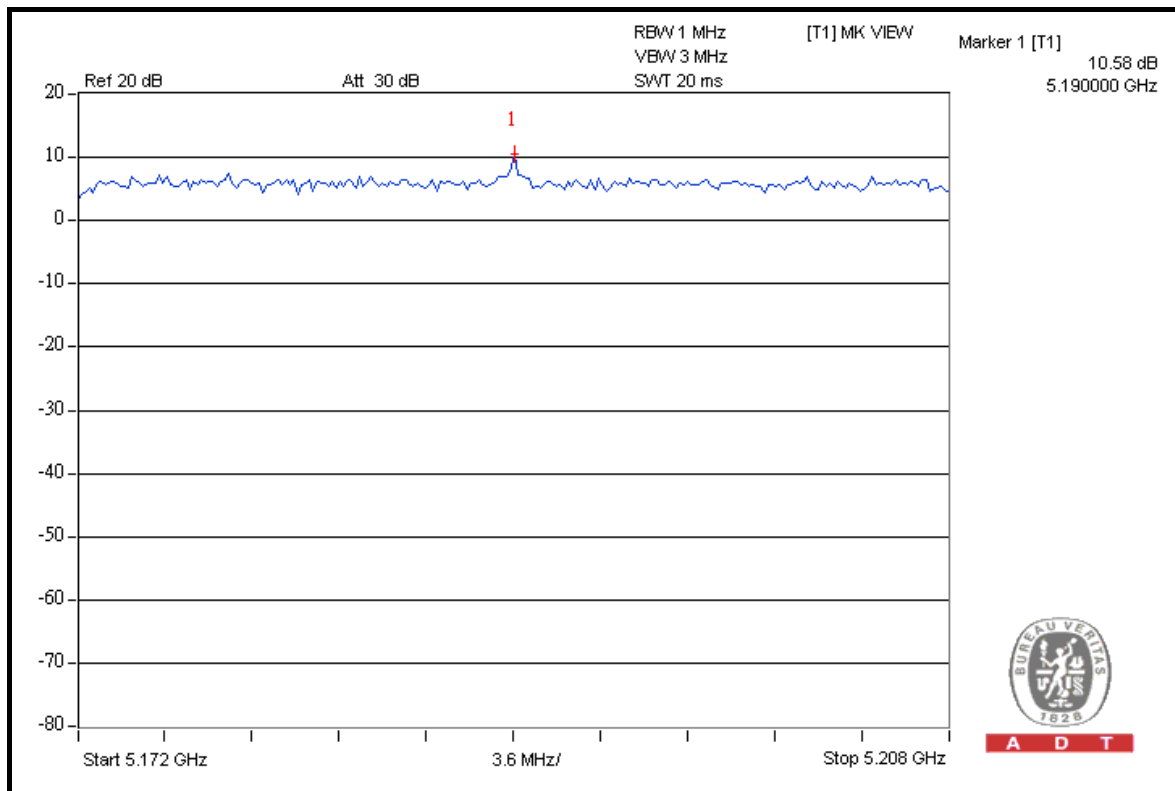
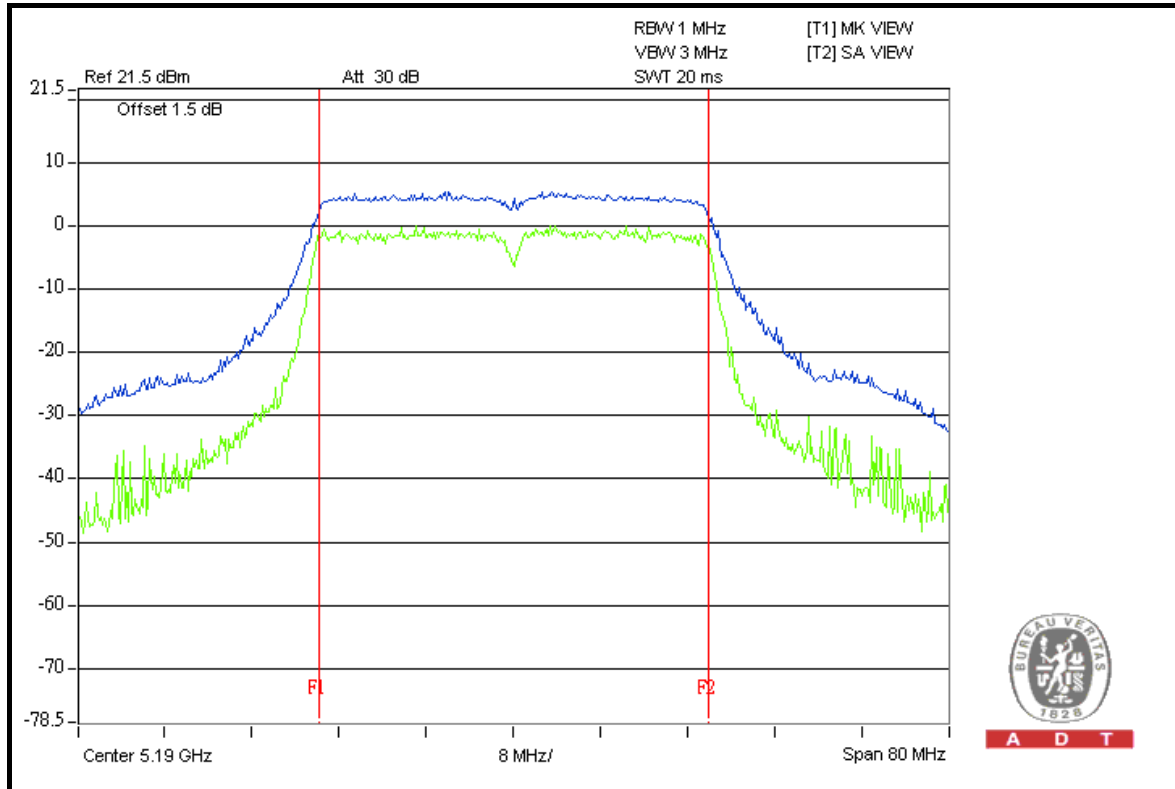



A D T

## 4.5 PEAK POWER SPECTRAL DENSITY MEASUREMENT

### 4.5.1 LIMITS OF PEAK POWER SPECTRAL DENSITY MEASUREMENT

FREQUENCY BAND	LIMIT
5.15 ~ 5.25GHz	4dBm

### 4.5.2 TEST INSTRUMENTS

DESCRIPTION & MANUFACTURER	MODEL NO.	SERIAL NO.	DATE OF CALIBRATION	DUE DATE OF CALIBRATION
R&S SPECTRUM ANALYZER	FSP40	100040	Jul. 07, 2009	Jul. 06, 2010

**NOTE:** The calibration interval of the above test instruments is 12 months and the calibrations are traceable to NML/ROC and NIST/USA.

### 4.5.3 TEST PROCEDURES

- a. The transmitter output was connected to the spectrum analyzer.
- b. Set RBW = 1MHz, VBW = 3MHz. The PPSD is the highest level found across the emission in any 1MHz band.

#### 4.5.4 DEVIATION FROM TEST STANDARD

No deviation

#### 4.5.5 TEST SETUP



#### 4.5.6 EUT OPERATING CONDITIONS

Same as 5.3.6



A D T

### 4.5.7 TEST RESULTS

#### 802.11a

CHAN.	CHAN. FREQ. (MHz)	RF POWER LEVEL IN 3kHz BW (dBm)			TOTAL POWER DENSITY (dBm)	MAX. LIMIT (dBm)	PASS / FAIL
		CHAIN 0	CHAIN 1	CHAIN 2			
36	5180	-1.6	-1.6	-2.1	3.0	4	PASS
40	5200	-1.7	-1.8	-1.8	3.0	4	PASS
48	5240	-1.5	-2.3	-2.0	2.8	4	PASS

#### FOR CHAIN 0: CH 48

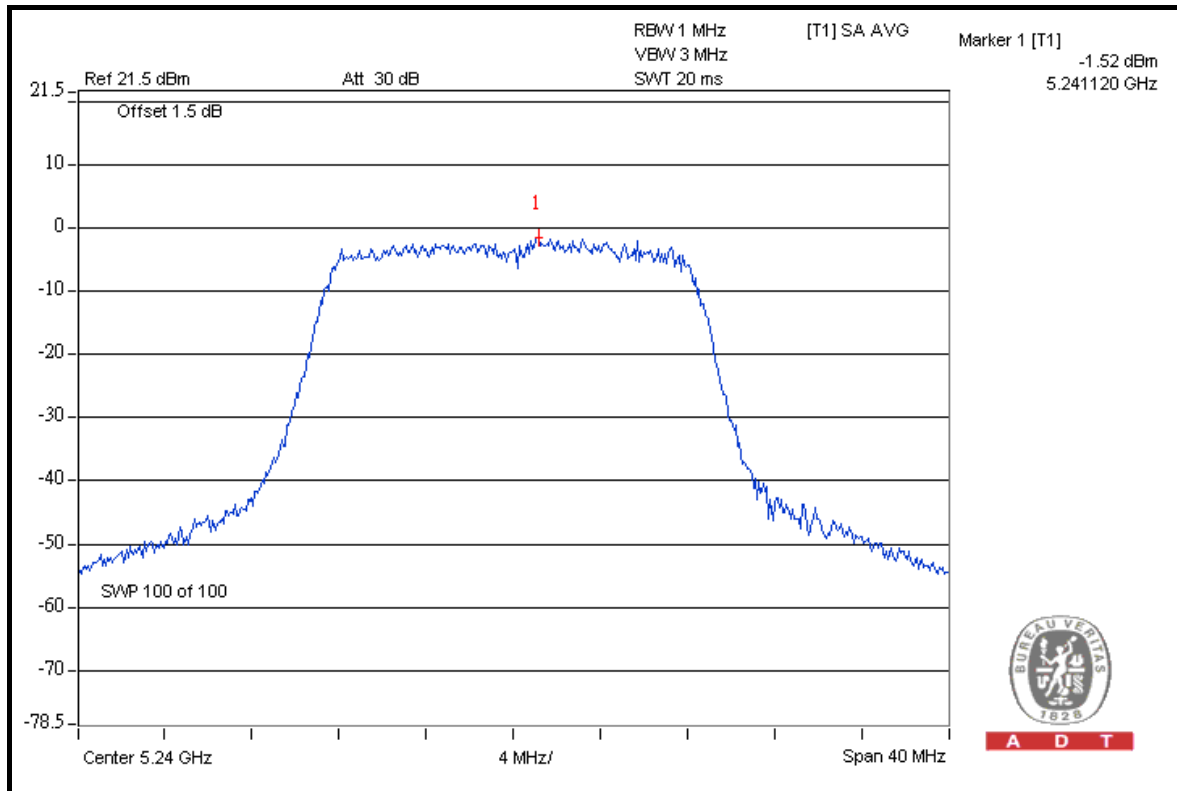



A D T

### 802.11n (20MHz)

CHAN.	CHAN. FREQ. (MHz)	RF POWER LEVEL IN 3kHz BW (dBm)			TOTAL POWER DENSITY (dBm)	MAX. LIMIT (dBm)	PASS / FAIL
		CHAIN 0	CHAIN 1	CHAIN 2			
36	5180	-2.1	-2.1	-2.3	2.6	4	PASS
40	5200	-2.9	-2.0	-2.1	2.4	4	PASS
48	5240	-2.0	-2.3	-2.4	2.6	4	PASS

### FOR CHAIN 1: CH 40

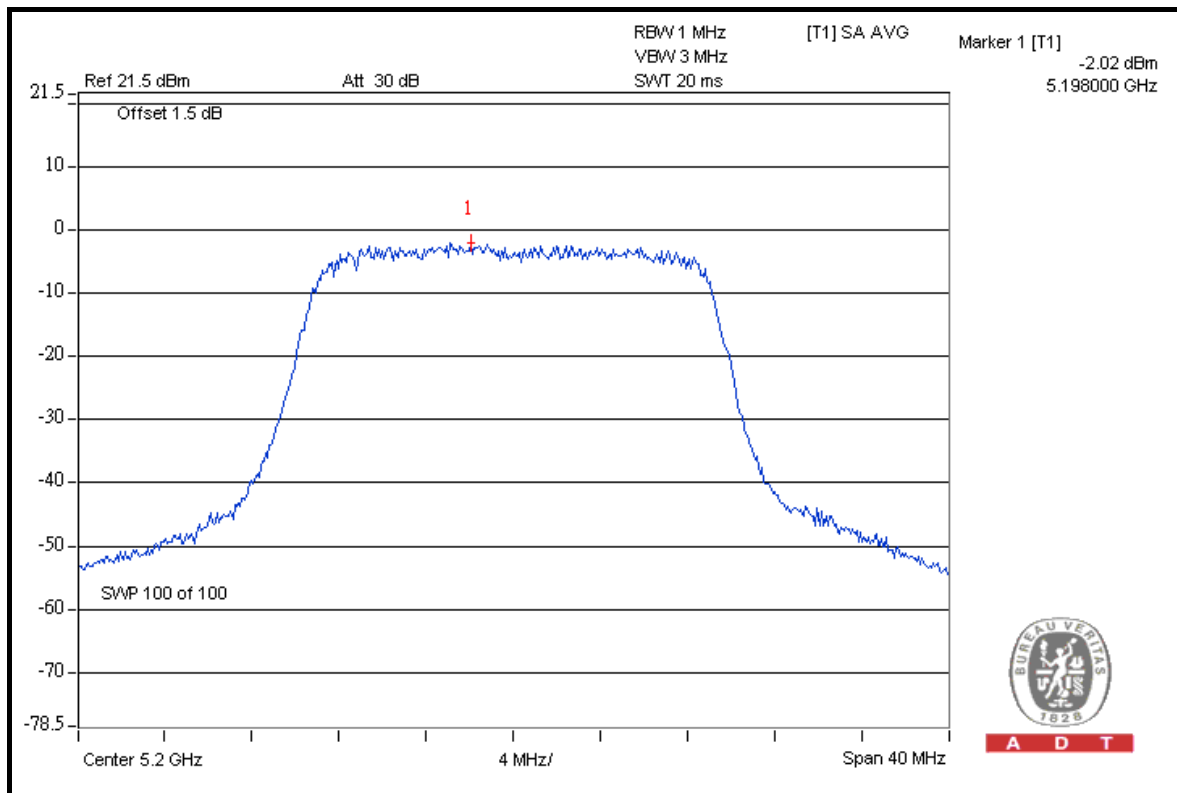



A D T

### 802.11n (40MHz)

CHAN.	CHAN. FREQ. (MHz)	RF POWER LEVEL IN 3kHz BW (dBm)			TOTAL POWER DENSITY (dBm)	MAX. LIMIT (dBm)	PASS / FAIL
		CHAIN 0	CHAIN 1	CHAIN 2			
38	5190	-5.8	-5.8	-5.7	-1.0	4	PASS
46	5230	-5.5	-5.6	-6.0	-0.9	4	PASS

### FOR CHAIN 0: CH 46

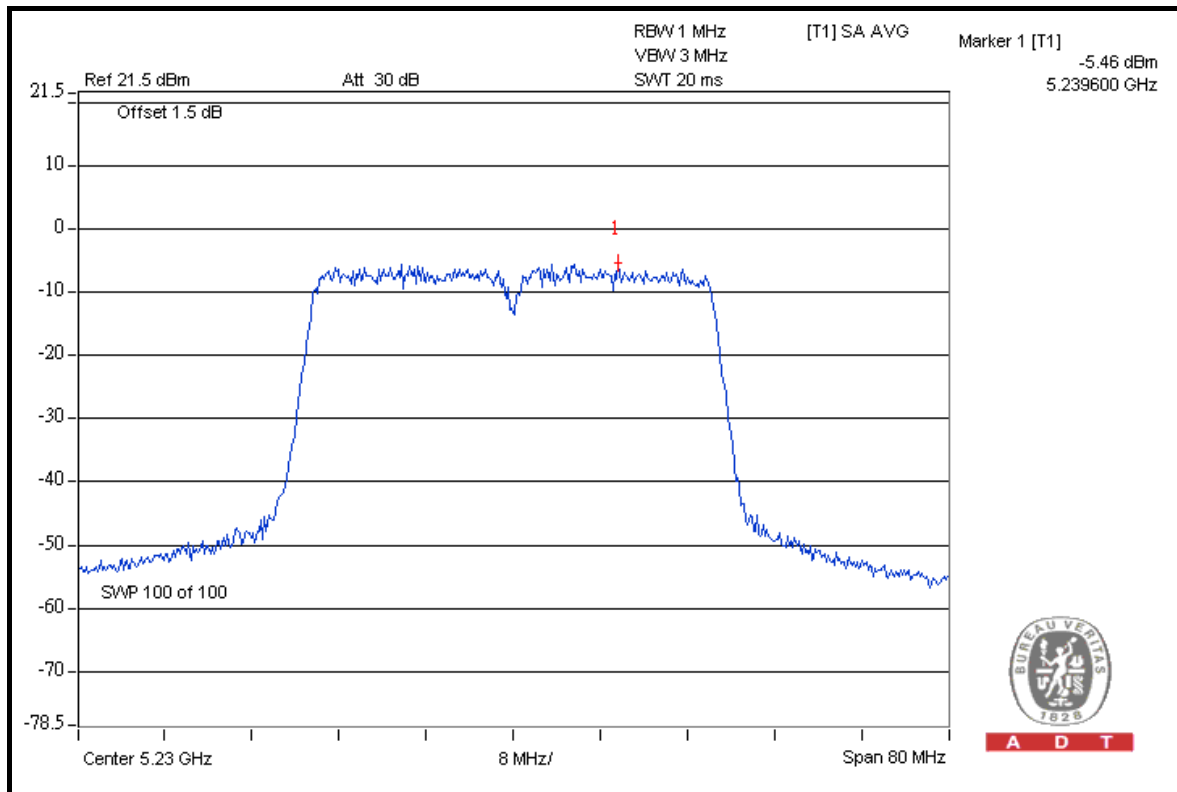





## 4.6 FREQUENCY STABILITY

### 4.6.1 LIMITS OF FREQUENCY STABILITY MEASUREMENT

The frequency tolerance of the carrier signal shall be maintained within +/- 0.02% of the operating frequency over a temperature variation of -30 degrees to 50 degrees C at normal supply voltage, and for a variation in the primary supply voltage from 85% to 115% of the rated supply voltage at a temperature of 20 degrees C.

### 4.6.2 TEST INSTRUMENTS

DESCRIPTION & MANUFACTURER	MODEL NO.	SERIAL NO.	DATE OF CALIBRATION	CALIBRATED UNTIL
R&S SPECTRUM ANALYZER	FSP40	100040	Jul. 07, 2009	Jul. 06, 2010
WIT STANDARD TEMPERATURE AND HUMIDITY CHAMBER	TH-4S-C	W981030	Jun. 24, 2009	Jun. 23, 2010

**NOTE:** The calibration interval of the above test instruments is 12 months and the calibrations are traceable to NML/ROC and NIST/USA.

### 4.6.3 TEST PROCEDURE

- a. The EUT was placed inside the environmental test chamber and powered by nominal DC voltage.
- b. Turn the EUT on and couple its output to a spectrum analyzer.
- c. Turn the EUT off and set the chamber to the highest temperature specified.
- d. Allow sufficient time (approximately 30 min) for the temperature of the chamber to stabilize, turn the EUT on and measure the operating frequency after 2, 5, and 10 minutes.
- e. Repeat step 2 and 3 with the temperature chamber set to the lowest temperature.
- f. The test chamber was allowed to stabilize at +20 degree C for a minimum of 30 minutes. The supply voltage was then adjusted on the EUT from 85% to 115% and the frequency record.

#### 4.6.4 DEVIATION FROM TEST STANDARD

No deviation

#### 4.6.5 TEST SETUP

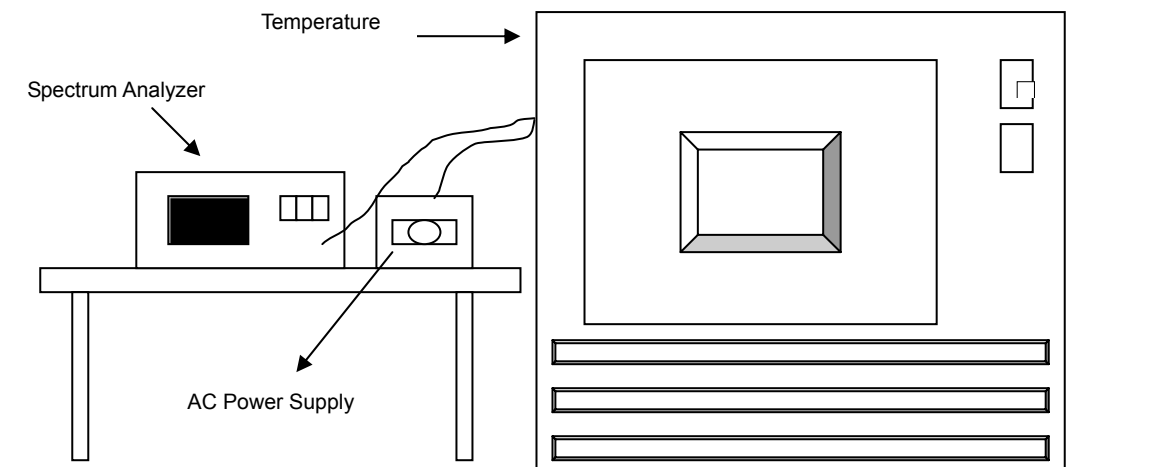

#### 4.6.6 EUT OPERATING CONDITION

Same as Item 4.1.6



### 4.6.7 TEST RESULTS

FREQUENCY STABILITY VERSUS TEMP.									
OPERATING FREQUENCY: 5200MHz									
TEMP. (°C)	POWER SUPPLY (Vdc)	0 MINUTE		2 MINUTE		5 MINUTE		10 MINUTE	
		Measured Frequency	Frequency Drift	Measured Frequency	Frequency Drift	Measured Frequency	Frequency Drift	Measured Frequency	Frequency Drift
		(MHz)	ppm	(MHz)	ppm	(MHz)	ppm	(MHz)	ppm
55	110.0	5199.987771	-2.352	5199.988311	-2.248	5199.988099	-2.289	5199.987582	-2.388
50	110.0	5199.988507	-2.210	5199.988538	-2.204	5199.988677	-2.177	5199.988036	-2.301
40	110.0	5199.990215	-1.882	5199.989916	-1.939	5199.990094	-1.905	5199.990147	-1.895
30	110.0	5199.991005	-1.730	5199.991298	-1.673	5199.991318	-1.670	5199.991565	-1.622
20	110.0	5199.992656	-1.412	5199.993039	-1.339	5199.992353	-1.471	5199.992406	-1.460
10	110.0	5199.991188	-1.695	5199.990899	-1.750	5199.991139	-1.704	5199.991424	-1.649
0	110.0	5199.990002	-1.923	5199.989621	-1.996	5199.989515	-2.016	5199.989521	-2.015
-10	110.0	5199.989239	-2.069	5199.989264	-2.065	5199.988579	-2.196	5199.988574	-2.197
-20	110.0	5199.988123	-2.284	5199.987860	-2.335	5199.988092	-2.290	5199.988154	-2.278

FREQUENCY STABILITY VERSUS VOLTAGE									
OPERATING FREQUENCY: 5200MHz									
TEMP. (°C)	POWER SUPPLY (Vac)	0 MINUTE		2 MINUTE		5 MINUTE		10 MINUTE	
		Measured Frequency	Frequency Drift	Measured Frequency	Frequency Drift	Measured Frequency	Frequency Drift	Measured Frequency	Frequency Drift
		(MHz)	ppm	(MHz)	ppm	(MHz)	ppm	(MHz)	ppm
20	93.5	5199.990452	-1.836	5199.990279	-1.869	5199.990417	-1.843	5199.990317	-1.862
	110.0	5199.991005	-1.730	5199.991298	-1.673	5199.991318	-1.670	5199.991565	-1.622
	126.5	5199.993026	-1.341	5199.992559	-1.431	5199.992669	-1.410	5199.992810	-1.383



A D T

## 4.7 BAND EDGES MEASUREMENT

### 4.7.1 TEST INSTRUMENTS

DESCRIPTION & MANUFACTURER	MODEL NO.	SERIAL NO.	DATE OF CALIBRATION	DUE DATE OF CALIBRATION
Test Receiver ROHDE & SCHWARZ	ESIB7	100212	May 25, 2009	May 24, 2010
Spectrum Analyzer ROHDE & SCHWARZ	FSP40	100040	Jul. 07, 2009	Jul. 06, 2010
BILOG Antenna SCHWARZBECK	VULB9168	9168-156	Apr. 30, 2010	Apr. 29, 2011
HORN Antenna SCHWARZBECK	BBHA 9120 D	9120D-563	Aug. 10, 2009	Aug. 09, 2010
HORN Antenna SCHWARZBECK	BBHA 9170	BBHA9170242	Dec. 25, 2009	Dec. 24, 2010
Preamplifier Agilent	8449B	3008A01910	Sep. 11, 2009	Sep. 10, 2010
Preamplifier Agilent	8447D	2944A10638	Dec. 21, 2009	Dec. 20, 2010
RF signal cable HUBER+SUHNNER	SUCOFLEX 104	218190/4 231241/4	May 13, 2009	May 12, 2010
RF signal cable Worken	8D-FB	Cable-HYCH9-01	Aug. 17, 2009	Aug. 16, 2010
Software	ADT_Radiated_ V7.6.15.9.2	NA	NA	NA
Antenna Tower EMCO	2070/2080	512.835.4684	NA	NA
Turn Table EMCO	2087-2.03	NA	NA	NA
Antenna Tower & Turn Table Controller EMCO	2090	NA	NA	NA
26GHz ~ 40GHz Amplifier	EM26400	07026401	Aug. 27, 2009	Aug. 26, 2010

**NOTE:** The calibration interval of the above test instruments is 12 months and the calibrations are traceable to NML/ROC and NIST/USA.

#### 4.7.2 TEST PROCEDURE

- a. The EUT was placed on the top of a rotating table 0.8 meters above the ground at a 3 meter semi-anechoic chamber. The table was rotated 360 degrees to determine the position of the highest radiation.
- b. The EUT was set 3 meters away from the interference-receiving antenna, which was mounted on the top of a variable-height antenna tower.
- c. The antenna is a broadband antenna, and its height is varied from one meter to four meters above the ground to determine the maximum value of the field strength. Both horizontal and vertical polarizations of the antenna are set to make the measurement.
- d. For each suspected emission, the EUT was arranged to its worst case and then the antenna was tuned to heights from 1 meter to 4 meters and the rotatable table was turned from 0 degrees to 360 degrees to find the maximum reading.
- e. Set both RBW and VBW of spectrum analyzer to 1MHz and 3MHz with suitable frequency span including 100MHz bandwidth from band edge. The band edges was measured and recorded.

**NOTE:** The resolution bandwidth of test receiver/spectrum analyzer is 1MHz and the video bandwidth is 10Hz for Average detection (AV) at frequency above 1GHz

#### 4.7.3 EUT OPERATING CONDITION

The software provided by client to enable the EUT under transmission condition continuously at specific channel frequencies individually.



#### 4.7.4 TEST RESULTS

For signals in the restricted bands above and below the 5.15 to 5.25GHz allocated band a measurement was made of the amplitude of the spurious emissions with respect to the intentional signals. The relative amplitude, in dBc, was applied to the average and peak field strength of the intentional signal made on the OATS to calculate the field strength of the unintentional signals.

The spectrum plots (Peak RBW = 1MHz, VBW = 3MHz) are attached on the following pages.

#### 802.11a

##### RESTRICT BAND (4500 ~ 5150 MHz)

FREQUENCY (MHz)	FUNDAMENTAL EMISSION (dBuV/m)	DELTA (dB)	MAXIMUM FIELD STRENGTH IN RESTRICT BAND (dBuV/m)	LIMIT (dBuV/m)
5180.00 (PK)	111.0	51.80	59.20	74.00
5180.00 (AV)	100.9	53.36	47.54	54.00

##### RESTRICT BAND (5350 ~ 5460 MHz)

FREQUENCY (MHz)	FUNDAMENTAL EMISSION (dBuV/m)	DELTA (dB)	MAXIMUM FIELD STRENGTH IN RESTRICT BAND (dBuV/m)	LIMIT (dBuV/m)
5240.00 (PK)	111.1	51.32	59.78	74.00
5240.00 (AV)	100.9	53.03	47.87	54.00

**NOTE:**

1. Delta = Amplitude between the peak of the fundamental and the peak of the band edge emission. Please check following 3 pages.
2. Maximum field strength in restrict band = Fundamental emission – Delta.



A D T

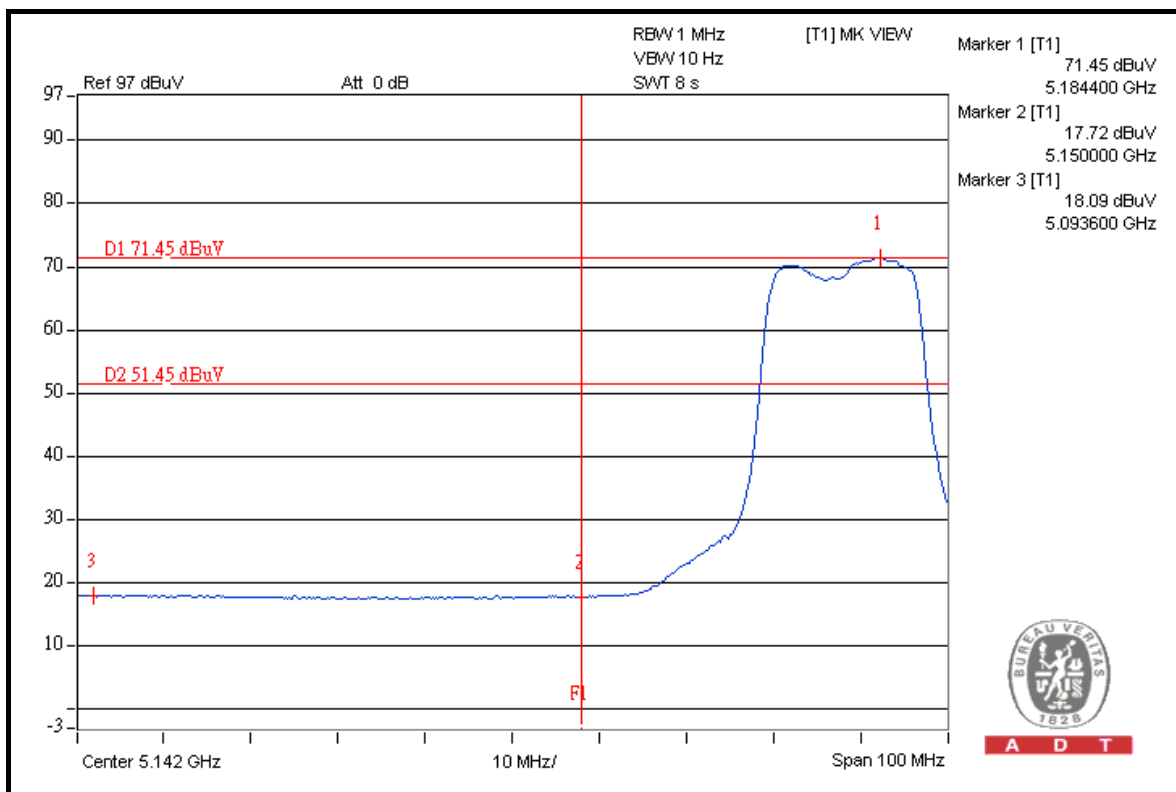
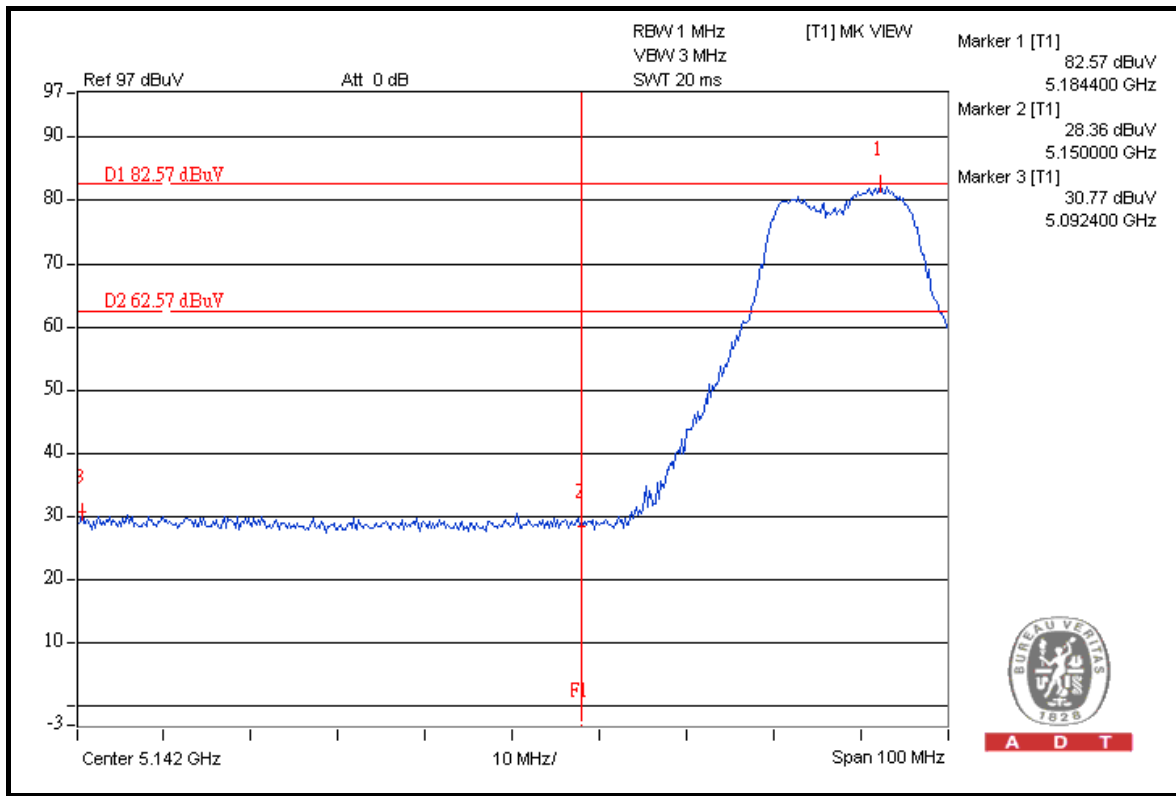



A D T

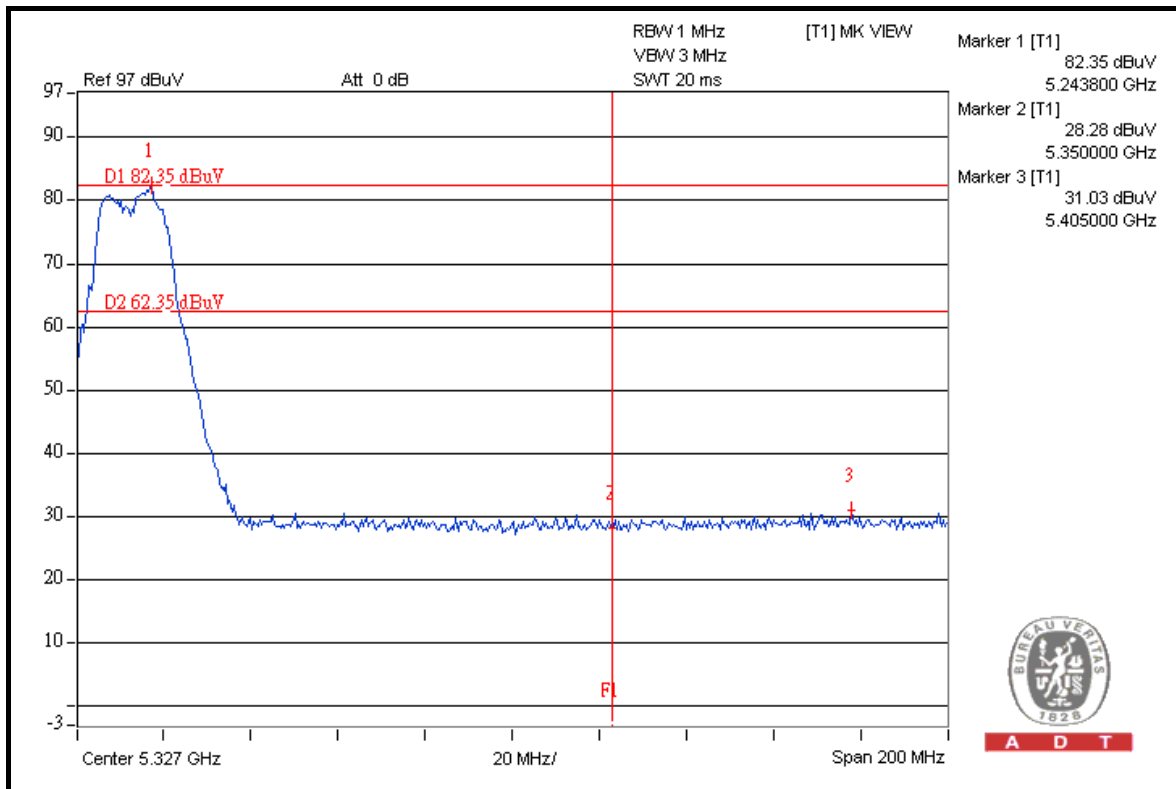
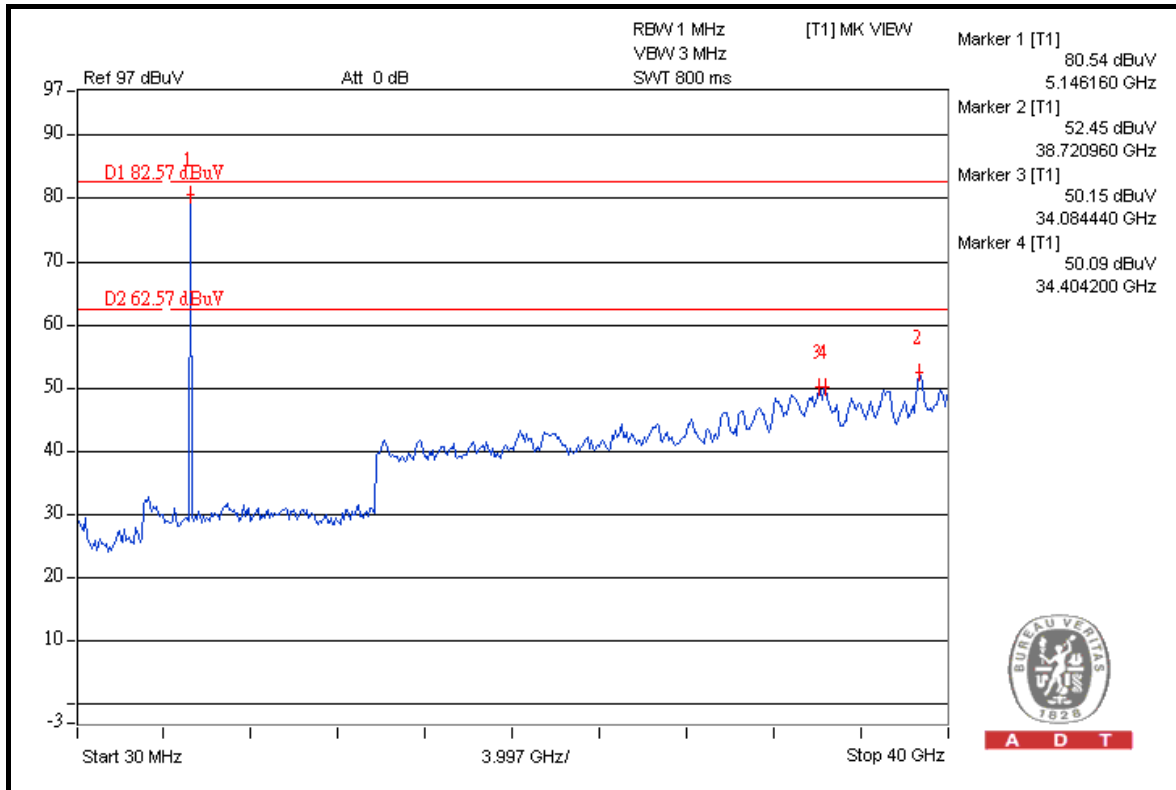





A D T

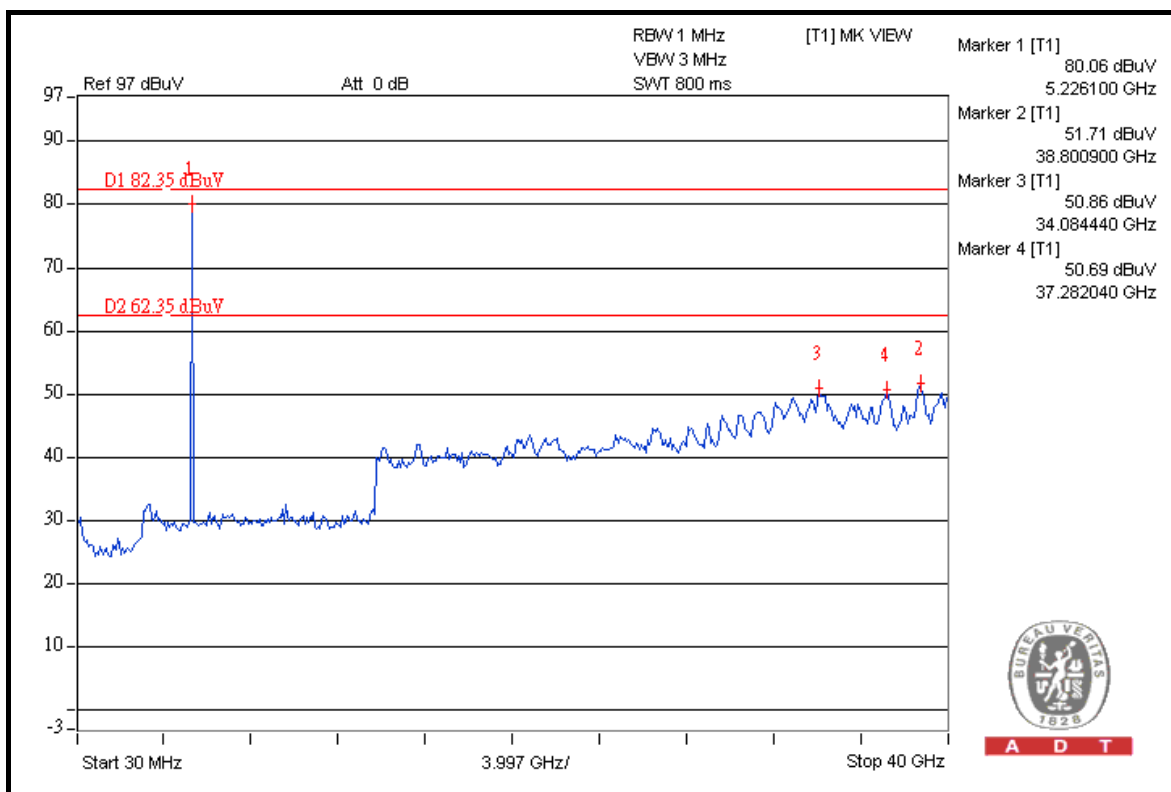
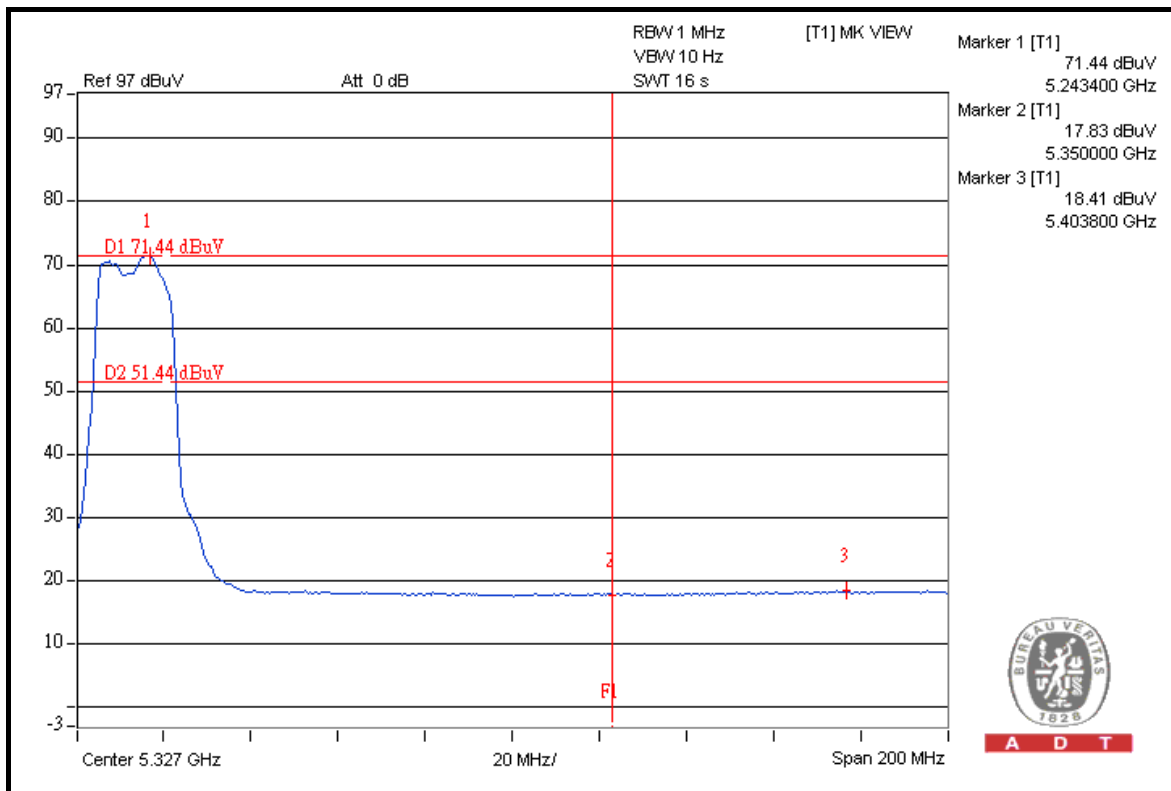



A D T

## 802.11n (20MHz)

### RESTRICT BAND (4500 ~ 5150 MHz)

FREQUENCY (MHz)	FUNDAMENTAL EMISSION (dBuV/m)	DELTA (dB)	MAXIMUM FIELD STRENGTH IN RESTRICT BAND (dBuV/m)	LIMIT (dBuV/m)
5180.00 (PK)	110.3	50.19	60.11	74.00
5180.00 (AV)	99.8	52.13	47.67	54.00

### RESTRICT BAND (5350 ~ 5460 MHz)

FREQUENCY (MHz)	FUNDAMENTAL EMISSION (dBuV/m)	DELTA (dB)	MAXIMUM FIELD STRENGTH IN RESTRICT BAND (dBuV/m)	LIMIT (dBuV/m)
5240.00 (PK)	110.6	49.90	60.70	74.00
5240.00 (AV)	100.1	52.35	47.75	54.00

#### NOTE:

1. Delta = Amplitude between the peak of the fundamental and the peak of the band edge emission. Please check following 3 pages.
2. Maximum field strength in restrict band = Fundamental emission – Delta.



A D T

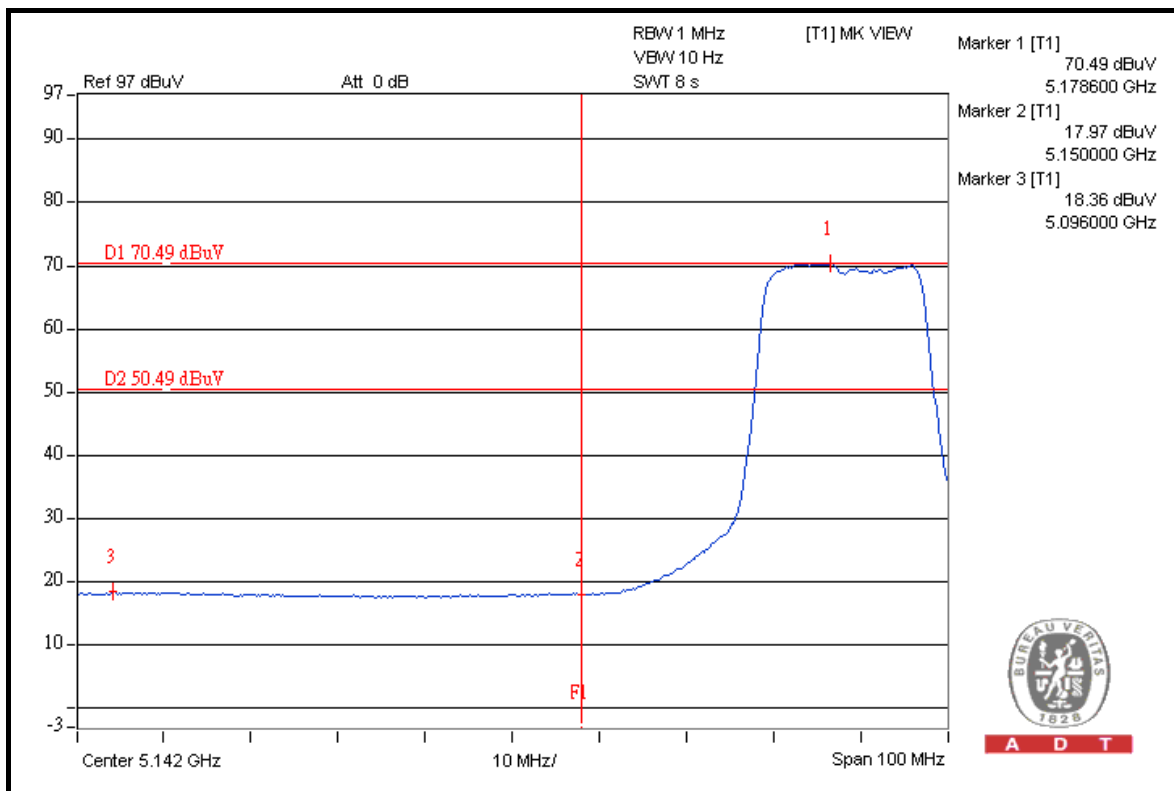
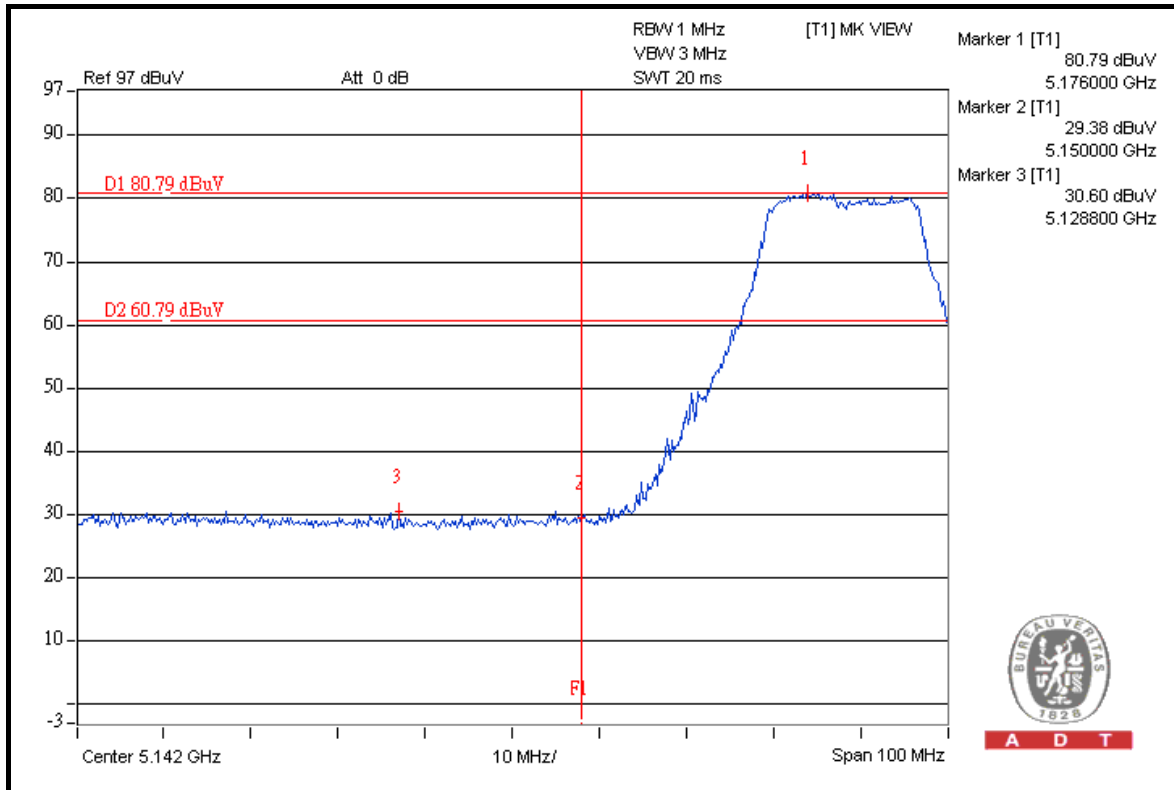



A D T

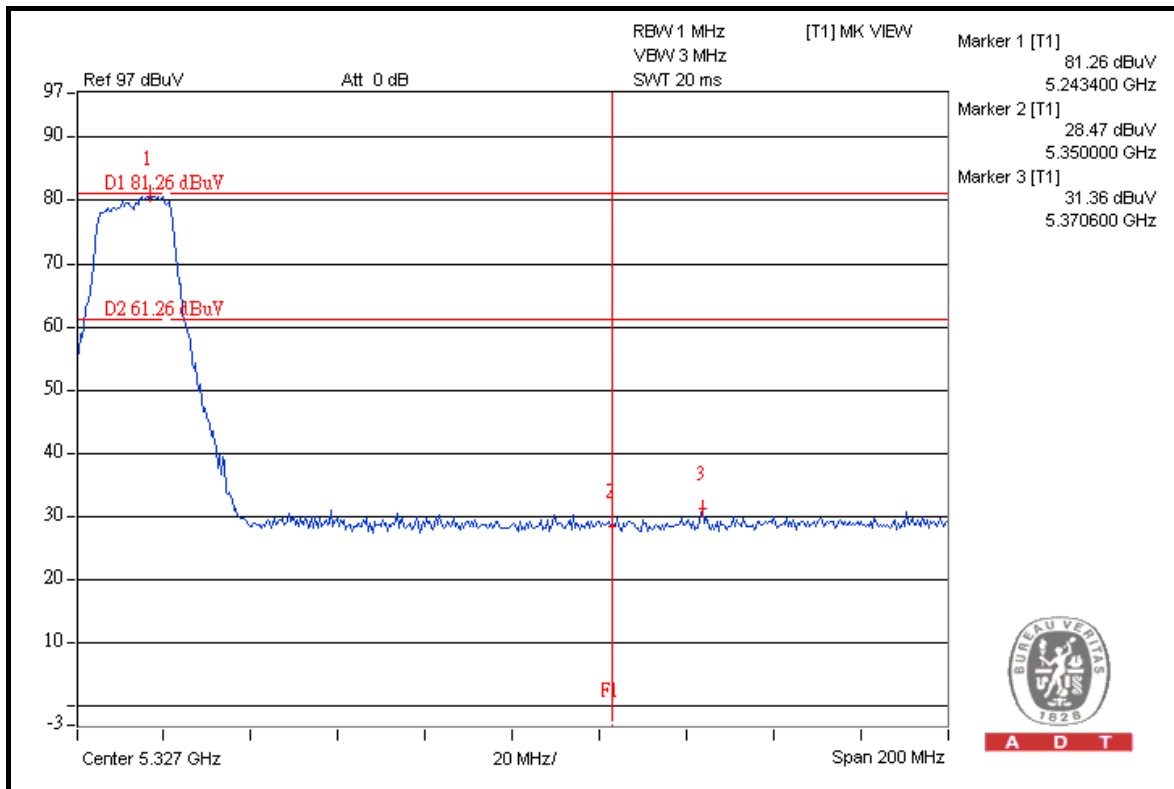
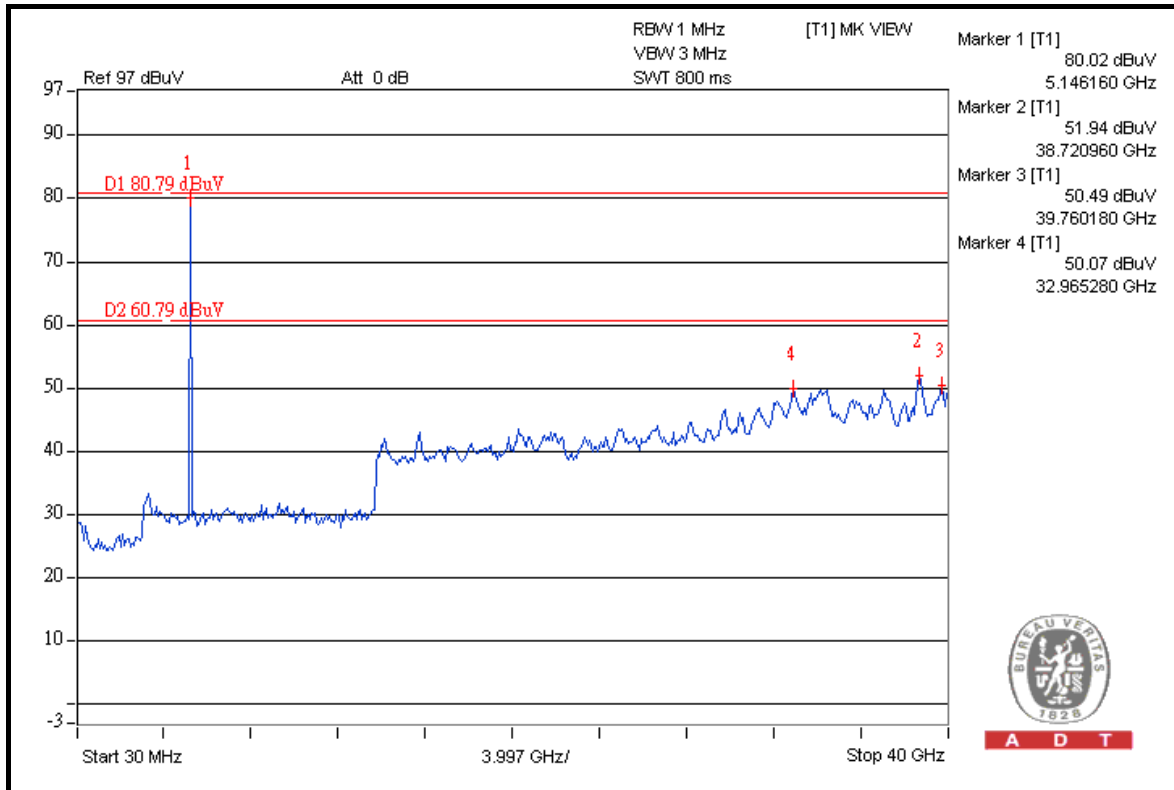



A D T

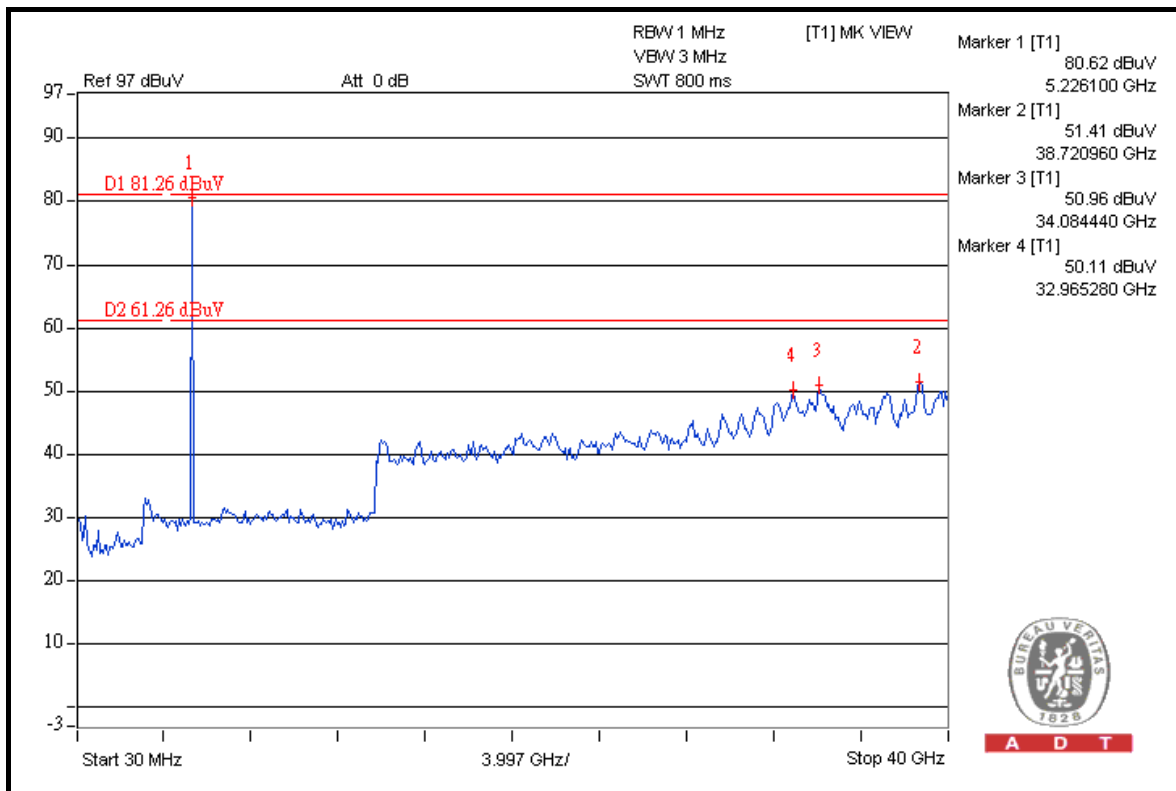
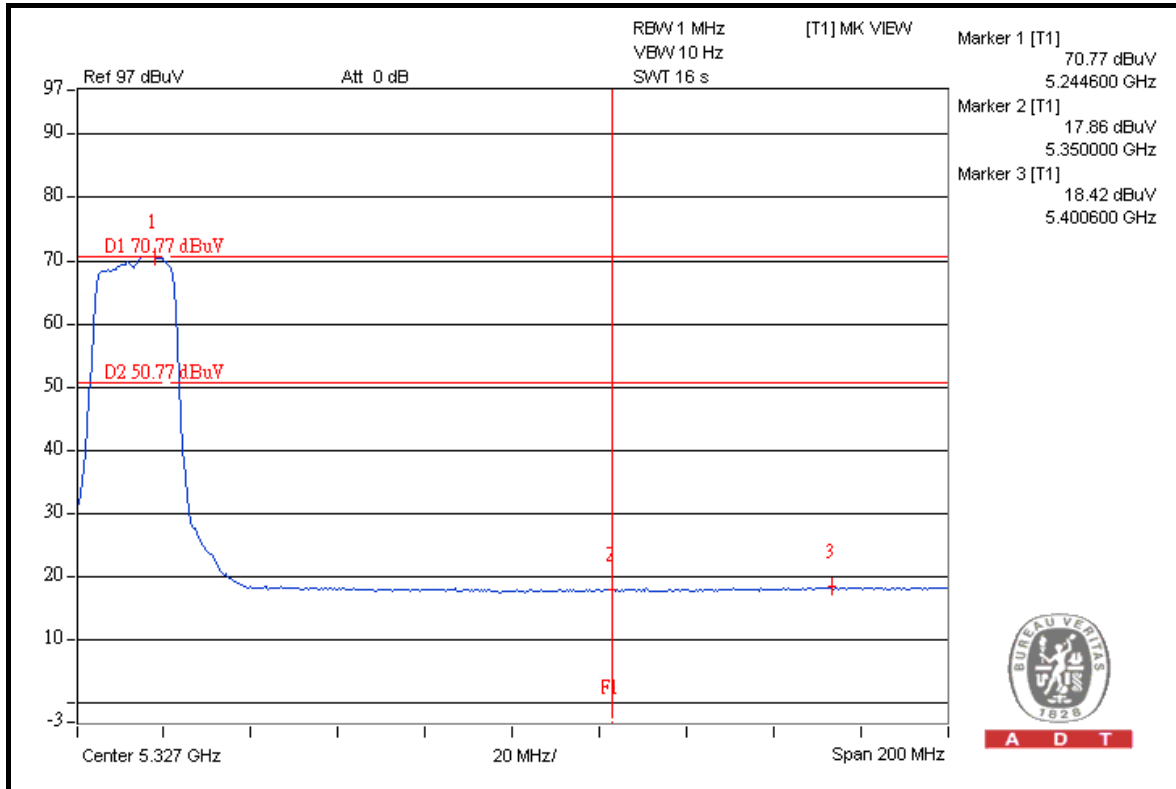



A D T

## 802.11n (40MHz)

### RESTRICT BAND (4500 ~ 5150 MHz)

FREQUENCY (MHz)	FUNDAMENTAL EMISSION (dBuV/m)	DELTA (dB)	MAXIMUM FIELD STRENGTH IN RESTRICT BAND (dBuV/m)	LIMIT (dBuV/m)
5190.00 (PK)	108.3	37.82	70.48	74.00
5190.00 (AV)	98.2	47.63	50.57	54.00

### RESTRICT BAND (5350 ~ 5460 MHz)

FREQUENCY (MHz)	FUNDAMENTAL EMISSION (dBuV/m)	DELTA (dB)	MAXIMUM FIELD STRENGTH IN RESTRICT BAND (dBuV/m)	LIMIT (dBuV/m)
5230.00 (PK)	108.2	47.05	61.15	74.00
5230.00 (AV)	98.1	49.90	48.20	54.00

#### NOTE:

1. Delta = Amplitude between the peak of the fundamental and the peak of the band edge emission. Please check following 3 pages.
2. Maximum field strength in restrict band = Fundamental emission – Delta.



A D T

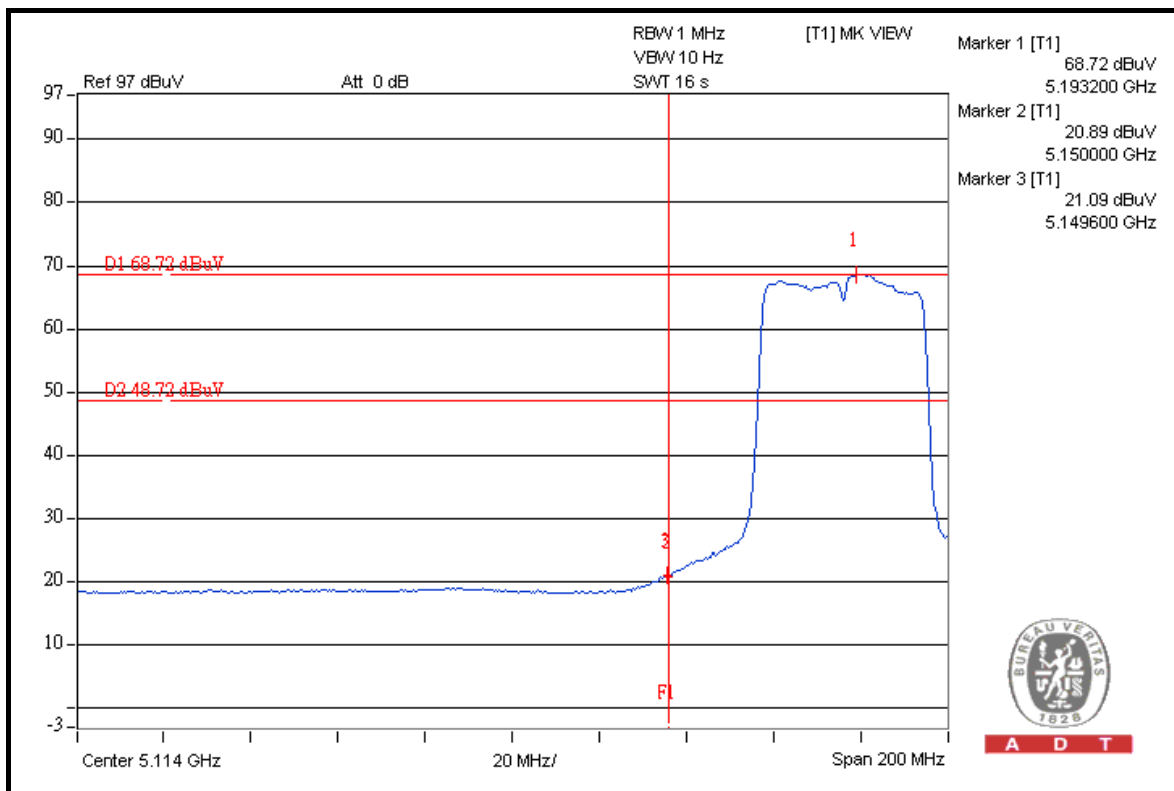
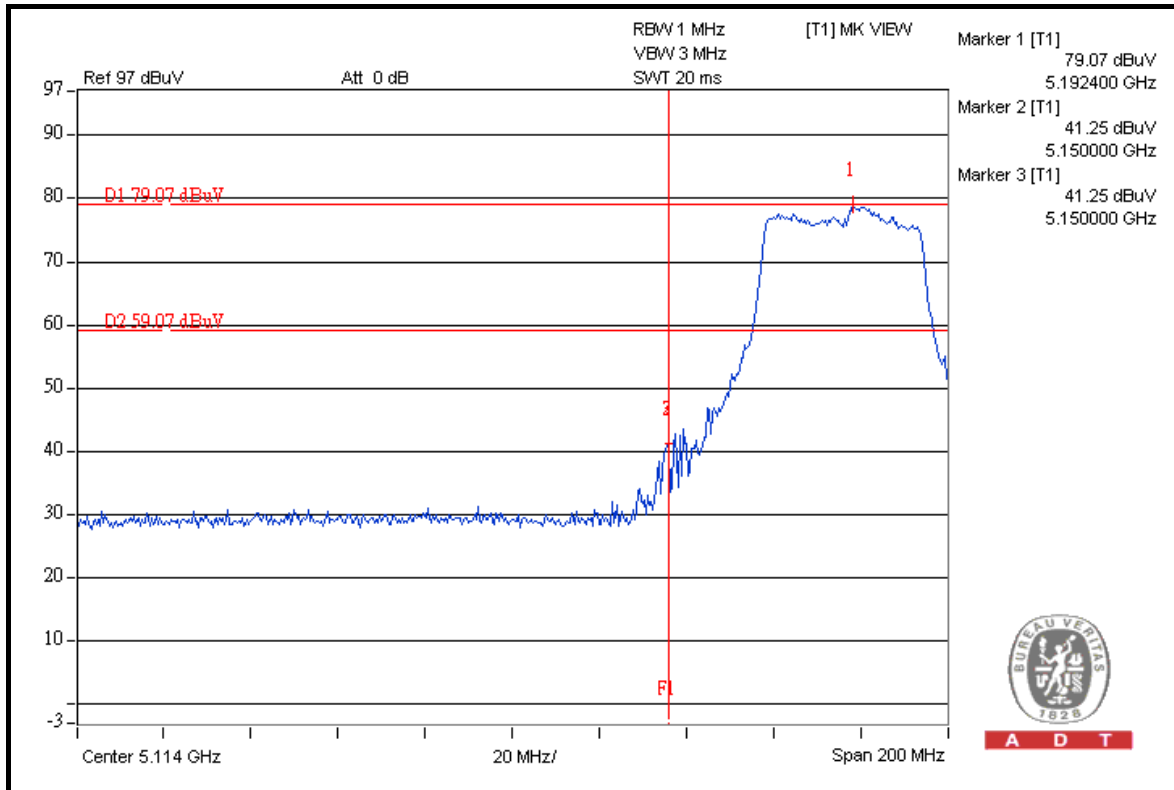



A D T

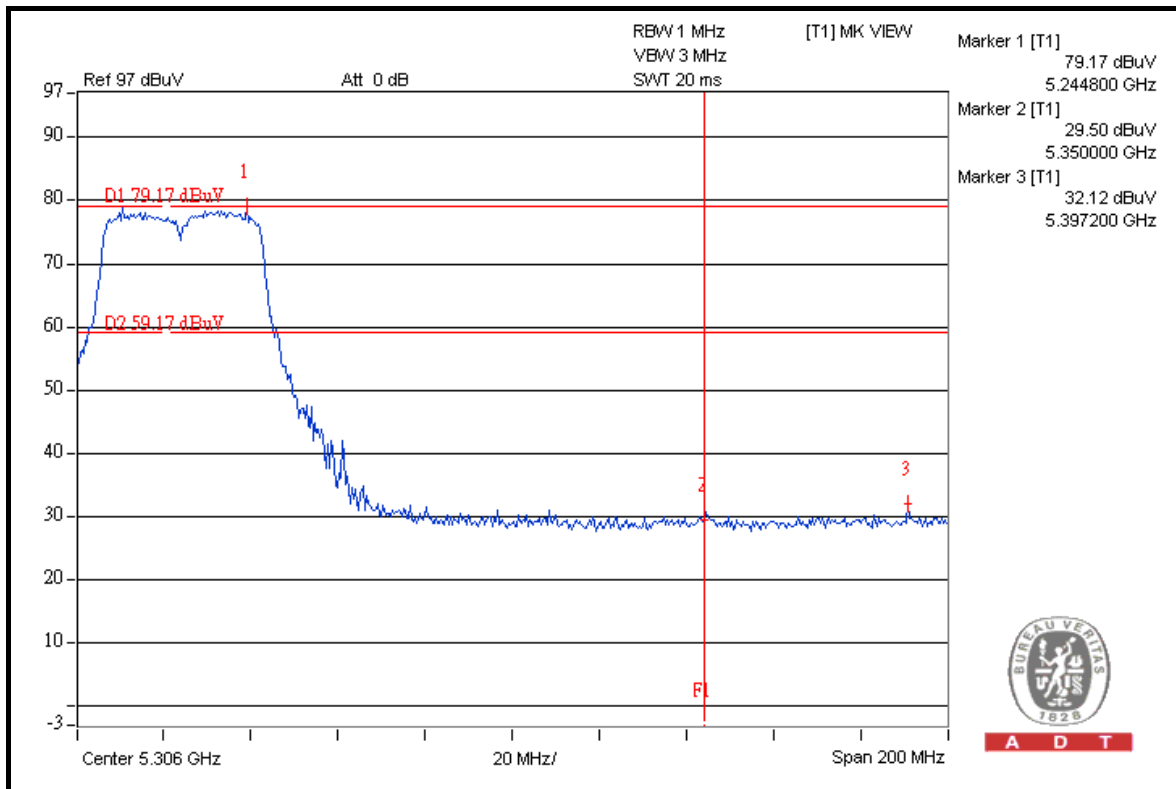
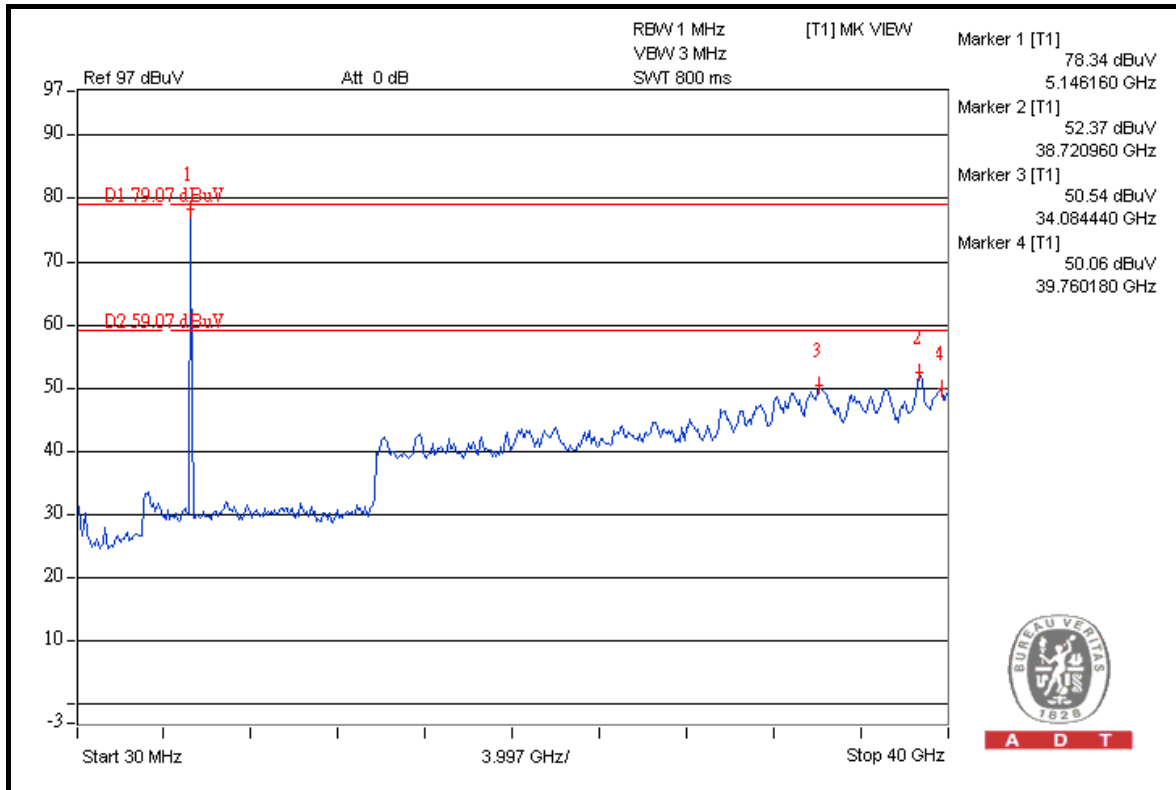





A D T

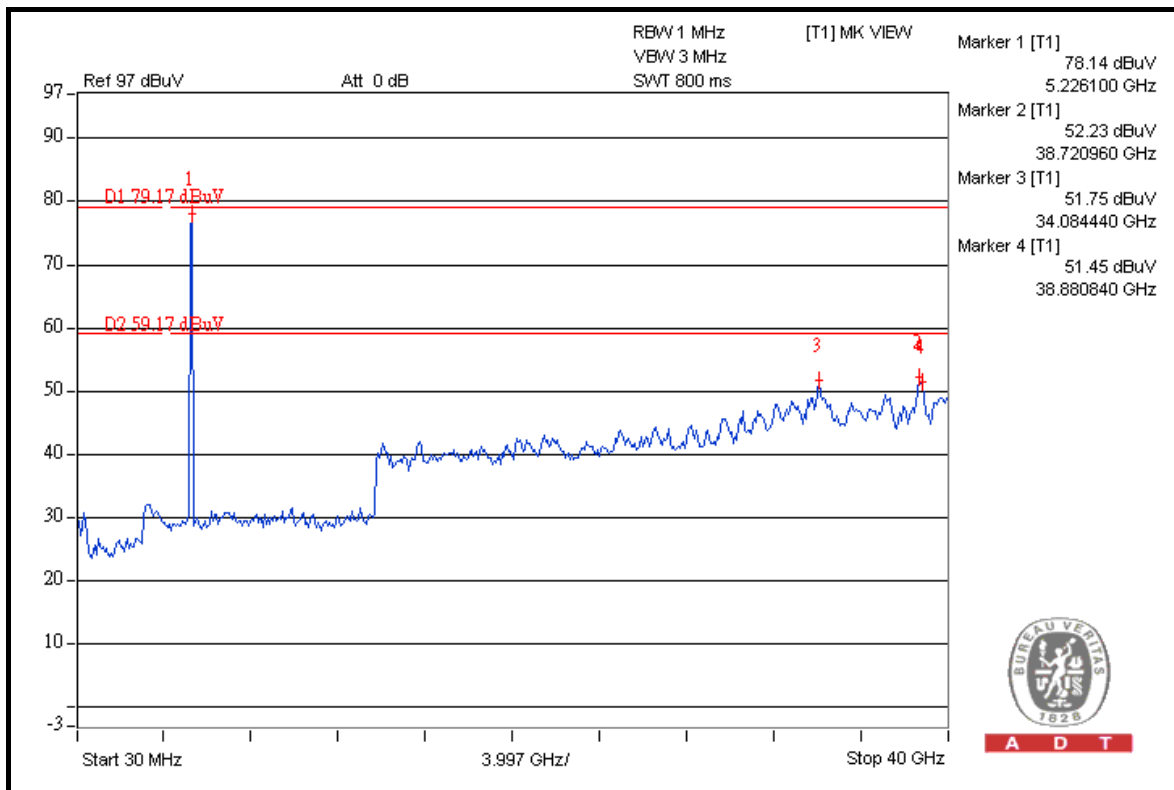
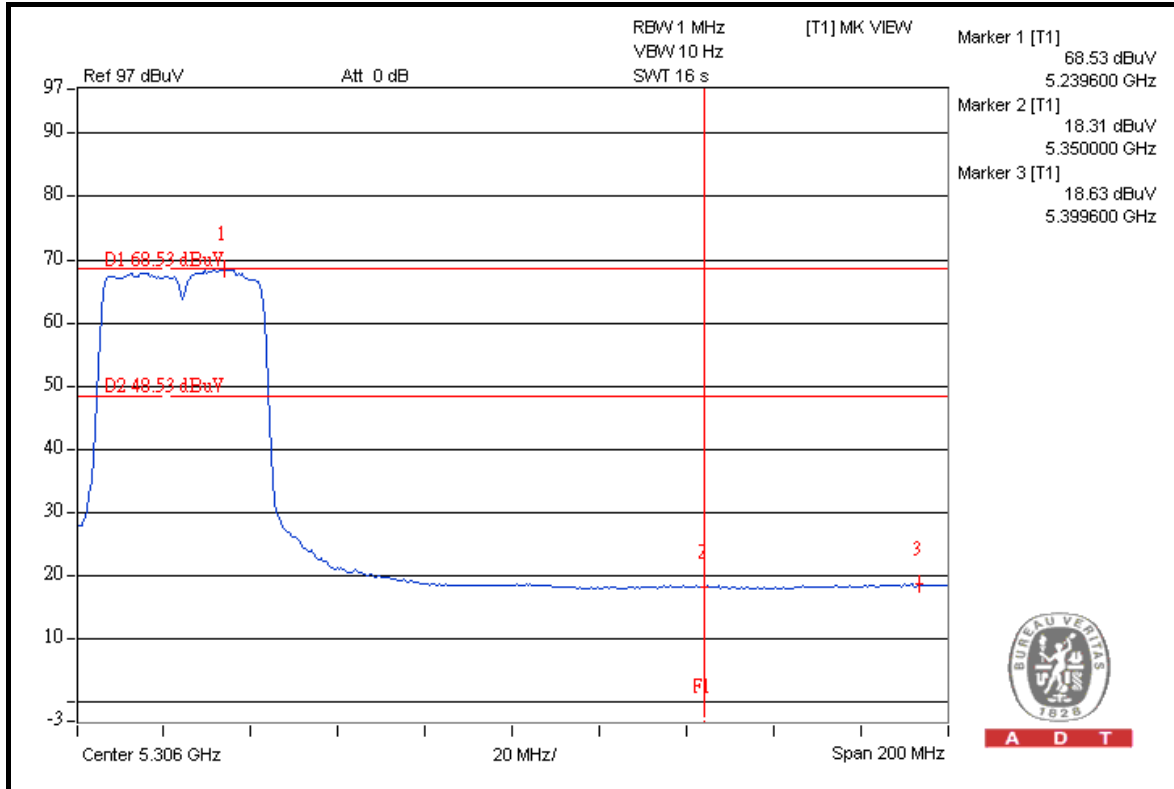



A D T

## 5. PHOTOGRAPHS OF THE TEST CONFIGURATION

Please refer to the attached file (Test Setup Photo).



A D T

## 6. INFORMATION ON THE TESTING LABORATORIES

We, Bureau Veritas Consumer Products Services (H.K.) Ltd., Taoyuan Branch, were founded in 1988 to provide our best service in EMC, Radio, Telecom and Safety consultation. Our laboratories are accredited and approved according to ISO/IEC 17025.

Copies of accreditation certificates of our laboratories obtained from approval agencies can be downloaded from our web site:

[www.adt.com.tw/index.5/phtml](http://www.adt.com.tw/index.5/phtml). If you have any comments, please feel free to contact us at the following:

**Linko EMC/RF Lab:**

Tel: 886-2-26052180

Fax: 886-2-26051924

**Hsin Chu EMC/RF Lab:**

Tel: 886-3-5935343

Fax: 886-3-5935342

**Hwa Ya EMC/RF/Safety Telecom Lab:**

Tel: 886-3-3183232

Fax: 886-3-3185050

**Web Site:** [www.adt.com.tw](http://www.adt.com.tw)

The address and road map of all our labs can be found in our web site also.



A D T

## **7. APPENDIX A - MODIFICATIONS RECORDERS FOR ENGINEERING CHANGES TO THE EUT BY THE LAB**

No any modifications are made to the EUT by the lab during the test.

**---END---**