



USER GUIDE

60 GHz cnWave™

System Release 1.2.2.1



Reservation of Rights

Cambium reserves the right to make changes to any products described herein to improve reliability, function, or design, and reserves the right to revise this document and to make changes from time to time in content hereof with no obligation to notify any person of revisions or changes. Cambium recommends reviewing the Cambium Networks website for the latest changes and updates to products. Cambium does not assume any liability arising out of the application or use of any product, software, or circuit described herein; neither does it convey license under its patent rights or the rights of others. It is possible that this publication may contain references to, or information about Cambium products (machines and programs), programming, or services that are not announced in your country. Such references or information must not be construed to mean that Cambium intends to announce such Cambium products, programming, or services in your country.

Copyrights

This document, Cambium products, and 3rd Party software products described in this document may include or describe copyrighted Cambium and other 3rd Party supplied computer programs stored in semiconductor memories or other media. Laws in the United States and other countries preserve for Cambium, its licensors, and other 3rd Party supplied software certain exclusive rights for copyrighted material, including the exclusive right to copy, reproduce in any form, distribute and make derivative works of the copyrighted material. Accordingly, any copyrighted material of Cambium, its licensors, or the 3rd Party software supplied material contained in the Cambium products described in this document may not be copied, reproduced, reverse engineered, distributed, merged or modified in any manner without the express written permission of Cambium. Furthermore, the purchase of Cambium products shall not be deemed to grant either directly or by implication, estoppel, or otherwise, any license under the copyrights, patents or patent applications of Cambium or other 3rd Party supplied software, except for the normal non-exclusive, royalty free license to use that arises by operation of law in the sale of a product.

Restrictions

Software and documentation are copyrighted materials. Making unauthorized copies is prohibited by law. No part of the software or documentation may be reproduced, transmitted, transcribed, stored in a retrieval system, or translated into any language or computer language, in any form or by any means, without prior written permission of Cambium.

License Agreements

The software described in this document is the property of Cambium and its licensors. It is furnished by express license agreement only and may be used only in accordance with the terms of such an agreement.

High Risk Materials

Cambium and its supplier(s) specifically disclaim any express or implied warranty of fitness for any high-risk activities or uses of its products including, but not limited to, the operation of nuclear facilities, aircraft navigation or aircraft communication systems, air traffic control, life support, or weapons systems (“High Risk Use”).

This product is not restricted in the EU. Any High Risk is unauthorized, is made at your own risk and you shall be responsible for any and all losses, damage or claims arising out of any High-Risk Use.

Contents

Contents	3
About This User Guide	10
Purpose	10
Cross-references	10
Feedback	10
Important regulatory information	10
Complying with rules for the country of operation	10
Application firmware	12
Ethernet networking skills	12
Lightning protection	12
Specific expertise and training for professional installers	13
Legal and Open-Source Software statements	13
Problems and warranty	13
Reporting problems	13
Repair and service	13
Hardware warranty	13
Security advice	14
Warnings, cautions, and notes	14
Caring for the environment	14
In the UK and EU countries	15
In non-EU countries	15
Product Description	16
Introduction	16
Frequency bands	16
Characteristics	17
802.11ay Standards and advantages	18
Terragraph	20
Theory of operation	21

Overview of cnWave family	22
Features	23
Wireless operation	25
Wireless topology	25
Modulation	27
Synchronization	28
Time-division duplexing access mechanism	30
Wireless encryption	30
Designing wireless networks	30
TDD synchronization	31
System management	31
Management agent	31
Network management	31
IPv6	31
System logging	32
Software upgrade	32
System Hardware	33
Wireless nodes	33
V1000 Client Node (CN)	33
V2000 Client Node (CN)	34
V3000 Client Node (CN)	35
V5000 Distribution Node (DN)	36
Radio mounting brackets	37
Radio accessories	44
Radio external interfaces	46
Radio specifications	50
Power supply units (PSU)	51
PSU Options	51
V1000 - Power over Ethernet (PoE)	52
V2000 - PoE	53

V3000/V5000 - PoE	55
Ethernet and DC cables	62
Maximum cable lengths	62
Outdoor copper CAT6A Ethernet cable	64
Cable accessories	65
SFP Module kits	66
Optical cable and connectors	66
System Planning	69
Site planning	69
Grounding and lightning protection	69
Lightning protection zones	69
Site grounding system	70
ODU location	70
Drop cable grounding points	70
ODU wind loading	71
PSU DC power supply	72
PSU AC power supply	72
PSU location	72
Outdoor AC/DC PSU	72
Lightning Surge Protection Units (LPU)	73
Drop cable grounding points	73
Lightning Surge Protection Units location	73
Deployment Considerations	74
Key deployment guidelines	74
Sector and alignment	75
Minimum CN spacing	76
Near-far radio	77
Early weak interference	78
Avoiding the tight angle deployment	79
Avoiding the straight line interference	79

When two V5000 devices are co-located at a site	80
Polarity	81
Link Adaptation and Transmit Power Control (LATPC)	81
Radio spectrum planning	82
General wireless specifications	82
Regulatory limits	83
Link planning	83
LINKPlanner	83
Range and obstacles	83
Path loss	84
Planning for data networks	84
Point to Point-based single link Ethernet bridge	85
IPv4/L2 based PMP and mesh network planning	85
Support for dual networking (IPv4 and IPv6)	86
IPv6 Mode network planning	87
IPv6 Network design consideration	88
Reserved IPv6 address space	89
E2E and cnMaestro deployment consideration	89
Ethernet bridging	89
Layer 2 control protocols	91
Ethernet port allocation	91
IP Interface	92
Daisy-chaining 60 GHz links	92
Installation	93
Safety	93
Power lines	93
Working at heights	93
PSU	93
Grounding and protective earth	93
AC Supply	93

Powering down before servicing	93
Primary disconnect device	94
External cables	94
Drop cable tester	94
RF Exposure near the antenna	94
Minimum separation distances	94
Grounding and lightning protection requirements	94
Grounding cable installation methods	94
Siting radios	95
60 GHz cnWave radios and mounting bracket options	95
Installing the cnWave radio nodes	95
ODU Interface with LPU on the pole	100
Attach ground cables to the radio	104
Mounting the ODU	104
Connect to the PSU port of the radio	127
Using Power over Ethernet (PoE)	127
Using AC/DC PSU	131
Install the PSU	134
Installing the 60W DC power injector	135
Installing the AC/DC PSU	136
Installing 15W or 30W power injector	138
Connecting to the SFP+ optical module or SFP+ to the copper module to ODU	139
Removing the cable and SFP module	145
Configuring 60 GHz cnWave™	147
Nodes deployment	147
Connecting to the unit	147
Configuring the management PC	147
Connecting to the PC and powering up	149
Using the web interface	149
Logging into the web interface	149

Enabling internal E2E Controller	155
Topology	157
Configuration	162
Operation	199
Software upgrade	199
Diagnostics	200
Statistics	202
Links	202
Ethernet	206
GPS	207
Radio	208
Performance	210
Prefix zone Statistics	214
Border Gateway Protocol (BGP)	214
Maps	215
Tools	216
Factory reset	216
Field diags	216
Antenna alignment	217
Remote Command	225
Ping	229
Quick PTP setup	231
iPerf	232
cnMaestro support for Onboard Controller	234
Backup CN link	237
Auto Manage IPv6 Routes (External E2E Controller)	239
Unconnected PoPs	242
Regulatory Information	244
Compliance with safety standards	244
Electrical safety compliance	244

Human exposure to radio frequency energy	245
Compliance with radio regulations	247
Type approvals	248
Federal Communications Commission (FCC) compliance	248
Innovation, Science and Economic Development Canada (ISED) compliance	249
60 GHz cnWave example product labels	249
Troubleshooting	252
Field diagnostics logs	252
Setup issues in IPv4 tunneling	254
Link is not established	256
PoP not online from E2E or cnMaestro UI	259
Link is not coming up	259
Link does not come up after some configuration change	260
Link is not having expected throughput performance	260
Factory reset	260
Cambium Networks	262

About This User Guide

This document provides detailed information about the 60 GHz cnWave™ products, hardware, and supported features. The guide also explains how to deploy the product along with important safety measures. It is intended for system designers, system installers, and system administrators.

Purpose

The 60 GHz cnWave product documents are intended to instruct and assist personnel in operation, installation, and maintenance of the equipment and ancillary devices. It is recommended that all personnel engaged in such activities must be properly trained.

Cambium Networks disclaims all liability whatsoever, implied or express, for any risk of damage, loss or reduction in system performance arising directly or indirectly out of the failure of the customer, or anyone acting on the customer's behalf, to abide by the instructions, system parameters, or recommendations made in this document.

Cross-references

References to external publications are shown in italics. Other cross-references, emphasized in blue text in electronic versions, are active links to the references.

This document is divided into numbered chapters that are divided into sections. Sections are not numbered but are individually named at the top of each page, and are listed in the table of contents.

Feedback

We appreciate feedback from the users of our documents. This includes feedback on the structure, content, accuracy, or completeness of our documents. To provide feedback, visit our support website: <https://support.cambiumnetworks.com>.

Important regulatory information

Complying with rules for the country of operation

USA specific information



Caution

This device complies with Part 15 of the Federal Communications Commission (FCC) Rules. Operation is subject to the following two conditions:

- This device may not cause harmful interference, and
- This device must accept any interference received, including interference that may cause undesired operation.



Note

This equipment has been tested and found to comply with the limits for a Class B digital device, pursuant to part 15 of the FCC Rules. These limits are designed to provide reasonable protection against harmful interference in a residential installation. This equipment generates, uses and can radiate radio frequency energy and, if not installed and used in accordance with the instructions, may cause harmful interference to radio communications. However, there is no guarantee that interference will not occur in a particular installation. If this equipment does cause harmful interference to radio or television reception, which can be determined by turning the equipment off and on, the user is encouraged to try to correct the interference by one or more of the following measures:

- Reorient or relocate the receiving antenna.
- Increase the separation between the equipment and receiver.
- Connect the equipment into an outlet on a circuit different from that to which the receiver is connected.
- Consult the dealer or an experienced radio/TV technician for help.

Canada specific information



Caution

This device complies with Innovation, Science and Economic Development Canada (ISED) license-exempt RSSs. Operation is subject to the following two conditions:

- This device may not cause interference; and
- This device must accept any interference, including interference that may cause undesired operation of the device.

Renseignements spécifiques au Canada



Attention

Le présent appareil est conforme aux CNR d'Industrie Canada applicables aux appareils radio exempts de licence. L'exploitation est autorisée aux deux conditions suivantes :

- l'appareil ne doit pas produire de brouillage, et
- l'utilisateur de l'appareil doit accepter tout brouillage radioélectrique subi, même si le brouillage est susceptible d'en compromettre le fonctionnement.

European specific information

Cambium Networks 60 GHz cnWave products are compliant with applicable European Directives required for CE marking:

- 2014/53/EU of the European Parliament and of the Council of 16 April 2014 on the harmonisation of the laws of the Member States relating to the making available on the market of radio equipment and repealing Directive 1999/5/EC; Radio Equipment Directive (RED).

- 2011/65/EU of the European Parliament and of the Council of 8 June 2011 on the restriction of the use of certain hazardous substances in electrical and electronic equipment (RoHS Directive).

EU Declaration of conformity

Hereby, Cambium Networks declares that the Cambium Networks 60 GHz cnWave Series of Wireless Ethernet Bridge complies with the essential requirements and other relevant provisions of Directive 2014/53/EU. The declaration of conformity may be consulted at https://www.cambiumnetworks.com/eu_dofc.

United Kingdom (UK) specific information

Cambium Networks 60 GHz cnWave products are compliant with applicable United Kingdom (UK) Regulations required for UKCA marking:

- Radio Equipment Regulations 2017 (SI 2017 No. 1206, as amended)
- Restriction of the Use of Certain Hazardous Substances in Electrical and Electronic Equipment Regulations 2012 (SI 2012 No. 3032, as amended) (RoHS)

The 59-63.9 GHz frequency band is subject to specific exclusion zones. For more information, see the [59 - 63.9 GHz transmission exclusion zones](#) table.

UK Unmetered Supplies Operational Charge Codes:

- **V3000:** 8820022000100
- **V5000:** 8820029000100

For more details, check <https://www.elxon.co.uk/operations-settlement/unmetered-supplies/charge-codes-and-switch-regimes/>.

UK Declaration of conformity

Hereby, Cambium Networks declares that the Cambium Networks 60 GHz cnWave Series of Wireless Ethernet Bridge complies with the essential requirements and other relevant provisions of Radio Equipment Regulations 2017 (SI 2017 No. 1206, as amended) The declaration of conformity may be consulted at https://www.cambiumnetworks.com/ukca_dofc.

Application firmware

Download the latest 60 GHz products family software and install it in the Outdoor Units (ODUs) before deploying the equipment. Instructions for installing software are provided in this guide.

Ethernet networking skills

The installer must have the ability to configure IP addressing on a PC and to set up and control products using a web browser user interface (UI).

Lightning protection

To protect outdoor radio installations from the impact of lightning strikes, the installer must be familiar with the normal procedures for site selection, bonding and grounding. Installation guidelines for the 60 GHz platform of products are available in [System Hardware](#) and [System Planning](#) sections.

Specific expertise and training for professional installers

To ensure that the 60 GHz cnWave Series is installed and configured in compliance with the requirements of the EU, ISEDC and the FCC, installers must have the radio engineering skills and training described in this section.

The Cambium Networks technical training program details can be accessed from the following link: <https://learning.cambiumnetworks.com/>

Legal and Open-Source Software statements

Refer to the *60 GHz cnWave™ Legal and Open-Source Guide* for:

- Cambium Networks end user license agreement
- Open-Source Software Notices.

Problems and warranty

Reporting problems

If any problems are encountered when installing or operating this equipment, follow this procedure to investigate and report:

1. Search this document and the software release notes of supported releases.
2. Visit the support website (<http://www.cambiumnetworks.com/support>).
3. Ask for assistance from the Cambium Networks product supplier.
4. Gather information from affected units, such as any available diagnostic downloads.
5. Escalate the problem by emailing or telephoning support.

Repair and service

If unit failure is suspected, obtain details of the Return Material Authorization (RMA) process from the support website (<http://www.cambiumnetworks.com/support>).

Hardware warranty

Cambium's standard hardware warranty is for one (1) year from the date of shipment from Cambium Networks or a Cambium distributor. Cambium Networks warrants that hardware will conform to the relevant published specifications and will be free from material defects in material and workmanship under normal use and service. Cambium shall within this time, at its own option, either repair or replace the defective product within thirty (30) days of receipt of the defective product. Repaired or replaced products will be subject to the original warranty period but not less than thirty (30) days.

To register positioner products or activate warranties, visit the support website. For warranty assistance, contact the reseller or distributor. The removal of the tamper-evident seal will void the warranty.



Caution

Using non-Cambium parts for repair could damage the equipment or void warranty. Contact Cambium for service and repair instructions.

Portions of Cambium equipment may be damaged from exposure to electrostatic discharge. Use precautions to prevent damage.

Security advice

Cambium Networks systems and equipment provide security parameters that can be configured by the operator based on their particular operating environment. Cambium recommends setting and using these parameters following industry-recognized security practices. Security aspects to be considered are protecting the confidentiality, integrity, and availability of information and assets. Assets include the ability to communicate, information about the nature of the communications, and information about the parties involved.

In certain instances, Cambium makes specific recommendations regarding security practices, however the implementation of these recommendations and final responsibility for the security of the system lies with the operator of the system.

Warnings, cautions, and notes

The following describes how warnings and cautions are used in this document and all Cambium Networks document sets:

Warnings

Warnings precede instructions that contain potentially hazardous situations. Warnings are used to alert the reader to possible hazards that could cause loss of life or physical injury. A warning has the following format:



Warning

Warning text and consequence for not following the instructions in the warning.

Cautions

Cautions precede instructions and are used when there is a possibility of damage to systems, software, or individual items of equipment within a system. However, this damage presents no danger to personnel. A caution has the following format:



Caution

Caution text and consequence for not following the instructions in the caution.

Notes

A note means that there is a possibility of an undesirable situation or provides additional information to help the reader understand a topic or concept. A note has the following format:



Note

Note text.

Caring for the environment

The following information describes national or regional requirements for the disposal of Cambium Networks supplied equipment and for the approved disposal of surplus packaging.

In the UK and EU countries

The following information is provided to enable regulatory compliance with the European Union (EU) directives and UK regulations identified and any amendments made to these directives and regulations when using Cambium equipment in the UK or EU countries:

Disposal of Cambium equipment

European Union (EU) Directive 2012/19/EU Waste Electrical and Electronic Equipment (WEEE) and UK Statutory Instrument The Waste Electrical and Electronic Equipment Regulations 2013 No. 3113.

Do not dispose of Cambium equipment in landfill sites. For disposal instructions, refer to <http://www.cambiumnetworks.com/support/weee-compliance>

Disposal of surplus packaging

Do not dispose of surplus packaging in landfill sites. In the EU and UK, it is the individual recipient's responsibility to ensure that packaging materials are collected and recycled according to the requirements of EU and UK environmental law.

In non-EU countries

In non-EU countries, dispose of Cambium equipment and all surplus packaging in accordance with national and regional regulations.

Product Description

This section provides information about the 60 GHz cnWave product from Cambium Networks. It also describes its features, characteristics, and other related concepts.

Introduction

The 60 GHz cnWave products support a wide spectrum of up to 9 GHz (57-66 GHz) that is typically divided into channels of 2 GHz each. The 60 GHz band is largely uncongested when compared to 2.5 GHz and 5 GHz public bands, which are currently used for Wi-Fi. The 60 GHz band is an unlicensed millimeter-wave band that can provide massive speeds and throughput with Line of Sight (LoS) applications.

The 60 GHz band is located in the millimeter-wave (30 GHz to 300 GHz) portion of the electromagnetic spectrum.

The millimeter-wave portion of the RF spectrum has been largely unexploited for commercial wireless applications. 60 GHz wireless products enable two-way wireless communications at data rates that was previously achieved using fiber optic cables.

In addition to the high-data rates (accomplished in this spectrum), energy propagation in the 60 GHz band has benefits such as excellent immunity to interference, high security, and frequency reuse.

Frequency bands

The 60 GHz band is divided into 11 channels, each with a bandwidth of 2.16 GHz starting from **57.24** to **70.2 GHz**. Channels 1 to 6 support 2.16 GHz bandwidth and are defined in 802.11ad. Channels 9 to 13 support 4.32 GHz bandwidth and are added to 802.11ay.

Figure 1: Frequency bands

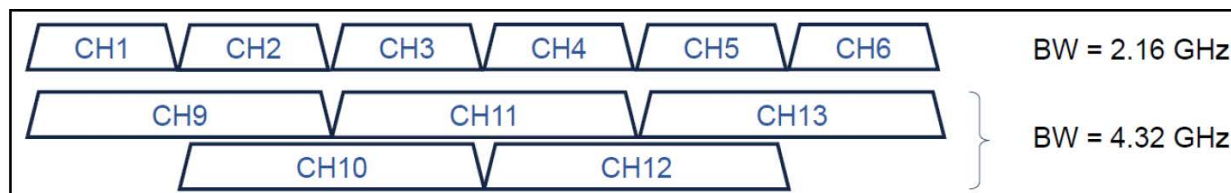

Table 1 lists the channels and the corresponding bandwidths supported by 60 GHz cnWave products:

Table 1: Channels and corresponding bandwidths

Channel	Bandwidth (GHz)	Center (GHz)	Minimum (GHz)	Maximum (GHz)
CH1	2.16	58.32	57.24	59.40
CH2	2.16	60.48	59.40	61.56
CH3	2.16	62.64	61.56	63.72
CH4	2.16	64.80	63.72	65.88
CH9	4.32	59.40	57.24	61.56
CH10	4.32	61.56	59.40	63.72
CH11	4.32	63.72	61.56	65.88

Characteristics

Following are the important characteristics of 60 GHz cnWave products:

- **High throughput capability**

With the multi-gigabit channel bandwidth, it is possible to gain multi-gigabit capacity. Based on 802.11ad, it is possible to get a 5 Gbps PHY rate. With 802.11ay, it is possible to get a 10 Gbps PHY rate. 60 GHz cnWave products are capable of providing 15 Gbps Ethernet rates with channel bonding enabled. For channel bonding (CB2), MCS13 is supported, and this has a PHY rate of 7.7 Gbps.

- **Unlicensed and interference free**

Typically, the V band is either an unlicensed or lightly licensed band, which is relatively a new band. This band has limited interference when compared to 2.4 and 5 GHz bands.

- **Line of Sight (LoS)**

60 GHz is affected by oxygen absorption, it varies throughout the band. The absorption gets reduced if the frequency gets increased. For example, the absorption is 15 dB/km in 60 GHz frequency, 5 dB/km in 64 GHz, and 0.5 dB/km in 68 GHz. If the total channel is divided into 6 channels, then the mid-channel that is channels 2 and 3 has more absorption loss. From channel 4, the absorption level starts to drop. So only Line of Sight links are available and Near LoS or non LoS links do not work with 60 GHz.

Figure 2: Line of Sight

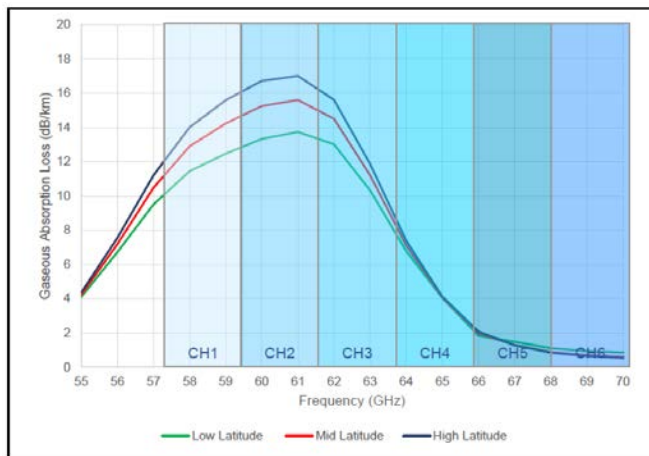

- **Rain fade**

You can view significant rain fade for 60 GHz links, particularly those pushing the longer distances. Attenuation depends on the rain rate which must be factored in while planning the network. Rain attenuation depends on the level of the rain. The following table describes the rain level and absorption loss.

Table 2: Rain and attenuation

Rain	Attenuation
Drizzle (0.25 mm/hr)	0.2 dB/km
Light Rain (2.5 mm/hr)	1.8 dB/km
Medium Rain (12.5 mm/hr)	5.6 dB/km
Heavy Rain (25 mm/hr)	9.5 dB/km
Downpour (50 mm/hr)	17 dB/km
Tropical (100 mm/hr)	28 dB/km
Monsoon (200 mm/hr)	38 dB/km

The following figure shows the absorption loss due to the rain level (seasons):

Figure 3: Variation in Loss/km with frequency and rain rate

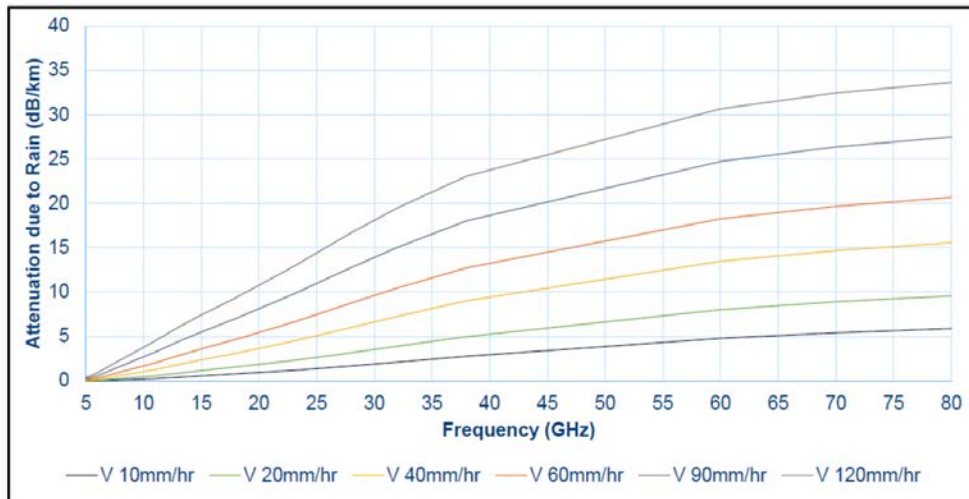

Drizzle - 0.25 mm/hr; Light rain - 2.5 mm/hr; Medium rain - 12.5 mm/hr; Heavy rain - 25 mm/hr.

- **Short range**

The range of a 60 GHz cnWave link can be limited due to oxygen absorption and rain fade which needs to be factored in for link planning. One advantage of a shorter range is the frequent reusability and security (as the signal does not travel long distances).

802.11ay Standards and advantages

IEEE 802.11ay is an IEEE standard that covers 60 GHz cnWave, this standard is an amendment of the IEEE 802.11ad standard. There are IEEE 802.11ay is designed with a higher throughput capacity of over 10 Gbps data rate over distances of 200 to 500 meters. 802.11ay includes features such as Channel Bonding and Synchronization. 802.11ay based 60 GHz solution transforms fixed wireless access from a broadband option of last resort into a competitive alternative to fiber and cable-based solution.

This standard is designed with a throughput capacity of over 10 Gbps data rate over distances of 200 to 500 meters. 802.11ay includes features such as **Channel Bonding** and **Synchronization**. 802.11ay is WLAN type in the IEEE 802.11. It has a frequency of 60 GHz. It has also been noted that it is likely to have

mechanisms for channel bonding and MU-MIMO technologies. 802.11ad uses a maximum of 2.16 GHz bandwidth, whereas 802.11ay bonds four of those channels together for a maximum bandwidth of 8.64 GHz.

802.11ay standard has the following advantages with the Terragraph solution:

- **Channel Bonding**

802.11ay standard has channel bonding capability to combine adjacent channels to form wider channels, in this case, wider channels combine to form 4.32 GHz, there are additional wider channels created which provide double capacity throughput compared to the 802.11ad standard.

- **Network Synchronization**

Synchronization is used to control the transmit and receive signals to prevent self-interference. Radios assigned with the same polarity will be transmitting and receiving at the same time.

There are four types of polarity:

- Odd Polarity
- Even Polarity
- Hybrid odd Polarity
- Hybrid Even Polarity

- **Mesh Routing**

Mesh is an interconnection of devices that can have multiple paths between any two nodes, some advantages of using mesh are better connectivity, capacity sharing, load balancing, and re-routing in case of link failure.

- **Increased capacity**

802.11ay supports Channel Bonding which allows two immediate channels to be merged into a single wide-band channel, thereby doubling the channel bandwidth to 4.32 GHz.

- **Supports a greater number of client nodes**

802.11ay supports 15 client nodes per sector.

Advantages

- **802.11ay product, Terragraph certified**

The 60 GHz cnWave is an 802.11ay product and Terragraph certified.

- **Highest capacity**

It has highest the capacity in the industry, up to 5.4 Gbps per sector.

- **Low total cost ownership**

- cnWave V5000 is 280-degree coverage with dual-sector. Installation is simple, uses beam forming for installation. No need for a site router.

- cnWave V1000, V2000, and V3000 meet various range challenges.
 - Using beam forming, the V3000 has a super long range.
 - cnMaestro panel is used for device management.
 - cnHeat and LINKPlanner help for easy planning.
- **Unlicensed and interference-free**
This spectrum spans 57 - 66 GHz and is widely available, especially when compared to the 2.4 and 5 GHz bands. This 9 GHz of the spectrum can be divided up into channels ranging between 1 and 2 GHz wide.
 - **Massive throughput**
This band can allow over 10 Gbps of throughput from some products on the market today.

Terragraph

Terragraph is a connectivity solution from Facebook. The mission of Terragraph is to bring more people online to a faster internet. It is freely licensed technology that is designed to deliver cost-effective and reliable fiber like connectivity over a wireless mesh network (as shown in [Figure 4](#)).

Figure 4: Terra graph

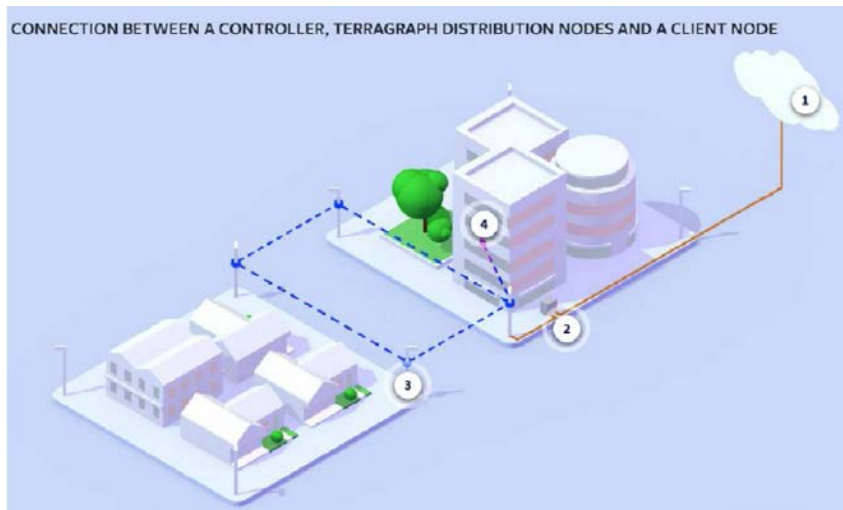

- 1- Controller
- 2- PoP (Fiber, RF)
- 3- Distribution Node
- 4- Client Node

Key components

Terragraph contains the following key components:

- **Distribution Node (DN)** - DN connects with other DN to form a mesh in a distribution network.
- **Client Node (CN)** - CN is a customer premise radio that connects with a DN node to provide high-speed connectivity.
- **E2E Controller** - The E2E Controller allows for configuration, control, and monitoring of the nodes and network. Cambium Networks supports two methods to utilize the E2E Controller:
 - On-Premises installed as a VM and can be used for small or large deployment (limited to 500 nodes).
 - Onboard the PoP, for PTP, PMP, and small mesh networks the PoP can be configured to host the controller (limited to 31 nodes).

Features

The following are the features of Terragraph:

- **802.11ay** - Delivers multi-gigabit speeds over wide frequency bands.
- **Mesh** - Efficiently distributes capacity and improves availability, using Open/R.
- **Efficient MAC and PHY** - Scheduled MAC (TDD / TDMA) for scalability and dense deployments.
- **Cloud management** - Used for configuration, management, visualization, alarms, and monitoring.
- **Network planning** - Automated design and optimization using imagery, population, and optionally other data sources.

Responsibilities

The Terragraph software initializes and configures radios (DN and CN). It tracks and optimizes meshed routing paths. It also monitors and maintains Syslog, alarms, and Firmware upgrades.

Theory of operation

The 60 GHz cnWave devices support Facebook connectivity technology called **Terragraph**. cnWave devices implement IEEE 802.11ay WLAN standard and use 60GHz frequency band for wider spectrum and higher capacity. cnWave devices can provide multi-gigabit throughput from 100 M to 1.5 KM.

Deployment of the devices uses Open/R based layer3/IPv6 mesh for efficient distribution of traffic between the nodes and higher availability of the traffic. This also overcomes non-line of sight issues.

Devices use TDMA/TDD technology to achieve density deployment efficiency. Network and the nodes are configured, controlled, and monitored by a cloud-based E2E Controller.

Following terminologies are used for the network deployment:

- **Distribution Node (DN)** - DN connects with other DN for mesh network
- **Client Node (CN)** - CN connects to DN to provide high-speed connectivity

- **PoP** - DN connected to the back-haul
- **CPE** - Customer premises equipment devices like Wi-Fi router

Figure 5: Deployment scenario

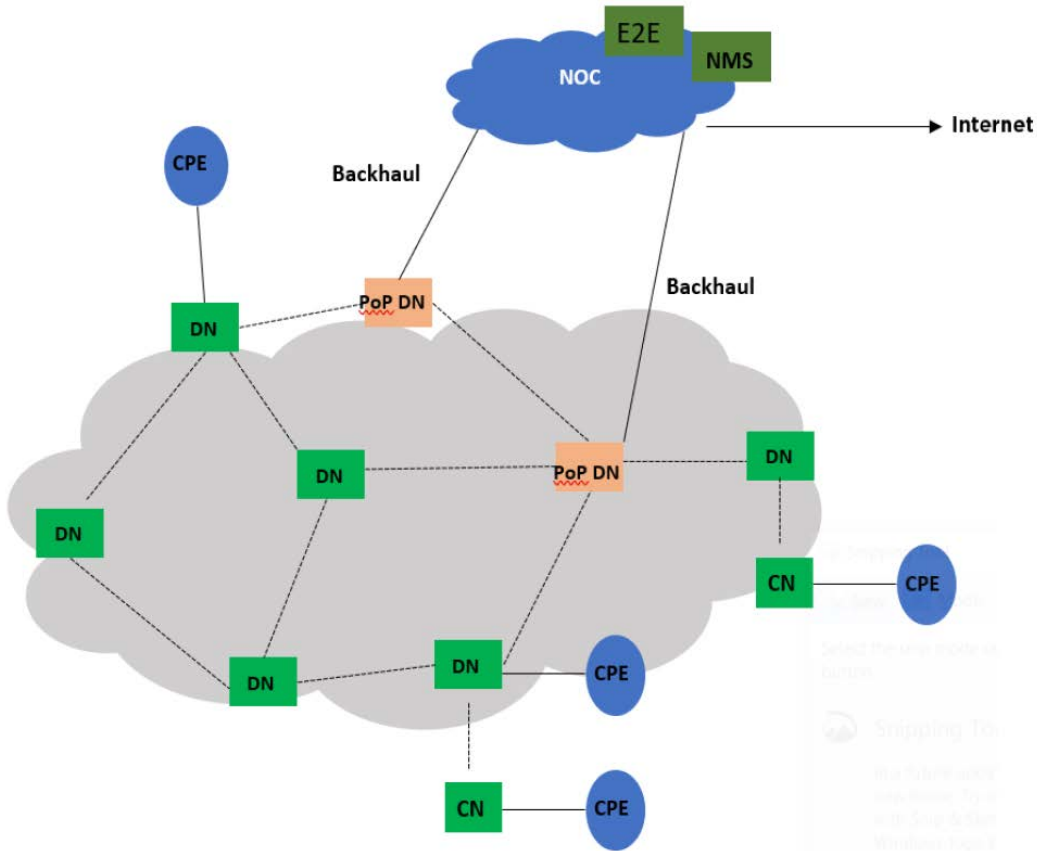

Overview of cnWave family

The 60 GHz cnWave solution (from Cambium Networks) provides easy, fast, and cost-effective wireless Gigabit connectivity for edge access and/or high-capacity backhaul for edge access solutions at a significantly lower cost than fiber infrastructure. Service providers and enterprises now have access to Gigabit for business and residential connectivity, backhaul for Wi-Fi access. Certified for Facebook Terragraph, 60 GHz cnWave Mesh solutions are highly efficient at handling high-density deployments in cities and suburban areas.

The 60 GHz solution consists of a Distribution Node (DN), which acts as an Access Point (AP), and a Client Node (CN) that acts as a cnWave client.

60 GHz cnWave consists of the following **four variants** (as shown in Figure 6):

- **V1000** : A **Client Node (CN)** that contains a wide-range, 80 degrees beamforming for easy installation. This CN is powered by 802.3af PoE and supports up to 2 Gbps for PTP and PMP configurations.

- **V2000:** A **CN** that contains a 34.5 dBi antenna with beamforming. This client node can support up to 3.6 Gbps for PTP and PMP configurations.
- **V3000:** A **Client Node (CN)** is available in two sizes - 44.5 dBi high-gain antenna and 40.5 dBi lower gain antenna, both with beamforming. These client nodes can support up to 5.4 Gbps, with channel bonding for PTP configurations.
- **V5000:** A **dual-sector Distribution Node (DN)** that contains two sectors covering up to 280 degrees with beamforming. A single V5000 can connect up to four other distribution nodes or up to 30 client nodes. V5000 can be used for PTP, PMP, and Mesh configurations.

Figure 6: 60 GHz cnWave products



Features

This section lists the features of each product of 60 GHz cnWave.

V1000 CN

- Supports modulations BPSK to 16 QAM (MCS1 to MCS12)
- Integrated antenna with beam forming
- 38 dBm EIRP
- Gigabit Ethernet
- 1 Gbps UL/1 Gbps DL throughput
- Powered by passive PoE or 802.3af/at PoE
- IP66/67

V2000 CN

- Supports modulations BPSK to 16 QAM (MCS1 to MCS12)
- 34.5 dBi ultra-high gain antenna with beam forming, peak 49 dBm EIRP
- 2.5 Gigabit Ethernet Main interface
- 2.5 Gigabit Ethernet Auxiliary (Aux) interface

- 1.8 Gbps UL or 1.8 Gbps DL throughput
- 802.3at POE (2-pair or 4-pair for higher wattage) or a Passive PoE
- Supports Aux PoE out (802.3af/at PoE)
- IP66/67

V3000 CN

- Supports modulations BPSK to 16 QAM (MCS1 to MCS12)
- 44.5 dBi ultra-high gain antenna with beam forming 60.5 dBm EIRP
- 40.5 dBi ultra-high gain antenna with beam forming 54.5 dBm EIRP
- 10 Gigabit Ethernet
- Supports 10G SFP+ or 1G SFP
- 1.8 Gbps UL/1.8 Gbps DL throughput
- CB2 2.7 Gbps UL / 2.7 Gbps DL
- Gigabit Ethernet Auxiliary Interface
- 802.3at POE (2-pair or 4-pair for higher wattage) or a Passive POE
- Supports Aux PoE out (802.3af/at PoE)
- IP66/67

V5000 DN

- Supports modulations BPSK to 16QAM (MCS1 to MCS12)
- Dual sector - 280-degree antenna with beamforming
- 38 dBm EIRP
- 10 Gigabit Ethernet
- Supports 10G SFP or 1G SFP
- 1.8 Gbps UL/1.8 Gbps DL throughput per sector
- Gigabit Ethernet Auxiliary Interface
- 802.3at POE (2-pair or 4-pair for higher wattage) or a Passive POE
- Supports Aux PoE out (802.3af/at PoE)
- IP 66/67

Wireless operation

This section describes how the 60 GHz cnWave is operated, including topology, modulation modes, power control, and security.

Wireless topology

60 GHz cnWave supports operation in three topologies:

- [Point to point \(PTP\)](#)
- [Point to Multipoint \(PMP\)](#)
- [Mesh](#)

PTP

The PTP topology provides a point-to-point link using V1000, V2000, and V3000.

Figure 7: PTP Topology

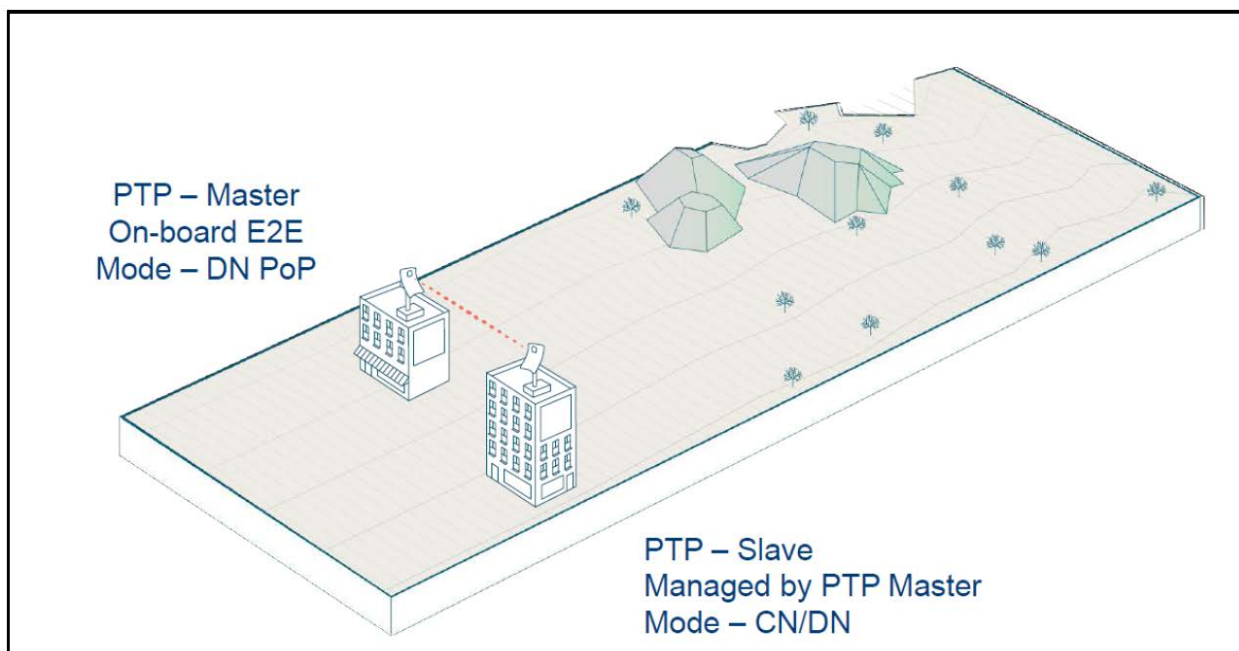

PMP

The PMP topology provides a point to multi-point where a V5000 acts as a PoP DN and V5000, V3000, V2000, V1000 act as Clients.

Figure 8: PMP Topology

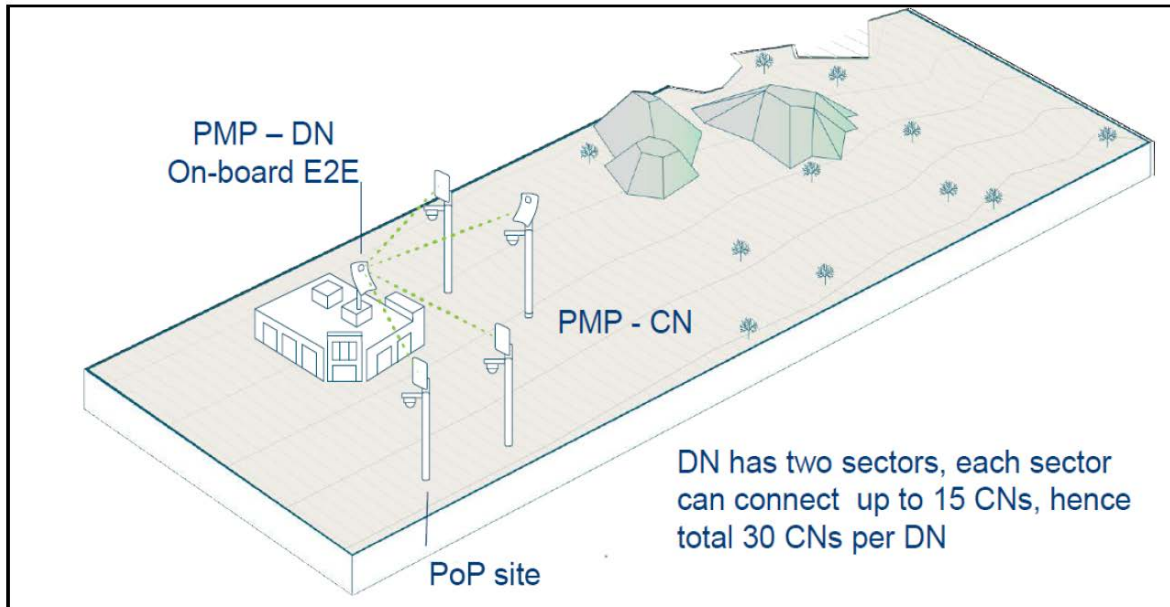

Mesh

Mesh efficiently distributes capacity and improves availability, using Open/R based layer 3 IPv6 meshing. It allows for route diversity which provides high network availability and supports up to 15 hops away from a PoP node. Network bandwidth is reduced at each hop, and the total bandwidth available in the network is limited to a PoP node's network reappearance. Mesh is a distributed network application platform that determines appropriate routes between the mesh nodes.

Figure 9: Mesh topology

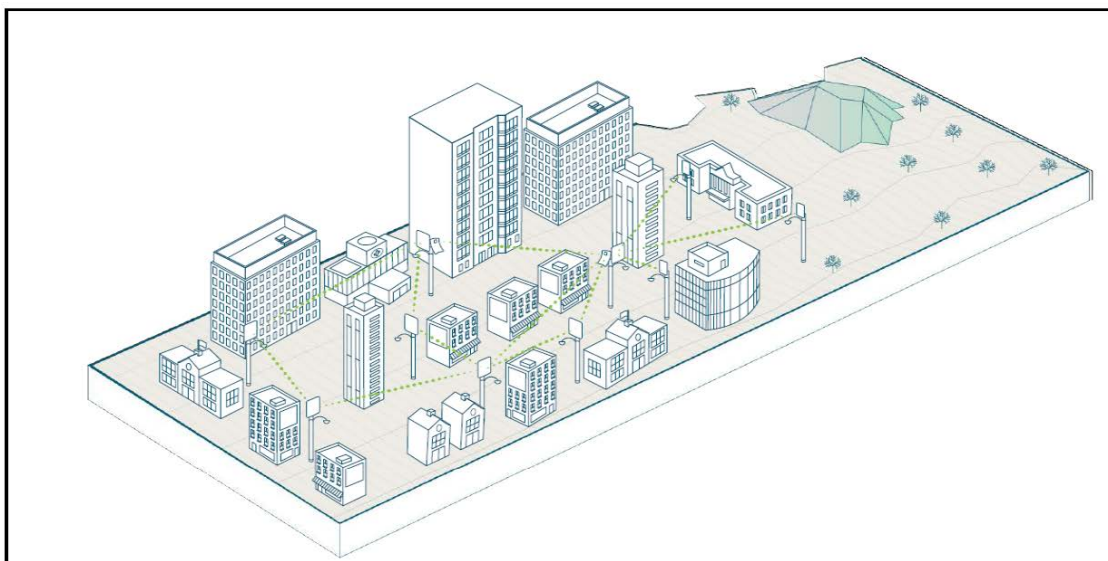

Modulation

Following tables list modulation supported during L2 and L3 throughput:

Table 3: Modulation and coding rate for CB1

MCS	Modulation	Coding Rate	L2 Throughput (Mb/s) DMG-CB1 (2.16 GHz Channel)
2	$\pi/2$ BPSK	1/2	572
3	$\pi/2$ BPSK	5/8	800
4	$\pi/2$ BPSK	3/4	914
6	$\pi/2$ QPSK	1/2	1256
7	$\pi/2$ QPSK	5/8	1600
8	$\pi/2$ QPSK	3/4	1828
9	$\pi/2$ QPSK	13/16	1942
10	$\pi/2$ 16QAM	1/2	2400
11	$\pi/2$ 16QAM	5/8	3200
12	$\pi/2$ 16QAM	3/4	3656

Table 4: Modulation and coding rate for CB2

MCS	Modulation	Coding Rate	L2 Throughput (Mb/s) EDMG-CB2 (4.32 GHz Channel)
2	$\pi/2$ BPSK	1/2	1244
3	$\pi/2$ BPSK	5/8	1524
4	$\pi/2$ BPSK	3/4	1750
5	$\pi/2$ BPSK	13/16	1792
7	$\pi/2$ QPSK	1/2	2280
8	$\pi/2$ QPSK	5/8	2740
9	$\pi/2$ QPSK	3/4	3480
10	$\pi/2$ QPSK	13/16	3800
11	$\pi/2$ QPSK	7/8	4260
12	$\pi/2$ 16QAM	1/2	5000
13	$\pi/2$ 16QAM	5/8	5420

Link adaptation

Link adaptation is performed independently for each link for data traffic, and it is closed-loop based. Adjusting the Tx modulation and coding scheme from MCS2 to MCS12 selected for transmission. It is adjusted based on the following:

- Packet Error Ratio (PER),
- SNR,
- local measurements of successful and unsuccessful frame transmissions (for example, count of frames Acknowledged (ACKed) or Not ACKed).

Figure 10: Adjusting links

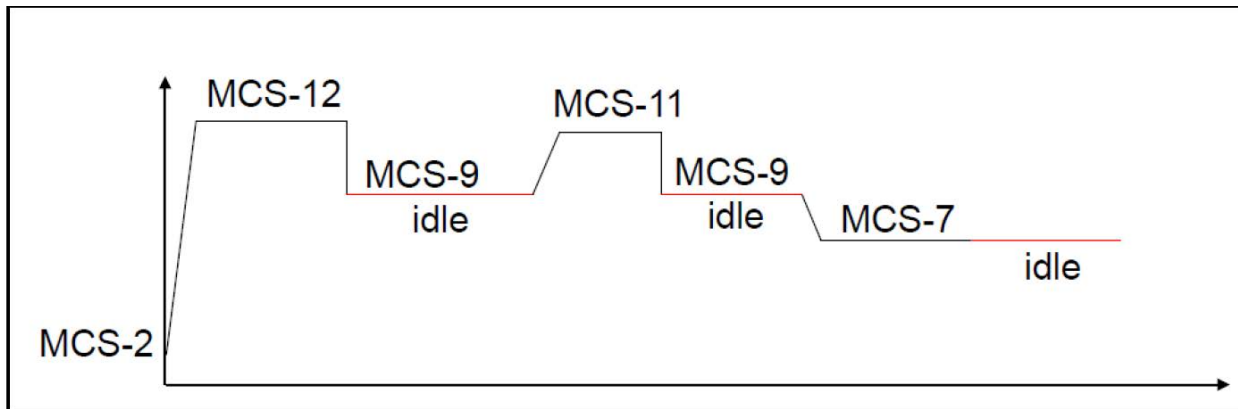

Start from MCS2, adjust based on signal quality, when the session is idle, fall back to MCS-9 or any highest MCS achieved below MCS-9.

Synchronization

Synchronization is used to control the transmit and receive signals to prevent self-interference. Radios assigned with the same polarity will be transmitting and receiving at the same time. There are two types of polarities:

- Odd (if Odd nodes are Tx)
- Even (if Even nodes are Rx)

Figure 11: Odd and even polarities

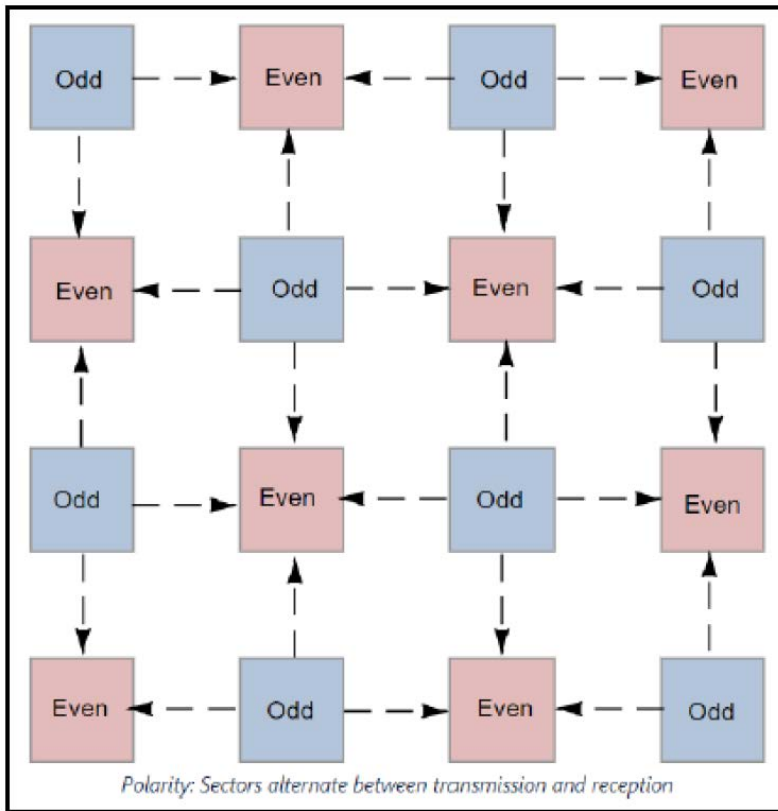

The MAC synchronizes its timers to an external, accurate time source, such as GPS or IEEE 1588. A timing pulse that resets the Timing Synchronization Function (TSF) on the DN is repeated once every second. This timing pulse occurs exactly at the turn of each second.

Figure 12: The MAC synchronization

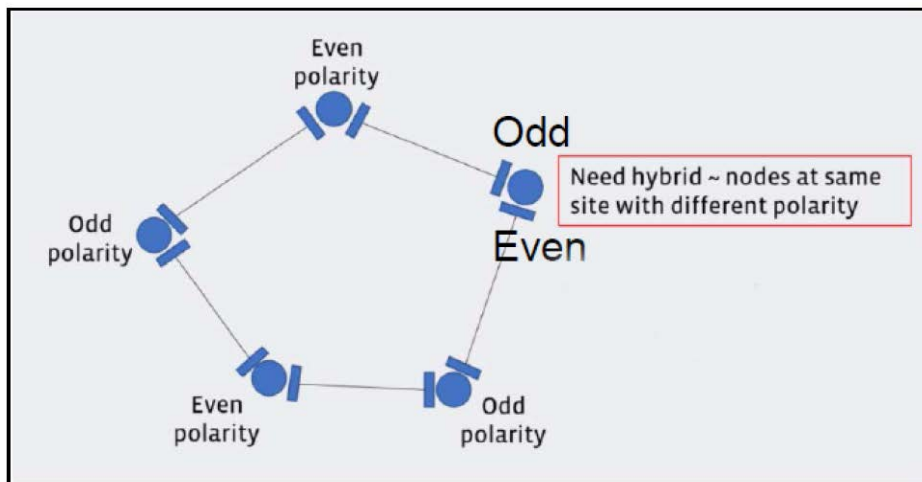

Time-division duplexing access mechanism

60 GHz cnWave uses a Time Division Duplex (TDD) channel access mechanism. All cnWave nodes are time-synchronized and this is achieved through internal GPS, IEEE 1588(roadmap), or Cambium Sync (roadmap), and each sector of a node is assigned specific times during which it can transmit or receive. A timing pulse that resets the Timing Synchronization Function (TSF) on the DN is repeated once every second (1PPS). This timing pulse occurs exactly at the turn of each second and Sub-Frames begins every 200 microseconds.

General operation of MAC layer

MAC is highly modified from that in IEEE 802.11-2016. Use TDD MAC by substituting TDD access for all other access. 60 GHz cnWave supports a fixed 50-50 up/down ratio.

60 GHz cnWave uses only the following frames:

- Data
- QoS-Null (frame does not carry any data)
- Management Action (for example, beam-forming, and others.)
- Block ACK (used for sending an ACK to multiple nodes/packets at once)
- ACK

Frame types

Below are the types of frames in 60 GHz cnWave:

- **Management frames** - A node sends all management frames using the DMG control mode PHY, MCS 0.
- **Control frames** - A node sends the ACK frame using the DMG control mode PHY, MCS 0. A node sends the Block ACK frame using the DMG single carrier PHY, MCS 1.
- **Data frames** - A node sends data frames using MCS 2 through MCS 12 of the DMG single carrier PHY, as determined by the link adaptation algorithm.

Wireless encryption

60 GHz cnWave supports an optional encryption, for data transmitted over the wireless link, using the following options:

- Disabled wireless encryption (which is disabled).
- Pre-Shared Key (PSK) is set, where a pre-configured secret at both ends is configured. The derivation of shared secret is based on WPA2.
- With a configured Radius server IP, cnWave nodes do EAP-TLS using X.509 certificates.

Designing wireless networks

For designing wireless networks, refer to [LINKPlanner](#).

TDD synchronization

V2000, V3000, and V5000 have built-in GPS receivers. The E2E Controller manages the TDD synchronization.

System management

This section introduces the 60 GHz cnWave management system, including the web interface, installation, configuration, alerts, and upgrades.

Management agent

The 60 GHz cnWave equipment is managed through an embedded management agent. Management workstations, network management systems, or PCs can be connected to this agent using a choice of in-band or out-of-band network management modes.

The management agent includes an IPv4/IPv6 interface at the management agent. The IP interface operates in the following modes:

- IPv4 only
- IPv6 only
- Dual IPv4/IPv6

Network management

cnMaestro is a Cambium Network Management System (NMS). This is a single plane to manage the complete Cambium product portfolio. It uses secure WebSocket for management traffic to manage all Cambium products on the same system. Configurations can be pushed from the cnMaestro through the E2E Controller to the end devices.

cnMaestro NMS is used to:

- Manage cnWave network including E2E, CN, and DN.
- Show the connection topologies.
- Collect KPIs/statistics, alarms, logs (via the E2E device agent).
- Perform software upgrade.

IPv6

IPv6 address is 128 bits (16 Bytes) address. The subnet ID in IPv4 is called a prefix in IPv6. In IPv6, Neighbor Discovery Protocol (NDP) is used with ICMPv6 to resolve the MAC address. IPV6 does not have broadcast but only has multicast.

60 GHz cnWave products get assigned with a unique IP in mesh, either from Controller (CPA) or PoP (DPA), known as loopback address (lo). In Layer 3 mode, nodes can also send Router Advertisement(RA) for all its downstream devices to acquire an IPv6 address. Prefix for RA can either be configured or device from lo.

System logging

For information on logging into the system using user interface (UI), refer to [Logging into the web interface](#).

Software upgrade

Refer to [Software upgrade](#) for more information.

System Hardware

This topic provides information about the hardware of 60 GHz cnWave.

Wireless nodes

The 60 GHz cnWave solution includes three types of wireless nodes:

- V1000 Client Node
- V2000 Client Node
- V3000 (44.5 dBi and 40.5 dBi) Client Node
- V5000 Distribution Node

V1000 Client Node (CN)

V1000 is an outdoor CN that can be connected to a distribution node wirelessly. V1000 supports a Gigabit Ethernet interface and is powered by 802.3af/at PoE compliant power supply or a passive PoE.

Figure 13: V1000 CN's front and rear views



V1000 CN - Part numbers

Order the V1000 CN from Cambium Networks (as listed in [Table 5](#)). Each V1000 CN is supplied with a mounting bracket for wall mount or pole mount, and an indoor power supply.

Table 5: V1000 CN part numbers

Product description	Part number
60GHz cnWave V1000 Client Node with US cord	C600500C001A
60GHz cnWave V1000 Client Node with EU cord	C600500C003A

Product description	Part number
60GHz cnWave V1000 Client Node with UK Cord	C600500C004A
60GHz cnWave V1000 Client Node with ANZ Cord	C600500C008A
60GHz cnWave V1000 Client Node with Brazil Cord	C600500C009A
60GHz cnWave V1000 Client Node with Argentina Cord	C600500C010A
60GHz cnWave V1000 Client Node with China Cord	C600500C011A
60GHz cnWave V1000 Client Node with South Africa Cord	C600500C012A
60GHz cnWave V1000 Client Node with India Cord	C600500C013A
60GHz cnWave V1000 Client Node with no Cord	C600500C014A
60GHz cnWave V1000 Client Node with Israel cord - for Israel Only	C600500C016A
60GHz cnWave V1000 Client Node with no Cord and no Power supply	C600500C017A

V2000 Client Node (CN)

V2000 is an outdoor CN that can be connected to a DN. This CN can also act as a DN for PTP deployments. It supports a 2.5 Gigabit Ethernet Main interface and 2.5 Gigabit Ethernet Auxiliary (Aux) interface. The V2000 CN can support a single wireless link and therefore, it can be used as a CN in all topologies or POP in a PTP topology.

A V2000 CN can be powered using 30W passive POE or using 802.3at compliant POE switch. For more information about the supported power supply and cable lengths, refer to the [Power supply units \(PSU\)](#) section. A V2000 CN can also power 802.3af/at compliant auxiliary device through the Aux Ethernet interface. For more information about Aux PoE interface, refer to the [Aux PoE - Powering options](#) section.

Figure 14: V2000 CN's front and rear views



V2000 CN - Part numbers

Order the V2000 CN from Cambium Networks (as listed in [Table 6](#)). A V2000 CN radio is supplied without a mounting bracket and with or without power supply.

Table 6: V2000 CN part numbers

Product description	Part number
60GHz cnWave V2000 Client Node 30W with Israel Cord	C600500C026B
60GHz cnWave V2000 Client Node 30W with South Africa Cord	C600500C027B
60GHz cnWave V2000 Client Node 30W with India Cord	C600500C028B
60GHz cnWave V2000 Client Node 30W with no Cord	C600500C029B
60GHz cnWave V2000 Client Node no power supply, no power cord	C600500C030B
60GHz cnWave V2000 Client Node 30W with US cord	C600500C020B
60GHz cnWave V2000 Client Node 30W with EU cord	C600500C031B
60GHz cnWave V2000 Client Node 30W with UK Cord	C600500C032B
60GHz cnWave V2000 Client Node 30W with ANZ Cord	C600500C033B
60GHz cnWave V2000 Client Node 30W with Brazil Cord	C600500C034B
60GHz cnWave V2000 Client Node 30W with Argentina Cord	C600500C035B

V3000 Client Node (CN)

V3000 is an outdoor CN that can be connected (wireless) to a DN or another V3000 DN. V3000 supports a 10 Gigabit Ethernet interface, a 10G SFP+ interface port, and a Gigabit Ethernet Aux interface.

V3000 can be powered using 60W passive POE or using an AC/DC PSU through a mini adapter (for more information, refer to the power supply and cable lengths supported in the [Power supply units](#) section). V3000 DN can also power 802.3af/at compliant auxiliary device through the Gigabit Aux interface.

For more information about Aux PoE interface, refer to the [Aux PoE - Powering options](#) section.

Figure 15: V3000 Client Node without antenna assembly and with 44.5 dBi and 40.5 dBi antenna assemblies



V3000 Part numbers

Order the V3000 CN from Cambium Networks ([V3000 CN part numbers](#)). The V3000 CN radio is supplied without an antenna assembly, bracket, or power supply. Refer to the [Precision brackets](#) section for details of suitable brackets.



Note

Use a dedicated antenna assembly for V3000 CN.
Order the antenna assembly required for each CN radio.

Table 7: V3000 CN part numbers

Cambium description	Cambium part number
60 GHz cnWave V3000 CN radio only	C600500C024A
60 GHz cnWave V3000 CN antenna assembly, 44.5 dBi	C600500D001A
60 GHz cnWave V3000 CN antenna assembly, 40.5 dBi, 4 Pack	C600500D002A
60 GHz cnWave V3000 CN antenna assembly, 44.5 dBi, 4 Pack	C600500D003A
60 GHz cnWave V3000 CN Radio only - Israel Only	C600500C025A

V5000 Distribution Node (DN)

V5000 is an outdoor DN that can be connected to multiple V1000 or V3000 CNs wirelessly. V5000 supports a 10 Gigabit Ethernet interface, a 10G SFP+ interface port, and a Gigabit Ethernet Aux interface.

V5000 can be powered using 60W passive POE or using an AC/DC PSU through mini an adapter (for more information, refer to the power supply and cable lengths supported in the [Power supply units](#) section). V5000 DN can also power 802.3af/at compliant auxiliary device through the Gigabit Aux interface.

For more information about Aux PoE interface, refer to the [Aux PoE - Powering options](#) section.

Figure 16: V5000 Distribution Node front and rear views



V5000 Part numbers

Order the V5000 Distribution Node (DN) from Cambium Networks (as shown in below table). The V5000 DN is supplied without a mounting bracket or power supply.

Table 8: V5000 DN part numbers

Cambium description	Cambium part number
60GHz cnWave V5000 Distribution Node	C600500A004B
60GHz cnWave V5000 Distribution Node - Israel Only	C600500A005B

Radio mounting brackets

V1000 Wall and pole mount

The V1000 CN is supplied with a mounting plate and a band clamp. The mounting plate can be used for mounting the V1000 on a wall, or it can be used with the supplied band clamp to mount the V1000 on a pole with a diameter in the range of 25 mm to 70 mm (1 inch to 2.75 inches). Note that the larger diameters can be accommodated with the customer supplied clamps.

Figure 17: V1000 mounting plate and band clamp



V1000 Adjustable pole mount (N000900L022A)

The adjustable pole mount is used to provide elevation adjustment when a V1000 CN is mounted on a pole. The adjustable pole mount works with poles with diameters in the range of 25 mm to 70 mm (1 inch to 2.75 inches).



Note

The adjustable pole mount does not come with a clamp. You can use the one that is supplied with the V1000 box. Larger diameter poles can be accommodated with the customer supplied clamps.

Figure 18: V1000 adjustable pole mount



V2000 Adjustable pole mount

The V2000 CN is supplied with adjustable pole mounting accessories such as mounting plate, a hose clamp, and four screws (as shown in [Figure 19](#)). These mounting accessories can be used to mount the V2000 CN on a vertical pole.

[Figure 19](#): V2000 and pole mounting accessories



The adjustable pole mount bracket (as shown in [Figure 20](#)) is used to mount the V2000 CN on a vertical pole with a diameter in the range of 25 mm to 70 mm (1 inch to 2.75 inches). The bracket provides a fine adjustment of up to $\pm 20^\circ$ in elevation for accurate alignment of V2000.

Figure 20: V2000 Adjustable pole mount



V3000 Precision bracket (C000000L125A)

The precision bracket (as shown in [Figure 21](#)) is used to mount the V3000 CN on a vertical pole with a diameter in the range of 25 mm to 70 mm (1 inch to 2.75 inches). It accepts band clamps for larger diameter poles.

The precision bracket provides fine adjustment of up to 18° in azimuth and +/-30° in elevation for accurate alignment of the V3000.

Figure 21: Precision bracket

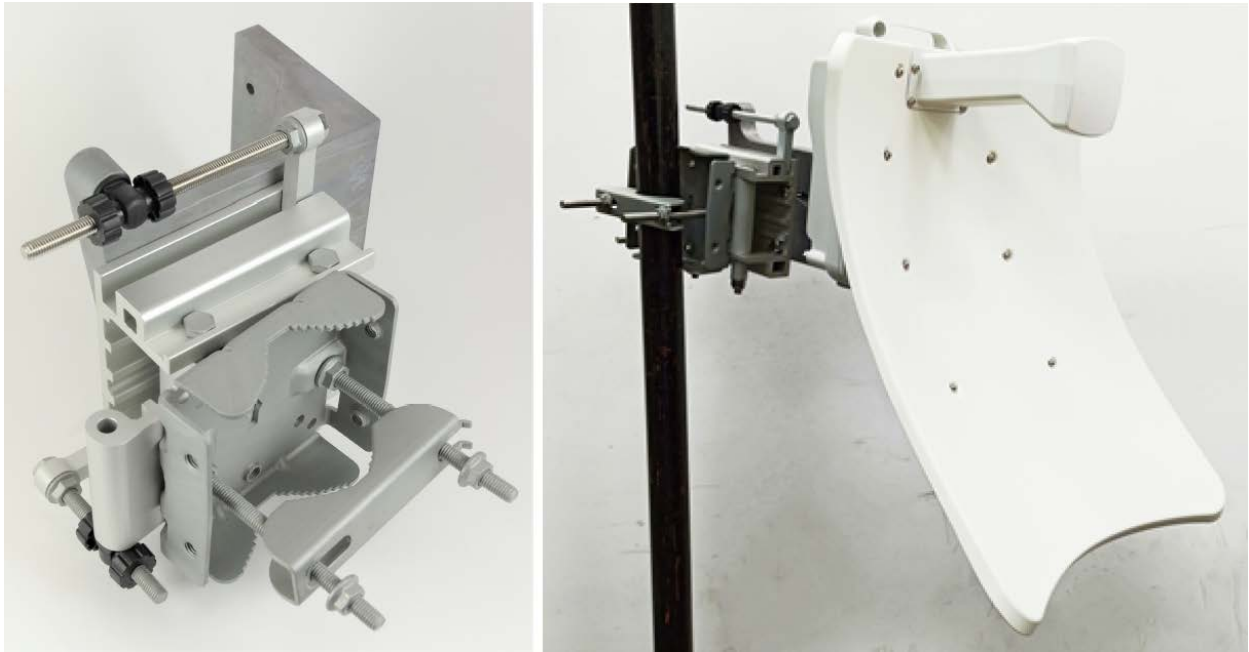
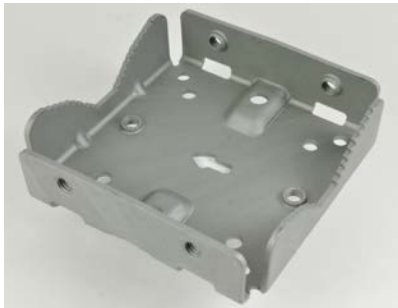

Figure 22: Precision bracket components



Bracket body



Azimuth arm



Long (120 mm) M8 screws and flange nuts



Bracket base



40 mm M8 screws, plain washers, and Nyloc nuts



V3000 mount



28 mm M6 screws, M8 spacers, and pole mount clamp

V3000 Tilt bracket (N000045L002A)

The tilt bracket (as shown in [Figure 23](#)) is used to provide elevation adjustment when a V3000 CN or V5000 DN is mounted on a pole. The tilt bracket works with poles with diameters in the range of 25 mm to 70 mm (1 inch to 2.75 inches).

The tilt bracket assembly may be used with third-party band clamps to mount the ODU on a larger pole (the diameter range depends on the clamps used).

[Figure 23](#): Tilt bracket assembly



V5000 Pole mount (C000000L137A)

The pole mount (as shown in [Figure 24](#)) is used to mount a V5000 DN on a vertical pole with a diameter in the range of 25 mm to 70 mm (1 inch to 2.75 inches). It provides coarse azimuth (but not elevation) adjustment. Band clamps can be used for V5000 pole mount to accommodate the larger diameter poles.

Figure 24: Pole mount



V5000 Wall mount (C000000L136A)

The wall mount ([Wall mount](#) figure below) is used to mount a V5000 DN on a vertical wall. It does not provide azimuth or elevation adjustment. The wall mount requires additional fixing hardware suitable for the type of wall.

Figure 25: Wall mount

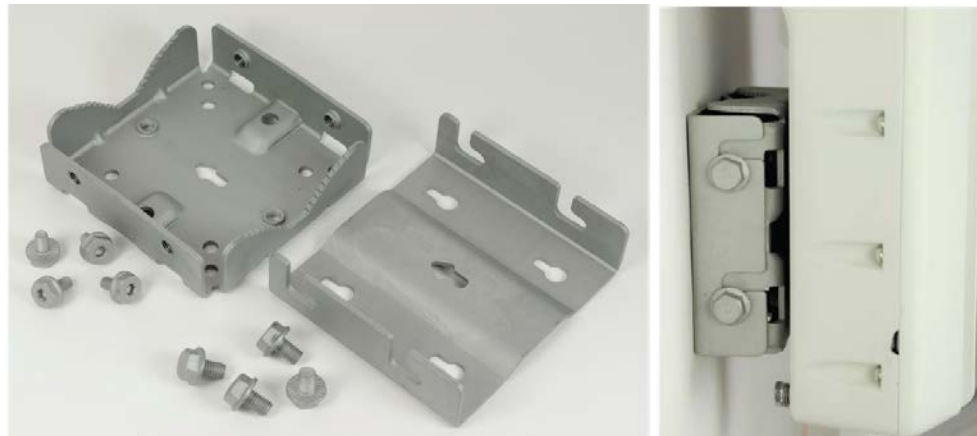

Bracket part numbers

Order mounting brackets by using the Cambium part numbers listed in below table.

Table 9: Radio mounting bracket part numbers

Bracket	Radio nodes	Cambium Part Number
Adjustable pole mount	V1000	N000900L022A
Tilt bracket assembly	V3000	N000045L002A
Wall mount bracket	V5000	C000000L136A

Bracket	Radio nodes	Cambium Part Number
Pole mount bracket	V5000	C000000L137A
Precision bracket	V3000	C000000L125A

Radio accessories

Telescope mounting kit for precision brackets

The Precision bracket and an alignment telescope provide the most accurate option for aligning the radio during installation. The telescope is temporarily mounted on the bracket using the telescope mounting kit for precision brackets.

The telescope mounting kit consists of a mounting plate, a knurled screw, and two rubber O-rings.

Order the telescope mounting kit from Cambium Networks.

Figure 26: *Telescope mounting kit*

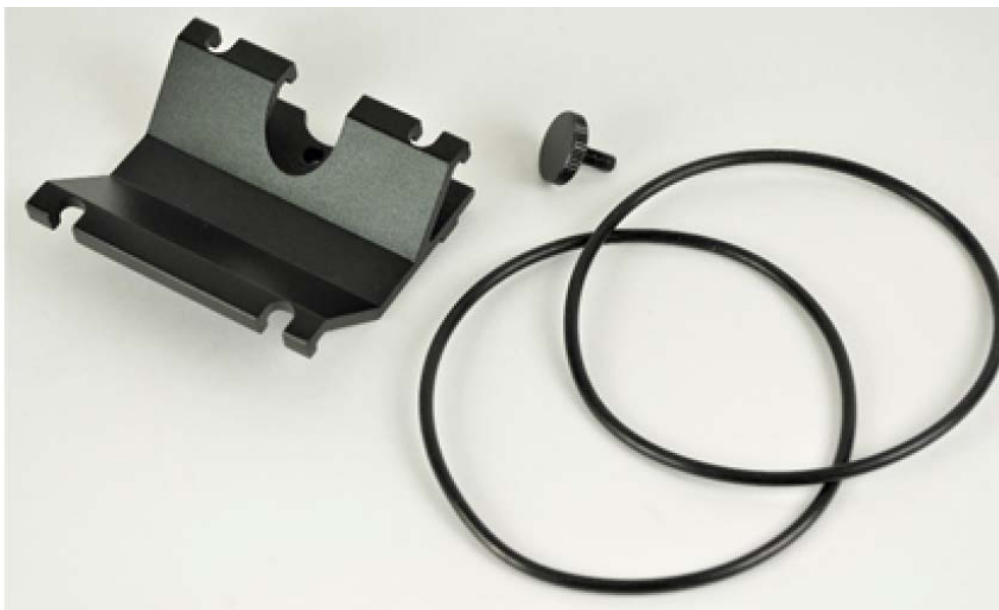

Order a suitable telescope from a specialist supplier specifying the following details:

Right angle, erecting, 9x50 mm alignment scope with 5° field of view

Figure 27: Typical alignment telescope



Alignment Tube

The Alignment tube (as shown in Figure 28) is designed to be used with V3000 when setting up a Point-to-Point link. It is ideal for aligning a Point-to-Point link that spans up to 600 m.

Figure 28: Alignment Tube



For longer links up to 3 km, Cambium Networks suggests using the telescopic mounting kit (C000000L139) and a finder scope.



Note

For details on how to fit the Alignment tube for V3000, refer to [Fixing the alignment tube](#).

Radio accessory part numbers

Order radio accessories using the Cambium Part Number in the [Radio accessory part numbers](#) table below.

Table 10: Radio accessory part numbers

Accessory	Radio nodes	Cambium Part Number
Telescope mounting kit	V3000	C000000L139A
Alignment Tube	V3000	C000000L190A

Radio external interfaces

V1000 CN

Figure 29: External interfaces for V1000 CN



Table 11: External interfaces V1000 CN

Port name	Connector	Interface	Description
PSU	RJ45	PoE input	Standard 802.3af/at PoE
		100/1000 BASE-T Ethernet	Data and management

V2000 CN

Figure 30: External interfaces for V2000 CN

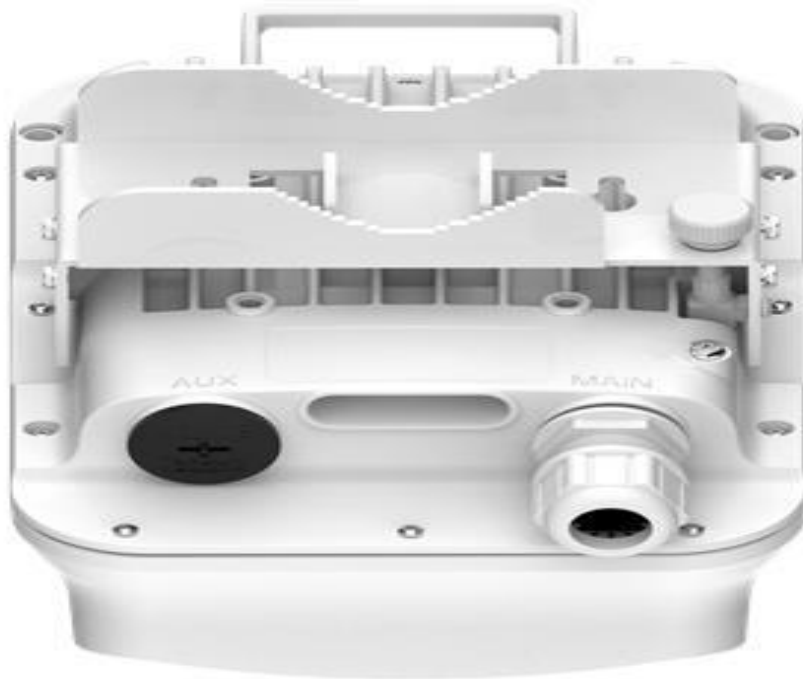

Table 12: External interfaces - V2000 CN

Port name	Connector	Interface	Description
PSU	RJ45	POE Input	Passive PoE or 802.3at (two pairs or four pairs for higher wattage)
		100m/1000m/2.5G BASE-T Ethernet	Data and management
AUX	RJ45	POE Output	IEEE 802.3af/at compliant, higher wattage supported (For more information, refer to the Aux PoE - Powering options section.)
		100m/1000m/2.5G BASE-T Ethernet	Data and management

V3000 CN

Figure 31: External interfaces for V3000 CN



Table 13: External interfaces V3000 CN

Port name	Connector	Interface	Description
SFP+	SFP	10G BASE-SR/10G BASE-LR/1G Base-SX using optional SFP+/SFP optical or copper module SFP-1G-SX / SFP-1G-LX using optional SFP optical or copper module	Data and management
PSU	RJ45	PoE input	Passive PoE or 802.3at (two pairs or four pairs for higher wattage)
		100m/1000m/2.5G BASE-T/5G BASE-T/ 10G BASE-T Ethernet	Data and management
AUX	RJ45	PoE output	IEEE 802.3af/at compliant, higher wattage supported for specific cases (For more information, refer to the Aux PoE - Powering options section.)
		100/1000 BASE-T Ethernet	Data and management

V5000 DN

Figure 32: External interfaces for V5000 DN

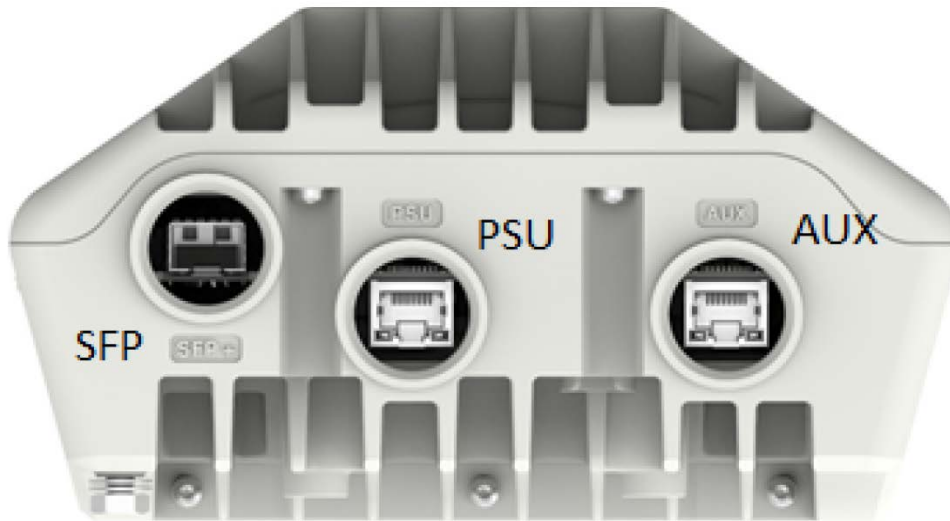

Table 14: External interfaces V5000 DN

Port name	Connector	Interface	Description
SFP+	SFP	10G BASE-SR/10G BASE-LR/1G Base-SX using optional SFP+/SFP optical or copper module SFP-1G-SX / SFP-1G-LX using optional SFP optical or copper module	Data and management
PSU	RJ45	PoE input	Passive PoE or 802.3at (two pairs or four pairs for higher wattage)
		100m/1000m/2.5G BASE-T/5G BASE-T/ 10G BASE-T Ethernet	Data and management
AUX	RJ45	PoE output	IEEE 802.3af/at compliant, higher wattage supported for specific cases (For more information, refer to the Aux PoE - Powering options section.)
		100/1000 BASE-T Ethernet	Data and management

Radio specifications

The 60 GHz cnWave Radios conform to the specifications listed in [Radio node specifications](#).

Table 15: Radio node specifications

Category	Specification	
Dimensions	V1000 Client Node	169 mm × 100 mm × 54 mm (6.6 in × 3.9 in × 2.1 in)
	V2000 Client Node	250 mm × 166 mm × 220 mm (9.8 in × 6.5 in × 8.6 in)
	V3000 Client Node (44.5 dBi) V3000 Client Node (40.5 dBi)	421 mm × 347 mm × 349 mm (16.5 in × 13.6 in × 13.7 in) 343 mm × 198 mm × 251 mm (13.5 in × 7.7 in × 9.8 in)
	V5000 Distribution Node	280 mm × 186 mm × 103 mm (11.0 in × 7.3 in × 4.0 in)
Weight	V1000 Client Node	0.46 kg (1.01 lbs)
	V2000 Client Node	1.9 kg (4.18 lbs)
	V3000 Client Node (44.5 dBi)	4.17 kg (9.1 lbs) including big antenna dish 6.12 kg (13.4 lbs) = radio with dish + precision bracket
	V3000 Client Node (40.5 dBi)	3.2 kg (7.05 lbs) including small antenna dish 5.15 kg (11.3 lbs) = radio with dish + precision bracket
	V5000 Distribution Node	3.12 kg (6.8 lbs) including antenna dish 3.76 kg (8.2 lbs) = radio with dish + universal pole bracket
Temperature	-40°C (-40°F) to +60°C (140°F)	
Wind survival	200 kph (124 mph) maximum	
Humidity	100% condensing	
Liquid and particle ingress	IP66, IP67	
Power consumption	V1000 Client Node	10 W
	V2000 Client Node	20 W without PoE and up to 60 W with PoE Out enabled
	V3000 Client Node	30 W, up to 60 W with PoE Out enabled
	V5000 Distribution Node	35 W, up to 65 W with PoE Out enabled

Category	Specification	
Power input interface	V1000 Client Node	IEEE 802.3af
	V2000 Client Node	Passive PoE or 802.3at (two pairs or four pairs for higher wattage)
	V3000 Client Node	Passive PoE or 802.3at (two pairs or four pairs for higher wattage)
	V5000 Distribution Node	Passive PoE or 802.3at (two pairs or four pairs for higher wattage)
Power output interface	V2000 Client Node	IEEE 802.3af/at, 30 W maximum
	V3000 Client Node	IEEE802.3af/at, 25 W maximum
	V5000 Distribution Node	IEEE 802.3af/at, 25 W maximum

Power supply units (PSU)

PSU Options

Order PSUs from Cambium Networks. The power supply component and the part numbers are described in the following table.

Table 16: Power supply component part numbers

Product description	Radio node	Cambium part number
Outdoor AC/DC PSU, 100W, 54V DC	V3000 and V5000	N000000L179B
Waterproof PSU Cable Joiner 14-16 AWG	V3000 and V5000	N000000L180A
DC to RJ45 Plug Power Adaptor	V3000 and V5000	C000000L184A
Cable Gland, Long, M25, Qty 5	V3000 and V5000	C000000L124A
PoE, 60W, 56V, 5GbE DC Injector, Indoor, Energy Level 6 Supply	V2000, V3000, and V5000	N000000L142A
PoE, 60W, 56V, 10GbE DC Injector, Indoor, Energy Level 6 Supply	V2000, V3000, and V5000	C000000L141A
PoE, 30W, 56V, 5GbE DC Injector, Indoor, Energy Level 6 Supply	V1000 and V2000	N000000L034B
PoE Gigabit DC Injector, 15W Output at 56V, Energy Level 6, OC to 50C	V1000	N000900L017A
AC power Injector 56V, 60W	V3000 and V5000	N000065L001C

Product description	Radio node	Cambium part number
CABLE, UL POWER SUPPLY CORD SET, 720mm, AUS/NZ	V1000, V2000, V3000, and V5000	N000900L011A
CABLE, UL POWER SUPPLY CORD SET, INDIA	V1000, V2000, V3000, and V5000	N000900L012A
CABLE, UL POWER SUPPLY CORD SET, ARGENTINA	V1000, V2000, V3000, and V5000	N000900L013A
CABLE, UL POWER SUPPLY CORD SET, CHINA	V1000, V2000, V3000, and V5000	N000900L015A
CABLE, UL POWER SUPPLY CORD SET, 720mm, US	V1000, V2000, V3000, and V5000	N000900L031A
CABLE, UL POWER SUPPLY CORD SET, 720mm, EU	V1000, V2000, V3000, and V5000	N000900L032A
CABLE, UL POWER SUPPLY CORD SET, 720mm, UK	V1000, V2000, V3000, and V5000	N000900L033A
CABLE, UL POWER SUPPLY CORD SET, 720mm, Brazil	V1000, V2000, V3000, and V5000	N000900L034A
CABLE, UL POWER SUPPLY CORD SET, 720mm, Israel	V1000, V2000, V3000, and V5000	N000900L037A

Refer to [Maximum cable lengths](#) for details of the maximum cable lengths and the maximum PoE output power for different powering options.

V1000 - Power over Ethernet (PoE)

The V1000 CN is always powered using Power over Ethernet (PoE) at a nominal 56V, as shown in the [PoE power supply to V1000](#) figure using the Gigabit power injector supplied with the radio, or using an IEEE 802.3af PoE output from an Ethernet switch.

Figure 33: PoE power supply to V1000



Table 17: PoE, 15W 56V, 1 Gigabit DC injector (N000900L017A)

Category	Specification
Dimensions	118 mm (4.64 in) x 43 mm (1.69 in) x 32.4 mm (1.27 in)
Weight	0.18 Kg (0.39 lbs)
Temperature	0°C (32°F) to +50°C (140°F)
Humidity	10% to 95 % non-condensing
AC Input	90-264V AC, 47-63 Hz
DC Output Voltage	56V
DC Output current	0.25A
Efficiency	Better than 84% at full load
Over Current Protection	Hiccup mode, recovers automatically after the fault condition is removed
Hold up time	At least 10 milliseconds
RJ45 POE Port	7,8 ----- DC V- 5,6 ----- DC V+



Note
The Gigabit power injector is supplied with the cnWave V1000 CN. Order part N000900L017A to obtain spares.



Warning
Always use an appropriately rated and approved AC supply cord-set in accordance with the regulations of the country of use.

V2000 - PoE

The V2000 CN is always powered using POE at a nominal 56V using 5GbE POE Injector, which is optional (Cambium part number: N000000L034B), or using an IEEE 802.3at POE output from an Ethernet Switch.

Figure 34: PoE power supply to V2000



Figure 35: Power supply to V1000 or V2000

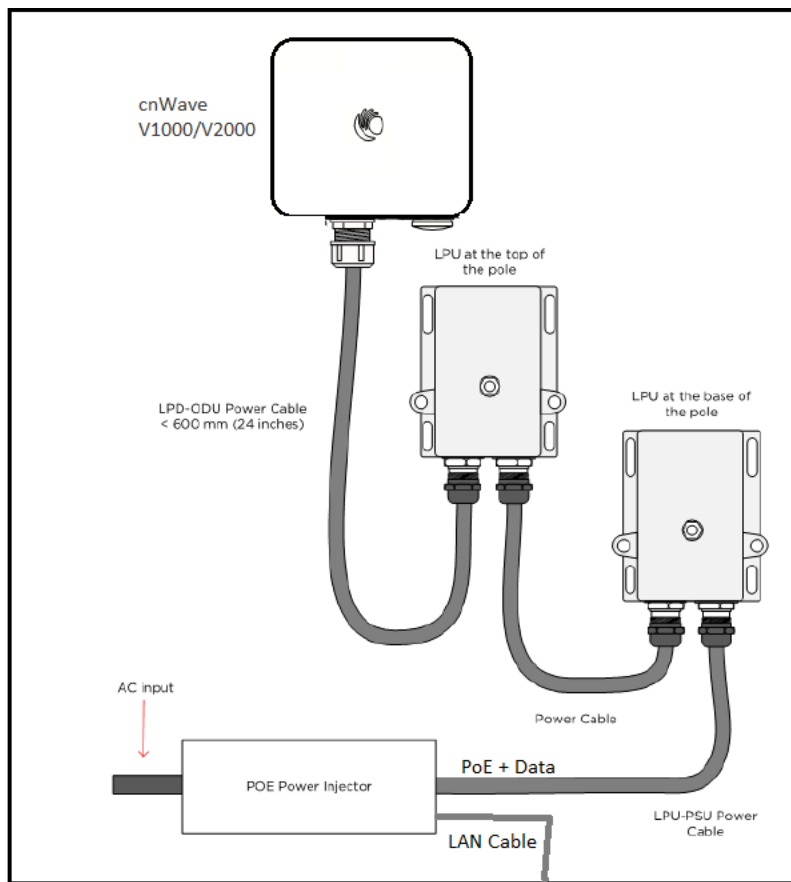

Table 18: PoE, 30W 56V, 5GbE DC injector (N000000L034B)

Category	Specification
Dimensions	140 mm (5.5 in) x 53 mm (2.08 in) x 35 mm (1.37 in)
Weight	0.24 Kg (0.5 lbs)

Category	Specification
Temperature	0°C (32°F) to +50°C (140°F)
Humidity	10% to 95 % non-condensing
AC Input	90-264 V AC, 47-63 Hz
DC Output voltage	56V
DC Output current	0.54 A
Efficiency	Better than 88% at full load
Over Current Protection	Hiccup mode, recovers automatically after the fault condition is removed
Hold up time	At least 10 milliseconds
RJ45 POE Port	1,2,7,8 ----- DC V- 3,4,5,6 ----- DC V+

V3000/V5000 - PoE

The V3000 CN and V5000 DN can be powered using DC power at a nominal 54V, using 14 AWG or 16 AWG cable, as shown in the [DC power supply to V3000 or V5000](#) figure.

Figure 36: PoE power supply to V3000 or V5000



Figure 37: 10 GbE PoE (C000000L141A)

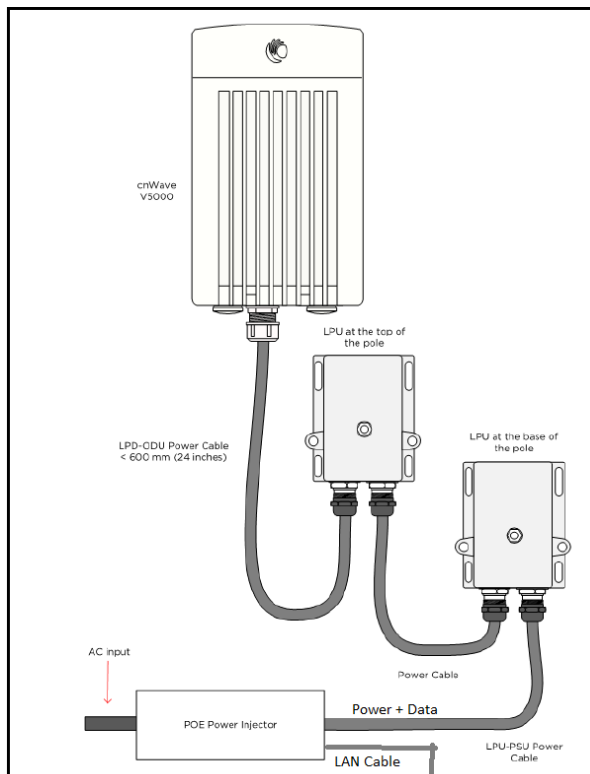
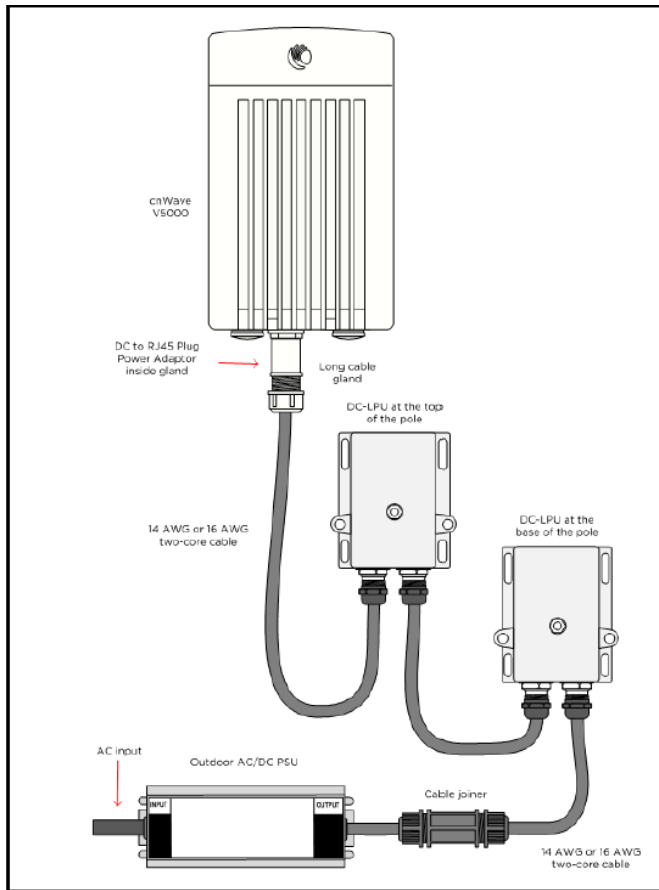

Table 19: PoE, 60W, 56V, 10 GbE DC injector (C000000L141A)

Category	Specification
Dimensions	140 mm (5.5 in) x 53 mm (2.08 in) x 35 mm (1.37 in)
Weight	0.24 Kg (0.5 lbs)
Temperature	0°C (32°F) to +50°C (140°F)
Humidity	10% to 95 % non-condensing
AC Input	90-264 V AC, 47-63 Hz
DC Output voltage	56V
DC Output current	1.07 A
Efficiency	Better than 88% at full load
Over Current Protection	Hiccup mode, recovers automatically after the fault condition is removed
Hold up time	At least 10 milliseconds
RJ45 POE Port	1,2,7,8 ----- DC V- 3,4,5,6 ----- DC V+

V3000/V5000 - Outdoor AC/DC power supply unit

Figure 38: DC power supply to V3000 or V5000



The outdoor PSU can be installed indoors, in an outdoor cabinet, or inside street furniture.

Figure 39: Outdoor AC/DC PSU, 100 W, 54V DC (N000000L179B)



Table 20: Outdoor AC/DC PSU, 54V DC

Category	PSU	Specification
Part number and	N000000L179B (100W)	220 mm (8.7 in) x 68 mm (2.7 in) x 39 mm

Category	PSU	Specification
dimensions		(1.5 in)
Power	100W	
Temperature	-40°C (-40°F) to +60°C (140°F)	
Humidity	20 to 95 % non-condensing	
Waterproofing	IP65/IP67	
AC Input	90-305 V AC, 47-63 Hz	
DC Output Voltage	54V	
DC Output current	60W	1.15 A
	100W	1.77 A
Efficiency	Better than 90% at full load	
Over Current Protection	Hiccup mode, recovers automatically after the fault condition is removed	
Hold up time	At least 16 milliseconds	
Power factor	Better than 0.95	

Figure 40: Cable joiner



Figure 41: DC to RJ45 plug power adapter

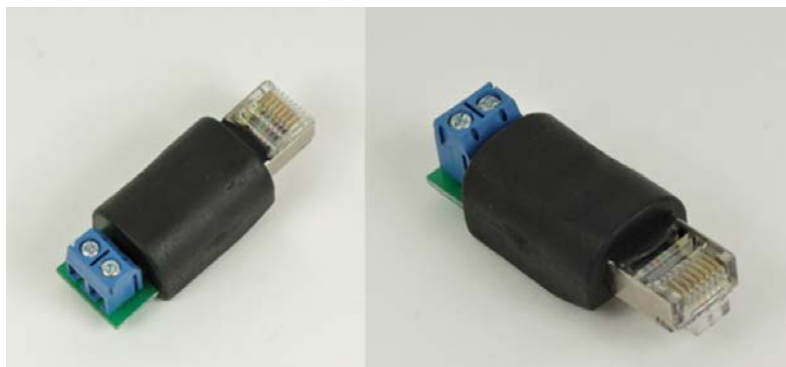

Cable joiners and DC to RJ45 cable adapters are used to connect to outdoor AC/DC PSU. Refer to [Maximum cable lengths](#) for details of the maximum cable lengths and the maximum PoE output power for different powering options.

**Note**

If you are using the mini RJ45 power adapter, you must use the cable gland (C000000L123A) to ensure that the cable is protected. This cable gland comes in the radio box. For more details about the cable gland, refer to [Table 28](#).

If the cable is ≤ 6 mm, you must use the gland (C000000L176A).

Aux PoE - Powering options

V2000, V3000, and V5000 devices support 802.3at compliant Aux POE output, using which these devices can power each other. This section lists and describes the supported cable lengths and maximum power available on the Aux port of these devices.

[Table 21](#) provides details of the power consumption of the devices without Aux PoE enabled.

Table 21: Power consumption without Aux PoE enabled

ODU	In typical cases	In maximum (worst) case
V2000	20W	22W
V3000	24W	27W
V5000	28W	32W

The Aux PoE output power depends on:

- Voltage of the PoE injector used to power on the main ODU and
- Cable length from the PoE injector to the main ODU.

[Table 22](#) lists the different PoE injector voltages used and the Aux power output available for the various ODUs.

Table 22: Aux power output for the different ODUs

ODU	ODU PoE voltage	Minimum Aux power available	ODU PoE Voltage	Maximum Aux power available
V2000	48	30W	56	36W
V3000	48	25W	56	30W
V5000	48	25W	56	30W

[Table 23](#) provides information of cable lengths of main PSU and Aux PoE for powering each ODU with other devices.

Table 23: Details of cable lengths of main PSU and Aux PoE - powering

ODU	Aux Device	Main PSU cable length (Max)	Aux PoE cable length (Max)	Feasible (Yes/No)
Using V2000 and powering V2000/V3000/V5000:				
V2000	V2000	0m to 100m	0m to 100m	Yes
	V3000	0m to 100m	0m to 100m	Yes
	V5000	0m to 100m	0m to 100m	Yes
Using V3000 and powering V2000/V3000/V5000:				
V3000	V2000	100m	100m	Yes
	V3000	100m	100m	Yes
	V5000	100m	100m	Yes only when 56V PoE is used
Using V5000 and powering V2000/V3000/V5000:				
V5000	V2000	100m	100m	Yes
	V3000	100m	100m	Yes
	V5000	100m	100m	Yes only when 56V PoE is used

Table 24 lists the possible and feasible combinations of devices (V1000, V2000, V3000, V5000) and power injectors.

Table 24: Possible combinations of devices, voltage, and PoE injector

ODU/Aux device	V1000	V2000	V3000	V5000
56V, 60W PoE:				
V1000	Not applicable	Not applicable	Not applicable	Not applicable
V2000	Yes	Yes	Yes	Yes
V3000	Yes	Yes	Yes	Yes
V5000	Yes	Yes	Yes	Yes
48V, 60W PoE:				
V1000	Not applicable	Not applicable	Not applicable	Not applicable
V2000	Yes	Yes	Yes	Yes

ODU/Aux device	V1000	V2000	V3000	V5000
V3000	Yes	Yes	Yes	No
V5000	Yes	Yes	Yes	No



Note

Consider the following key points:

- It is recommended using 56V PoE Injector to achieve the described powering options. Powering options vary depending on the PoE Injector's voltage rating.
- For V3000 and V5000, the main PoE cable can be CAT6/6A and Aux PoE cable can be CAT5/5e for powering V3000, V5000, or V2000.
- For V2000, the main PoE cable can be CAT5e and Aux PoE cable can be CAT5e for powering V2000, V3000, or V5000.

Ethernet and DC cables

Maximum cable lengths

Ethernet

For all cnWave radios, the maximum cable length for data transmission over copper Ethernet (100BASE-TX, 1000BASE-T, 2.5GBASE-T, 5GBASE-T, 10GBASE-T) is 100 m (328 ft) from the radio to the connected equipment.

Cambium Networks recommends using outdoor braided **CAT6A** cable for V2000, V3000, and V5000, and outdoor braided **CAT5e** cable for V1000.

For installations where the auxiliary device is powered using ODU Aux POE port, refer to the [Maximum cable lengths supported](#) table.

The maximum cable length for fiber Ethernet (10GBASE-SR, 10GBASE-LR) connections depends on the fiber used. Refer to the [SFP module kits](#) section for details of the Ethernet standards supported and maximum permitted cable lengths.

Power over Ethernet (PoE)

The maximum length for supplying power from a 60 W DC injector over a CAT6A Ethernet cable is shown in the [Maximum cable length for Power over Ethernet](#) table. A 60W DC injector is used to power the V2000, V3000, or V5000.

The maximum length for supplying power from a 30 W DC injector over a CAT6A Ethernet cable is shown in the [Maximum cable length for Power over Ethernet](#) table. A 30W DC injector is used to power on V2000.

Table 25: Maximum cable length for PoE supported

Radio	PoE enabled	Maximum cable length
V2000	-	390m
	25W	100m
V3000	-	390m
	25W	72m
V5000	-	330m
	25W	0m to 5m

The available output power for the auxiliary PoE in V2000, V3000, and V5000 is reduced at longer cable lengths as shown in [Table 26](#).

Table 26: Maximum PoE output power

Radio	Cable length	Maximum Aux PoE output
V2000	0m to 20m	36W
	20m to 70m	30W
	70m to 100m	30W
V3000	0m to 72m	25W
	25m	24.6W
	100m	23.6W
V5000	0m to 5m	25W
	10m	23.1 W
	20m	22.6W
	30m	22.1W
	40m	21.6W
	60m	20.6W
	80m	19.6W
	100m	18.6W



Note

The maximum PoE output power is based on the IEEE 802.3af/at compliant PoE requirements. The power ratings are different for 56V PoE. For more details on the Aux PoE - powering options, refer to the [Aux PoE - Powering options](#) section.

Using AC/DC PSU with a DC power feed

The maximum length for supplying power over a CAT6A Ethernet cable is shown in the [Maximum cable length for DC power](#) table.

Table 27: Maximum cable length for DC power

Radio	PSU	PoE enabled	Maximum cable length 14 AWG	Maximum cable length 16 AWG
V3000	60W	-	780m	490m
		25W	140m	90m
	100W	-	780m	490m
		25W	390m	250m
V5000	60W	-	660m	410m
		25W	Not supported	
	100W	-	660m	410m
		25W	360m	220m

Outdoor copper CAT6A Ethernet cable

Select an outdoor-rated CAT6A cable, ready with RJ45 connectors in one of the following lengths:

- 25m
- 50m
- 100m



Note

Cambium Networks offers the following cable bundles as accessories:

- 305m (N000082L172B - which can be used to make 25m, 50m, 100m, or any other length cables depending on the requirement at the time of installation)
- 100m (N000000L155A)

Alternatively, terminate bulk CAT6A cable with RJ45 connectors at a length to suit each installation.



Attention

Always use CAT6A or better cable that has an overall copper braid shield, is outdoor rated with a UV-resistant sheath.

Table 28: Ethernet cable part numbers

Cambium description	Cambium part number
CAT6A outdoor cable, 305m	N000082L172B
RJ45 connector for CAT6A cable	N000082L174B

Cambium description	Cambium part number
CAT6A outdoor cable, 100m	N000000L155A
CAT5E Outdoor Cable, 100m drum	N000082L016A

Cable accessories

This section provides information about the required cable accessories.

Figure 42: Standard cable gland



Figure 43: Long cable gland (C000000L124A)



Cable accessories available from Cambium Networks are listed in the [Cable accessory part numbers](#) table below.

Table 29: Cable accessory part numbers

Cambium description	Cambium part number
Cable gland for 6-9mm cable, M25, Qty 10	C000000L123A
Cable gland Long, M25, Qty 5	C000000L124A
Grounding cable, 0.6m with M6 ring to M6 ring	C000000L138A
Standard cable gland for 4-6mm cable, M25, Qty 10	C000000L176A
DC to RJ45 plug power adapter	C000000L184A
Grounding cable, 1m with M6 ring to M6 ring	N000082L116A



Note

One cable gland for 6-9mm cable size is included with each cnWave radio. Order additional cable glands as spares, where smaller cable size is to be used, or where the V3000 or V5000 Aux port is to be used.

SFP Module kits

SFP Module kits allow the connection of a V3000 CN or V5000 DN radio to a network over a 10 Gigabit optical Ethernet interface in one of the following full-duplex modes:

- 10GBASE-SR
- 10GBASE-LR

Order SFP+ module kits from Cambium Networks ([SFP module part numbers](#)).

The SFP+ module must be used with the long cable gland.

Table 30: SFP module part numbers

Cambium description	Cambium part number
10G SFP+ MMF SR Transceiver, 850nm. -40C to 85C	SFP-10G-SR
10G SFP+ SMF LR Transceiver, 1310nm. -40C to 85C	SFP-10G-LR
1G SFP MMF SX Transceiver, 850nm. -40C to 85C	SFP-1G-SX
1G SFP SMF LX Transceiver, 1310nm. -40C to 85C	SFP-1G-LX
10G SFP+ BaseT (RJ45), -40C to 85C	SFP-10G-Cu-EXT
1000Base-T (RJ45) SFP Transceiver. -40C to 85C	SFP-1G-Copper

Optical cable and connectors

Order an optical cable with LC connectors from a specialist fabricator, quoting the specification shown in the [Optical optic cable and connector specification](#). It must be the correct length to connect the ODU to the other device. LC connectors should be supplied with dust caps to prevent dust build-up.

Figure 44: Optical optic cable and connector specification

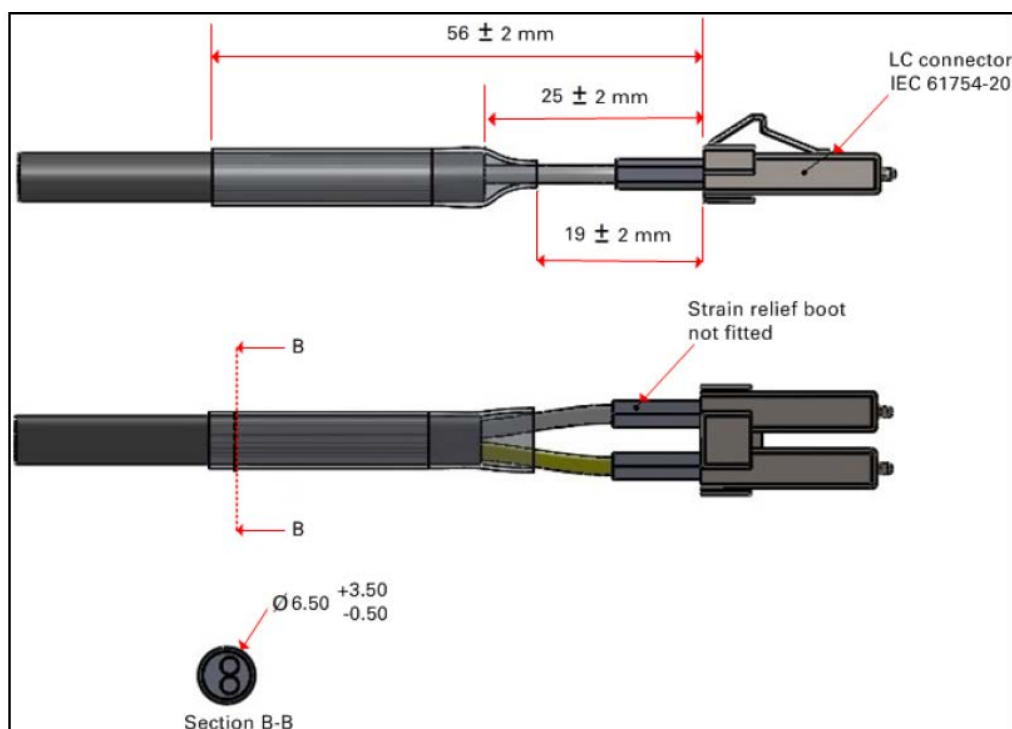

Table 31: Optical cable part numbers

Cambium description	Cambium part number
Optical CABLE,MM, 1m	N000082L215A
Optical CABLE,MM, 2.2m	N000082L191A
Optical CABLE,MM, 10m	N000082L192A
Optical CABLE,MM, 20m	N000082L193A
Optical CABLE,MM, 30m	N000082L194A
Optical CABLE,MM, 50m	N000082L195A
Optical CABLE,MM, 80m	N000082L196A
Optical CABLE,MM, 100m	N000082L197A
Optical CABLE,MM, 150m	N000082L198A
Optical CABLE,MM, 200m	N000082L199A
Optical CABLE,MM, 300m	N000082L200A
Optical CABLE,SM, 2.2m	N000082L186A
Optical CABLE,SM, 10m	N000082L187A
Optical CABLE,SM, 20m	N000082L188A

Cambium description	Cambium part number
Optical CABLE,SM, 30m	N000082L139A
Optical CABLE,SM, 50m	N000082L140A
Optical CABLE,SM, 80m	N000082L141A
Optical CABLE,SM, 100m	N000082L142A
Optical CABLE,SM, 150m	N000082L143A
Optical CABLE,SM, 200m	N000082L189A
Optical CABLE,SM, 300m	N000082L190A

System Planning

Site planning

This section describes factors to be considered when planning the proposed link end sites, including grounding, lightning protection, and equipment location for Outdoor Units (ODUs) and power supply units (PSU).

Grounding and lightning protection



Warning

Electro-magnetic discharge (lightning) damage is not covered under warranty. The recommendations in this guide, when followed correctly, give the user the best protection from the harmful effects of EMD. However, 100% protection is neither implied nor possible.

Structures, equipment, and people must be protected against power surges (typically caused by lightning) by conducting the surge current to the ground via a separate preferential solid path. The actual degree of protection required depends on local conditions and applicable local regulations. To adequately protect a 60 GHz cnWave installation, both ground bonding and transient voltage surge suppression are required.

Full details of lightning protection methods and requirements can be found in the International Standards **IEC 61024-1** and **IEC 61312-1**, the U.S. National Electric Code ANSI/NFPA No. 70-1984, or section 54 of the Canadian Electric Code.



Note

International and national standards take precedence over the requirements in this guide.

Lightning protection zones

Use the rolling sphere method (Rolling sphere method to determine the lightning protection zones) to determine where it is safe to mount equipment. An imaginary sphere, typically 50 meters in radius, is rolled over the structure. Where the sphere rests against the ground and a strike termination device (such as a finial or ground bar), all the space under the sphere is in the zone of protection (Zone B). Similarly, where the sphere rests on two finials, the space under the sphere is in the zone of protection.

Figure 45: Rolling sphere method to determine the lightning protection zones

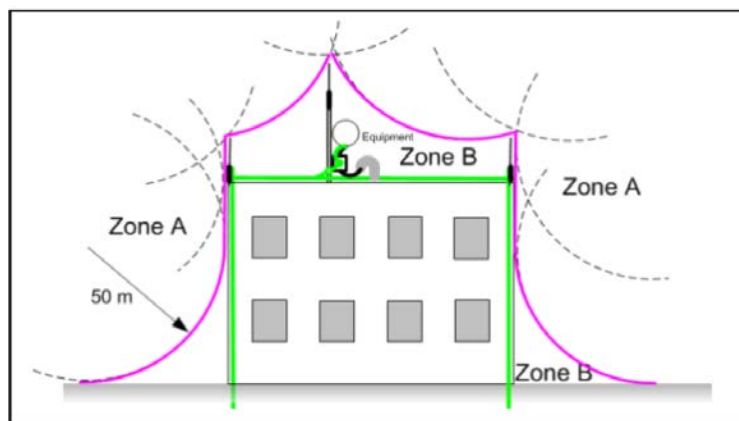



Warning

Never mount equipment in Zone A. Mounting in Zone A may put equipment, structures and life at risk.

Site grounding system

Ensure that the site has a correctly installed grounding system on a common ground ring with access points for grounding ODU.

If the outdoor equipment is to be installed on the roof of a high building, refer to the [Installation](#) section.

Ensure that the system meets the following additional requirements:

- A grounding conductor is installed around the roof perimeter to form the main roof perimeter lightning protection ring.
- Air terminals are installed along the length of the main roof perimeter lightning protection ring, typically every 6.1 m (20 ft).
- The main roof perimeter lightning protection ring contains at least two down conductors connected to the grounding electrode system. The down conductors should be physically separated from one another, as far as practical.

ODU location

Find a location for the ODU (and external antenna for connectorized units) that meets the following requirements:

- The equipment is high enough to achieve the best radio path.
- People can be kept a safe distance away from the equipment when it is radiating.
- The equipment is lower than the top of the supporting structure (tower, mast, or building) or its lightning air terminal.
- If the ODU is connectorized, select a mounting position that gives it maximum protection from the elements, but still allows easy access for connecting and weather proofing the cables. To minimize cable losses, select a position where the antenna cable lengths can be minimized. If diverse or two external antennas are being deployed, it is not necessary to mount the ODU at the mid-point of the antennas.

Drop cable grounding points

To estimate how many grounding kits are required for each drop cable, refer to site installation and use the following criteria:

- The drop cable shield must be grounded near the ODU at the first point of contact between the drop cable and the mast installation, tower or building.
- The drop cable shield must be grounded at the building entry point.

For mast or tower installations installation, use the following additional criteria:

- The drop cable shield must be grounded at the bottom of the tower, near the vertical to the horizontal transition point. This ground cable must be bonded to the tower or tower ground bus

bar (TGB) if installed.

- If the tower is greater than 61 m (200 ft) in height, the drop cable shield must be grounded at the tower midpoint, and at additional points as necessary to reduce the distance between ground cables to 61 m (200 ft) or less.
- In high lightning-prone geographical areas, the drop cable shield must be grounded at the spacing between 15 to 22 m (50 to 75 ft). This is especially important on towers taller than 45 m (150 ft).

For roof installations, use the following additional criteria:

- The drop cable shield must be bonded to the building grounding system at its top entry point (usually on the roof).
- The drop cable shield must be bonded to the building grounding system at the entry point to the equipment room.

ODU wind loading

Ensure that the ODU and the structure on which it is mounted are capable of withstanding the prevalent wind speeds at a proposed site. Wind speed statistics should be available from national meteorological offices.

The ODU and its mounting bracket are capable of withstanding wind speeds of up to 325 kph (200 mph).

Wind blowing on the ODU subjects the mounting structure to significant lateral force. The magnitude of the force depends on both wind strength and the surface area of the ODU. Wind loading is estimated using the following formulae:

- Force (in newtons) = $0.5 \times \rho \times V^2 \times A \times C_d$
 - “ ρ ” is the density of air (1.225 kg/m³)
 - “V” is the wind speed in meters per second
 - “A” is the projected surface area of the ODU in square meters
 - “ C_d ” is the drag coefficient = 1.385.

The drag co-efficient has been measured when the cover plate or antenna is perpendicular to the air flow.

Applying these formulae to the cnWave ODU at different wind speeds, the resulting wind loadings are shown in the following [ODU wind loading \(newtons\)](#) table:

Table 32: ODU wind loading (newtons)

Type of ODU	Max surface area (square meters)	Wind speed (km/h Newtons)					
		200*	225	250	275	300	325
V1000	0.017544	44	56	69	83	99	116
V2000	0.0368	61	78	96	116	138	162
v3000**	0.1764	462	583	719	871	1036	1216
V5000	0.052597188	118	148	185	224	266	312

Equivalent results in US customary units are shown in following [ODU wind loading \(pounds force\)](#) table:

Table 33: ODU wind loading (pounds-force)

Type of ODU	Max surface area (square meters)	Wind speed (km/h lbf)					
		200*	225	250	275	300	325
V1000	0.017544	10	13	16	19	23	26
V2000	0.0368	14	18	22	26	31	36
v3000**	0.1764	104	131	162	196	233	273
V5000	0.052597188	27	33	42	50	60	70

* 200 km/h is from measured data and used to calculate the remaining figures.

** Worst case setup with the product in -30° tilt position.

PSU DC power supply

Use Cambium Networks recommended DC PSU for wireless nodes and ensure the power cords and cables are appropriately rated and in accordance with the regulations of the country of use.

PSU AC power supply

Use Cambium recommended AC power supply for wireless nodes and ensure the power cords and cables are appropriately rated and in accordance with the regulations of the country of use.

PSU location

Find a location for the PSU that meets the following requirements:

DC PoE power injector

- DC power injector can be mounted on a flat surface.
- PSU is installed in a dry location where no condensation, flooding or rising damp is possible.
- The PSU is located in an environment where it is not likely to exceed its operational temperature rating, allowing for natural convection cooling and placed not close to any fire source.
- PSU can be connected to the ODU drop cable and network terminating equipment.
- PSU can be connected to a compatible power supply.

Outdoor AC/DC PSU

Find a location for the PSU that meets the following requirements:

- The PSU is installed in a dry location where no flooding or rising damp is possible.
- The PSU is located in an environment where it is not likely to exceed its operational temperature rating, allowing for natural convection cooling and placed not close to any fire source.
- The PSU is not stacked and placed adjacent to the heat-generating equipment.
- The PSU shall be connected to protective earth.

- The PSU shall be connected to ODU drop cable using cable joiner and appropriately rated cables should be used.

Lightning Surge Protection Units (LPU)

All drop cables connected to the ODU (for example, PSU and AUX drop cables) require their own Lighting Protection Unit (LPU) or Gigabit Surge Suppressor installed close to the ODU and close to the enclosure/building entry point. The copper SFP drop cable also requires surge protection. Optical cables do not require lightning surge protection or ground cables. Guidance on the positioning of required lightning surge protection is given in the [Lightning Surge Protection Units Location](#).

Drop cable grounding points

To estimate how many grounding kits are required for each drop cable, use the following criteria:

- The drop cable shield must be grounded near the ODU at the first point of contact between the drop cable and the mast, tower or building.
- The drop cable shield must be grounded at the building entry point.

For mast or tower installations, use the following additional criteria:

- The drop cable shield must be grounded at the bottom of the tower, near the vertical to the horizontal transition point. This ground cable must be bonded to the tower or TGB, if installed.
- If the tower is greater than 61 m (200 ft) in height, the drop cable shield must be grounded at the tower midpoint, and at additional points as necessary to reduce the distance between ground cables to 61 m (200 ft) or less.
- In high lightning-prone geographical areas, the drop cable shield must be grounded at the spacing between 15 to 22 m (50 to 75 ft). This is especially important on towers taller than 45 m (150 ft).

For roof installations, use the following additional criteria:

- The drop cable shield must be bonded to the building grounding system at its top entry point (usually on the roof).
- The drop cable shield must be bonded to the building grounding system at the entry point to the equipment room.

Lightning Surge Protection Units location

Lightning Surge Protection Units or Gigabit Surge Suppressors must be installed at two points on drop cables:

- There is room to mount the LPU, either on the ODU mounting bracket or on the mounting pole below the ODU.
- The drop cable length between the ODU and top LPU must not exceed 600 mm.
- There is access to a metal grounding point to allow the ODU and top LPU to be bonded in the following ways: top LPU to ODU; ODU to a grounding system.

Find a location for the bottom LPU that meets the following requirements:

- The bottom LPU can be connected to the drop cable from the ODU.
- The bottom LPU is within 600 mm (24 in) of the point at which the drop cable enters the building, enclosure or equipment room within a larger building.
- The bottom LPU can be bonded to the grounding system.

Deployment Considerations

This section provides brief information specific to the deployment of 60 GHz cnWave series of products. This section covers the following topics:

- [Key deployment guidelines](#)
- [Sector and alignment](#)
- [Minimum CN spacing](#)
- [Near-far radio](#)
- [Early weak interference](#)
- [Avoiding the tight angle deployment](#)
- [Avoiding the straight line interference](#)
- [When two V5000 devices are co-located at a site](#)
- [Polarity](#)
- [Link Adaptation and Transmit Power Control \(LATPC\)](#)

Key deployment guidelines

Following are some of the key guidelines that you must consider for the deployment of 60 GHz cnWave series of products:

- **Mounting accuracy:** Cambium Networks has different Stock Keeping Units (SKU) models. These three SKUs have different requirements in terms of alignment coverage, as shown in [Table 34](#).

Table 34: Details of alignment coverage - 60 GHz cnWave products

60 GHz cnWave product version	Azimuth (in degrees)	Elevation (in degrees)
V5000	+/-70 per sector	+/-20
V3000	+/-2	+/-1
V2000	+/-10	+/-4.5
V1000	+/-40	+/-20

- **Minimum deployment distance:** A typical minimum deployment distance is based on the maximum receive signal strength of -40 dBm, as listed:

- 25 meters for V1000 and V5000
- 150 meters for V3000
- 60 meters for V2000
- In deployments where the range is less than 25 meters (for V1000 and V5000), 150 meters (for V3000), or 60 meters (for V2000) a short range or long range specific check box is provided in the user interface (UI) to allow this.
- **Deployment frequency range:** 60 GHz cnWave products support the use of CH1 to CH4 (channels). Deployment in these channels depends on the allowed channels in that region. Each channel is 2.16 GHz wide, and the raster frequencies supported are - 58.32 GHz, 60.48 GHz, 62.64 GHz, and 64.8 GHz.

Sector and alignment

Each sector is an independent radio or a baseband unit. Each sector has 2 RF tiles connected to provide extended azimuth scan range, as shown in [Figure 46](#).

Figure 46: The sector diagram

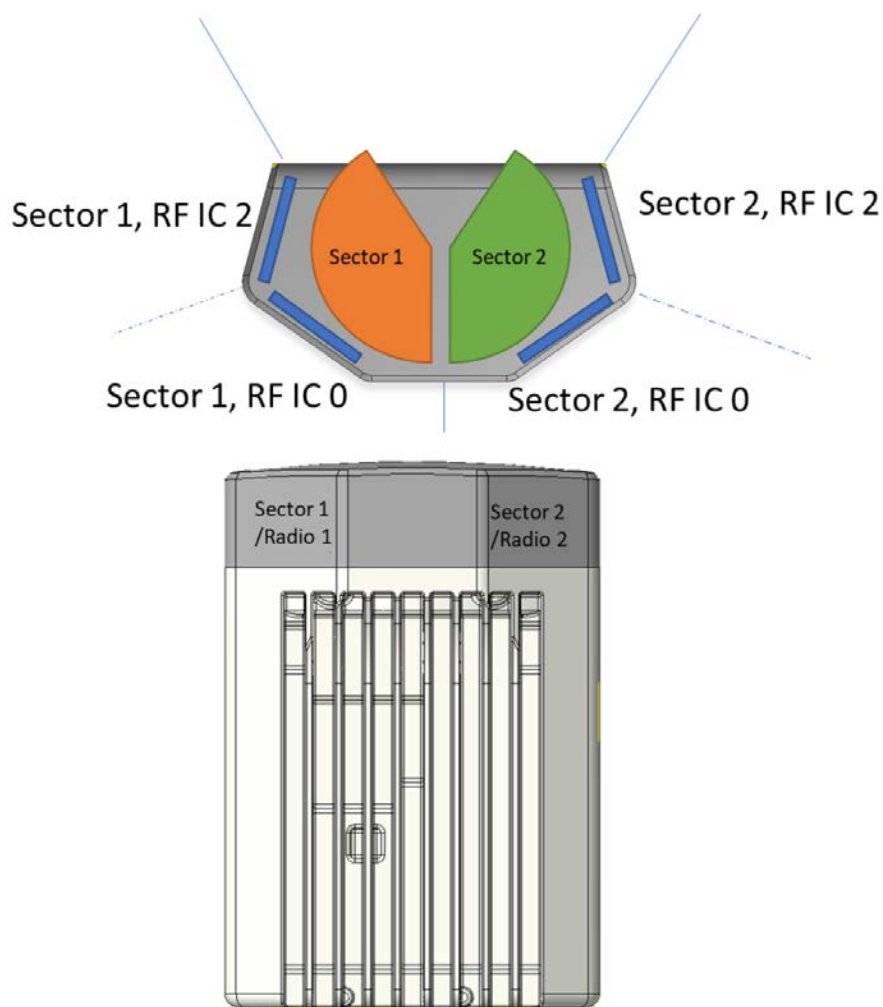

Maximize the pole or box height during the deployment. This action minimizes the ground bounce and avoids channel fluctuations, especially for links with long distances. The suggested height is >5m.

You must consider the orientation of a DN node in P2MP. For example, orient the V5000 to the boresight of the RF tile to the longest link (where possible). The optimal beam angle to achieve the maximum antenna gain is at boresight of the active tile face (as shown in Figure 47 using the Red dotted line).

Figure 47: Optimal beam angle

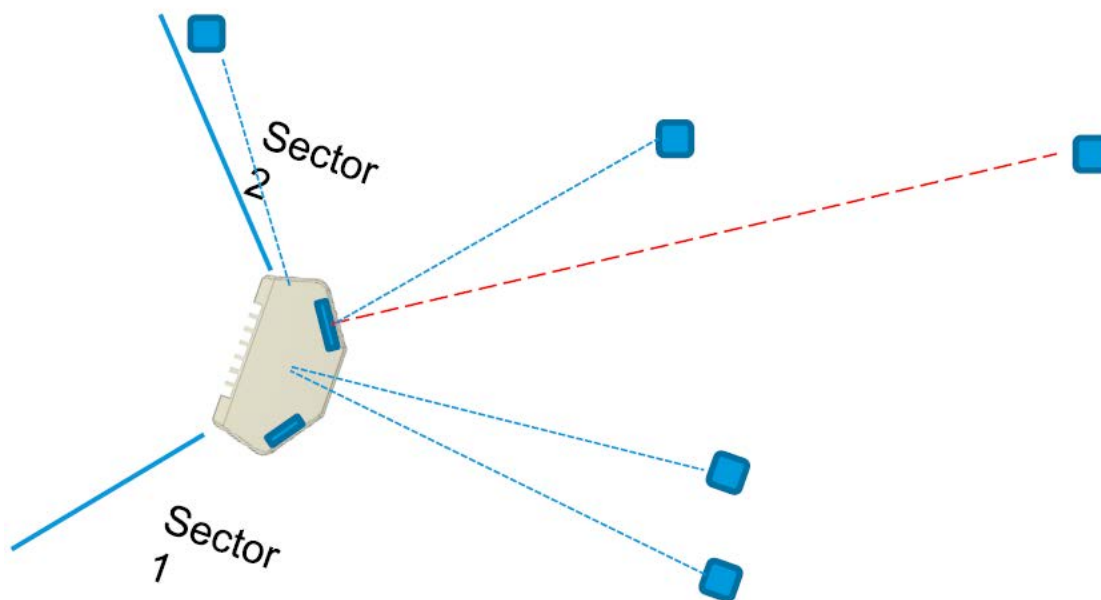

Consider the following deployment specific points:

- Avoid sticking any metallic labels on the radome.
- The 60 GHz cnWave antenna tiles are located on the four marked faces.
- The GPS antenna is located at the middle of the top face of the radome that is pointed to the sky.

Minimum CN spacing

Consider the following key points for the minimum CN spacing at a sector intersection:

- Up to 15 CNs can be installed on a single sector. Time Division Multiple Access scheme (TDMA) dynamically schedules the time slots for each wireless link on an access point, such that they do not interfere with one another.
- When CNs are installed in multiple sectors, more than one CN can be talking at a given time as the sectors have independent schedulers.

If both CNs installed in different sectors are located within the highlighted 20 degree range, then configure the two sectors to be on different channels to avoid interference.

Figure 48 shows the minimum CN spacing at a sector intersection.

Figure 48: Minimum CN spacing

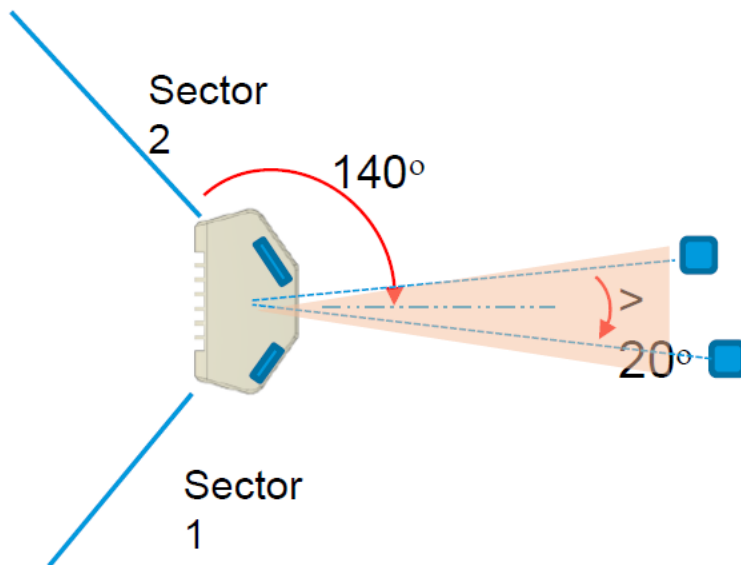

Near-far radio

Near-far ratio for links from different sectors on the same pole is based on the following factors:

- **Scenario:**
 - One wireless link on DN sector 1 at long range, link 2
 - One wireless link on DN sector 2 at short range, link 1
 - Narrow angular separation between link1 and link2 (less than 20 degrees)
 - Configured for the same channel
- **Problem:**
 - The TG system utilizes the active Transmit Power control.
 - The transmit power for link 1 is automatically set to a low level.
 - The transmit power for link 2 is automatically set to a high level.
 - Due to narrow angular separation, the sidelobe of link 2 is interfered with link 1. As a result, the Signal-to-Noise Ratio (SNR) of link1 could degrade and this might cause the transmit power of link 1 to be boosted to a much higher level. This problem ends up in a cycle resulting in both links eventually transmitting at full power by causing network interference.
- **Solution:**

- Perform traffic test on one link at a time and then simultaneously.
- If the simultaneous traffic results show degradation along with transmit power that is raised high to maximum, consider the following tasks:
 - Setting the two sectors on different channels or
 - Capping the maximum power of the short range link.

Figure 49 illustrates the problem and the solution for near-far radio.

Figure 49: Near-far radio - Problem and solution

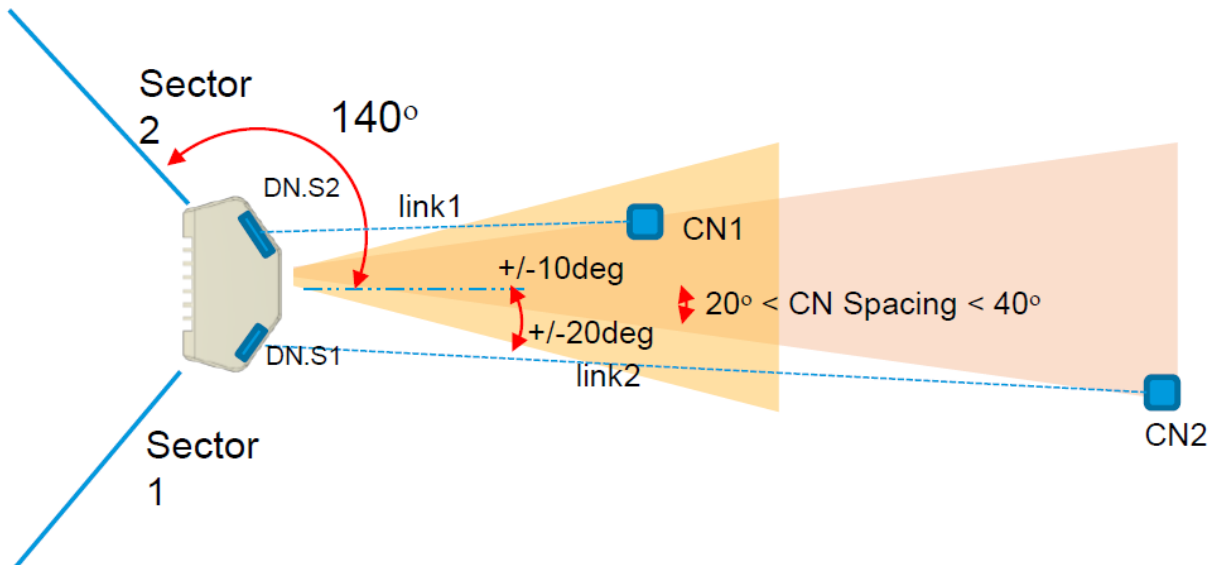

Early weak interference

Early weak interference occurs when the receiver correlates to a preamble from an unwanted node, with the same Golay code (as desired). If the receiver starts decoding the preamble from the wrong node, it may be too late to recover the preamble from the correct node for that cycle.

Terragraph has four Golay codes to mitigate this interference. Users can select the Golay codes {1,2,3}.



Note

Golay 0 is used for another purpose. Therefore, avoid selecting the Golay 0 (The use of Golay 0 has been deprecated in System Release 1.2).

Consider the following points specific to the Golay codes in 802.11ad/ay:

- The 802.11ad/ay frame consists of PHY preamble, which consists of short training frame (STF) and Channel Estimation Symbol (CES).
- The STF and CES are made up of complimentary Golay codes. Due to the repetition of the Golay codes, the signal can be correlated with even low SNRs.
- This PHY preamble is used for frequency synchronization, timing synchronization, and channel estimation.

Avoiding the tight angle deployment

Avoid tight P2MP angles in the deployment for the following reasons:

- In Figure 50 (shown as an example), a downlink data transmission from the DN1 to CN1 can interfere with the uplink data reception at CN2 to DN2. This interference can be both down to the main lobe in very tight angles or sidelobes with up to 20 degrees delta between two CNs.
- The level of interference depends on the link distances between DN1->CN1 versus DN->DN2 versus CN2->DN2.
- In most cases, the main interference is due to the early weak interference.
- To mitigate this early-weak interference, different Golay code assignment could be used. This issue only relates to the two links transmitting at the same time in the same physical direction.

Figure 50: Tight angle deployment

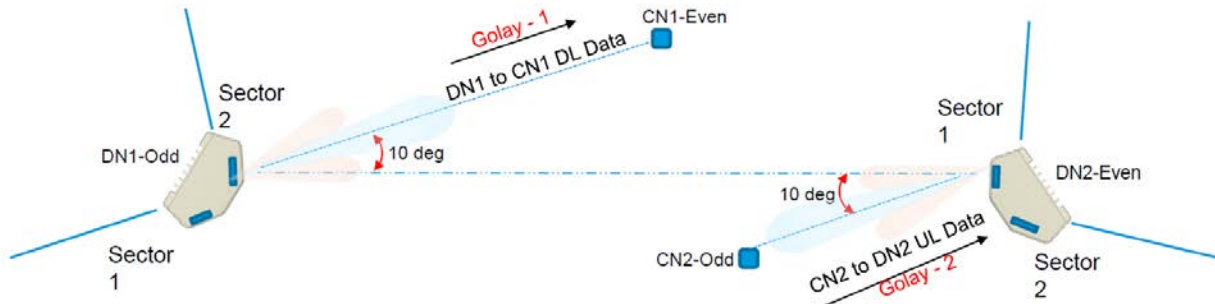

Avoiding the straight line interference

It is recommended to avoid the straight line interference. When the desired link and interference link angles are the same, there is no assistance from the beamforming interference suppression.

Figure 51: Representation of straight line interference

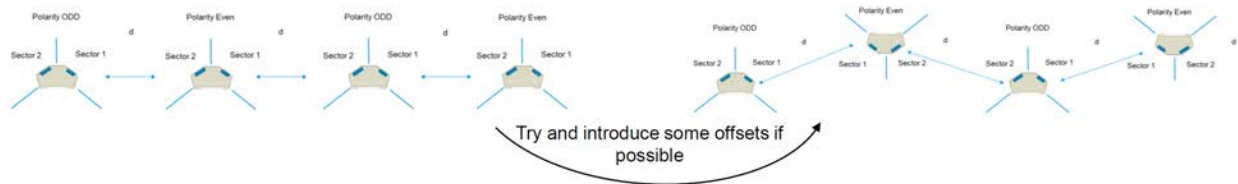

It is recommended to assign appropriate Golay codes to mitigate early-weak interference. In Figure 52, the red and orange arrows show the possible weak interference. The code assignment must be in the form of 2-2-1-1 or 1-1-2-2 but not in the 1-2-1-2 form.

Figure 52: Assigning Golay codes

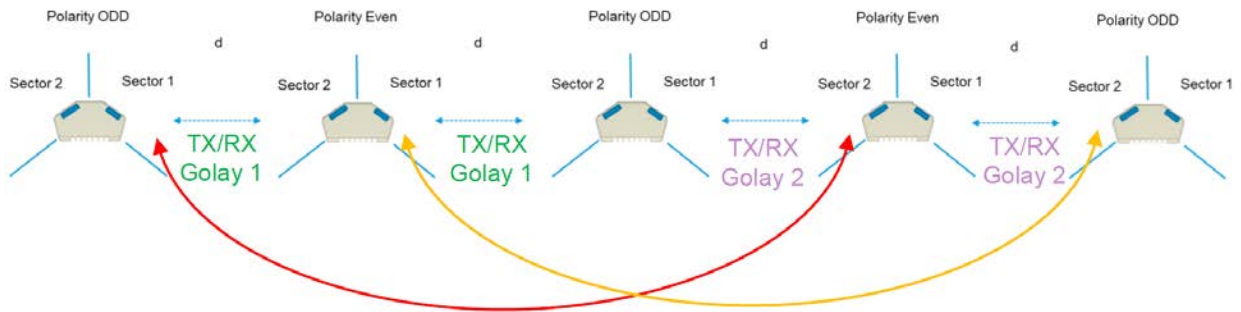

When two V5000 devices are co-located at a site

When two V5000 devices are co-located at the same site, it is recommended that one must use different channels on the two V5000 devices to start with.

Evaluate the issues specific to near-far radio and Tight Angle deployment. Then, you have to configure two different channels for the two sectors or consider option 2, as shown in Figure 53.

Figure 53: When two V5000 devices are co-located at the same site

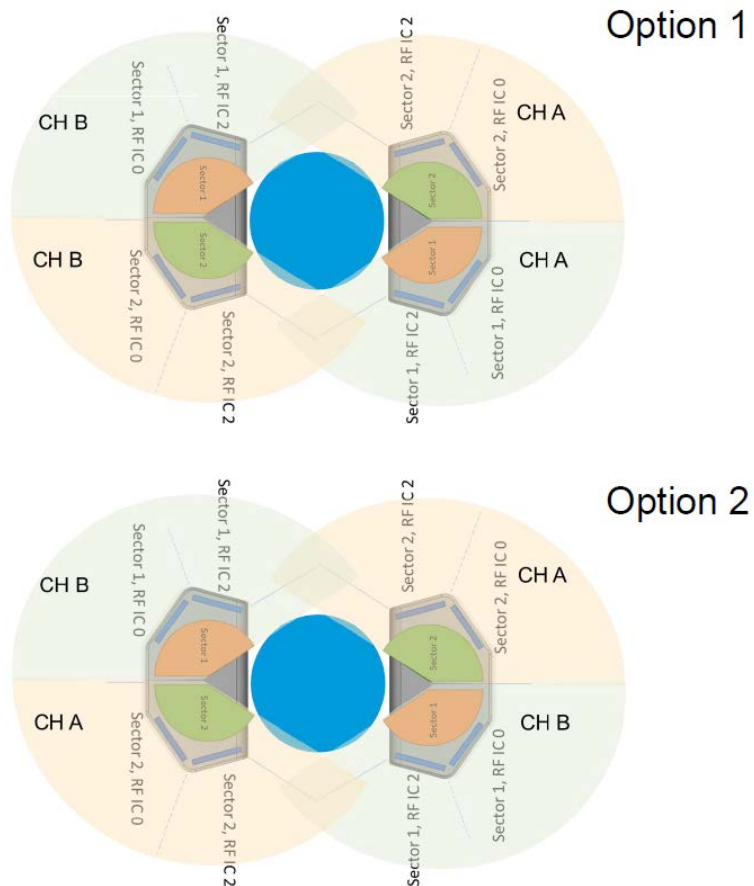

Where local regulations allow the usage of four channels, it is advisable to choose CHA and CHB such that there are two channels apart. Example: Consider that CHA = 1 or 2 CHB = 3 or 4. The reason is that it

may be easier to upgrade to Channel bonding (CB2) in the future and still experience the channel isolation.



Note

It is important to use the same polarity at the same site. For more details about the polarity, refer to the [Polarity](#) section.

Polarity

60 GHz CnWave uses TDD, which is synchronized across the network. As one sector is in the transmit phase, the neighbor sector is in the receive phase. The transmit and receive phases of the sectors are determined by the EVEN or ODD polarity.

All sectors with a common polarity in a network could be transmitting or receiving at the same time.

Hybrid polarity is when a node uses an EVEN polarity on one sector and an ODD on another sector. Although hybrid polarity is possible through configuration, you must avoid this unless the installer is sure that the two links on the sectors are orthogonal. [Figure 54](#) shows an example of the hybrid polarity.

[Figure 54](#): Hybrid polarity

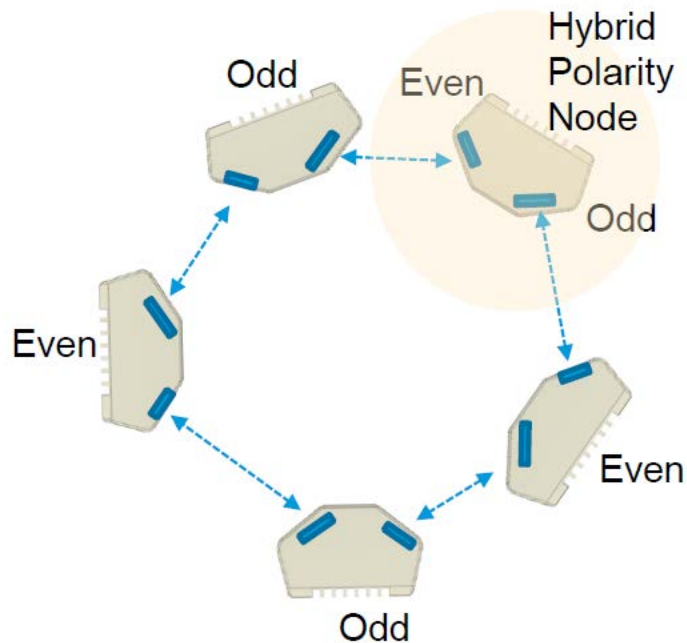

Link Adaptation and Transmit Power Control (LATPC)

The modulation and code scheme (MCS) rate and transmit power are both adaptive values. These values are set at the transmitter, independently, for every link and for both directions. The adaptive MCS selection procedure is referred to as link adaptation (LA) and the transmit power procedure as transmit power control (TPC).

Following are the two versions of this adaptation, data traffic, and standby:

- When there is data traffic, adaptation is driven by block error rate (BLER) reported every SF (1.6ms). A lower BLER causes the algorithm to adapt the transmit power or MCS.

- When there is no data traffic, the algorithm is driven by the short training frame (STF) SNR as reported by each management packet. The SNR is compared to an MCS table. If the SNR is greater or lesser than table value, the transmit power or the MCS rate is adapted accordingly.

There is a maximum TX power per MCS mode (which is defined in the configuration section).

During the adaptation process, the transmit power is either increased or decreased first to:

- increase the power till the maximum per MCS power is reached or
- reduce the power if there is enough headroom.

If the maximum power for the MCS mode has been reached, the MCS mode is reduced.

Radio spectrum planning

General wireless specifications

The following [60 GHz cnWave wireless specifications \(all variants\)](#) table lists the wireless specifications that apply to all 60 GHz cnWave frequency bands:

Table 35: 60 GHz cnWave wireless specifications (all variants)

Item	Specification
Channel selection	Open/R protocol or manual selection
Manual power control	Supports ATPC automatic transmit power control and maximum EIRP can be set lower than the default power limit.
Integrated antenna type	<ul style="list-style-type: none"> • V1000 - 22.5 dBi gain • V2000 - 34.5 dBi gain • V3000 - 44.5 dBi gain and 40.5 dBi gain • V5000 -22.5 dBi gain
Duplex schemes	Symmetric 50:50 fixed and asymmetric fixed
Range	100 m to 2 KMs, depends on the following factors: <ul style="list-style-type: none"> • Frequency selected • Rain condition • Availability • EIRP limitation
Over-the-air encryption	AES 128-bit
Weather sensitivity	Highly sensitive due to rain range conditions. For more information in range, refer Rain and attenuation table.

Regulatory limits

Many countries impose EIRP limits (allowed EIRP) on products operating in the bands used by the 60 GHz cnWave. These are commonly identified by limitations on conducted transmit power or by antenna gain. For example:

Table 36: ERC recommendation (70-03)

Frequency Band		Power / Magnetic Field
c2	57 - 71 GHz	40 dBm E.I.R.P., 23 dBm/MHz E.I.R.P. density and maximum transmit power of 27 dBm at the antenna port/ports.
c3	57-71 GHz	55 dBm E.I.R.P., 38 dBm/MHz E.I.R.P. density and transmit antenna gain \geq 30 dBi.

CFR47 Part 15.255(c)(ii):

For fixed point-to-point transmitters located outdoors, the average power of any emission shall not exceed 82 dBm and shall be reduced by 2 dB for every dB that the antenna gain is less than 51 dBi. The peak power of any emission shall not exceed 85 dBm, and shall be reduced by 2 dB for every dB that the antenna gain is less than 51 dBi.

Link planning

This section describes factors that must be considered when planning links, such as range, obstacles path loss, and throughput. It is highly recommended to use Cambium LINKPlanner software when planning the links.

LINKPlanner

The Cambium LINKPlanner software and user guide may be downloaded from the support website (see <https://support.cambiumnetworks.com/files/linkplanner/>).

LINKPlanner imports path profiles and predicts data rates and reliability over the path. It allows the system designer to try different antenna heights and RF power settings. It outputs an installation report that defines the parameters to be used for configuration, alignment, and operation. Use the installation report to compare predicted and actual link performance.

Exclusion zones for the 59 – 63.9 GHz band

In the three geographical areas outlined in [59 - 63.9 GHz Transmission Exclusion Zones](#) (UK IR 2078 Section 4 and IR 2030 IR2030/7/4 (2018/316/UK)), no transmissions are permitted.

Table 37: 59 - 63.9 GHz transmission exclusion zones

Site Name	Site Location	Radius of exclusion zone from the center of site location
Site 1	07° 23' 36.6" W, 57° 21' 3.6" N	6 Km
Site 2	04° 58' 21" W, 51° 37' 16.8" N	6 Km
Site 3	00° 36' 22.8" W, 52° 38' 1.8" N	6 Km

Range and obstacles

Calculate the range of the link and identify any obstacles that may affect radio performance.

Perform a survey to identify all the obstructions (such as trees or buildings) in the path and to assess the risk of interference. This information is necessary to achieve an accurate link feasibility assessment. The 60 GHz cnWave radios are designed to operate in Line-of-Sight (LoS) environments.

The 60 GHz cnWave radios operate at ranges from 15 m (49 ft) to 2000 m (1.2 miles). The operation of the system depends on the frequency channel chosen.

Path loss

Path loss is the amount of attenuation the radio signal undergoes between the two ends of the link. The path loss is the sum of the attenuation of the path if there were no obstacles in the way (Free Space Path Loss), the attenuation caused by obstacles (Excess Path Loss) and a margin to allow for possible fading of the radio signal (Fade Margin). The following calculation needs to be performed to judge whether a particular link can be installed:

$$L_{free_space} + L_{excess} + L_{fade} + L_{seasonal} < L_{capability}$$

Table 38: Input details for the link calculation

Where:	Is:
L_{free_space}	Free Space Path Loss (dB)
L_{excess}	Excess Path Loss (dB)
L_{fade}	Fade Margin Required (dB)
$L_{seasonal}$	Seasonal Fading (dB)
$L_{capability}$	Equipment Capability (dB)

At 60 GHz cnWave, the oxygen absorption is a key component of the free space path loss and varies substantially depending on the frequency channel selected. Use LINKPlanner to calculate the oxygen absorption component for the required path and frequency channel.

Planning for data networks

This section describes factors to be considered when planning 60 GHz cnWave data networks.

60 GHz cnWave network can be deployed as point-to-point backhaul-bridge, Point-to-Multipoint coverage network and mesh network that provide network rebound.

By default, cnWave radios operate in IPv6 layer 3 network mode, requiring IPv6-based routing gears. The network can be designed to operate in pure IPv4 network mode, transporting layer 2 traffic (VLAN tagged and untagged) with GRE tunnels built-in by the system.

There is no fundamental difference between configurations of PTP vs. PMP vs. Mesh because the underlying routing mechanism of the cnWave network is always IPv6-based OpenR routing.

In a PTP network, you have one PoP DN and a CN to form a link. In a PMP network, you have one PoP DN and multiple CNs (up to 30 CNs if V5000 is used) to form a PMP cluster. You can have multiple PMP clusters to form a coverage area network.

You can have one PoP node with multiple DNs or CNs. If DNs are connected, the user gets a mesh network. User can then have multiple PoPs and DNs and if the link with each other and form a complex mesh network.

Point to Point-based single link Ethernet bridge

A Point to Point cnWave link can be configured to work as an Ethernet bridge. The operator needs to configure one end as PoP DN, and the other end as CN.

Enable Layer 2 Bridge. While the radios still run on IPv6, the Layer 2 Bridge configuration allows user Layer 2 data (VLAN tagged and untagged) to be transmitted transparently through the link.

IPv6 address of the PoP and CN can be automatically generated and they do not need to be routable through the external network as long as the E2E is collocated with the PoP DN or within the same VLAN of the PoP DN. The operator can assign IPv4 addresses to the radios for management purposes.

Figure 55: Point to Point cnWave link



IPv4/L2 based PMP and mesh network planning

You can build a complete IPv4-based network without the need for any IPv6 routers. The following figure shows the network:

Figure 56: Example of IPv4-based network

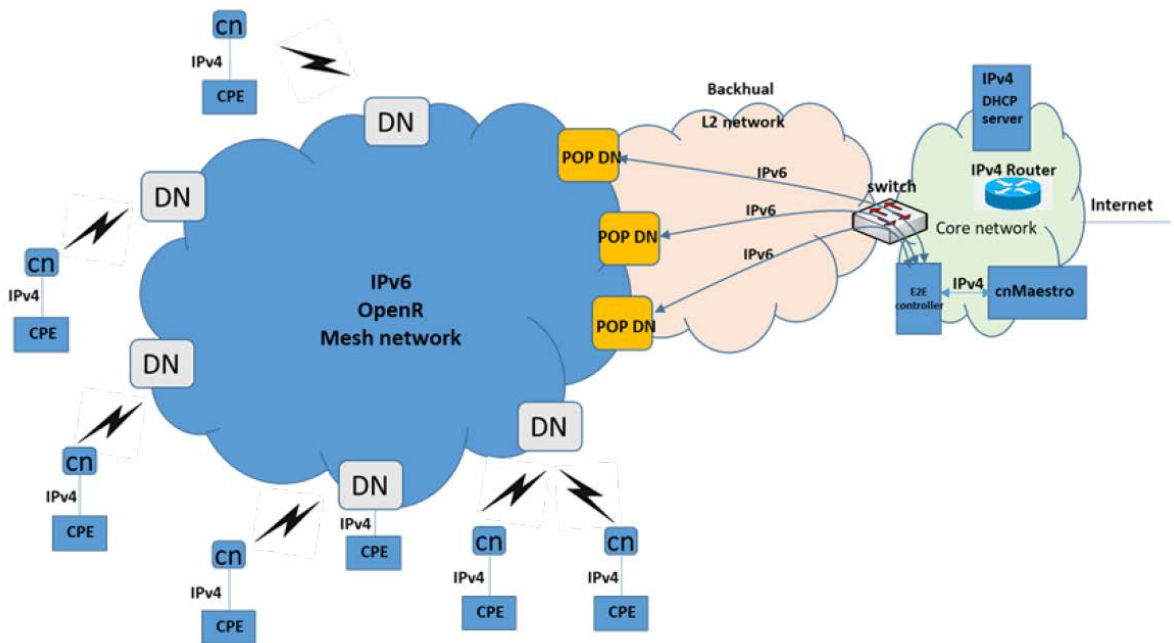

60 GHz cnWave IPv6 IP address is generated automatically by the system.

1. Single PoP, E2E resides in the PoP DN

When configuring the PoP E2E, the operator can configure the IPv6 address to be generated automatically.

2. Multiple PoPs, E2E controls all the PoPs

cnMaestro generates the IPv6 configuration for all the PoPs. The user can download the config file from cnMaestro. This config file contains all the PoPs IPv6 configuration. The IPv6 configuration is associated with the MAC address of each PoP DN. When loading the config file to the PoP DN during initial configuration, the PoP DN chooses the IPv6 address by matching its MAC address, so there is no IPv6 address conflict.

The PoP DNs automatically use the E2E controller as the default gateway of IPv6 traffic. Since IPv6 traffic is used only for management purposes, there may be no concern about overloading the E2E. (IPv6 payload traffic should be disabled in the radio configuration).

The E2E chooses any one of the active PoP DN as the IPv6 default gateway. If the E2E detects that the default gateway PoP DN is down, it selects another PoP DN as a default gateway.

Control traffic from E2E to all cnWave radios will be sent to the default gateway PoP, which relies on OpenR to route through correlated POP to the target radio.

Select the **Relay Port Interface** for the PoP DN's Ethernet interface for inter-PoPs OpenR routing to work.



Note

IPv6 routers in the network are not required. Ensure that the PoP DNs and the E2E be in the same VLAN.

Configure the IPv4 address of the radios manually. The CPE IPv4 address can be manually configured or use a DHCP server sitting in the core network. Depending on the complexity of the network, IPv4 based router may be required to route the IPv4 traffic from the CPEs.

Support for dual networking (IPv4 and IPv6)

The operator can design the network so that both IPv4 and IPv6 user data are supported. In this case, an IPv6 router is required at the core network. Ensure that if Layer 2 Bridge is enabled, by default all the user traffic including IPv6 is encapsulated in the GRE tunnel. The IPv6 user traffic is passed through the cnWave network in the GRE tunnel so that it does not be routed by the cnWave radios, but rather by an external IPv6 router.

Figure 57: Example of an IPv4 and IPv6 supported network

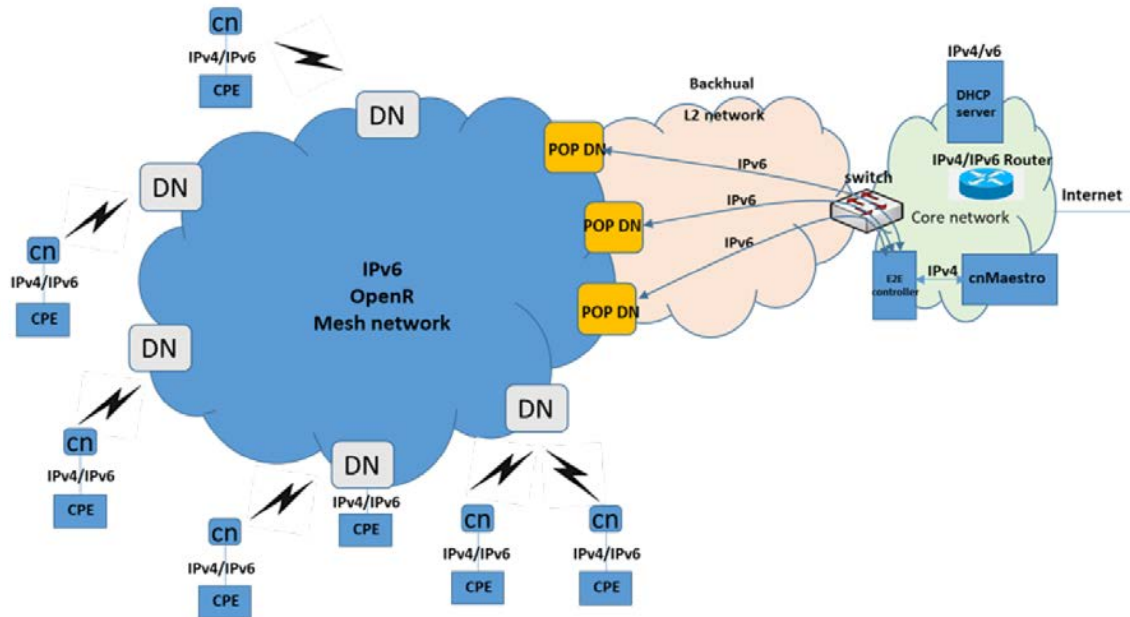

The operator can choose certain of the radio Ethernet port to be SLAAC based port or (CPE interface), user traffic from this port is only IPv6 based and does not be encapsulated into the GRE Layer 2 bridge when transmitted over the wireless network. Although this reduces overhead, it is not recommended since this adds complexity to the network design (the operator may need to add a BGP router to the network).

IPv6 Mode network planning

If the operator chooses to have the network completely run on IPv6 mode, then GRE Layer 2 Bridge is not required and a BGP router is usually required to route traffic between the wireless network and the external network.

Figure 58: Example of IPv6 mode network

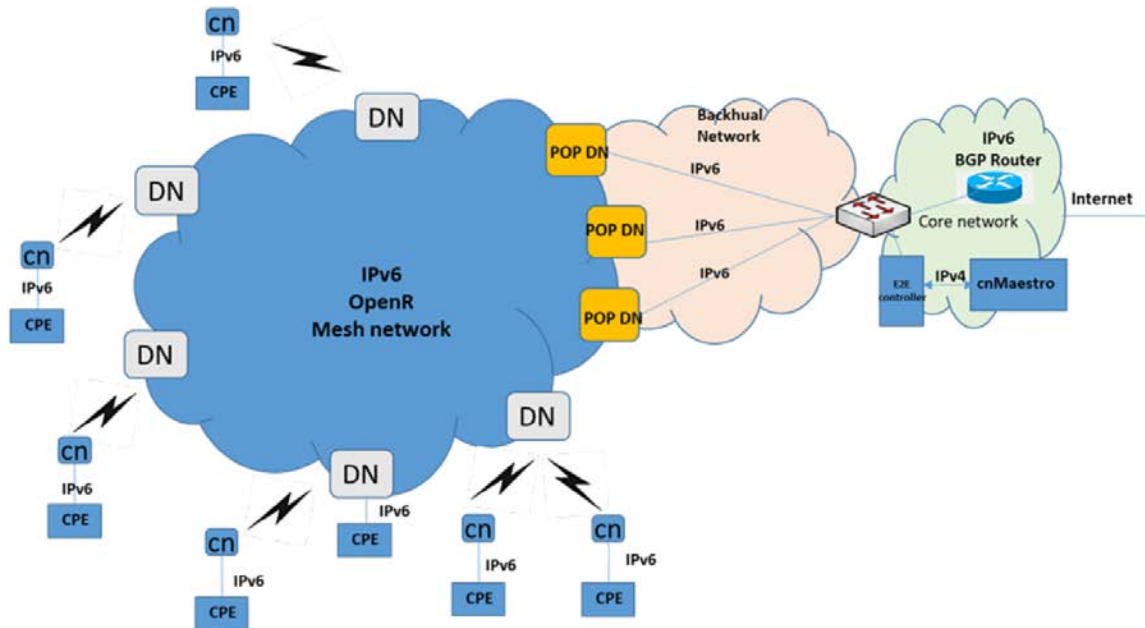

IPv6 Network design consideration

There are two sets of networks when designing the IPv6 network. one set is for the OpenR subnets (e.g. prefix of 56 bits and partition into multiple 64 bits subnet).

Each PoP node, besides being part of the OpenR mesh network, has a subnet assigned to it and has an IPv6 address assigned to it as PoP interface IPv6 address.

If you let the system automatically generate an IP address configuration, the IP address is always in the format of `FD00:xxxxxxx`, which is a standard routable private IPv6 address.

Figure 59: Example of an IPv6 network design

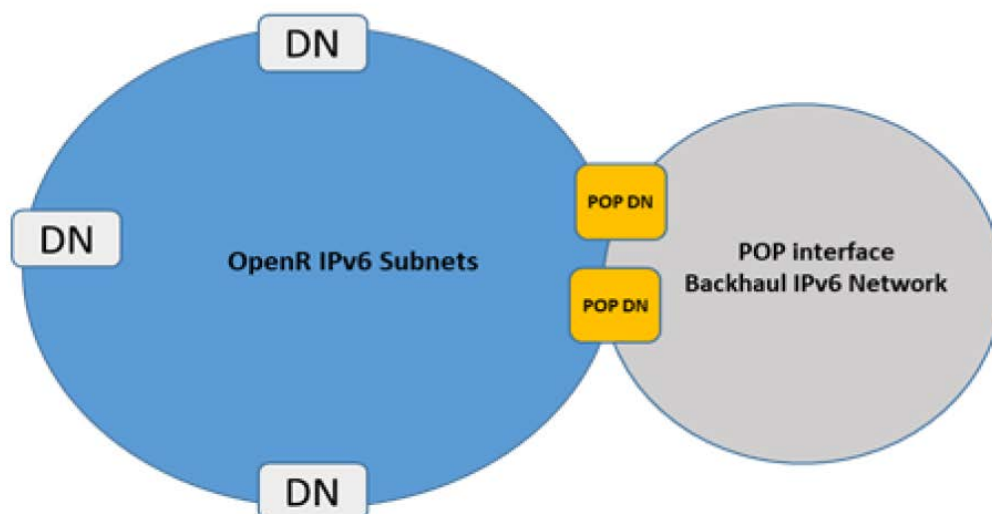

Reserved IPv6 address space

If the operator let the system automatically generate the IPv6 addresses for the network, the following private IPv6 address spaces are reserved:

- FD00:CEED::0/32 for seed prefix of the mesh network
- FD00:BA5E::0/32 for all the PoP nodes and the E2E Controller

E2E and cnMaestro deployment consideration

While the E2E and cnMaestro are two separate entities, they can be hosted on separate computers or the same computer. While the E2E communicates with the cnMaestro using IPv4, the E2E communicates with the cnWave radios using IPv6.

Ethernet bridging

Layer 2 (L2) bridging

L2 Bridge employs Ethernet over GRE (EoGRE) to carry the customer traffic across the Terragraph network. When L2 Bridge is enabled, all CNs and DNs automatically create an EoGRE tunnel with their PoP node and the PoP node creates a tunnel back to each of those CNs/DNs. The tunnel is capable of carrying both IPv4 and IPv6 customer traffic between CN and PoP. The IPv6 over the tunnel can be optionally disabled from the UI.

An ingress Ethernet frame from a customer's network must not exceed 1942 bytes. On top of this, the device (CN, DN, or PoP) adds 58 bytes of tunnel headers. Hence, the maximum size of an encapsulated Ethernet frame is 2000 bytes.

If the device nodes are configured to insert VLANs (native Q or native QinQ), additional room must be left free for that in the ingress Ethernet frame.

Broadcast/Multicast control

The downstream broadcast can be controlled by explicitly disabling it from the UI. Disabling IPv6 over the tunnel also reduces the downstream multicast traffic.

Limitations

- In bridge mode, the V5000 PoP node can forward 1.8 Gbps of TCP traffic and 2.0 Gbps of UDP traffic in the down-link direction.

Layer 2 Bridge support in multi-PoP deployments

This feature applies to Layer 2 bridging and Deterministic Prefix Allocation (DPA) are configured to be used in the network.

In the Terragraph network, CNs and DNs are allocated prefixes from a seed prefix. There are various ways for allocating prefixes. In DPA, the controller assigns prefix zones to PoPs based on the network topology to allow PoP nodes to take advantage of summarizing the route and helps in load balancing ingress traffic.

CNs and DNs get prefixes from the respective PoP zone which is allocated by the controller. CNs and DNs see multiple PoP nodes in the mesh, they select PoP to form GRE tunnel, by matching their lo IPv6 address with PoPs lo IPv6 address. The longest prefix match is selected as the best PoP for L2 GRE Tunnel establishment. The multi-PoP setup gives the advantage that user data traffic can take alternate

routes if the best route is unavailable for some reason. Open/R makes this selection to route the traffic. If PoP is unavailable, CNs and DNs switch to the next best PoP. They however keep track of their primary PoP availability and switch to it once it becomes online.

External Layer 2 Concentrator support

The external device can be used as an L2 GRE Concentrator. Concentrator could be a Linux server or any router or switch supporting IPv6 L2 GRE tunnels. Example: Juniper MX 100.

Select the **Static** tunnel concentrator option and provide an IPv6 address to configure the external concentrator IPv6 address.

Figure 60: Layer 2 Tunnel Concentrator

Layer 2 Bridge

Enable Layer 2 bridge
By selecting this checkbox, you will be enabling Layer 2 network bridging (via automatically created tunnels) across all nodes connected to a PoP. This will facilitate bridging of IPv4 traffic across the wireless networks.

Tunnel Concentrator

Best PoP Static

Tunnel Concentrator IPv6 Address

E.g. 2001:a20:c305:ff00::2

Concentrator can be a PoP device or an external switch/router

Multi-PoP deployments

You must take care of the following aspects in the multi-PoP deployments:

- [Layer 2 domain](#)
- [Open/R on the PoP interface port](#)
- [MTU of upstream switch ports](#)
- [Prefix allocation](#)

Layer 2 domain

All cnWave PoP nodes must be connected to the same Layer 2 broadcast domain. PoP nodes learn about other PoP nodes using IPv6 multicast packets, which do not cross broadcast domain.

This allows cnWave PoP nodes to forward traffic to other cnWave PoP nodes via a wired connection when the routing path of the other PoP node is closer to the traffic's destination. This concept is called Tromboning, as the traffic enters one PoP node and then leaves to another PoP node.

Open/R on the PoP interface port

PoP interface port must be configured to run the Open/R protocol. To enable this option, select **Multi-PoP/ Relay port Interface**.

Figure 61: Multi-PoP/Relay Port Interface

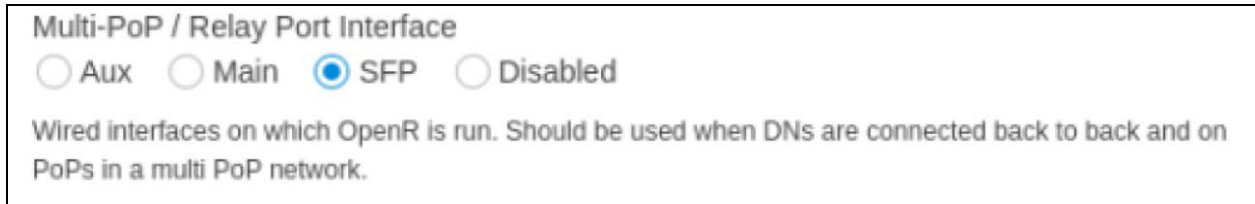

MTU of upstream switch ports

PoP ports use a 2000 MTU size. So, all the switch ports must be at least 2000 MTU size. Even if the user traffic is limited to 1500 sized packets, switch ports should allow the higher MTU size. The following packets exchanged between the PoPs that can be of higher size:

- Open/R packets,
- L2GRE packets (in Layer 2 mode), and
- Software download packets.

Prefix allocation

It is recommended to select the Deterministic Prefix Allocation option for multi-PoP deployments.

Figure 62: The prefix allocation options



Layer 2 control protocols

60 GHz cnWave identifies layer 2 control protocols (L2CPs) from the Ethernet destination address or Ethertype of bridged frames. The QoS classification can be separately configured for these protocols.

Ethernet port allocation

The user must decide how the three ODU Ethernet ports are allocated to the data service, management service and Local Management Service based on the following rules:

- Map the Data Service to at least one of the available wired Ethernet ports.
- Map the Management Service to In-Band, or any combination of the remaining unused Ethernet ports. If the Management Service is mapped to In-Band, it shares all the ports selected for the Data Service. The Management Service can be disabled by mapping to None.
- Map the Local Management Service to any combination of the remaining unused Ethernet ports. The Local Management Service can be disabled by mapping to None.

The LAN configuration page ensures that the management agent can always be reached using either the management service or the local management service.

IP Interface

Select the IP version for the IP interface of the ODU management agent. 60 GHz cnWave can operate in IPv4 mode (via L2 tunneling), IPv6 mode. Choose one IPv4 address and/or one IPv6 address for the IP interface of the ODU management agent. The IP address or addresses must be unique and valid for the connected network segment and VLAN.

Find out the correct subnet mask (IPv4) or prefix length (IPv6) and gateway IP address for this network segment and VLAN.

Ensure that the design of the data network permits bidirectional routing of IP datagrams between network management systems and the ODUs. For example, ensure that the gateway IP address identifies a router or another gateway that provides access to the rest of the data network.

Daisy-chaining 60 GHz links

When connecting two or more 60 GHz cnWave links together in a network (daisy-chaining), do not install direct copper CAT5e connections between the PSUs. Each PSU must be connected to the network terminating equipment using the LAN port. To daisy-chain 60 GHz cnWave links, install each ODU-to-ODU links using one of the following solutions:

- A copper CAT5e connection between the Aux ports of two ODUs.
- A copper CAT5e connection between the Aux port of one ODU and the SFP port of the next ODU (using a copper SFP module).
- Optical connections between the ODUs (SFP ports) using optical SFP modules at each ODU.



Note

Wherever CAT5e is applicable, you can use CAT5e or better category cables. Similarly, you can use CAT6 or better category cables wherever CAT6 is applicable.

Installation

Safety



Warning

To prevent loss of life or physical injury, observe the following safety guidelines. In no event shall Cambium Networks be liable for any injury or damage caused during the installation of the Cambium 60 GHz cnWave radio nodes. Ensure that only qualified personnel install 60 GHz cnWave radios.



Attention

Pour éviter toute perte de vie ou blessure physique, respectez les consignes de sécurité suivantes. En aucun cas Cambium Networks ne pourra être tenu responsable des blessures ou dommages causés lors de l'installation des nœuds radio Cambium 60 GHz cnWave. Assurez-vous que seul du personnel qualifié installe les radios cnWave 60 GHz.

Power lines

Exercise extreme care when working near power lines.

Working at heights

Exercise extreme care when working at heights.

PSU

Always use one of the approved power supply options. Failure to use the Cambium supplied PSUs can result in equipment damage and will invalidate the safety certification and may cause a safety hazard.

Grounding and protective earth

The cnWave radios must be properly grounded to protect against lightning. It is the user's responsibility to install the equipment in accordance with national regulations. In the USA follow the requirements of the National Electrical Code NFPA 70-2005 and 780-2004 *Installation of Lightning Protection Systems*. In Canada, follow Section 54 of the *Canadian Electrical Code*. These codes describe correct installation procedures for grounding the outdoor unit, mast, lead-in wire, and discharge unit, size of grounding conductors, and connection requirements for grounding electrodes. Other regulations may apply in different countries and therefore it is recommended that installation of the outdoor unit be contracted to a professional installer.

AC Supply

Always use an appropriately rated and approved AC supply cord-set in accordance with the regulations of the country of use.

Powering down before servicing

Before servicing 60 GHz cnWave equipment, always switch off the power supply and unplug it from the PSU.

Do not disconnect the RJ45 drop cable connectors from the radio while the PSU is connected to the power supply. Always remove the AC or DC input power from the PSU.

Primary disconnect device

The primary disconnect device is the main power supply.

External cables

Safety may be compromised if outdoor rated cables are not used for connections that are exposed to the outdoor environment.

Drop cable tester

The PSU output voltage may be hazardous in some conditions such as wet weather. Do not connect a drop cable tester to the PSU, either directly or via LPUs.

RF Exposure near the antenna

Strong Radio Frequency (RF) fields are present close to the antenna when the transmitter is ON. Always turn off the power to the radio before undertaking maintenance activities in front of the antenna.

Minimum separation distances

Ensure that personnel is not exposed to unsafe levels of RF energy. The units start to radiate RF energy as soon as they are powered up. Never work in front of the antenna when the radio is powered. Install the radios to provide and maintain the minimum separation distances from all persons. For minimum separation distances, see [Calculated distances and power compliance margins](#).

Grounding and lightning protection requirements

Ensure that the installation meets the requirements defined in the [Installation](#) section.

Grounding cable installation methods

To provide effective protection against lightning-induced surges, observe these requirements:

- Grounding conductor runs are as short, straight and smooth as possible, with bends and curves kept to a minimum.
- Grounding cables must not be installed with drip loops.
- All bends must have a minimum radius of 200 mm (8 in) and a minimum angle of 90°. A diagonal run is preferable to a bend, even though it does not follow the contour or run parallel to the supporting structure.
- All bends, curves and connections must be routed towards the grounding electrode system, ground rod/ground bar.
- Grounding conductors must be securely fastened.
- Braided grounding conductors must not be used.
- Approved bonding techniques must be used for the connection of dissimilar metals.

Siting radios

Radios are not designed to survive direct lightning strikes. For this reason they must be installed in Zone B as defined in *Lightning protection zones*. Mounting in Zone A may put equipment, structures, and life at risk.

60 GHz cnWave radios and mounting bracket options

The 60 GHz cnWave series supports eight mounting bracket options. Select the optimum mounting bracket arrangement based on the ODU type and the choice of wall or pole mounting. The wall mount plate for V1000 and V5000 are included with the ODU. Order the remaining brackets separately.

Table 39: ODU mounting bracket part numbers

Bracket	Pole diameter	ODU variants	Bracket part number
V1000 pole mount	25 mm to 70 mm (1 inch to 2.75 inches)	V1000	Included with V1000
V1000 wall mount	Wall mount	V1000	Included with V1000
V1000 adjustable pole mount	25 mm to 70 mm (1 inch to 2.75 inches)	V1000	N000900L022A
V2000 Adjustable pole mount	25 mm to 70 mm (1 inch to 2.75 inches)	V2000	Included with V2000
V3000 precision bracket	25 mm to 70 mm (1 inch to 2.75 inches)	V3000	C000000L125A
V3000 tilt bracket assembly	25 mm to 70 mm (1 inch to 2.75 inches)	V3000, V5000	N000045L002A
V3000 tilt bracket assembly with band clamps	The diameter range depends on the clamps used.	V3000, V5000	N000045L002A + third-party band clamps
V5000 pole mount	25 mm to 70 mm (1 inch to 2.75 inches)	V5000	C000000L137A
V5000 wall mount	Wall mount	V5000	C000000L136A

Installing the cnWave radio nodes

To install the radio, use the following procedure and guidelines:

1. [Typical installation](#)
2. [ODU interface with LPU on the pole](#)
3. [SFP and Aux Ethernet interfaces](#)
4. [Attach ground cables to the radio](#)
5. [Mounting the ODU](#)

Typical installation

V1000

Consider the following key points when installing V1000:

1. Use the recommended grounding and surge suppressor connections.
2. Use the recommended cables for interfacing ODU (refer to the supported power supply and cable length details in the [Power supply units \(PSU\)](#) section).
3. Always install the ODU 0.5 meters below the tip of the pole.

Figure 63 shows a typical installation of V1000 CN on a mast and powered through PoE power injector.

Figure 63: Typical installation - V1000 CN

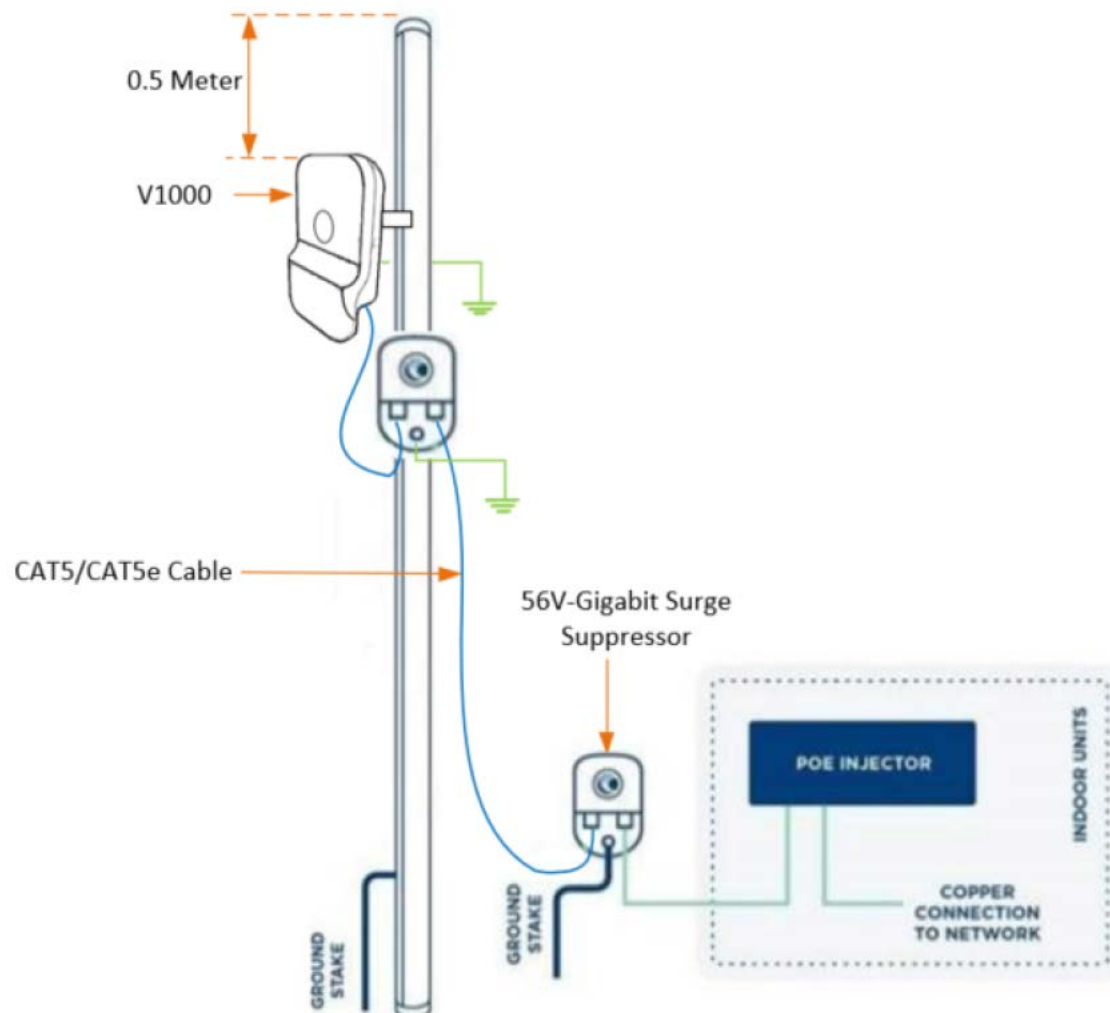

V2000

Consider the following key points when installing V2000:

1. Use the recommended grounding and LPU connections.
2. Use the recommended cables for interfacing ODU (refer to the supported power supply and cable length details in the [Power supply units \(PSU\)](#) section).
3. Always install the ODU 0.5 meters below the tip of the pole.

Figure 64 shows a typical installation of V2000 CN on a mast and powered through outdoor AC/DC PSU.

Figure 64: Typical installation - V2000 CN

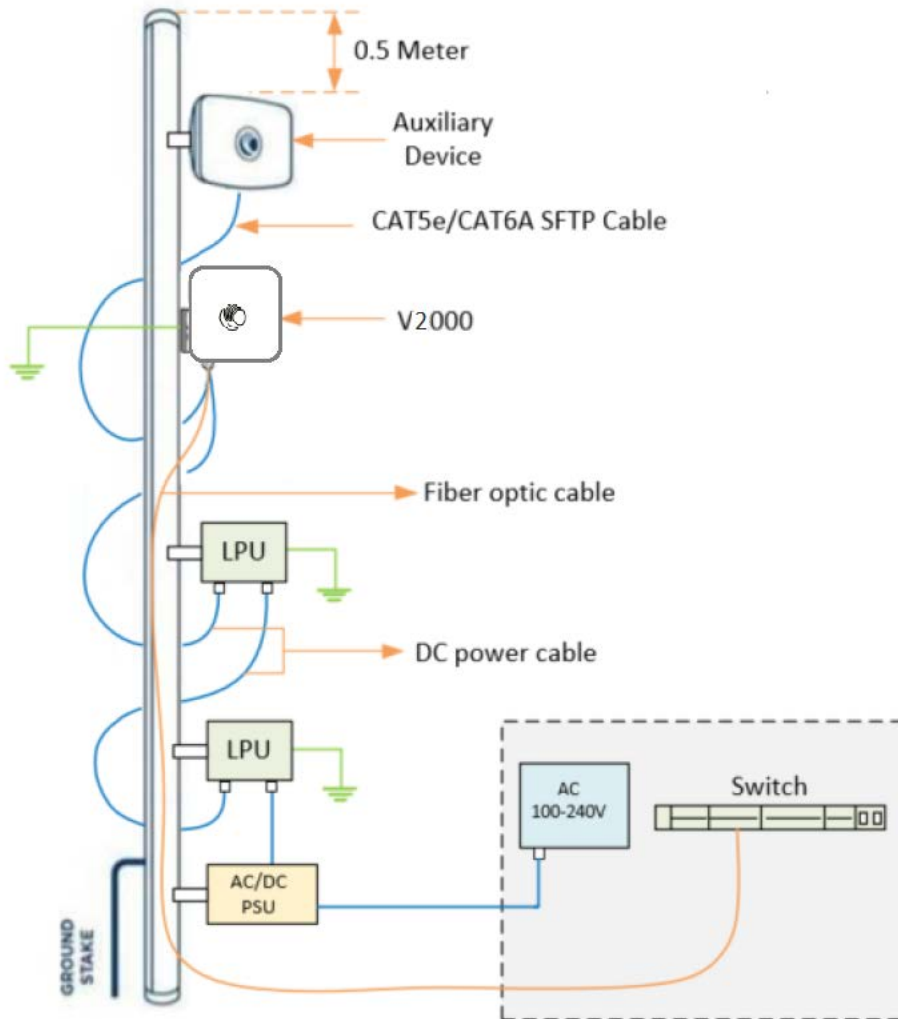

V3000

Consider the following key points when installing V3000:

1. Use the recommended grounding and LPU connections.
2. Use the recommended cables for interfacing ODU (refer to the supported power supply and cable length details in the [Power supply units \(PSU\)](#) section).
3. Always install the ODU 0.5 meters below the tip of the pole.

Figure 65 shows a typical installation of V3000 CN on a mast and powered through outdoor AC/DC PSU.

Figure 65: Typical installation - V3000 CN

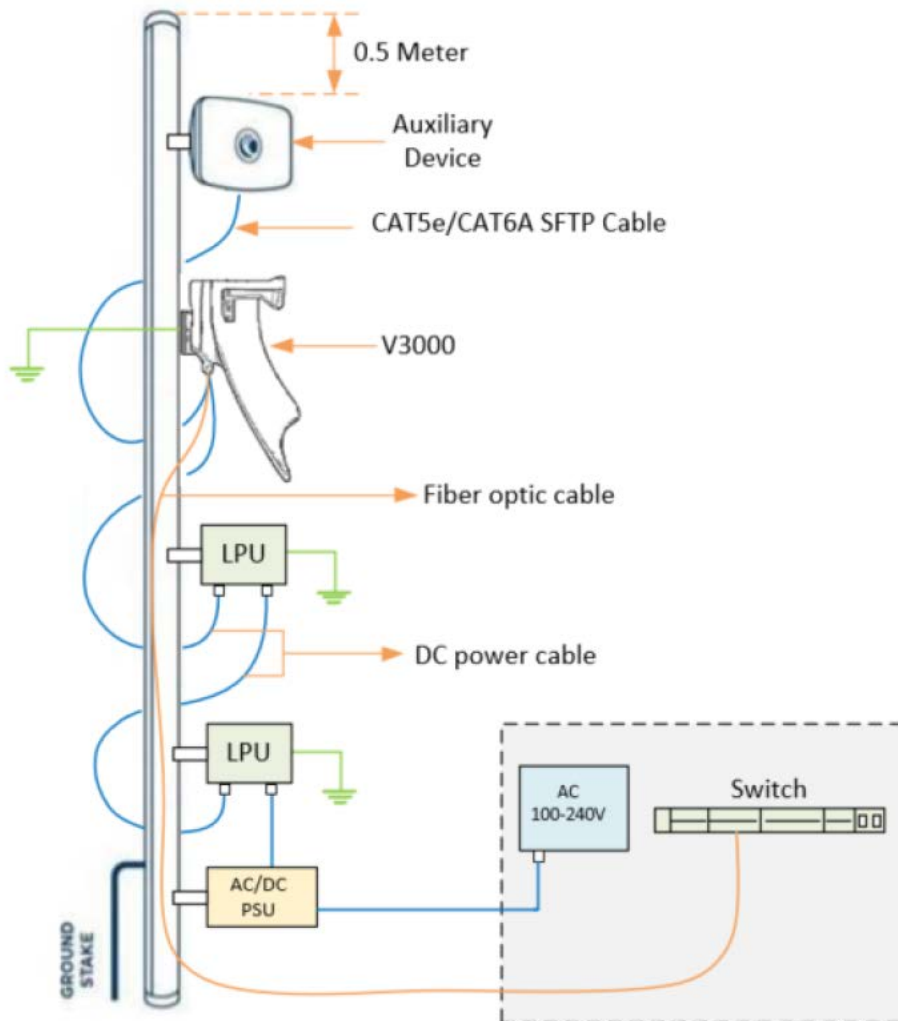

V5000

Consider the following key points when installing V5000:

1. Use the recommended grounding and LPU connections.
2. Use the recommended cables for interfacing ODU (refer to the supported power supply and cable length details in the [Power supply units \(PSU\)](#) section).
3. Always install the ODU 0.5 meters below the tip of the pole.

Figure 66 shows a typical installation of cnWave DN on a mast and powered through outdoor AC/DC PSU.

Figure 66: Typical installation - V5000 DN

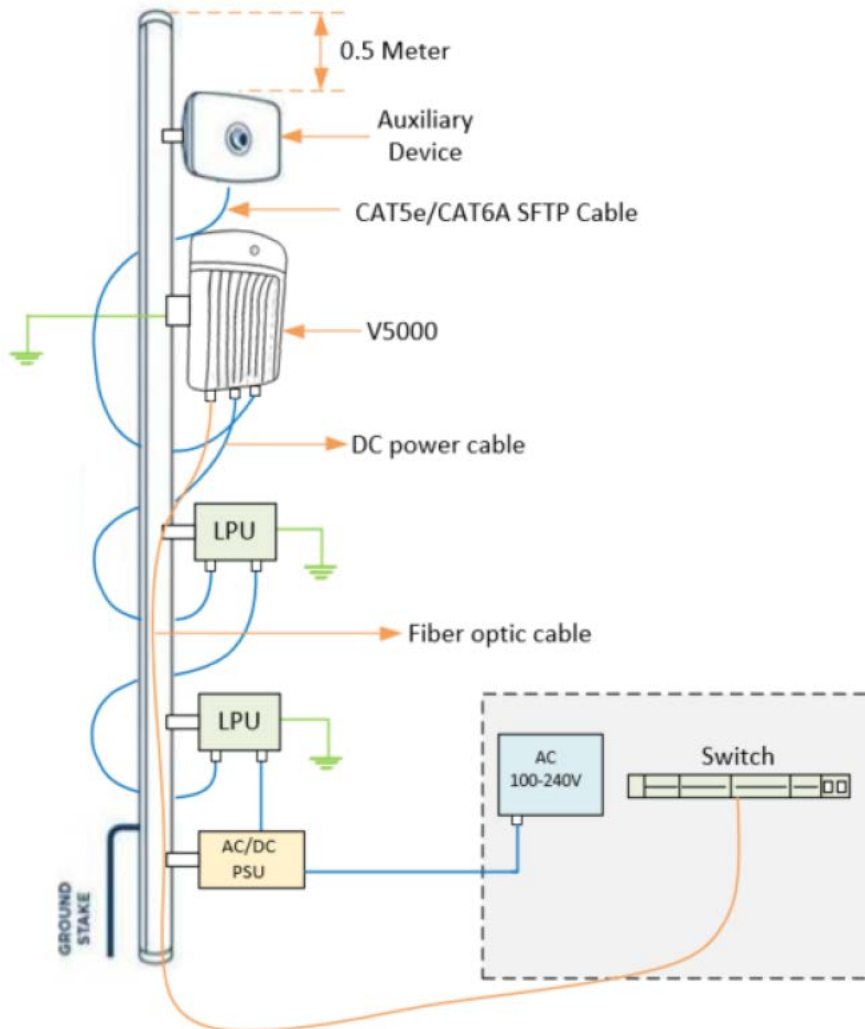

ODU Interface with LPU on the pole

V1000:

You can install the V1000 CN on a pole. During the installation, use the 56V Gigabit Surge Suppressor for lightning protection. Ensure that the cable glands and grounding connections are made, as shown in Figure 67.

Figure 67: Installing the V1000 CN on a pole

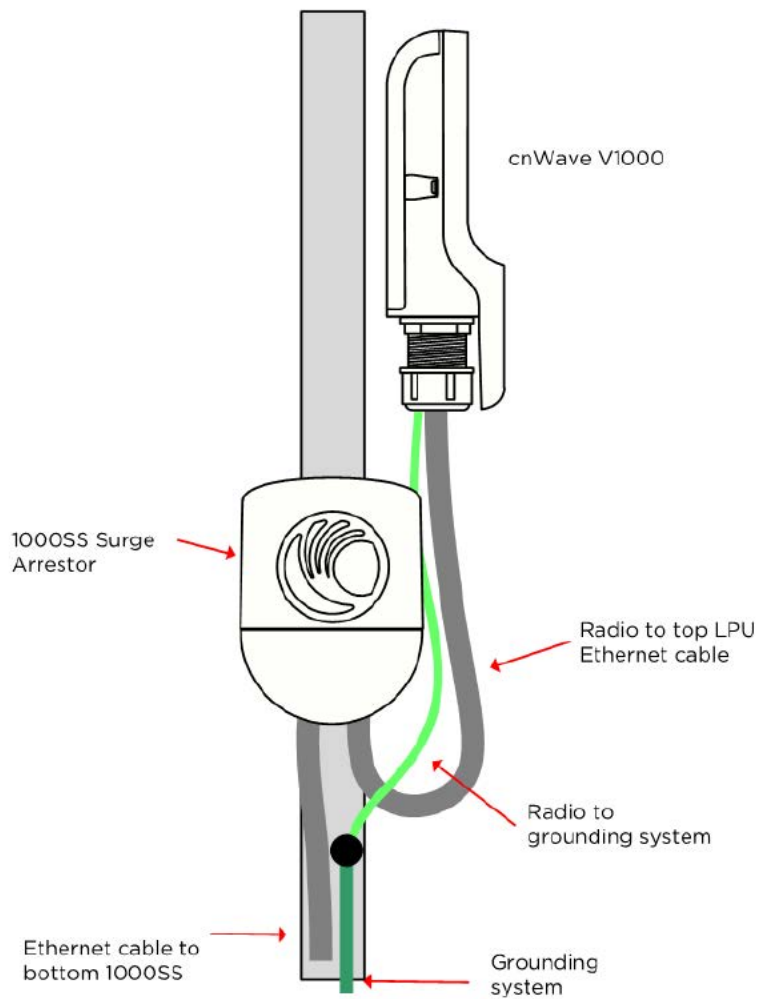

V2000:

During the installation of V2000 CN on a pole, use the 56V Gigabit surge suppressor for lightning protection. Ensure that the cable glands and grounding connections are made, as shown in [Figure 68](#).

Figure 68: Installing the V2000 CN on a pole

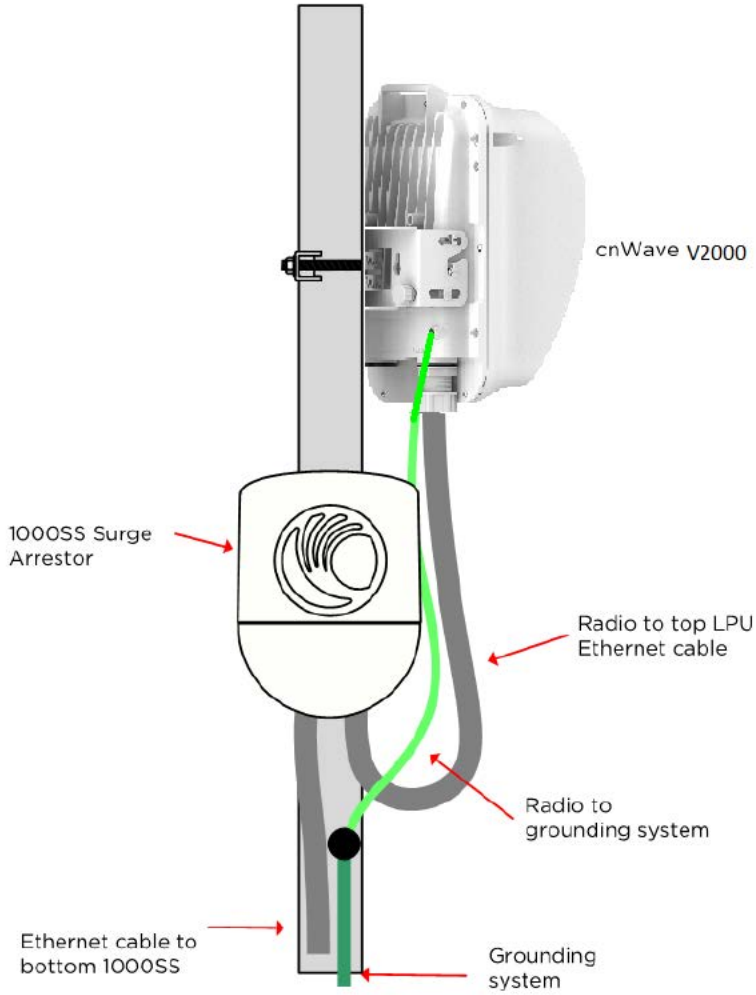

V3000:

You can install the V3000 CN on a pole using a precision bracket. During the installation, Use a recommended LPU for surge protection. Ensure glands and grounding connections are made, as shown in Figure 69.

Figure 69: Installing the V3000 CN on a pole

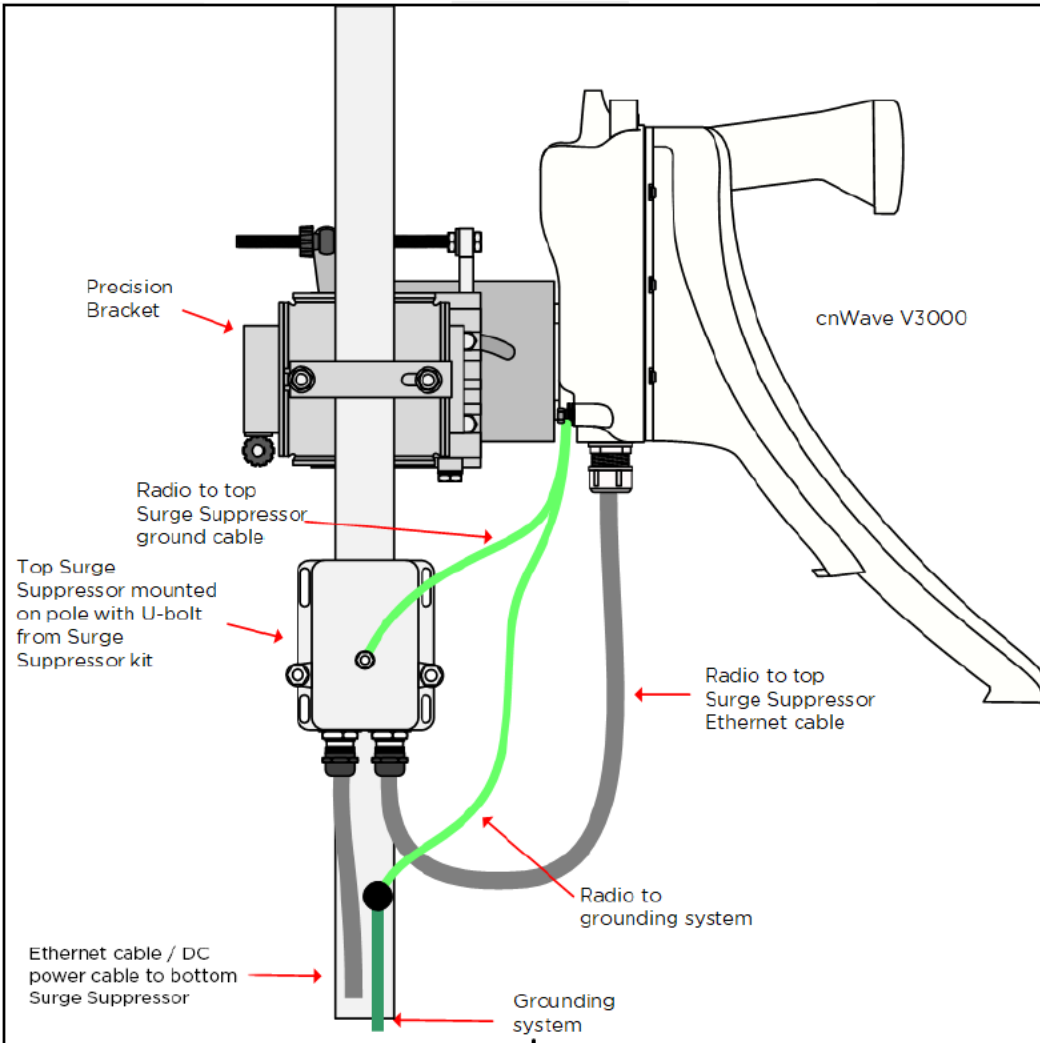

V5000:

You can install the V5000 DN on a pole using a tilt bracket. Use the recommended LPU for surge protection. Ensure glands and grounding connections are made, as shown in [Figure 70](#).

Figure 70: Installing the V5000 DN on a pole

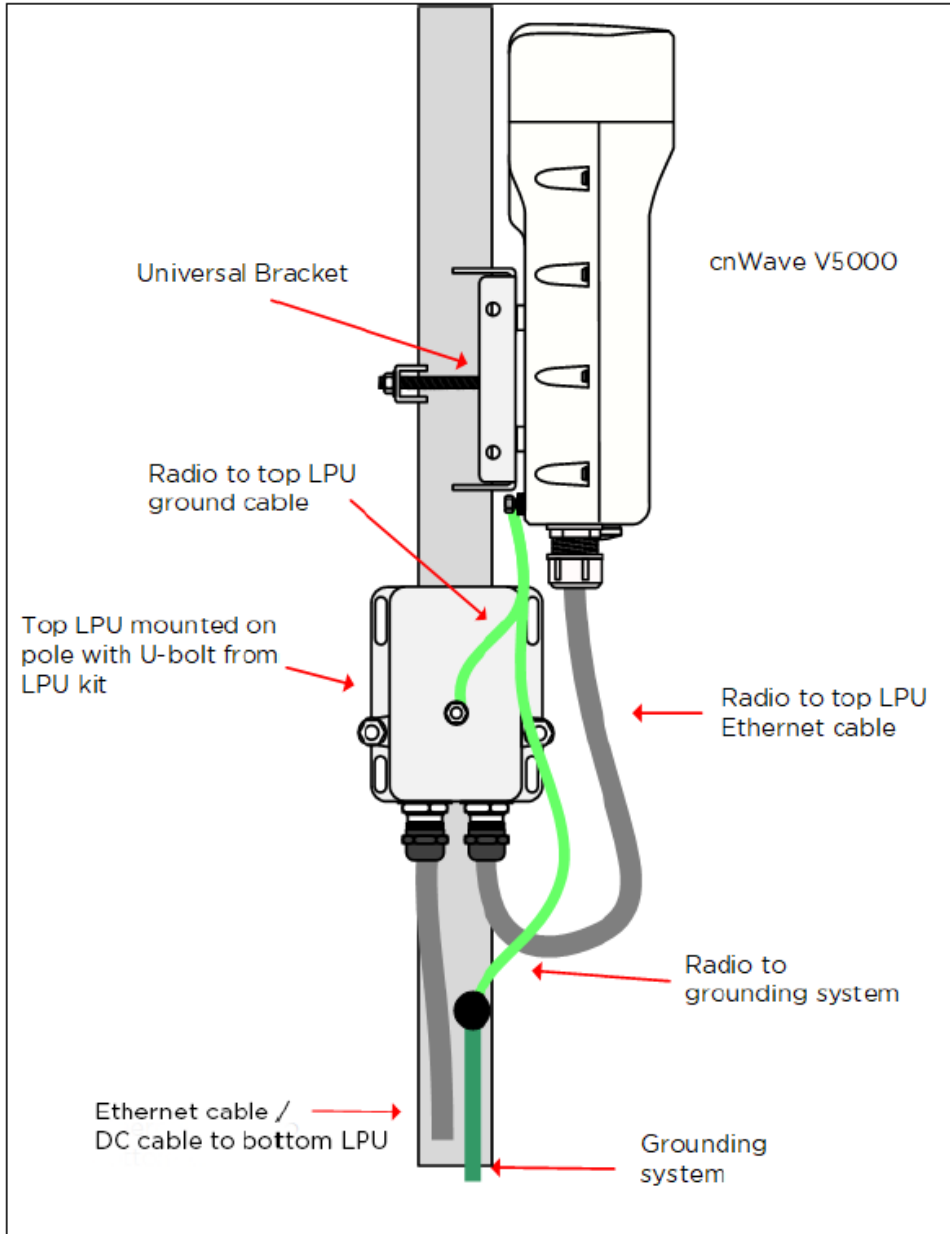

Attach ground cables to the radio

1. Fasten the ground cable to the radio grounding point using the M6 lug.

Figure 71: Radio grounding point



2. Tighten the ODU grounding bolt to a torque of 5 Nm (3.9 lb-ft).

Mounting the ODU

Select the most appropriate bracket mounting arrangement from the options listed in the [Mounting bracket options](#). Refer to individual procedures below for each of the options:

- [V1000 Pole mount](#)
- [V1000 Wall mount](#)
- [V1000 Adjustable pole mount](#)
- [V2000 Adjustable pole mount](#)
- [V3000 Precision bracket](#)
- [V3000 Tilt bracket assembly](#)
- [V3000 Tilt bracket assembly with band clamps](#)
- [V5000 Pole mount bracket](#)
- [V5000 Wall mount bracket](#)

V1000 Pole mount

The V1000 CN can be installed to a pole using the supplied mounting plate and jubilee clip. Follow the below instructions to mount V1000 to the pole:

1. Insert the hose clamps through the mounting plate and clamp to the pole by applying 3.0 Nm torque.

Figure 72: Inserting the hose clamps

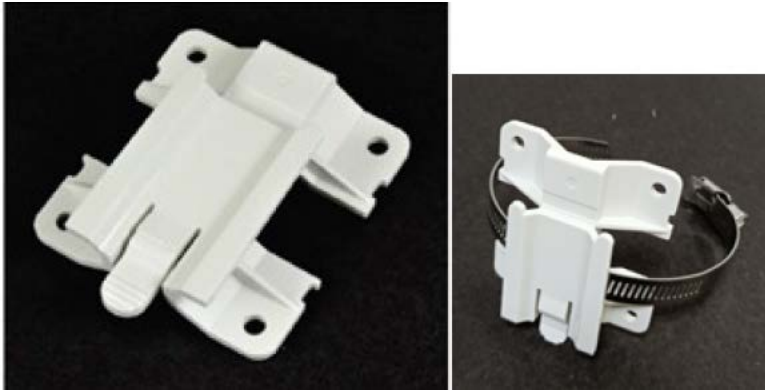

2. Insert the radio into the mounting plate on the pole.

Figure 73: Inserting the radio



V1000 Wall mount

Follow the below instructions to mount V1000 on the wall:

1. Fix the mounting plate (supplied with the V1000 ODU) securely to a vertical wall, using suitable fixings.



Note

Fixing hardware is not supplied with the V1000.

2. Slide the V1000 ODU onto the mounting plate from above, ensuring that the spring clip in the mounting plate clicks into place on the radio.

Figure 74: Fixing the mounting plate and the spring clip

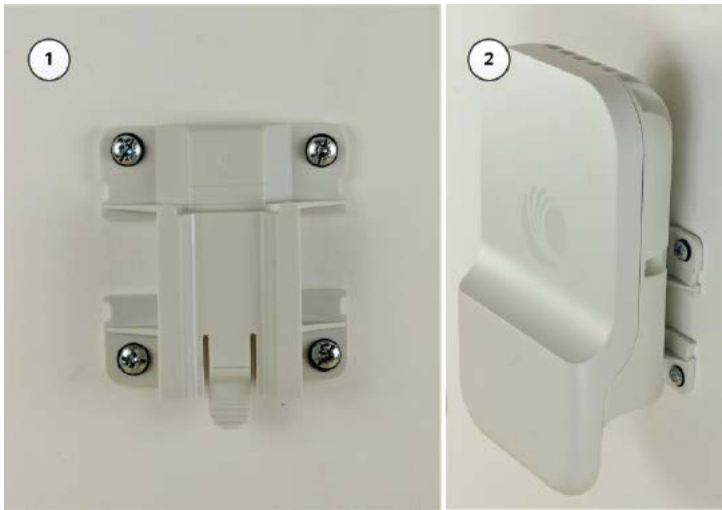

V1000 Adjustable pole mount

Follow the below instructions to mount V1000 to the adjustable pole:

1. Insert the hose clamps through the adjustable pole mount bracket and clamp to the pole by applying 3.0 Nm torque.

Figure 75: Fixing hose clamps through adjustable pole mount bracket



2. Insert the radio into the adjustable pole mount bracket on the pole.

Figure 76: Fixing the radio on the pole



The adjustment can be made up to maximum ± 30 degrees and each serration movement is 5 degrees.

V1000 Alignment

The V1000 CN requires minimal effort to align as the internal antenna can beam steer ± 40 degrees in azimuth and ± 20 degrees in elevation from boresight. If the unit is installed with the remote node visible within this range, no further adjustment is required.

V2000 Adjustable pole mount

You can install the V2000 CN on a pole using a jubilee clip (hose clamps). Perform the following steps to mount the V2000 CN on a pole:

1. Insert the two hose clamps through the adjustable mounting bracket and clamp it to the pole by applying 5.0 Nm torque, as shown in [Figure 77](#).

Figure 77: Fixing V2000 to a pole



2. Align the device by viewing through the eye piece and the notch on radome, as shown in Figure 78.

Figure 78: Aligning the V2000 device

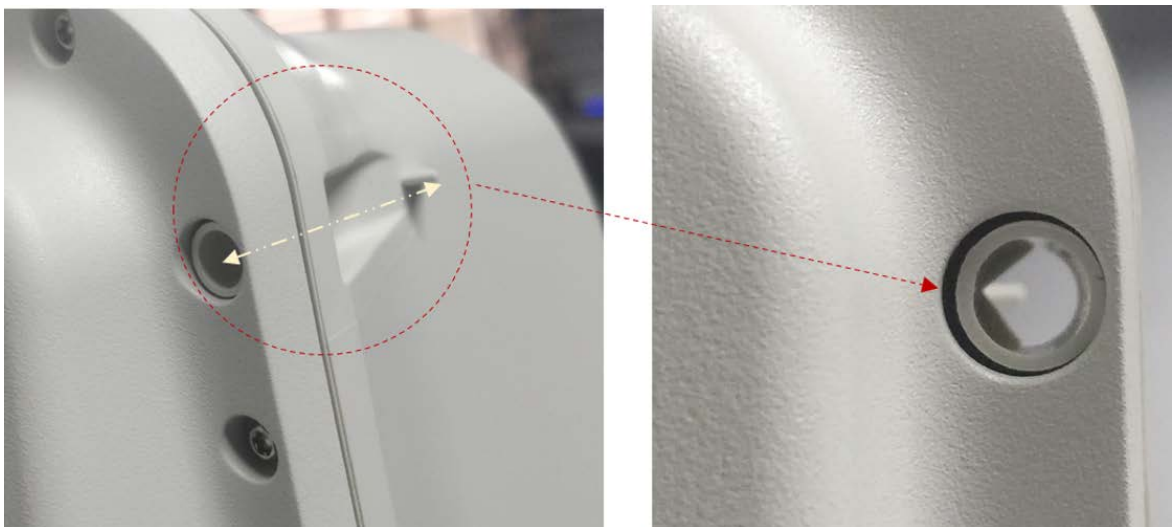

3. Use the bracket knob (as shown in Figure 80) to rotate fine adjustable bracket until the alignment is complete in the elevation plane.

The adjustable bracket supports fine adjustment of up to $\pm 20^\circ$ in elevation for an accurate alignment.

Figure 79: Aligning V2000



Figure 80: Using the adjustable bracket knob for alignment

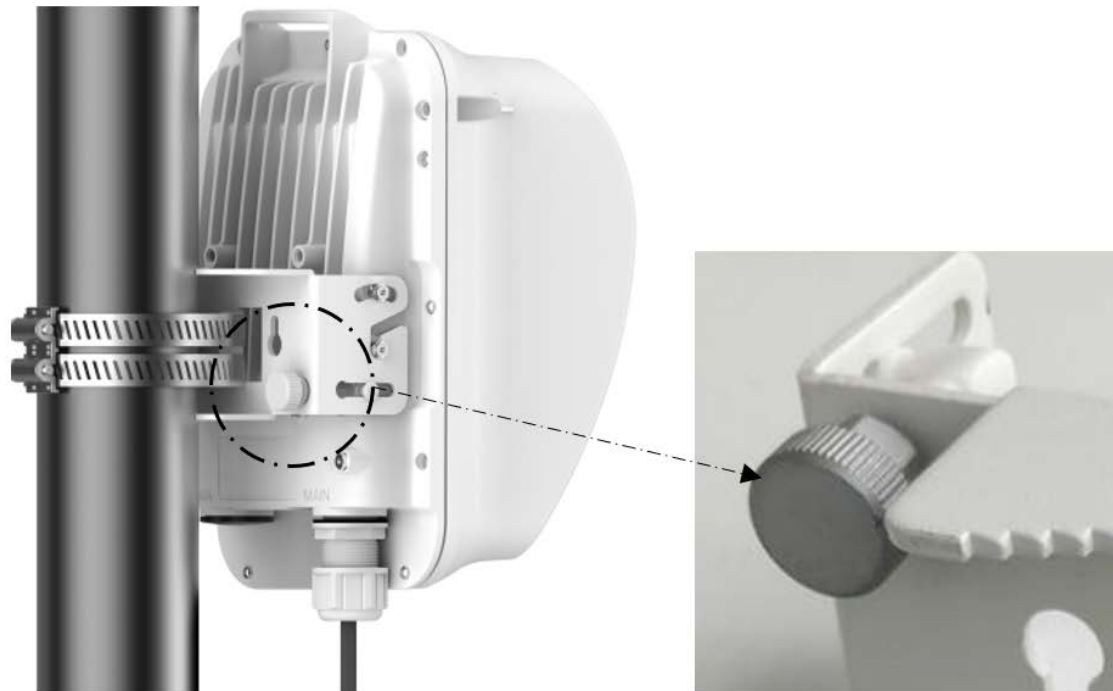

V2000 Antenna alignment

The V2000 CN requires minimal effort to align as the internal antenna can beam steer ± 10 degrees in azimuth and ± 4.5 degrees in elevation from boresight. If the unit is installed with the remote node

visible within this range, no further adjustment is required.

V3000 Precision bracket

The precision bracket is used to mount the cnWave V3000 CN on a vertical pole, providing fine adjustment up to 18° in azimuth and $\pm 30^\circ$ in elevation for accurate alignment of the V3000. The precision bracket is compatible with pole diameters in the range of 25 mm to 70 mm (1 inch to 2.75 inches). Note that the Jubilee clamp allows for larger diameter poles and the range depends on the clamps used.

These instructions illustrate the procedure for assembling and using the precision bracket. The mounting of the optional alignment telescope also explained.

Figure 81: V3000 Precision bracket

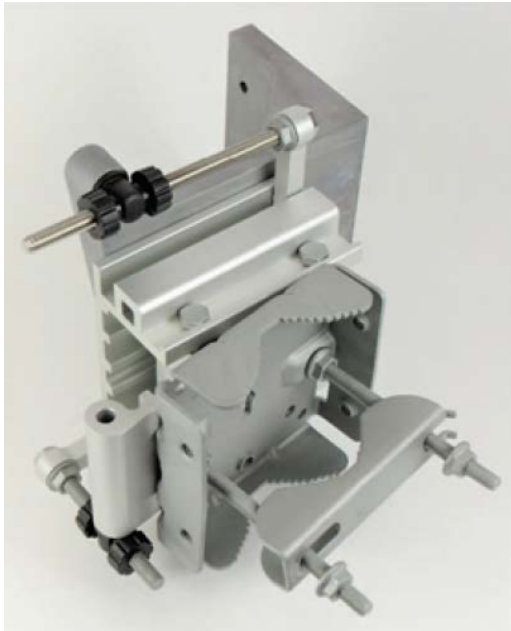

1. Insert two of the long (120 mm) screws through the azimuth arm and the bracket body. The screws are located in the slots in the azimuth arm.

Figure 82: Two screws in the slots of the azimuth arm



2. Fit two flanged M8 nuts to the long screws on the back of the bracket. Tighten using a 13 mm spanner.

Figure 83: Two MB nuts on the back of bracket

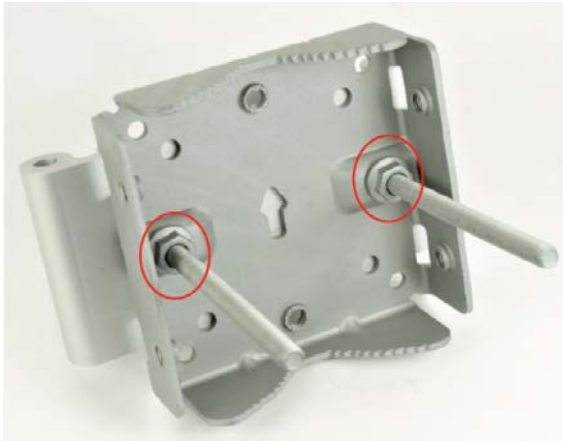

3. Insert the three medium-length (40 mm) M8 screws through the bracket base and the V3000 mount. The screws are located in the slots in the bracket base.

Figure 84: MB Screws in the slots in the bracket base

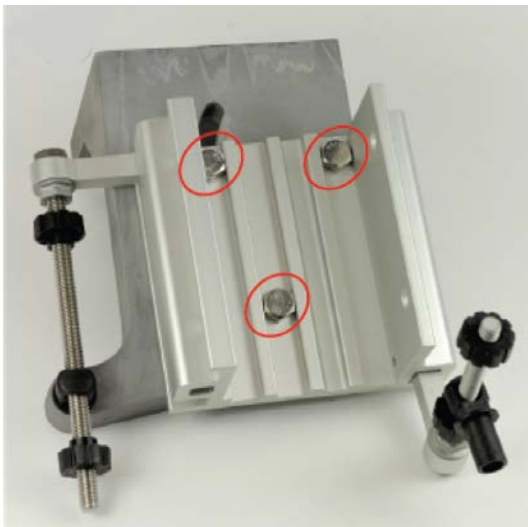

You must ensure that the pivot pin in the elevation adjuster is located in the circular hole in the V3000 mount.

Figure 85: The pivot pin in the circular hole of mount



4. Fit plain washers and M8 Nyloc nuts to the screws on the back of the bracket base. Tighten using a 13 mm spanner.

Figure 86: Plain washers and M8 Nyloc nuts on the back of the bracket



5. Insert the two remaining long (120 mm) M8 screws through the bracket body and the azimuth arm. The screws must be located in the slots in the bracket body.

Figure 87: MB Screws located in the slots in the bracket body

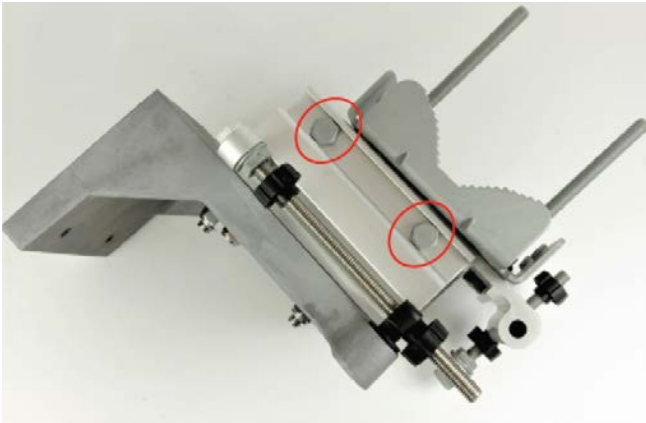

You must ensure that the pivot pin in the azimuth adjuster is located in the circular hole in the bracket body.

Figure 88: The pivot pin in the circular hole of bracket body

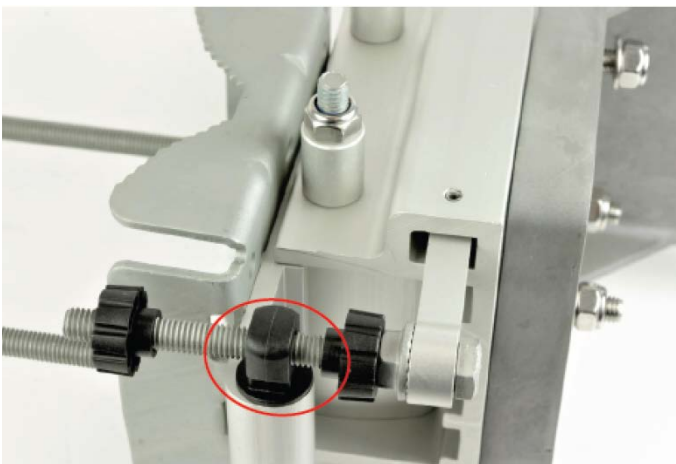

6. Fit three sets of spacers, plain washers and M8 Nyloc nuts to the screws on the underside of the bracket base. Tighten using a 13 mm spanner.

Figure 89: Fixing pacers, plain washers and M8 Nyloc nuts



7. Attach the V3000 mount to the radio using the four short M6 bolts. Tighten the four bolts to a torque setting of 5.0 Nm (3.7 lb-ft) using a 13 mm spanner or socket.

Figure 90: Attaching the V3000 mount



8. Attach the precision bracket to the pole using the clamp and the remaining flanged nuts. Adjust azimuth approximately and tighten the nuts to 10 Nm (7.4 lbft) using a 13 mm spanner.

Figure 91: Attaching the precision bracket



9. Lock the antenna alignment by tightening the five Nyloc nuts (see [step 5](#) and [step 8](#)) to 10 Nm (7.4 lb-ft) using a 13 mm spanner or socket.

Figure 92: Locking the antenna alignment



Note

Visit the [Cambium Learning website](#) to learn more about the precision bracket assembly.

Precision bracket alignment

1. Ensure that the three Nyloc screws for securing the bracket in elevation are loose and the fine elevation adjuster is holding the weight of the unit.

Figure 93: Three Nyloc screws on the unit



2. Ensure the two Nyloc screws securing the bracket in the azimuth are loose.

Figure 94: Two Nyloc screws in the azimuth



3. Before starting the mechanical alignment, move the fine elevation adjuster $\frac{2}{3}$ of the way across the screw until the unit is sitting at approximately 0 degrees in elevation.

Figure 95: Moving the elevation adjuster



4. Move the fine azimuth adjuster to approximately the center of the available range and lock it in position.

Figure 96: Moving the azimuth adjuster



5. Loosen the clamp which attaches the bracket to the pole until there is enough freedom to rotate the unit in azimuth.
6. From behind the unit, using the sight to aim towards the remote node, rotate the unit until it is approximately aligned in azimuth. Tighten the clamp.
7. While looking for the far node through the site, rotate the fine elevation adjuster until the alignment is complete in the elevation plane. One turn of the adjustment wheel is equivalent to approximately one degree of elevation. Lock the fine elevation adjuster screws in place.

Figure 97: Locking the fine elevation adjuster



You can use the **alignment tube** for adjustment, as described in [Fixing the alignment tube](#).

8. While looking for the far node through the site, rotate the fine azimuth adjuster until the alignment is complete in the azimuth plane. One turn of the adjustment wheel is equivalent to approximately one degree of azimuth. Lock the fine azimuth adjuster screws in place.
9. Make any remaining adjustments to the elevation and azimuth as required. Once complete, tighten the three Nyloc screws in place to fix the elevation alignment and do the same for the two Nyloc screws for azimuth alignment to 10 Nm (7.4 lbft) using a 13 mm spanner or socket.

Precision bracket alignment - optional telescope

1. Attach the telescope mount to the V3000 radio using the knurled screw.
2. Attach the telescope by looping the two elastic O-rings over the ears of the mount, ensuring that the telescope is located securely in the mount.

Figure 98: Attaching the telescope



3. If a telescope with a smaller body is used, shorten the O-rings by twisting.
4. Following the previously described precision bracket alignment method, align the radio starting with the site, and fine-tune using the scope for increased accuracy.

Fixing the alignment tube for V3000

Perform the following steps to fix the alignment tube for V3000:

1. Slide the alignment tube through the alignment slot, as shown in [Figure 99](#).

[Figure 99](#): *Sliding the alignment tube*

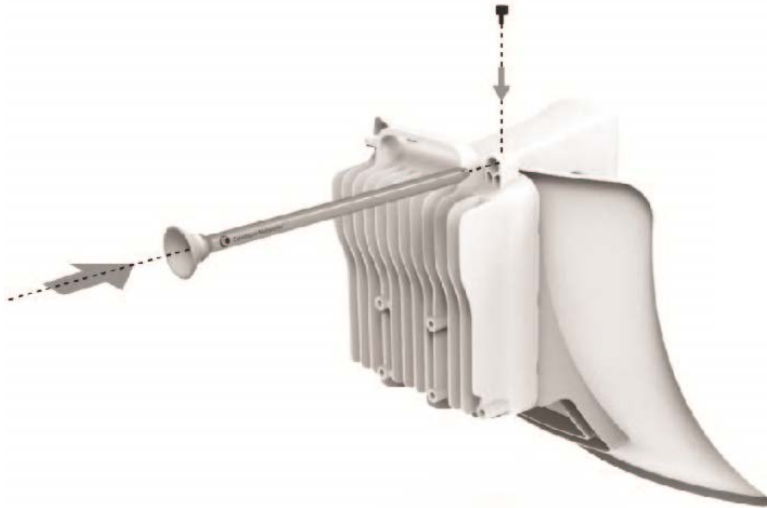

2. Tighten the screw to fix the alignment tube in place, as shown in [Figure 100](#).

The tube fits into the circular area.

[Figure 100](#): *Fixing the alignment tube*



3. Align the device by viewing through the eyepiece, as shown in [Figure 101](#).

Figure 101: *Aligning the device*



V3000 Tilt bracket assembly

1. Fix the mounting plate of the tilt bracket to the back of the radio using four of the short bolts, ensuring that the arrow in the plate points towards the top of the radio. Tighten the four bolts to a torque setting of 5.0 Nm (3.7 lb-ft) using a 13 mm spanner or socket.

Figure 102: *Fixing the mounting plate of the tilt bracket*



2. Fit the two long bolts through the bracket body so that the bolt heads engage in the slots as shown. Fit two of the short bolts into the side of the bracket body but do not tighten.

Figure 103: Fixing two long and short bolts

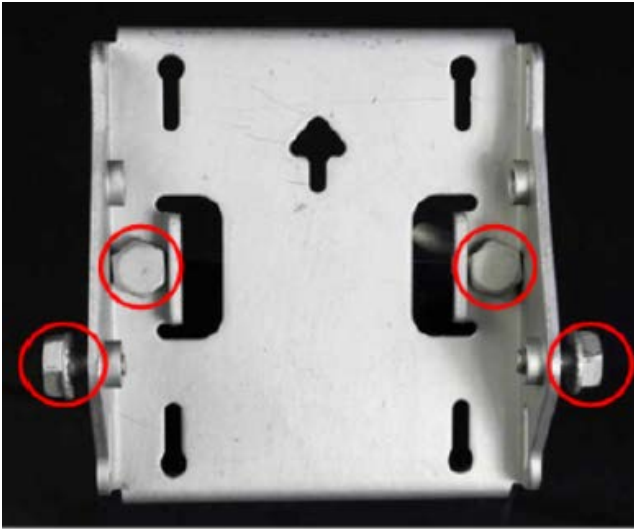

3. Thread two of the nuts to the long bolts and tighten against the bracket body using a 13 mm spanner. Fit the bracket strap and thread the remaining nuts onto the long bolts.

Figure 104: Fixing the bracket strap

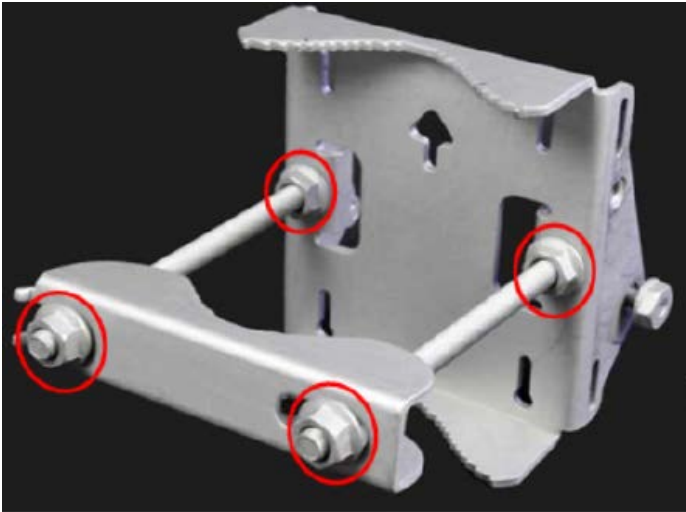

4. Fix the assembled bracket body to the pole, adjust the azimuth angle, and tighten the nuts to a torque setting of 10.0 Nm (7.4 lb-ft) using a 13 mm spanner, ensuring that the arrow in the body is pointing upwards.

Figure 105: Fixing the assembled bracket body

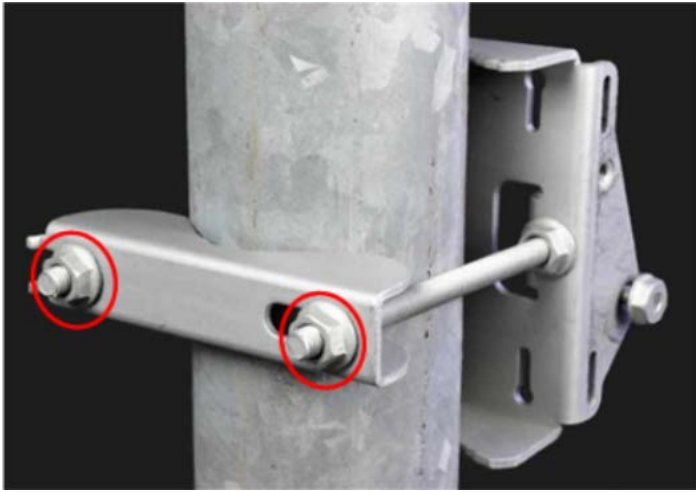

5. Fit the mounting plate to the bracket body by positioning the open- ended slots over the short bolts. Insert the remaining short bolts through the longer curved slots into the threaded holes in the bracket body. Adjust the elevation angle and tighten the bolts to a torque setting of 5.0 Nm (3.7 lb-ft) using a 13 mm spanner or socket.

Figure 106: Fixing the mounting plate and adjusting the elevation

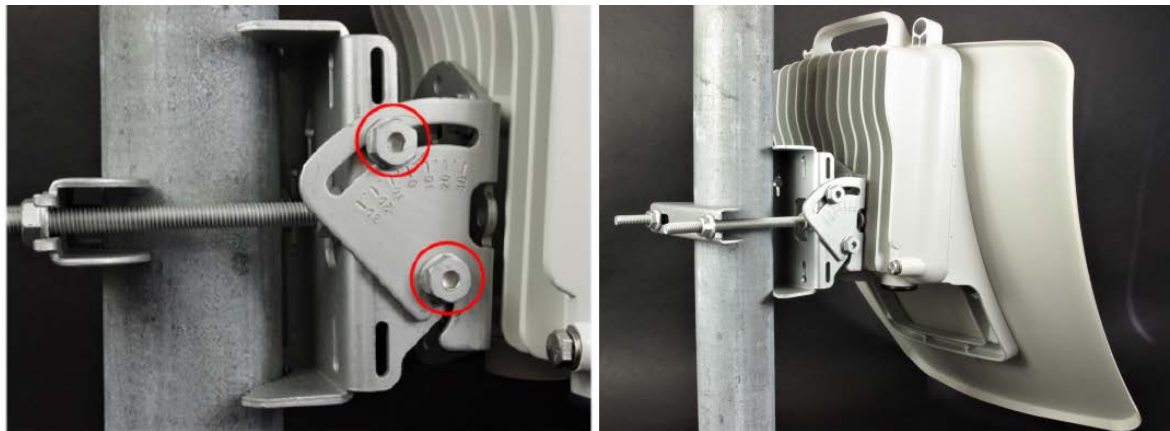

V3000 Tilt bracket assembly with band clamps

Follow the below instructions to assemble the tilt bracket with band clamps:

1. Follow step 1 of the [V3000 tilt bracket assembly](#) procedure.
2. Feed the band clamps through the slots in the bracket body. Secure the bracket body to the pole using band clamps (not supplied by Cambium), ensuring that the arrow in the body is pointing upwards. Adjust the azimuth angle, and tighten the band clamps to a torque setting of 6.0 Nm (4.5 lb-ft).
3. Fix the mounting plate to the bracket body with four of the short bolts, using a 13 mm spanner or socket. Adjust the elevation angle, and tighten the bolts to a torque setting of 5.0 Nm (3.7 lb-ft).

Figure 107: Fixing the mounting plate of bracket body and adjusting the elevation angle

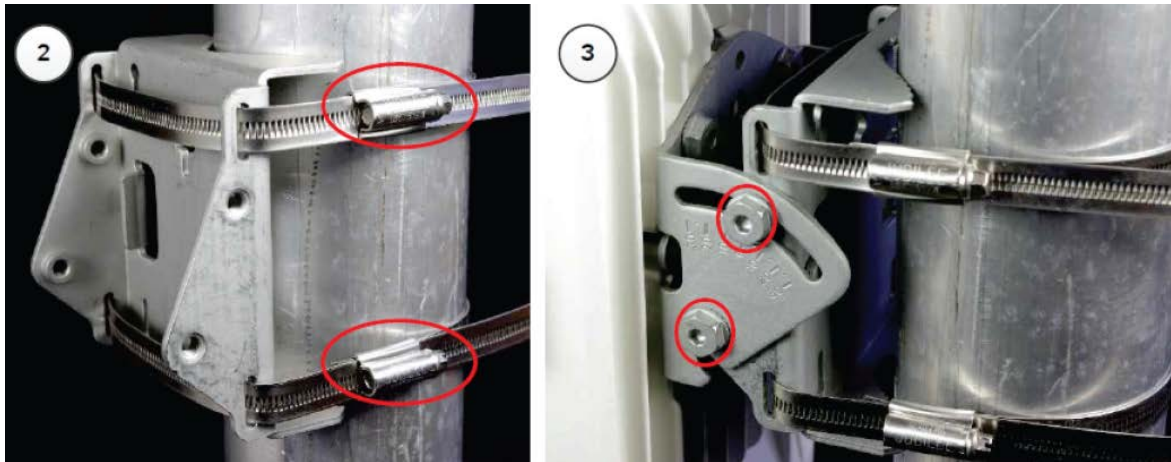

V5000 Pole mount bracket

1. Pass the long screws through the bracket body. The screws are located in the recess in the bracket.
2. Fit two flanged nuts to the long screws on the back of the bracket. Tighten using a 13 mm spanner.
3. Fix the bracket to the back of the radio using the four short M6 bolts, ensuring that the arrow in the plate points towards the top of the radio. Tighten the four bolts to a torque setting of 5.0 Nm (3.7 lb-ft) using a 13 mm spanner or socket.
4. Attach the pole-mount bracket to the pole using the clamp and the remaining flanged nuts. Adjust azimuth and tighten the nuts to 10 Nm (7.4 lbft) using a 13 mm spanner.

Figure 108: Fixing the V5000 pole mount bracket

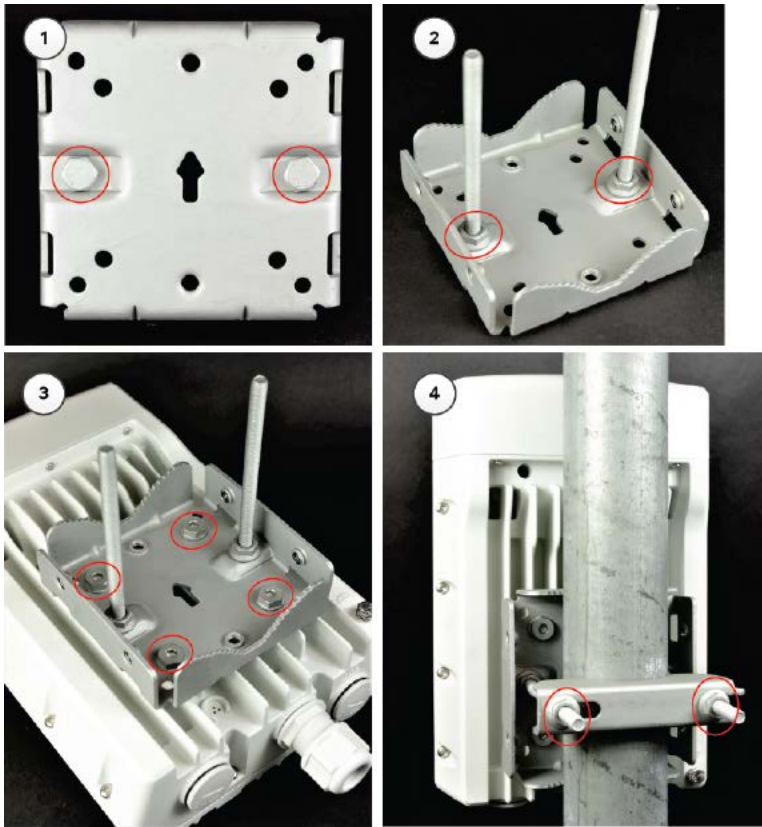

V5000 Alignment

The V5000 distribution node has two sectors, situated side by side, each covering a 140-degree range in azimuth, giving a combined coverage of 280 degrees. In elevation, the antenna can beam steer in a +/- 20-degree range. The boundary between where Sector 1 ends and Sector 2 begins is the centerline/boresight from the unit.

Figure 109: V5000 alignment - Top view

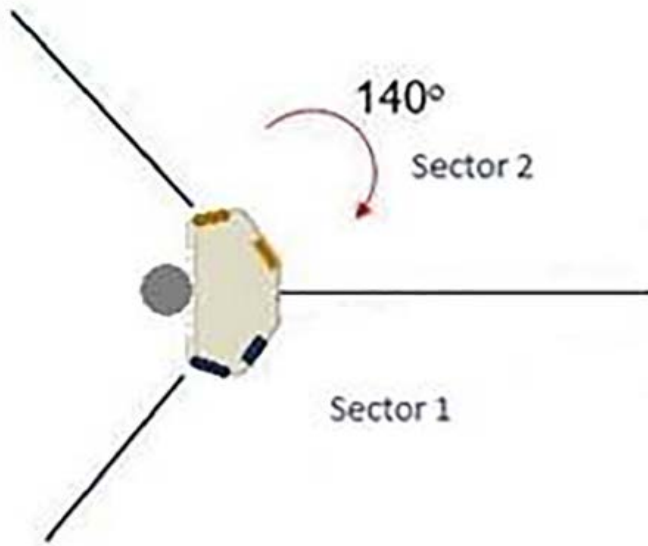

V5000 Wall mount bracket

1. Install the mounting plate of the wall mount bracket securely on a vertical wall, using suitable fixing hardware.



Note

Fixing hardware is not supplied with the wall mount bracket.

2. Fix the bracket body to the back of the radio using the four short M6 bolts, ensure that the arrow in the plate points towards the top of the radio. Tighten the four bolts to a torque setting of 5.0 Nm (3.7 lb-ft) using a 13 mm spanner or socket.
3. Insert the four short M8 bolts into the sides of the bracket body.
4. Fit the bracket body to the mounting plate by positioning the short bolts into the open-ended slots.

Tighten the bolts to a torque setting of 5.0 Nm (3.7 lb-ft) using a 13 mm spanner or socket.

Figure 110: Fixing the V5000 wall mount bracket

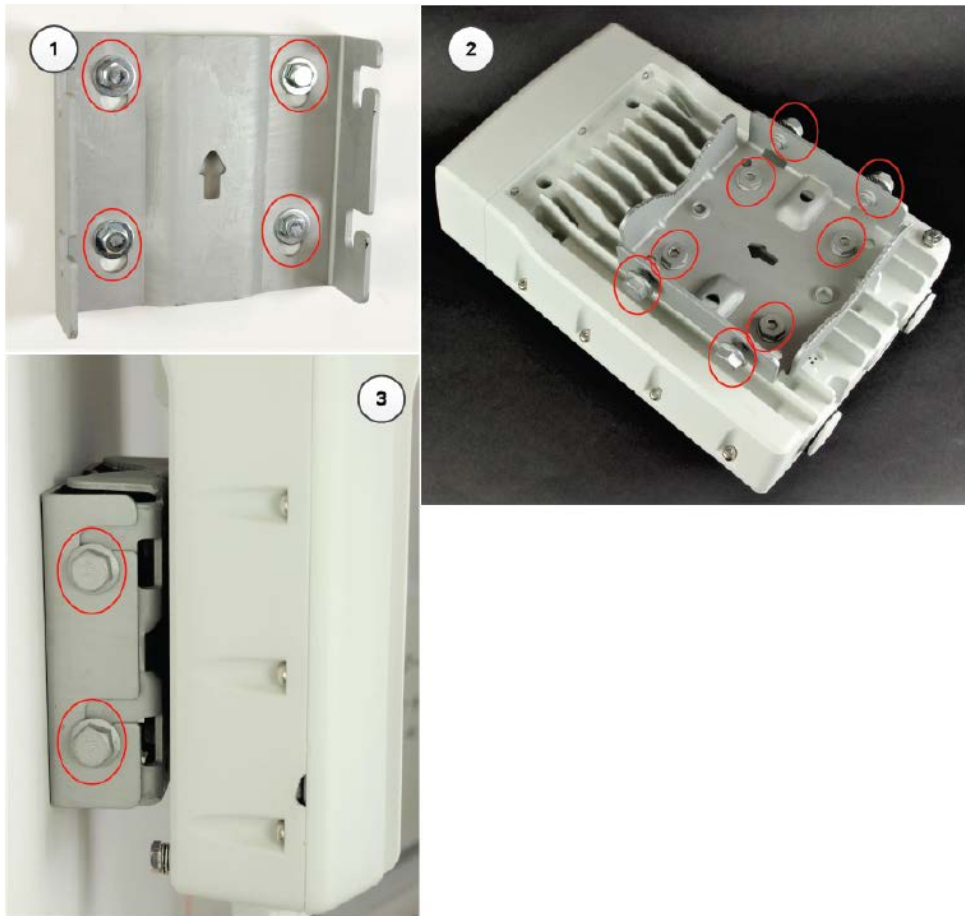

Connect to the PSU port of the radio

Using Power over Ethernet (PoE)

1. Disassemble the gland and thread each part onto the cable (the rubber bung is split). Assemble the spring clip and the rubber bung.

Figure 111: Assembling the spring clip and the rubber bung



2. Fit the parts into the body and lightly screw on the gland nut (do not tighten it).

Figure 112: Fixing the gland nut



3. Connect the RJ45 plug into the main PSU port of the ODU (which can be either V1000, V2000, V3000, or V5000).

Figure 113: Connecting the RJ45 plug



4. Rotate the gland clockwise to tightly fit the gland on the PSU port.



Warning

Ensure that the cable clamp is not attached/ tightened at this stage, this may cause damage to the RJ45 or PCB.

Figure 114: Rotating the gland



5. Tighten the gland (cap or nut), this must be done last. Otherwise, it may damage the RJ45 or PCB.

Disconnecting drop cable from the radio

1. Loosen and remove the cable clamp by rotating anti-clockwise from the PSU port.

Figure 115: Removing the cable clamp



Warning

Loosen the cable clamp completely and then unscrew the gland. Not releasing the cable may cause damage to the RJ45 socket and/or PCB.

2. Remove the gland.

Figure 116: Removing the gland

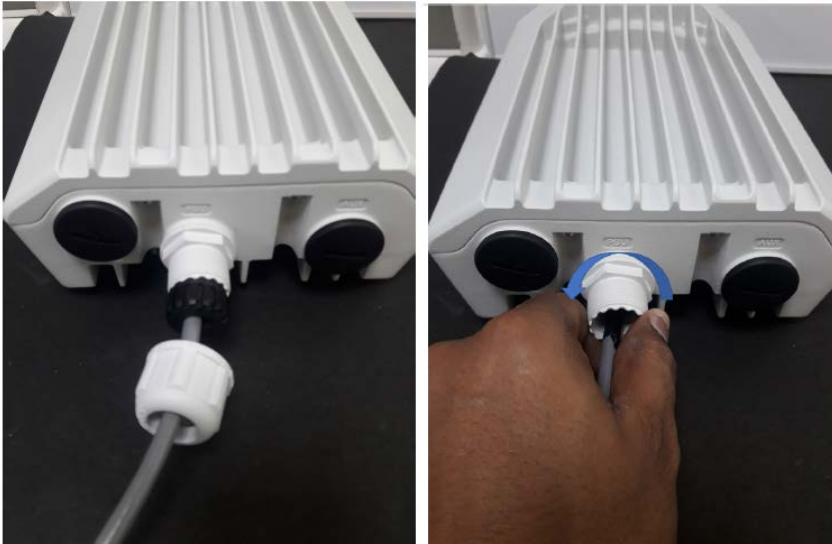

3. Press tab on RJ45 plug to remove the cable from PSU port.
4. Remove the latch of the RJ45 plug to remove the cable from the PSU port.

Figure 117: Removing the latch of the RJ45 plug



Using AC/DC PSU

Cable joiner

A cable joiner is used to connect the wires. Insert the wires into the cable joiner by loosening the screws on the joiner.

Figure 118: Cable joining parts



Figure 119 is an example of connecting wires using the cable joining parts.

Figure 119: Connecting wires

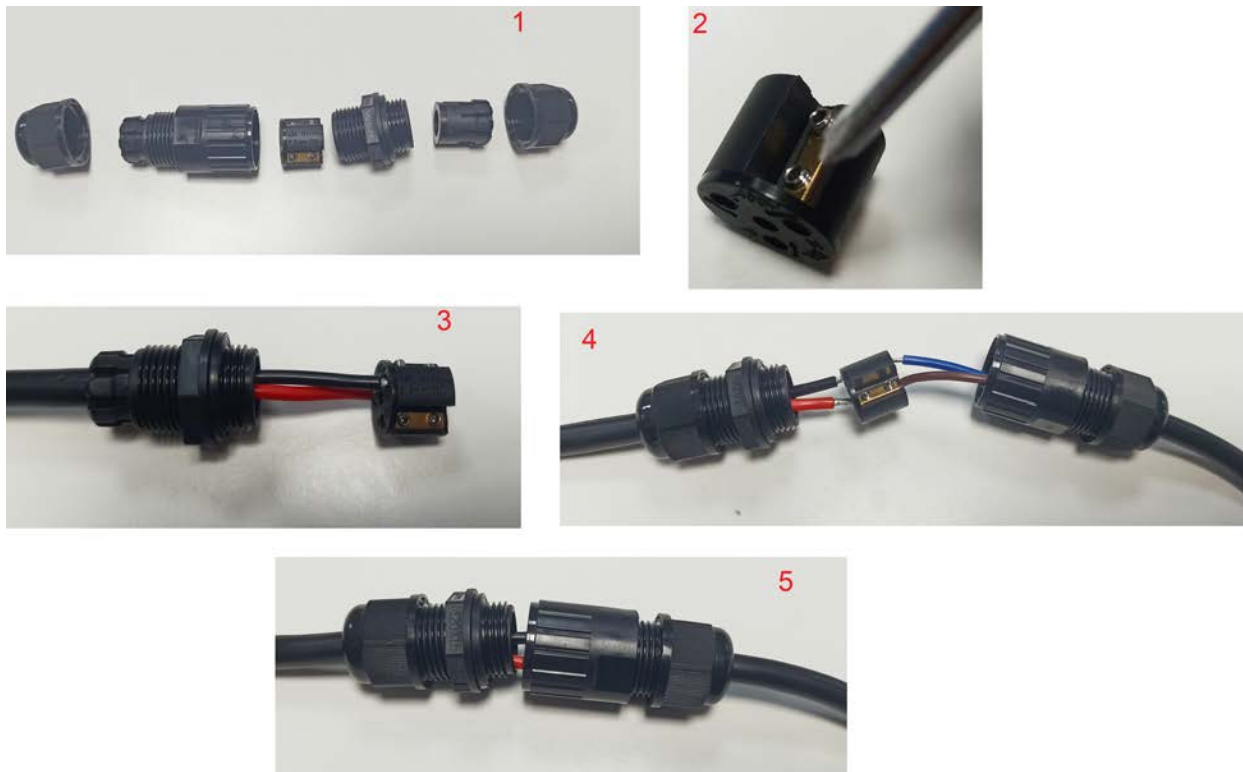

Connecting the mini adapter

Figure 120: Mini adapter connections

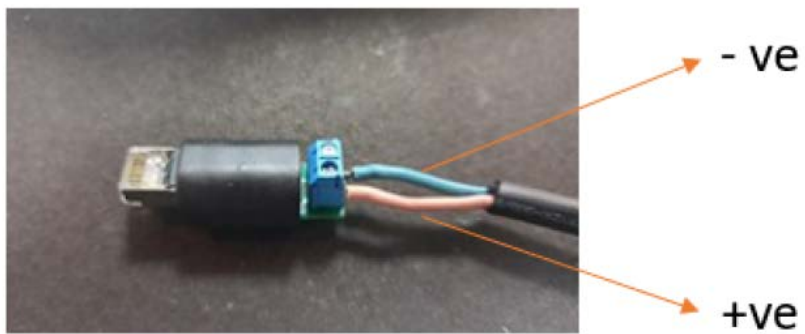

Fitting the long cable gland

Figure 121: *The long cable gland*



Connecting the mini adapter to ODU

1. Plug the input side of the AC/DC PSU to the AC power line and tighten the gland. Tighten the cable clamp cap.

Figure 122: *Connecting the input side of AC/DC PSU*



2. Connect output side of DC PSU to ODU through cable joiner and DC mini adapter.

Figure 123: Connecting the output side of AC/DC PSU



Install the PSU

Install one of the following types of PSU:

- [Installing the 60W DC power injector](#)
- [Installing the AC/DC PSU](#)
- [Installing 15W or 30W power injector](#)

Table 40: Details of PoE injector to be used for cnWave 60 GHz products

Product	Without AUX POE Enabled	With AUX POE enabled
V1000	15W	Not applicable
V2000	30W	60W
V3000	60W	60W
V5000	60W	100W



Warning

Always use an appropriately rated and approved AC supply cord-set in accordance with the regulations of the country of use.



Attention

As the 60W DC power injector and V1000 power injector are not waterproof, locate it away from sources of moisture, either in the equipment building or in a ventilated moisture-proof enclosure. Do not locate the PSU in a position where it may exceed its temperature rating.



Attention

Do not plug any device other than a 60 GHz cnWave ODU into the ODU port of the PSU. Other devices may be damaged due to the non-standard techniques employed to inject DC power into the Ethernet connection between the PSU and the ODU.

Do not plug any device other than a Cambium 60 GHz cnWave PSU into the PSU port of the ODU. Plugging any other device into the PSU port of the ODU may damage the ODU and device.

Installing the 60W DC power injector

1. Connect the input side of the DC power injector to the AC power line.

Figure 124: 60W DC power injector and powering diagram

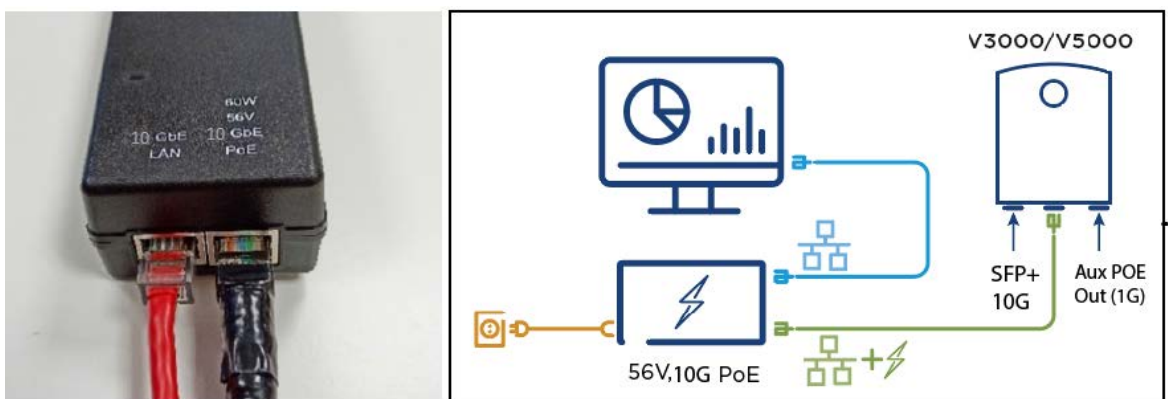

2. Connect 10 Gbe LAN port of the power injector to network equipment.
3. Connect 60 W 56V 10 GbE PoE port of the power injector to ODU drop cable (ODU can be either V3000 or V5000).



Note

For V2000, use the 60 W device, especially when POE Out is required, and the 5 GbE PoE (000000L142A).

Figure 125: Connecting the power injector to ODU drop cable



Installing the AC/DC PSU

1. Connect the input side of the AC/DC PSU to the AC power line.
2. Connect output side of DC PSU to ODU through cable joiner and DC mini adapter. Refer to the [Cable joiner](#) section for connecting, installing cable joiner and mini adapter.

Figure 126: AC/DC PSU (N000000L179B)



Figure 127: Cable joiner



Figure 128: DC to RJ45 plug, mini adapter



Figure 129: AC/DC powering diagram

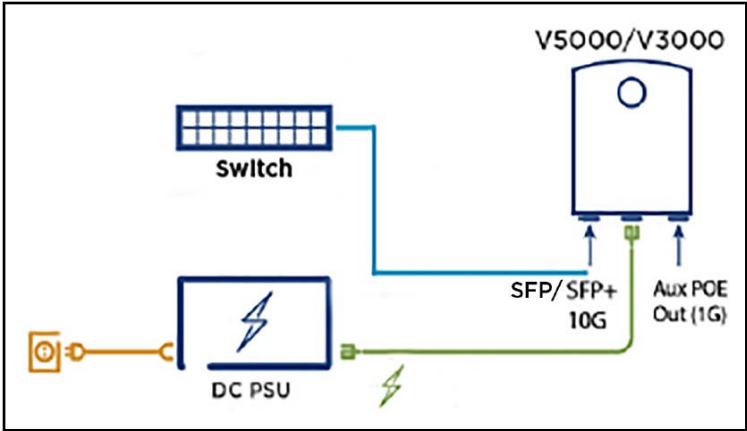

Figure 130: AC/DC PSU



For detailed assembly of cable joiner and mini adapter to ODU PSU port, refer to the [Cable joiner](#) section.



Note
Both short and long glands can be used to connect to outdoor PSU.

Installing 15W or 30W power injector

1. Connect the 56V Gigabit Data and power port to ODU (which can be either V1000 or V2000)

Figure 131: V1000 Power injector



Figure 132: V2000 Power injector



Note

30 W (N000000L034B) supports up to 5 GbE.

Figure 133: V1000 or V2000 Powering diagram

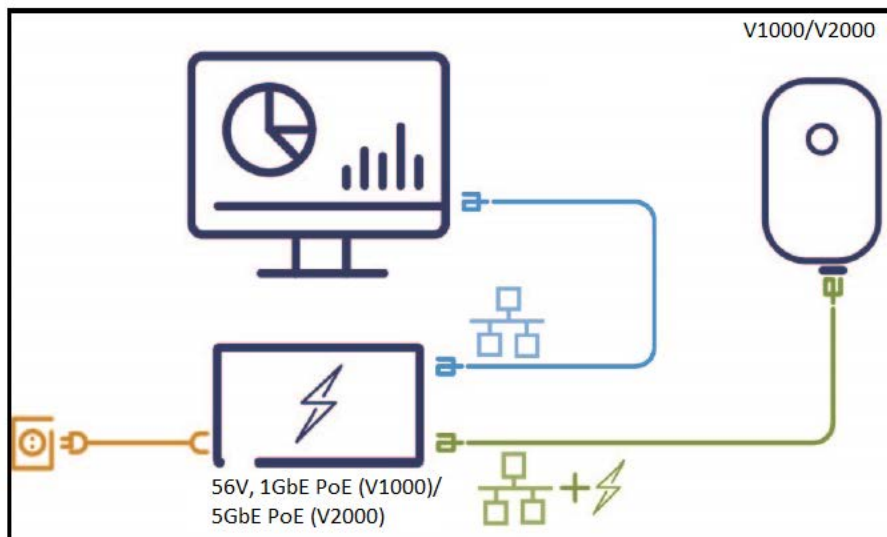

Figure 134: Connecting the V1000 Power injector



Figure 135: Connecting the V2000 power injector



2. Connect the Gigabit data port to the network equipment.

Connecting to the SFP+ optical module or SFP+ to the copper module to ODU

When ODU is powered through AC/DC PSU, an optical or copper Cat6A Ethernet interface can be connected to the SFP port of the ODU for the data interface.

Adapt the installation procedures in this section as appropriate for SFP interfaces, noting the following differences from a PSU interface.

Fitting the long cable gland

Optical SFP interface: Disassemble the long cable gland and thread its components over the LC connector at the ODU end as shown below.

Copper CAT6A SFP interface: Disassemble the cable gland and thread its components over the RJ45 connector at the ODU end.

1. Disassemble the long cable gland used for the optical SFP interface.

Figure 136: Disassembling the long cable gland - optical SFP interface



You must also disassemble the long cable gland used for the copper SFP interface.

Figure 137: Disassembling the long cable gland - copper SFP interface



2. Thread each part onto the cable (the rubber bung is split).

Figure 138: Threading the part onto the cable



3. Fit the parts into the body and lightly screw on the gland nut (do not tighten it).

Figure 139: Fixing parts to the gland

Optical



Copper



Inserting the SFP module

To insert the SFP module into the ODU, follow the below steps:

1. Remove the blanking plug from the SFP port of the ODU.

Figure 140: Removing the blanking plug from the SFP port



Optical SFP+ module



Copper SFP module



2. Insert the SFP module into the SFP receptacle with the label on the bottom.

Figure 141: Inserting the SFP module

Optical



Copper



3. Push the module home until it clicks into place.

Figure 142: Pushing the module home

Optical



Copper



4. Rotate the latch to the locked position.

Figure 143: Rotating the latch

Optical



Copper



Connecting the cable



Attention

The Fiber optic cable assembly is very delicate. To avoid damage, handle it with extreme care. Ensure that the fiber optic cable does not twist during assembly, especially when fitting and tightening the weatherproofing gland. Do not insert the power over Ethernet drop cable from the PSU into the copper SFP module, as this will damage the module.

1. Remove the LC connector dust caps from the ODU end (optical cable only).

Figure 144: Removing the LC connector dust caps

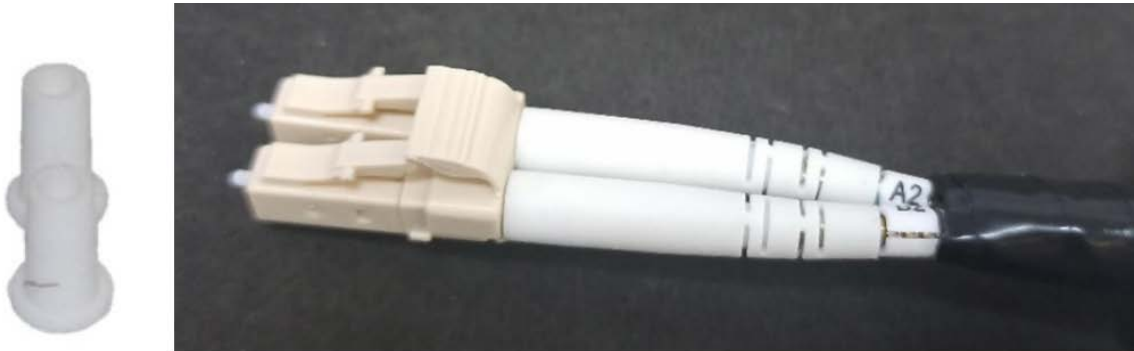

2. Plug the connector into the SFP module, ensuring that it snaps home.

Figure 145: Plugging the connector into the SFP module

Optical



Copper



Fitting the gland

1. Fit the gland body to the SFP port and tighten it to a torque of 5.5 Nm (4.3 lb-ft).

Figure 146: Fitting the gland body



2. Fit the gland nut and tighten until the rubber seal closes on the cable. Do not over-tighten the gland nut, as there is a risk of damage to its internal components.

Figure 147: Fitting the gland nut



3. Fit the gland nut to the rubber seal on the gland body and tighten it to a torque of 5.5 Nm (4.3 lb-ft).

Figure 148: Fitting the gland nut to the rubber seal



Removing the cable and SFP module

Do not attempt to remove the module without disconnecting the cable, otherwise, the locking mechanism in the ODU will be damaged.

1. Remove the cable connector by pressing its release tab before pulling it out.

Figure 149: Removing the cable connector

Optical



Copper



2. Pull the bale clasp (latch) to the unlocked position. Extract the module by using a screwdriver.

Figure 150: Pulling the bale clasp (latch)

Optical



Copper



Configuring 60 GHz cnWave™

This topic explains how to configure the 60 GHz cnWave products.

Nodes deployment

The configuration of cnWave nodes is handled automatically by the E2E service. However, the first PoP node must be configured manually since connectivity to the E2E controller has not yet been established. After establishing communication with the E2E controller, the nodes report a hash of their local configuration file, and the controller automatically pushes configuration changes to the nodes upon seeing any mismatches. The centralized configuration management architecture is implemented in which the E2E controller serves as the single point for configurations in the network.

Figure 151: Nodes deployment

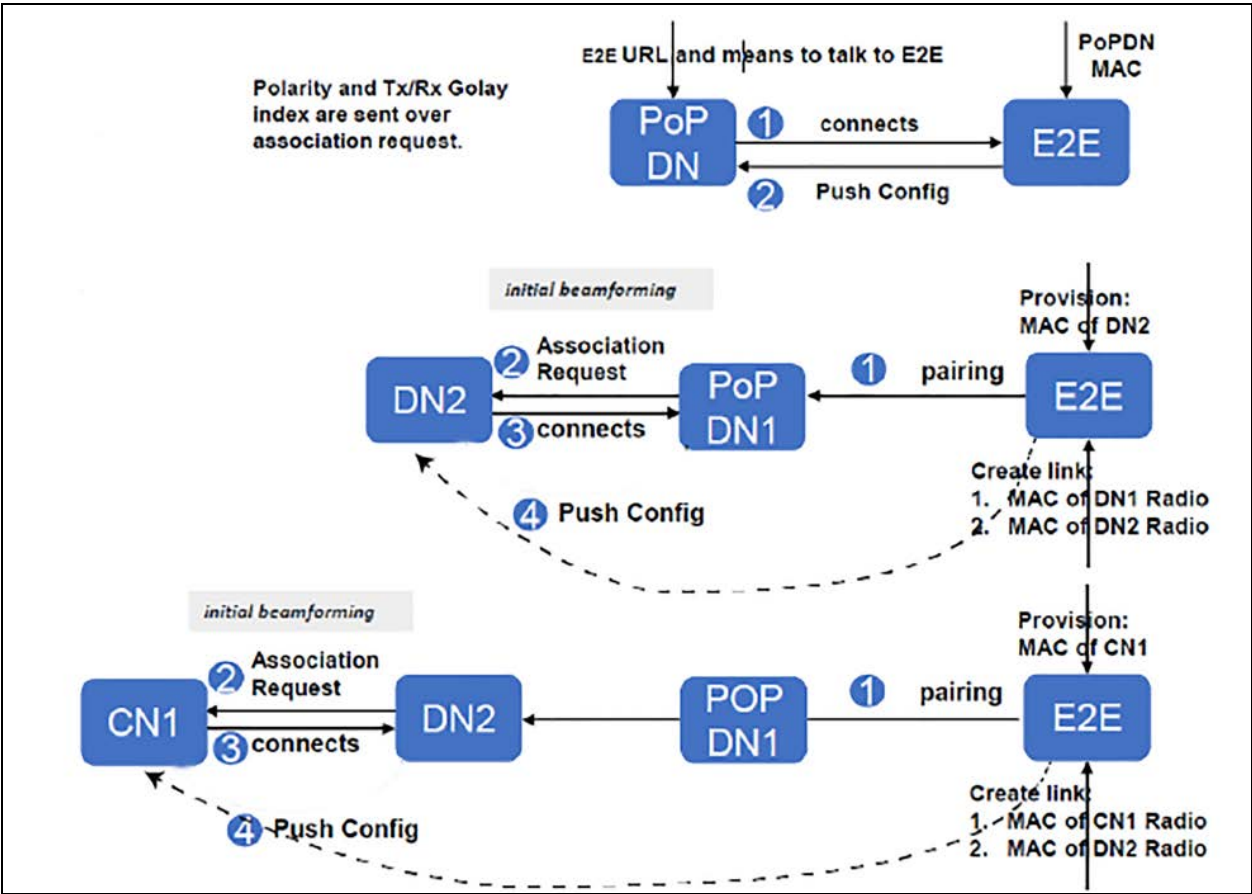

Connecting to the unit

This section describes how to connect the unit to a management PC and power it up.

Configuring the management PC

Use this procedure to configure the local management PC to communicate with the 60 GHz cnWave devices.

Procedure:

1. Select **Properties** for the Ethernet port. In Windows 7 this is found in **Control Panel > Network and Internet > Network Connections > Local Area Connection**.
2. Select **Internet Protocol Version 4 (TCP/IPv4)**.

Figure 152: *The Ethernet Properties dialog box*

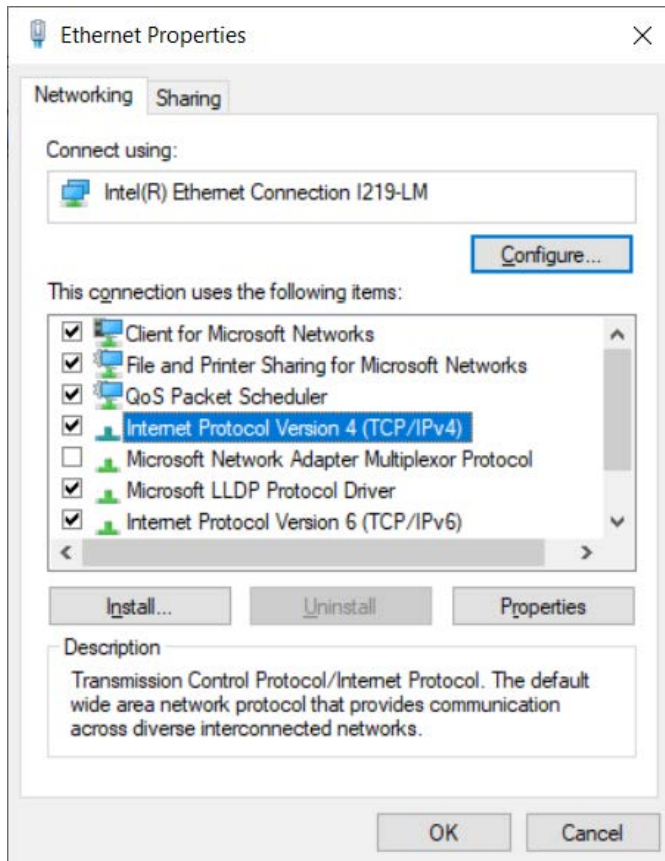

3. Click **Properties**.
4. Enter an IP address that is valid for the 169.254.X.X/16 network, avoiding 169.254.1.1 (for example: 169.254.1.3).

Figure 153: The Internet Protocol Version 4 (TCP/IPv4) dialog box

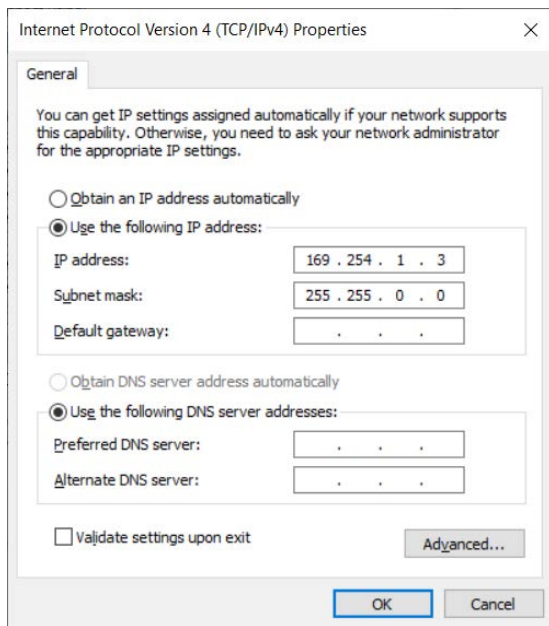

5. Enter a subnet mask of 255.255.0.0. Leave the default gateway blank.

Connecting to the PC and powering up

Use this procedure to connect a management PC and power up the 60 GHz cnWave devices.

Procedure:

1. Check that the ODU is connected to the power supply (AC/DC according to the configuration).
2. Connect the PC Ethernet port to the LAN port of the PSU or AUX port (according to device configuration).
3. Open a web browser and type: **169.254.1.1**.
4. When prompted, enter **admin/admin** to login to the GUI and complete the configuration.

Using the web interface

This section describes how to log into the 60 GHz cnWave web interface and use its menus.

Logging into the web interface

Use this procedure to log into the web interface as a system administrator.

Procedure:

1. Start the web browser from the management PC.
2. Type the IP address of the unit into the address bar. The factory default IP address is **169.254.1.1** and press **Enter**.

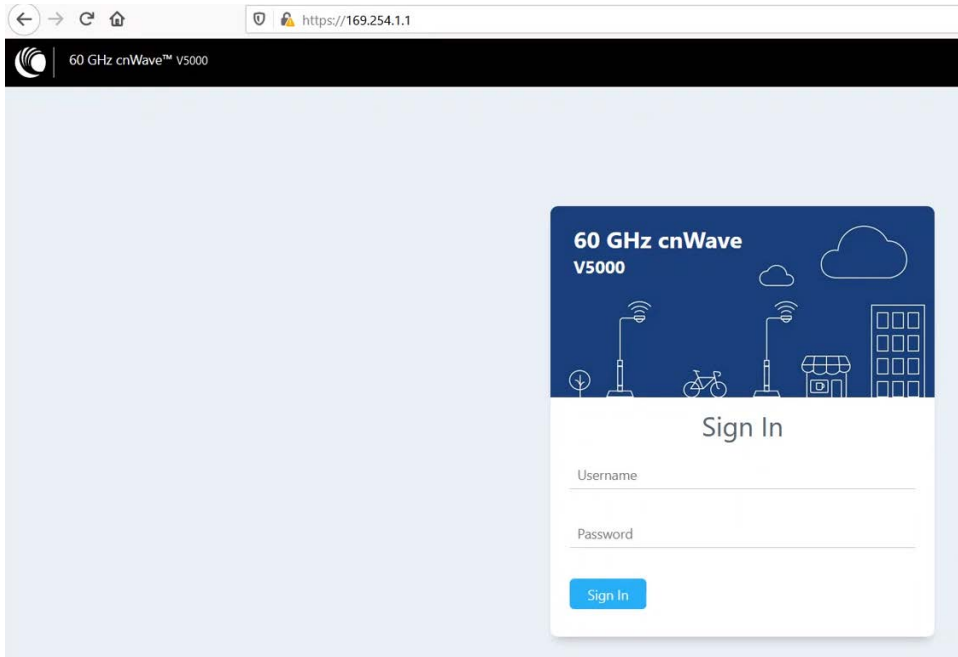

3. Type the username and password as **admin** and **admin**. Click **Sign In**.

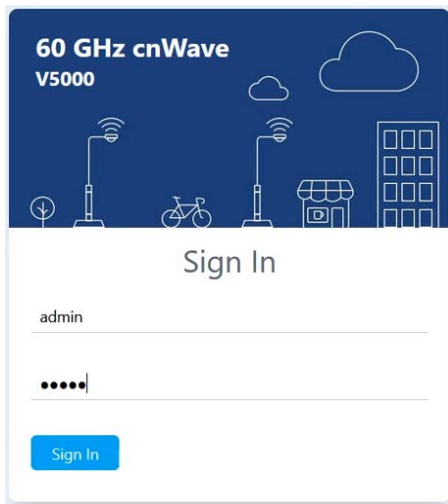

The **Dashboard** page appears.

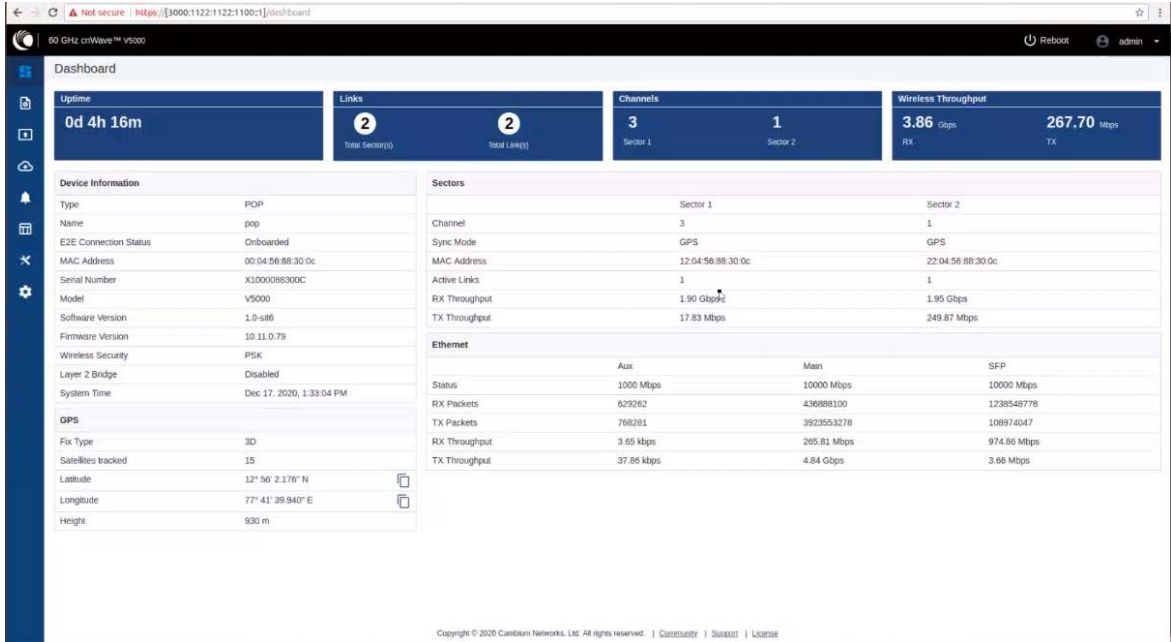

Users can select the refresh time interval. Click **admin** at the top-right and select the **Refresh Interval** from the drop-down.

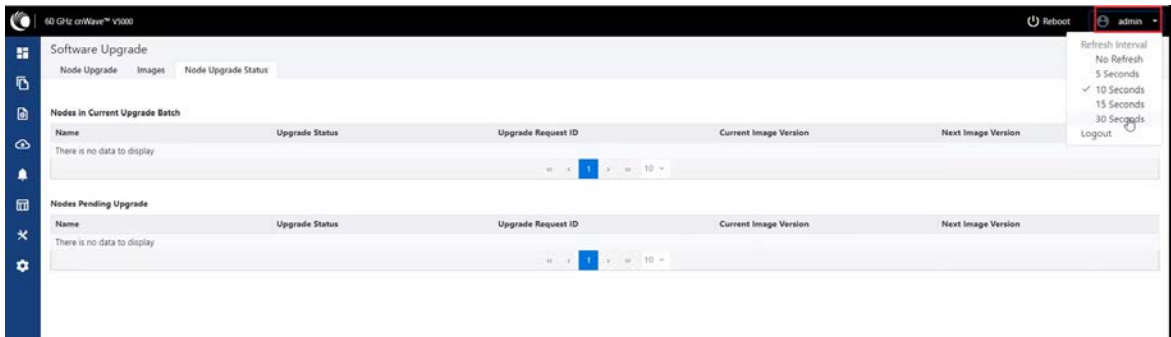

The Dashboard contains the following options at the top:

- Uptime
- Links
- Channels
- Wireless Throughput

Uptime

Displays the total running time of the device.

Links

Displays the total number of active links which are connected to the 60 GHz cnWave™ device.

Channels

Displays the total number of channels (Sector 1, Sector 2, etc.,) which are connected to the 60 GHz cnWave™ device.

Wireless Throughput

Displays the transmitting and receiving throughput values.

Dashboard elements

The **Dashboard** page consist of the following elements:

- Device Information
- GPS
- Sectors
- Ethernet

Figure 154: Dashboard - Device Information

Device Information	
Type	DN
Name	-
E2E Connection Status	Not Onboarded
MAC Address	00:04:56:88:31:21
Serial Number	V5WH004ZNX7V
Model	V5000
Software Version	1.0-dev12
Firmware Version	10.11.0.70
Wireless Security	None
Layer 2 Bridge	Disabled
System Time	Nov 5, 2020, 12:12:57 PM

Table 41: Elements in the Device Information section

Element	Description
Type	Displays type of the device. The device types are: <ul style="list-style-type: none">• DN• PoP DN• CN
Name	Displays name of the device.
E2E Connection Status	Displays the connection status of the E2E controller.
MAC address	Displays the MAC address of the 60 GHz cnWave device.
Serial Number	Displays the serial number of the 60 GHz cnWave device
Model	Displays the model of the 60 GHz cnWave device. The models are:

Element	Description
	<ul style="list-style-type: none"> • V1000 • V2000 • V3000 • V5000
Software version	Displays the software version used in 60 GHz cnWave device.
Firmware version	Displays the Firmware version used in 60 GHz cnWave device.
Wireless security	Displays the security type. The types are: <ul style="list-style-type: none"> • Disabled • PSK • 802.1X
Layer 2 Bridge	Displays bridge status.
System Time	Displays current time.

GPS

The **GPS** section displays the positioning information of the site.

Figure 155: Dashboard - GPS



GPS	
Fix Type	3D
Satellites tracked	15
Latitude	12° 56' 2.163" N 
Longitude	77° 41' 39.912" E 
Height	927 m

Table 42: Elements in the GPS section

Element	Description
Fix Type	Fix Type
Satellites tracked	Number of registered satellites
Latitude	Displays latitude of the site
Longitude	Displays longitude of the site
Height	Displays height of the device

Sectors

The **Sectors** section displays the number of nodes added to the device and its information.

Figure 156: Dashboard - Sectors

Sectors		
	Sector 1	Sector 2
Channel	3	4
Sync Mode	RF	RF
MAC Address	12:04:56:88:31:21	22:04:56:88:31:21
Active Links	0	0
RX Throughput	0 kbps	0 kbps
TX Throughput	0 kbps	0 kbps

Table 43: Elements in the Sectors section

Element	Description
Channel	Displays the channel information used by the sector
Sync mode	Displays the sync mode of the sectors
MAC address	Displays the MAC address of the sectors
Active links	Displays the number of active links in connected sectors
RX Throughput	Displays RX Throughput of the individual sectors
TX Throughput	Displays TX Throughput of the individual sectors

Ethernet

The **Ethernet** section displays the information about Aux, Main, and SFP ports.

Figure 157: Dashboard - Ethernet

Ethernet			
	Aux	Main	SFP
Status	1000 Mbps	10000 Mbps	10000 Mbps
RX Packets	637166	445648283	1250718835
TX Packets	777923	3983518625	109768893
RX Throughput	14.46 kbps	348.40 Mbps	974.40 Mbps
TX Throughput	28.78 kbps	4.84 Gbps	3.65 Mbps

Table 44: Elements in the Ethernet section

Element	Description
Status	Displays the speed of Ethernet ports
RX Packets	Number of packets received
TX Packets	Number of packets transmitted
RX Throughput	Displays the RX Throughput of the Ethernet
TX Throughput	Displays the TX Throughput of the Ethernet

Enabling internal E2E Controller

E2E Controller handles important management functions such as link bring-up, software upgrades and configuration management.



Note

The internal E2E controller is not required if you want to run the E2E controller On-Premise platform. For details, refer to the *60 GHz E2E Controller User Guide*.

Currently, the internal E2E controller is restricted to 31 nodes.

To enable E2E Controller to configure and establish the connection, perform the following steps:

1. Click the **E2E Controller** option on the left pane of the Dashboard.

60 GHz cnWave™ v3000

Onboard E2E Controller

This service enables user to configure and control various aspects of the nodes in the mesh r... ignition of wireless links, software upgrade, statistics and configuration management.

Enable E2E

2. Click **Enable E2E**.

The **Enable Onboard E2E** dialog box appears.

Enable Onboard E2E ✕

Site Name

Default site name

Latitude

Longitude

Device Name

Default device name

[-] Network Settings

Layer 2 Bridge
 By selecting this checkbox, you will be enabling Layer 2 network bridging (via automatically created tunnels) across all nodes connected to a PoP. This will facilitate bridging of IPv4 traffic across the wireless networks.

Prefix Allocation
 Centralized Deterministic

[-] cnMaestro

Remote Management
 Enable Disable

cnMaestro URL

Cambium ID

Onboarding Key

3. Enter the required details and click **Enable**.
4. After enabling E2E Controller, the dashboard displays the links which are connected to the device.

Figure 158: Dashboard

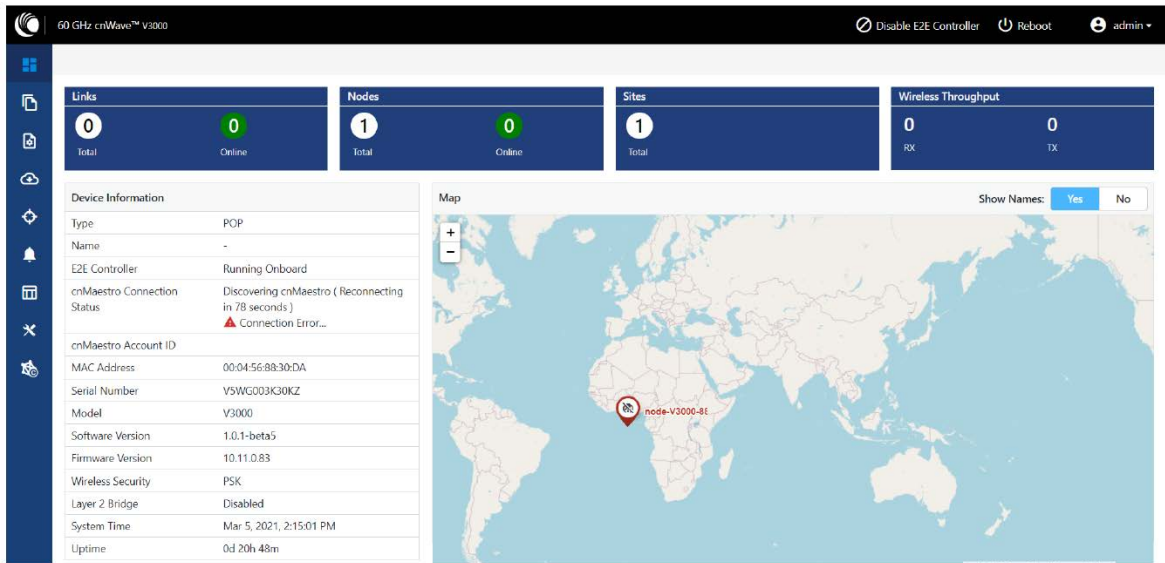

Right-click on the site pin to see additional information about the site, as shown below:

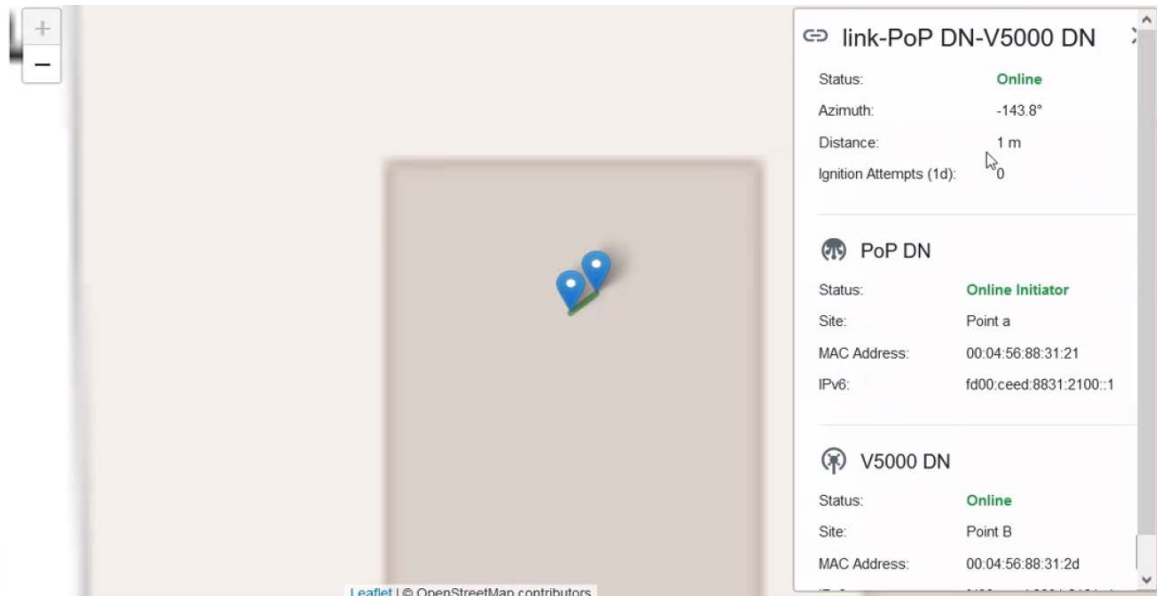

Topology

After enabling the E2E Controller, add Sites, Nodes and Links to establish the connection.

To add sites, nodes and links, perform the following steps:

1. In the main dashboard page, click **Topology** on the left navigation pane.

The **Topology** page appears. By default, the **Sites** tab is selected, as shown below:

Figure 159: The Sites page

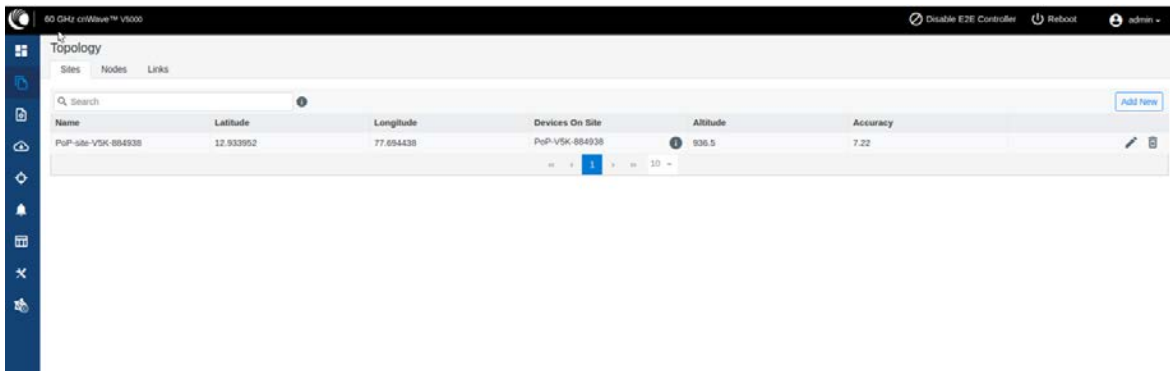

2. To add a DN site, click **Add New**.

The **Add Site** dialog box appears, as shown below:

Figure 160: The Add Site dialog box

Add Site [X]

Name
DN-Site@3f69

Latitude
12.933975905668138

Longitude
77.69462584806521

Altitude
1

Accuracy
2

Save Cancel

3. Enter the Name, Latitude, Longitude, Altitude, Accuracy information, and click **Save**.

The new DN site information gets added to the topology, as shown below:

Figure 161: The updated Sites page with new site details

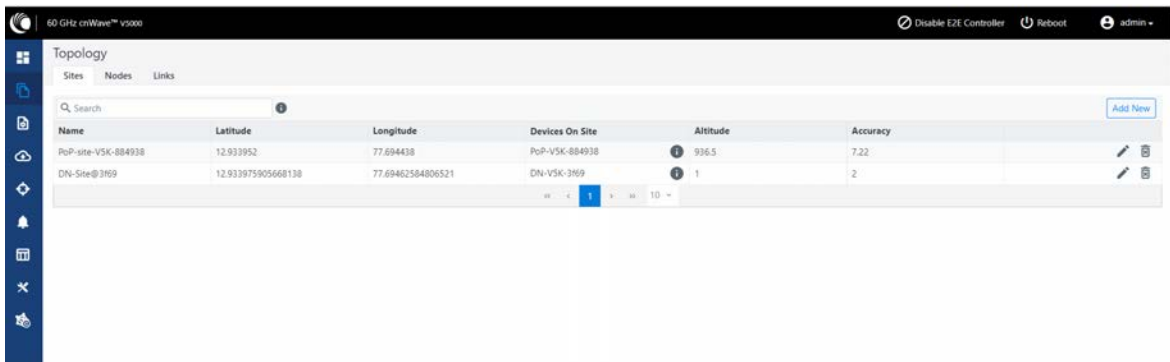

Name	Latitude	Longitude	Devices On Site	Altitude	Accuracy
PoP-site-VSK-084938	12.933952	77.694438	PoP-VSK-084938	936.5	7.22
DN-Site@3169	12.933975905668138	77.69462584806521	DN-VSK-3169	1	2

4. To add a DN node, click on the **Nodes** tab in the **Topology** page.

The **Nodes** page appears, as shown below:

Figure 162: The Nodes page

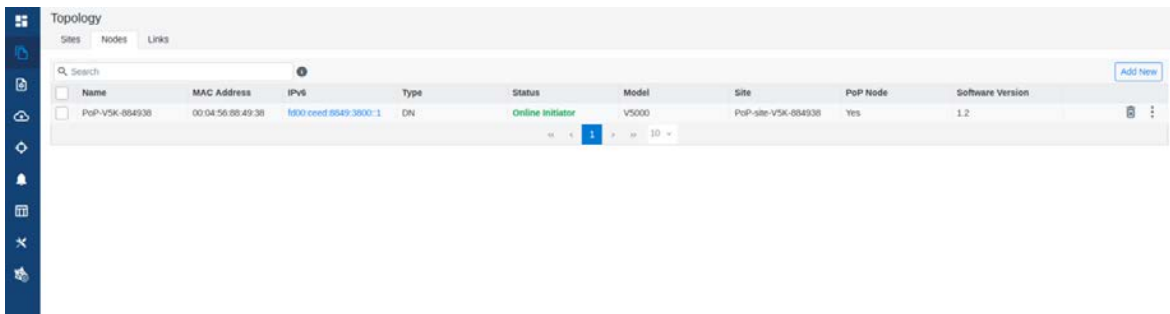

Name	MAC Address	IPv6	Type	Status	Model	Site	PoP Node	Software Version
PoP-VSK-084938	00:04:56:00:49:38	fd00:cecd:8549:3900::1	DN	Online Initiator	V5000	PoP-site-VSK-084938	Yes	1.2

5. Click **Add New** and provide values in the **Add Node** dialog box, as shown below:

Figure 163: The Add Node dialog box

Add Node [X]

Name
DN-V5K-3f69

Site
DN-Site@3f69

PoP Node?
 Yes No

Node Type
 CN DN

MAC Address (ESN)
00:04:56:88:3f:69

Platform
V5000

Azimuth
0

Elevation
0

Save **Cancel**

6. Click **Save**.

The DN node gets added to the topology.

7. To add a link, click on the **Links** tab in the **Topology** page.

The **Links** page appears.

8. Click **Add New** and provide values in the **Add Link** dialog box, as shown below:

Figure 164: The Add Link dialog box

9. Click **Save**.

The new link gets added to the topology, as shown below:

Figure 165: The updated Links page with the new link details

Name	A-Node	A-Node Sector	Z-Node	Z-Node Sector	Active	Uptime	Type	Ignition Attempts (1d)	Distance (m)	Ignition Status
link-DN-V5K-3f6...	DN-V5K-3f69	Sector 2	PoP-V5K-884938	Sector 1	Yes	0d 20h 14m	Wireless	6	936	Enabled

Support for renaming nodes

A node can be renamed in the topology. To rename the node, perform the following steps:

1. From the dashboard page, navigate to **Topology > Nodes**.
2. Select the required node and click in the corresponding row. Then, select **Edit Node**.
The **Edit Node** dialog box appears with information for the selected node.
3. Rename the node, as shown below:

Figure 166: The Edit Node dialog box



4. Click **Save**.

Configuration

The **configuration** page contains the following two configuration options:

- [Network configuration](#)
- [Node configuration](#)

Network configuration

Network configuration is used to configure the network. Users can modify the network settings. It has **Basic**, **Management**, **Security** and **Advanced** options for the configuration. Settings under **Network** apply to all the nodes in the network. Some apply to the **E2E Controller**. Enter the required information and click **Submit** to configure the network.