



PTP 500 Series User Guide



MOTOROLA POINT-TO-POINT WIRELESS SOLUTIONS



MOTOROLA, Inc.

Point-to-Point Wireless Bridges – PTP 500 Series

Software Release PTP 500-01-xx

System User Manual

March 7th , 2008

Ref: PHN-1115-00.01

Copyright Information

This document is the confidential property of Motorola, Inc. and without its prior written consent may not be copied or released to third parties.

MOTOROLA, the stylized M Logo and all other trademarks indicated as such herein are trademarks of Motorola, Inc. ®Reg. U.S. Pat & Tm. Office. PTP 500 is a trademark of Motorola, Inc. All other product or service names are the property of their respective owners.

©2008 Motorola, Inc. All rights reserved.

<http://www.motorola.com/ptp>

Compliance

General

Changes or modifications not expressly approved by Motorola could void the user's authority to operate the system.



NOTE: This system has achieved Type Approval in various countries around the world. This means that the system has been tested against various local technical regulations and found to comply. The frequency bands in which the system operates is may be 'unlicensed' and, in these bands, the system can be used provided it does not cause interference. Further, it is not guaranteed protection against interference from other products and installations.

The system has been tested for compliance to both US (FCC) and European (ETSI) specifications. It has been shown to comply with the limits for emitted spurious radiation for a Class B digital device¹, pursuant to Part 15 of the FCC Rules in the USA and appropriate European ENs. These limits have been designed to provide reasonable protection against harmful interference. However the equipment can radiate radio frequency energy and, if not installed and used in accordance with the instructions, may cause harmful interference to other radio communications. There is no guarantee that interference will not occur in a particular installation.

If this equipment does cause harmful interference to radio or television reception, which can be determined by turning the equipment off and on, the user is encouraged to try to correct the interference by one or more of the following measures:

- Reorient or relocate the Outdoor Unit (ODU).
- Increase the separation between the affected equipment and ODU.
- Connect the ODU/PIDU into a power outlet on a circuit different from that to which the receiver is connected.
- Consult your installer or supplier for help.

Deployment and Operation

The Radio Regulations of various countries' limits constrain the operation of radio products generally. In particular the local regulator may limit the amount of conducted or radiated transmitter power and may require registration of the radio link.

The power transmitted by the PTP 500 Series Bridge is controlled by the use of Region-specific License Keys.

The following examples show how the regulatory limits apply in some specific countries at the current time. Operators should note that regulations are subject to change.

Contact your supplier/installer to ensure that your product is set for the correct License Key for your Country/Region and to ensure that you have fulfilled all the local regulatory requirements, especially if you are intending to use a link with external antennas. Notes below the tables indicate countries where registration of the link is currently mandatory.

The system has been tested for compliance to both US (FCC) and European (ETSI) specifications. It has been shown to comply with the limits for emitted spurious radiation for a Class B digital device, pursuant to Part 15 of the FCC Rules in the USA and appropriate European ENs. These limits have been designed to provide reasonable protection against harmful interference. However the equipment can radiate radio frequency energy and, if not installed and used in accordance with the instructions, may cause harmful interference to other radio communications. There is no guarantee that interference will not occur in a particular installation.

¹ Class B Digital Device, A digital device that is marketed for use in a residential environment notwithstanding use in commercial, business and industrial environments.

Regulations applicable to 5.4GHz PTP 500 Series Bridge variant

	Examples of Regulatory Limits at 5.4GHz
FCC	Under FCC Regulations, operation of this product is only allowed with a License Key for Region 12 (30dBm or 1W EIRP with Radar Detection)
ETSI	Under ETSI Regulations, operation of this product is only allowed with a License Key for Region 24 (30dBm or 1W EIRP with Radar Detection)
Australia, Canada	Under Australian Communications Authorities and Industry Canada Regulations, operation of this product is only allowed with a License Key for Region 13 (30dBm or 1W EIRP with Radar Detection and barring of the band 5600-5650MHz)
Thailand	Operation of this product is only allowed with a License Key for Region 20 (30 dBm or 1W EIRP)
Korea	Operation of this product is only allowed with a License Key for Region 21 (28 dBm EIRP (15 MHz))

General Notice Applicable to Europe

This equipment complies with the essential requirements for the EU R&E Directive 1999/5/EC.



Note: In regions other than EU/USA, specific local regulations may apply. It is the responsibility of the installer/user to check that the equipment as deployed meets local regulatory requirements.

Regulations applicable to 5.8GHz PTP 500 Series Bridge variant

	Examples of Regulatory Limits at 5.8GHz
USA / Canada / Taiwan / Brazil	Equipment can be operated in any mode, best results will be obtained using Region 1 settings
China	Operation of this product is only allowed with a License Key for Region 2 (33 dBm or 2W EIRP)
Australia	Operation of this product is only allowed with a License Key for Region 3 (36 dBm or 4W EIRP)
Hong Kong	Under Hong Kong Regulations, operation of this product is only allowed with a License Key for Region 3 (36 dBm or 4W EIRP)
UK	Under UK Regulations, operation of this product is allowed with a License Key for Region 4 (3W EIRP with Radar Detection)
Singapore	Under Singapore Regulations, operation of this product is only allowed with a License Key for Region 5 (20 dBm or 100mW EIRP)
Eire	Under Eire Regulations, operation of this product is only allowed with a License Key for Region 6 (33 dBm or 2W EIRP. Note lower power limits in narrow bandwidths.)
Korea	Under Korean Regulations, operation of this product is only allowed with a License Key for Region 11 (43 dBm or 20W EIRP)
India	Operation of this product is only allowed with a License Key for Region 19 (36 dBm or 4W EIRP at 15 MHz)
Thailand	Operation of this product is only allowed with a License Key for Region 20 (30 dBm or 1W EIRP)
Germany	Operation of this product is only allowed with a License Key for Region 22 (36 dBm or 4W EIRP)
Bahrain	Operation of this product is only allowed with a License Key for Region 24 (33 dBm or 2W EIRP)

General Notice Applicable to Europe

This equipment complies with the essential requirements for the EU R&E Directive 1999/5/EC.

The use of 5.8GHz for Point to Point radio links is not harmonized across the EU.

However, the regulatory situation in Europe is changing and the radio spectrum may become available in other countries in the near future. Please contact Motorola for the latest situation.



Notes:

UK Registration of Links – OfCom, The application form may be found at

<http://www.ofcom.org.uk/radiocomms/isu>

Eire Registration of Links – Commission for Communication Regulation, The application form may be found at

http://www.comreg.ie/licensing_and_services

Disclaimer

The parameters quoted in this document must be specifically confirmed in writing before they become applicable to any particular order or contract. The company reserves the right to make alterations or amendments to the detail specification at its discretion. The publication of information in this document does not imply freedom from patent or other rights of Motorola, Inc. or others.

Contents

1	About This User Guide	15
1.1	Interpreting Typeface and Other Conventions	15
1.2	Getting Additional Help	16
1.2.1	Sending Feedback	17
2	Avoiding Hazards	18
2.1	Preventing Overexposure to RF Energy	18
2.1.1	Calculations for Separation Distances and Power Compliance Margins	18
3	Getting Started	20
3.1	For Your Safety	20
3.2	Welcome	20
3.2.1	Who Should Use This Guide?	21
3.2.2	Contact Information	21
3.2.3	Repair and Service	21
3.3	Product Description	22
3.3.1	The Outdoor Unit (ODU)	24
3.3.2	PIDU Plus – PTP 500 Series Bridge	25
3.3.3	Redundancy and Alternate Powering Configurations	27
3.3.4	Remote LEDs and Recovery Switch	29
3.3.5	Cables and connectors	29
3.3.6	PTP and Lightning Protection	30
3.3.7	Mounting Brackets	30
3.3.8	Configuration and Management	30
3.4	Warranty	31
4	Product Architecture	32
5	General Considerations	34
5.1	Spectrum Planning	34
5.2	Region Codes	35
5.3	Operational Restrictions	37
5.3.1	Radar Avoidance	37
5.3.2	RTTT Avoidance and Other Channel Use Restrictions	38
5.3.3	Radar Avoidance, i-DFS and Variable (Narrow) Bandwidth Operation	38
5.4	Variable Channel Bandwidth Operation	38
5.5	5.4 GHz Specific Frequency Planning Considerations	39
5.5.1	5.4 GHz Raster Considerations	39
5.5.2	5.4 GHz Transmit Power Reduction at the Band Edges	39
5.6	5.8 GHz Specific Frequency Planning Considerations	40
5.6.1	5.8 GHz Raster Considerations	40
5.6.2	5.8 GHz Transmit Power Reduction at the Band Edges	40
5.7	Distance	41
5.8	Networking Information	41
5.9	Lightning Protection and regulations	41
5.10	Electrical Requirements	41
6	Site Planning	42
6.1	Site Selection Criteria	42
6.1.1	ODU Site Selection	42
6.1.2	PTP 500 Series Bridge PIDU Plus Site Selection	42
6.1.3	Path Loss Considerations	42

6.1.4	Definitions	43
6.1.5	5.4 GHz Product Variant - Link Loss, Output Power and System Thresholds versus Modulation Mode	44
6.1.6	5.8 GHz Product Variant - Link Loss, Output Power and System Thresholds versus Modulation Mode	45
7	Installation	46
7.1	Preparation	46
7.2	Installation Procedure	46
7.3	Tools Required	46
7.4	Installation Support	46
7.5	Legal Disclaimer	47
7.6	Mounting the ODUs	47
7.7	Connecting Up	48
7.7.1	Preparing the PIDU Plus To ODU Cable	48
7.7.2	Making the Connections at the ODU	50
7.7.3	Making the PTP 500 Series Bridge PIDU Plus Connection At The ODU	51
7.7.4	Routing the Cable	52
7.7.5	Fitting a Lightning Protection Unit	52
7.7.6	Grounding the Installation	52
7.7.7	Making the ODU Connection at the PTP 500 Series Bridge PIDU Plus	53
7.7.8	Making the Network Connection at The PIDU Plus – PTP 500 Series Bridge	54
7.7.9	Mounting the PTP 500 Series Bridge PIDU Plus	54
7.7.10	Powering Up	55
7.7.11	Aligning the PTP 500 Series Bridge ODUs	56
8	Web Page Reference	58
8.1	Home Page – PTP 500 Series Bridge	59
8.1.1	Home Page Alarm Display	59
8.2	Systems Status Page	61
8.3	System Administration Pages	65
8.3.1	System Configuration	66
8.3.2	Statistics Page	78
8.3.3	Detailed Counters Page	81
8.3.4	Install Pages	82
8.3.5	Graphical Install	94
8.3.6	Software Upgrade	95
8.3.7	Spectrum Management	98
8.3.8	Spectrum Management (Fixed Frequency)	105
8.3.9	Spectrum Management Control – With Operational Restrictions	107
8.3.10	Remote Management Page	111
8.3.11	Diagnostics	116
8.3.12	Change System Administration Password	119
8.3.13	License Key	119
8.3.14	Properties	121
8.3.15	Reboot	122
9	Recovery Mode	123
9.1	Upgrade Software Image	125
9.2	Reset IP and Ethernet Configuration	126
9.3	Erase Configuration	128
9.4	Erase Security Parameters	130

9.5	Reboot	131
10	Fault Finding	132
10.1	Hardware	132
10.1.1	Power	132
10.1.2	Ethernet	132
10.1.3	Checking your wiring	133
10.2	Radio	134
10.2.1	No Activity	134
10.2.2	Some Activity	134
11	Lightning Protection	135
11.1	Overview	135
11.1.1	Lightning Protection Zones	135
11.2	Detailed Installation	137
11.3	Testing Your Installation	139
11.3.1	Pre-Power Testing	140
11.3.2	Post-Power Testing	140
11.4	Locating the Fault	142
12	Wind Loading	143
12.1	General	143
12.2	Calculation of Lateral Force	143
12.3	Capabilities of the PTP 500 Series Bridges	144
12.4	Wind Speed Statistics	144
13	PTP 500 Series Bridge - Connectorized Model	145
13.1	Scope	145
13.2	Product Description	145
13.2.1	Hardware	145
13.2.2	Antenna Choices – 5.8 GHz	145
13.2.3	Antenna Choices – 5.4 GHz	146
13.3	Software/Features	146
13.3.1	Status Page	146
13.3.2	Configuration Pages	147
13.3.3	Installation Pages	148
13.4	Deployment Considerations	150
13.5	Link Budget	151
13.6	Regulatory Issues	151
13.6.1	Antenna Choice (FCC and Industry Canada Regions Only)	151
13.6.2	Cable Losses (FCC Regions Only)	152
13.6.3	Antennas for USA / Canada – 5.8 GHz	153
13.6.4	Antennas for USA / Canada – 5.4 GHz	157
13.7	Installation	158
13.7.1	Antenna Choice	158
13.7.2	Cables and Connectors	159
13.7.3	Tools	159
13.7.4	Miscellaneous supplies	159
13.7.5	Mounting the Connectorized 500 Series Bridge	159
13.7.6	Mounting the antennas	160
13.7.7	Alignment Process	160
13.7.8	Aligning Dual Polar Antennas	160
13.7.9	Aligning Separate Antennas	160

13.7.10	Completing the Installation	161
13.7.11	Antenna Cable Fixing	161
13.7.12	Antenna Connection Weatherproofing	161
13.8	Additional Lightning Protection	162
13.8.1	ODU Mounted Outdoors	162
13.8.2	ODU Mounted Indoors	163
14	Data Rate Calculations	164
15	AES Encryption Upgrade	172
15.1	Configuring Link Encryption	172
15.1.1	License Keys	172
15.1.2	Encryption Mode and Key	173
15.2	Wireless Link Encryption FAQ	175
15.2.1	Encryption data entry fields are not available	175
15.2.2	Link fails to bridge packets after enabling link encryption	175
15.2.3	Loss of AES following downgrade	175
16	Legal and Regulatory Notices	176
16.1	Important Note on Modifications	176
16.2	National and Regional Regulatory Notices – 5.8 GHz variant	176
16.2.1	European Union Notification	177
16.2.2	UK Notification	178
16.3	National and Regional Regulatory Notices – 5.4 GHz Variant	178
16.3.1	U.S. Federal Communication Commission (FCC) and Industry Canada (IC) Notification	178
16.3.2	European Union Notification	179
16.4	Exposure	180
16.5	Legal Notices	180
16.5.1	Motorola Inc. End User License Agreement	180
16.5.2	Limit of Liability	186
17	Specifications	187
17.1	System Specifications	187
17.1.1	Wireless 5.4GHz Variant	187
17.1.2	Wireless 5.8GHz Variant	188
17.1.3	Management	189
17.1.4	Ethernet Bridging	189
17.1.5	Physical	190
17.1.6	Powering	190
17.2	Safety Compliance	190
17.3	EMC Emissions Compliance	190
17.3.1	5.4GHz Variant	190
17.3.2	5.8GHz Variant	190
17.4	EMC Immunity Compliance	191
17.5	Radio Certifications	191
17.5.1	Radio Certifications - 5.4 GHz Variant	191
17.5.2	Radio Certifications - 5.8 GHz Variant	192
17.6	Environmental Specifications	192
17.7	System Connections	193
17.7.1	PIDU Plus to ODU and ODU to Network Equipment Connections	193
18	FAQs	194
19	Glossary	196

List of Figures

1	Typical PTP 500 Series Bridge Deployment	22
2	PTP 500 Series Bridge Outdoor Unit (ODU) with PTP-LPU	24
3	Power Indoor Unit (PIDU Plus) – PTP 500 Series	25
4	PIDU Plus Recovery Switch Location	25
5	PTP 500 Series Bridge PIDU Plus Power Input	26
6	PTP 500 Series Bridge PIDU Plus to ODU Cable Length Graph	27
7	External DC Supply Only	27
8	External DC Supply and AC Supply	28
9	External DC Supply and Redundant AC Supply	28
10	Remote LED and Recovery Switch Wiring	29
11	PTP 500 Series Bridge Layer Diagram	33
12	5.8 GHz UK RTTT Channel Avoidance – 15 MHz Channel Bandwidth Only	38
13	5.4 GHz Available Spectrum Settings – 15 MHz Channel Bandwidth	39
14	5.8 GHz Available Spectrum Settings – 15 MHz Channel Bandwidth	40
15	Mounting to pole diameters 25mm (1”) to 50mm (2”)	47
16	Integral Safety Loop	48
17	Correct Cable Preparation for the Recommended Cable	49
18	Completed ODU Connector	50
19	Warning Not To Over tighten Cable Gland	50
20	PTP 500 Series Bridge PIDU Plus Connexion	50
21	Connecting the PIDU+ to the ODU	51
22	Disconnecting the ODU	52
23	Making the Network Connection at the PIDU Plus	54
24	PTP 500 Series PIDU Plus Drip Loop Configuration	55
25	Menu Navigation Bar	58
26	System Summary Page	59
27	Alarm Warning Triangle	60
28	Status Page	62
29	System Administration Login Page	65
30	System Configuration Page	67
31	LAN Configuration Page	68
32	Configuration Reboot Page	70
33	Configuration Reboot Page – Ethernet Auto Negotiation Disabled	70
34	VLAN Configuration Fields	71
35	LAN Configuration Page – Manual Ethernet Configuration	72
36	Save and Restore Configuration Page	73
37	Save Configuration File Screen	74
38	PTP 500 Example Configuration File	75
39	Restore Configuration File Pop Up Screen	76
40	Reset Configuration and Reboot Confirmation Pop-up	76
41	System Statistics	78
42	Detailed Counters Page	81
43	License Key Data Entry	84
44	Installation Wizard Internet Protocol Configuration	85
45	VLAN Warning	86
46	5.8 GHz and 5.4 GHz Variants - Installation Wizard Wireless Configuration	86
47	5.8 GHz and 5.4 GHz Variants - Fixed Frequency Operation	89

48	5.8 GHz and 5.4 GHz Variants - Installation Wizard Confirm Configuration	90
49	Reboot Confirmation Pop Up	91
50	5.8 GHz and 5.4 GHz Variant - Disarm Installation	92
51	Optional Post Disarm Configuration 2	93
52	Optional Post Disarm Configuration 1	93
53	Graphical Installation Screen	94
54	Software Upgrade	95
55	Software Upgrade Image Check	96
56	Software Download Progress Indicator	97
57	Software Upgrade Complete	97
58	Reboot Confirmation Pop Up	97
59	Spectrum Management as seen from the Master	100
60	Spectrum Management as seen from the Slave	101
61	Example Spectrum Management Graphic	103
62	Active Channel History Screen	104
63	Spectrum Management Time Series Plot	105
64	Spectrum Management Fixed Frequency Screen	106
65	Spectrum Management Help Page (Fixed Frequency)	107
66	Spectrum Management Master Screen With Operational Restrictions	108
67	Spectrum Management Slave Screen With Operational Restrictions	109
68	Remote Management	112
69	Warning when disabling HTTP Interface	113
70	Remote Management – Diagnostic Alarms	114
71	Diagnostic Plotter	117
72	CSV Download	118
73	Password Change	119
74	Software License Key Data Entry	120
75	License Key reboot Screen	120
76	Reboot Confirmation Pop Up	121
77	Properties	121
78	System Reboot	122
79	Reboot Confirmation Pop Up	122
80	Recovery Mode Warning Page	123
81	Recovery Options Page	124
82	Software Download Progress Indicator Page	125
83	Software Download Complete Page	125
84	Reboot Confirmation Pop Up	126
85	Confirm Reset to Factory Default Pop Up	126
86	IP and Ethernet Erased Successfully page	127
87	Reboot Confirmation Pop Up	127
88	Confirm Erase Configuration Pop Up	128
89	Erase Configuration Successful Page	129
90	Erase Configuration – Reboot Confirmation Pop Up	129
91	Confirm Zeroise Security Parameters Pop Up	130
92	Zeroise Parameters Successful Page	131
93	Recovery – Reboot Confirmation Pop Up	131
94	ODU mounted in Zones A and B	136
95	Showing how the use of a Finial enables the ODU to be mounted inside Zone B	136
96	Diagrammatically Showing Typical Mast and Wall Installations	138

97	PTP LPU End Kit	138
98	Simplified Circuit Diagram	139
99	PTP LPU test Points	142
100	Connectorized 500 Series Bridge Outdoor Unit	145
101	Connectorized 500 Series bridge Status Page	147
102	Connectorized 500 Series bridge ‘System Configuration’ Page	147
103	Connectorized PTP 500 Series Bridge ‘Installation Wizard’ Page	148
104	Connectorized 500 Series bridge ‘Confirm Installation’ Page	149
105	Connectorized 500 Series bridge ‘Disarm Installation’ Page	150
106	Forming a Drip Loop	161
107	Weatherproofing the Antenna Connections	162
108	Additional Grounding When Using Connectorized Units	162
109	Lightning Arrestor Mounting	163
110	Polyphaser Assembly	163
111	BPSK 0.50 Single Payload	164
112	QPSK 0.50 Single Payload	165
113	QPSK 0.75 Single Payload	165
114	16 QAM 0.50 Single Payload	166
115	16 QAM 0.75 Single Payload	166
116	64 QAM 0.67 Single Payload	167
117	64 QAM 0.83 Single Payload	167
118	256 QAM 0.75 Single Payload	168
119	QPSK 0.50 Dual Payload	168
120	QPSK 0.75 Dual Payload	169
121	16 QAM 0.50 Dual Payload	169
122	16 QAM 0.75 Dual Payload	170
123	64 QAM 0.67 Dual Payload	170
124	64 QAM 0.83 Dual Payload	171
125	256 QAM 0.75 Dual Payload	171
126	AES Software License Key Data Entry	173
127	AES Configuration Data Entry Page	174
128	Configuration Reboot Screen	175
129	Cable Connection Diagram (T568B Color Coding)	193

List of Tables

1	Font types	15
2	Admonition types	16
3	Power Compliance Margins	19
4	Contact Information	21
5	PTP 500 Series Bridge Variants	34
6	5.8 GHz Band Edge Tx Power Reduction	41
7	5.4GHz - IP Mode - Sensitivity Figures	44
8	5.4GHz -TDM Mode - Sensitivity Figures	44
9	5.8GHz - IP Mode - Sensitivity Figures	45
10	5.8GHz - TDM Mode - Sensitivity Figures	45
11	Audio indications from the ODU	56
12	500 Series Bridge Factory Configuration Values	83
13	Spectrum Management change state key	104
14	Spectrum Management Time Series Key	105
15	Spectrum Management Change State Key With Operational Restrictions	110
16	Protection Requirements	137
17	Resistance Table Referenced to the RJ45 at the PIDU Plus	140
18	Lateral Force – Imperial	143
19	Lateral Force – Metric	143
20	Cable Losses per Length	152

1 About This User Guide

This guide covers the installation, commissioning, operation and fault finding of the Motorola PTP 500 Series of Point-to-Point Wireless Ethernet Bridges.

1.1 Interpreting Typeface and Other Conventions

This document employs distinctive fonts to indicate the type of information, as described in **Table 1**.

Font	Type of Information
variable width bold	Selectable option in a graphical user interface or settable parameter in a web-based interface.
<code>constant width regular</code>	Literal system response in a command-line interface.
<i>constant width italic</i>	Variable system response in a command-line interface.
constant width bold	Literal user input in a command-line interface.
<i>constant width bold italic</i>	Variable user input in a command-line interface.

Table 1 Font types

This document employs specific imperative terminology as follows:

- Type means press the following characters.
- Enter means type the following characters and then press Enter.
- Highlight means click anywhere in a row of data to highlight the entire row.
- Select means use the mouse to click on or branch to the menu item that follows.

Use this table and the Glossary to aid in interpreting the technical acronyms used throughout this User Guide.

About This User Guide

This document also employs a set of consistently used admonitions. Each type of admonition has a general purpose that underlies the specific information in the box. These purposes are indicated in **Table 2**.





Admonition Label	General Message
	<p>Note Informative content that may:</p> <ul style="list-style-type: none">• Defy common or cursory logic.• Describe a peculiarity of the 500 Series solutions implementation.• Add a conditional caveat.• Provide a reference.• Explain the reason for a preceding statement or provide background for what immediately follows. <p>Recommendation Suggestion for an easier, quicker, or safer action or practice.</p>
	<p>Informative content that may:</p> <ul style="list-style-type: none">• Identify an indication that you should watch for.• Advise that your action can disturb something that you may not want disturbed.• Reiterate something that you presumably know but should always keep in mind.
	<p>Caution! A notice that the risk of harm to equipment or service exists.</p>
	<p>Warning! A notice that the risk of harm to person exists.</p>

Table 2 Admonition types

1.2 Getting Additional Help

To get information or assistance as soon as possible for problems that you encounter, use the following sequence of action:

1. Search this document, the user manuals that support the modules, and the software release notes of supported releases:
 - a. In the Table of Contents for the topic.
 - b. In the Adobe Reader[®] search capability for keywords that apply.²
2. Visit the Motorola website at <http://www.motorola.com/ptp>

² Reader is a registered trademark of Adobe Systems, Incorporated.

About This User Guide

3. Ask your Motorola products supplier to help.
4. Gather information from affected units such as:
 - a. the IP addresses and MAC addresses
 - b. the software releases
 - c. the configuration of software features
 - d. any available diagnostic downloads
5. Escalate the problem to Motorola Technical Support as follows. You may either:
 - a. Send e-mail to **support.ptp@motorola.com**
 - b. Call our 24x7 Technical Support Center on +1 (0) 877 515 0400 (Worldwide) or +44 (0) 808 234 4640 (UK Customers).

For warranty assistance, contact your reseller or distributor for the process.

1.2.1 Sending Feedback

We welcome your feedback on the PTP 500 Series Bridge system documentation

support.ptp@motorola.com.

This includes feedback on the structure, content, accuracy, or completeness of our documents, and any other comments you have.

2 Avoiding Hazards

2.1 Preventing Overexposure to RF Energy



Caution To protect from overexposure to RF energy, install the radios for the 500 family of PTP wireless solutions so as to provide and maintain the minimum separation distances from all persons as shown in **Table 3**.

When the system is operational, avoid standing directly in front of the antenna. Strong RF fields are present when the transmitter is on. The Outdoor Unit (ODU) must not be deployed in a location where it is possible for people to stand or walk inadvertently in front of the antenna. At these and greater separation distances, the power density from the RF field is below generally accepted limits for the general population.



Note These are conservative distances that include compliance margins.

2.1.1 Calculations for Separation Distances and Power Compliance Margins

Limits and guidelines for RF exposure come from:

- US FCC limits for the general population. See the FCC web site at <http://www.fcc.gov>, and the policies, guidelines, and requirements in Part 1 of Title 47 of the Code of Federal Regulations, as well as the guidelines and suggestions for evaluating compliance in FCC OET Bulletin 65.
- Health Canada limits for the general population. See the Health Canada web site at http://www.hc-sc.gc.ca/ewh-semt/pubs/radiation/99ehd-dhm237/limits-limités_e.html and Safety Code 6.
- ICNIRP (International Commission on Non-Ionizing Radiation Protection) guidelines for the general public. See the ICNIRP web site at <http://www.icnirp.de/> and Guidelines for Limiting Exposure to Time-Varying Electric, Magnetic, and Electromagnetic Fields.

The applicable power density exposure limits from the documents referenced above are:

- 6 W/m² for RF energy in the 900-MHz frequency band in the US and Canada.
- 10 W/m² for RF energy in the 2.4-, 5.2-, 5.4-, and 5.8-GHz frequency bands.

Peak power density in the far field of a radio frequency point source is calculated as follows:

$$S = \frac{P.G}{4\pi d^2} \quad (1)$$

Where:-

S	= power density	W/m ²
P	= Maximum Average transmit power capability of the radio	W
G	= total Tx gain as a factor, converted from dB	
d	= distance from point source	m

Avoiding Hazards

Rearranging terms to solve for distance yields

$$d = \sqrt{\frac{P \cdot G}{4\pi S}} \quad (2)$$

2.1.1.1 Calculated Distances and Power Compliance Margins

Table 3 shows calculated minimum separation distances d, recommended distances and resulting power compliance margins for each frequency band and antenna combination.

Band	Antenna	Max Average Transmit Power in Burst (Watt)	Variable			D (m)	Recommended Distance (m)	Power Compliance Margin
			P (Watt)	G	S (W/m ²)			
5.4 GHz	Integrated	0.005 (7dBm)	0.00250	200 (23dBi)	10	0.06	1	15.9
	External 3ft Dish	0.00035 (-4.6dBm)	0.00017	2884 (34.6dBi)	10	0.06		
5.8 GHz	Integrated	0.32 (25dBm)	0.16	200 (23dBi)	10	0.5	2	4.0
	External 2ft Flat Plate	0.32 (25dBm)	0.16	631 (28dBi)	10	0.9	4	4.5
	External 6ft Dish	0.32 (25dBm)	0.16	6310 (38dbi)	10	2.83	10	3.5

Table 3 Power Compliance Margins



Notes:

1. The regulations require that the power used for the calculations is the maximum power in the transmit burst subject to allowance for source-based time-averaging.
2. At 5.4GHz the product is generally to a fixed EIRP which can be achieved with the Integrated Antenna. If there are no EIRP limits, use the distance calculations for 5.8GHz.
3. At 5.8GHz, for antennas between 0.6m (2ft) and 1.8m (6ft), alter the distance proportionally to the antenna gain

3 Getting Started

3.1 For Your Safety



WARNING: Use extreme care when installing antennas near power lines.

WARNING: Use extreme care when working at heights.

WARNING: The Outdoor Unit (ODU) for the PTP 500 Series Bridge must be properly grounded to protect against lightning. It is the user's responsibility to install the equipment in accordance with Section 810 of the National Electric Code, ANSI/NFPA No.70-1984 or Section 54 of the Canadian Electrical Code. These codes describe correct installation procedures for grounding the outdoor unit, mast, lead-in wire and discharge unit, size of grounding conductors and connection requirements for grounding electrodes. It is recommended that installation of the outdoor unit be contracted to a professional installer.



WARNING: The ODU for the PTP 500 Series Bridge must be grounded to a Protective Earth in accordance with the Local Electrical Regulations.

WARNING: It is recommended that the supplied Power Indoor Plus (PIDU Plus) – PTP 500 Series is used to power the PTP 500 Series Bridge ODU. The use of other power sources may invalidate safety approval and affect your warranty.

WARNING: When using alternate DC supplies (via the PIDU Plus DC in terminals as described in [Section 3.3.3](#) “Redundancy and Alternate Powering Configurations”), such as battery-backed DC power source, the supply **MUST** comply with the following requirements:

- The voltage and polarity is correct and is applied to the correct terminals in the PIDU Plus
- The power source is rated as SELV
- The power source is rated to supply at least 1A continuously, and
- The power source cannot provide more than the Energy Hazard Limit as defined by IEC/EN/UL6090, Clause 2.5, Limited Power (The Energy Hazard Limit is 240VA)



CAUTION: Users and installers should note that the main power supply is the primary disconnect device.

CAUTION: Safety will be compromised if external quality cables are not used for connections that will be exposed to the weather.

CAUTION: Safety will be compromised if a different power supply is used than the one supplied by Motorola as part of the system.

3.2 Welcome

Congratulations on the purchase of the PTP 500 Series Bridge from Motorola. The PTP 500 Series Bridge is the latest innovation in high-speed wireless networking that lets you deploy wireless networks in areas previously unattainable.

Getting Started

3.2.1 Who Should Use This Guide?

The guide is for use by the system installer and the end user IT professional. The system installer will require expertise in the following areas:

- Outdoor radio equipment installation
- Network configuration
- Use of web browser for system configuration, monitoring and fault finding

3.2.2 Contact Information

Postal Address:	Motorola, Inc. Unit A1, Linhay Business Park, Eastern Road, Ashburton, Devon. TQ13 7UP United Kingdom
Web Site:	http://www.motorola.com/ptp
Sales Enquiries:	sales.ptp@motorola.com
Web Support:	http://www.motorola.com/ptp
Email Support:	support.ptp@motorola.com
All Other Enquiries:	info.ptp@motorola.com
Telephone Enquiries and Global Support:	+1 (0) 877 515 0400 (Toll Free in the USA) and +44 (0) 808 234 4640 (Toll Free in the Uk).

Table 4 Contact Information

3.2.3 Repair and Service

For unit repair or service, contact your service provider or an authorized Motorola Point-to-Point Distributor for Return Material Authorization (RMA) and shipping instructions. Alternatively, contact the PTP Global Technical Support Center to process an RMA.

3.3 Product Description

This User Manual is specifically written for the 500 family of point-to-point broadband wireless solutions. The PTP 500 Series Bridge has been developed to provide Point-to-Point data connectivity via a 5.4 GHz or 5.8 GHz wireless Ethernet bridge operating at broadband data rates. The PTP 500 Series Bridge is aimed at a wide range of applications. An example application is an enterprise that has a requirement to connect together the Local Area Network (LAN) of two or more buildings as shown in **Figure 1**.

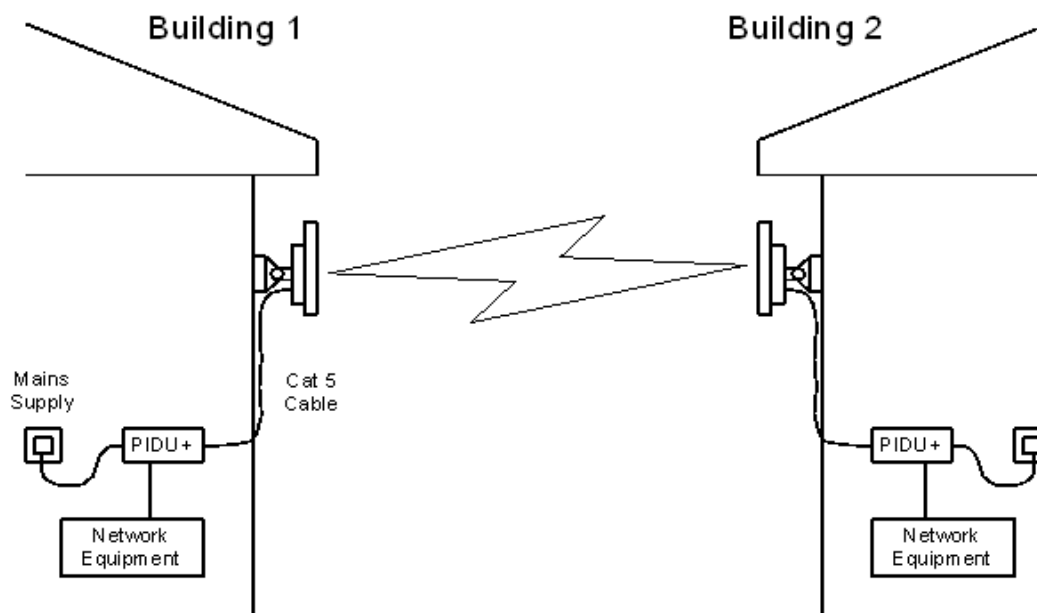

Figure 1 Typical PTP 500 Series Bridge Deployment

The PTP 500 Series Bridge offers true non-line-of-sight (NLOS) operation by using a combination of Orthogonal Frequency Division Multiplexing (OFDM) modulation and Multiple-Input Multiple-Output (MIMO) techniques. These technologies enable the PTP 500 Series Bridge to drive through foliage and around buildings to such an extent that almost universal coverage can be expected at short range.

A PTP 500 Series Bridge system consists of a pair of identical devices that are deployed one at each end of the link. At installation, the user sets up one unit as the Master and the other as the Slave. Either unit can be configured as Master or Slave.

Each end of the link consists of:

- An integrated (or connectorized - see **section 13**) outdoor transceiver unit containing all the radio and networking electronics hereafter referred to as the Outdoor Unit (ODU).
- An indoor connection box containing a mains power supply, status indicators and network connection port. Hereafter referred to as the Power Indoor Unit Plus (PIDU Plus).

Getting Started

A pair of units is normally supplied pre-configured as a link.

The network connection to a PTP 500 Series Bridge is made via a 100BaseT Ethernet connection.

Power is provided to the ODU over the 100BaseT Ethernet connection using a patented non-standard powering technique.

Power is fed into the PTP 500 Series Bridge PIDU Plus from the mains via a standard “figure of eight” mains plug. Connection between the ODU and PIDU Plus is made using standard CAT5e outdoor UV resistant cable. Connection between the PIDU Plus and the Network Equipment is made using standard CAT5e cable.

3.3.1 The Outdoor Unit (ODU)

The ODU is a self-contained unit. It houses both radio and networking electronics. The ODU for the PTP 500 Series Bridge should only be deployed using the supplied PTP 500 Series Bridge PIDU Plus. **Figure 2** shows an installation example of a PTP 500 Series ODU with a Motorola lightning protection unit (PTP-LPU).



Figure 2 PTP 500 Series Bridge Outdoor Unit (ODU) with PTP-LPU

3.3.2 PIDU Plus – PTP 500 Series Bridge

The PTP 500 Series Bridge PIDU Plus is used to generate the ODU supply voltage from the mains supply and inject this supply voltage into the 1000BaseT Ethernet connection to the ODU. Connection uses a CAT5e cable using standard RJ45 wiring.



CAUTION: Care should be taken not to connect equipment other than an ODU for the PTP 500 Series Bridge to a PIDU Plus ODU port as equipment damage may occur. The PTP 500 Series Bridge PIDU Plus is not interchangeable with the PTP 400 Series PIDU Plus but can be used with the PTP 600 Series.



Figure 3 Power Indoor Unit (PIDU Plus) – PTP 500 Series

The front panel contains indicators showing the status of the power and Ethernet connections.

The power indicator is illuminated when the PIDU Plus is receiving mains power.

The Ethernet indicator normally illuminates when the Ethernet link is working, flashing when there is Ethernet activity. The fact that it lights also indicates that the ODU is powered. At power up the LED will flash 10 times to indicate that a correct start up sequence has occurred. See **Section 10** “Fault Finding” for further fault finding information.

At the bottom of the PIDU Plus is an entry point for the PIDU Plus to ODU cable, the 100BaseT Ethernet network port and the Recovery switch.



Figure 4 PIDU Plus Recovery Switch Location

Getting Started

The Recovery switch is used to recover the unit from configuration errors or software image corruption. To put a PTP 500 Series Bridge into Recovery mode the Recovery switch should be pressed then the power applied. The Recovery switch should be kept pressed for at least 30 seconds after the power has been applied. Full instruction on the recovery mode can be found in [Section 9](#) “Recovery Mode”.

A simple reboot can be performed by removing and re-applying the mains power to the PTP 500 Series Bridge PIDU Plus.

On the left hand side of the PIDU Plus, 48V DC input and output connections can be found. These are used to power the PTP 500 Series Bridge from an external DC source or to provide a level of power supply redundancy, as shown in [Section 3.3.3](#) “Redundancy and Alternate Powering Configurations”.



WARNING: When using alternate DC supplies the supply **MUST** comply with the following requirements:

- The voltage and polarity is correct and is applied to the correct terminals in the PIDU Plus
- The power source is rated as SELV
- The power source is rated to supply at least 1A continuously
- The power source cannot provide more than the Energy Hazard Limit as defined by IEC/EN/UL6090, Clause 2.5, Limited Power (The Energy Hazard Limit is 240VA)

Also on the left hand side of the PTP 500 Series Bridge PIDU Plus, connectors and jumpers can be found that allow the remote connection of power LED, Ethernet LED and Recovery switch. The connection instructions can be found in [Section 3.3.4](#) “Remote LEDs and Recovery Switch”.

The input supply range for the 500 Series PIDU Plus is 90V-264V AC, 47-63Hz. Mains connection to the PIDU Plus is made using a standard “figure of eight” mains lead as shown in [Figure 5](#).



Figure 5 PTP 500 Series Bridge PIDU Plus Power Input

3.3.3 Redundancy and Alternate Powering Configurations



NOTE: The use of DC supplies of less than 55v will reduce the usable distance between the PIDU Plus and ODU see **Figure 6**.

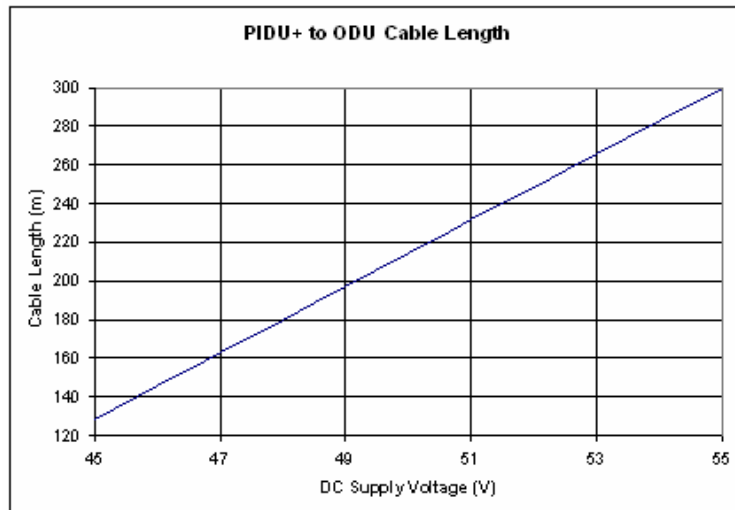

Figure 6 PTP 500 Series Bridge PIDU Plus to ODU Cable Length Graph



CAUTION: The maximum distance from the ODU to the connected network equipment is 100m (330 ft) when using 100BaseT.

3.3.3.1 External DC Supply Only

For use where there is no mains supply.

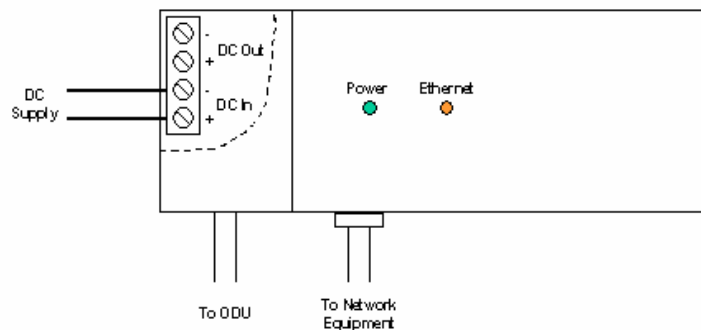

Figure 7 External DC Supply Only

3.3.3.2 External DC Supply and AC Supply

To give redundancy through the use of mains and DC supply.

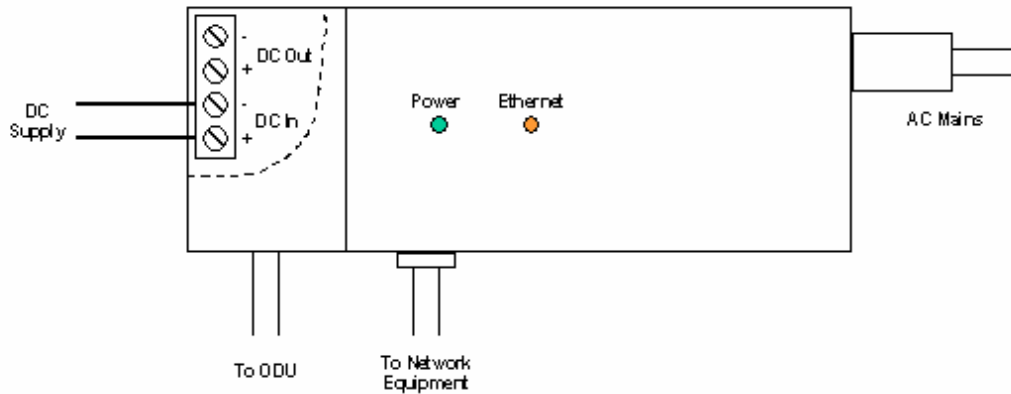

Figure 8 External DC Supply and AC Supply

3.3.3.3 External DC Supply and Redundant AC Supply

To guard against mains failure, DC supply failure of PTP 500 Series Bridge PIDU Plus failure.

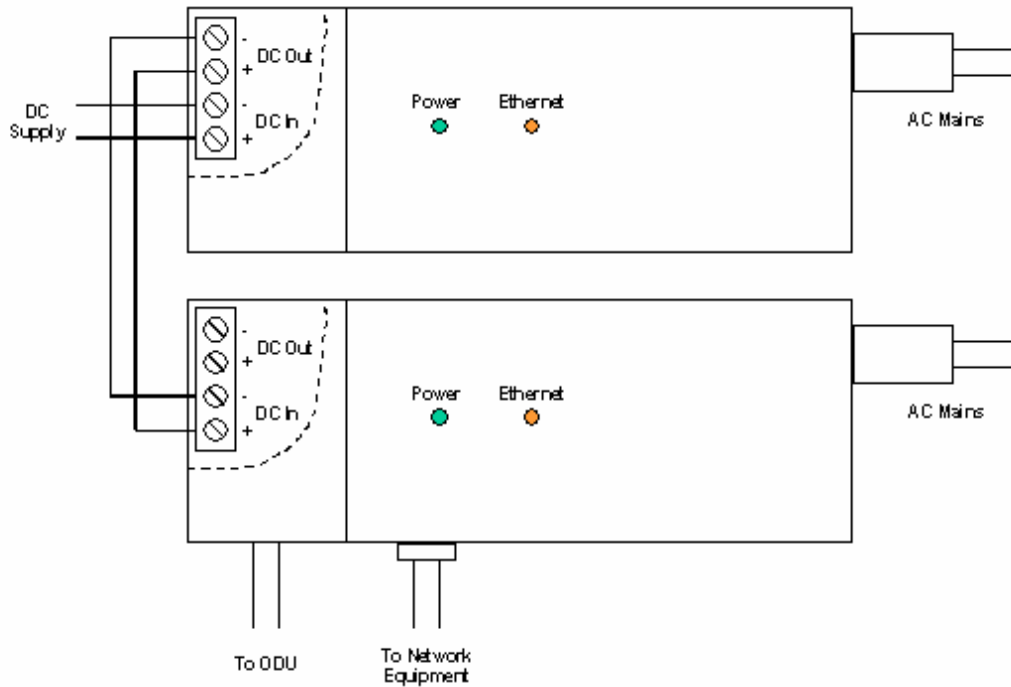

Figure 9 External DC Supply and Redundant AC Supply

3.3.4 Remote LEDs and Recovery Switch

The PTP 500 Series Bridge PIDU Plus provides a facility to connect remote LEDs and Recovery switch allowing the PIDU Plus to be mounted inside an enclosure. At the left hand end of the PIDU Plus under the ODU connection cover can be found a PCB header and three jumpers. Jumpers J906 and J907 should be removed and connection to the remote LEDs and Recovery switch made to J908 as shown in **Figure 10**.

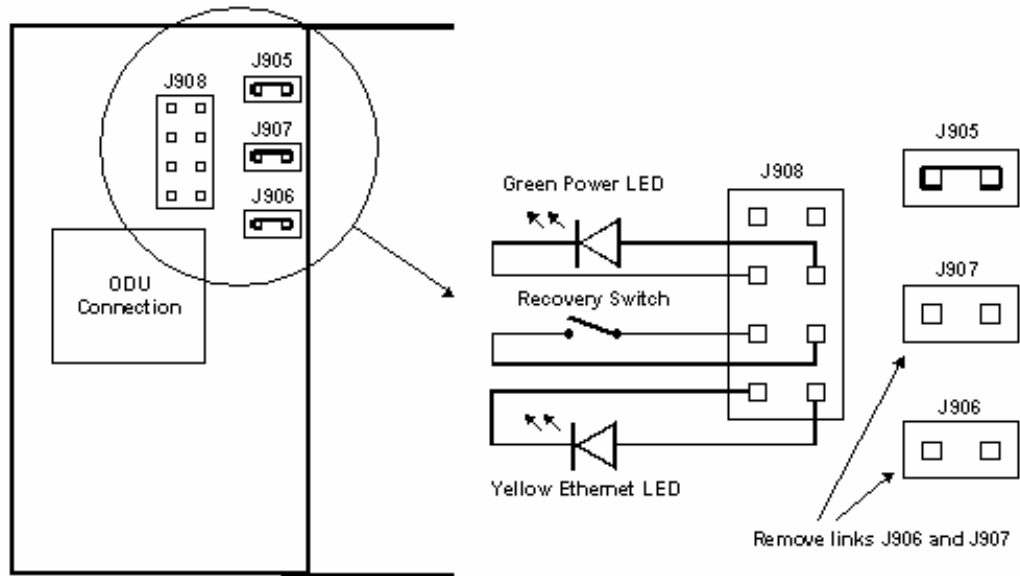

Figure 10 Remote LED and Recovery Switch Wiring

3.3.5 Cables and connectors

The cable used to connect the PTP 500 Series Bridge PIDU Plus to the ODU can be any standard CAT5e type provided that it is suitable for outdoor deployment. Motorola recommends that cables to the specification below be used:

Cable: Superior Essex BBDGE CAT 5e
Connector Type: Tyco, 5-558530-1
Gland: Motorola WB1811



Caution: Failure to use the recommended (or equivalent) standard of cable may invalidate the system's safety certification.

The cable used to connect the PTP 500 Series Bridge PIDU Plus to the users Network Equipment can be any standard CAT5e Cable.

The PIDU Plus to ODU and the PIDU Plus to Network Equipment cables may be unshielded (UTP) or shielded (STP). However, unshielded cables reduce the system's ability to cope with nearby lightning strikes. If lightning activity is common in the area of deployment, the use of shielded cable is highly recommended. See [Section 11](#) "Lightning Protection".



The PIDU Plus provides screen continuity between the ODU and Network Equipment connections. **Note:** The ODU network connection implements automatic MDI/MDI-X sensing and pair swapping allowing connection to networking equipment that require cross-over cables (MDI-X networks) or straight-through cables (MDI Networks).

3.3.6 PTP and Lightning Protection

The PTP 500 Series Bridge PIDU Plus meets the low level static discharge specifications identified in [Section 17](#) "Specifications", but does not provide lightning or surge suppression. Installations will generally require lightning or surge suppression, a separate Ethernet surge suppressor must be used and appropriately earthed. Suitable surge suppressors can be sourced from your Motorola Point-to-Point Distributor or Solutions Provider. See [Section 11](#) "Lightning Protection".

3.3.7 Mounting Brackets

The PTP 500 Series Bridge is supplied with a mounting bracket suitable for mounting the ODU to a pole of 50mm (2") to 75mm (3") in diameter. For more details on mounting, see [Section 7](#) "Installation".

The bracket allows for adjustment in both azimuth and elevation. The bracket may be split allowing the pole mount section of the bracket to be mounted to the pole first. This allows the installer to take the weight of the unit and secure it, one handed, with a single mounting bolt.

The PIDU Plus can either be desk or wall mounted. The preference is wall mounted with the cables dressed to a cable channel. Wall mounting is achieved by screwing through the mounting lugs on either side of the unit. Remember to leave space for access to the Recovery button. See [Section 3.3.2](#) "PIDU Plus – PTP 500 Series Bridge".

3.3.8 Configuration and Management

Configuration and Management of the PTP 500 Series Bridge is implemented using an inbuilt web server hosting a number of Configuration and Management web pages. This approach allows Configuration and Management to be carried out on any standard web browsing technology. The PTP 500 Series Bridge can also be managed remotely using the SNMP management protocol. Connection to the bridge is via the Ethernet connection carrying the bridge network traffic. Connection to the unit is via a preset IP address. This address can be changed via the Network Interface Configuration web page. A full explanation of the available web pages and their use can be found in [Section 8](#) "Web Page Reference".

3.4 Warranty

Motorola's standard hardware warranty is for one (1) year from date of shipment from Motorola or a Motorola Point-to-Point Distributor. Motorola warrants that hardware will conform to the current relevant published specifications and will be free from material defects in material and workmanship under normal use and service. Motorola shall within this time, at its own option, either repair or replace the defective product within thirty (30) days of receipt of the defective product. Repaired or replaced product will be subject to the original warranty period but not less than thirty (30) days.

Motorola warranty for software is described in details in **Section 16.5.1** "Motorola Inc. End User License Agreement".

4 Product Architecture

The PTP 500 Series Bridge consists of an identical pair of units deployed one at each end of the link. The radio link operates on a single frequency channel in each direction using Time Division Duplex (TDD). One unit is deployed as a master and the other as a slave. The master unit takes responsibility for controlling the link in both directions. The non-line-of-sight (NLOS) aspects of the product are provided by Multiple-Input Multiple-Output (MIMO), coupled with Orthogonal Frequency Division Multiplexing (OFDM) modulation.

The PTP 500 Series Bridge has been developed to operate within license exempt frequency bands.

The current product range supports:

- ETSI 5.4 GHz band B (5.470-5.725 GHz)
- ETSI 5.8 GHz band C (5.725-5.850 GHz) and the USA 5 GHz ISM band (5.725-5.850 GHz)

The PTP 500 Series Bridge has been designed to coexist with other users of the band in an optimal fashion using a combination of Transmit Power Control (TPC), Spectrum Management functionality and Antenna beam shape.

In order to maintain link availability, the product employs adaptive modulation techniques that dynamically reduce the data rate in severe or adverse conditions. The PTP 500 series provides wireless Ethernet bridging between two fixed locations. To be more precise, it forwards Ethernet frames as a two-port transparent heterogeneous encapsulation bridge, meaning that each bridge forwards frames between two dissimilar interfaces (Ethernet and wireless), encapsulating Ethernet MAC frames within a PTP MAC frames for transmission at the wireless interface. A link consisting of a pair of back to back bridges appears to the data network to be very similar to a standard two-port Ethernet bridge.

The PTP500 series provides two egress queues in each direction, classifying Ethernet frames into one of the two prioritised queues based on inspection of the user priority field (802.1p) in the IEEE802.1Q VLAN tag. Untagged frames receive a default priority. The queuing method is strict priority. The bridge does not implement any VLAN functions for bridged frames apart from inspection of the priority field, and consequently the bridge forwards tagged and untagged Ethernet frames regardless of VLAN ID and without modification of any protocol header fields..

The management function of the PTP 500 Series Bridge is logically equivalent to a separate protocol stack with virtual point of attachment at the Ethernet interface. This is illustrated in **Figure 11**.

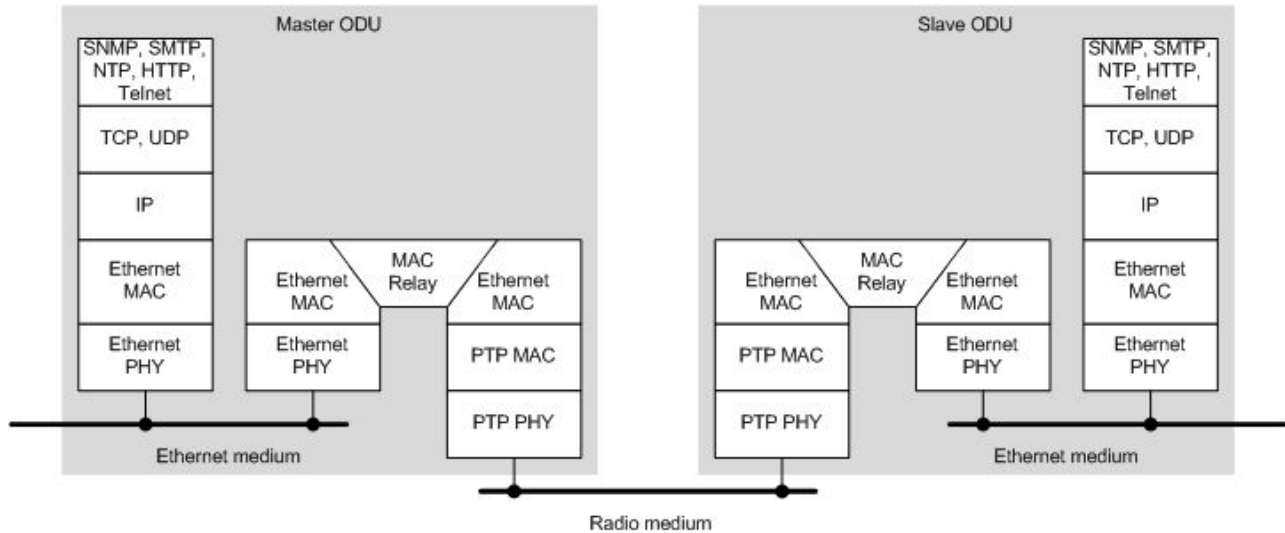

Figure 11 PTP 500 Series Bridge Layer Diagram

Each unit in the link is manageable through an IP connection. Standard IP protocols are utilized for all management functions e.g., HP, SNMP, etc. The unit can be configured to use VLAN tags on the management interfaces.

The PTP 500 Series Bridge is fully software upgradeable. New software images are first downloaded from the Motorola website <http://www.motorola.com/ptp> to a convenient computer. The image is then uploaded to the ODU via the web management page described in **Section 8.3.6** “Software Upgrade”. The compressed image is first loaded into RAM and check-summed. If the compressed image transfer has completed successfully the image is decompressed and written to flash memory. On completion of this process the unit can be rebooted to use the newly uploaded image. Should this process fail, the unit will revert to a protected compressed image installed during manufacturing to allow the unit to be recovered.

5 General Considerations

5.1 Spectrum Planning

The PTP 500 Series Bridge has four frequency variants in its product range.

Band	Definition	Frequency Coverage	Variable Channel Width	Channel Raster
5.4 GHz	ETSI 5 GHz band B, USA UNII Band	5470-5725 MHz	15 MHz	5 MHz
5.8 GHz	USA ISM Band / ETSI 5 GHz band C	5725-5850 MHz	15 MHz	5 MHz

Table 5 PTP 500 Series Bridge Variants

Note: for 5.4 GHz and 5.8 GHz, use of the product is allowed according to local regulations.

There are two distinct approaches to spectrum planning:

- First an operator can utilize the default spectrum management mode i-DFS (intelligent Dynamic Frequency Selection). This mode uses the PTP 500 Series Bridge ability to measure the interference levels in all channels to build up a picture of the interference / noise levels in all channels. The PTP 500 Series Bridge uses statistical techniques to select the most appropriate transmit and receive channels. i-DFS can be influenced in its channel decision process by selectively barring channels from use. The use of this functionality is described in detail in [Section 8.3.7](#) “Spectrum Management”.
- Second, when detailed control of the spectrum allocation is required, it is recommended that the fixed frequency mode is used to statically allocate transmit and receive channels.

General Considerations

5.2 Region Codes

The PTP 500 Series Bridge uses a system of Region Codes to control the operation of the radio link. The Region Code is set by a License Key.



Caution: To meet the regulatory requirements of your region you should set the correct Region Code by obtaining a new License Key from your reseller or distributor.

Region Code	Frequency Band	Regulatory Body or Countries	Max Tx Power	EIRP Limit	Operational Restrictions (see Section 5.3 “Operational Restrictions”)
1	5.8 GHz	FCC Compliant (e.g. USA, Canada, Taiwan, Brazil)	25 dBm	None	Reduced TX Power at Band Edges see Section 5.6.2 “5.8 GHz Transmit Power Reduction at the Band Edges”
2	5.8 GHz	China	10 dBm	33 dBm	
3	5.8 GHz	Australia, Hong Kong	13 dBm	36 dBm	
4	5.8 GHz	UK	12 dBm	35 dBm	Radar Avoidance Enabled and RTTT (Road Transport and Traffic Telematics, 5795 to 5815 MHz channels cannot be used)
5	5.8 GHz	Singapore	-3 dBm	20 dBm	
6	5.8 GHz	Eire	10 dBm	33 dBm	
7	5.4/5.8 GHz	Unregulated DFS and RTTT	25 dBm	None	Radar Avoidance Enabled and RTTT (Road Transport and Traffic Telematics, 5795 to 5815 MHz channels cannot be used)
8	5.4 / 5.8 GHz	Unregulated Internal Use	25 dBm	None	

General Considerations

Region Code	Frequency Band	Regulatory Body or Countries	Max Tx Power	EIRP Limit	Operational Restrictions (see Section 5.3 “Operational Restrictions”)
11	5.4 GHz	Korea	20 dBm	43 dBm	Band restricted : 5725 MHz to 5825 MHz
12	5.4 GHz	USA	7 dBm	30 dBm	Radar Avoidance Enabled
13	5.4 GHz	Australia, Canada	7 dBm	30 dBm	Radar Avoidance Enabled Weather; Radar Band (5600 to 5650 MHz) barred
16	2.5 GHz	USA	23 dBm	≥ 63 dBm	Licensed Band operation. Note Power reduction in the Upper Band.
18	2.5 GHz	Taiwan	23 dBm		Channel 2590 MHz should not be used because of in-band interference.
19	5.8 GHz	India	13 dBm	36 dBm	5.825 MHz to 5.850 MHz Only
20	5.4 / 5.8 GHz	Thailand	7 dBm	30 dBm	Fixed Power for all bandwidths.
21	5.4 GHz	Korea	5 dBm	28 dBm	Maximum Channel Bandwidth 20 MHz. 5470 MHz to 5650 MHz only.
22	5.8 GHz	Germany	12 dBm	35 dBm	5755 MHz to 5850 MHz only.
23	4.5 GHz	Military	25 dBm	None	
24	5.8 GHz	Bahrain	20 dBm	33 dBm	
26	5.4 GHz	ETSI	7 dBm	30 dBm	Radar Avoidance Enabled Weather; Radar Band (5600 to 5650 MHz) barred

General Considerations



Note: For Region Code 16, the EIRP limit is approximately $63 \text{ dBm} + 10 \times \text{Log}(360/\text{Antenna Azimuth BW})$.

When shipped from the factory units³ are configured as follows:

- PTP 500 Series Bridge 5.4 GHz – Region Code 26⁴
- PTP 500 Series Bridge 5.8 GHz – Region Code 1

5.3 Operational Restrictions

5.3.1 Radar Avoidance

Radar Avoidance requires that equipment used in the region:

- Detects interference from other systems and avoids co-channel operation with these systems, notably radar systems.
- Provide on aggregate a uniform loading of the spectrum across all devices, i.e. Fixed Frequency operation is not allowed.
- Radar avoidance is not applicable to the PTP54600 product.

To address the primary aims the Spectrum Management algorithm implements a radar detection function which looks for impulsive interference on the active channel only. If impulsive interference is detected Spectrum Management will mark the current active channel as having detected radar and initiate a channel hop to an available channel. The previous active channel will remain in the radar detected state for thirty minutes after the last impulsive interference pulse was detected. After the thirty minutes have expired the channel will be returned to the available channel pool.

The radar detection algorithm will always scan the active channel for 60 seconds for radar interference before using the channel. This compulsory channel scan will mean that there is a 60 seconds service outage every time radar is detected and that the installation time is extended by 60 seconds even if there is found to be no radar on the channel.



NOTE: On system installation or start-up this extends the initial scan time of the Master unit by 60 seconds. To address the “provide aggregate uniform loading of the spectrum across all devices” requirement, the channel selection algorithm will choose a channel at random from a list of available channels. The channel selection algorithm is initiated at link initialization and when radar interference is detected.

³ Note that 5.4 GHz and 5.8 GHz are different products.

⁴ Note that the Quickstart Guide also contains the license keys for region 12 and 13.

General Considerations

5.3.2 RTTT Avoidance and Other Channel Use Restrictions

Where regulatory restrictions apply to certain channels these channels are barred. The user should note that the number of channels barred is dependent on the channel raster selected. For example see the effect of the UK RTTT channel restrictions in **Figure 12**. Barred channels are indicated by a “No Entry” symbol displayed on the “Spectrum Management” web page, see **Section 8.3.9** “Spectrum Management Control - With Operational Restrictions”.



NOTE: “Radar Avoidance Enabled” is only valid with 30 MHz channel bandwidth.

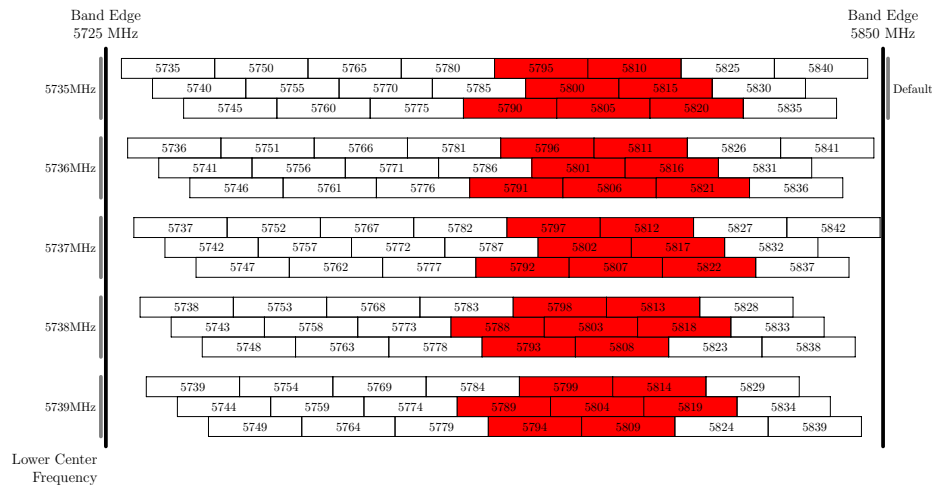

Figure 12 5.8 GHz UK RTTT Channel Avoidance – 15 MHz Channel Bandwidth Only

5.3.3 Radar Avoidance, i-DFS and Variable (Narrow) Bandwidth Operation

Radar avoidance at 5.8 GHz is applicable to EU operation and the requirements are currently as defined in EN 302 502 v1.1.1

5.4 Variable Channel Bandwidth Operation

Channel bandwidth of 15 MHz⁵ is supported for Only Full versions of the PTP 500.

Configuration of the variable bandwidth operation must be symmetric, i.e. the Transmit and receive channels must use identical channel bandwidths.



⁵ 15MHz channel widths are available where allowed by local regulations and subject to some restrictions on channel choice.

General Considerations

5.5 5.4 GHz Specific Frequency Planning Considerations

Adjustment of the lower centre frequency allows the operator to slide the available frequency settings up and down the 5.4 GHz band. See **Figure 13**.

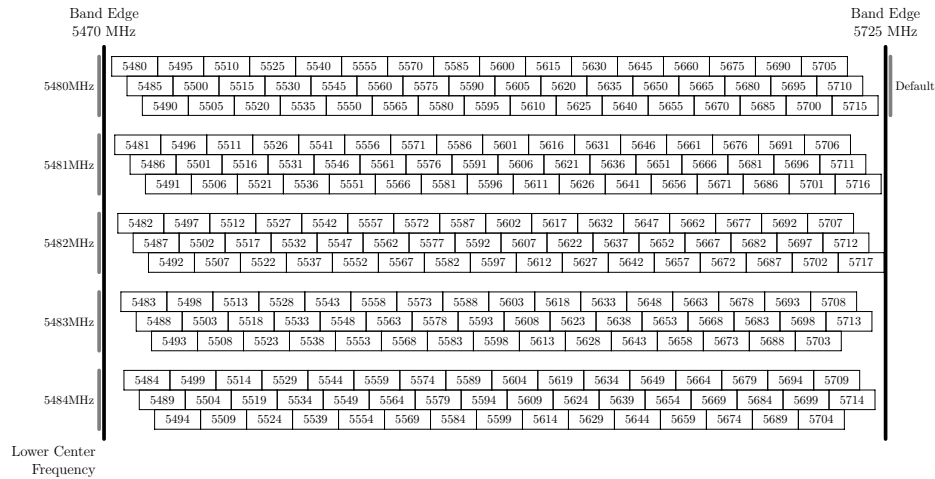

Figure 13 5.4 GHz Available Spectrum Settings – 15 MHz Channel Bandwidth

5.5.1 5.4 GHz Raster Considerations

The PTP 500 Series Bridge 5.4 GHz variant operates on a 5 MHz channel raster. The channel raster is set to even centre frequencies. See **Figure 13**.

5.5.2 5.4 GHz Transmit Power Reduction at the Band Edges

The 5.4 GHz product variant does not apply any band edge power reduction.

General Considerations

5.6 5.8 GHz Specific Frequency Planning Considerations

Adjustment of the lower center frequency allows the operator to slide the available frequency settings up and down the 5.8 GHz bands. **Figure 14** shows the available spectrum.

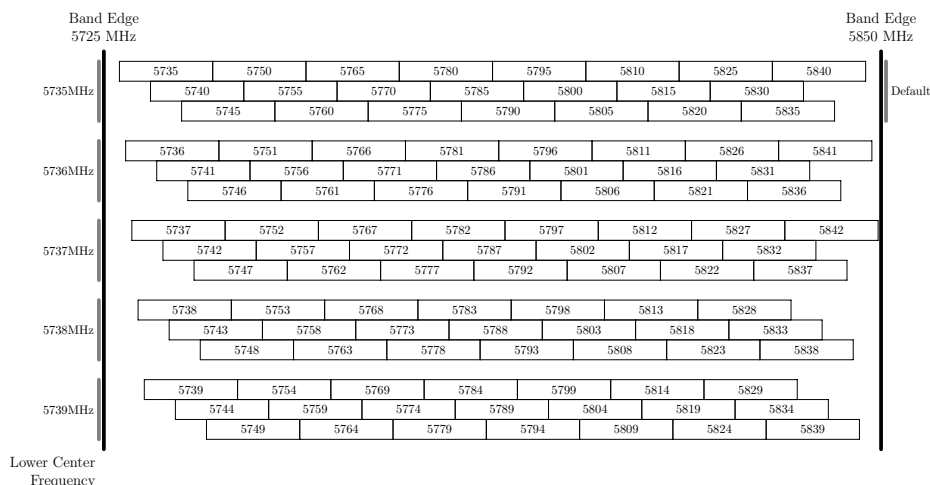

Figure 14 5.8 GHz Available Spectrum Settings – 15 MHz Channel Bandwidth

5.6.1 5.8 GHz Raster Considerations

The PTP 500 Series Bridge 5.8 GHz variant operates on a 5 MHz channel raster. The channel raster is set to even center frequencies. See **Figure 14**.

5.6.2 5.8 GHz Transmit Power Reduction at the Band Edges

Operation at or near the 5.8 GHz band edges can result in a lower maximum transmit power. In some configurations the PTP 500 Series Bridge solution reduces the power when operating at the edge channels. The amount of reduction, if any, is dependent on the region code of the region of operation. This currently only affects systems configured with Region Code 1. The power reduction in the edge channels for 15 MHz is presented in **Table 6** (for region code 1 ONLY).

General Considerations

Channel Center Frequency (MHz)	Maximum Output Power (dBm)
	Channel Bandwidth (MHz)
	15
5735	25
5736	25
5737	25
5738	25
5739 - 5838	25
5740	25
5742 - 5832	25
5839	26
5840	26

Table 6 5.8 GHz Band Edge Tx Power Reduction

5.7 Distance

The PTP 500 Series Bridge will operate at ranges from 100 m (330 ft) to 200 km (124 miles), within 3 modes: 0-40km (0-25 miles), 0-100km (0-62 miles) and 0-200km (0-124 miles). Operation of the system will depend on obstacles in the path between the units. Operation at 40 km (25 miles) or above will require a near line-of-sight path. Operation at 100m (330 ft) could be achieved with one unit totally obscured from the other unit, but with the penalty of transmitting at higher power in a non-optimal direction, thereby increasing interference in the band. This subject is covered in more detail in **Section 6.1.3** “Path Loss Considerations”.

5.8 Networking Information

The PTP 500 Series Bridge operates as a transparent Ethernet bridge. Each unit requires an IP address. This IP address is for management purposes only and it plays no part in the operation of the system. IP addresses are assigned during initial configuration as described in **Section 7.2** “Installation Procedure”.

5.9 Lightning Protection and regulations



The amount of lightning protection is dependent on regulatory requirements and the end user requirements. The standard ODU for the PTP 500 Series Bridge is fitted with surge limiting circuits and other features to minimize the risk of damage due to nearby lightning strikes. These standard features may require some additional equipment to be configured as part of the system installation to be fully effective. Motorola recommends the use of screened cable and Lightning Protection units to protect connected equipment from nearby strikes.



NOTE: The PTP 500 Series Bridge is not designed to survive direct lightning strikes. For this reason the unit should not be installed as the highest point in a localized area, unless specific precautions are taken. See **Section 11** “Lightning Protection”.

5.10 Electrical Requirements

The PTP 500 Series Bridge requires one mains supply outlet at each end of the link to plug in the PIDU Plus units (**Section 3.3.2** “PIDU Plus – PTP 500 Series Bridge”).

6 Site Planning

6.1 Site Selection Criteria

The following are guidelines for selecting the installation location of the ODU and PIDU Plus for a PTP 500 Series Bridge.

6.1.1 ODU Site Selection

When selecting a site for the ODU the following should be taken into consideration:

- It is not possible for people to stand or walk inadvertently in front of the antenna
- Height and location to achieve the best radio path
- Height in relation to other objects with regard to lightning strikes
- Aesthetics and planning permission issues
- Distance from the ODU and connected Network equipment (Maximum cable run from the ODU to the connected equipment is 100m [330 ft])
- Distance from the PIDU Plus to the ODU (Maximum cable run from the PIDU Plus to the ODU is 300m [990 ft] when using the Fiber interface)

6.1.2 PTP 500 Series Bridge PIDU Plus Site Selection

When selecting a site for the PIDU Plus the following should be taken into consideration:

- Availability of a mains electricity supply
- Accessibility for viewing status indicators and pressing Recovery switch.

6.1.3 Path Loss Considerations

The path loss is the amount of attenuation the radio signal undergoes between the two ends of the link. The path loss is the sum of the attenuation of the path if there were no obstacles in the way (Free Space Path Loss), the attenuation caused by obstacles (Excess Path Loss) and a margin to allow for possible fading of the radio signal (Fade Margin).

$$L_{\text{free_space}} + L_{\text{excess}} + L_{\text{fade}} + L_{\text{seasonal}} < L_{\text{capability}} \quad (3)$$

Where

$L_{\text{free_space}}$	=	Free Space Path Loss	dB
L_{excess}	=	Excess Path Loss	dB
L_{fade}	=	Fade Margin Required	dB
L_{seasonal}	=	Seasonal Fading	dB
$L_{\text{capability}}$	=	Equipment Capability	dB

6.1.4 Definitions

The equipment capability is given in **Table 7**, **Table 9** (IP Mode) and **Table ??**, **Table 10** (TDM Mode). Each table gives Link Loss Output Power and System Thresholds for PTP 500 Series Bridge in all modulation modes for the channel bandwidth 15 MHz. Adaptive Modulation will ensure that the highest throughput that can be achieved instantaneously will be obtained taking account of propagation and interference. The calculation of Equation 3 needs to be performed to judge whether a particular link can be installed. When the link has been installed, web pages provide information about the link loss currently measured by the equipment both instantaneously and averaged. The averaged value will require maximum seasonal fading to be added, and then the radio reliability of the link can be computed.

For minimum error rates on TDM links the maximum modulation mode should be limited to 64QAM 0.75.

The values for (BPSK) are static receive sensitivity measurements. The other values are static receive sensitivity measurements with an AMOD threshold applied. The AMOD threshold applied is for a benign radio channel.

Sensitivity: Sensitivity is defined as the combined receive input signal level on both horizontal and vertical inputs that produces a Null Bit Error Ratio of 3×10^{-7} .

Output Power: The output power is for a centre channel in Region 1. The output power will be reduced on the edge channels and may vary if different region codes are selected.

AMOD Threshold: The AMOD threshold is the combined receive input signal level on both horizontal and vertical inputs that results in the link consistently entering the receive modulation mode under consideration as the signal level is increased.

System Threshold: Thresholds for all modes except BPSK are for the relevant link optimization AMOD thresholds. System threshold for BPSK is the RPSK receive sensitivity.

Max Link Loss: The maximum link loss for each modulation mode is derived from the AMOD threshold for that mode (sensitivity threshold for BPSK) and the maximum Region 1 centre channel output power. The figures assume integral antennas with 23dBi (5.8 GHz and 5.4 GHz) gain are used.

Site Planning

6.1.5 5.4 GHz Product Variant - Link Loss, Output Power and System Thresholds versus Modulation Mode

Table 7 and **Table 8** show respectively sensitivity figures for IP and TDM respectively.

Modulation Mode	Threshold Value (dBm)	Output Power (dBm)	Maximum Link Loss (dB)
	Channel Bandwidth (MHz)		
	15 MHz		
256QAM 0.75 dual	-65.02	+21	133.02
64 QAM 0.83 dual	-69.63	+21	137.63
64QAM 0.67 dual	-73.22	+22	142.22
16QAM 0.75 dual	-76.59	+23	146.59
16QAM 0.50 dual	-80.72	+24	151.72
QPSK 0.75 dual	-82.78	+25	154.78
QPSK 0.50 dual	-89.08	+26	162.08
256QAM 0.75 single	-68.58	+21	136.58
64QAM 0.83 single	-72.90	+21	140.90
64QAM 0.67 single	-76.35	+22	145.35
16QAM 0.75 single	-79.72	+23	149.72
16QAM 0.50 single	-83.82	+24	154.82
QPSK 0.75 single	-85.74	+25	157.74
QPSK 0.50 single	-89.02	+26	162.02
BPSK 0.50 single	-94.25	+27	168.25

Table 7 5.4GHz - IP Mode - Sensitivity Figures

Modulation Mode	Threshold Value (dBm)	Output Power (dBm)	Maximum Link Loss (dB)
	Channel Bandwidth (MHz)		
	15 MHz		
256QAM 0.75 dual	-63.52	+21	131.52
64 QAM 0.83 dual	-68.13	+21	136.13
64QAM 0.67 dual	-71.72	+22	140.72
16QAM 0.75 dual	-75.09	+23	145.09
16QAM 0.50 dual	-79.22	+24	150.22
QPSK 0.75 dual	-81.28	+25	153.28
QPSK 0.50 dual	-87.58	+26	160.58
256QAM 0.75 single	-67.08	+21	135.08
64QAM 0.83 single	-71.40	+21	139.40
64QAM 0.67 single	-74.85	+22	143.85
16QAM 0.75 single	-78.22	+23	148.22
16QAM 0.50 single	-82.32	+24	153.32
QPSK 0.75 single	-84.24	+25	156.24
QPSK 0.50 single	-87.52	+26	160.52
BPSK 0.50 single	-94.25	+27	168.25

Table 8 5.4GHz -TDM Mode - Sensitivity Figures

Site Planning

6.1.6 5.8 GHz Product Variant - Link Loss, Output Power and System Thresholds versus Modulation Mode

Table 9 and **Table 10** show respectively sensitivity figures for IP and TDM respectively.

Modulation Mode	Threshold Value (dBm)	Output Power (dBm)	Maximum Link Loss (dB)
	Channel Bandwidth (MHz)		
	15 MHz		
256QAM 0.75 dual	-65.02	+21	133.02
64 QAM 0.83 dual	-69.63	+21	137.63
64QAM 0.67 dual	-73.22	+22	142.22
16QAM 0.75 dual	-76.59	+23	146.59
16QAM 0.50 dual	-80.72	+24	151.72
QPSK 0.75 dual	-82.78	+25	154.78
QPSK 0.50 dual	-89.08	+26	162.08
256QAM 0.75 single	-68.58	+21	136.58
64QAM 0.83 single	-72.90	+21	140.90
64QAM 0.67 single	-76.35	+22	145.35
16QAM 0.75 single	-79.72	+23	149.72
16QAM 0.50 single	-83.82	+24	154.82
QPSK 0.75 single	-85.74	+25	157.74
QPSK 0.50 single	-89.02	+26	162.02
BPSK 0.50 single	-94.25	+27	168.25

Table 9 5.8GHz - IP Mode - Sensitivity Figures

Modulation Mode	Threshold Value (dBm)	Output Power (dBm)	Maximum Link Loss (dB)
	Channel Bandwidth (MHz)		
	Channel Bandwidth (MHz)		
	15 MHz		
256QAM 0.75 dual	-63.52	+21	131.52
64 QAM 0.83 dual	-68.13	+21	136.13
64QAM 0.67 dual	-71.72	+22	140.72
16QAM 0.75 dual	-75.09	+23	145.09
16QAM 0.50 dual	-79.22	+24	150.22
QPSK 0.75 dual	-81.28	+25	153.28
QPSK 0.50 dual	-87.58	+26	160.58
256QAM 0.75 single	-67.08	+21	135.08
64QAM 0.83 single	-71.40	+21	139.40
64QAM 0.67 single	-74.85	+22	143.85
16QAM 0.75 single	-78.22	+23	148.22
16QAM 0.50 single	-82.32	+24	153.32
QPSK 0.75 single	-84.24	+25	156.24
QPSK 0.50 single	-87.52	+26	160.52
BPSK 0.50 single	-94.25	+27	168.25

Table 10 5.8GHz - TDM Mode - Sensitivity Figures

7 Installation



Motorola recommends that only qualified personnel undertake the installation of a PTP 500 Series Bridge solution.

7.1 Preparation

Before proceeding with the installation you should:

- Check the contents of all packages against the parts lists shown in the packing list.
- Ensure that you have the correct tools for the job.
- Ensure that you are qualified to undertake the work.
- Ensure that you have taken the correct safety precautions.
- Have completed the site planning as described in **Section 6** “Site Planning”.

7.2 Installation Procedure

The 500 Series installation procedure consists of the following steps:

- Mounting the ODUs, **Section 7.6** “Mounting the ODUs”
- Connecting up, **Section 7.7** “Connecting Up”
- Mounting the PIDU Plus Units, **Section 7.7.9** “Mounting the PTP 500 Series Bridge PIDU Plus”
- Mounting the Lightning Protection Units, **Section 7.7.5** “Fitting a Lightning Protection Unit”.
- Powering Up, **Section 7.7.10** “Powering Up”
- Aligning the ODUs, **Section 7.7.11** “Aligning the PTP 500 Series Bridge ODUs”

7.3 Tools Required

The following specific tools are required to install a PTP 500 Series Bridge in addition to general tools:

- 13mm Spanner / Wrench
- RJ45 Crimp Tool
- IBM Compatible Personal Computer (PC) running Windows 98 or later with 10, 100 or 1000BaseT Ethernet (Ability to change IP settings easily is recommended)
- Either Internet Explorer version 6 or higher, or FireFox 1.5 or higher are recommended.
- Ethernet patch cable

7.4 Installation Support

Online installation support and contact details for your regional support can be found at

<http://www.motorola.com/ptp>. A Frequently Asked Questions (FAQ) section can be found in **Section 18** “FAQs”.

7.5 Legal Disclaimer



IN NO EVENT SHALL MOTOROLA, INC. BE LIABLE FOR ANY INJURY TO ANY PERSONS OR ANY DAMAGE CAUSED DURING THE INSTALLATION OF THE MOTOROLA PTP 500 SERIES PRODUCT.

7.6 Mounting the ODUs

The ODU mounting bracket is designed to ease installation by fixing the bracket to a pole and then bringing the ODU into position using a single bolt fixing. The ODU should be mounted using the following steps ensuring that the cable entry is at the bottom.

The ODU mounting bracket is designed to work with poles with diameters in the range 50mm (2") to 75mm (3").



Step 1: Mount the bracket to the pole.



Step 2: Mate the unit to the bracket together and tighten the nut and bolt.

Pole diameters of 25mm (1") to 50mm (2") can be accommodated by inverting the back of the bracket as shown in **Figure 15**.



Figure 15 Mounting to pole diameters 25mm (1") to 50mm (2")

When adjustment is complete tighten all bolts to 14Nm (11lb ft).



CAUTION: Do not over tighten the bolts as bracket failure may occur.

Installation

The enclosure and mounting brackets of the PTP 500 Series Bridge product range are capable of withstanding wind speeds up to 151mph (242kph). The installer should ensure that the structure the bridge is fixed to is also capable of withstanding the prevalent wind speeds and loads. See [Section 12 "Wind Loading"](#).



The integral safety loop should be used both for hoisting the ODU up a mast or building and into position, and also as a fixing point to secure a permanent safety lanyard from the tower/building to the ODU in case of mounting failure.

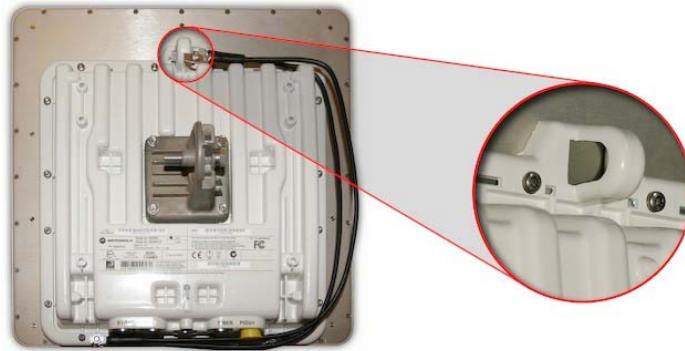

Figure 16 Integral Safety Loop

The length of the safety lanyard must not exceed 1m (approx 3 ft) in length. The lanyard should be made from a material that does not degrade in an outdoor environment.

The safety lanyard must be fixed to a separate fixing point that is not part of the direct mounting system for the ODU.

7.7 Connecting Up

7.7.1 Preparing the PIDU Plus To ODU Cable



NOTE: The maximum cable length between the ODU and the user's Network Equipment is 100m (330 ft). Cable lengths up to 300m (984 ft) can be used where the PIDU Plus to ODU cable is supplying power only, i.e., when using the PTP 500 Series Bridge Optical Interface.

The cable should be assembled as shown in **Figure 17**:

Correct cable preparation for the recommended cable

Note: Fit Gland to cable before fitting RJ45

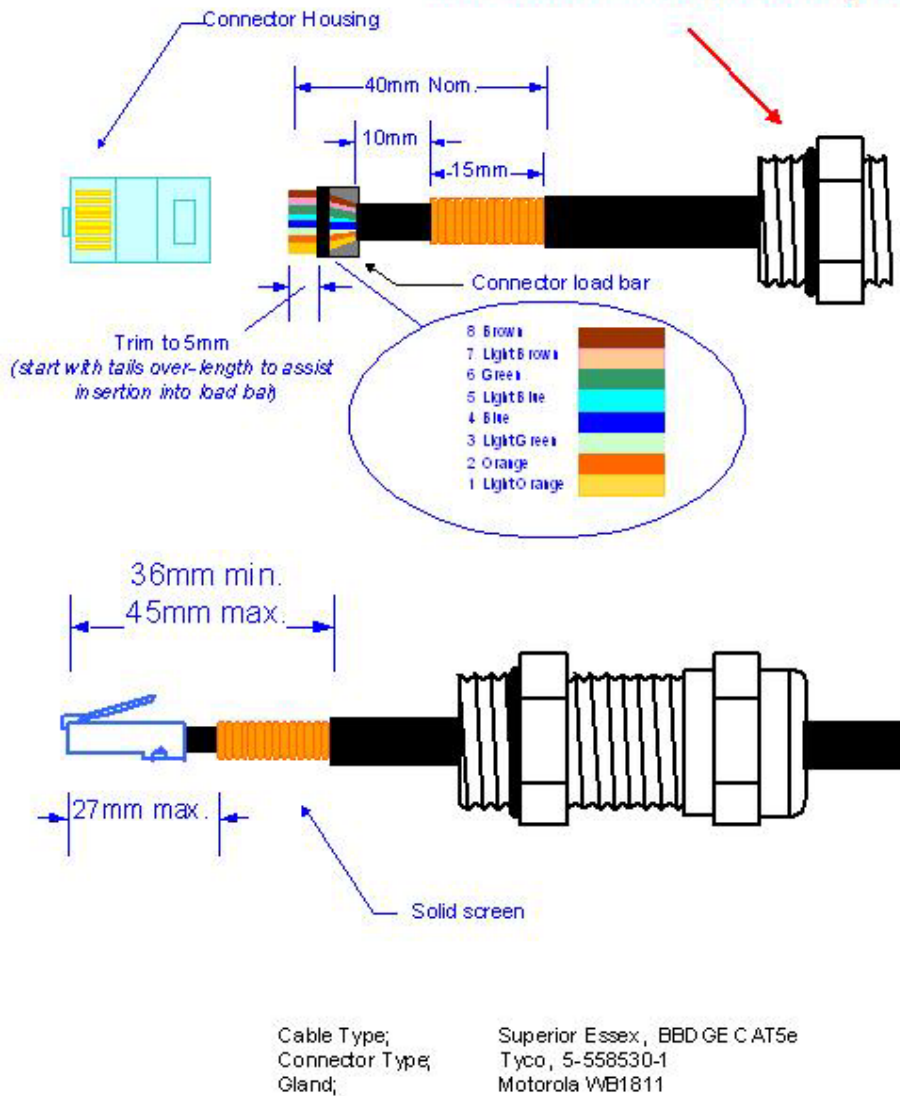

Figure 17 Correct Cable Preparation for the Recommended Cable

Both ends of the ODU cable are terminated in the same way. The above procedure should be repeated for the PIDU Plus end of the cable when the cable routing process is complete. This assumes that the installation uses PTP LPUs. If not, then the PIDU Plus end of the cable does not require a Gland, but just the RJ45.

NOTE: The PIDU Plus end of the cable does not use a cable gland.



Installation

Figure 18 shows a completed ODU to PIDU Plus cable.



Figure 18 Completed ODU Connector



CAUTION: Do not over tighten the glands as the internal seal and structure may be damaged.

See **Figure 19** for an example of an over tightened cable gland.



Figure 19 Warning Not To Over tighten Cable Gland

7.7.2 Making the Connections at the ODU

Looking at the back of the unit with the cable entry at the bottom, the PTP 500 Series Bridge PIDU Plus connection is the first hole on the right (**Figure 20**) and is labeled “PIDU +”.

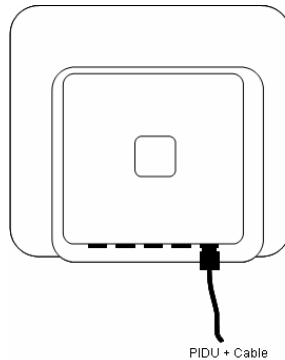

Figure 20 PTP 500 Series Bridge PIDU Plus Connexion

Installation

7.7.3 Making the PTP 500 Series Bridge PIDU Plus Connection At The ODU

The following procedure describes how connection is made at the ODU. It is often easier to carry out this procedure on the ground or a suitable surface prior to mounting the ODU.

Ensure that no power is connected to the PIDU Plus or present on the cable before connecting the ODU.



Step 1: Assemble the cable as described in 5.7.1 above



Step 2: Insert the RJ45 connector making sure that the locking tab snaps home



Step 3: Screw in the body of the weather proofing gland and tighten



Step 4: Screw on the clamping nut and tighten (Do not over tighten – see [Figure 19](#))

Figure 21 Connecting the PIDU+ to the ODU

Installation

Should it be necessary to disconnect the PIDU Plus to ODU cable at the ODU, this can be achieved by removing the weather proofing gland and depressing the RJ45 locking tab with a small screwdriver as shown below:

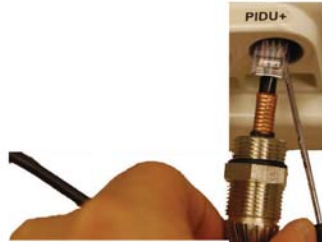

Figure 22 Disconnecting the ODU



CAUTION: Ensure that power is removed from the system at the PIDU Plus to prevent damage to the ODU while making or breaking the connection.

7.7.4 Routing the Cable

After connecting the cable to the ODU it can be routed and secured using standard cable routing and securing techniques. When the cable is in place it can then be cut to the desired length at the PIDU Plus prior to connection to the PIDU Plus

7.7.5 Fitting a Lightning Protection Unit



If you have opted to fit a Lightning Protection unit, this should be installed by following the manufacturer's instruction. For recommended types see **Section 11** "Lightning Protection"

7.7.6 Grounding the Installation



The Outdoor Unit (ODU) must be properly grounded to protect against power surges. It is the user's responsibility to install the equipment in accordance with Section 810 of the National Electric Code, ANSI/NFPA No.70-1984 or Section 54 of the National Electrical Code in the country of installation. These codes describe correct installation procedures for grounding the outdoor unit, mast, lead-in wire and discharge unit, size of grounding conductors and connection requirements for grounding electrodes. It is recommended that installation of the outdoor unit be contracted to a professional installer.

7.7.7 Making the ODU Connection at the PTP 500 Series Bridge PIDU Plus

The ODU is connected to the PIDU Plus by means of a concealed RJ45 connector. The RJ45 connection has been placed inside the PIDU Plus hinged cover to prevent the user from inadvertently plugging other equipment into the ODU RJ45 socket.



CAUTION: Plugging other equipment into the ODU RJ45 socket may damage the equipment due to the non-standard techniques employed to inject DC power into the 1000BaseT connection between the PIDU Plus and the ODU. Plugging the ODU into other equipment may damage the ODU and/or the other equipment.



Step 1: Undo the retaining screw and hinge back the cover



Step 2: Plug in the ODU into the PIDU Plus Cable ensuring that it snaps home



Step 3: Replace the cover and secure with the retaining screw

Installation

7.7.8 Making the Network Connection at The PIDU Plus – PTP 500 Series Bridge

The Network connection is made by connecting the user's Network Equipment directly to the PIDU Plus LAN port as shown in **Figure 23**.



Figure 23 Making the Network Connection at the PIDU Plus

7.7.9 Mounting the PTP 500 Series Bridge PIDU Plus

This step is optional. Motorola recommends that you mount the PIDU Plus on a wall or other suitable mounting surface. This prevents the unit from being knocked or kicked and can help maintain link availability. Ensure that the Recovery switch can be accessed when mounting the unit.



Plus to the wall using the lugs provided



Make connections as per **Section 7.7.8**

Installation



CAUTION: The PIDU Plus is not waterproof and should be mounted away from sources of moisture. If mounted outdoors, the unit should be mounted in a rain proof enclosure, preferably ventilated.

It is also recommended that you fit a drip loop on the PIDU Plus to ODU cable to ensure that any moisture that runs down the cable into the cabinet or enclosure cannot enter the PIDU Plus. As shown in **Figure 24**. The network connection and mains cable should be treated in the same way if there is a risk that they can carry moisture to the PIDU Plus.

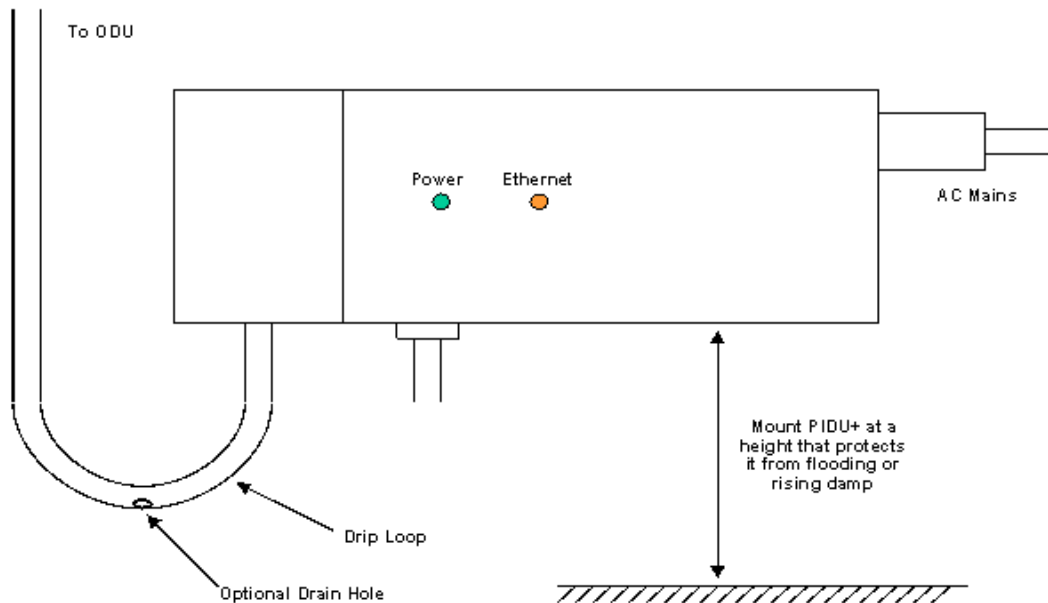

Figure 24 PTP 500 Series PIDU Plus Drip Loop Configuration



CAUTION: It is possible for moisture to enter the cable due to damage to the outer protective layer. This moisture can track down the inside of the cable, filling up the drip loop and eventually finding its way into the PIDU Plus. To protect against this the outer protective layer of the cable can be opened up at the bottom of the drip loop to allow this moisture to escape.

7.7.10 Powering Up

The PTP 500 Series Bridge is supplied as a pair of matched Master/Slave units. The Master unit can now be powered up and accessed using the default URL <http://169.254.1.2/>; the Slave unit can be accessed using <http://169.254.1.1/>.



Prior to powering up the PTP 500 Series Bridge, a computer with web browsing capabilities should be configured with an IP address of 169.254.n.n and subnet mask of 255.255.0.0 where n is any value between 1 and 254 but excluding 1.1 or 1.2. If the default addresses of the unit 169.254.1.1/2 clashes with an address you are already using on your LAN, or you are not sure, you should set up an isolated LAN. As the LAN connection presented at the PIDU Plus has a default configuration

Installation

as a hub/switch (and auto-sensing MDI/MDIX cross over is employed), connection can be made directly to the computer using a standard CAT 5 patch cable.

Before physical installation takes place the units to be installed should be set up as described in the **Section 8.3.4 "Install Pages"**. It is recommended that this procedure be carried out on the bench before physical installation commences. Providing it is safe to do so, the installer should take the process to the point where a radio link is established before proceeding to the installation site.



NOTE: It is possible that some units may not be accessed using the above default URL. This is because these units may have been previously configured with IP addresses 10.10.10.11 (Master) and 10.10.10.10 (Slave). Therefore, users must use the URL <http://10.10.10.10/> and/or URL <http://10.10.10.11/> to configure the units. Please ensure that a computer with web browsing capabilities is configured with an IP address of 10.10.10.n, where n is any value between 2 and 254 but excluding 10 and 11, to configure these units.

7.7.11 Aligning the PTP 500 Series Bridge ODUs

The following is a description of the steps taken to establish a radio link between the two units forming the bridge and align the units for the best signal strength.

The PTP 500 Series Bridge uses audible tones during installation to assist the installer with alignment. The installer should adjust the alignment of the ODU in both azimuth and elevation until highest pitch tone is achieved⁶. The tones and their meanings are as follows:

State Name	Tone Description	State Description	Pitch Indication (Higher pitch = higher power)
Free Channel Search	Regular beep	Executing band scan	N/A
Scanning	Slow broken tone	Not demodulating the wanted signal	Rx Power
Synchronized	Fast broken tone	Demodulating the wanted signal	Rx Power
Registered	Solid tone	Both Master and Slave units exchanging Radio layer MAC management messages	Rx Power

Table 11 Audio indications from the ODU

The term ‘wanted signal’ refers to that of the peer unit being installed.

In each of the states detailed above, the unit should be aligned to give the highest pitch tone. It should be noted that if, when in the Synchronized or Registered state, the tone varies wildly, you

⁶ The pitch of the alignment tone is proportional to the received power of the wireless signals. The best results are usually achieved by making small incremental movement in angular alignment.

Installation

may be suffering from interference or a fast fading link. Installing in this situation may not give a reliable link. The cause of the problem should be investigated.

For the ease of alignment, both Master and Slave units use the install tones in the same way but with some small behavioral differences. This allows the installer to install the Slave unit first and carry out the initial alignment with the Master unit if desired. However, due to the behavioral differences of Master and Slave units, it is recommended that the Master unit is installed first and the initial alignment carried out at the Slave unit.

Note also that there is a graphical installation screen (**Section 8.3.5 "Graphical Install"**) available using the web interface that displays the state of the link during the alignment process (up green, Down, red).

The following behavior should be noted:

- When first started up and from time to time, the Master unit will carry out a band scan to determine which channels are not in use. During this time, between 10 and 15 seconds, the Master unit will not transmit and as a consequence of this neither will the Slave unit. During this time the installation tone on the master unit will drop back to the band scan state, and the Slave unit will drop back to the Scanning state with the pitch of the tone set to the background noise level. Alignment of the unit should cease during this time.
- The master unit can take up to 60 seconds in 0-40km (0-25 miles) mode, 90 seconds in 0-130km (0-81 miles) mode and 120 seconds in 0-200km (0-124 miles) mode to determine the range of the link being installed⁷. The Master unit will remain in the Scanning state until the range of the link has been established. The Master unit will only move to the Synchronized state when the range of the link has been established.
- If, at the end of the ranging period, the Registered state is not achieved due to interference or other reasons, the Master unit will retry twice more on the same channel before moving to another available channel. Should this occur it might take a number of minutes to establish a link in the Registered state.
- The Slave unit does not have a ranging process. The slave unit will change to the Synchronized state as soon as the wanted signal is demodulated.

When the alignment process is complete the installer **MUST REMEMBER TO DISARM⁸BOTH UNITS** in the link as described in **Section 8.3.4 "Install Pages"**. This is necessary in order to:

- Turn off the audible alignment aid (**Section 8.3.4.4 "Disarm"**)
- Enable Adaptive Modulation
- Fully enable Advanced Spectrum Management with i-DFS
- Clear unwanted installation information from the various systems statistics
- Store the link range for fast link acquisition on link drop
- Enable higher data rates

⁷ If the unit is operating where mandatory radar avoidance algorithms are implemented the ranging behavior for the PTP 500 Series Bridge may be affected. The Master has to monitor the initially chosen channel for 60 seconds to make sure it is clear of radar signals before transmitting. If a radar is detected during any of the installation phases a further compulsory 60 seconds channel scan will take place as the master unit attempts to locate a new channel that is free of radar interference.

⁸ After 24 hours, the units will be disarmed automatically provided that they are armed and that the link is UP.

8 Web Page Reference

The web user interface has three main sections. The home page presents to the operator a high level summary of the PTP 500 Series Bridge point-to-point wireless link. The status page presents a more detailed set of system parameters describing the performance of the wireless link together with other key system performance metrics. The final section is the system administration section. This section is password protected and allows the system administrator to perform all the day-to-day administrative procedures, e.g. software upgrade and performing configuration changes.

The following subsections give a detailed usage guide for all the web user interfaces. The web pages are best viewed using a screen resolution of at least 1024 x 768 pixels on a PC using Microsoft Internet Explorer Version 6 or 7⁹.

The navigation bar on the left hand side of the web page is used to move between the various management pages. The currently selected page is always highlighted with a light blue background. The menu is hierarchical. Selecting a menu item which has associated submenu options will automatically display all sub options. A sample web page with the navigation menu is shown in **Figure 25** when the 'Home' Link is highlighted as the current page.



Figure 25 Menu Navigation Bar

⁹ The web pages have also been tested with Firefox 2.0.0.12. Other browsers may function correctly but have not been tested.

8.1 Home Page – PTP 500 Series Bridge

The home page for the PTP 500 Series Bridge has been designed to display a high level summary of the status of the wireless link and associated equipment. The home page (**Figure 26**) normally displays four key system attributes:

Wireless Link Status: The Wireless Link Status attribute displays the current status of the PTP 500 Series Bridge wireless link. A state of ‘Up’ on a green background indicates that a point-to-point link is established. A state of ‘Down’ on a red background indicates that the wireless link is not established. If the link is down for an unknown reason the system administrator should first consult the status web page for a more detailed summary of up to date system diagnostics.

Link Name: The link name attribute is a name and/or handle allocated by the system administrator to aid the identification of the unit, network or building.

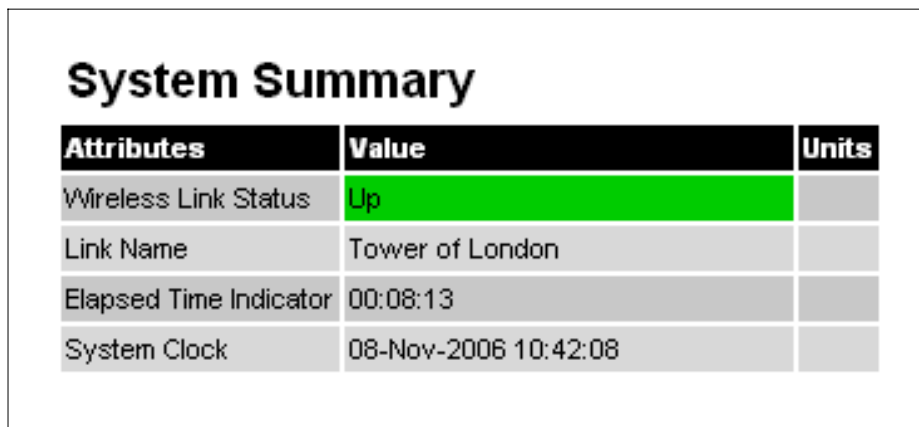

Attributes	Value	Units
Wireless Link Status	Up	
Link Name	Tower of London	
Elapsed Time Indicator	00:08:13	
System Clock	08-Nov-2006 10:42:08	

Figure 26 System Summary Page

Elapsed Time Indicator: The elapsed time indicator attribute presents the total time in days, hours, minutes and seconds since the last system restart. The system can restart for several reasons, e.g., commanded reboot from the system reboot webpage, or a power cycle of the equipment.

System Clock: If SNTP (Simple Network Time Protocol) is enabled, or the clock has been set, then a system clock attribute is displayed giving the date and time of the last page refresh.

Section 8.3.10.8 “SNTP (Simple Network Time Protocol) explains how to enable SNTP and **Section 8.3.10.9** explains how to set the clock.

8.1.1 Home Page Alarm Display

The home page is also used to display all outstanding major system alarms. Whenever system alarms are asserted, a yellow warning triangle is displayed on web page navigation bar. The warning triangle will be visible from all web pages. Clicking the warning triangle will cause the web page to jump back to the system homepage. **Figure 27** shows a sample alarm screen.

The screenshot shows a web interface for Motorola Point-to-Point Wireless Solutions. On the left is a navigation menu with a yellow warning triangle icon. The main content area is titled 'System Summary' and contains a table with the following data:

Attributes	Value	Units
Wireless Link Status	Up	
Link Name	Tower of London	
Elapsed Time Indicator	00:01:03	
System Clock	09-Nov-2006 17:46:31	
Install Arm State	Armed	

Figure 27 Alarm Warning Triangle

The following system alarms are defined:

Region Code: The region code prohibits the wireless unit from operating outside the regulated limits. An invalid region code indicates a corrupted license key. Note that a change of state may generate an SNMP trap and/or SMTP email alert.

Install Status: A non-OK value indicates that signaling was received with the wrong MAC address. Note that it is very unusual to detect this, because units with misconfigured Target MAC Address will normally fail to establish a wireless link. However, rare circumstances may establish a partial wireless link and detect this situation. NB: A non-OK value on start-up, or a change of value during operation, may generate an SNMP trap and/or SMTP email alert.

Install Arm State: This alarm warns when a wireless unit is in installation mode. After installation the wireless unit should be disarmed. This will increase the wireless link's data-carrying capacity and stop the installation tone generator. The wireless link is disarmed from the 'Installation Wizard' see [Section 8.3.4.4](#) "Disarm". Note that a change of state may generate an SNMP trap and/or SMTP email alert.

Unit Out Of Calibration: The unit is out of calibration and must be returned to the factory using the RMA process for re-calibration. Note that a change of state may generate an SNMP trap and/or SMTP email alert.

Incompatible Region Codes: The PTP 500 Series Bridge uses region codes to comply with local regulatory requirements governing the transmission of wireless signals in the 5.8, 5.4 GHz and 2.5 GHz bands. Region codes can only be changed by obtaining a new PTP 500. Note that a change of state may generate an SNMP trap and/or SMTP email alert.

Incompatible Master and Slave: A non-zero value indicates that the master and slave ends of the wireless link are different hardware products, or have different software versions. Note that it is very unusual to detect this because incompatible units will normally fail to establish a wireless link. However, some combinations may establish a partial wireless link and detect this situation. Note that a non-zero value may generate an SNMP trap and/or SMTP email alert.

Ethernet Configuration Mismatch Alarm: The detection of Ethernet fragments (runt packets) when the link is in full duplex is an indication of an auto-negotiation or forced configuration mismatch. Note that a change of state may generate an SNMP trap and/or SMTP email alert.

No Wireless Channel Available: Spectrum Management was unable to locate a suitable wireless channel to operate on. Note that a change of state may generate an SNMP trap and/or SMTP email alert.

SNTP Synchronization Failed: This warning indicates that SNTP has been enabled but that the unit is unable to synchronize with the specified SNTP server. [Section 8.3.10.8](#) “SNTP (Simple Network Time Protocol) explains how to configure SNTP. Note that a change of state may generate an SNMP trap and/or SMTP email alert.

Wireless Link Disable Warning: This warning is displayed if the Wireless link has been administratively disabled via the SNMP Interface (see [Section 8.3.10](#) “Remote Management Page”). The Wireless Interface MIB-II ifAdminStatus attribute has been set to DOWN. To enable the Ethernet interface, set the ifAdminStatus attribute to UP. Note that a change of state may generate an SNMP trap and/or SMTP email alert.

Ethernet Link Disable Warning: This warning is displayed if the Ethernet link has been administratively disabled via the SNMP Interface (see [Section 8.3.10](#) “Remote Management Page”). The Ethernet Interface MIB-II ifAdminStatus attribute has been set to DOWN. To enable the Ethernet interface, set the ifAdminStatus attribute to UP. Note that a change of state may generate an SNMP trap and/or SMTP email alert.

Ethernet Link Status: Current status of the Ethernet link. If there are any problems with the Ethernet interface, this alarm will be asserted. This alarm will most likely be seen if the unit has no Ethernet cable plugged into its Ethernet socket. Note that a change of state may generate an SNMP trap and/or SMTP email alert.

Fiber Link Status: If the fiber link is not OK, there are two possible causes: Either the fiber link has been installed but disabled (because the license key does not include fiber support), or the link could not be established even though an optical carrier was detected (due perhaps to a broken TX fiber, or the link is disabled at the fiber link partner). Note that a change of status may generate an SNMP trap and/or SMTP email alert.

TDD Synchronization Status: Current status of the TDD Synchronization (acquiring synchronization, no timing reference and timing system not connected). Note that a change of state may generate an SNMP trap and/or SMTP email alert.

8.2 Systems Status Page

The status page has been designed to give the system administrator a detailed view of the operation of the 500 Series Bridge from both the wireless and network perspectives.

Hardware Version: The hardware version attribute contains all the combined hardware version information. The attribute is formatted as DXX-RYY-Z where DXX contain the version of the digital card, RYY contains the version of the RF (radio frequency) card and Z describes the antenna type which can be I (integrated) or C (connectorized).

Region Code: The region code is used by the system to constrain the wireless to operate within regulatory regime of the particular country. The region code is encoded in the product license key. If the operator wishes to change region code, a new license key must be obtained from Motorola or the local point-to-point distributor / system integrator.

Elapsed Time Indicator: The elapsed time indicator attribute presents the total time in years, days, hours, minutes and seconds since the last system restart. The system can restart for several reasons, e.g. commanded reboot from the system reboot web page, or a power cycle of the equipment.

Ethernet Link Status: Current status of the Ethernet link. A state of 'Up' with a green background indicates that an Ethernet link is established. A state of 'Down' with a red background indicates that the Ethernet link is not established.

Ethernet Speed and Duplex: The negotiated speed and duplex setting of the Ethernet interface. The speed setting is specified in Mbps. Full Duplex data transmission means that data can be transmitted in both directions on a signal carrier at the same time. For example, on a local area network with a technology that has full duplex transmission; one workstation can be sending data on the line while another workstation is receiving data. Half Duplex data transmission means that data can be transmitted in both directions on a signal carrier, but not at the same time. For example, on a local area network using a technology that has half duplex transmission, one workstation can send data on the line and then immediately receive data on the line from the same direction in which data was just transmitted.

Remote IP Address: Hyperlink to the other side of the Link. The IP address of the peer link is displayed if the Link is UP, otherwise "unavailable" is displayed.

Refresh Page Period: The Status page refreshes automatically according to the setting entered here (in seconds). This attribute is only displayed when the user is logged on as System Administrator.

Wireless Link Status: As the attribute name suggests it displays the current status of the wireless link. A state of 'Up' on a green background indicates that a point-to-point link is established. A state of 'Down' on a red background indicates that the wireless link is not established.

Maximum Transmit Power: The maximum transmit power that the local wireless unit is permitted to use to sustain a link.

Remote Maximum Transmit Power: The maximum transmit power that the remote wireless unit is permitted to use to sustain a link.

Transmit Power: Transmit power histogram¹⁰ is expressed in dBm and presented as: max, mean, min, and latest. The max, min and latest are true instantaneous measurements; the mean is the mean of a set of one second means.

¹⁰ An histogram is calculated over a one hour period. If the equipment has been running for less than one hour then the histogram is calculated over the current elapsed time. The data used to compute the histogram statistics can be downloaded in an ASCII comma separated value (CSV) format via the diagnostics CSV Download page, see [Section 8.3.11.2](#) "Diagnostics Download".

Receive Power: Receive power histogram is expressed in dBm and presented as: max, mean, min, and latest. The max, min and latest are true instantaneous measurements; the mean is the mean of a set of one second means. See [footnote 10](#) “histograms”.

Vector Error: The vector error measurement compares the received signal’s In phase / Quadrature (IQ) modulation characteristics to an ideal signal to determine the composite error vector magnitude. The results are stored in an histogram and expressed in dB and presented as: max, mean, min and latest. The max, min and latest are true instantaneous measurements; the mean is the mean of a set of one second means. The expected range for Vector Error would be approximately -2dB (NLOS link operating at sensitivity limit on BPSK 0.67) to -33dB (short LOS link running 256 QAM 0.83). See [footnote 10](#) “histograms”.

Link Loss: The link loss is the total attenuation of the wireless signal between the two point-to-point units. See [footnote 10](#) “histograms”.

The link loss calculation presented below:

$$P_l = P_T - P_R + g_T + g_R \quad (4)$$

Where

P_l	= Link Loss	dB
P_T	= Transmit power of the remote wireless unit	dBm
P_R	= Received signal power at the local unit	dBm
g_t, g_r	= Antenna gain at the remote and local units respectively ¹¹	dBi

Equation - Link Loss

Transmit Data Rate: The data rate in the transmit direction, expressed in Mbps and presented as: max, mean, min, and latest in an histogram format. The max, min and latest are true instantaneous measurements; the mean is the mean of a set of one second means.

See [footnote 10](#) “histograms”. Expected data rates can be found in [Section 14](#) “Data Rate Calculations”.

Receive Data Rate: The data rate in the receive direction, expressed in Mbps and presented as: max, mean, min, and latest in an histogram format. The max, min and latest are true instantaneous measurements; the mean is the mean of a set of one second means.

See [footnote 10](#) “histograms”. Expected data rates can be found in [Section 14](#) “Data Rate Calculations”.

Link Capacity: The maximum aggregate data rate capacity available for user traffic, assuming the units have been connected using Gigabit Ethernet. The link capacity is variable and depends of the prevailing wireless conditions as well as the distance (range) between the two wireless units.

Transmit Modulation Mode: The modulation mode currently being used on the transmit channel. List of all the modulation modes can be found in [Section 14](#) where data rate calculations plots are given for each available modulation mode.

¹¹ The antenna gain of the 500 Series bridge (23.5 dBi) is used unless one or both of the units is a Connectorized version.

Receive Modulation Mode: The modulation mode currently being used on the receive channel. List of all the modulation modes can be found in [Section 14](#) where data rate calculations plots are given for each available modulation mode.

Receive Modulation Mode Detail: This supplies the user with information regarding the receive modulation mode in use. Possible values are:

- Running at maximum receive mode
- Running at user-configured Max Modulation Mode
- Restricted due to byte errors on the wireless link or local Ethernet Tx Fifo Drops
- Restricted because a DFS channel change is in progress
- Restricted due to telecoms acquisition mode
- Restricted due to the low Ethernet link speed
- Limited by the wireless conditions

Range: The range¹² between the 500 Series bridge ODUs.

8.3 System Administration Pages

The following menu options are available for the system administrator and can be password protected. [Figure 29](#) shows the system administration login page. By default a system administrator password is not set. Simply click the login button to access the system administration features.

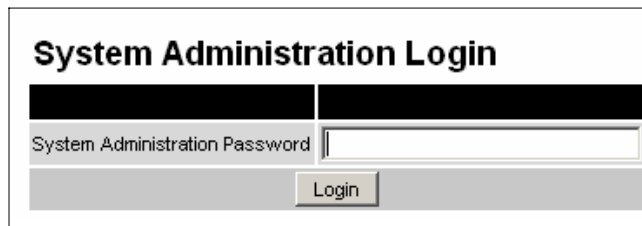

Figure 29 System Administration Login Page

Once the password has been set using the ‘Change Password’ menu item the system administration pages will only be available after the user has entered the correct password.

The features that are only available to the system administrator are:

- Configuration
- Statistics
- The Installation Wizard
- Software Upgrade

¹² The PTP 500 Series Bridge displays range in km by default, if the user would prefer to display range using Miles the ‘Distance Units’ attribute should be set to imperial, see the “Properties” web page [Section 8.3.14](#) “Properties”.

- Spectrum Management including DFS
- Remote management
- Diagnostics Plotter
- Password Management
- License Key Management
- Properties
- System Reboot

8.3.1 System Configuration

The configuration of the 500 Series Bridge is organized into three sections:

- General configuration
- LAN configuration
- Telecoms Configuration
- Save and Restore

The general configuration allows modification of high level administrative (descriptive) attributes and high level wireless configuration.

The LAN configuration sub menu allows the system administrator to modify the Ethernet and IP configuration of the 500 Series Bridge.

The telecoms submenu displays the current status of the telecoms interface and allows the configuration of interface loopbacks.

The save and restore submenu allows the system administrator to backup and restore the bridge configuration. It is recommended after a unit has been successfully installed; a copy of the active configuration is taken and archived by the system administrator.

8.3.1.1 General Configuration Page

The general configuration page (**Figure 30**) is used by the system administrator to configure the 500 Series Bridge's high level administrative (descriptive) attributes and high level wireless configuration.

System Configuration

This page controls the day to day configuration of the PTP wireless unit.

Equipment

Attributes	Value	Units
Link Name	<input type="text" value="Tower of London"/>	
Link Location	<input type="text" value="London, England"/>	
Master Slave Mode	Master	
Link Mode Optimization	IP Traffic	
Max Receive Modulation Mode	256QAM 0.81	
Ethernet Capped Max Wireless Speed	<input type="radio"/> Disabled <input checked="" type="radio"/> Enabled	
Max Transmit Power	<input type="text" value="25"/>	dBm

Figure 30 System Configuration Page

While the majority of the system configuration is entered during installation and should never require changing, this page offers the system administrator the ability to change the basic system parameters for both the wireless and Ethernet components.

Link Name: User defined identity for the unit (max 63 characters).

Link Location: Can be used as a generic scratch pad to describe the location of the equipment.

Master Slave Mode and Link Mode Optimization current settings are displayed and can be modified using the Installation Wizard pages. See [Section 8.3.4](#) “Install Pages”

Max Receive Modulation Mode: This is the maximum mode the unit will use as its adaptive modulation. By default the Max Receive Modulation Mode is the highest mode available.

For minimum error rates on TDM links the user should set the maximum modulation mode to 64QAM 0.75 at both ends of the link.

Ethernet Capped Max Wireless Speed: When enabled this option will cap the wireless speed to a mode that the connected Ethernet connection can sustain.

Maximum Transmit Power: This specifies the maximum transmit power in dBm of the system. It is country dependent and although the user can change this in 1dB steps, it will be limited to that country’s regulations¹³.

¹³ In the UK there is a legal requirement to provide a minimum of 19dB of transmit power control range. When the equipment is operating with a UK License Key, an additional facility is provided on the configuration page that allows the transmitted power to be reduced by 19dB compared to the maximum allowed with a simple single step control.

Why Reduce Transmit Power?

If the link losses are low and the link data rate and availability targets are being easily achieved, the transmitted power level may be reduced with a consequent benefit to other users of the band, e.g. fixed satellite links.

8.3.1.2 LAN Configuration Page

The LAN configuration page (**Figure 31**) is used by the system administrator to configure the 500 Series Bridge's LAN interface.

LAN Configuration

This page controls the LAN configuration of the PTP wireless unit.

Attributes	Value	Units
IP Address	<input type="text" value="10"/> . <input type="text" value="10"/> . <input type="text" value="10"/> . <input type="text" value="10"/>	
Subnet Mask	<input type="text" value="255"/> . <input type="text" value="255"/> . <input type="text" value="255"/> . <input type="text" value="0"/>	
Gateway IP Address	<input type="text" value="10"/> . <input type="text" value="10"/> . <input type="text" value="10"/> . <input type="text" value="111"/>	
VLAN High Priority Traffic Threshold	<input type="text" value="VLAN User Priority 1 and Above"/>	
Use VLAN For Management Interfaces	<input checked="" type="radio"/> Disabled <input type="radio"/> Enabled	
Ethernet Auto Negotiation	<input type="radio"/> Disabled <input checked="" type="radio"/> Enabled	
Auto Neg Advertisement	<input type="checkbox"/> Reserved	
	<input checked="" type="checkbox"/> 100 Mbps Full Duplex	
	<input checked="" type="checkbox"/> 100 Mbps Half Duplex	
	<input checked="" type="checkbox"/> 10 Mbps Full Duplex	
	<input checked="" type="checkbox"/> 10 Mbps Half Duplex	
Ethernet Auto Mdx	<input type="radio"/> Disabled <input checked="" type="radio"/> Enabled	
Drop Ethernet Link On Wireless Link Down	<input checked="" type="radio"/> Disabled <input type="radio"/> Enabled	

Figure 31 LAN Configuration Page

IP Address: Internet protocol (IP) address. This address is used by the family of Internet protocols to uniquely identify this unit on a network.

Subnet Mask: A subnet allows the flow of network traffic between hosts to be segregated based on a network configuration.

Gateway IP Address: The IP address of a computer / router on the current network that acts as a gateway.

VLAN High Priority Traffic Threshold: All packets with an 802.1P priority tag greater than or equal to the indicated value will be treated as a high priority packet for transmission over the wireless link.

Use VLAN For Management Interfaces: This controls whether the management interfaces (WWW/SNMP/SMTTP/SNTP) use 802.1Q VLAN tags or not. See [Section 8.3.1.3](#) “LAN Configuration Page - Use VLAN For Management Interface”.

Ethernet Auto Negotiation: This enables the Ethernet configuration to be forced rather than auto negotiated.



Caution:The configuration should only be forced if you are having problems with auto negotiation. You must ensure that you configure both this unit and the Ethernet port to which it is connected identically. If you force a fixed Ethernet Configuration on the 500 Series bridge then you **MUST** also force the same fixed configuration on the equipment to which it is connected. If you fail to force the configuration of the connected equipment, its automatic configuration mechanisms will normally cause a duplex mismatch, and you will receive greatly reduced throughput!

When Ethernet Auto Negotiation is Disabled the format of the LAN configuration page will change see [Section 8.3.1.4](#) “LAN Configuration Page – Manual Ethernet Configuration”.



Auto Neg Advertisement: This controls the rates that the auto negotiation mechanism will advertise as available. Warning: Over the air throughput will be capped to the rate of the Ethernet interface at the receiving end of the link.

Ethernet Auto Mdx: This enables/disables the Auto Medium Dependent Interface (MDI)/Medium Dependent Interface Crossover (MDIX) capability. Default is “Enabled”.

Drop Ethernet Link On Wireless Link Down: When this option is enabled the Ethernet link is momentarily dropped when the wireless link goes down. This feature is used to indicate to the connected network equipment that this Ethernet link is no longer available, thus causing STP (Spanning Tree Protocol) to re-route packets through an alternate link.

Local Packet Filtering: When Local Packet Filtering is “Enabled”, the bridge learns the source MAC addresses of devices transmitting Ethernet packets on the local Ethernet network, and only bridges packets to the remote unit if the destination MAC address has not been learned as a ‘local’ device. When Local Packet Filtering is ‘Disabled’ the bridge does not learn the source MAC addresses of devices transmitting Ethernet packets on the local Ethernet network, and bridges ALL Ethernet packets received to the remote unit. Local Packet Filtering should be disabled when external Ethernet switching hardware or a router is present. The default setting for Local Packet Filtering is disabled.

All of the above attributes are non-volatile, once set they will be used by the unit even after a power on reboot. A number of attributes, such as IP Address, Subnet Mask and Gateway IP Address and VLAN settings will require a reboot before they are used. If any of these attributes are changed a reboot screen appears asking the user to verify the reboot ([Figure 32](#) or [Figure 33](#)).



Figure 32 Configuration Reboot Page

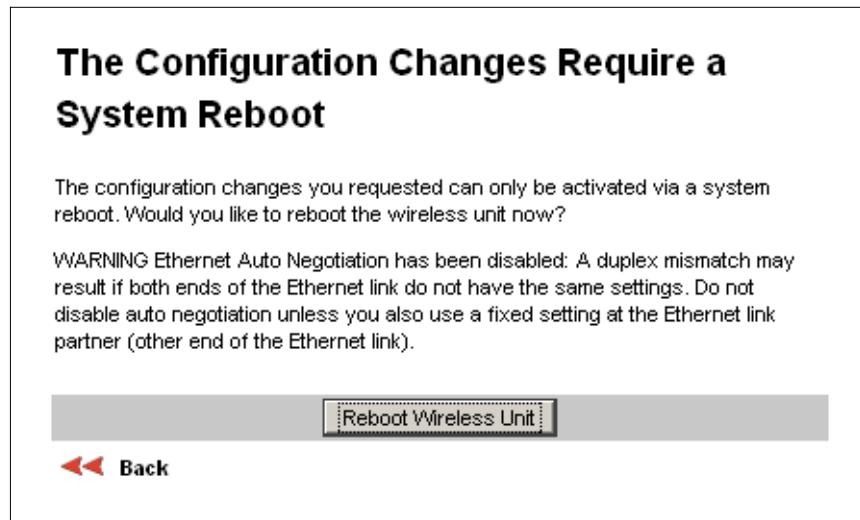

Figure 33 Configuration Reboot Page
– Ethernet Auto Negotiation Disabled

This will be followed by a pop-up dialogue box asking to confirm the action.

Note: At this point you will lose connection to the unit. If you have just changed the IP Address you now have to reconnect to the unit using the address just set.

8.3.1.3 LAN Configuration Page – Use VLAN For Management Interfaces

The layout of the LAN Configuration page changes if this attribute is enabled in order to allow the VLAN VID and VLAN Priority to be set, see **Figure 34**. The VLAN settings are applied only after the unit is rebooted.



Caution: You must ensure that you can access the VLAN which you configure here, otherwise you will be unable to access the unit following the next reboot.



Caution: The PTP 500 is only compatible with single VLAN tagged packets. Any packet with two or more tags will be ignored.

LAN Configuration					
This page controls the LAN configuration of the PTP wireless unit.					
Attributes	Value				Units
IP Address	10	10	10	10	
Subnet Mask	255	255	255	0	
Gateway IP Address	10	10	10	111	
VLAN High Priority Traffic Threshold	VLAN User Priority 1 and Above				
Use VLAN For Management Interfaces	<input type="radio"/> Disabled <input checked="" type="radio"/> Enabled				
VLAN Management VID	1				
VLAN Management Priority	0				
VLAN Management VID Validation	<input checked="" type="radio"/> Disabled <input type="radio"/> Enabled				
Ethernet Auto Negotiation	<input type="radio"/> Disabled <input checked="" type="radio"/> Enabled				
Auto Neg Advertisement	<input type="checkbox"/> Reserved				
	<input checked="" type="checkbox"/> 100 Mbps Full Duplex				
	<input checked="" type="checkbox"/> 100 Mbps Half Duplex				
	<input checked="" type="checkbox"/> 10 Mbps Full Duplex				
	<input checked="" type="checkbox"/> 10 Mbps Half Duplex				
Ethernet Auto MdiX	<input type="radio"/> Disabled <input checked="" type="radio"/> Enabled				
Drop Ethernet Link On Wireless Link Down	<input checked="" type="radio"/> Disabled <input type="radio"/> Enabled				
<input type="button" value="Submit Updated System Configuration"/> <input type="button" value="Reset Form"/>					

Figure 34 VLAN Configuration Fields

VLAN Management VID: This 802.1Q VLAN VID will be included in packets generated by the management interfaces. Valid settings are in the range 0 to 4094.

VLAN Management Priority: This 802.1Q VLAN Priority will be included in packets generated by the management interfaces. Valid settings are in the range 0 to 7.

VLAN Management VID Validation: If enabled, the management interfaces will only respond to Ethernet packets tagged with the configured 802.1Q VLAN Management VID; otherwise packets with any VID will be accepted.

8.3.1.4 LAN Configuration Page – Manual Ethernet Configuration

LAN Configuration

This page controls the LAN configuration of the PTP wireless unit.

Attributes	Value	Units
IP Address	10 . 10 . 10 . 10	
Subnet Mask	255 . 255 . 255 . 0	
Gateway IP Address	10 . 10 . 10 . 111	
VLAN High Priority Traffic Threshold	VLAN User Priority 1 and Above ▼	
Use VLAN For Management Interfaces	<input checked="" type="radio"/> Disabled <input type="radio"/> Enabled	
Ethernet Auto Negotiation	<input checked="" type="radio"/> Disabled <input type="radio"/> Enabled	
Forced Configuration	100 Mbps Copper Full Duplex ▼	
Ethernet Auto Mdx	<input type="radio"/> Disabled <input checked="" type="radio"/> Enabled	
Drop Ethernet Link On Wireless Link Down	<input checked="" type="radio"/> Disabled <input type="radio"/> Enabled	

Figure 35 LAN Configuration Page – Manual Ethernet Configuration

Force Configuration: This option allows the user to force the speed and duplex setting of the Ethernet interface.

Warning: Over the air throughput will be capped to the rate of the Ethernet interface at the receiving end of the link

8.3.1.5 Save and Restore Configuration File

The save and restore feature of a PTP 500 Series Bridge allows the system administrator to backup the operation configuration of the wireless unit. It is recommended that this facility is used immediately after a successful PTP 500 Series Bridge installation or prior to any software upgrade. In the unlikely event that a unit has to be replaced in the field, the replacement unit can be reconfigured by simply playing back the saved configuration file.

To save the configuration file click on the 'Save Configuration File' button (**Figure 36**) and save the configuration file (.cfg) to the hard drive of your computer^{14 15}.

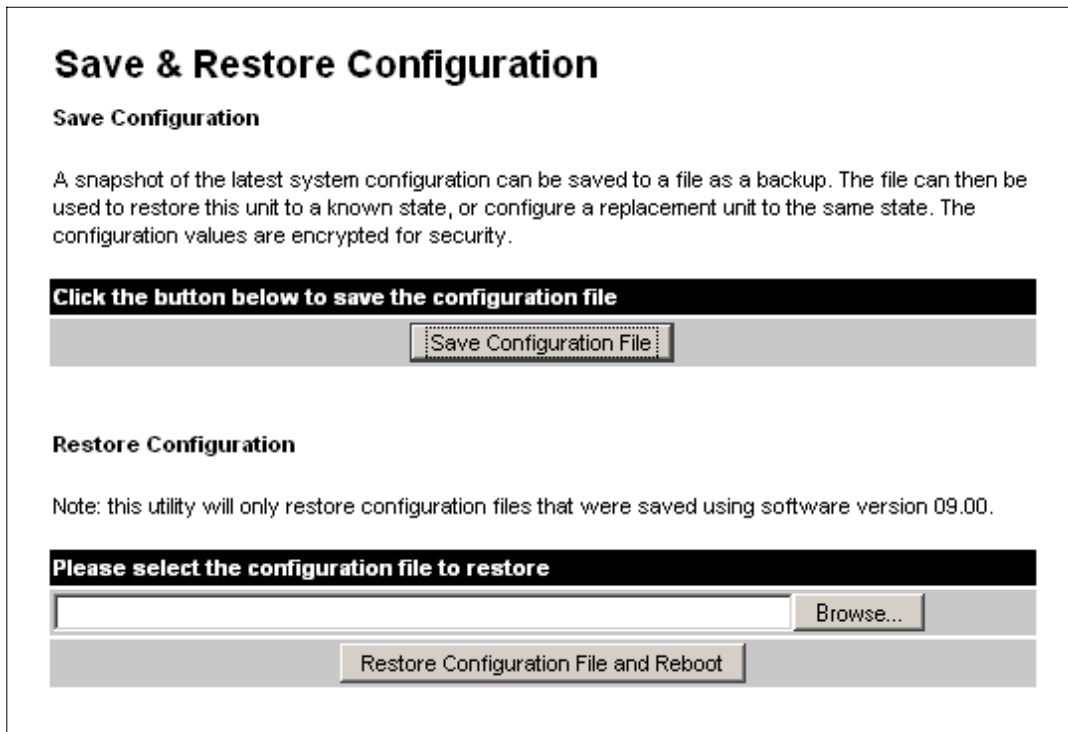

Figure 36 Save and Restore Configuration Page

¹⁴ There is a feature of Internet Explorer (all versions) that will always look at the content of any downloadable file as make an assessment whether to treat the file as an ASCII or binary file. Unfortunately the configuration file is always treated as ASCII and the browser attempts to display it instead of downloading it. Firefox (all versions) makes no such assumptions.

¹⁵ The configuration file format is MAC-mm-mm-mm_IP-iii-iii-iii-iii.cfg where mm and iii are the lower 3 bytes of the MAC address and the unit IP address respectively.

Save & Restore Configuration

Save Configuration

A snapshot of the latest system configuration can be saved to a file as a backup. The file can then be used to restore this unit to a known state, or configure a replacement unit to the same state. The configuration values are encrypted for security.

Click the button below to save the configuration file

Save Configuration File

Restore Configuration

Note: this utility will only restore configuration files that were saved using software version 999.00.

Please select the configuration file to restore

Restore Configura

File Download

Do you want to open or save this file?

 Name: MAC-80-0d-49_IP-1-1-100-2.cfg
Type: Microsoft Office Outlook Configuration File
From: 1.1.100.2

Open Save Cancel

 While files from the Internet can be useful, some files can potentially harm your computer. If you do not trust the source, do not open or save this file. [What's the risk?](#)

Figure 37 Save Configuration File Screen

The configuration file is encoded using an ASCII encoding scheme. An example is show in **Figure 38**.

Motorola PTP 600 Series Configuration file
#
MAC Address :- 00:04:56:80:0f:ff
IP Address :- 169.254.1.1
License Key :- DCBD-A7AA-6851-4679
Software Version :- 09-01
Creation Date :- 07-Mar-07 20:03:23
#
To playback this configuration file into the unit, use the Save and Restore configuration webpage:
#
<config>+.BP9)7HC;O)DS.UNPAGUTLIHJ:","\K,]"3F60*XR14+>) I3-MZ-VF
...
</config>

Figure 38 PTP 500 Example Configuration File



CAUTION: The configuration file is currently restricted to a single software version and can only be restored into a wireless unit operating the software version indicated in the configuration file header.

The configuration file can also be used when swapping out a faulty wireless unit. If one of the wireless units is replaced on a wireless link a configuration file captured from the faulty unit can be uploaded into the new unit to speed up replacement. It should be noted that when placing a configuration file into a wireless unit with a different MAC Address the license key will not be restored and may need to be entered. This can be obtained either from the Quick Start Guide supplied with the replacement wireless unit or directly from Motorola. Note that the target MAC address at the other end needs to be changed to ensure that it is using the MAC address of the replaced unit.

The restoration of configuration files can be performed using the Restore configuration tool. Using the browser button to locate the configuration file you wish to restore then click the ‘Restore Configuration File and Reboot’ button (**Figure 39**). The user will then be prompted to confirm the action (**Figure 40**)

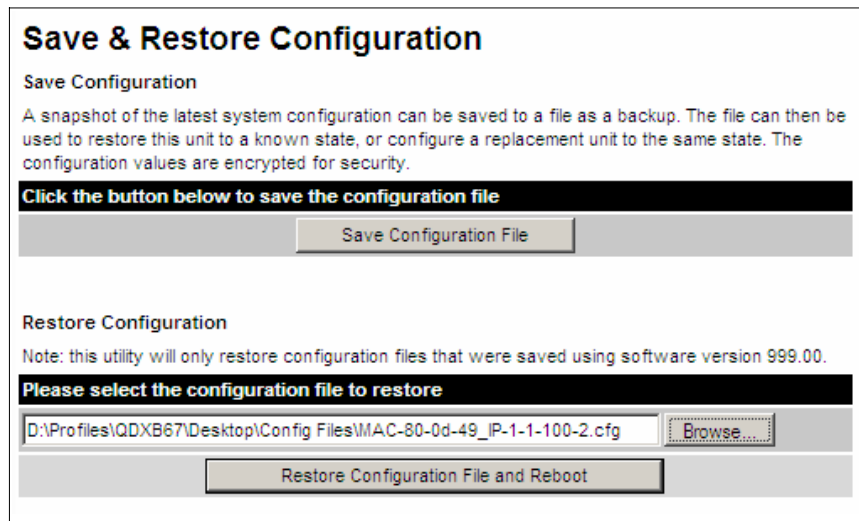

Figure 39 Restore Configuration File Pop Up Screen

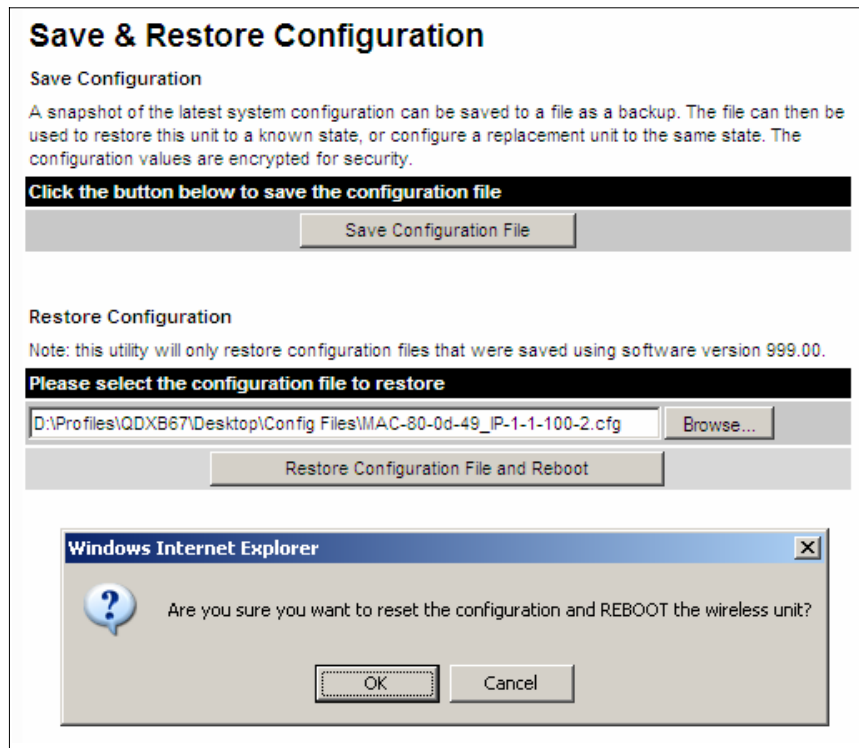

Figure 40 Reset Configuration and Reboot Confirmation Pop-up

Web Page Reference

On confirmation the PTP 500 Series Bridge will:

- Upload the configuration file
- Perform data integrity checking
- Erase previous configuration
- Apply the new configuration
- Restart

After the unit has restarted the entire configuration from the configuration file will now be active. Note: The IP address of the unit may have also been changed. The user can check the new IP address by reading the header of the configuration file, **Figure 38**.



CAUTION: A reboot is always required to restore a configuration file.

8.3.2 Statistics Page

The 500 Series bridge statistics page is designed to display some key statistics of the Ethernet Bridge and the underlying wireless performance.

System Statistics					
Attributes	Value				Units
Wireless Tx Packets	4,371 (+191)				
Wireless Rx Packets	0 (+0)				
Ethernet Tx Packets	2,403 (+104)				
Ethernet Rx Packets	1,991 (+87)				
Packets To Internal Stack	1,973 (+61)				
Packets From Internal Stack	2,407 (+77)				
Transmit Data Rate	52.52	51.12	0.00	52.52	Mbps
Receive Data Rate	2.02	1.97	0.00	2.02	Mbps
Aggregate Data Rate	54.54	53.10	0.00	54.54	Mbps
Link Capacity	78.26				Mbps
Transmit Modulation Mode	64QAM 0.83 (Dual) (15 MHz)				
Receive Modulation Mode	BPSK 0.50 (15 MHz)				
Receive Modulation Mode Detail	Restricted Because Installation Is Armed				
Signal Strength Ratio	0.3	-12.5	-16.5	-12.6	dB
Wireless Link Availability	0.0000				%
Byte Error Ratio	7.393e-8				
Code Word Error Ratio	1.070e-2				
Elapsed Time Indicator	00:18:13				
Statistics Page Refresh Period	<input type="text" value="3600"/>				Seconds
<input type="button" value="Submit Updated Values"/> <input type="button" value="Reset Form"/>					
<input type="button" value="Reset system counters"/>					
<input type="button" value="Reset system histograms"/>					

Figure 41 System Statistics

Wireless Tx Packets: This displays the total number of good packets the bridge has sent for transmission by the wireless interface¹⁶.

Wireless Rx Packets: This displays the total number of good packets the bridge has received from the wireless interface. See **footnote 16** “number of packets”.

¹⁶ The number in between brackets displays the number of packets received since the last page refresh.

Ethernet Tx Packets: This displays the total number of good packets the bridge has sent for transmission by the local Ethernet interface. . See [footnote 16](#) “number of packets”.

Ethernet Rx Packets: This displays the total number of good packets the bridge has received from the local Ethernet interface. . See note See [footnote 16](#) “number of packets”.

Packets To Internal Stack: This displays the total number of good packets the bridge has transmitted to the internal stack (e.g., ARP requests, PING requests, HTTP requests). See [footnote 16](#) “number of packets”.

Packets From Internal Stack: This displays the total number of good packets the bridge has received from the internal stack (e.g. ARP responses, PING replies, HTTP responses). See [footnote 16](#) “number of packets”.

Transmit Data Rate: The data rate in the transmit direction, expressed in Mbps and presented as: max, mean, min, and latest in an histogram format. The max, min and latest are true instantaneous measurements; the mean is the mean of a set of one second means. See [footnote 10](#) “histograms”. Expected data rates can be found in [Section 14](#) “Data Rate Calculations”.

Receive Data Rate: The data rate in the receive direction, expressed in Mbps and presented as: max, mean, min, and latest in an histogram format. The max, min and latest are true instantaneous measurements; the mean is the mean of a set of one second means. . See [footnote 10](#) “histograms”. Expected data rates can be found in [Section 14](#) “Data Rate Calculations”.

Aggregate Data Rate: The sum of the data rate in the directions expressed in Mbps and presented as: max, mean, min, and latest in an histogram format. The max, min and latest are true instantaneous measurements; the mean is the mean of a set of one second means. See Note 15. Expected data rates can be found in [Section 14](#) “Data Rate Calculations”.

Link Capacity: The maximum aggregate data capacity available for user traffic under the current radio link conditions, assuming the units have been connected using Gigabit Ethernet. The sum of the displayed Transmit and Receive data rates may be lower than this figure if the link isn’t fully loaded by the current traffic profile.

Transmit Modulation Mode: The modulation mode currently being used on the transmit channel. The number in brackets after the modulation mode and coding rate string is the effective data rate available to all MAC layer protocols. List of all the modulation modes can be found in [Section 14](#) “Data Rate Calculations” where data rate calculations plots are given for each available modulation mode.

Receive Modulation Mode: The modulation mode currently being used on the receive channel. The number in brackets after the modulation mode and coding rate string is the effective data rate available to all MAC layer protocols. List of all the modulation modes can be found in [Section 14](#) “Data Rate Calculations” where data rate calculations plots are given for each available modulation mode.

Receive Modulation Mode Detail: This supplies the user with information regarding the receive modulation mode in use. Possible values are:

- Running at maximum receive mode
- Running at user-configured Target Modulation Mode

Web Page Reference

- Restricted because Installation is armed
- Restricted because of byte errors on the wireless link
- Restricted because a DFS channel change is in progress
- Restricted due to the low Ethernet link speed
- Limited by the radio conditions

Signal Strength Ratio: The Signal Strength Ratio is the ratio of the power received by the Vertical / Horizontal receivers and presented as: max, mean, min, and latest in an histogram format. The max, min and latest are true instantaneous measurements; the mean is the mean of a set of one second means. See **footnote 10** “histograms”.

Wireless Link Availability: Expresses the link availability as a percentage of time since the first successful registration after a system restart, expressed as a percentage to four decimal places.

Byte Error Ratio: The ratio of detected Byte errors to the total number of bytes since the last system reboot. This is a true measure of link quality as this measurement is made continually using null frames when there is no user data to transport.

Code Word Error Ratio: The ratio of uncorrected Codeword errors to the total number of Codewords, calculated since the last reset of the system counters.

Statistics Page Refresh Period: The statistics page refreshes automatically according to the setting entered here (in seconds).

Reset System Counters: By pressing this button all counters in the system are reset to zero.

Reset System Histograms: All histograms are reset, and the calculation period is restarted.

8.3.3 Detailed Counters Page

Ethernet			Wireless		
Attributes	Value	Units	Attributes	Value	Units
Ethernet Rx Octets	242,240 (+10,389)		Wireless Rx Octets	0 (+0)	
Ethernet Tx Octets	2,228,240 (+100,611)		Wireless Tx Octets	2,468,252 (+111,000)	
Ethernet Rx Drops	0 (+0)		Wireless Rx Drops	0 (+0)	
Ethernet Rx Packets	2,121 (+92)		Wireless Rx Packets	0 (+0)	
Ethernet Rx Broadcasts	14 (+0)				
Ethernet Rx Multicasts	12 (+0)				
Ethernet Rx Crc And Align	0 (+0)		Wireless Rx Crc And Align	0 (+0)	
Ethernet Rx Undersize	0 (+0)		Wireless Rx Undersize	0 (+0)	
Ethernet Rx Oversize	0 (+0)		Wireless Rx Oversize	0 (+0)	
Ethernet Rx Fragments	0 (+0)				
Ethernet Rx Jabbers	0 (+0)				
Ethernet Tx Drops	1 (+0)		Wireless Tx Drops	21 (+0)	
Ethernet Tx Packets	2,578 (+124)		Wireless Tx Packets	4,683 (+223)	
Ethernet Tx Broadcasts	1 (+0)				
Ethernet Tx Multicasts	2 (+0)				
Ethernet Tx Collisions	0 (+0)				
Ethernet Tx Fifo Drops	0 (+0)				
Ethernet Rx High Priority Frames	0 (+0)		Wireless Rx High Priority Frames	0 (+0)	
Ethernet Rx Low Priority Frames	2,128 (+99)		Wireless Rx Low Priority Frames	0 (+0)	
Ethernet Tx High Priority Frames	0 (+0)		Wireless Tx High Priority Frames	0 (+0)	
Ethernet Tx Low Priority Frames	2,576 (+124)		Wireless Tx Low Priority Frames	4,683 (+146)	
Ethernet Rx Pause Frames	0 (+0)				
Ethernet Tx Pause Frames	2 (+0)				
Detailed Counters Page Refresh Period	<input type="text" value="3600"/>	Seconds	<input type="button" value="Update Page Refresh Period"/>	<input type="button" value="Reset System Counters"/>	

Figure 42 Detailed Counters Page

The detailed counters page is subdivided into two columns. Column one presents the detailed statistics for the bridge's Ethernet interface. Column two relates to the wireless interface.

The Counters have the following definitions:

Tx & Rx Octets: Total number of octets (bytes) transmitted or received over the interface.

Rx Drops: Frames dropped due to lack of receive buffer. This includes packets dropped when the wireless link cannot transmit packets as quickly as they are being received at the Ethernet interface.

Rx Packets: Total number of packets received by the interface. This includes both good and bad packets.

Rx Broadcasts: Total number of good broadcast packets.

Rx Multicasts: Total number of good multicast packets.

Rx CRC and Align: Total number of packets with CRC or frame alignment errors.

Rx Undersize: Total number of packets received that are less than 64 bytes and have a valid CRC.

Rx Oversize: Total number of packets received that are greater than the maximum number of bytes with a valid CRC.

Rx Fragments: Total number of packets that are less than 64 bytes with an invalid CRC (these packet types are also known as runts).

Rx Jabbers: Total number of packets received that are greater than the maximum number of bytes with an invalid CRC.

Tx Drops: Total number of frames dropped due excessive collisions, late collision and frame ageing.

Tx Packets: Total number of packets received by the interface. This includes both good and bad packets.

Tx Broadcasts: Total number of good broadcast packets.

Tx Multicasts: Total number of good multicast packets.

Tx Collisions: Total number frames experiencing collisions.

Tx FIFO Drops: Total number frames dropped due to lack of capacity in the transmit buffer, for example when the 500 Series bridge is connected to the local Ethernet at a connection speed of less than 1 Gbps.

Rx & Tx High Priority: Total number of received or transmitted frames marked as high priority.

Rx & Tx Low Priority: Total number of received or transmitted frames marked as low priority.

Rx & Tx Pause Frames: Total number of received or transmitted pause frames.

Statistics Page Refresh Period: The statistics page refreshes automatically according to the setting entered here (in seconds).

8.3.4 Install Pages

These pages are used during system installation. There follows a description of the install pages along with their use during the installation configuration process. The actual installation process is described in **Section 8.3.4.1** “Manually Configuring the Wireless Units”.

All wireless links are shipped as paired units. They are pre-configured at the factory so that they can be installed without the user supplying any configuration. Each wireless link is shipped with a quick start guide. Attached to the quick start guide is a summary of the pre-configured configuration data. **Table 12** shows a sample link configuration. The values highlighted have been committed to the wireless unit’s non-volatile storage.

Example PTP 500 Series Configuration Data	
For your convenience these two units have been pre-configured as a link Units	
<u>Units:</u>	
ODU serial number	ODU serial number
016710000A0	01671000096
Ethernet MAC address	Ethernet MAC address
00:04:56:10:00:96	00:04:56:10:00:A0
<u>Configured as:</u>	
Master	Slave
Target MAC address	Target MAC address
00:04:56:10:00:A0	00:04:56:10:00:96
License key	License Key
0557-D8B0-47A1-B0DD	534F-4F54-D1B0-E2DA
IP Address	IP Address
169.254.1.2	169.254.1.1

Table 12 500 Series Bridge
Factory Configuration Values



The factory default configuration is limited in range to 40 Km (25 miles). If you wish to install a wireless link with a range of > 40 Km (> 25 miles) and < 200 Km (< 124 miles) or < 5 Km (< 3 miles) you must follow the steps in **Section 8.3.4.1** “Manually Configuring The Wireless Units”.



The factory default configuration is set to Region 26. Region 26 allows the 500 Series bridge a maximum transmit power of 25 dBm. If the local regulatory regime limits the maximum transmit power (EIRP) to less than 25 dBm you should obtain a new license key containing the correct region code from your local distributor or direct from Motorola. Alternatively in the short term, you should reduce the maximum transmit power by following the procedures in **Section 8.3.4.1** “Manually Configuring The Wireless Units”.

8.3.4.1 Manually Configuring The Wireless Units

If the installer / system administrator wishes, they may modify the default installation configuration. If only the IP addresses (network configuration) are incorrect it is recommended that the values are changed via the configuration menu (**Section 8.3.1.2** “LAN Configuration Page”). If

any other parameters require modification then it is recommended that the system administrator use the Installation Wizard.

A detailed description of the Installation Wizard follows: The 500 Series bridge operational software requires a license key to enable the wireless bridging capability and programs region code specific parameters in to the unit.

Software License Key

A valid software license key is required before installation of the PTP (Point to Point) wireless link can commence. If you do not have a valid license key please contact your distributor.

License key data entry

Attributes	Value	Units
License Key	<input type="text" value="0557-D8B0-47A1-B0DD"/>	

Capability summary

Attributes	Value	Units
Product Name	Motorola PTP 58500 Full	
MAC Address	00:04:56:10:00:96	
Region Code	Region Code 1	
Frequency Variant	5800 MHz	
Bandwidth Variant	15 MHz	

Figure 43 License Key Data Entry

A license key is programmed into each unit during production and can be found written on the Configuration Data Summary Label which is attached to the Quick Install Guide. If subsequently the license key has been mislaid, replacement keys can be applied for online or via your distributor.

If a valid license key is not detected in the unit’s non-volatile memory then the user is prompted to enter a valid key. It should be noted that 500 Series bridge units are shipped as link pairs and, as such, valid license keys are entered during the production process. To enter a license key simply type or paste the license key into the data entry box (**Figure 43**) and click the ‘validate license key’ button.

8.3.4.2 Internet Protocol Configuration

Step 1 of the installation wizard requires the installer to enter the Internet Protocol (IP) configuration.

Step 1: Interface Configuration Problem loading page

Please complete the wizard in order to arm the unit.

A valid IP address and subnet mask is required before the PTP unit can be used on a network. Please see your network administrator if you are unsure of the correct values to enter here.

Interface configuration data entry

Attributes	Value	Units
IP Address	<input style="width: 30px;" type="text" value="10"/> <input style="width: 30px;" type="text" value="10"/> <input style="width: 30px;" type="text" value="10"/> <input style="width: 30px;" type="text" value="10"/>	
Subnet Mask	<input style="width: 30px;" type="text" value="255"/> <input style="width: 30px;" type="text" value="255"/> <input style="width: 30px;" type="text" value="255"/> <input style="width: 30px;" type="text" value="0"/>	
Gateway IP Address	<input style="width: 30px;" type="text" value="10"/> <input style="width: 30px;" type="text" value="10"/> <input style="width: 30px;" type="text" value="10"/> <input style="width: 30px;" type="text" value="111"/>	
Use VLAN For Management Interfaces	<input checked="" type="radio"/> Disabled <input type="radio"/> Enabled	

Figure 44 Installation Wizard Internet Protocol Configuration

IP Address:Internet protocol (IP) address. This address is used by the family of Internet protocols to uniquely identify this unit on a network.

Subnet Mask:A subnet allows the flow of network traffic between hosts to be segregated based on a network configuration. By organizing hosts into logical groups, subnetting can improve network security and performance. **Gateway IP Address:** The IP address of a computer / router on the current network that acts as a gateway. A gateway acts as an entrance / exit to packets from / to other networks.

Use VLAN Management Interface:Controls whether the management interfaces (HTTP/SNMP /SMTP/SNTP) use a VLAN. Selecting this option presents the user with extra fields in which to enter the Management VLAN ID, Priority and whether to validate the VLAN ID. If the user modifies this control, a warning dialog is displayed see **Figure 45**.

Telecoms Interface This allows the activation of the 500 Series bridge telecoms interface. If the selection options are disabled, T1 or E1 note mixed T1/E1 configurations are not permitted.

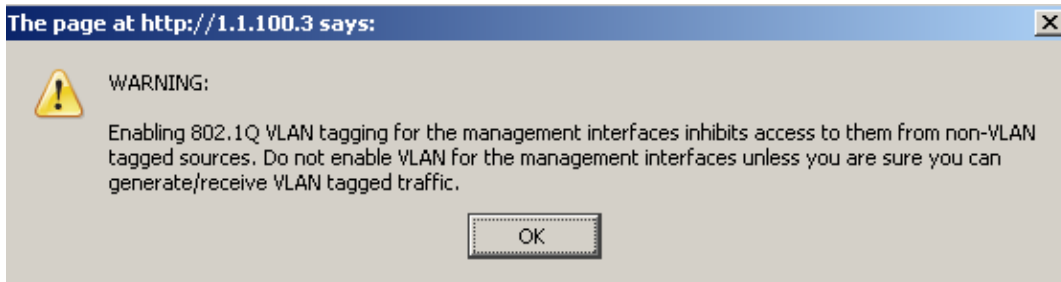

Figure 45 VLAN Warning

Once complete, click the ‘Submit Internet Protocol Configuration’ button or the ‘Next’ link.

8.3.4.3 Wireless Configuration

Step 2 of the installation wizard requires the installer to enter the wireless configuration parameters.

Step 2: Wireless Configuration

Please enter the following wireless configuration parameters

Wireless data entry

Attributes	Value	Units
Target MAC Address	00:04:58: <input type="text" value="10"/> : <input type="text" value="00"/> : <input type="text" value="a0"/>	
Master Slave Mode	<input checked="" type="radio"/> Master <input type="radio"/> Slave	
Link Mode Optimization	<input checked="" type="radio"/> IP Traffic <input type="radio"/> TDM Traffic	
Tx Max Power	<input type="text" value="5"/>	dBm
Platform Variant	<input checked="" type="radio"/> Integrated Antenna <input type="radio"/> Connectorized	
Channel Bandwidth	<input checked="" type="radio"/> 15 MHz	
Spectrum Management Control	<input checked="" type="radio"/> i_DFS <input type="radio"/> Fixed Frequency	
Lower Center Frequency	<input type="text" value="5735"/>	MHz
Installation Tones	<input checked="" type="radio"/> Disabled <input type="radio"/> Enabled	

◀ Back
Next ▶▶

Figure 46 5.8 GHz and 5.4 GHz Variants - Installation Wizard Wireless Configuration

Target MAC Address:It is the MAC Address of the peer unit that will be at the other end of the wireless link. This is used by the system to ensure the unit establishes a wireless link to the correct peer.

The MAC Address can be found embedded within the serial number of the unit. The last six characters of the serial number are the last three bytes of the unit's MAC address. (Note: A PTP 500 Series system is shipped as a pair of units with pre-loaded correct MAC addresses. Target MAC addresses will only need to be entered if an existing unit has to be replaced in the field or the units configuration has been erased).

Master Slave Mode:At this point it is necessary to decide which end will designate a Master.

The Master unit is the controlling unit with respect to the point-to-point link and its maintenance. The master transmits until the link is made, while the Slave listens for its peer and only transmits when the peer has been identified.

Link Mode Optimization:Optimizes the link behavior according to the type of traffic that will be bridged. There are two modes to choose from: IP and TDM.

In IP Mode, the PTP 500 product runs an Adaptive TDD scheme. Basically an unloaded link runs 10:10 mode (10 OFDM bursts alternately in each direction). A sustained traffic load in one direction for example may cause a threshold to be reached where the TDD mode automatically adapts to say 20:10. If the load continues to increase, then the TDD structure may adapt even further through 30:10 to 40:10. This is a state of maximum link asymmetry (40 OFDM bursts in one direction compared with 10 in the other). If the load increases in BOTH directions, then the TDD structure can adapt from 10:10, through 20:20, 30:30 and finally 40:40. This is a state of maximum aggregate throughput. So if three out of these combinations are considered; 10:10, 40:10 and 40:40 they would give the following characteristics:

10:10: equal performance in each direction, lowest aggregate throughput and lowest Latency.

40:10: achieves maximum one way throughput performance, to the detriment of both latency and throughput in the opposite direction.

40:40: Maximum link aggregate rate, balanced performance in each direction, higher latency.

Note that there is an engineering trade-off between the flexibility of ATDD and Latency as follows: When the TDD structure changes, there will be a short term impact on Latency for a few Frames. This would not affect the steady state long term average latency, but could be recorded as a Maximum latency. This affect may be amplified for short Latency tests or if the traffic loading is oscillating either side of a boundary condition. As the TDD burst length increases, Traffic in each direction will have to wait longer before a Transmit window is available, but more data can be sent during the burst. There is an impact on latency but it varies depending upon installation range, Frame size and modulation mode.

In TDM mode, two major differences in link behaviour occur compared with IP mode. First the TDD structure is fixed symmetrically. Either 10:10, 20:20, 30:30 or 40:40 based upon the installed range.

Secondly, the point at which a modulation mode changes for given RF conditions is more conservative. In practice, this means that the link will typically stay in a lower modulation mode, but with increased tolerance to RF variability.

Depending upon the link characteristic that the customer requires, this may very well be the best choice. It increases consistency of link performance and equality in each direction as a trade-off against maximum throughput.

Tx Max Power:This attribute controls the maximum transmit power the unit is permitted to use when installing and executing the wireless link. The maximum setting for a particular region or country is controlled by the License Key.

Platform Variant:Chooses between an integrated unit or a connectorized unit that requires an external antenna.

Channel Bandwidth:Users can choose a variable channel bandwidth for the available spectrum. Value is 15 MHz.

Spectrum Management Control:Is used to configure the PTP 500 Series Bridge's Spectrum Management features, see [Section 8.3.7](#) "Spectrum Management" for more details. i-DFS is the abbreviation for intelligent Dynamic Frequency Selection. This feature continually monitors the spectrum looking for the channel with the lowest level of on channel and co-channel interference. Fixed frequency mode allows the installer to fix transmit and receive frequencies on the units. The frequencies may be configured symmetrically or asymmetrically.

Lower Center Frequency:The software for the PTP 500 Series Bridge allows a user to optionally adjust the channel center frequencies. Changing the Lower Center Frequency attribute causes all channel center frequencies to be offset. It effectively slides the channelization up or down. See [Sections Section 5.5](#) "5.4 GHz Specific Frequency Planning Considerations" and [Section 5.6](#) "5.8 GHz Specific Frequency Planning Considerations" depending on the frequency variant.



Warning: The lower center frequency attribute must be configured to the same value for both the master and slave. Failure to do so will cause the wireless link to fail reestablishment. The only way to recover from this situation is to modify the Lower Center Frequency attribute so that they are identical on both the master and slave unit.

Fixed Transmit Frequency, Fixed Receive Frequency:The software for the PTP 500 Series Bridge allows a user to optionally fix the Transmit and the Receive frequencies for a wireless link. The settings must be compatible at each end of the link. Once configured the spectrum management software will not attempt to move the wireless link to a channel with lower co or adjacent channel interference. Therefore this mode of operation is only recommended for deployments where the installer has a good understanding of the prevailing interference environment. [Figure 47](#) shows a sample fixed frequency configuration for a 30 MHz channel bandwidth. In the example the lower center frequency is set to its default values and the Fixed Transmit Frequency is set to 5735 MHz and the Fixed Receive Frequency is set to 5735 MHz. Care must be taken when configuring the Fixed Transmit and Receive Frequencies to ensure that both frequencies are on the same 5 MHz channel raster as the Lower Center Frequency. For example both the Fixed Transmit and Receive Frequencies must be a multiple of 5 MHz from the Lower Center Frequency ($5740 = 5735 + 5 \text{ MHz}$) and ($5745 = 5735 + 5 \text{ MHz} \times 2$). Please note that there is a raster that limits the selection of the Rx frequency based upon the setting of the Tx frequency, and that the list of options presented in the fixed Tx frequency box is limited to that raster.

Step 2: Wireless Configuration

Please enter the following wireless configuration parameters

Wireless data entry

Attributes	Value	Units
Target MAC Address	00:04:56: <input type="text" value="10"/> : <input type="text" value="00"/> : <input type="text" value="a0"/>	
Master Slave Mode	<input checked="" type="radio"/> Master <input type="radio"/> Slave	
Link Mode Optimization	<input checked="" type="radio"/> IP Traffic <input type="radio"/> TDM Traffic	
Tx Max Power	<input type="text" value="5"/>	dBm
Platform Variant	<input checked="" type="radio"/> Integrated Antenna <input type="radio"/> Connectorized	
Channel Bandwidth	<input checked="" type="radio"/> 15 MHz	
Spectrum Management Control	<input type="radio"/> I_DFS <input checked="" type="radio"/> Fixed Frequency	
Default Raster	<input checked="" type="radio"/> On <input type="radio"/> Off	
Fixed Tx Frequency	<input type="text" value="5735"/>	MHz
Fixed Rx Frequency	<input type="text" value="5735"/>	MHz
Installation Tones	<input checked="" type="radio"/> Disabled <input type="radio"/> Enabled	

◀◀ **Back**
Next ▶▶

Figure 47 5.8 GHz and 5.4 GHz Variants - Fixed Frequency Operation

Installation Tones: Where the use of audio installation tones is not required this control allows the installer to optionally disable the tone generator during the installation process. Once the installer is satisfied with the wireless configuration options then the “Submit Wireless Configuration” button or the “Next” link should be clicked.

Step 3: Confirm Installation Configuration

Please review your entered configuration. If any of the configuration items are incorrect please use the back button to apply the corrections.

Once you're happy with the configuration press the 'Confirm Configuration, Arm Installation Agent and Reboot' button, this will commit the parameters to non-volatile memory and reboot this wireless unit.

Installation configuration

Attributes	Value	Units
IP Address	10.10.10.10	
Subnet Mask	255.255.255.0	
Gateway IP Address	10.10.10.111	
Use VLAN For Management Interfaces	Disabled	
Target MAC Address	00:04:58:10:00:a0	
Master Slave Mode	Master	
Link Mode Optimization	IP Traffic	
Tx Max Power	5	dBm
Platform Variant	Integrated Antenna	
Channel Bandwidth	15 MHz	
Spectrum Management Control	i_DFS	
Lower Center Frequency	5735	MHz
Installation Tones	Disabled	

Confirm Configuration, Arm Installation Agent and Reboot

◀◀ Back

Figure 48 5.8 GHz and 5.4 GHz Variants - Installation Wizard Confirm Configuration

If the settings are correct and appropriate, click the “Confirm Configuration, Arm Installation and Reboot” button. The user will now be prompted to confirm the action (**Figure 49**).

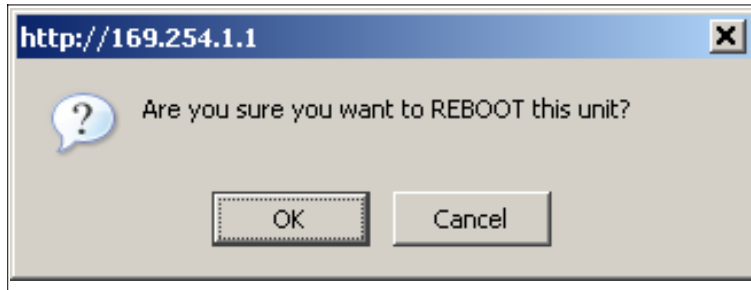

Figure 49 Reboot Confirmation Pop Up

All the attributes are committed to non-volatile memory. Immediately following the write to non-volatile memory the unit is reset. Note: If you have changed the Ethernet parameters you must reconnect using the correct network and address settings.

8.3.4.4 Disarm

Step 5 of the installation wizard is the disarm phase.

Disarm Installation

The installation agent is armed. If you wish to disarm installation then use the 'Disarm Installation Agent' button. If you wish to reconfigure the installation agent then use the wizards 'back' button

Installation configuration

Attributes	Value	Units
IP Address	10.10.10.10	
Subnet Mask	255.255.255.0	
Gateway IP Address	10.10.10.111	
Use VLAN For Management Interfaces	Disabled	
Target MAC Address	00:04:56:10:00:a0	
Master Slave Mode	Master	
Link Mode Optimization	IP Traffic	
Tx Max Power	5	dBm
Platform Variant	Integrated Antenna	
Channel Bandwidth	15 MHz	
Spectrum Management Control	i_DFS	
Lower Center Frequency	5735	MHz
Installation Tones	Disabled	

<< **Back**

Figure 50 5.8 GHz and 5.4 GHz Variant - Disarm Installation

Once **Section 8.3.4.3** “Wireless Configuration” is complete pressing the “Disarm Installation Agent” button completes the installation process¹⁷ and the audible installation tone will be switched off. If the installer wishes to modify the installation configuration then the ‘Back’ link can be used to access the installation wizard steps described above.

After disarming the wireless link the user is presented with one of two possible configuration pages, see **Figure 52** and **Figure 51**. The screen presents hyperlinks to the main configuration and spectrum management pages.

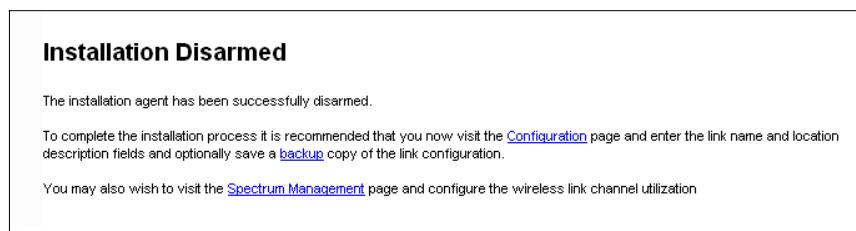

Figure 51 Optional Post Disarm Configuration 2

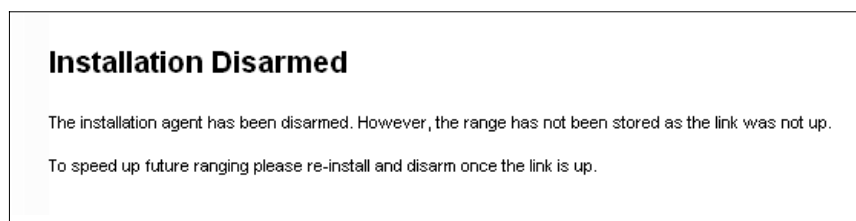

Figure 52 Optional Post Disarm Configuration 1

After installation the system administrator may wish to modify the wireless units descriptive configuration (link name and link location). In addition the system administrator may wish to change the spectrum management configuration of the wireless unit, or look at the analysis of the 5.8 GHz spectrum to see if the automatic channel selection is appropriate for the system administrator’s network. It is also recommended that a backup copy of the wireless units configuration is taken. Hyperlinks are provided on the post disarm page for ease of use.

¹⁷ The installation process is completed when both ends of the link are ‘disarmed’.

8.3.5 Graphical Install

To aid the installation of wireless links two graphical installation aids have been introduced in this 500 Series system version.

- A PDA installation screen
- A larger installation screen available from the main HTTP management interface.

The design of the installation screen has been deliberately kept simple and uncluttered. An example of the installation screen is shown in **Figure 53**. Both the PDA and the large format installation screen have the same content and only differ in size. The PDA installation screen is 232 by 220 pixels to be compatible with the typical size of a PDA screen.

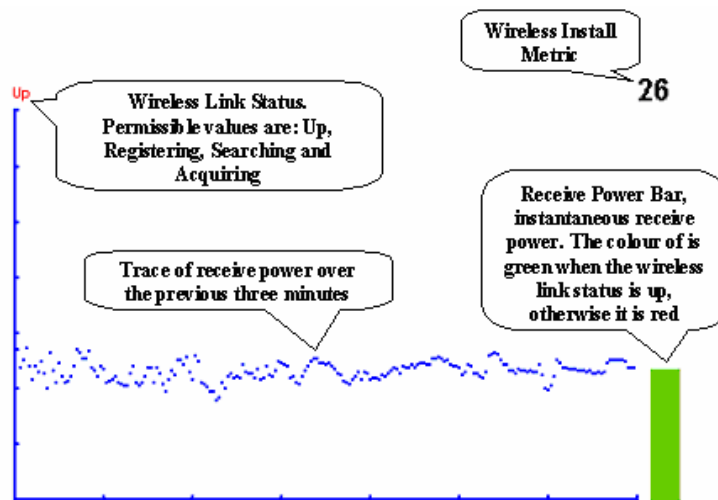

Figure 53 Graphical Installation Screen

The screen displays the receive power over the last three minutes. This will allow the installer to slowly sweep the antenna during installation and monitor the variation in signal strength with angular position. The screen automatically refreshes every three seconds.

The screen also displays the current state of the wireless link in two ways. First, the actual state of the wireless link is written in the top left corner of the screen. The instantaneous receive power bar also encodes the state of the wireless link using green to signify that the wireless link is up and red for all other states.

For the more technically aware, the installation metric is simply the instantaneous receive power in dBm + 100.

The PDA installation tool is accessed via a hidden URL <http://<ip-address>/pda.cgi>. It should be noted that this link is only available after the user has logged in as system administrator.

The large screen version of the graphical user interface is available as a submenu option of the installation wizard.

8.3.6 Software Upgrade

The 500 Series system has two software image banks; one is a fixed image which is stored in protected non-volatile memory and cannot be modified by the user. The second bank is used by the system administrator to upgrade the firmware when necessary. **Figure 54** shows the main software upgrade web page.

Figure 54 Software Upgrade

The ‘Fixed’ or ‘Recovery’ image is used by the System Administrator to:

- Reset Ethernet configuration to default settings
- Erase Configuration
- Upgrade software

For a full description of the Recovery image see **Section 9** “Recovery Mode”.

The software upgrade pages are used to update a unit’s operational software. The software image to be uploaded should be downloaded to local storage from the Motorola web site. The software image is delivered by Motorola as a compressed zip file. Once the zip file has been downloaded, the user should extract the PTP 500 Series Software image, identifiable by its ‘.dld’ file extension.

The first step (**Figure 54**) is to use the “Browse” button to locate the software image previously downloaded to local storage from the Motorola web site. Once the image is located, the user should press the “Upload image to wireless unit” button to start the software upgrade process¹⁸.

¹⁸ During the software upgrade process, ensure that the remote end is upgraded first using the wireless connection and then the local end can be upgraded.

The software image will now be uploaded to the unit. This upload should only take a few seconds. Once complete the image is verified and validated to ensure that no errors occurred during transfer and that the image is valid to run on the current platform. If there are any problems a warning screen will appear.

The unit being upgraded will now display information about the build it currently has stored in the image bank and the one that's just been uploaded. If the image is not the right one, the user has the option to go back and reload a new image. (See **Figure 55**)

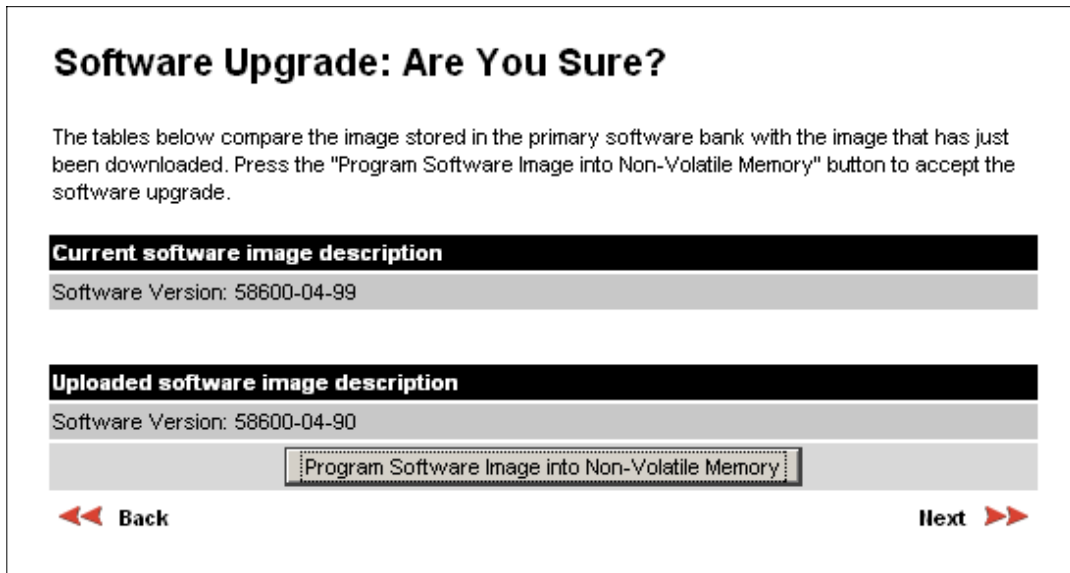

Figure 55 Software Upgrade Image Check

The user should ensure that the correct image is shown before pressing the “Program Software Image into Non-Volatile Memory” button. Once this button has been pressed the image is stored into non-volatile memory, this process can take up to 60 seconds and must not be interrupted.

If the upgrade process is interrupted during the erasure of the image bank, or during the reprogramming of the image bank, the image bank will be left in a corrupt state. If this occurs the software must be reloaded. All software images that are stored in non-volatile memory are protected via the use of CRCs. If the software detects an invalid CRC the image bank is marked as ‘corrupt’ and the 500 Series bridge boot code will boot the fixed software image. If this occurs the user must attempt to reload the correct version of software.

During the write process the progress of the upgrade is displayed on the progress tracking page (**Figure 56**). The upgrade process should not be interrupted. Interruption of this process can result in a corrupt main software image, which will result in the recovery image being booted at the next reset cycle.

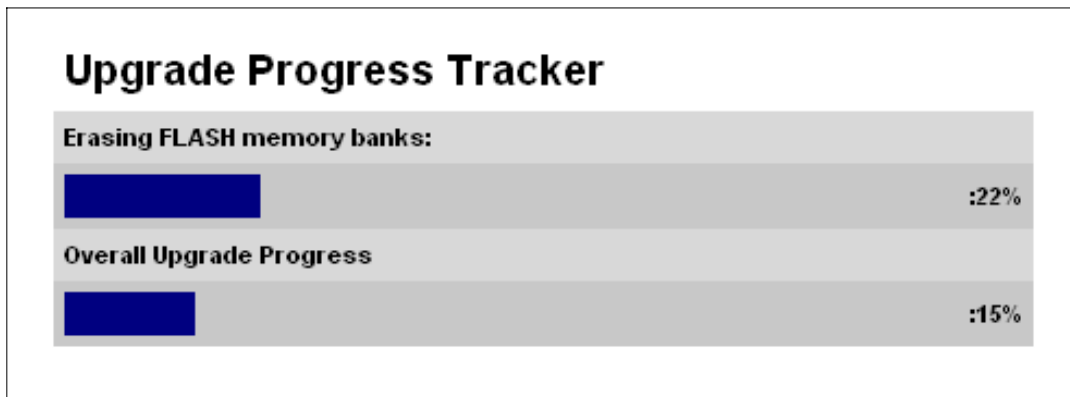

Figure 56 Software Download Progress Indicator



Figure 57 Software Upgrade Complete

When the software image has been written to non-volatile memory **Figure 57** will be displayed showing the status of the software upload.

Reboot the unit by clicking the "Reboot Wireless Unit" button. You will be asked to confirm this action as shown in **Figure 58**.

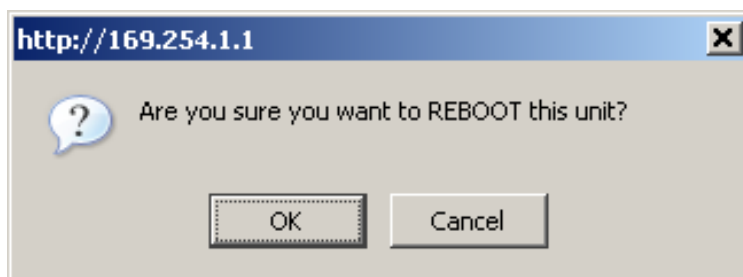

Figure 58 Reboot Confirmation Pop Up

This will reboot the unit, taking up to 120 seconds. During this time you will not be able to communicate with the unit.

If you cannot communicate with the unit after 120 seconds, this could indicate a problem with the memory update process. Under these circumstances the user should enter “Recovery Mode”, see [Section 9](#) “Recovery Mode”.

After the reboot the user should check that the required software image is loaded and running.



NOTE: Please ensure that you are upgrading the correct units. Units cannot be downgraded..

8.3.7 Spectrum Management

Spectrum Management Selection is the PTP 500 Series Bridge feature that monitors the available wireless spectrum and directs both ends of the wireless link to operate on a channel with a minimum level of co-channel and adjacent channel interference.

8.3.7.1 Wireless Channels

The PTP 500 Series Bridge operates using a set of predefined overlapping channels. There are a different number of channels, depending on the raster mode selected. Each channel occupies 15 MHz of wireless spectrum and is offset in center frequency from its neighboring channel by 5 MHz. It is important to note that adjacent channels on the Spectrum management display have a 5 MHz overlap to the adjacent channel.

The default channelization can be modified by varying the lower center frequency attribute in the installation wizard - see [Section 8.3.4.3](#) “Wireless Configuration”. See [Section 5](#) “General Considerations” for more detail.

8.3.7.2 Spectrum Management Measurements

The 500 Series Bridge performs two mean signal measurements per TDD cycle, per channel. This mean measurement represents the mean received signal power for the 40 microseconds measurement period.

The Spectrum Management algorithm collects measurements equally from all channels.

This process is called the Channel Availability Check (hereafter referred to by the acronym CAC).

The CAC uses a round-robin channel selection process to collect an equal amount of measurements from each channel. It is important to note that the CAC measurement process is not altered by the channel barring process. Measurements are still collected for all channels irrespective of the number of barred channels.

8.3.7.3 Measurement Analysis

Spectrum Management uses statistical analysis to process the received peak and mean measurement. The statistical analysis is based on a fixed, one minute, measurement quantization period. Spectrum Management collects data for the specified quantization period and only at the end of the period is the statistical analysis performed.

The analysis produces three key metrics for each channel:

- Peak of Means
- 99.9% Percentile of the Means
- Mean of Means

Peak of Means: is the largest mean interference measurement encountered during the quantization period. The peak of means is similar to the peak of peaks and is useful for detecting slightly longer duration spikes in the interference environment. 99.9% Percentile of the Means is the value of mean interference measurement which 99.9% of all mean measurements fall below, during the quantization period. The 99.9% percentile metric is useful for detecting short duration repetitive interference that by its very nature has a minimal effect of the mean of means.

Mean of Means: is the arithmetic mean¹⁹ of the measured means during a quantization period. The mean of means is a coarse measure of signal interference and gives an indication of the average interference level measured during the quantization period. The metric is not very good at predicting intermittent interference and is included to show the spread between the mean of means, the 99.9% percentile and the peak of means.



Important Note: Spectrum Management uses the 99.9% percentile as the prime interference measurement. All subsequent references to interference level refer to this percentile measurement.

The display of statistical measurement on the spectrum management page always shows a statistical summary of all channel measurement. The statistical summary is controlled by the Statistics Window attribute. This attribute defaults to a value of twenty minutes, which means that the mean and percentile values displayed for each channel are calculated over the 20 minute period. All channel decisions are made using the values computed over the statistics window period.

8.3.7.4 The Spectrum Management Master / Slave Relationship

The Spectrum Management operates in a master / slave relationship. The master is assumed to be the link master configured during installation. All Spectrum Management configuration changes MUST be performed from the master. To enforce this, the Spectrum Management web page has a different appearance depending if you are viewing the data from the master or slave.

All configuration changes are applied at the master only. These changes are then messaged from the master to the slave. Any Spectrum Management configuration messages received at the slave are stored in non-volatile memory. This enables both master and slave to keep identical copies of Spectrum Management configuration data in their non-volatile memories. It is therefore possible to swap master and slave roles on an active Point-to-Point link without modifying Spectrum Management configuration.

¹⁹ The arithmetic mean is the true power mean and not the mean of the values expressed in dBm.

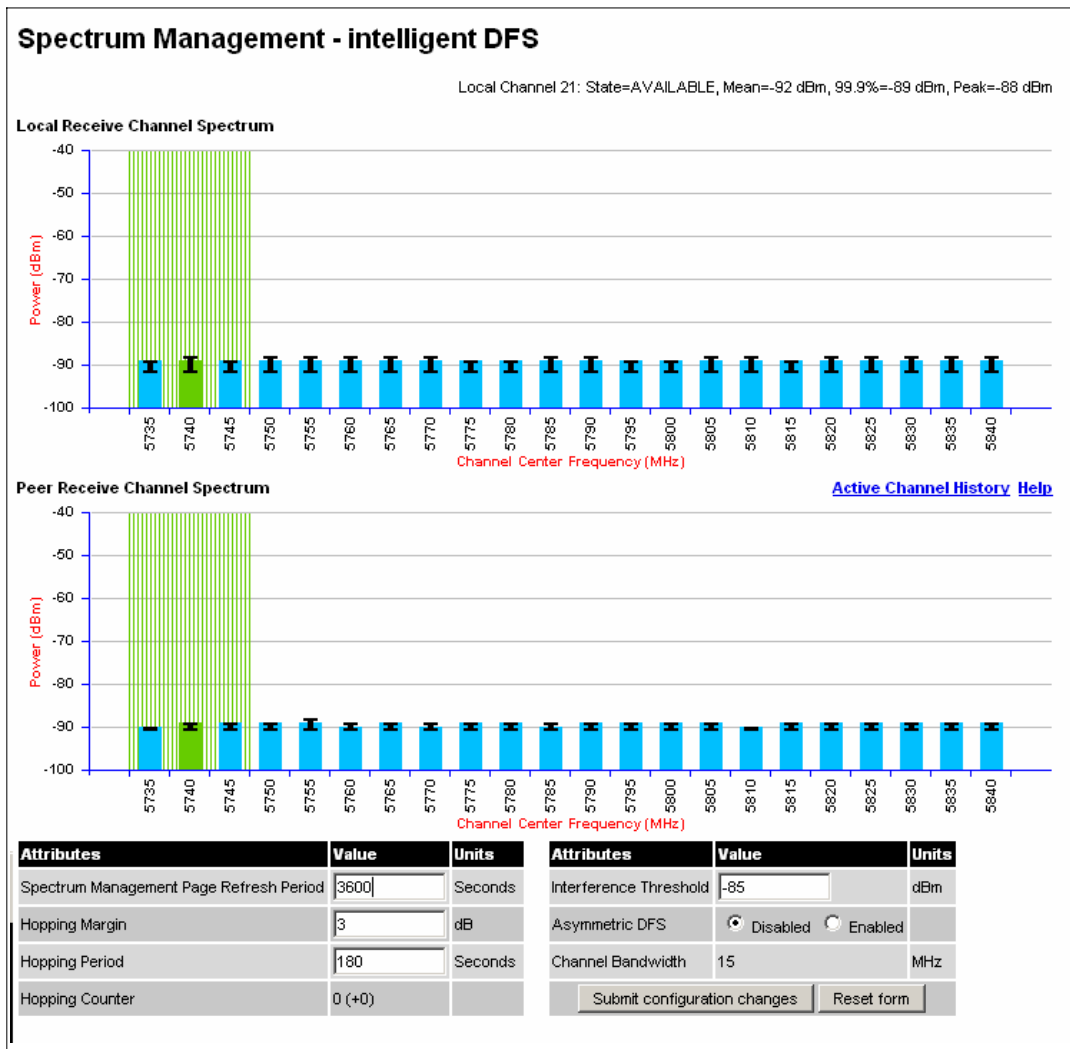

Figure 59 Spectrum Management as seen from the Master

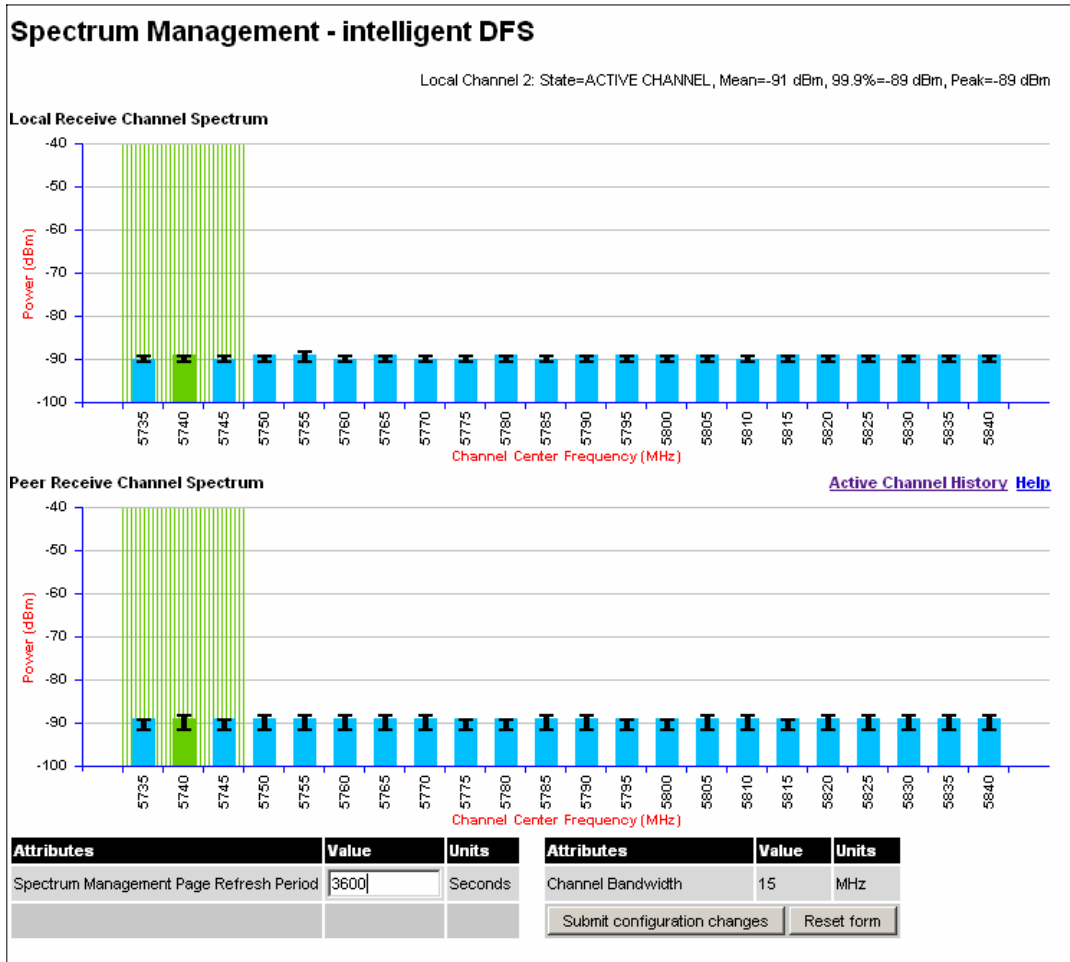

Figure 60 Spectrum Management as seen from the Slave

Figure 59 shows an example Spectrum Management webpage as seen from the master.

Figure 60 shows an example Spectrum Management webpage as seen from the slave. It should be noted that the key configuration attributes are not available on the slave web page.

8.3.7.5 Spectrum Management Configuration

The following section describes the user modifiable configuration accessible from the Spectrum Management webpage. It is recommended that the default values are maintained. If the user believes that the performance of the Spectrum Management algorithm requires some modifications this should only be done after consulting your Motorola Point-to-Point distributor or one of the system field support engineers.

Page Refresh Period: The page refreshes automatically according to the setting entered here (in seconds).

Hopping Margin:Spectrum Management uses this margin when making a channel hop decision. The target channel has to have an interference level 3 dB (default) better than the current active channel.

Hopping Period (not configurable):The Spectrum Management algorithm evaluates the metrics every ‘Hopping Period’ seconds (180 seconds by default) looking for a channel with lower levels of interference. If a better channel is located, Spectrum Management performs an automated channel hop. If SNMP or SMTP alerts are enabled an SNMP TRAP or an email alert is sent warning the system administrator of the channel change.

Hopping Counter:is used to record the number of channel hops. The number in the “(+)” brackets indicates the number of channel changes since the last screen refresh.

Interference Threshold:Spectrum Management uses the interference threshold to perform instantaneous channel hops. If the measured interference on a channel exceeds the specified threshold, then iDFS will instruct the wireless to immediately move to a better channel. If a better channel cannot be found the 500 Series Bridge will continue to use the current active channel. (Default -85 dBm)

Asymmetric DFS:The default configuration of symmetric operation constrains the link to operate symmetrically, using the same transmit and receive channels. When in symmetric mode the slave unit will always follow the master. If the master moves to a new channel the slave will hop to the same channel. When the Point-to-Point link is configured as an asymmetric link both the master and slave are free to select the best channel from their own set of local interference metrics.

Channel Bandwidth (not configurable):shows the value of the variable channel bandwidth selected.

8.3.7.6 Barring Channels

Channels can only be barred / unbarred by the system administrator from the master Spectrum Management web page. The barring / unbarring operations are disabled on the slave web page. If an attempt to bar / unbar a channel is made at the slave, a warning dialog is generated.

Barring/Unbarring of channels is performed by clicking the appropriate channel on the local or peer channel spectrum plots on the master web page. Each bar / unbar attempt will be preceded by a confirmation dialog. It should be noted that the channel bar will take effect immediately and is not related to the measurement quantization period.

8.3.7.7 Master and Slave Channel Spectrum Graphics

Spectrum Management presents its computed statistical measurements in a graphical display on both the master and slave Spectrum Management web page.

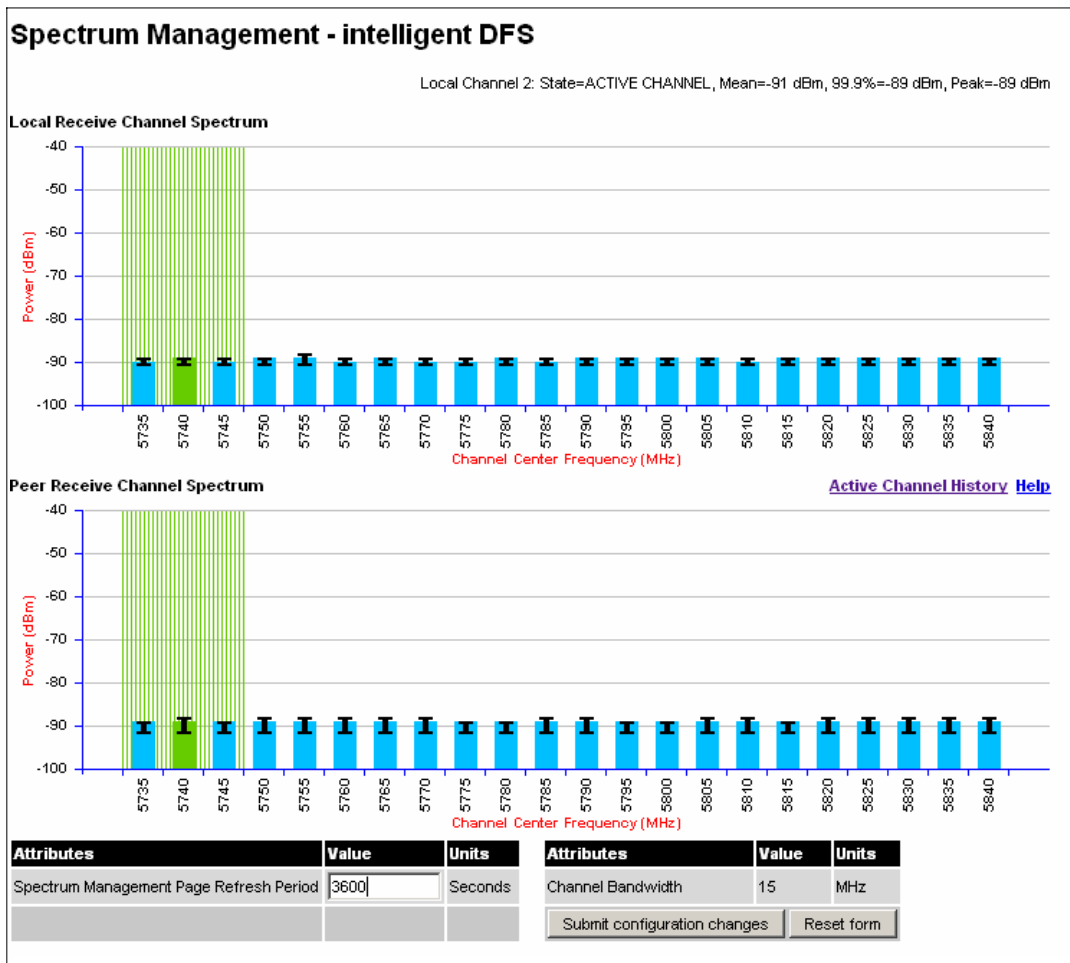

Figure 61 Example Spectrum Management Graphic

The X-axis shows a stylized view of the selectable wireless channels. It is important to note that adjacent channels on the display have a 10 MHz overlap. The display separates the display of channels to help the clarity of the resultant display. The axis is labeled using the channel center frequencies in MHz.

The Y-axis shows the interference power levels from -100 to -40 dBm.

The active channel (channel 5 in **Figure 61**) is always marked using hatched green and white lines. The width of the hatching is directly proportional the channel bandwidth spectral occupancy of the channel.

The individual channel metrics are displayed using a colored bar and an ‘I’ bar.

The colored bar represents the following channel state:

Green	Active	The channel is currently in use, hosting the Point-to-Point wireless link.
Orange	Interference	The channel has interference above the interference threshold
Blue	Available	The channel has an interference level below the interference threshold and is considered by the Spectrum Management algorithm suitable for hosting the Point-to-Point link.
Grey	Barred	The system administrator has barred this channel from use. For improved visibility, an additional red 'lock' symbol is used to indicate that a channel is barred

Table 13 Spectrum Management change state key

The top of the colored bar represents the 99.9% percentile metric for specific channel. The 'P' Bar is used to display the mean of means and peak of means metrics. The lower horizontal bar represents the mean of means and the upper horizontal bar represents the peak of means. The vertical bar is used as a visual cue to highlight the statistical spread between the peak and the mean of the statistical distribution.

8.3.7.8 Active Channel History

The active channel history is a time series display of the channels used by the PTP 500 Series Bridge over the last 25 hours. The active channel history is activated from the main Spectrum Management page using the 'Active Channel History' hyperlink. An example of the active channel history display is shown in **Figure 62**. Where there are parallel entries on the display this signifies that the wireless link occupied this channel during the measurement period. The measurement periods are one minute (from zero to sixty minutes) and twenty minutes from (60 minutes to twenty five hours).

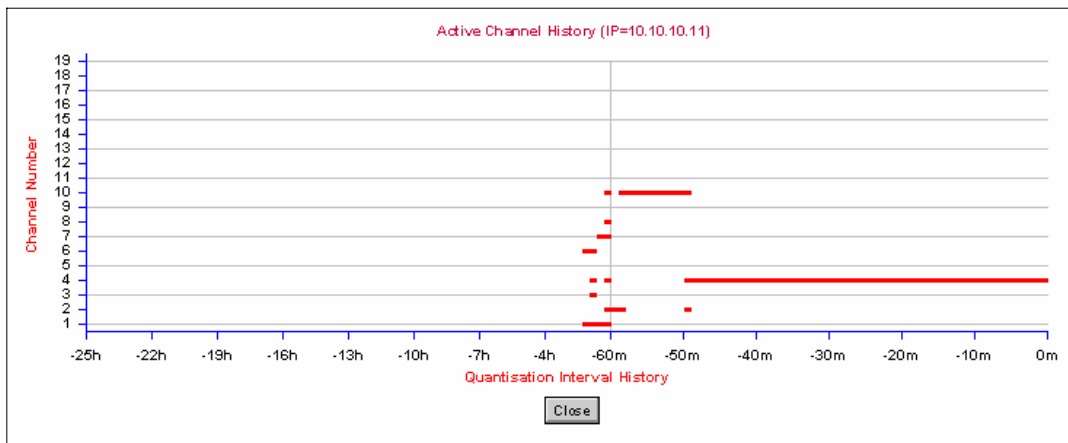

Figure 62 Active Channel History Screen

8.3.7.9 Viewing Historic Spectrum Management Metrics

Spectrum Management allows the system administrator to view the results of previous measurement quantization periods. Holding down the shift key and clicking the appropriate channel on the local channel spectrum plots activates this feature. This feature is available on both the master and slave web page.

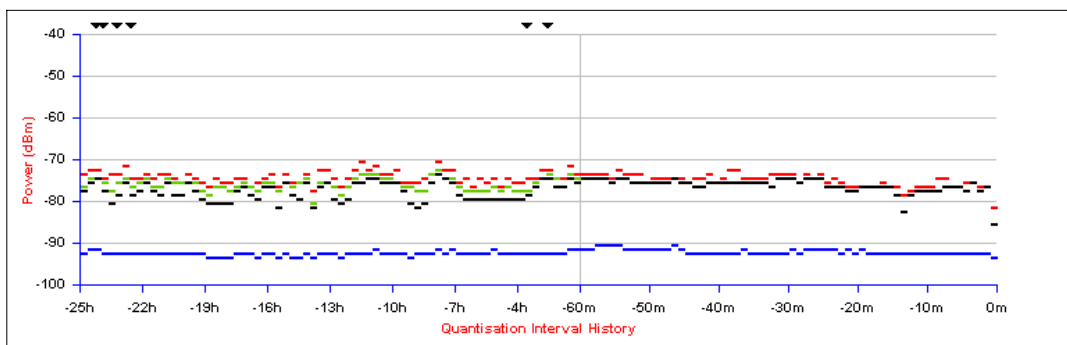

Figure 63 Spectrum Management Time Series Plot

Figure 63 shows an example time series plot. A time series plot displays the previous 132 measurement quantization periods. If the PTP 500 Series Bridge has not been running for 132 quantization periods then only the number of measurement quantization periods that are available are displayed.

GREEN	Peak of Means interference measurement
BLACK	99.9% percentile of means intinterference measurement
BLUE	Mean of means interference measurement

Table 14 Spectrum Management Time Series Key

8.3.8 Spectrum Management (Fixed Frequency)

The PTP 500 Series Bridge software allows a user to optionally fix transmit and receive frequencies for a wireless link. Once configured, the spectrum management software will not attempt to move the wireless link to a channel with lower co and adjacent channel interference. Therefore this mode of operation is only recommended for deployments where the installer has a good understanding the prevailing interference environment. (See [Section 8.3.4.3](#) “Wireless Configuration”). Care must also be taken to ensure that the frequency allocations at each end of the link are compatible. To help the user when identifying the mode of operation Spectrum Management uses two visual cues. See [Figure 64](#).

The main page title identifies the mode of operation using the “Fixed Frequency Mode” postfix and the selected channels are identified by a red capital ‘F’.

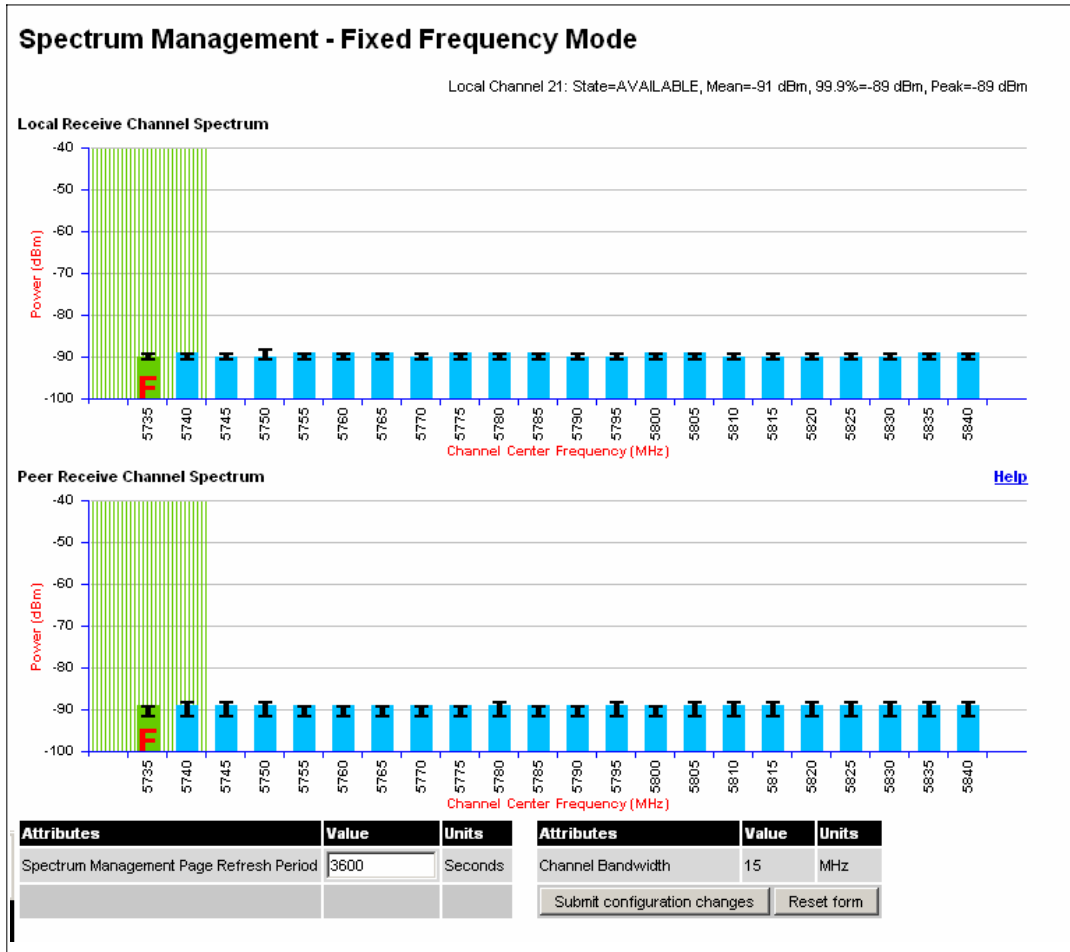

Figure 64 Spectrum Management Fixed Frequency Screen

Channel barring is disabled in fixed frequency mode; it is not required as dynamic channel hopping is prohibited in this mode.

The only controls available to the master are the Statistics Window and Interference Threshold attributes. They will have no effect on the operation of the wireless link and will only effect the generation of the channel spectrum graphics.

The active channel history menu is removed in this mode of operation as channel hopping is prohibited.

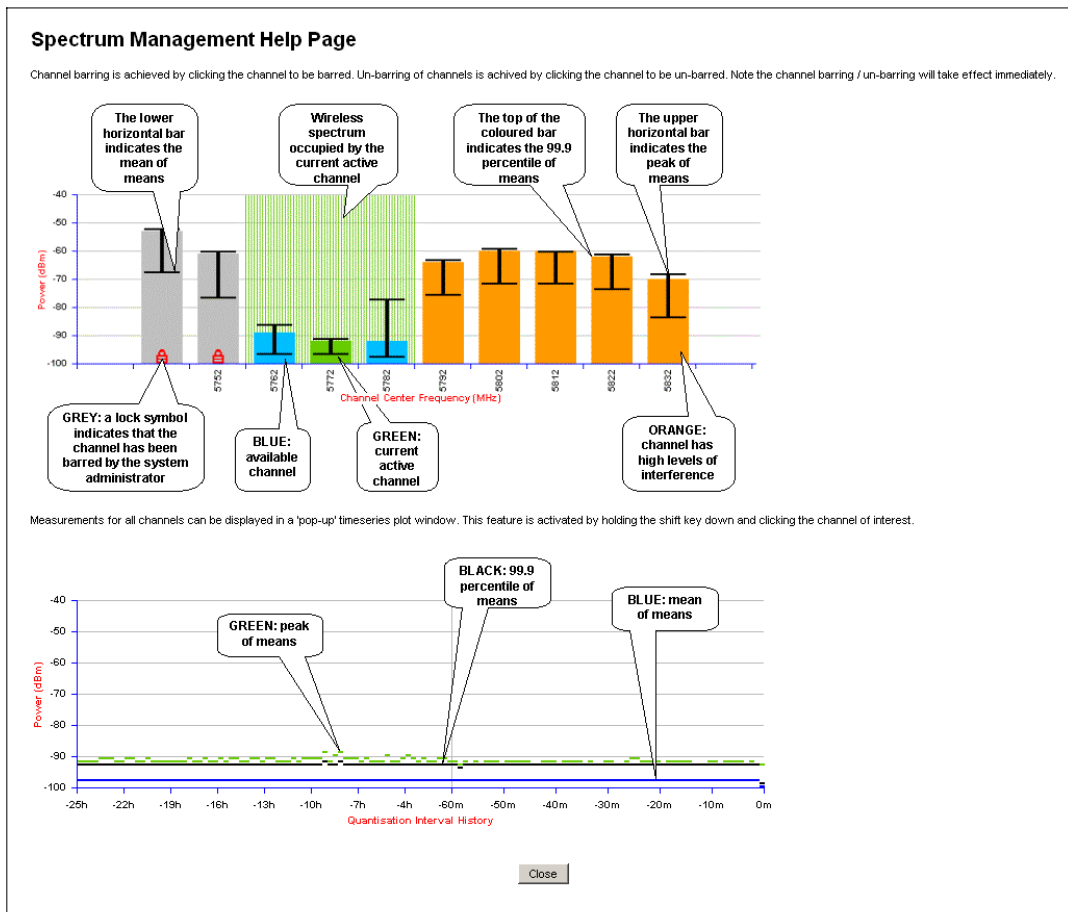

Figure 65 Spectrum Management Help Page (Fixed Frequency)

8.3.9 Spectrum Management Control – With Operational Restrictions

When operating with Radar Avoidance enabled the following variances in operation apply:

- The words “Radar Avoidance” are appended to the “Spectrum Management” title at the top of the screen. See [Figure 66](#) and [Figure 67](#).
 - The only controls available to the master are the Interference Threshold attribute. This has no effect on the operation of the wireless link and will only affect the generation of the channel spectrum graphics. See [Figure 66](#).
 - Extra color coding of the interference histogram is provided. See [Table 15](#).
- When operating with RTTT (Road transport and Traffic Telematics) Avoidance enabled or other regulatory restrictions on channel usage the following variances apply:
- All channels marked with a ‘no entry’ symbol with their associated statistics colored black are the prohibited channels. See [Figure 66](#) and [Figure 67](#). These channels are never used to host the wireless link, but CAC measurements are still taken so that adjacent channel biases can be calculated correctly and so the user can see if other equipment is in use.

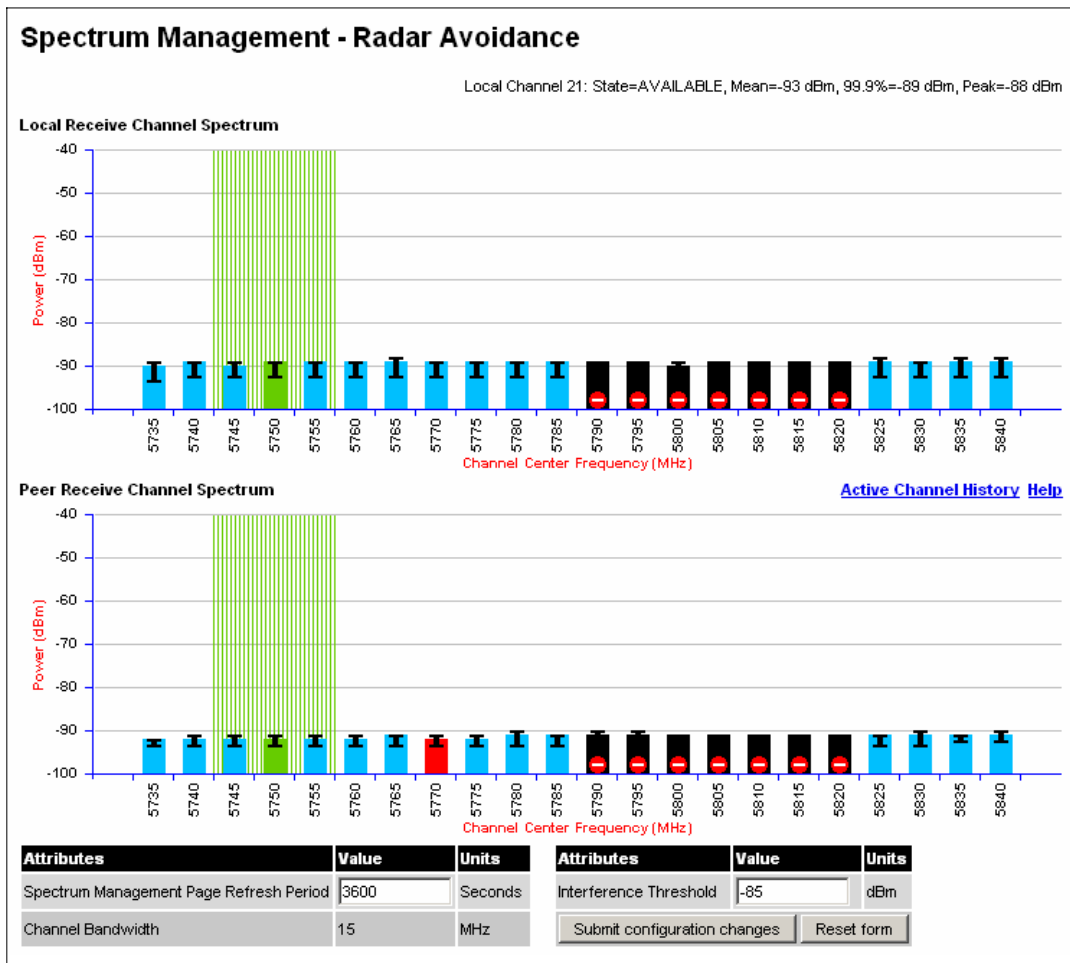

Figure 66 Spectrum Management Master Screen With Operational Restrictions

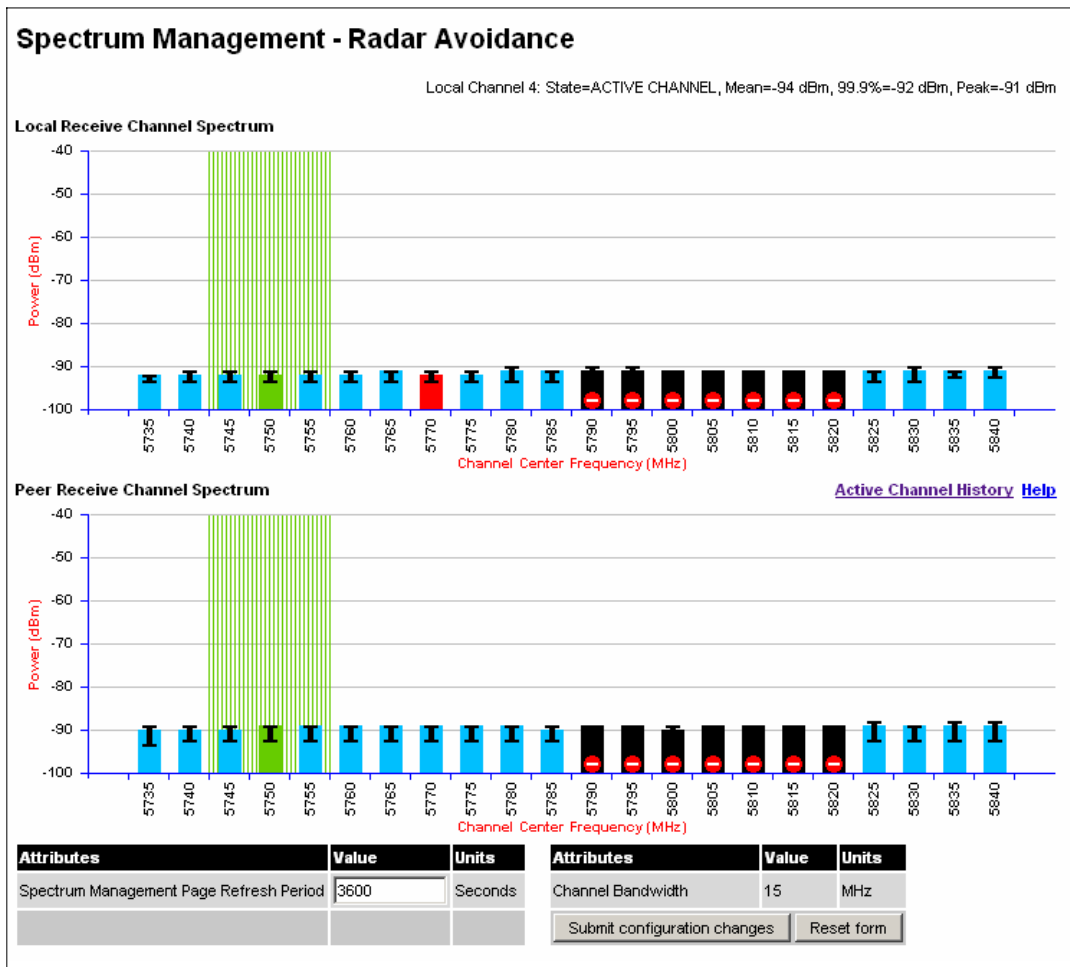

Figure 67 Spectrum Management Slave Screen With Operational Restrictions

The colored bar represents the following channel state:

Web Page Reference

Green	Active	The channel is currently in use hosting the Point-to-Point wireless link
Orange	Interference	The channel has interference above the interference threshold
Blue	Available	The channel has an interference level below the interference threshold and is considered by the Spectrum Management algorithm suitable for hosting the Point-to-Point link
Grey	Barred	The system administrator has barred this channel from use. Because the low signal levels encountered when a unit is powered up in a laboratory environment prior to installation (which makes the grey of the channel bar difficult to see). An additional red 'lock' symbol is used to indicate that a channel is barred.
Red	Radar detected	Detected Impulsive Radar Interference has been detected on this channel.
Region Bar	Region Bar	This channel has been barred from use by the local region regulator

Table 15 Spectrum Management Change State Key With Operational Restrictions

8.3.10 Remote Management Page

The Remote Management page (**Figure 68**) allows the system administrator to configure the remote management of the PTP 500 Series Bridge.

8.3.10.1 Control Access to HTTP Interface

The attribute **HTTP Access Enabled** allows a user to stop any access to a unit via the web interface. The default value for this control is set to “yes”, which means that the unit can be accessed using the web interface. If the option “No” is selected, then a warning is displayed as shown in **Figure 69**.

8.3.10.2 Control Access to Telnet Interface

The attribute **HTTP Telnet Enabled** allows a user to stop any access to a unit via the telnet interface. The default value for this control is set to “yes”, which means that the unit can be accessed using the telnet interface²⁰

8.3.10.3 SNMP (Simple Network Management Protocol)

The industry standard remote management technique is SNMP (Simple Network Management Protocol). The PTP 500 Series Bridge supports version 1 and version 2c of the SNMP protocol.

8.3.10.4 Supported Management Information Bases (MIBS)

The PTP 500 Series Bridge SNMP stack currently supports the following MIBs:

- MIB-II, RFC-1213, The PTP 500 Series Bridge supports the ‘System Group’ and ‘Interfaces Group’.
- Bridge MIB, RFC-1493, The PTP 500 Series Bridge supports the ‘dot1dBase Group’ and the ‘dot1dBasePortTable Group’.
- PTP 500 Series Bridge proprietary MIB
- RFC-2233 (High capacity counter) MIB
- WiMAX MIB SNMP TRAPs supported:
 - Cold Start
 - Link Up
 - Link Down
 - DFS Channel Change
 - DFS Impulsive Interference

²⁰ Note that if HTTP, Telnet and SNMP interfaces have been disabled, then the user needs to use the Recovery image to Sreset IP & Ethernet Configuration back to factory defaultsT to re-enable the HTTP-Telnet interfaces. SNMP can also be used to re-enable the other interfaces if SNMP is enabled.

Remote Management

HTTP and Telnet

Attributes	Value	Units
HTTP Access Enabled	<input type="radio"/> No <input checked="" type="radio"/> Yes	
Telnet Access Enabled	<input type="radio"/> No <input checked="" type="radio"/> Yes	

Simple Network Management Protocol (SNMP)

SNMP State	<input checked="" type="radio"/> Disabled <input type="radio"/> Enabled	
SNMP Enabled Traps	<input checked="" type="checkbox"/> Coldstart	
	<input checked="" type="checkbox"/> PTP Link Status Change	
	<input checked="" type="checkbox"/> DFS Channel Change	
	<input checked="" type="checkbox"/> DFS Impulse Interference	
	<input type="checkbox"/> Enabled Diagnostic Alarms	
SNMP Trap Version	<input type="radio"/> SNMP version 1 <input checked="" type="radio"/> SNMP version 2c	
SNMP Trap IP Address	0 . 0 . 0 . 0	
SNMP Trap Port Number	162	
SNMP Community String	public	
SNMP Port Number	161	

Simple Mail Transfer Protocol (SMTP)

SMTP Email Alert	<input checked="" type="radio"/> Disabled <input type="radio"/> Enabled	
SMTP Enabled Messages	<input checked="" type="checkbox"/> PTP Link Status Change	
	<input checked="" type="checkbox"/> DFS Channel Change	
	<input checked="" type="checkbox"/> DFS Impulse Interference	
	<input type="checkbox"/> Enabled Diagnostic Alarms	
SMTP Server IP Address	0 . 0 . 0 . 0	
SMTP Server Port Number	25	
SMTP Source Email Address		
SMTP Destination Email Address		

Clock

SNTP State	<input checked="" type="radio"/> Disabled <input type="radio"/> Enabled	
Set Time	15 : 45 : 34	
Set Date	2008 Jan 22	
Time Zone	GMT 00.00	
Daylight Saving	<input checked="" type="radio"/> Disabled <input type="radio"/> Enabled	

Figure 68 Remote Management

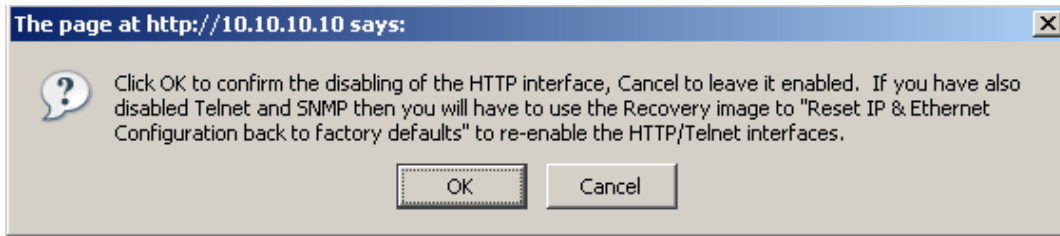

Figure 69 Warning when disabling HTTP Interface

8.3.10.5 Diagnostics Alarms

A number of diagnostics alarms have been added to allow SNMP agents to receive traps and emails if required. Refer to **Section 8.1.1** “Home Page Alarm Display” for a description of all these alarms. Checking the control “Enabled Diagnostic Alarms” in SNMP and/or SNTTP selects all the alarms shown in **Figure 70**. Users can access the sub-menu “Diagnostic Alarms” to modify the alarms selected.

Diagnostic Alarms		
Attributes	Value	Units
Enabled Diagnostic Alarms	<input checked="" type="checkbox"/> Region Code	
	<input checked="" type="checkbox"/> Install Status	
	<input checked="" type="checkbox"/> Install Arm State	
	<input checked="" type="checkbox"/> Unit Out Of Calibration	
	<input type="checkbox"/> Reserved	
	<input type="checkbox"/> Reserved	
	<input checked="" type="checkbox"/> Incompatible Region Codes	
	<input checked="" type="checkbox"/> Incompatible Master And Slave	
	<input checked="" type="checkbox"/> Ethernet Configuration Mismatch	
	<input checked="" type="checkbox"/> No Wireless Channel Available	
	<input checked="" type="checkbox"/> SNTP Synchronisation Failed	
	<input checked="" type="checkbox"/> Wireless Link Disabled Warning	
	<input checked="" type="checkbox"/> Ethernet Link Disabled Warning	
	<input checked="" type="checkbox"/> Ethernet Link Status	
	<input checked="" type="checkbox"/> Fiber Link Status	
<input checked="" type="checkbox"/> TDD Synchronization Status		

Figure 70 Remote Management – Diagnostic Alarms

For a copy of the Motorola proprietary version 1 and version 2 MIB RFCs please consult the installation CD

8.3.10.6 SNMP Configuration

SNMP State:The SNMP state attribute controls the creation of the SNMP features. Changing the SNMP state attribute requires a mandatory reboot of the unit. Only when the SNMP state is enabled at system start-up will the SNMP processor task be created.

SNMP Enabled Traps:The SNMP Enabled Traps attribute controls which SNMP Traps the unit will send.

SNMP Community String:The SNMP community string acts like a password between the networks SNMP management entity and the distributed SNMP clients (600 Series bridge). Only if the community string is configured correctly on all SNMP entities can the flow of management information take place. By convention the default value is set to 'public'. When the community string is changed the system requires a mandatory reboot before the new string or phrase is adopted.

SNMP Port Number:Is the port the SNMP management agent is listening to for commands from an SNMP manager. The default value for this port number is 161.

SNMP Trap IP Address:Is the address of either the network SNMP manager or Trap receiver. When asynchronous events (traps in SNMP terminology) are generated, the client unicasts these to this IP Address. When the address is changed the system requires a mandatory reboot before the setting is adopted

SNMP Trap Port Number:The SNMP Trap Port Number is the port number of either the networked SNMP manager or Trap receiver. By convention the default value for the port number is 162. When the port number is changed the system requires a mandatory reboot before the setting is adopted.

WiMAX Control:Enables and Disables the WiMAX (802.16) MIB. This control is only displayed when 'Fixed Frequency' is selected during installation.

8.3.10.7 SMTP (Simple Mail Transport Protocol)

The SMTP client is an alternative method for the 500 Series bridge to alert a system administrator when there are or have been system errors SMTP

Email Alert:This attribute controls the activation of the SMTP client.

SMTP Enabled Messages:The SMTP Enabled Messages attribute controls which email alerts the unit will send.

SMTP IP Address:The IP address of the networked SMTP server.

SMTP Port Number:The SMTP Port Number is the port number used by the networked

SMTP server:By convention the default value for the port number is 25.

SMTP Source Email Address:The email address used by the 500 Series to log into the SMTP server. This must be a valid email address that will be accepted by your SMTP Server.

SMTP Destination Email Address:The email address to which the 500 Series bridge will send the alert messages.

8.3.10.8 SNTP (Simple Network Time Protocol)

The SNTP client allows the 500 Series to obtain accurate date and time updates from a networked timeserver. The system time is used for SNMP and event logging.

SNTP State:When enabled, the Remote Management web page permits the following attributes to be set.

SNTP IP Address:The IP Address of the networked SNTP Server.

SNTP Port Number:The port number of the networked SNTP server. By convention the default value for the port number is 123.

SNTP Poll Interval:The period at which the SNTP client polls the server for time correction updates. Default 1 hour. If for any reason an SNTP poll fails, the client will automatically perform 3 retries before waiting for the user defined poll period.

Time Zone:The time zone is a fixed offset from GMT that is added to the SNTP time to allow the expression of time in all geographic time zones.

Daylight Saving:Allows a fixed offset of one hour to be added to the SNTP time in order to reflect the local daylight saving time.

8.3.10.9 Setting the Clock

The PTP 500 Series bridge has a system clock which can be used to supply accurate date and time information in the absence of a SNTP server. The system clock is battery backed and will continue to operate for several days if the 500 Series bridge has been switched off.

SNTP State:If the SNTP State is set to “Disabled”, see **Figure 68**, then the Remote Management web page allows the following attributes to be set:

Set Time:Shows the current time in 24 hour mode. The three editable fields display hours minutes and seconds.

Set Date:Displays the current date. The year, month and day can be set using the drop-down selection boxes.

Time Zone:See **Section 8.3.10.9** “Setting The Clock”.

Daylight Saving:See **Section 8.3.10.9** “Setting The Clock”

8.3.11 Diagnostics

To further enhance the diagnostic capabilities of the PTP 500 Series, the storage of link performance histograms has been extended to 31. To optimize RAM (volatile memory) usage a cascading histogram approach has been adopted. The root histogram is identical to the histograms in earlier releases of the software, that is data is stored for one hour at a resolution of one second. Previously, the histograms were simple cyclic buffers which never stored more than the last one hour of data. The new cascading histogram approach daisy chains multiple histograms together. When the first histogram fills up the overflow from the first is used as an input to the next histogram in line. To optimize memory utilization, a statistical analysis is performed on the overflow to reduce the amount of data to be stored. In the case of the PTP 500 Series the cascading histograms are defined as:

- Histogram 1: 1 hour at a resolution of 1 second
- Histogram 2: 24 hours at a resolution of 1 minute
- Histogram 3: 30 Days at a resolution of 1 hour

For example, when histogram 1 fills up and starts to overflow the first minute of overflow is analyzed and the maximum, minimum and mean over that minute are computed and inserted into histogram 2. When histogram 2 fills up and starts to overflow the first hour of overflow is analyzed and the maximum, minimum and mean over that hour is computed and inserted into histogram 3. When histogram 3 starts to overflow, the overflow data is simply discarded.

8.3.11.1 Diagnostic Plotter

New for the PTP 500 Series is the system administration diagnostic plotter facility see **Figure 71**:

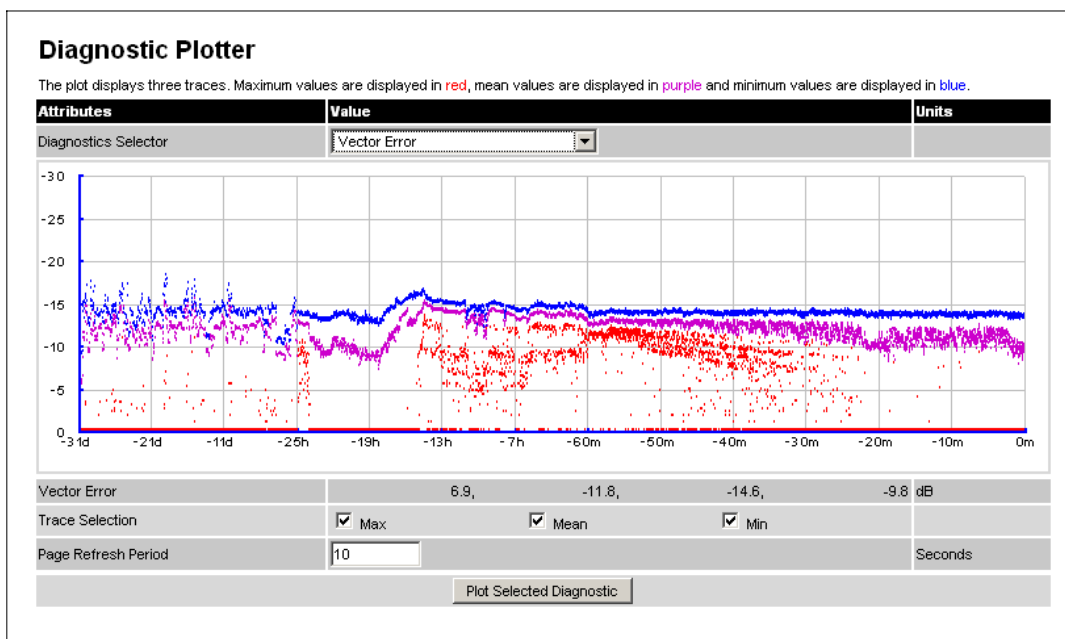

Figure 71 Diagnostic Plotter

The diagnostic plotter allows the system administrator to view the cascading histogram data in an easily accessible graphical form. The plot always displays three traces, maximum, minimum and mean by default. The diagnostic selector allows the user to select the various categories of histogram.

The histograms that are available are:

- Vector Error
- Rx Power
- Tx Power
- Signal Strength Ratio
- Link Loss
- Rx Data Rate

- Tx Data Rate
- Aggregate Data Rate

The diagnostic plotter uses a novel time representation in the x-axis which compresses the timeline of the plot without sacrificing resolution.

The trace selection allows the user to control which traces are plotted.

As with other management pages the page refresh period can be used to interactively monitor the wireless link.

8.3.11.2 Diagnostics Download

The diagnostics Download page allows the system administrator to download snapshots of system diagnostics.

Attributes	Value
Diagnostics Selector	Vector Error

Generate Diagnostics

Figure 72 CSV Download

The following diagnostics are available:

- Vector Error
- Rx Power
- Tx Power
- Signal Strength Ratio V/H
- Link Loss
- Rx Data Rate
- Tx Data Rate
- Aggregate Data Rate
- Receive SNR
- Rx Gain

All diagnostics are extracted from the associated status and statistics web page histograms. They are translated in a CSV file containing at most 578425 entries.

255784 entries comprises 3600 entries for the first hour, 1440 entries for the next 24 hours and 744 entries for the next 31 days.

8.3.12 Change System Administration Password

This page (**Figure 73**) is used to change the password for the system administration (The factory default is blank).

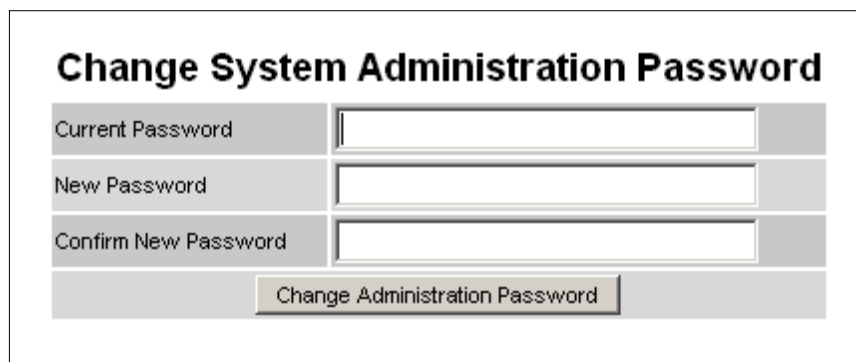

Change System Administration Password	
Current Password	<input type="text"/>
New Password	<input type="text"/>
Confirm New Password	<input type="text"/>
<input type="button" value="Change Administration Password"/>	

Figure 73 Password Change

To change the password any combination of alphanumeric characters, up to 31 characters in length, can be used.

8.3.13 License Key

The License Key data entry page allows the system administrator to update the 500 Series bridge license key. **Figure 74** shows a sample license key data entry page.

Software License Key

A valid software license key is required before installation of the PTP (Point to Point) wireless link can commence. If you do not have a valid license key please contact your distributor.

License key data entry

Attributes	Value	Units
License Key	1362-6A54-75DE-23B6	

Capability summary

Attributes	Value	Units
Product Name	Motorola PTP 58500 Full	
MAC Address	00:04:56:10:00:a0	
Region Code	Region Code 1	
Frequency Variant	5800 MHz	
Bandwidth Variant	15 MHz	

Figure 74 Software License Key Data Entry

The user must enter the license key and click the 'Validate License Key' button to check that the key is valid and program it to non-volatile memory. If a valid license key is detected then the user will be presented by a system reboot screen.

Reboot Wireless Unit

The new license key has been accepted. The system now requires a reboot before any new features can be accessed

Figure 75 License Key reboot Screen

The user will then be asked to confirm the reboot (**Figure 76**).

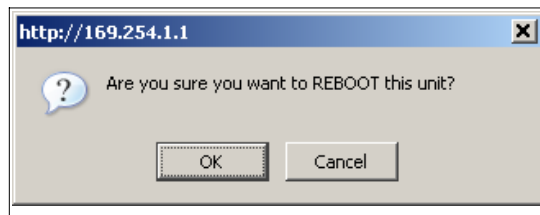

Figure 76 Reboot Confirmation Pop Up

8.3.14 Properties

The web page properties screen allows the user to configure the web page interface.

Webpage Properties		
Properties		
Attributes	Value	Units
Web Properties	<input checked="" type="checkbox"/> Disable FrontPage login	
	<input type="checkbox"/> Disable HTTP NO-CACHE META data	
Auto Logout Timer	<input type="text" value="60"/>	Minutes
Distance Units	<input checked="" type="radio"/> Metric <input type="radio"/> Imperial	
Use Long Integer Comma Formatting	<input type="radio"/> Disabled <input checked="" type="radio"/> Enabled	
Popup Help	<input type="radio"/> Disabled <input checked="" type="radio"/> Enabled	
<input type="button" value="Apply Properties"/> <input type="button" value="Reset Form"/>		

Figure 77 Properties

WEB Properties:Disable Front Page Login. Allows access to homepage and status page web pages without forcing a login as the system administrator.

WEB Properties:Disable HTTP NO-CACHE META data. Removes the HTTP NO-CACHE META clause from all dynamically created web pages.

Auto Logout TimerConfigures the time, in minutes, when the system administrator is automatically logged out if no web page activity is detected.

Distance UnitsSwaps the default metric display of distance in to imperial units, for example km to Miles.

Use Long Integer Comma FormattingChanges the format of long integers from 1000000 to 1,000,000.

8.3.15 Reboot

The reboot page allows the system administrator to perform commanded reboots of the wireless unit. The reboot page also allows the system administrator to view a list of past reboot reasons. The “Previous Reasons For Reset/Reboot” field has been implemented as a drop down selection box, where the latest reason for reboot is located at the top of the list.

If the SNTP service from the remote management section above is active, or the system time has been set, then the command reboot reason will be accompanied by the date and time at which the reboot occurred.

Attributes	Value
Previous Reasons For Reset/Reboot	User Reboot - Console (08-Nov-2006 10:33:21)

Reboot Wireless Unit

Figure 78 System Reboot

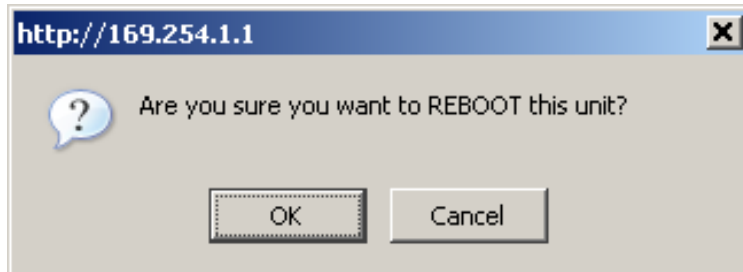

Figure 79 Reboot Confirmation Pop Up

9 Recovery Mode

The Motorola PTP 500 point-to-point wireless Ethernet bridges have a special mode of operation that allows the user to recover a unit from configuration errors or software image corruption.

Recovery mode is entered by depressing the Recovery Switch located on the underside of the PIDU Plus while applying mains power, as shown in [Section 3.3.2](#) “PIDU Plus - PTP 500 Series Bridge”. The Recovery Switch should be held in the depressed state for between 10 and 20 seconds after the application of mains power. The Ethernet LED will flash with 10 double flashes at power up (following the release of the Recovery switch).

When in recovery mode the user will be able to access the unit via the Ethernet interface. The Ethernet interface will have its IP address set to 169.254.1.1 (or 10.10.10.10 see [Section 7.7.10](#) “Powering Up”). On connection to a unit in recovery mode the following screen is displayed [Figure 80](#):

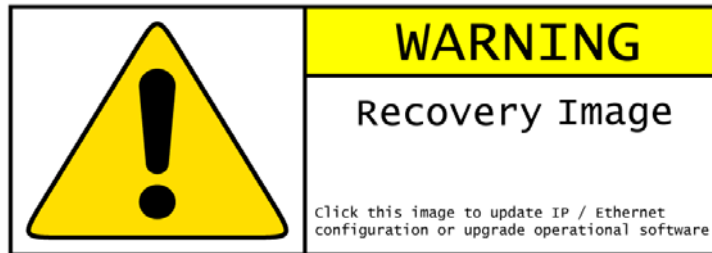

Figure 80 Recovery Mode Warning Page

Clicking on the warning page image will take the user on to the Recovery Option Page ([Figure 81](#)).

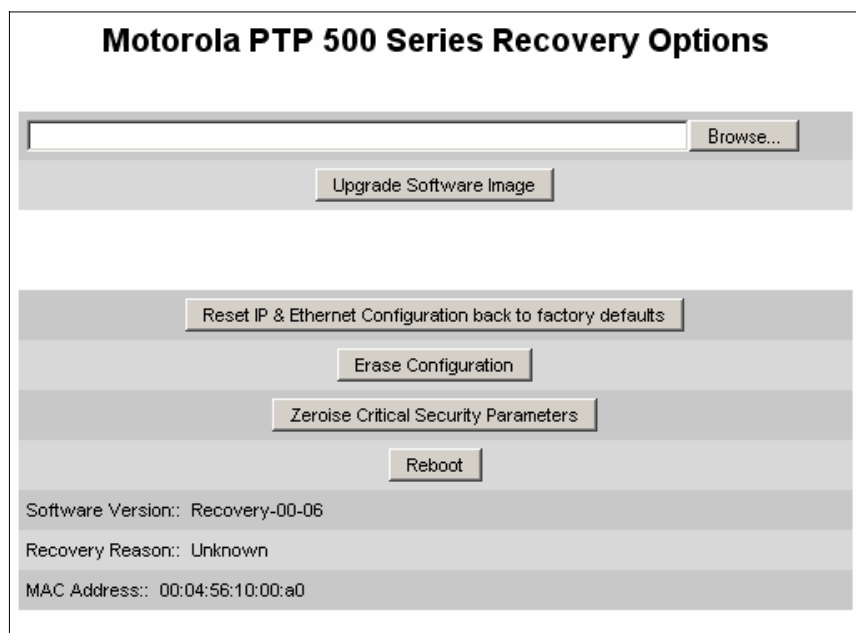

Figure 81 Recovery Options Page

The recovery options available are:

Upgrade Software Image: This allows the user to reload a software image. This may be the original image if software corruption is suspected or a step back to an old image if an incorrect image has just been loaded.

Reset IP and Ethernet Configuration back to factory defaults: This allows the user to reset the unit back to the factory defaults:

- IP Address 169.254.1.1 (or 10.10.10.10)
- Netmask 255.255.0.0
- Gateway 169.254.1.0
- Ethernet Interface Auto-negotiate, Auto-MDI/MDIX

Erase Configuration: This allows the user to erase the unit's entire configuration. Executing this option will also erase factory settings such as target MAC address, range setting, license key, etc.

Zeroise Critical Security Parameters: This allows the user to erase the security parameters such as AES parameters. This is to comply with FIPS requirements.

Reboot: This allows the user to reboot the unit. This option must be executed after resetting the IP and Ethernet configuration or erasing the configuration detailed above.

Software Version: This is the software version of the recovery operating system permanently installed during manufacture.

Recovery Mode

Recovery Reason:Indicates the reason the unit is operating in Recovery mode. Possible reasons are “Recovery button active” or “Invalid or corrupt image”

MAC Address:The MAC address shown here is the MAC address of the unit programmed during manufacture.

9.1 Upgrade Software Image

The first step (**Figure 81**) is to use the ‘Browse’ button to locate the software image to be downloaded. Once located the user should press the “Upgrade Software Image” button to start the software download process.

During software download, progress is indicated by a pair of progress bars (**Figure 82**).

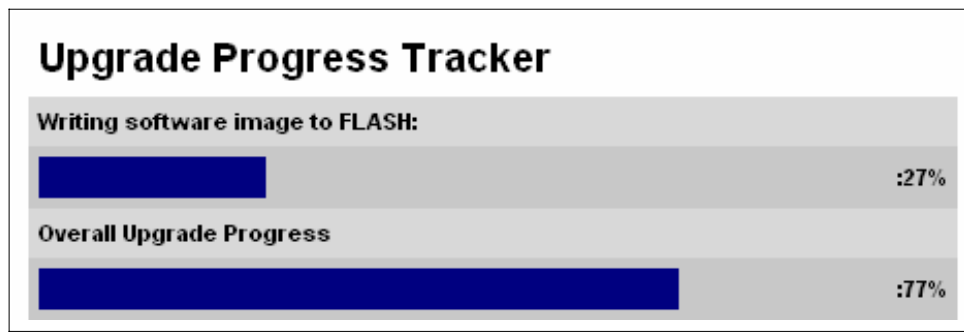

Figure 82 Software Download Progress Indicator Page

When the download is complete a page is displayed indicating the status of the software download (**Figure 83**).

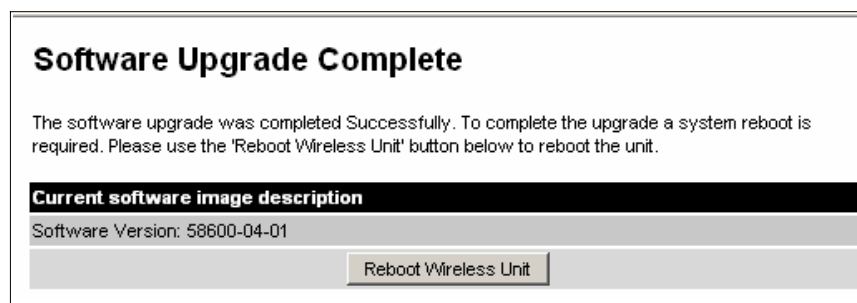

Figure 83 Software Download Complete Page

After carefully checking that correct image has been downloaded the user should reboot the unit by pressing the “Reboot Wireless Unit” button. The user will then be presented with a pop up box asking them to confirm the action (**Figure 84**)

The unit will now reboot. Providing the unit configuration is still intact the unit should restart in normal operational mode and the link should recover. Should the unit or link fail to recover the user should refer to **Section 10** “Fault Finding”.

Recovery Mode

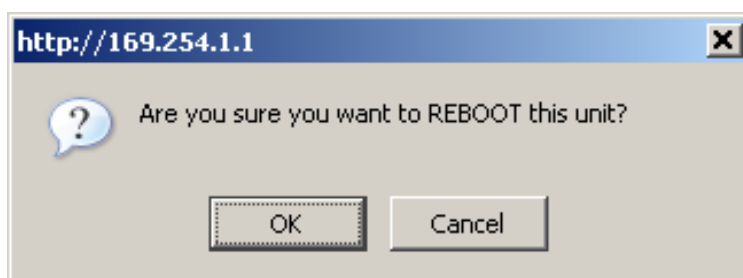

Figure 84 Reboot Confirmation Pop Up

9.2 Reset IP and Ethernet Configuration

To reset IP and Ethernet configuration back to factory defaults the user should press the “Reset IP and Ethernet Configuration back to factory defaults” button on the “Recovery Options” page (**Figure 81**). The user will now be presented with a pop up box asking them to confirm the action (**Figure 85**).

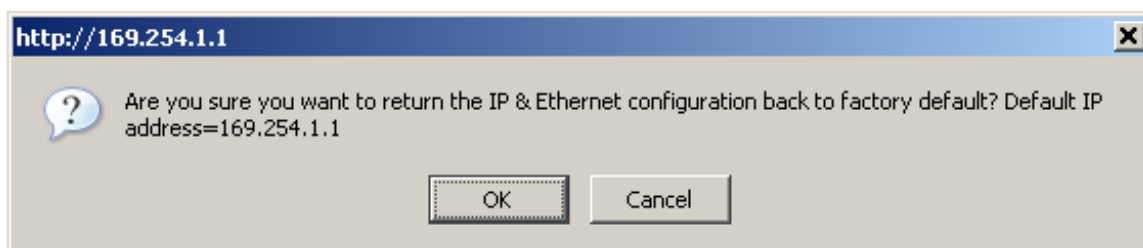

Figure 85 Confirm Reset to Factory Default Pop Up

On confirmation the following page will be displayed (**Figure 84**). The user should now reboot the unit by pressing the “Reboot” button.

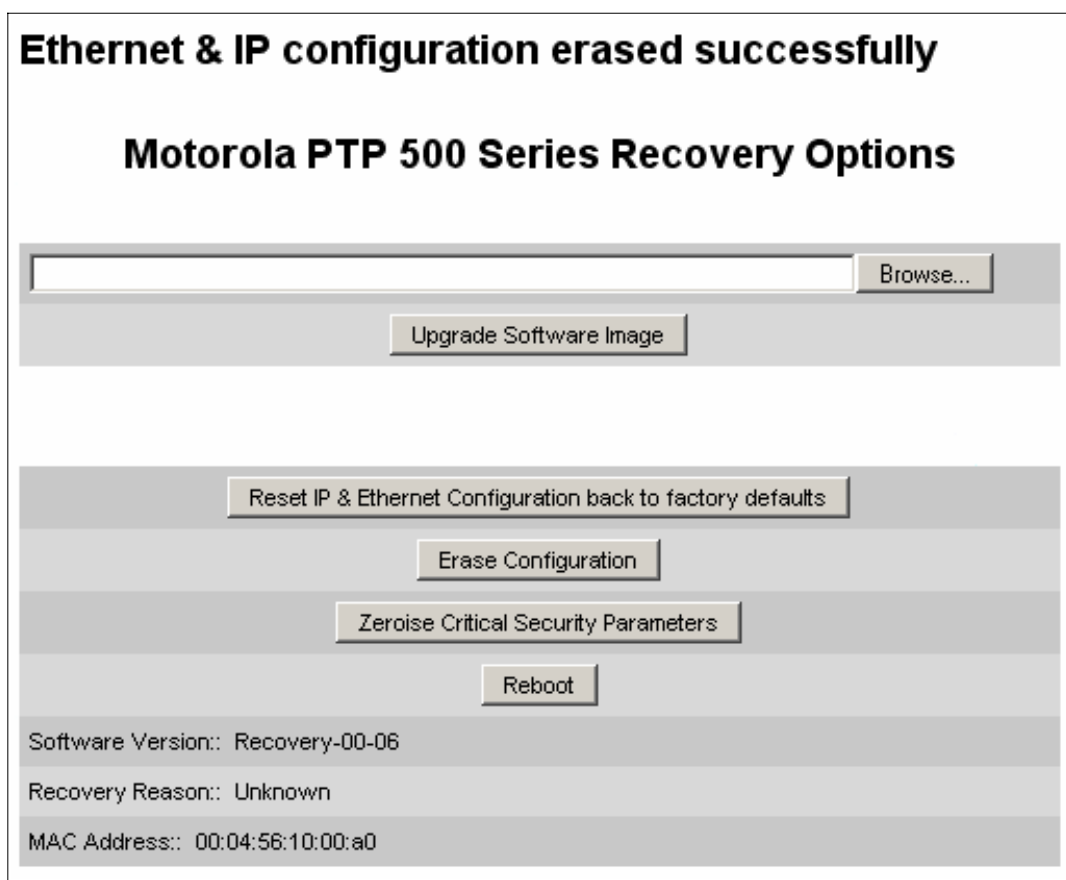

Figure 86 IP and Ethernet Erased Successfully page

The user will now be presented with a pop up box asking them to confirm the action **Figure 87**.

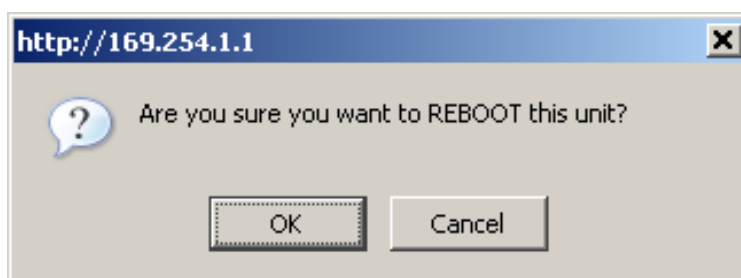

Figure 87 Reboot Confirmation Pop Up

The unit will now reboot. The unit should now start up in normal mode but with the IP address set to 169.254.1.1 and the Ethernet interface set to auto-negotiate and auto-MDI/MDIX.

Should the unit fail to start up the user should refer to **Section 10** "Fault Finding".

9.3 Erase Configuration

To erase the unit's configuration the user should press the "Erase Configuration" button on the "Recovery Options" page (**Figure 81**). The user will now be presented with a pop up box asking them to confirm the action (**Figure 88**).

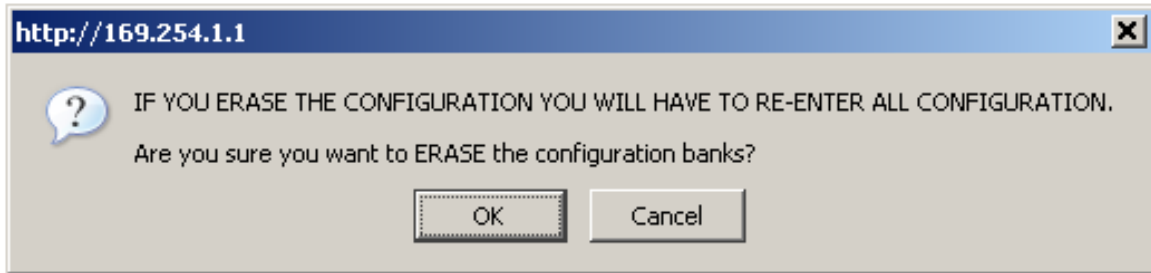

Figure 88 Confirm Erase Configuration Pop Up

On confirmation the following page will be displayed (**Figure 89**). The user should now reboot the unit by pressing the "Reboot" button.

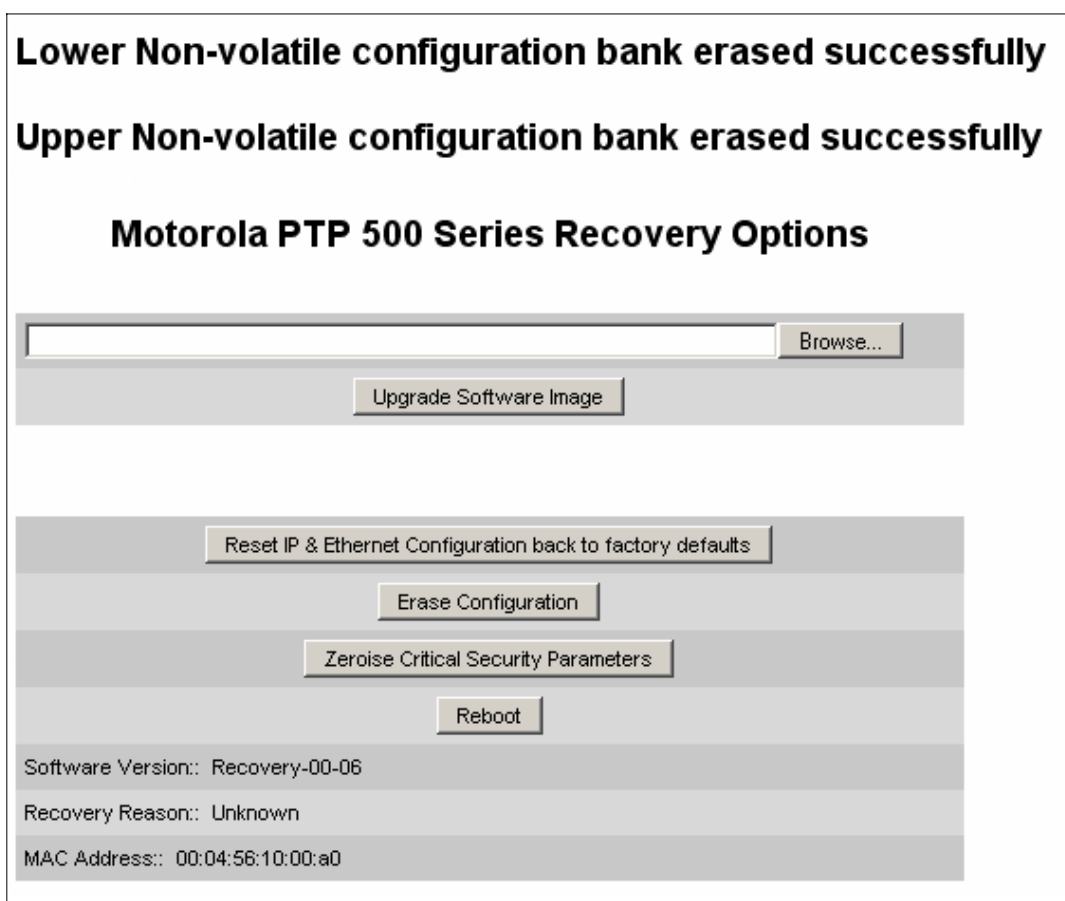

Figure 89 Erase Configuration Successful Page

The user will now be presented with a pop up box asking them to confirm the action **Figure 90**.

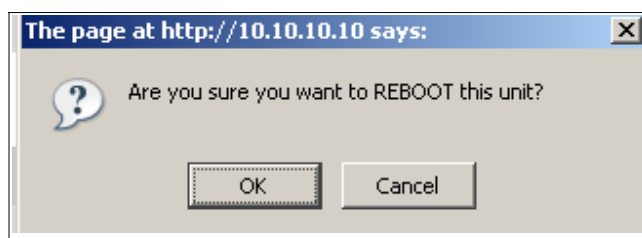

Figure 90 Erase Configuration
– Reboot Confirmation Pop Up

The unit will now reboot. The unit should now start up in normal mode but with all configuration erased. Should the unit fail to start up the user should refer to **Section 10** "Fault Finding".

9.4 Erase Security Parameters

To erase the unit's security parameters and to comply with FIPS the user should press the "Zeroise Critical Security Parameters" button on the "Recovery Options" page (**Figure 81**). The user will now be presented with a pop up box asking them to confirm the action (**Figure 91**).

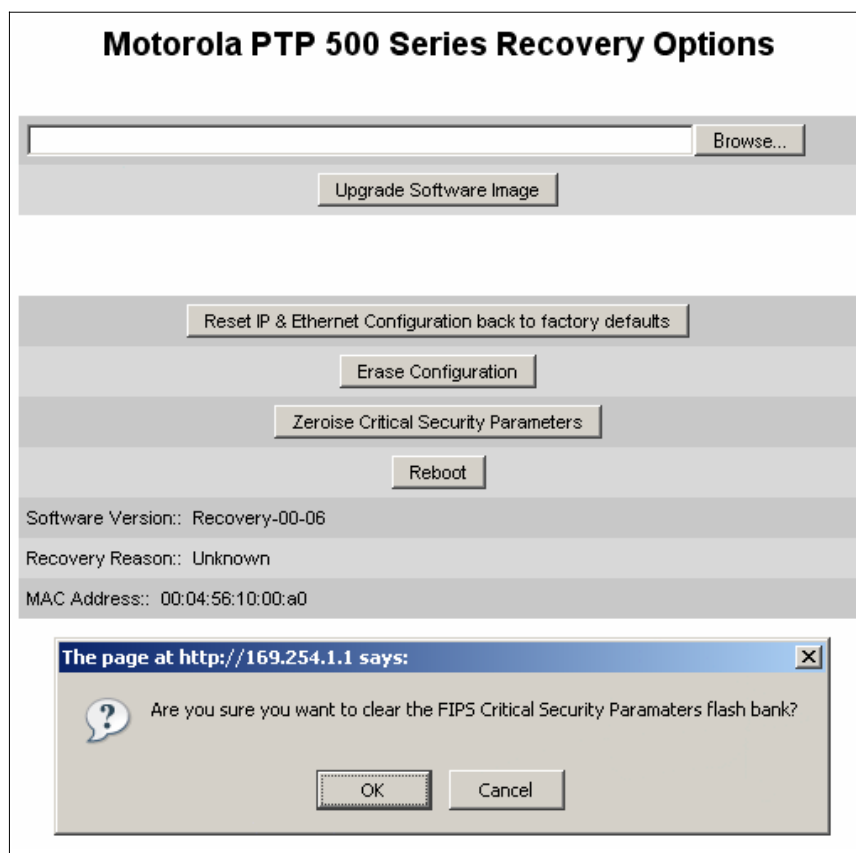

Figure 91 Confirm Zeroise Security Parameters Pop Up

On confirmation the following page will be displayed (**Figure 92**).

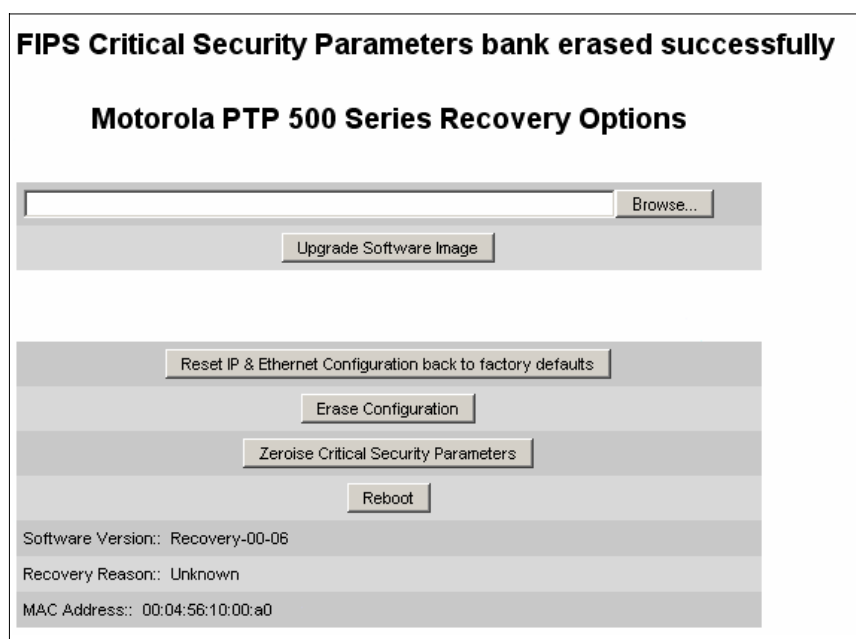

Figure 92 Zeroise Parameters Successful Page

9.5 Reboot

This option can be used to reboot the unit. The user will now be presented with a pop up box asking them to confirm the action (**Figure 93**).

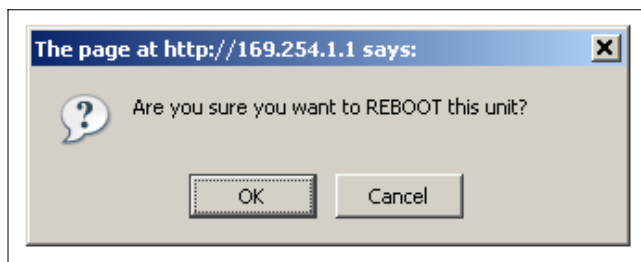

Figure 93 Recovery – Reboot Confirmation Pop Up

The unit will now reboot. The unit should now start up in normal operational mode. Should the unit fail to start up the user should refer to **Section 10** “Fault Finding”.

10 Fault Finding

If communication has been lost with the unit at the near end of the link then there may be a hardware fault with the wiring, network or hardware. Go to the hardware section below. If communication with the far end of the link is lost then go to the radio section below.

10.1 Hardware

If there are problems suspected with the link hardware the following procedure is recommended.

10.1.1 Power

Check the power LED at each end of the link. If the power lights are illuminated go to the Ethernet section below. If at either end they are not illuminated then²¹ check the power source. If neither is illuminated then there is no voltage on the power wires to the ODU.

- Check that the mains power is connected and switched on.
- Check that the power LED illuminates if the ODU connector is disconnected at the PIDU Plus (Open the PIDU Plus flap on the left hand side).

If it does illuminate then either the ODU is drawing too much current, or the power wiring to the ODU is short circuit or the PSU is supplying insufficient power. The likely fault can be determined by removing the jumper (J906), found inside the removable cover of the PIDU Plus, and measuring the current taken with an ammeter placed across the 2 jumper pins. This is normally 10mA without the ODU connected and 300mA to 1A when the ODU is connected.

If it does not illuminate then recheck that power is applied to the PIDU Plus by measuring the voltage across +55V and 0V pads inside the removable cover in the PIDU Plus. Check that the PIDU Plus is not short circuit by measuring the impedance across the Power connector. Is the led faulty?

10.1.2 Ethernet

The Ethernet LED is driven from the ODU processor and thus is capable of informing you of many conditions using different flash sequences. If the Ethernet indicator does not illuminate at all there are four possible conditions.

1. There is no power reaching the ODU because of a wiring fault
2. The ODU is faulty
3. The PIDU Plus is faulty
4. The Ethernet network side is faulty

Look at the following table to check the LED response for power up, disconnect the power and reapply and note what happens.

²¹ The power indicator LED should be continually illuminated.

Fault Finding

Differentiating between 1-3 and 4 can be achieved by removing the power for 1 second. Watch the Ethernet indicator for 1 minute while power is removed, if it never flashes then the problem is 1-3. Take the jumper (J905) out of the PIDU Plus and check the current taken by the ODU. This should be 300mA to 1A when starting to run normally.

If the Ethernet indicator flashes to begin with but then stops flashing, the ODU is powered and software loaded but Ethernet connectivity has been lost between the ODU and the users connected equipment. All Ethernet connections should be rechecked.

Power Indoor Unit LED check chart:

Mode	Green LED	Yellow LED No Ethernet Cable Connected	Yellow LED Ethernet Cable Connected between PIDU Plus and NIC/Switch/Hub
No Power Applied	Off	Off	Off
Power Applied	On	Will flash once per second regularly approximately 30 seconds after power applied for 10 seconds then will go out and stay out	Will flash once per second regularly approximately 30 seconds after power applied for 10 seconds then operate as Ethernet Link/Activity LED
Valid Ethernet Link and no traffic	On	N/A	Will be on solid for a valid link.
Valid Ethernet Link with traffic	On	N/A	Will be on solid, but will blink randomly as traffic passes through.
Recovery Switch Pressed and held for greater than 10 seconds from power on (Recovery is pressed while power is applied)	On	Off while switch pressed. Approximately 30 seconds after releasing the switch, flashes twice per second regularly for 10 seconds, then boots in "Recovery Mode" While in "Recovery Mode" the unit will only be accessible via the IP address 10.10.10.10 or 169.254.1.1.	

10.1.3 Checking your wiring

If the above procedures fail to diagnose the issue you may have a wiring fault. Unplug the RJ45 from the PIDU+ and check the following resistances at the RJ45:

1. Check the cable resistance between pins 1 & 2, 3 & 6, 4 & 5 and 7 & 8 at the RJ45.
2. Check against column 2 in **Table 17**. Resistances for each pair should be within 1 ohm of each other.

Fault Finding

3. Check the cable resistance between pins 1 & 3 at the RJ45. Check against column 3 in **Table 17**.
4. Check the cable resistance between pins 4 & 7 at the RJ45. Check against column 4 in **Table 17**.
5. Ensure that there is greater than 100K ohms between pins 1 & 8 for all cable lengths.
6. Ensure that there is greater than 100K ohms between pin 1 and ODU ground for all cable lengths.
7. Ensure that there is greater than 100K ohms between pin 8 and ODU ground for all cable lengths

10.2 Radio

10.2.1 No Activity

If communication over the radio link has been lost and the unit at the other end of the link can be managed on its local network, the following procedure should be adopted: If there is no wireless activity then the configuration should be checked. It is essential that the following items are correct:

- Check for Alarm conditions on Home page
- Check that the software at each end of the link is the same version
- Check that the Target Mac address has not been misconfigured at each end of the link
- Check Range
- Check Tx Power
- Check License keys to ensure that both units are the same product variant
- Check Master/Slave status for each unit and ensure that one unit is Master and the other unit is slave
- Check that the link has not been further obscured or the ODU misaligned
- Check the DFS page at each end of the link and establish that there is a quiet wireless channel to use If there are no faults found in the configuration and there is absolutely no wireless signal retry the installation procedure. If this doesn't work then the ODU may be faulty.

10.2.2 Some Activity

If there is some activity but the link is unreliable or doesn't achieve the data rates required then:

- Check that the interference has not increased using the i-DFS measurements
- If a quieter channel is available check that it is not barred
- Check that the path loss is low enough for the communication rates required
- Check that the ODU has not become misaligned

11 Lightning Protection

EMD (Lightning) damage is not covered under standard warranty. The recommendations in this user manual when installed correctly give the user the best protection from the harmful effects of EMD. However 100% protection is neither implied nor possible.

11.1 Overview

The idea of lightning protection is to protect structures, equipment and people against lightning by conducting the lightning current to ground via a separate preferential solid path.

The following should be treated as a guide only, the actual degree of lightning protection required depends on local conditions and weather patterns and applicable local regulations.

Full details of lightning protection methods and requirements can be found in the international standards IEC 61024-1 and IEC 61312-1, the U.S. National Electric Code ANSI/NFPA No. 70-1984 or section 54 of the Canadian Electric Code.

11.1.1 Lightning Protection Zones

The installation of the ODU can be classified into two different lightning protection zones.

Zone A - In this zone a direct lightning strike is possible. Zone B - In this zone a direct lightning strike is unusual, but the full electromagnetic field is still present.

The zones are determined using the 'rolling sphere method', an imaginary sphere, typically 50 meter in radius is rolled over the structure. All structure points that contact the sphere, (Zone A) indicate the zone where a direct strike is possible. Similarly points that do not contact the sphere indicate a zone (zone B) where a direct strike is less likely.

The following diagrams (**Figure 94** and **Figure 95**) show this zoning pictorially:

Equipment mounted in Zone A should be capable of carrying the full lightning current. Mounting of the ODU in Zone A is not recommended. Mounting in Zone A should only be carried out observing the rules governing installations in Zone A²². Failure to do so may put structures, equipment and life at risk.

Equipment mounted in Zone B should be grounded using grounding wire of at least 10 AWG. This grounding wire should be connected to a grounding rod or the building grounding system before entry in to building.

The PTP 500 Series bridge ODU grounding point can be found on the bottom of the unit. The 600 Series Bridge is supplied with an appropriate grounding lug for attachment to the ODU.

²² Local regulations may also require the fitting of the 8 AWG ground wire referred below.

Lightning Protection

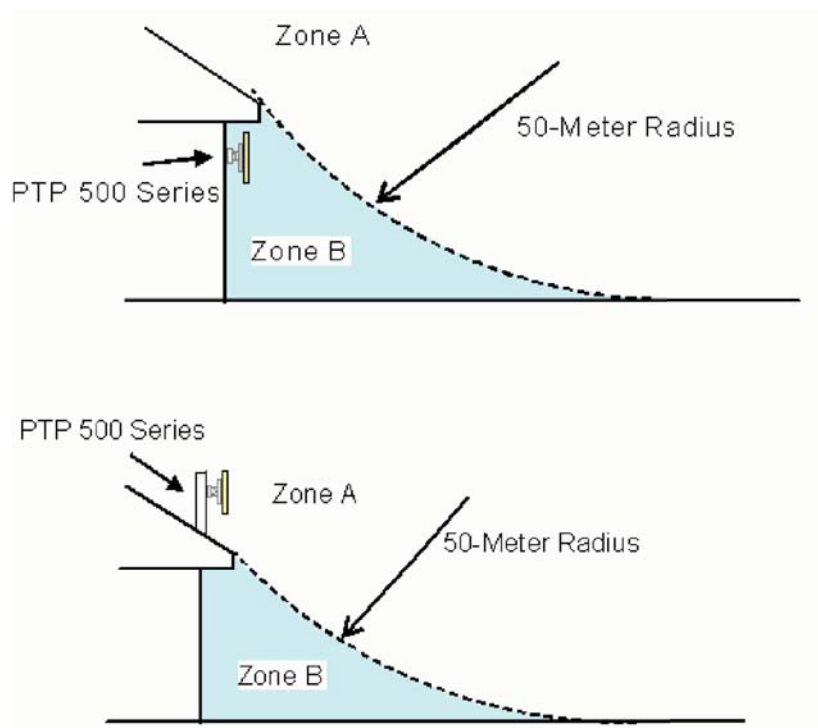

Figure 94 ODU mounted in Zones A and B

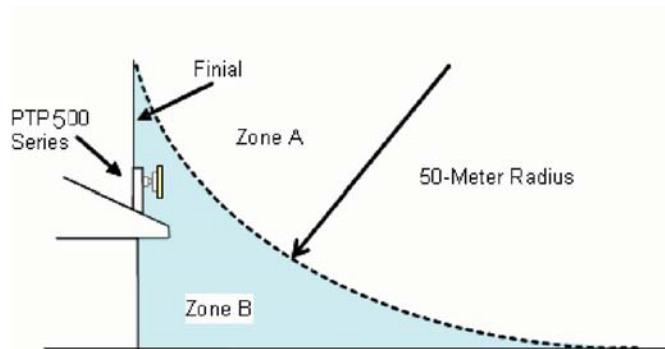

Figure 95 Showing how the use of a Finial enables the ODU to be mounted inside Zone B

Lightning Protection

	Zone A	Zone B
Earth ODU	Mandatory	Mandatory
Screen Cable	Mandatory	Mandatory
Lightning protection Unit at ODU - PTP-LPU	Mandatory	Mandatory
Earth Cable at Building Entry	Mandatory	Mandatory
Lightning protection Unit at Building Entry - PTP-LPU	Mandatory	Mandatory

Table 16 Protection Requirements

11.2 Detailed Installation

The recommended components for an installation protected for nearby strikes are:

- Recommended cables as described in **Section 3.3.5**.
- Lightning protection: Motorola PTP-LPU - 2 per link (2 Motorola Kits, part number 2978)
- Grounding Stake
- RJ45 screened connectors



NOTE: There may be a local regulatory requirement to cross bond the CAT 5e cable at regular intervals to the mast. This may be as frequent as every 10 meters (33 feet).

Figure 96 includes illustrations showing the placement of the PTP lightning protection units and the recommended components for typical Mast/Tower or Wall installations.

Lightning Protection

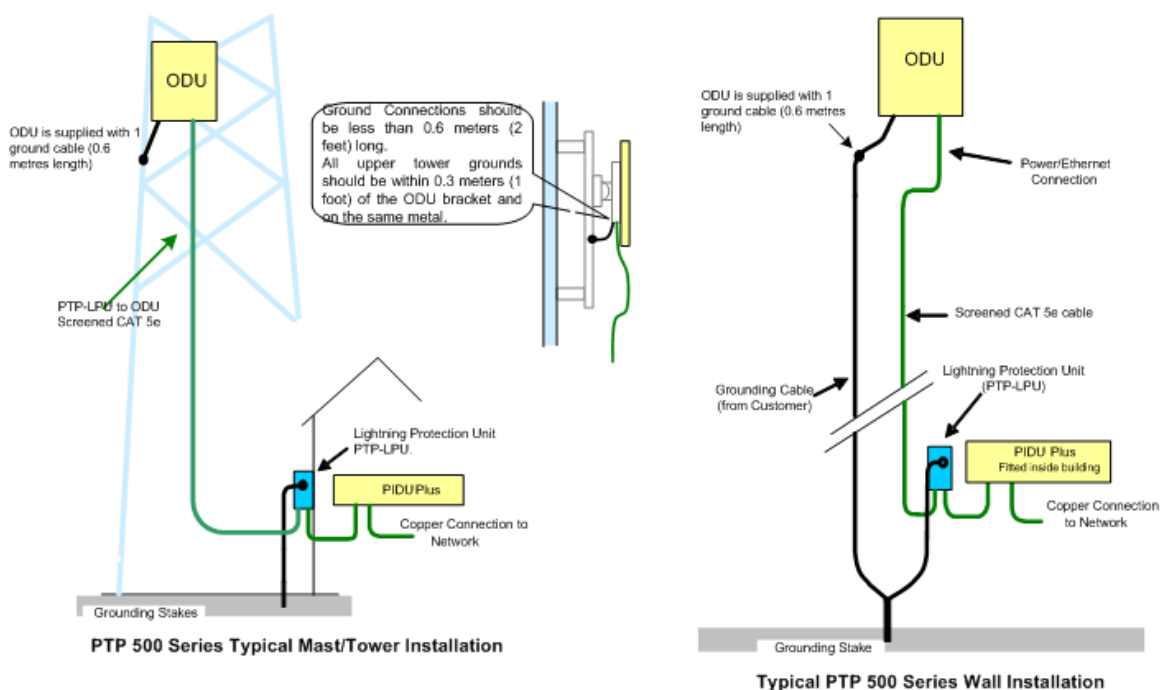

Figure 96 Diagrammatically Showing Typical Mast and Wall Installations

The Lightning protection Unit should be mounted at the building entry point and must be grounded.

Figure 97 shows all the components that are supplied with the Motorola Kit 2978.

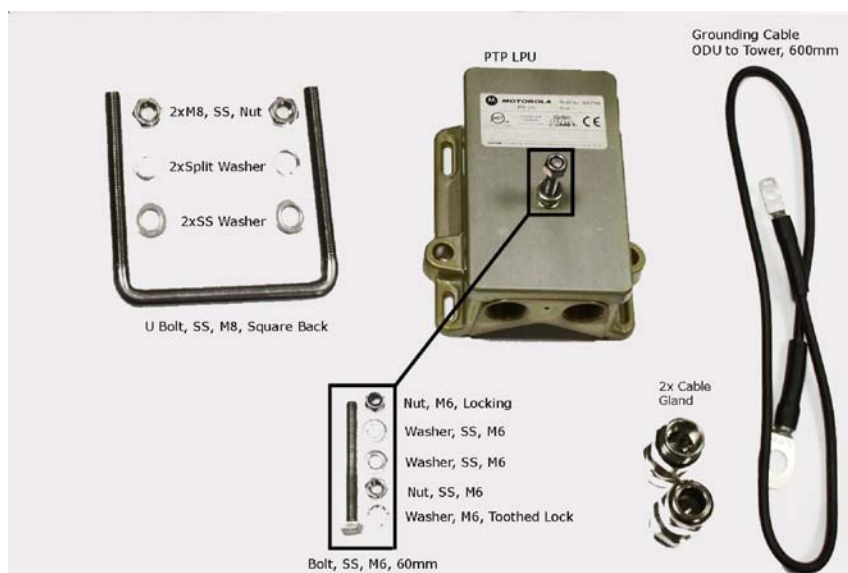

Figure 97 PTP LPU End Kit

11.3 Testing Your Installation

If you have followed the above instructions you will have wired your system to the following diagram:

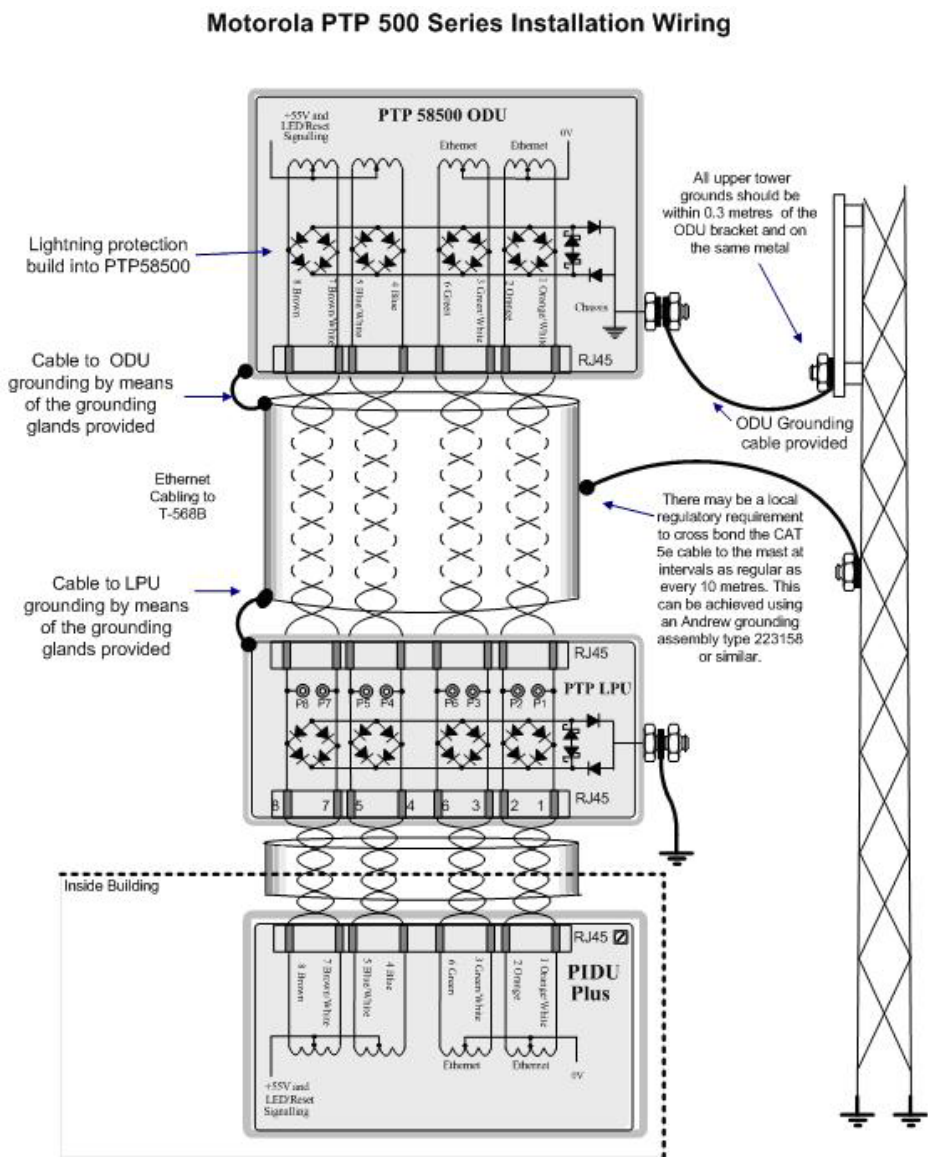

Figure 1 Motorola PTP 500 Series Simplified Circuit and Grounding requirements

Figure 98 Simplified Circuit Diagram

11.3.1 Pre-Power Testing

Before plugging the RJ45 from the lower LPU (or if not fitted the ODU) into the PIDU, check the following resistances at the RJ45:

1. Check the cable resistance between pins 1&2, 3&6, 4&5 and 7&8 at the RJ45. Check against column 2 in **Table 17**. Resistances for each pair should be within 1 ohm of each other.
2. Check the cable resistance between pins 1&3 and 4&7 at the RJ45. Check against columns 3 and 4 respectively in **Table 17**.
3. Ensure that there is greater than 100K ohms between pins 1&8 for all cable lengths.
4. Ensure that there is greater than 100K ohms between pin 1 and ODU ground for all cable lengths.
5. Ensure that there is greater than 100K ohms between pin 8 and ODU ground for all cable lengths.

CAT-5 Length (Meters)	Resistance between pins 1&2, 3&6 , 4&5 and pins 7&8 (ohms)	Resistance between pins 1&3 (ohms)	Resistance between pins 4&7 (ohms)
0	0.8	1.0	1.6
10	2.5	2.7	3.3
20	4.2	4.4	5.0
30	5.9	6.1	6.7
40	7.6	7.8	8.4
50	9.3	9.5	10.1
60	11.0	11.2	11.8
70	12.7	12.9	13.5
80	14.4	14.6	15.2
90	16.1	16.3	16.9
100	17.8	18.0	18.6

Table 17 Resistance Table Referenced to the RJ45 at the PIDU Plus

11.3.2 Post-Power Testing

The Correct Operation is as follows:

Lightning Protection

1. Connect the RJ45 to the PIDU and apply power to the PIDU, the power LED should illuminate continuously.
2. 30 seconds after powering, the Ethernet LED should be observed starting with 10 slow flashes.
3. If there is a network connection the Ethernet LED will then show Ethernet activity.

If the system does not operate correctly, refer to the fault finding below.

The PIDU Green power LED does not illuminate Unplug the ODU connection from the PIDU and check the power LED illumination. If the power LED still does not light then check the power source.

The PIDU Green power LED flashes A flashing power LED indicates that there is a short circuit on the output of the PIDU. Check that pins 4&5 and 7&8 are not crossed with pins 1&2 and 3&6 on the RJ45, and also greater than 100K ohms between pins 1&8.

The Ethernet LED flashes ten times but does not show Ethernet activity Failure of the Ethernet LED to show Ethernet activity can be due to wiring to pins 1&2 and 3&6 being incorrect, for example if the wiring to pins 1 and 3 are crossed.

The Ethernet connection to the network is only 10/100BaseT, when 1000BaseT was expected It is likely there is a fault with the wiring to pins 4&5 and 7&8.

11.4 Locating the Fault

Having identified which of the wiring cores are likely to be connected incorrectly, the location of the faulty cable can be narrowed by disconnecting sections of the drop cable and by unplugging the relevant RJ45 connectors from the LPUs.

As a further aid to locating the fault the Ethernet connections are also available inside the LPU. The connections can be accessed by rotating the LPU lid as shown in **Figure 99** The Lid nut only needs to be slacken, do not remove. Test point P1 on the LPU PCB corresponds to pin 1 on the RJ45 etc.

An indication of power on the Ethernet cable is also provided inside the LPU, LED PWR1 will illuminate in the case of the PTP600 series, LED PWR2 should not.

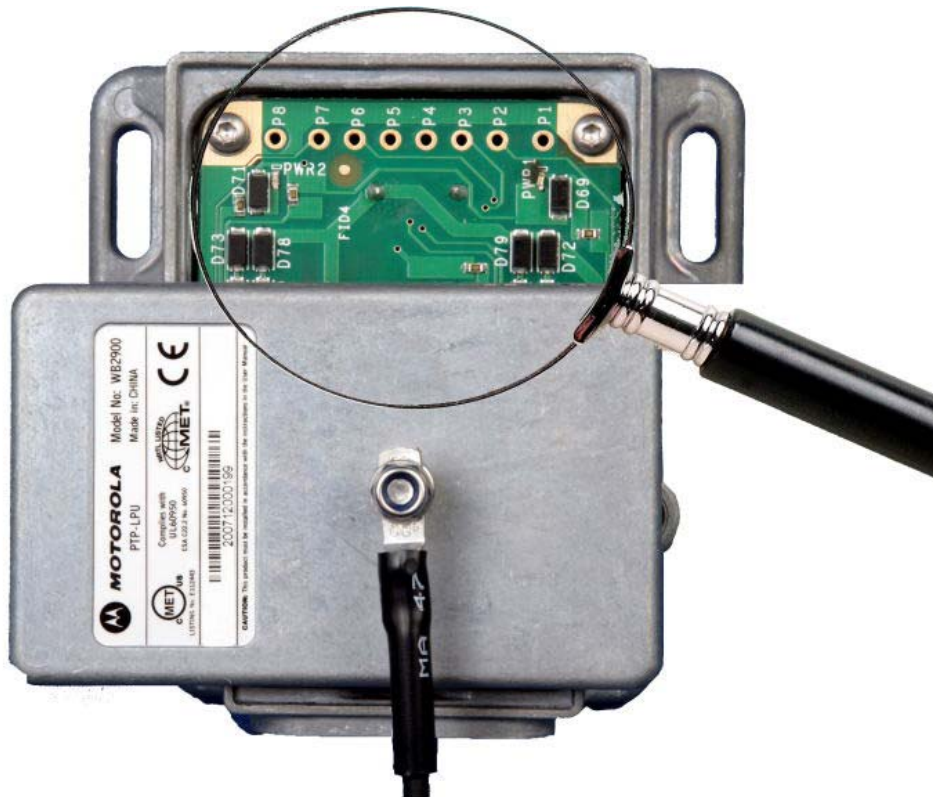

Figure 99 PTP LPU test Points

12 Wind Loading

12.1 General

Antennas and electronic equipment mounted on towers or pole mounted on buildings will subject the mounting structure to significant lateral forces when there is appreciable wind. Antennas are normally specified by the amount of force (in pounds) for specific wind strengths.

The magnitude of the force depends on both the wind strength and size of the antenna.

12.2 Calculation of Lateral Force

The 500 Series bridge with or without the integral antenna is essentially a flat structure and so the magnitude of the lateral force can be estimated from:

$$\text{Force (in pounds)} = 0.0042 \cdot A \cdot v^2$$

Where A is the surface area in square feet and v is the wind speed in miles per hour.

The lateral force produced by a single 500 Series bridge (integrated or connectorized model) at different wind speeds is shown in **Table 18** and **Table 19**.

	Largest Surface Area (sq ft)	Lateral Force (Pound) at wind speed (mph)				
		80	100	120	160	200
PTP 500 Series Bridge - Integrated	1.36	27	41	57	101	164
PTP 500 Series Bridge - Connectorized	1.00	27	42	60	98	N/A

Table 18 Lateral Force – Imperial

	Largest Surface Area (sq m)	Lateral Force (Kg) at wind speed (m/s)				
		30	40	50	60	70
PTP 500 Series Bridge - Integrated	0.130	12	22	34	49	66
PTP 500 Series Bridge - Connectorized	0.093	9	16	24	35	48

Table 19 Lateral Force – Metric



Note: When the connectorized version of 500 Series bridge is used with external antennas, the figures from the antenna manufacturer for lateral force should be included to calculate to total loading on the mounting structure.

12.3 Capabilities of the PTP 500 Series Bridges

The structure and mounting brackets of the PTP Series systems are capable of withstanding wind speeds up to 151mph (242 kph). The installer should ensure that the structure to which the 500 Series Bridge is fixed to is also capable of withstanding the prevalent wind speeds and loads.

12.4 Wind Speed Statistics

Installers are recommended to contact the national meteorological office for the country concerned to identify the likely wind speeds prevalent at the proposed location. This will enable the installer to estimate the total wind loading on the support structures.

Examples of the sort of statistics that are available are:

USA - Reported Fastest Single Wind Velocities for Selected U.S. Cities (Source: National Weather Service)

City, State	Wind Velocity (mph)
Bismark, North Dakota	72
Buffalo, New York	91
Chicago, Illinois	87
Hatteras, North Carolina	110
Miami, Florida	132
New York, New York	99
Pensacola, Florida	114

UK Meteorological Office, <http://www.met.gov.uk>

Peak wind speed contour maps can be found as Fig 3a/3b at:

<http://www.met.gov.uk/education/historic/1987.html>

13 PTP 500 Series Bridge - Connectorized Model

13.1 Scope

This section details the changes and additional features relevant to the connectorized version of the PTP 500 Series products..

13.2 Product Description

13.2.1 Hardware

The Connectorized PTP 500 Series Bridge is a variant designed to provide the system integrator and installer with the ability to provide extra capability to cope with very difficult radio links compared to the PTP 500 Series Integrated model. The variant allows the use of a variety of externally mounted antennas, either Flat Plate or Dish, which have higher gains than provided by the integrated antenna that is normally used.



Figure 100 Connectorized 500 Series Bridge Outdoor Unit

13.2.2 Antenna Choices – 5.8 GHz

The integrated antenna has a gain of 23.5 dBi.

In non-FCC regions antenna choice is not restricted but any region specific EIRP limit must be obeyed by reducing the maximum Transmit power²³, see Table 6 in **Section 5.2** “Region Codes”.

In FCC regions external antennas from the list in **Section 13.6.3** “Antennas for USA / Canada – 5.8 GHz” can be used with the Connectorized version of the 500 Series Bridge. These are approved by the FCC for use with the product and are basically constrained by the following limits:

- Single Polarization Flat Plate Antennas – up to 28 dBi per antenna.
- Single/Dual Polarization Parabolic Dish Antennas – up to 37.7 dBi per polarization or antenna.

In FCC regions when using external antennas – cable loss between the connectorized version of the 500 Series Bridge and the antenna ports must not be less than 1.2 dB.

13.2.3 Antenna Choices – 5.4 GHz

The integrated antenna has a gain of 23.5 dBi.

In FCC regions external antennas from the list in **Section 13.2.3** “Antenna Choices – 5.4 GHz” can be used with the Connectorized version of the 500 Series Bridge. These are approved by the FCC for use with the product and are basically constrained by the following limits:

- Single/Dual Polarization Parabolic Dish Antennas – up to 34.6 dBi per polarization or antenna.

However, the Maximum Transmit Power must be reduced to avoid exceeding the EIRP limits. In FCC regions when using external antennas – cable loss between the connectorized version of the 500 Series Bridge and the antenna ports must not be less than 1.2 dB.

13.3 Software/Features

The connectorized variant operates in the same way as the basic 500 Series and is released initially with the feature set to the Connectorized 500 Series variant. The areas where the functionality is modified are:

13.3.1 Status Page

The link loss calculation presented on the Status Page of the management interface has to be modified to allow for the increased antenna gains at each end of the link. The manufacturing process of the Connectorized 500 Series Bridge configures the standard hardware of the unit for use with external antennas. The installer is prompted, as part of the installation process, to enter the gain of the external antenna(s) and cable losses at each end of the link.

Peer-to-peer messaging is used to pass the effective antenna gain to each end of the link so that the link loss calculations can be correctly computed.

²³ Maximum Transmit Power Allowed = EIRP Limit – Antenna Gain + Cable Losses; set the power to the 1dB value lower than the actual value calculated.

PTP 500 Series Bridge - Connectorized Model

Equipment			Wireless			
Attributes	Value	Units	Attributes	Value	Units	
Link Name	Master 5.8GHz G4		Wireless Link Status	Up		
Link Location			Maximum Transmit Power	5	dBm	
Software Version	Recovery-B553+ lwdog		Remote Maximum Transmit Power	15	dBm	
Hardware Version	D00-R02.00-I		Transmit Power	5.0, 5.0, 5.0, 5.0	dBm	
Region Code	Region Code 7		Receive Power	-36.4, -47.7, -110.0, -46.1	dBm	
Elapsed Time Indicator	00:04:15		Vector Error	2.7, -18.4, -56.4, -19.3	dB	
Ethernet / Internet			Link Loss	98.1, 91.7, 0.0, 98.1	dB	
Ethernet Link Status	Copper Link Up		Transmit Data Rate	52.52, 46.55, 0.00, 52.52	Mbps	
Ethernet Speed And Duplex	100 Mbps Full Duplex		Receive Data Rate	2.02, 1.81, 0.00, 2.02	Mbps	
MAC Address	00:04:56:10:00:96		Link Capacity	78.26	Mbps	
Remote IP Address	10.10.10.11		Transmit Modulation Mode	64QAM 0.83 (Dual) (15 MHz)		
			Receive Modulation Mode	BPSK 0.50 (15 MHz)		
			Receive Modulation Mode Detail	Restricted Because Installation Is Armed		
			Range	0.2	km	
Automatic page refresh period in seconds	<input type="text" value="3600"/>	Seconds	<input type="button" value="Update Page Refresh Period"/> <input type="button" value="Reset form"/>			

Figure 101 Connectorized 500 Series bridge Status Page

13.3.2 Configuration Pages

The amended Configuration web page is shown below as **Figure 102**. Please refer to **Section 8.3.4** for the definitions of the parameters Antenna Gain, Cable Loss and EIRP.

Equipment		
Attributes	Value	Units
Link Name	<input type="text" value="Master 5.8GHz G4"/>	
Link Location	<input type="text"/>	
Master Slave Mode	Master	
Link Mode Optimization	IP Traffic	
Max Receive Modulation Mode	<input type="text" value="BPSK 0.50"/>	
Max Transmit Power	<input type="text" value="5"/>	dBm
Antenna Gain	<input type="text" value="23.0"/>	dBi
Cable Loss	<input type="text" value="0.0"/>	dB
EIRP	28.0	dBm
<input type="button" value="Submit Updated System Configuration"/> <input type="button" value="Reset Form"/>		

Figure 102 Connectorized 500 Series bridge 'System Configuration' Page

13.3.3 Installation Pages

The installer is prompted to enter the Antenna Gain and Cable Loss (Connectorized PTP 500 Series Bridge to antenna) at each end of the link. The Installation Page(s) is shown as **Figure 103** to **Figure 105**.

Step 2: Wireless Configuration

Please enter the following wireless configuration parameters

Wireless data entry

Attributes	Value	Units
Target MAC Address	00:04:56: <input style="width: 40px;" type="text" value="10"/> : <input style="width: 40px;" type="text" value="00"/> : <input style="width: 40px;" type="text" value="a0"/>	
Master Slave Mode	<input checked="" type="radio"/> Master <input type="radio"/> Slave	
Link Mode Optimization	<input checked="" type="radio"/> IP Traffic <input type="radio"/> TDM Traffic	
Tx Max Power	<input style="width: 60px;" type="text" value="5"/>	dBm
Platform Variant	<input type="radio"/> Integrated Antenna <input checked="" type="radio"/> Connectorized	
Antenna Gain	<input style="width: 60px;" type="text" value="23.0"/>	dBi
Cable Loss	<input style="width: 60px;" type="text" value="0.0"/>	dB
Channel Bandwidth	<input checked="" type="radio"/> 15 MHz	
Spectrum Management Control	<input type="radio"/> i_DFS <input checked="" type="radio"/> Fixed Frequency	
Default Raster	<input checked="" type="radio"/> On <input type="radio"/> Off	
Fixed Tx Frequency	<input style="width: 60px;" type="text" value="5735"/> ▾	MHz
Fixed Rx Frequency	<input style="width: 60px;" type="text" value="5735"/> ▾	MHz
Installation Tones	<input checked="" type="radio"/> Disabled <input type="radio"/> Enabled	

◀ Back
Next ▶

Figure 103 Connectorized PTP 500 Series Bridge ‘Installation Wizard’ Page

Antenna Gain:Gain of the antenna you are connecting to the unit, see table in **Section 13.2.3** “Antenna Choices – 5.4 GHz”.

Cable Loss:Loss in the cable between the ODU and the antenna. Note: In the event that there is a significant difference in length of the antenna cables for the two antenna ports, then the average value should be entered.

Spectrum Management Control: Is used to configure the 500 Series Bridge Spectrum Management features, see [Section 8.3.7](#) for more details. iDFS is the abbreviation for intelligent Dynamic Frequency Selection, which continually monitors the spectrum looking for the channel with the lowest level of on channel and co-channel interference. Fixed frequency mode allows the installer to fix the Transmit and receive frequencies on the units. The frequencies may be configured symmetrically or asymmetrically.

Step 3: Confirm Installation Configuration

Please review your entered configuration. If any of the configuration items are incorrect please use the back button to apply the corrections.

Once you're happy with the configuration press the 'Confirm Configuration, Arm Installation Agent and Reboot' button, this will commit the parameters to non-volatile memory and reboot this wireless unit.

Installation configuration

Attributes	Value	Units
IP Address	10.10.10.10	
Subnet Mask	255.255.255.0	
Gateway IP Address	10.10.10.111	
Use VLAN For Management Interfaces	Disabled	
Target MAC Address	00:04:56:10:00:a0	
Master Slave Mode	Master	
Link Mode Optimization	IP Traffic	
Tx Max Power	5	dBm
Platform Variant	Connectorized	
Antenna Gain	23.0	dBi
Cable Loss	0.0	dB
EIRP	28.0	dBm
Channel Bandwidth	15 MHz	
Spectrum Management Control	Fixed Frequency	
Fixed Transmit Frequency	5735	MHz
Fixed Receive Frequency	5735	MHz
Installation Tones	Disabled	

Confirm Configuration, Arm Installation Agent and Reboot

◀◀ **Back**

Figure 104 Connectorized 500 Series bridge 'Confirm Installation' Page

EIRP:The Confirm Installation Page displays the EIRP (Effective Isotropic Radiated Power), which describes the strength of the radio signal leaving the wireless unit. This allows the operator to verify that their link configuration (Max Transmit Power, Antenna Gain and Cable Loss) do not cause the link to exceed any applicable regulatory limit.

Disarm Installation

The installation agent is armed. If you wish to disarm installation then use the 'Disarm Installation Agent' button. If you wish to reconfigure the installation agent then use the wizards 'back' button

Installation configuration

Attributes	Value	Units
IP Address	10.10.10.10	
Subnet Mask	255.255.255.0	
Gateway IP Address	10.10.10.111	
Use VLAN For Management Interfaces	Disabled	
Target MAC Address	00:04:56:10:00:a0	
Master Slave Mode	Master	
Link Mode Optimization	IP Traffic	
Tx Max Power	5	dBm
Platform Variant	Connectorized	
Antenna Gain	23.0	dBi
Cable Loss	0.0	dB
EIRP	28.0	dBm
Channel Bandwidth	15 MHz	
Spectrum Management Control	Fixed Frequency	
Fixed Transmit Frequency	5735	MHz
Fixed Receive Frequency	5735	MHz
Installation Tones	Disabled	

◀ Back

Figure 105 Connectorized 500 Series bridge 'Disarm Installation' Page

13.4 Deployment Considerations

The majority of radio links can be successfully deployed with the 500 Series. It should only be necessary to use external antennas where the Link Estimator indicates marginal performance for a

specific link – for example when the link is heavily obscured by dense woodland on an NLOS link or extremely long LOS links (>80km or >50 miles) over water.

The external antennas can be either dual-polarization (as the integrated antenna) or two single polarized antennas can be used in a spatially diverse configuration. It is expected that the dual-polarization antennas would normally be used to simplify the installation process; spatially diverse antennas may provide additional fade margin on very long LOS links where there is evidence of correlation of the fading characteristics on Vertical and Horizontal polarizations.

Dual polarization antennas (with a gain greater than the integrated antenna) are currently only available in parabolic dish form.

13.5 Link Budget

An estimate of the link budget for a specific application can be obtained by using the Motorola Systems link estimation tools. For more information see the Motorola web site.

13.6 Regulatory Issues

Installations must conform to any applicable local regulations for the Equivalent Isotropic Radiated Power (EIRP).

Ensuring compliance becomes more complex when the connectorized unit is used with external antennas which may be locally sourced. With higher gain external antennas fitted, the Maximum Transmit power may need to be reduced for operation in specific countries.

See table in **Section 5.2** for any EIRP restrictions that may apply in your region.

In some regions, operation of the PTP54500 products is constrained by an EIRP limit. The normal constraint is that the EIRP does not exceed 30 dBm (33 dBm for PTP58500) for radio signals with a bandwidth of ≥ 20 MHz. As the PTP54500 operating bandwidth is approximately 27 MHz, then the limit is 30 dBm EIRP (33 dBm for PTP58500).

When operating with external antennas, the installer/operator has to set the maximum transmit power to ensure that the EIRP limit is not exceeded. The Set_Max_Transmit_Power is calculated as below:

Set_Max_Transmit_Power = [Max_Transmit_Power] rounded down to nearest lower dB.

13.6.1 Antenna Choice (FCC and Industry Canada Regions Only)

The antennas which can be deployed with the Connectorized 500 Series Bridge are shown in **Section 13.6.3** “Antennas for USA / Canada – 5.8 GHz” and **Section 13.6.4** “Antennas for USA / Canada – 5.4 GHz”.

For FCC and Industry Canada, the PTP500 Series Bridge has been designated to operate with the antennas listed in **Section 13.6.3** “Antennas for USA / Canada – 5.8 GHz” and **Section 13.6.4** “Antennas for USA / Canada – 5.4 GHz”, and having a maximum gain of 37.7 dB (34.9 dB for 5.4 GHz product variant). Antennas not included in these tables or having a gain greater than 37.7 dB (34.9 dB for 5.4 GHz product variant) are strictly prohibited for use with this device. The required antenna impedance is 50 ohms.

13.6.2 Cable Losses (FCC Regions Only)

The FCC approval for the product is based on tests with a cable loss between the units of approximately 1.2dB at 5.8GHz. The use of lower cable losses would result in the installation being outside the FCC rules.

As an indication, 1.2dB of cable loss corresponds to the following cable lengths excluding connector losses (source: Times Microwave).

Cable	Length for 1.2dB Cable Loss at 5.8GHz	
	(ft)	(m)
LMR100	1.9	0.6
LMR200	4.6	1.4
LMR300	7.25	2.2
LMR400	11.1	3.4
LMR600	16.5	5.0

Table 20 Cable Losses per Length

PTP 500 Series Bridge - Connectorized Model

13.6.3 Antennas for USA / Canada – 5.8 GHz

Manufacturer	Antenna Type	Gain (dBi)	Flat Plate	Parabolic Dish
Andrew	Andrew 1-foot Flat Panel, FPA5250D12-N (23.6dBi)	23.6	Y	
Andrew	Andrew 2-foot Flat Panel, FPA5250D24-N (28dBi)	28	Y	
Gabriel	Gabriel 1-foot Flat Panel, DFPD1-52 (23.5dBi)	23.5	Y	
Gabriel	Gabriel 2-foot Flat Panel, DFPD2-52 (28dBi)	28	Y	
MTI	MTI 17 inch Diamond Flat Panel, MT-485009 (23dBi)	23	Y	
MTI	MTI 15 inch Dual-Pol Flat Panel, MT-485025/NVH (23dBi)	23	Y	
MTI	MTI 2 ft Directional Flat Panel, MT-20004 (28dBi)	28	Y	
MTI	MTI 2 ft Flat Panel, MT-485001 (28dBi)	28	Y	
RFS	RFS 1-foot Flat Panel, MA0528-23AN (23dBi)	23	Y	
RFS	RFS 2-foot Flat Panel, MA0528-28AN (28dBi)	28	Y	
Teletronics	Teletronics 2-foot Flat Plate Antenna, ANT-P5828 (28dBi)	28	Y	
Andrew	Andrew 2-foot Parabolic, P2F-52 (29.4dBi)	29.4		Y
Andrew	Andrew 2-foot Dual-Pol Parabolic, PX2F-52 (29.4dBi)	29.4		Y
Andrew	Andrew 3-foot Parabolic, P3F-52 (33.4dBi)	33.4		Y
Andrew	Andrew 3-foot Dual-Pol Parabolic, PX3F-52 (33.4dBi)	33.4		Y
Andrew	Andrew 4-foot Parabolic, P4F-52 (34.9dBi)	34.9		Y
Andrew	Andrew 4-foot Dual-Pol Parabolic, PX4F-52 (34.9dBi)	34.9		Y
Andrew	Andrew 6-foot Parabolic, P6F-52 (37.6dBi)	37.6		Y
Andrew	Andrew 6-foot Dual-Pol Parabolic, PX6F-52 (37.6dBi)	37.6		Y

PTP 500 Series Bridge - Connectorized Model

Manufacturer	Antenna Type	Gain (dBi)	Flat Plate	Parabolic Dish
Gabriel	Gabriel 2-foot High Performance QuickFire Parabolic, HQF2-52-N	28.2		Y
Gabriel	Gabriel 4-foot High Performance QuickFire Parabolic, HQF4-52-N	34.4		Y
Gabriel	Gabriel 6-foot High Performance QuickFire Parabolic, HQF6-52-N	37.4		Y
Gabriel	Gabriel 2-foot High Performance Dual QuickFire Parabolic, HQFD2-52-N	28.1		Y
Gabriel	Gabriel 4-foot High Performance Dual QuickFire Parabolic, HQFD4-52-N	34.3		Y
Gabriel	Gabriel 6-foot High Performance Dual QuickFire Parabolic, HQFD6-52-N	37.3		Y
Gabriel	Gabriel 2-foot Standard QuickFire Parabolic, QF2-52-N	28.5		Y
Gabriel	Gabriel 2-foot Standard QuickFire Parabolic, QF2-52-N-RK	28.5		Y
Gabriel	Gabriel 2.5-foot Standard QuickFire Parabolic, QF2.5-52-N	31.2		Y
Gabriel	Gabriel 4-foot Standard QuickFire Parabolic, QF4-52-N	34.8		Y
Gabriel	Gabriel 4-foot Standard QuickFire Parabolic, QF4-52-N-RK	34.8		Y
Gabriel	Gabriel 6-foot Standard QuickFire Parabolic, QF6-52-N	37.7		Y
Gabriel	Gabriel 2-foot Standard Dual QuickFire Parabolic, QFD2-52-N	28.4		Y
Gabriel	Gabriel 2.5-foot Standard Dual QuickFire Parabolic, QFD2.5-52-N	31.1		Y
Gabriel	Gabriel 2-foot Standard Dual QuickFire Parabolic, QFD2-52-N-RK	28.4		Y
Gabriel	Gabriel 4-foot Standard Dual QuickFire Parabolic, QFD4-52-N	34.7		Y

PTP 500 Series Bridge - Connectorized Model

Manufacturer	Antenna Type	Gain (dBi)	Flat Plate	Parabolic Dish
Gabriel	Gabriel 4-foot Standard Dual QuickFire Parabolic, QFD4-52-N-RK	34.7		Y
Gabriel	Gabriel 6-foot Standard Dual QuickFire Parabolic, QFD6-52-N	37.7		Y
RadioWaves	Radio Waves 2-foot Dual-Pol Parabolic, SPD2-5.2 (28.1dBi)	28.1		Y
RadioWaves	Radio Waves 2-foot Parabolic, SP2-5.2 (29.0dBi)	29		Y
RadioWaves	Radio Waves 3-foot Dual-Pol Parabolic, SPD3-5.2 (31.1dBi)	31.1		Y
RadioWaves	Radio Waves 3-foot Parabolic, SP3-5.2 (31.4dBi)	31.4		Y
RadioWaves	Radio Waves 4-foot Dual-Pol Parabolic, SPD4-5.2 (34.4dBi)	34.4		Y
RadioWaves	Radio Waves 4-foot Parabolic, SP4-5.2 (34.8dBi)	34.8		Y
RadioWaves	Radio Waves 6-foot Dual-Pol Parabolic, SPD6-5.2 (37.5dBi)	37.5		Y
RadioWaves	Radio Waves 6-foot Parabolic, SP6-5.2 (37.7dBi)	37.7		Y
RadioWaves	Radio Waves 2-foot Parabolic, SP2-2/5 (28.3dBi)	28.3		Y
RadioWaves	Radio Waves 3-foot Parabolic, SP3-2/5 (31.4dBi)	31.4		Y
RadioWaves	Radio Waves 4-foot Parabolic, SP4-2/5 (34.6dBi)	34.6		Y
RadioWaves	Radio Waves 6-foot Parabolic, SP6-2/5 (37.7dBi)	37.7		Y
RFS	RFS 2-foot Parabolic, SPF2-52AN or SPFX2-52AN (27.9dBi)	27.9		Y
RFS	RFS 3-foot Parabolic, SPF3-52AN or SPFX3-52AN(31.4dBi)	31.4		Y

PTP 500 Series Bridge - Connectorized Model

Manufacturer	Antenna Type	Gain (dBi)	Flat Plate	Parabolic Dish
RFS	RFS 4-foot Parabolic, SPF4-52AN or SPFX4-52AN(33.9dBi)	33.9		Y
RFS	RFS 6-foot Parabolic, SPF6-52AN or SPFX6-52AN (37.4dBi)	37.4		Y
RFS	RFS 2-foot HP Parabolic, SDF2-52AN or SDFX2-52AN (31.4dBi)	31.4		Y
RFS	RFS 4-foot HP Parabolic, SDF4-52AN or SDFX4-52AN (33.9dBi)	33.9		Y
RFS	RFS 6-foot HP Parabolic, SDF6-52AN or SDFX6-52AN (37.4dBi)	37.4		Y
StellaDoradus	StellaDoradus 45 inch Parabolic Antenna, 58PSD113	33.8		Y

PTP 500 Series Bridge - Connectorized Model

13.6.4 Antennas for USA / Canada – 5.4 GHz

Manufacturer	Antenna Type	Gain (dBi)	Parabolic Dish
Andrew	Andrew 2-foot Parabolic, P2F-52 (29.4dBi)	29.4	Y
Andrew	Andrew 2-foot Dual-Pol Parabolic, PX2F-52 (29.4dBi)	29.4	Y
Andrew	Andrew 3-foot Parabolic, P3F-52 (33.4dBi)	33.4	Y
Andrew	Andrew 3-foot Dual-Pol Parabolic, P3F-52 (33.4dBi)	33.4	Y
Andrew	Andrew 4-foot Parabolic, P4F-52 (34.9dBi)	34.9	Y
Andrew	Andrew 4-foot Dual-Pol Parabolic, P4F-52 (34.9dBi)	34.9	Y
Gabriel	Gabriel 2-foot High Performance QuickFire Parabolic, HQF2-52-N	28.2	Y
Gabriel	Gabriel 4-foot High Performance QuickFire Parabolic, HQF4-52-N	34.4	Y
Gabriel	Gabriel 2-foot High Performance Dual QuickFire Parabolic, HQFD2-52-N	28.1	Y
Gabriel	Gabriel 4-foot High Performance Dual QuickFire Parabolic, HQFD4-52-N	34.3	Y
Gabriel	Gabriel 2-foot Standard QuickFire Parabolic, QF2-52-N	28.5	Y
Gabriel	Gabriel 2-foot Standard QuickFire Parabolic, QF4-52-N-RK	28.5	Y
Gabriel	Gabriel 2.5-foot Standard QuickFire Parabolic, QF2.5-52-N	31.2	Y
Gabriel	Gabriel 4-foot Standard QuickFire Parabolic, QF4-52-N	34.8	Y
Gabriel	Gabriel 4-foot Standard QuickFire Parabolic, QF4-52-N-RK	34.8	Y
Gabriel	Gabriel 2-foot Standard Dual QuickFire Parabolic, QFD2-52-N	28.4	Y
Gabriel	Gabriel 2.5-foot Standard Dual QuickFire Parabolic, QFD2.5-52-N	31.1	Y
Gabriel	Gabriel 2-foot Standard Dual QuickFire Parabolic, QFD2-52-N-RK	28.4	Y
Gabriel	Gabriel 4-foot Standard Dual QuickFire Parabolic, QFD4-52-N	34.7	Y

PTP 500 Series Bridge - Connectorized Model

Manufacturer	Antenna Type	Gain (dBi)	Parabolic Dish
Gabriel	Gabriel 4-foot Standard Dual QuickFire Parabolic, QFD4-52-N-RK	34.7	Y
RadioWaves	Radio Waves 2-foot Dual-Pol Parabolic, SPD2-5.2 (28.1dBi)	28.1	Y
RadioWaves	Radio Waves 2-foot Parabolic, SP2-5.2 (29.0dBi)	29	Y
RadioWaves	Radio Waves 3-foot Dual-Pol Parabolic, SPD3-5.2 (31.1dBi)	31.1	Y
RadioWaves	Radio Waves 3-foot Parabolic, SP3-5.2 (31.4dBi)	31.4	Y
RadioWaves	Radio Waves 4-foot Dual-Pol Parabolic, SPD4-5.2 (34.4dBi)	34.4	Y
RadioWaves	Radio Waves 4-foot Parabolic, SP4-5.2 (34.8dBi)	34.8	Y
RadioWaves	Radio Waves 2-foot Parabolic, SP2-2/5 (28.3dBi)	28.3	Y
RadioWaves	Radio Waves 3-foot Parabolic, SP3-2/5 (31.4dBi)	31.4	Y
RadioWaves	Radio Waves 4-foot Parabolic, SP4-2/5 (34.6dBi)	34.6	Y
RFS	RFS 2-foot Parabolic, SPF2-52AN or SPFX2-52AN (27.9dBi)	27.9	Y
RFS	RFS 3-foot Parabolic, SPF3-52AN or SPFX3-52AN (31.4dBi)	31.4	Y
RFS	RFS 4-foot Parabolic, SPF4-52AN or SPFX4-52AN (33.9dBi)	33.9	Y
RFS	RFS 2-foot HP Parabolic, SDF2-52AN or SDFX2-52AN (31.4dBi)	31.4	Y
RFS	RFS 4-foot HP Parabolic, SDF4-52AN or SDFX4-52AN (33.9dBi)	33.9	Y

13.7 Installation

The section covers the generic installation instructions for the Connectorized versions of the PTP 500 Series point-to-point wireless Ethernet bridges. The actual installation procedure will depend on antenna choice, cable choice, required antenna separation etc.

13.7.1 Antenna Choice

Section 13.6.3 “Antennas for USA / Canada – 5.8 GHz” and **Section 13.6.4** “Antennas for USA / Canada – 5.4 GHz” show a wide variety of antennas that can be used with the Connectorized PTP

500 Series bridge. The main selection criteria will be the required antenna gain. The secondary criteria should be the ease of mounting and alignment. For example the Radio Waves Parabolic dishes are supplied with a mount that allows adjustment for alignment independent of the actual antenna mounting. This type of antenna is much easier to align than those that have to be rotated around the mounting pole for alignment.

13.7.2 Cables and Connectors

Cables should be selected using the above criteria. However it should be noted that a cable of a type similar to LMR400 is a lot more difficult to handle and route than a cable of a type similar to LMR100. Motorola recommends the use of weatherproof connectors – preferably, ones that come supplied with adhesive lined heat shrink sleeve that is fitted over the cable/connector interface. The connectors required at the Connectorized 500 Series bridge end of the antenna cables are N-Type Male. The connectors required at the antenna end of the antenna cables is dependant on the antenna type chosen.

13.7.3 Tools

The tools required for mounting a Connectorized 500 Series bridge unit are the same as those required for an Integrated 500 Series bridge detailed in **Section 7.3**. The tools required for mounting the antennas are specific to the antenna chosen. The installer should refer to the antenna manufacturer’s instructions.

13.7.4 Miscellaneous supplies

The following miscellaneous supplies will be required:

- Cable ties, cable cleats – for securing cables
- Self-amalgamating tape – to weatherproof the RF connectors
- PVC tape – for additional protection of the RF connectors and securing cables

13.7.5 Mounting the Connectorized 500 Series Bridge

A Connectorized 500 Series bridge is shipped with the same bracket as supplied with an Integrated unit. Details on the use of this bracket can be found in **Section 3.3.7**. The 500 Series Bridge should be mounted in a position that gives it maximum protection from the elements, but still allows easy access for making off the various connections and applying the recommended weatherproofing.

When using dual polar antennas the Connectorized 500 Series bridge should be mounted in such a position as to minimize the cable length, keeping losses to a minimum (taking into account the minimum cable lengths required by the FCC regulations, see **Section 13.6.3** “Antennas for USA / Canada – 5.8 GHz” .

When using separate antennas the Connectorized 500 Series Bridge should be mounted in such a position as to minimize both cable runs between the unit and the antennas. It is not necessary to mount the Connectorized 500 Series Bridge at the mid point between the antennas.

13.7.6 Mounting the antennas

The Antennas should be mounted according to the manufacturer's instructions. Actual antenna position will depend on the available mounting positions and link requirements. It may be necessary to mount the antennas 20m apart or at a certain distance from the ground to get the desired results.

13.7.7 Alignment Process

When aligning antennas deployed with a Connectorized 500 Series bridge unit it may not be possible to hear the alignment tone emanating from the unit. In this case it may be necessary for a second installer to assist in the operation. Alternatively, it may be possible to extend the tube on the supplied stethoscope to give a longer reach.

Tip: Fine antenna alignment can sometimes be achieved by tightening and loosening the bolts on either side of the antenna mounting bracket, rather than trying to turn the whole bracket on the mounting pole.

13.7.8 Aligning Dual Polar Antennas

The process for aligning a dual polar antenna is the same as aligning an Integrated unit with an integrated antenna. This procedure is detailed in **Section 7.7.11** "Aligning the PTP 500 Series Bridge ODUs".

13.7.9 Aligning Separate Antennas

When using separate antennas to achieve spatial diversity, one should be mounted with Horizontal polarization and the other with Vertical polarization.

The following steps should be followed:

- Step 1: Mount the Antennas
- Step 2: Mount the connectorized version of the PTP 500 Series Bridge unit
- Step 3: Route and make off the ends of the Antenna cables
- Step 4: Connect the antenna cables at the antennas
- Step 5: Connect one of the antenna cables at the Connectorized version of the 500 Series bridge unit.
- Step 6: Connect the Connectorized 500 Series Bridge ODU to PIDU Plus cable and configure the unit as described in **Section 7.7** "Connecting Up".
- Step 7: Align the connected antenna using the tones as described in **Section 7.7.11** "Aligning the PTP 500 Series Bridge ODUs".
- Step 8: Connect the other antenna to the Connectorized 500 Series bridge.
- Step 9: Disconnect the cable to the already aligned antenna.
- Step 10: Align the second antenna using the tones as described in **Section 7.7.11** "Aligning the PTP 500 Series Bridge ODUs".
- Step 11: Re-connect the second antenna to the Connectorized 500 Series bridge (Note: you will notice the tone pitch increase as you re-connect the second antenna due to the additional received signal).
- Step 12: Use the relevant status web pages to check that you are getting the results you expect from your link planning.
- Step 13: Complete the installation as detailed below.

13.7.10 Completing the Installation

The installation should be completed by checking all mounting nuts bolts and screws, securing all cables and weatherproofing the installation. Warning: Finally tightening the antenna mountings may cause the antenna alignment to be altered, due to distortion in the mounting bracket caused by action of tightening. It is recommended that the installation tone be left turned on (armed) during this process so that any movement can be noticed and counteracted by tightening the other side of the bracket.

13.7.11 Antenna Cable Fixing

Cables should be secured in place using cable ties, cleats or PVC tape. Care should be taken to ensure that no undue strain is placed on the connectors on both the Connectorized 500 Series bridge and the Antennas and also to ensure that the cables do not flap in the wind. Flapping cables are prone to damage and induce unwanted vibrations in the mast to which the units are attached.

13.7.12 Antenna Connection Weatherproofing

Where a cable connects to an antenna or unit from above, a drip loop should be left to ensure that water is not constantly channeled towards the connector.

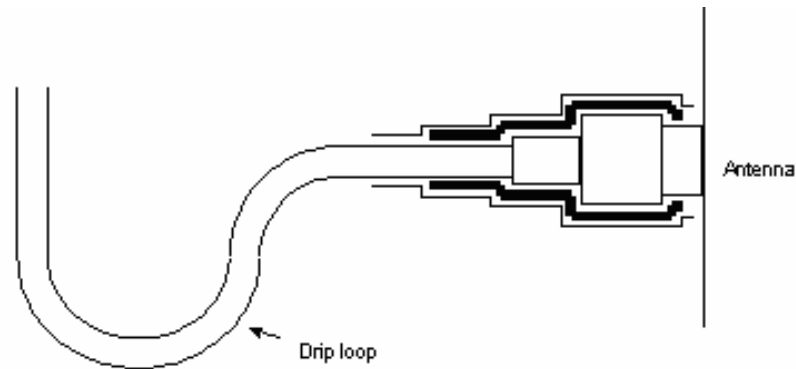

Figure 106 Forming a Drip Loop

All joints should be weatherproofed using self-amalgamating tape. It is recommended that a layer of PVC tape be placed over the self-amalgamating tape to protect the joint while the self-amalgamating tape cures and gives additional protection.

Figure 107 shows this diagrammatically for the 500 Series bridge end of the antenna cables. If the antenna manufacturer has not supplied guidance on this matter, the same technique should be employed at the antenna end of the cable.

PTP 500 Series Bridge - Connectorized Model

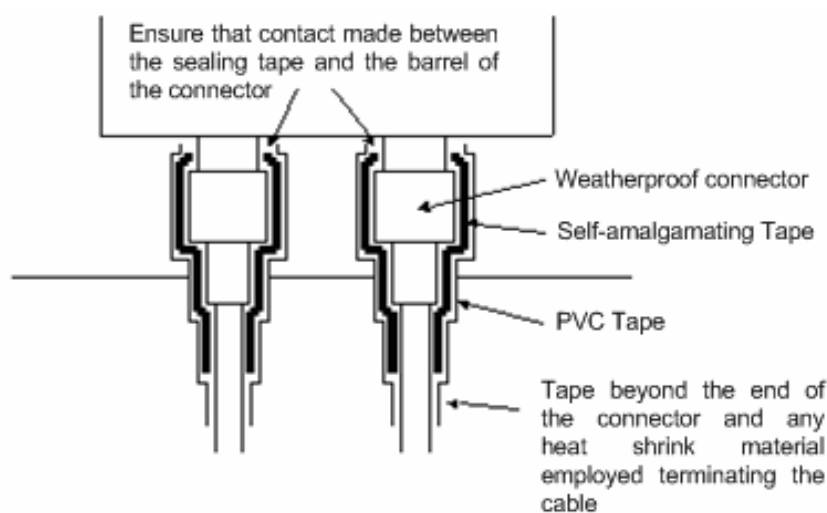

Figure 107 Weatherproofing the Antenna Connections

13.8 Additional Lightning Protection

The following guidelines should be applied in addition to those described in **Section 11** "Lightning Protection".

13.8.1 ODU Mounted Outdoors

Where the ODU is mounted outdoors and is mounted some distance from the antenna, it is advisable to add additional grounding by utilizing Andrew Assemblies (such as Andrew Type 223158 www.andrew.com) as shown in **Figure 108**.

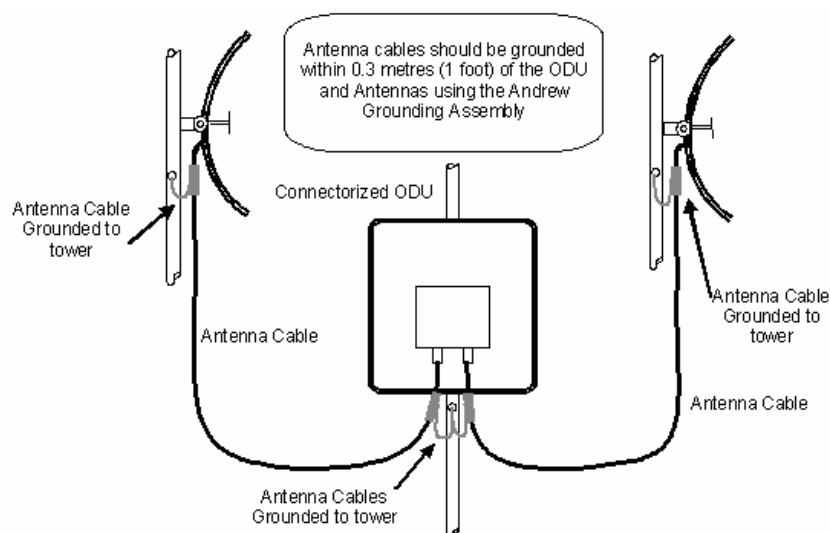

Figure 108 Additional Grounding When Using Connectorized Units

13.8.2 ODU Mounted Indoors

Where the ODU is mounted indoors, lightning arrestors should be deployed where the antenna cables enter the building as shown in **Figure 109**.

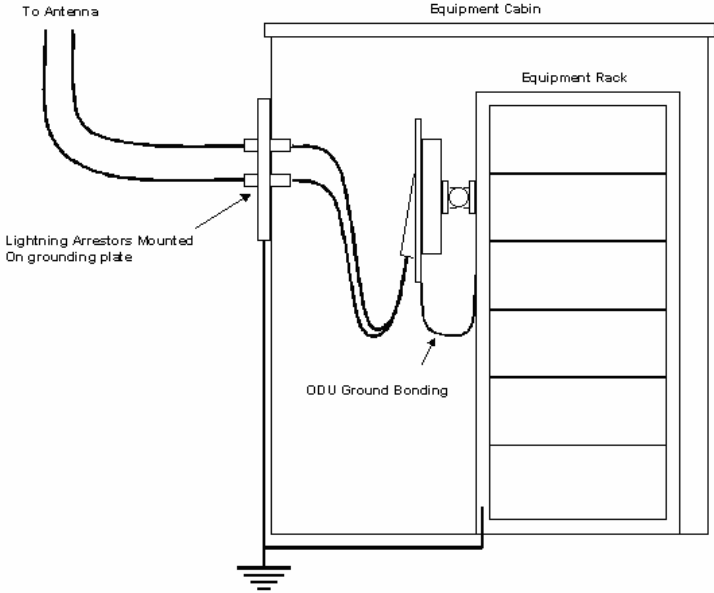

Figure 109 Lightning Arrester Mounting

The lightning arrestors should be ground bonded to the building ground at the point of entry. Motorola recommends Polyphaser LSXL-ME or LSXL lightning arrestors. These should be assembled as show in **Figure 110**.

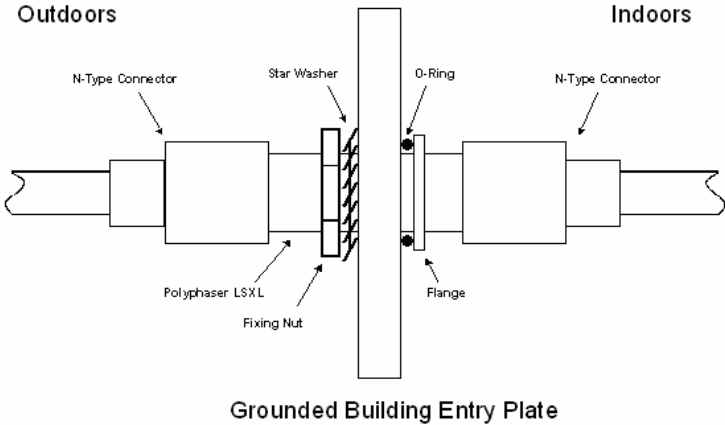

Figure 110 Polyphaser Assembly

14 Data Rate Calculations

To aid the calculation of data rate throughput, the following plots of throughput verses link range have been produced for all the PTP 500 Series modulation modes, assuming the units are connected using 100 Mbps Ethernet. Please note that only 15 MHz channel bandwidth has been considered and the plots are the same for IP or TDM modes. Aggregate data rate capacity can be calculated using four key system parameters:

- Receive modulation mode
- Transmit modulation mode
- Range Between the two wireless units
- Wireless link mode (IP or TDM) Using these parameters the Receive and Transmit data rates can be looked up using the plots **Figure 111** through **Figure 125**.

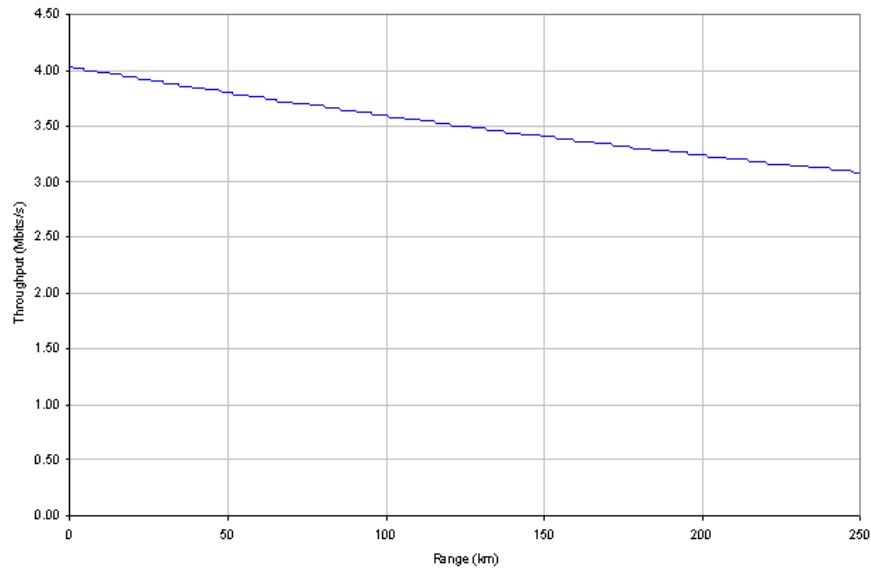

Figure 111 BPSK 0.50 Single Payload

Data Rate Calculations

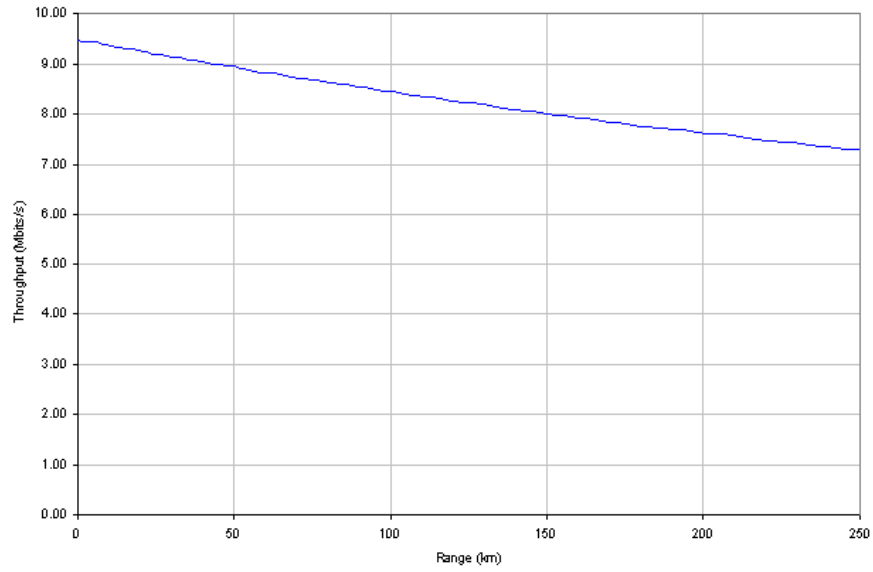

Figure 112 QPSK 0.50 Single Payload

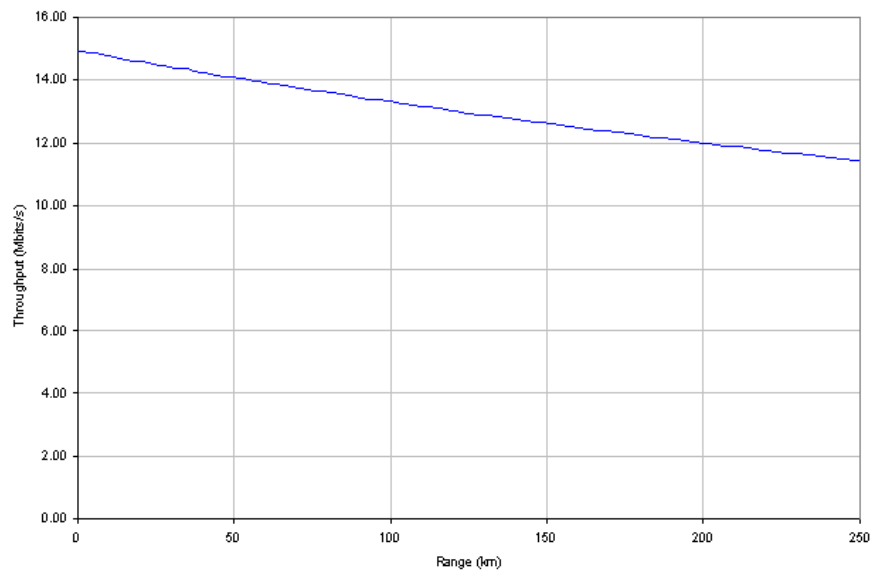

Figure 113 QPSK 0.75 Single Payload

Data Rate Calculations

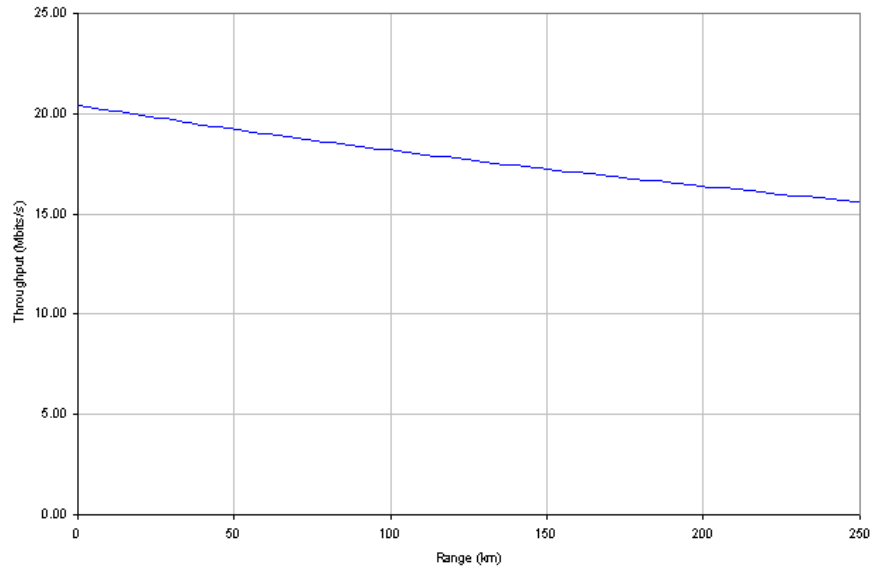

Figure 114 16 QAM 0.50 Single Payload

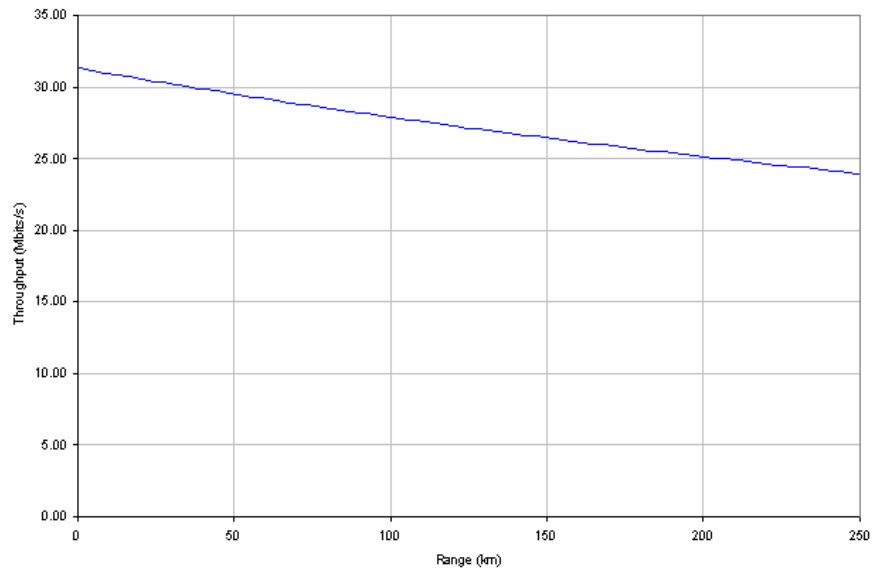

Figure 115 16 QAM 0.75 Single Payload

Data Rate Calculations

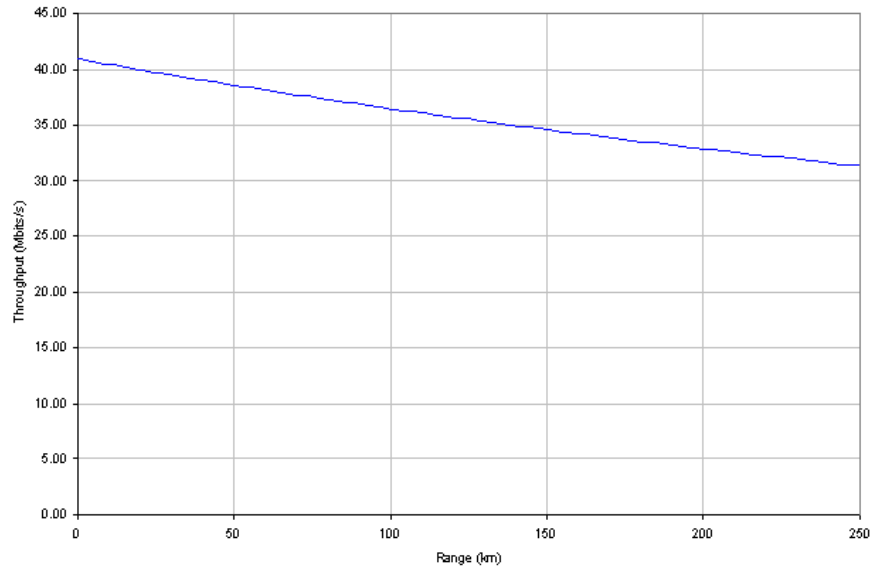

Figure 116 64 QAM 0.67 Single Payload

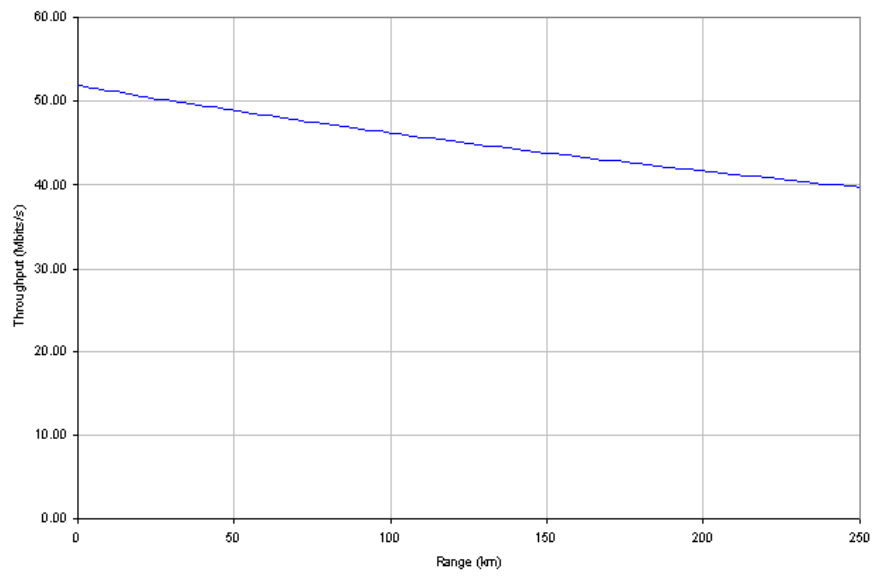

Figure 117 64 QAM 0.83 Single Payload

Data Rate Calculations

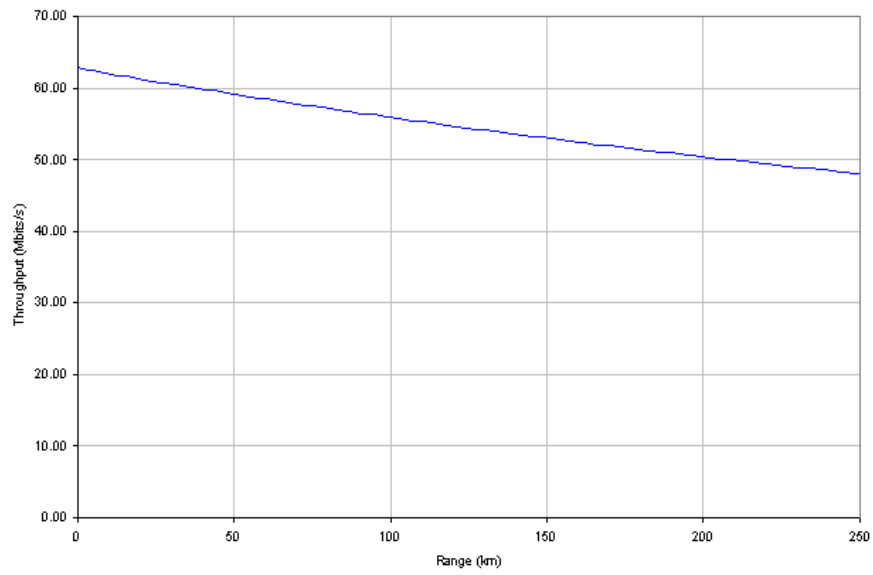

Figure 118 256 QAM 0.75 Single Payload

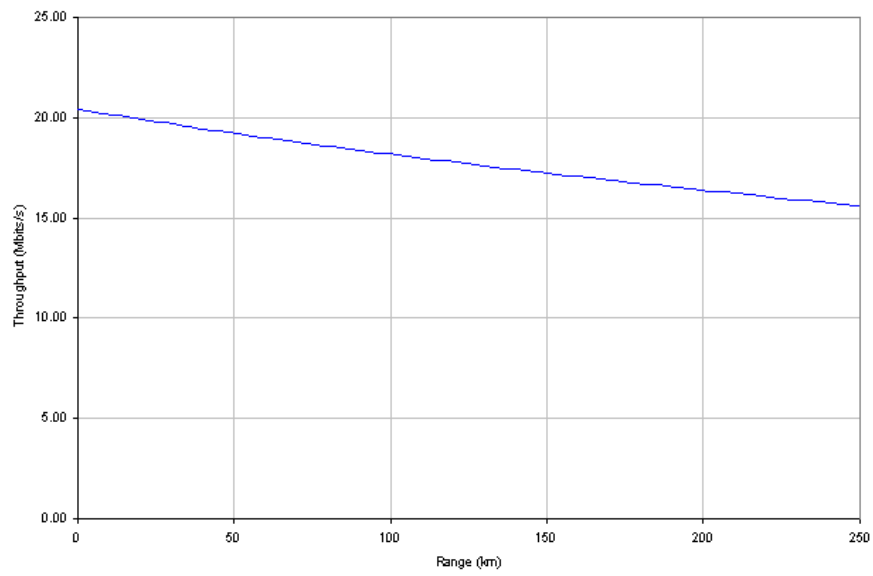

Figure 119 QPSK 0.50 Dual Payload

Data Rate Calculations

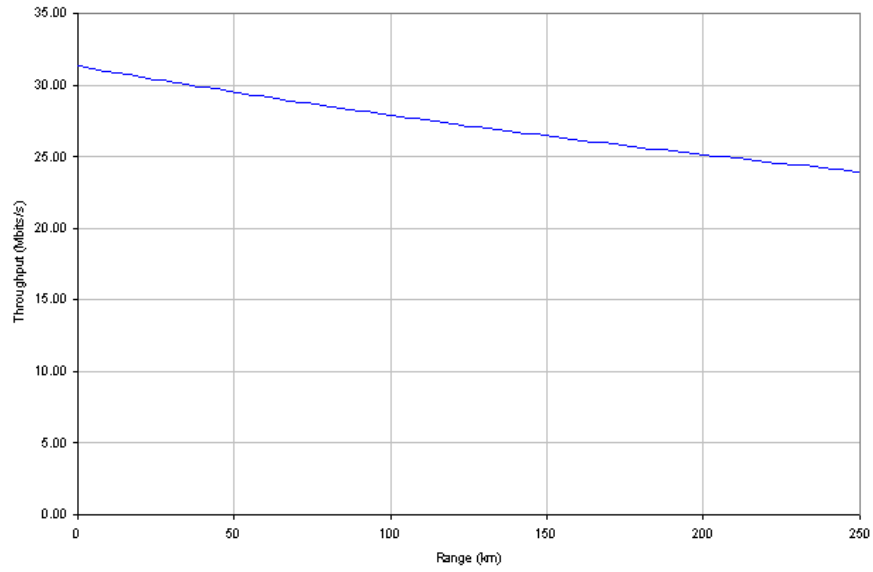

Figure 120 QPSK 0.75 Dual Payload

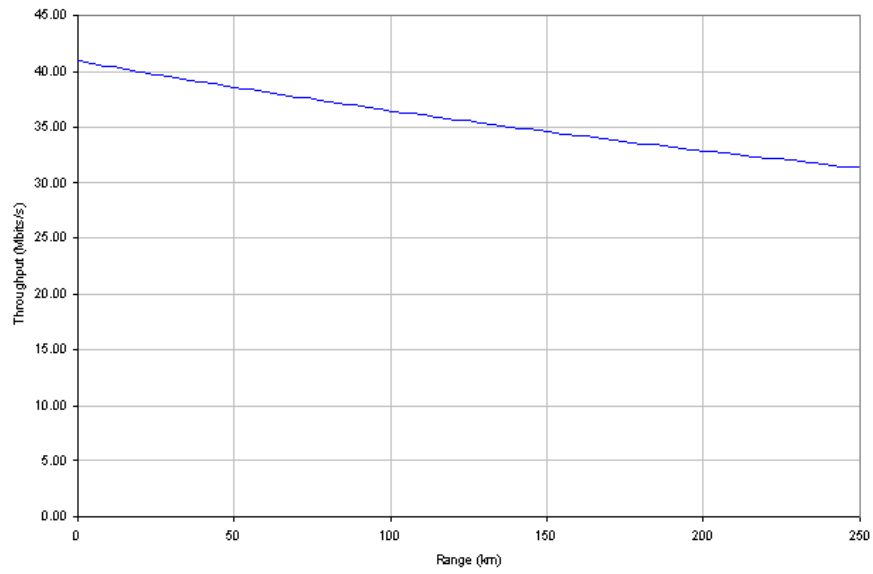

Figure 121 16 QAM 0.50 Dual Payload

Data Rate Calculations

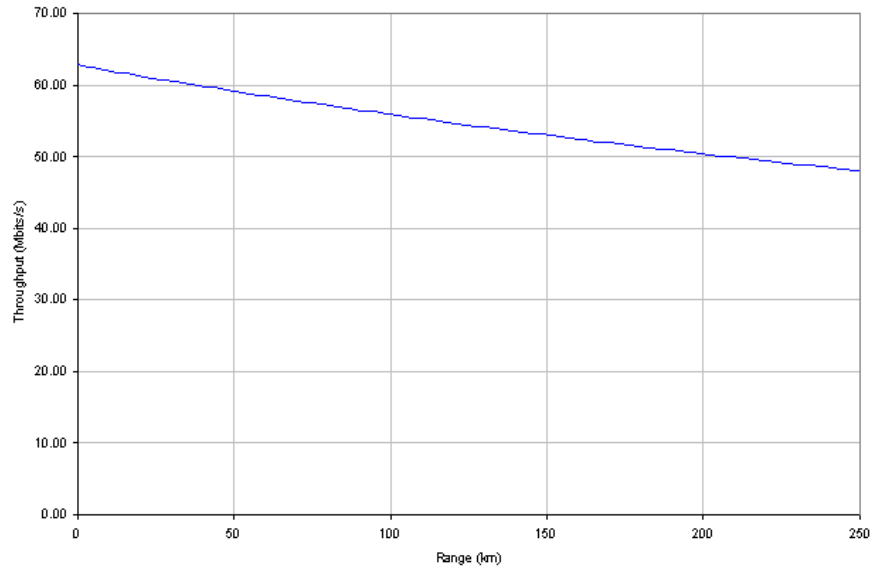

Figure 122 16 QAM 0.75 Dual Payload

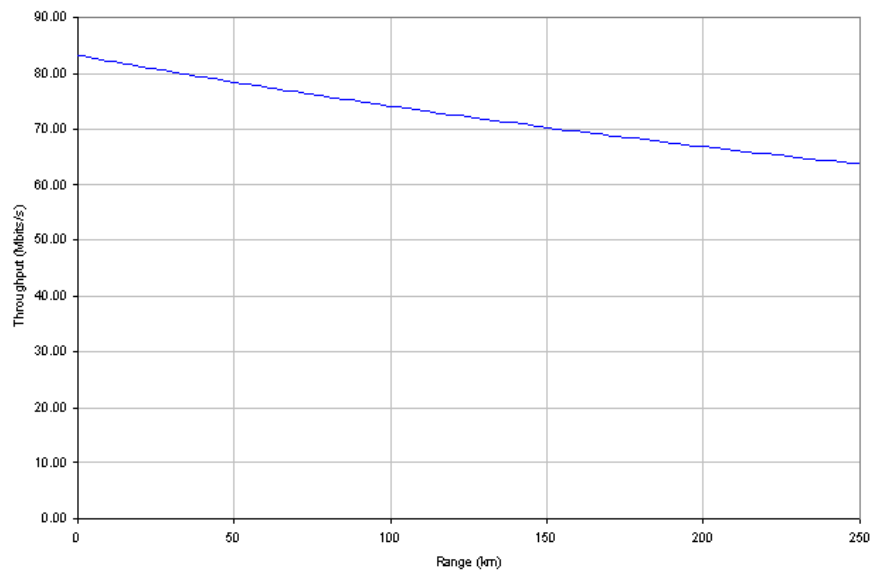

Figure 123 64 QAM 0.67 Dual Payload

Data Rate Calculations

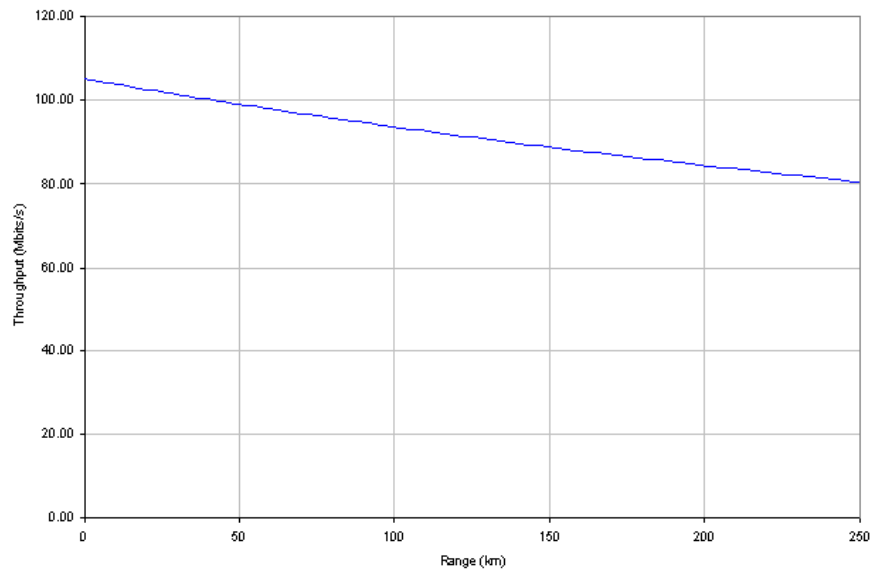

Figure 124 64 QAM 0.83 Dual Payload

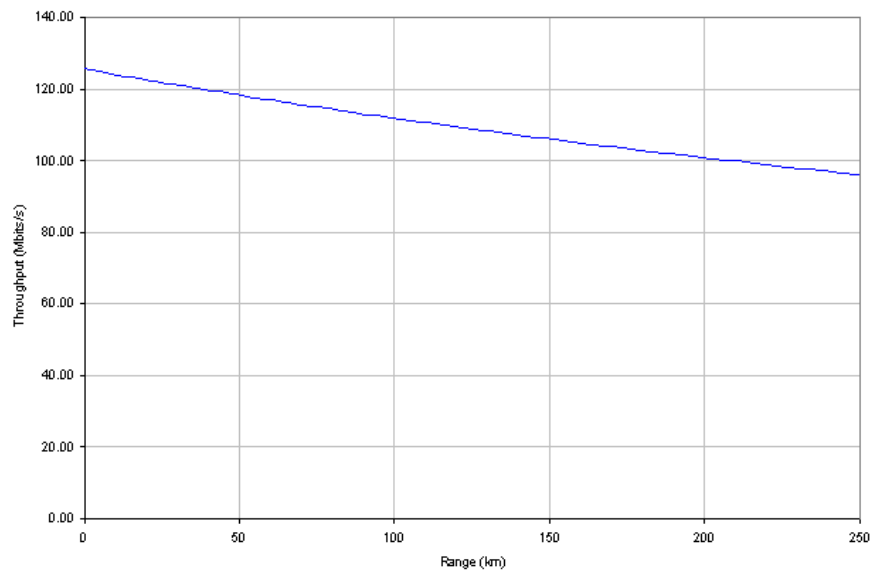

Figure 125 256 QAM 0.75 Dual Payload

15 AES Encryption Upgrade

The Motorola PTP 500 Series bridges support link encryption using the NIST approved Advanced Encryption Standard, HFIPS-197 UTH. This standard specifies AES (Rijndael) as a FIPS-approved symmetric encryption algorithm that may be used by U.S. Government organizations (and others) to protect sensitive information.

Link Encryption is not available in the standard PTP 500 Series system. A license key to enable link encryption can be purchased from your Motorola Point-to-Point Distributor or Solutions Provider. AES can be activated on receipt of the activation on the Motorola Systems Support Page.

There are two levels of encryption that are available to purchase:

- 128-bit
- 128 and 256-bit

Option 1 allows the user to encrypt all traffic sent over the wireless link using 128-bit encryption. Option 2 allows the user to encrypt traffic using either 128 or 256-bit encryption. The configuration process for both encryption variants is identical except for the selection of algorithm. The following configuration example is for a 256-bit encryption key.

15.1 Configuring Link Encryption

After purchasing AES encryption for the PTP 500 Series wireless link, two new license keys will be issued, one for each end of the wireless link. The following configuration process gives a step by step guide to enabling AES link encryption on a PTP 500 Series bridge.

15.1.1 License Keys

The first step when configuring link encryption is to enter the new license keys in both 500 Series wireless units.

Figure 126 shows the license key data entry screen. This screen can only be accessed by the system administrator. If you do not have access to the PTP 500 Series system administration pages then please contact your designated system administrator.

It must be noted that configuring link encryption will necessitate a 500 Series bridge service outage. Therefore it is recommended that the configuration process be scheduled during an appropriate period of low link utilization. Motorola recommends the following process for entering new license keys and minimizing service outage.

1. Open two browsers, one for each end of the link
2. Navigate to the 'License Key' data entry page for each end of the link
3. Enter the license keys and click the 'Validate license key' button at each end of the link. This will allow the software to validate the license key prior to the system reset. (DO NOT CLICK ARE YOU SURE POPUP DIALOG)

Software License Key

A valid software license key is required before installation of the PTP (Point to Point) wireless link can commence. If you do not have a valid license key please contact your distributor.

License key data entry

Attributes	Value	Units
License Key	<input type="text" value="EA06-EBFE-1450-8D15"/>	

Capability summary

Attributes	Value	Units
Product Name	Motorola PTP 58500 Full	
MAC Address	00:04:56:10:00:96	
Region Code	Region Code 1	
Encryption Algorithm	AES 128 & 256-bit (Rijndael)	
Frequency Variant	5800 MHz	
Bandwidth Variant	15 MHz	

Figure 126 AES Software License Key Data Entry

4. When both license keys have been successfully validated confirm the reboot for both ends of the link. The software is designed to allow five seconds so that a user can command both ends of the link to reset before the wireless link drops.
5. The link will automatically re-establish.

15.1.2 Encryption Mode and Key

Entering the license keys only does not initialize AES link encryption. Link encryption can only be enabled via the Configuration or Installation Wizard pages. Motorola recommends that the Configuration page **Figure 127** be used to configure AES link encryption.

Step 2: Wireless Configuration

Please enter the following wireless configuration parameters

Wireless data entry

Attributes	Value	Units
Target MAC Address	00:04:56: <input type="text" value="10"/> : <input type="text" value="00"/> : <input type="text" value="a0"/>	
Master Slave Mode	<input checked="" type="radio"/> Master <input type="radio"/> Slave	
Link Mode Optimization	<input checked="" type="radio"/> IP Traffic <input type="radio"/> TDM Traffic	
Encryption Algorithm	<input checked="" type="radio"/> None <input type="radio"/> AES 128-bit (Rijndael) <input type="radio"/> AES 256-bit (Rijndael)	
Encryption Key	<input type="text" value="*****"/>	
Tx Max Power	<input type="text" value="5"/>	dBm
Platform Variant	<input type="radio"/> Integrated Antenna <input checked="" type="radio"/> Connectorized	
Antenna Gain	<input type="text" value="23.0"/>	dBi
Cable Loss	<input type="text" value="0.0"/>	dB
Channel Bandwidth	<input checked="" type="radio"/> 15 MHz	
Spectrum Management Control	<input type="radio"/> I_DFS <input checked="" type="radio"/> Fixed Frequency	
Default Raster	<input checked="" type="radio"/> On <input type="radio"/> Off	
Fixed Tx Frequency	<input type="text" value="5735"/>	MHz
Fixed Rx Frequency	<input type="text" value="5735"/>	MHz
Installation Tones	<input checked="" type="radio"/> Disabled <input type="radio"/> Enabled	

◀ Back
Next ▶

Figure 127 AES Configuration Data Entry Page

Motorola recommends the following process for entering AES link encryption configuration:-

1. Open two browsers, one for each end of the link
2. Navigate to the 'Configuration' data entry page for each end of the link
3. At both ends of the link select the 'AES (Rijndael)' Encryption Algorithm required.
4. At both ends of the link enter either an 128-bit or 256-bit encryption key. Note the key consists of 32/64 case insensitive hexadecimal characters. The same Key must be entered at both ends of the link. Failure to enter the same key will cause the link to fail.

AES Encryption Upgrade

5. Submit configuration on both ends of the link, but do not reboot.
6. Reboot both ends of the link **Figure 128**. The software is designed to allow five seconds so that a user can command both ends of the link to reboot before the wireless link drops.

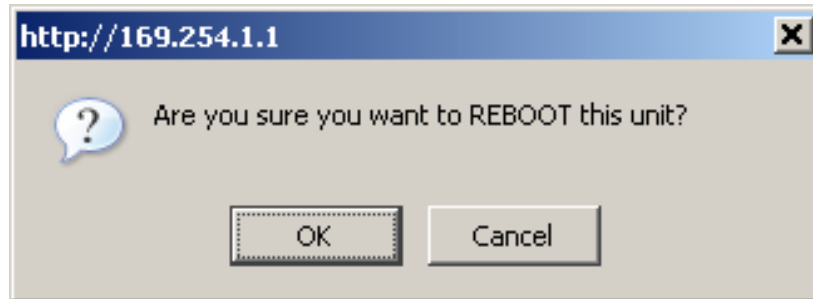

Figure 128 Configuration Reboot Screen

15.2 Wireless Link Encryption FAQ

15.2.1 Encryption data entry fields are not available

Check that the correct license key has been inserted into the unit. The current license key is displayed on the 'License Key' data entry page.

15.2.2 Link fails to bridge packets after enabling link encryption

If the wireless link status on the status web page indicates that the link is 'Searching', and you can browse to the local end of the link but not to the remote end, then check that the same encryption algorithm and key have been entered at both ends of the link. Failure to enter the same algorithm and key will result in received packets not being decrypted correctly.

15.2.3 Loss of AES following downgrade

When downgrading (using Recovery software image 05-01 onwards) to an earlier version of software that does not support AES, the unit will indicate that the region code is invalid. The user will be required to re-install correct software (supplied when AES key was activated) and reboot the unit.

16 Legal and Regulatory Notices

16.1 Important Note on Modifications

Intentional or unintentional changes or modifications to the equipment must not be made unless under the express consent of the party responsible for compliance. Any such modifications could void the user's authority to operate the equipment and will void the manufacturer's warranty.

16.2 National and Regional Regulatory Notices – 5.8 GHz variant

19.2.1 U.S. Federal Communication Commission (FCC) and Industry Canada (IC) Notification
This system has achieved Type Approval in various countries around the world. This means that the system has been tested against various local technical regulations and found to comply. The frequency band in which the system operates is 'license exempt' and the system is allowed to be used provided it does not cause interference. Further, the licensing authority does not guaranteed protection against interference from other products and installations.

This device complies with part 15 of the US FCC Rules and Regulations and with RSS-210 of Industry Canada. Operation is subject to the following two conditions: (1) This device may not cause harmful interference, and (2) This device must accept any interference received, including interference that may cause undesired operation. In Canada, users should be cautioned to take note that high power radars are allocated as primary users (meaning they have priority) of 5250 - 5350 MHz and 5650 - 5850 MHz and these radars could cause interference and/or damage to license-exempt local area networks (LELAN).

For the connectorized version of the product and in order to reduce potential radio interference to other users, the antenna type and its gain should be so chosen that the Effective Isotropically Radiated Power (EIRP) is not more than that permitted for successful communication.

This equipment has been tested and found to comply with the limits for a Class B digital device, pursuant to Part 15 of the US FCC Rules and with RSS-210 of Industry Canada. These limits are designed to provide reasonable protection against harmful interference in a residential installation. This equipment generates, uses, and can radiate radio-frequency energy and, if not installed and used in accordance with these instructions, may cause harmful interference to radio communications. If this equipment does cause harmful interference to radio or television reception, which can be determined by turning the equipment on and off, the user is encouraged to correct the interference by one or more of the following measures:

- Increase the separation between the affected equipment and the unit;
- Connect the affected equipment to a power outlet on a different circuit from that which the receiver is connected to;
- Consult the dealer and/or experienced radio/TV technician for help.
- FCC IDs and Industry Canada Certification Numbers are listed below:

Legal and Regulatory Notices



Where necessary, the end user is responsible for obtaining any National licenses required to operate this product and these must be obtained before using the product in any particular country. Contact the appropriate national administrations for details on the conditions of use for the bands in question and any exceptions that might apply. Also see <http://www.ero.dk> for further information.

16.2.1 European Union Notification

The 5.8 GHz connectorized product is a two-way radio transceiver suitable for use in Broadband Wireless Access System (BWAS), Radio Local Area Network (RLAN), or Fixed Wireless Access (FWA) systems. It is a Class 2 device and uses operating frequencies that are not harmonized throughout the EU member states. The operator is responsible for obtaining any national licenses required to operate this product and these must be obtained before using the product in any particular country.

This equipment complies with the essential requirements for the EU R&TTE Directive 1999/5/EC.

The use of 5.8GHz for Point to Point radio links is not harmonized across the EU and currently the product may only be deployed in the UK and Eire (IRL). However, the regulatory situation in Europe is changing and the radio spectrum may become available in other countries in the near future.

This equipment is marked to show compliance with the European R&TTE directive 1999/5/EC.



The relevant Declaration of Conformity can be found at www.motorola.com/ptp.

European Union (EU) Waste of Electrical and Electronic Equipment (WEEE) directive The European Union's WEEE directive requires that products sold into EU countries must have the crossed out trash bin label on the product (or the package in some cases). As defined

by the WEEE directive, this cross-out trash bin label means that customers and end-users in EU countries should not dispose of electronic and electrical equipment or accessories in household waste. Customers or end-users in EU countries should contact their local equipment supplier representative or service center for information about the waste collection system in their country.

16.2.2 UK Notification

The 5.8 GHz connectorized product has been notified for operation in the UK, and when operated in accordance with instructions for use it is compliant with UK Interface Requirement IR2007. For UK use, installations must conform to the requirements of IR2007 in terms of EIRP spectral density against elevation profile above the local horizon in order to protect Fixed Satellite Services. The frequency range 5795-5815 MHz is assigned to Road Transport & Traffic Telematics (RTTT) in the U.K. and shall not be used by FWA systems in order to protect RTTT devices. UK Interface Requirement IR2007 specifies that radiolocation services shall be protected by a Dynamic Frequency Selection (DFS) mechanism to prevent co-channel operation in the presence of radar signals.

Important Note This equipment operates as a secondary application, so it has no rights against harmful interference, even if generated by similar equipment, and must not cause harmful interference on systems operating as primary applications.

16.3 National and Regional Regulatory Notices – 5.4 GHz Variant

16.3.1 U.S. Federal Communication Commission (FCC) and Industry Canada (IC) Notification²⁴

This device complies with part 15.407 of the US FCC Rules and Regulations and with RSS-210 Issue 7 of Industry Canada. Operation is subject to the following two conditions: (1) This device may not cause harmful interference, and (2) This device must accept any interference received, including interference that may cause undesired operation. In Canada, users should be cautioned to take note that high power radars are allocated as primary users (meaning they have priority) of 5250 - 5350 MHz and 5650 - 5850 MHz and these radars could cause interference and/or damage to license-exempt local area networks (LELAN).

For the connectorized version of the product and in order to reduce potential radio interference to other users, the antenna type and its gain should be so chosen that the equivalent isotropically radiated power (EIRP) is not more than that permitted for successful communication.

This equipment has been tested and found to comply with the limits for a Class B digital device, pursuant to Part 15E of the US FCC Rules and with RSS-210 Issue 7 of Industry Canada. These limits are designed to provide reasonable protection against harmful interference in a residential installation. This equipment generates, uses, and can radiate radio-frequency energy and, if not installed and used in accordance with these instructions, may cause harmful interference to radio communications. If this equipment does cause harmful interference to radio or television reception, which can be determined by turning the equipment on and off, the user is encouraged to correct the interference by one or more of the following measures:

²⁴ FCC and IC certification approval applies ONLY to INTEGRATED variant.

Legal and Regulatory Notices

- Increase the separation between the affected equipment and the unit;
- Connect the affected equipment to a power outlet on a different circuit from that which the receiver is connected to;
- Consult the dealer and/or experienced radio/TV technician for help.
- FCC IDs and Industry Canada Certification Numbers are listed below:



Where necessary, the end user is responsible for obtaining any National licenses required to operate this product and these must be obtained before using the product in any particular country. Contact the appropriate national administrations for details on the conditions of use for the bands in question and any exceptions that might apply. Also see www.eor.dk for further information.

16.3.2 European Union Notification

The 5.4 GHz product is a two-way radio transceiver suitable for use in Broadband Wireless Access System (WAS), Radio Local Area Network (RLAN), or Fixed Wireless Access (FWA) systems. It is a Class 1 device and uses operating frequencies that are harmonized throughout the EU member states. The operator is responsible for obtaining any national licenses required to operate this product and these must be obtained before using the product in any particular country.

This equipment complies with the essential requirements for the EU R&TTE Directive 1999/5/EC and has been tested compliant with EuroNorm EN 301 893. This equipment is marked to show compliance with the European R&TTE directive 1999/5/EC.

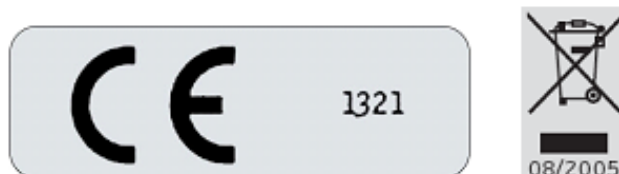

The relevant Declaration of Conformity can be found at www.motorola.com

European Union (EU) Waste of Electrical and Electronic Equipment (WEEE) directive
The European Union's WEEE directive requires that products sold into EU countries must have the crossed out trash bin label on the product (or the package in some cases). As defined by the WEEE directive, this cross-out trash bin label means that customers and end-users in EU countries should

Legal and Regulatory Notices

not dispose of electronic and electrical equipment or accessories in household waste. Customers or end-users in EU countries should contact their local equipment supplier representative or service center for information about the waste collection system in their country.

16.4 Exposure

See **Section 2** “Avoiding Hazards”.

16.5 Legal Notices

16.5.1 Motorola Inc. End User License Agreement

In connection with Motorola’s delivery of certain proprietary software or products containing embedded or pre-loaded proprietary software, or both, Motorola is willing to license this certain proprietary software and the accompanying documentation to you only on the condition that you accept all the terms in this End User License Agreement (“Agreement”).

IF YOU DO NOT AGREE TO THE TERMS OF THIS AGREEMENT, DO NOT USE THE PRODUCT OR INSTALL THE SOFTWARE. INSTEAD, YOU MAY, FOR A FULL REFUND, RETURN THIS PRODUCT TO THE LOCATION WHERE YOU ACQUIRED IT OR PROVIDE WRITTEN VERIFICATION OF DELETION OF ALL COPIES OF THE SOFTWARE. ANY USE OF THE SOFTWARE, INCLUDING BUT NOT LIMITED TO USE ON THE PRODUCT, WILL CONSTITUTE YOUR ACCEPTANCE TO THE TERMS OF THIS AGREEMENT.

16.5.1.1 Definitions

In this Agreement, the word “Software” refers to the set of instructions for computers, in executable form and in any media, (which may include diskette, CD-ROM, downloadable internet, hardware, or firmware) licensed to you. The word “Documentation” refers to electronic or printed manuals and accompanying instructional aids licensed to you. The word “Product” refers to Motorola’s MOTOwi4’s fixed wireless broadband devices for which the Software and Documentation is licensed for use.

16.5.1.2 Grant of License

Motorola, Inc. (“Motorola”) grants you (“Licensee” or “you”) a personal, nonexclusive, non-transferable license to use the Software and Documentation subject to the Conditions of Use set forth in **Section 3.4** “Warranty” and the terms and conditions of this Agreement. Any terms or conditions relating to the Software and Documentation appearing on the face or reverse side of any purchase order, purchase order acknowledgment or other order document that are different from, or in addition to, the terms of this Agreement will not be binding on the parties, even if payment is accepted.

16.5.1.3 Conditions of Use

Any use of the Software and Documentation outside of the conditions set forth in this Agreement is strictly prohibited and will be deemed a breach of this Agreement.

Legal and Regulatory Notices

1. Only you, your employees or agents may use the Software and Documentation. You will take all necessary steps to insure that your employees and agents abide by the terms of this Agreement.
2. You will use the Software and Documentation (i) only for your internal business purposes; (ii) only as described in the Software and Documentation; and (iii) in strict accordance with this Agreement.
3. You may use the Software and Documentation, provided that the use is in conformance with the terms set forth in this Agreement.
4. Portions of the Software and Documentation are protected by United States copyright laws, international treaty provisions, and other applicable laws. Therefore, you must treat the Software like any other copyrighted material (e.g., a book or musical recording) except that you may either: (i) make 1 copy of the transportable part of the Software (which typically is supplied on diskette, CD-ROM, or downloadable internet), solely for back-up purposes; or (ii) copy the transportable part of the Software to a PC hard disk, provided you keep the original solely for back-up purposes. If the Documentation is in printed form, it may not be copied. If the Documentation is in electronic form, you may print out 1 copy, which then may not be copied. With regard to the copy made for backup or archival purposes, you agree to reproduce any Motorola copyright notice, and other proprietary legends appearing thereon. Such copyright notice(s) may appear in any of several forms, including machine-readable form, and you agree to reproduce such notice in each form in which it appears, to the extent it is physically possible to do so. Unauthorized duplication of the Software or Documentation constitutes copyright infringement, and in the United States is punishable in federal court by fine and imprisonment.
5. You will not transfer, directly or indirectly, any product, technical data or software to any country for which the United States Government requires an export license or other governmental approval without first obtaining such license or approval.

16.5.1.4 Title; Restrictions

If you transfer possession of any copy of the Software and Documentation to another party outside of the terms of this agreement, your license is automatically terminated. Title and copyrights to the Software and Documentation and any copies made by you remain with Motorola and its licensors. You will not, and will not permit others to: (i) modify, translate, decompile, bootleg, reverse engineer, disassemble, or extract the inner workings of the Software or Documentation, (ii) copy the look-and-feel or functionality of the Software or Documentation; (iii) remove any proprietary notices, marks, labels, or logos from the Software or Documentation; (iv) rent or transfer all or some of the Software or Documentation to any other party without Motorola's prior written consent; or (v) utilize any computer software or hardware which is designed to defeat any copy protection device, should the Software and Documentation be equipped with such a protection device. If the Software and Documentation is provided on multiple types of media (such as diskette, CD-ROM, downloadable internet), then you will only use the medium which best meets your specific needs, and will not loan, rent, lease, or transfer the other media contained in the package without Motorola's written consent. Unauthorized copying of the Software or Documentation, or failure to comply with any of the provisions of this Agreement, will result in automatic termination of this license.

16.5.1.5 Confidentiality

You acknowledge that all Software and Documentation contain valuable proprietary information and trade secrets and that unauthorized or improper use of the Software and Documentation will result in irreparable harm to Motorola for which monetary damages would be inadequate and for which Motorola will be entitled to immediate injunctive relief. If applicable, you will limit access to the Software and Documentation to those of your employees and agents who need to use the Software and Documentation for your internal business purposes, and you will take appropriate action with those employees and agents to preserve the confidentiality of the Software and Documentation, using the same degree of care to avoid unauthorized or improper disclosure as you use for the protection of your own proprietary software, but in no event less than reasonable care.

1. You have no obligation to preserve the confidentiality of any proprietary information that: (i) was in the public domain at the time of disclosure; (ii) entered the public domain through no fault of yours; (iii) was given to you free of any obligation to keep it confidential; (iv) is independently developed by you; or (v) is disclosed as required by law provided that you notify Motorola prior to such disclosure and provide Motorola with a reasonable opportunity to respond.

16.5.1.6 Right to Use Motorola's Name

Except as required in 19.6.1.3 above, you will not, during the term of this Agreement or thereafter, use any trademark of Motorola, or any word or symbol likely to be confused with any Motorola trademark, either alone or in any combination with another word or words.

16.5.1.7 Transfer

The Software and Documentation may not be transferred to another party without the express written consent of Motorola, regardless of whether or not such transfer is accomplished by physical or electronic means. Motorola's consent may be withheld at its discretion and may be conditioned upon transferee paying all applicable license fees and agreeing to be bound by this Agreement.

16.5.1.8 Updates

During the first 12 months after purchase of a Product, or during the term of any executed Maintenance and Support Agreement for the Product, you are entitled to receive Updates. An "Update" means any code in any form which is a bug fix, patch, error correction, or minor enhancement, but excludes any major feature added to the Software. Updates are available for download at <http://www.motowi4solutions.com/software/>

1. Major features may be available from time to time for an additional license fee. If Motorola makes available to you major features and no other end user license agreement is provided, then the terms of this Agreement will apply.

16.5.1.9 Maintenance

Except as provided above, Motorola is not responsible for maintenance or field service of the Software under this Agreement.

16.5.1.10 Disclaimer

MOTOROLA DISCLAIMS ALL WARRANTIES OF ANY KIND, WHETHER EXPRESS, IMPLIED, STATUTORY, OR IN ANY COMMUNICATION WITH YOU. MOTOROLA SPECIFICALLY DISCLAIMS ANY WARRANTY INCLUDING THE IMPLIED WARRANTIES OF MERCHANTABILITY, NONINFRINGEMENT, OR FITNESS FOR A PARTICULAR PURPOSE. THE SOFTWARE AND DOCUMENTATION ARE PROVIDED “AS IS.” MOTOROLA DOES NOT WARRANT THAT THE SOFTWARE WILL MEET YOUR REQUIREMENTS, OR THAT THE OPERATION OF THE SOFTWARE WILL BE UNINTERRUPTED OR ERROR FREE, OR THAT DEFECTS IN THE SOFTWARE WILL BE CORRECTED. MOTOROLA MAKES NO WARRANTY WITH RESPECT TO THE CORRECTNESS, ACCURACY, OR RELIABILITY OF THE SOFTWARE AND DOCUMENTATION. Some jurisdictions do not allow the exclusion of implied warranties, so the above exclusion may not apply to you.

16.5.1.11 Limitation of Liability

THE TOTAL LIABILITY OF MOTOROLA UNDER THIS AGREEMENT FOR DAMAGES WILL NOT EXCEED THE TOTAL AMOUNT PAID BY YOU FOR THE PRODUCT LICENSED UNDER THIS AGREEMENT. IN NO EVENT WILL MOTOROLA BE LIABLE IN ANY WAY FOR INCIDENTAL, CONSEQUENTIAL, INDIRECT, SPECIAL OR PUNITIVE DAMAGES OF ANY NATURE, INCLUDING WITHOUT LIMITATION, LOST BUSINESS PROFITS, OR LIABILITY OR INJURY TO THIRD PERSONS, WHETHER FORESEEABLE OR NOT, REGARDLESS OF WHETHER MOTOROLA HAS BEEN ADVISED OF THE POSSIBILITY OF SUCH DAMAGES. Some jurisdictions do not permit limitations of liability for incidental or consequential damages, so the above exclusions may not apply to you.

16.5.1.12 U.S. Government

If you are acquiring the Product on behalf of any unit or agency of the U.S. Government, the following applies. Use, duplication, or disclosure of the Software and Documentation is subject to the restrictions set forth in subparagraphs (c) (1) and (2) of the Commercial Computer Software – Restricted Rights clause at FAR 52.227-19 (JUNE 1987), if applicable, unless being provided to the Department of Defense. If being provided to the Department of Defense, use, duplication, or disclosure of the Products is subject to the restricted rights set forth in subparagraph (c) (1) (ii) of the Rights in Technical Data and Computer Software clause at DFARS 252.227-7013 (OCT 1988), if applicable. Software and Documentation may or may not include a Restricted Rights notice, or other notice referring specifically to the terms and conditions of this Agreement. The terms and conditions of this Agreement will each continue to apply, but only to the extent that such terms and conditions are not inconsistent with the rights provided to you under the aforementioned provisions of the FAR and DFARS, as applicable to the particular procuring agency and procurement transaction.

16.5.1.13 Term of License

Your right to use the Software will continue in perpetuity unless terminated as follows. Your right to use the Software will terminate immediately without notice upon a breach of this Agreement by you. Within 30 days after termination of this Agreement, you will certify to Motorola in writing that through your best efforts, and to the best of your knowledge, the original and all copies, in whole or in part, in any form, of the Software and all related material and Documentation, have

Legal and Regulatory Notices

been destroyed, except that, with prior written consent from Motorola, you may retain one copy for archival or backup purposes. You may not sublicense, assign or transfer the license or the Product, except as expressly provided in this Agreement. Any attempt to otherwise sublicense, assign or transfer any of the rights, duties or obligations hereunder is null and void.

16.5.1.14 Governing Law

This Agreement is governed by the laws of the United States of America to the extent that they apply and otherwise by the laws of the State of Illinois.

16.5.1.15 Assignment

This agreement may not be assigned by you without Motorola's prior written consent.

16.5.1.16 Survival of Provisions

The parties agree that where the context of any provision indicates an intent that it survives the term of this Agreement, then it will survive.

16.5.1.17 Entire Agreement

This agreement contains the parties' entire agreement regarding your use of the Software and may be amended only in writing signed by both parties, except that Motorola may modify this Agreement as necessary to comply with applicable laws.

16.5.1.18 Third Party Software

The software may contain one or more items of Third-Party Software supplied by other third-party suppliers. The terms of this Agreement govern your use of any Third-Party Software UNLESS A SEPARATE THIRD-PARTY SOFTWARE LICENSE IS INCLUDED, IN WHICH CASE YOUR USE OF THE THIRD-PARTY SOFTWARE WILL THEN BE GOVERNED BY THE SEPARATE THIRD-PARTY LICENSE.

1. UCD SNMP. Copyright 1989, 1991, 1992 by Carnegie Mellon University, Derivative Work – 1996, 1998-2000, Copyright 1996, 1998-2000 The regents of the University of California All Rights reserved. Permission to use, copy, modify and distribute this software and its documentation for any purpose and without fee is hereby granted, provided that the above copyright notice appears in all copies and that both that copyright notice and this permission notice appear in supporting documentation, and that the name of CMU and The Regents of the University of California not be used in advertising or publicity pertaining to distribution of the software without specific written permission. CMU AND THE REGENTS OF THE UNIVERSITY OF CALIFORNIA DISCLAIM ALL WARRANTIES WITH REGARD TO THIS SOFTWARE, INCLUDING ALL IMPLIED. WARRANTIES OF MERCHANTABILITY AND FITNESS. IN NO EVENT SHALL CMU OR THE REGENTS OF THE UNIVERSITY OF CALIFORNIA BE LIABLE FOR ANY SPECIAL, INDIRECT OR CONSEQUENTIAL DAMAGES OR ANY DAMAGES WHATSOEVER RESULTING FROM THE LOSS OF USE, DATA OR PROFITS, WHETHER IN AN ACTION OF CONTRACT, NEGLIGENCE OR OTHER TORTIOUS ACTION, ARISING OUT OF OR IN CONNECTION WITH THE USE

Legal and Regulatory Notices

OR PERFORMANCE OF THIS SOFTWARE. ONLY OPEN THE PACKAGE, OR USE THE SOFTWARE AND RELATED PRODUCT IF YOU ACCEPT THE TERMS OF THIS LICENSE. BY BREAKING THE SEAL ON THIS DISK KIT / CDROM, OR IF YOU USE THE SOFTWARE OR RELATED PRODUCT, YOU ACCEPT THE TERMS OF THIS LICENSE AGREEMENT. IF YOU DO NOT AGREE TO THESE TERMS, DO NOT USE THE SOFTWARE OR RELATED PRODUCT; INSTEAD, RETURN THE SOFTWARE TO PLACE OF PURCHASE FOR A FULL REFUND. THE FOLLOWING AGREEMENT IS A LEGAL AGREEMENT BETWEEN YOU (EITHER AN INDIVIDUAL OR ENTITY), AND MOTOROLA, INC. (FOR ITSELF AND ITS LICENSORS). THE RIGHT TO USE THIS PRODUCT IS LICENSED ONLY ON THE CONDITION THAT YOU AGREE TO THE FOLLOWING TERMS.

2. BZIP2 License Terms. Terms. This. “bzip2” and associated library “libbzip2”, are copyright (C) 1996-2000 Julian R Seward. All rights reserved. Redistribution and use in source and binary forms, with or without modification, are permitted provided that the following conditions are met:
 - Redistributions of source code must retain the above copyright notice, this list of condition sand the following disclaimer.
 - The origin of this software must not be misrepresented; you must not claim that you wrote the original software. If you use this software in a product, an acknowledgment in the product documentation would be appreciated but is not required.
 - Altered source versions must be plainly marked as such, and must not be misrepresented as being the original software.
 - The name of the author may not be used to endorse or promote products derived from this software without specific prior written permission.

THIS SOFTWARE IS PROVIDED BY THE AUTHOR “AS IS” AND ANY EXPRESS OR IMPLIED WARRANTIES, INCLUDING, BUT NOT LIMITED TO, THE IMPLIED WARRANTIES OF MERCHANTABILITY AND FITNESS FOR A PARTICULAR PURPOSE ARE DISCLAIMED. IN NO EVENT SHALL THE AUTHOR BE LIABLE FOR ANY DIRECT, INDIRECT, INCIDENTAL, SPECIAL, EXEMPLARY, OR CONSEQUENTIAL DAMAGES (INCLUDING, BUT NOT LIMITED TO, PROCUREMENT OF SUBSTITUTE GOODS OR SERVICES; LOSS OF USE, DATA, OR PROFITS; OR BUSINESS INTERRUPTION) HOWEVER CAUSED AND ON ANY THEORY OF LIABILITY, WHETHER IN CONTRACT, STRICT LIABILITY, OR TORT (INCLUDING NEGLIGENCE OR OTHERWISE) ARISING IN ANY WAY OUT OF THE USE OF THIS SOFTWARE, EVEN IF ADVISED OF THE POSSIBILITY OF SUCH DAMAGE.

3. zlib.h – Interface of the ‘zlib’ general purpose compression library version 1.2.3, July 18th, 2005. Copyright (C) 1995-2005 Jean-loup Gailly and Mark Adler. This software is provided ‘as-is’, without any express or implied warranty. In no event will the authors be held liable for any damages arising from the use of this software. Permission is granted to anyone to use this software for any purpose, including commercial applications, and to alter it and redistribute it freely, subject to the following restrictions:

Legal and Regulatory Notices

- The origin of this software must not be misrepresented; you must not claim that you wrote the original software. If you use this software in a product, an acknowledgment in the product documentation would be appreciated but is not required.
- Altered source versions must be plainly marked as such, and must not be misrepresented as being the original software.
- This notice may not be removed or altered from any source distribution.

Jean-loup Gailly jloup@gzip.org

Mark Adler madler@alumni.caltech.edu

19.6.2 Hardware Warranty in U.S.

Motorola U.S. offers a warranty covering a period of one year from the date of purchase by the customer. If a product is found defective during the warranty period, Motorola will repair or replace the product with the same or a similar model, which may be a reconditioned unit, without charge for parts or labor.

16.5.2 Limit of Liability

IN NO EVENT SHALL MOTOROLA BE LIABLE TO YOU OR ANY OTHER PARTY FOR ANY DIRECT, INDIRECT, GENERAL, SPECIAL, INCIDENTAL, CONSEQUENTIAL, EXEMPLARY OR OTHER DAMAGE ARISING OUT OF THE USE OR INABILITY TO USE THE PRODUCT (INCLUDING, WITHOUT LIMITATION, DAMAGES FOR LOSS OF BUSINESS PROFITS, BUSINESS INTERRUPTION, LOSS OF BUSINESS INFORMATION OR ANY OTHER PECUNIARY LOSS, OR FROM ANY BREACH OF WARRANTY, EVEN IF MOTOROLA HAS BEEN ADVISED OF THE POSSIBILITY OF SUCH DAMAGES. (Some states do not allow the exclusion or limitation of incidental or consequential damages, so the above exclusion or limitation may not apply to you.) IN NO CASE SHALL MOTOROLA'S LIABILITY EXCEED THE AMOUNT YOU PAID FOR THE PRODUCT.

17 Specifications

17.1 System Specifications

17.1.1 Wireless 5.4GHz Variant

Radio Technology	Specification
RF Band	5.470-5.725GHz
Channel Selection	By dynamic frequency control and manual intervention. Automatic detection on start-up and continual adaptation to avoid interference.
Dynamic Frequency Control	Initial capture 10-15 sec. Out of service on interference 100 ms.
Channel size	5, 10, 15 and 30 MHz
Manual Power Control	Maximum power can be controlled lower than the power limits shown above in order to control interference to other users of the band.
Receiver Noise Figure	Typically 6 dB
Antenna Type	Integrated flat plate antenna
Antenna Gain	23dBi typical
Antenna Beamwidth	8 Degrees
Max Path Loss (5 MHz channel)	169 dB
Duplex Scheme	TDD, Symmetric (1:1)
Range	125 miles (200km) optical Line-of-Sight 6 miles (10km) non-Line-of-Sight
Over-the-Air Encryption	Proprietary scrambling mechanism.
Weather Sensitivity	Sensitivity at higher modes may be reduced during high winds through trees due to Adaptive Modulation Threshold changes
Error Correction	FEC

Specifications

17.1.2 Wireless 5.8GHz Variant

Radio Technology	Specification
RF Band	5.725-5.850GHz
Channel Selection	By dynamic frequency control and manual intervention. Automatic detection on start-up and continual adaptation to avoid interference.
Dynamic Frequency Control	Initial capture 10-15 sec. Out of service on interference 100 ms.
Channel size	5, 10, 15 and 30 MHz
Manual Power Control	Maximum power can be controlled lower than the power limits shown above in order to control interference to other users of the band.
Receiver Noise Figure	Typically 6 dB
Antenna Type	Integrated flat plate antenna
Antenna Gain	23dBi typical
Antenna Beamwidth	8 Degrees
Max Path Loss (5 MHz channel)	166 dB
Duplex Scheme	TDD, Symmetric (1:1)
Range	125 miles (200km) optical Line-of-Sight 6 miles (10km) non-Line-of-Sight
Over-the-Air Encryption	Proprietary scrambling mechanism.
Weather Sensitivity	Sensitivity at higher modes may be reduced during high winds through trees due to Adaptive Modulation Threshold changes
Error Correction	FEC

Specifications

17.1.3 Management

Management	Specification
Status Indication	Power status Ethernet Link Status Data activity
Installation	Web server and browser for setup Audio tone feedback during installation , plus graphical installation tool suitable for laptop and PDA computing devices Web server for confirmation
Radio Performance and Management	Via web server and browser, SNMP
Alarms	Via configurable email alerts, SNMP

17.1.4 Ethernet Bridging

Ethernet Bridging	Specification
Protocol	IEEE802.1; IEEE802.1P; IEEE802.3 compatible
Interface	10/100/1000BaseT (RJ-45), Supports MDI/MDIX Auto Crossover
Data Rates	See Section 14 “Data Rate Calculations”



Note: Practical Ethernet rates will depend on network configuration, higher layer protocols and platforms used.



Caution: Over the air throughput will be capped to the rate of the Ethernet interface at the receiving end of the link.

Specifications

17.1.5 Physical

Integrated	Specification
Dimensions	Width 14.5" (370mm), Height 14.5" (370mm), Depth 3.75" (95mm)
Weight	12.1 lbs (5.5 Kg) including bracket
Connectorized	Specification
Dimensions	Width 12" (305mm), Height 12" (305mm), Depth 4.01" (105mm)
Weight	9.1 lbs (4.3 Kg) including bracket

17.1.6 Powering

Power Supply	Separate power supply unit (included)
Dimensions	Width 9.75" (250mm), Height 1.5" (40mm), Depth 3" (80mm)
Weight	1.9 lbs (0.864 Kg)
Power source	90 - 264 VAC, 50 - 60 Hz / 36 - 60 VDC
Power consumption	55 W max

17.2 Safety Compliance

Region	Specification
USA	UL 60950
Canada	CSA C22.2 No.60950
International	CB certified & certificate to IEC 60950

17.3 EMC Emissions Compliance

17.3.1 5.4GHz Variant

Region	Specification
USA	FCC Part 15 Class B
Canada	CSA Std C108.8, 1993 Class B
Europe	EN55022 CISPR 22

17.3.2 5.8GHz Variant

Specifications

Region	Specification
USA	FCC Part 15 Class B
Canada	CSA Std C108.8, 1993 Class B
Europe	EN55022 CISPR 22

17.4 EMC Immunity Compliance

Top-level Specification ETSI 301-489.

Specification	Comment
EN 55082-1 Generic EMC and EMI requirements for Europe	
EN 61000-4-2: 1995 Electro Static Discharge (ESD), Class 2, 8 kV air, 4 kV contact discharge	Testing will be carried to ensure immunity to 15kV air and 8kV contact
EN 61000-4-3: 1995 ENV50140: 1993 (radiated immunity) 3 V/m	
EN 61000-4-4: 1995 (Bursts/Transients), Class 4, 4 kV level (power lines AC & DC)	Signal lines @ 0.5 kV open circuit voltage
EN 6100045:1995, (Surge Immunity)	Requires screened connection to users network
EN 61000-4-6: 1996 (Injected RF), power line, Class 3 @ 10 V/m	Signal lines, Class 3 @ 3 V RMS unmodulated.

17.5 Radio Certifications

17.5.1 Radio Certifications - 5.4 GHz Variant

Region	Specification (Type Approvals)
USA	FCC Part 15.407
EU	EN301 893 V1.2.3/V1.3.1
Canada	RSS 210 Issue 7

Specifications

17.5.2 Radio Certifications - 5.8 GHz Variant

Region	Specification (Type Approvals)
USA	FCC Part 15.247
Canada	RSS 210 Issue 7
UK	IR 2007
Eire	Comreg 03/42

17.6 Environmental Specifications

Category	Specification
Temperature	ODU -40°F (-40°C) to 140°F (+60°C) PIDU Plus (indoor) 32°F (0°C) to 104°F (+40°C) PIDU Plus (outdoor)-40°F (-40°C) to 140°F (+60°C)
Wind Loading	150mph Max (242 kmh). See Section 12 “Wind Loading” for a full description
Humidity	100% condensing
Waterproof	IP65 (ODU), IP53 (PIDU Plus)
UV Exposure	10 year operational life (UL746C test evidence)

Specifications

17.7 System Connections

17.7.1 PIDU Plus to ODU and ODU to Network Equipment Connections

<u>ODU Power Connector</u>			<u>PIDU</u>	
PIN 1		Data pair 1 & 0V (White and Orange)		PIN 1
PIN 2		Data pair 1 & 0V (Orange)		PIN 2
PIN 3		Data pair 2 & 0V (Green and White)		PIN 3
PIN 4		Data pair 3, +55V and LED (Blue)		PIN 4
PIN 5		Data pair 3, +55V and LED (Blue and		PIN 5
PIN 6		Data pair 2 & 0V (Green)		PIN 6
PIN 7		Data pair 4, +55V and LED (Brown and White)		PIN 7
PIN 8		Data pair 4, +55V and LED (Brown)		PIN 8

Figure 129 Cable Connection Diagram (T568B Color Coding)

18 FAQs

Can I source and use my own PoE adaptor with the 500 Series bridge? No. The 500 Series bridge uses a non-standard PoE configuration. Failure to use the Motorola supplied Power Indoor Unit could result in equipment damage and will invalidate the safety certification and may cause a safety hazard.

Why has Motorola launched the 500 Series bridge? The 500 Series bridge is the first product to feature Multiple-Input Multiple-Output (MIMO). The PTP 500 Series solutions allow wireless connections of up to 200km (124 miles) in near line-of-sight conditions and up to 10km (6 miles) in deep non-line-of-sight conditions.

What is Multiple-Input Multiple-Output (MIMO)? The 500 Series bridge radiates multiple beams from the antenna - the effect of which is to significantly protect against fading and to radically increase the probability that the receiver will decode a usable signal. When the effects of MIMO are combined with those of OFDM techniques and a best in class link budget, there is a significant improvement to the probability of a robust connection over a non-line-of-sight path.

What do you mean by “non-line-of-sight”? A wireless connection between two points without optical line-of-sight, i.e., with obstructions between the antennas the transmitted signal is still able to reach the receiver and produce a good quality link.

What else is special about the 500 Series bridge ? There are many special features built-in to the hardware of the 500 Series bridge. The product offers the highest system gain in its class through high sensitivity antennas for improved signal recovery. It also features a Software Defined Radio system that operates on ultra fast digital signal processors but is controlled by firmware giving the ability to download new firmware when enhancements become available. The 500 Series bridge has a built-in web server for advanced management capabilities including detailed radio signal diagnosis.

In which frequency bands does the 500 Series bridge operate? The Motorola point-to-point 500 Series bridge operates in the unlicensed 5.4 GHz (ETSI Band B) and 5.8 GHz (ETSI Band C and FCC ISM band). This means no license is required to operate the 500 Series bridge.

Why does the 500 Series bridge operate in the 5GHz band? The 5 GHz band offers the dual benefits of high data throughput and good radio propagation characteristics. The wide band of spectrum available is subdivided into several channels such that multiple systems can operate in the vicinity without causing interference to one another.

Is the 500 Series bridge an 802.11a device?No, although similar, the 500 Series bridge uses different encoding and radio transmission systems from 802.11a. In areas where 802.11a systems are operating, the 500 Series bridge will detect the 802.11a radio signals and choose a clear channel away from any interference.

How much power does the 500 Series bridge transmit?At all times the 500 Series bridge operates within country / region specific regulations for radio power emissions. In addition, the 500 Series bridge uses a technique known as Transmit Power Control (TPC) to ensure that it only transmits sufficient radio power such that the other antenna can receive a high quality signal.

How does the PTP 500 Series Bridge avoid interference from other devices nearby? At initialization, the 500 Series bridge monitors the available frequency channels to find a channel

FAQs

that is clear of interference. In operation 500 Series bridge continuously monitors the spectrum to ensure it is operating on the cleanest channel.

How does the 500 Series bridge integrate into my data network?The 500 Series bridge acts as a transparent bridge between two segments of your network. In this sense, it can be treated like a virtual wired connection between the two buildings. The 500 Series bridge forwards 802.3 Ethernet packets destined for the other part of the network and filters packets it does not need to forward. The system is transparent to higher-level management systems such as VLANs and Spanning Tree.

How does the 500 Series bridge provide security for data traffic?The 500 Series bridge has a range of security features. At installation time each link must be programmed with the serial ID of its partner. The two ends of the link will only communicate with one another, eliminating any chance of “man in the middle” attacks. Over the air security is achieved through a proprietary scrambling mechanism that cannot be disabled, spoofed or snooped by commercial tools.

Can I use Apple Macintosh OS X to control and monitor my 500 Series bridge?Yes, but there are some restrictions. Mozilla 1.6 or higher is recommended.

19 Glossary

AES	Advanced Encryption Standard
ARP	Address Resolution Protocol
ARQ	Automatic Repeat reQuest
BPSK	Binary Phase Shift Keying
CAC	Channel Availability Check
DC	Direct Current Multiplex
DFS	Dynamic Frequency Selection
EIRP	Equivalent Isotropically Radiated Power
EMD	Earth Movers Distance
ETSI	European Telecommunications Standards Institute
FAQ	Frequently Asked Question
FCC	Federal
GPS	Global Positioning System
HTTP	Hypertext Transfer Protocol
ID	Identity
IEEE	Institute of Electrical and Electronic Engineers
i-DFS	Intelligent Dynamic Frequency Spectrum
IP	Internet Protocol
IQ	In phase / Quadrature
ISM	Industrial Scientific and Medical
ITU	International Telecommunications Union
LAN	Local Area Network
LED	Light Emitting Diode
LPU	Lightning Protection Unit
MAC	Medium Access Control Layer
MDI	Medium Dependent Interface
MDIX	Medium Dependent Interface Crossover UV Ultraviolet
MIMO	Multiple In Multiple Out
NIST	National Institute of Standards and Technology
NLOS	non-Line-of-Sight
ODU	Outdoor Unit
OFDM	Orthogonal Frequency Division
PC	IBM Compatible Personal Computer
PIDU+	Power Indoor Unit Plus
PING	Packet Internet Groper
PoE	Power over Ethernet
PSU	Power Supply Unit
PTP	Point-to-Point
QAM	Quadrature Amplitude Modulation
RAM	Random Access Memory
RTTT	Road Transport and Traffic Telematics
STC	Space Time Coding
STP	Shielded Twisted Pair
TCP	Transmission Control Protocol
TPC	Transmit Power Control
URL	Universal Resource Location
USA	United States of America

Glossary

UTP	Unshielded Twisted Pair
VLAN	Virtual Local Area Network

Unit A1, Linhay Business Park
Eastern Road, Ashburton
Devon, TQ13 7UP, UK
Telephone Support: +1 877 515-0400 (Worldwide)
+44 803 234 4640 (UK)
www.motorola.com/ptp