



**DFS PORTION OF  
FCC CFR47 PART 15 SUBPART E  
INDUSTRY CANADA RSS-210 ISSUE 7  
CERTIFICATION TEST REPORT**

**FOR**

**MOTOROLA POINT TO POINT WIRELESS BRIDGE**

**MODEL NUMBER: PTP54500, PTP54300**

**FCC ID: QWP54500**

**IC: 109AO-54500**

**REPORT NUMBER: 08U11557-1**

**ISSUE DATE: FEBRUARY 27, 2008**

*Prepared for*  
**MOTOROLA POINT TO POINT FIXED WIRELESS SOLUTIONS GROUP.  
UNIT A1, LINHAY BUSINESS PARK  
EASTERN ROAD  
ASHBURTON  
DEVON  
TQ13 7UP UNITED KINGDOM**

*Prepared by*  
**COMPLIANCE CERTIFICATION SERVICES  
47173 BENICIA STREET  
FREMONT, CA 94538, U.S.A.  
TEL: (510) 771-1000  
FAX: (510) 661-0888**



**NVLAP LAB CODE 200065-0**

Revision History

<u>Rev.</u>	<u>Issue Date</u>	<u>Revisions</u>	<u>Revised By</u>
--	02/27/2008	Initial Issue	M. Heckrotte

## TABLE OF CONTENTS

<b>1. ATTESTATION OF TEST RESULTS</b> .....	<b>4</b>
<b>2. TEST METHODOLOGY</b> .....	<b>5</b>
<b>3. FACILITIES AND ACCREDITATION</b> .....	<b>5</b>
<b>4. CALIBRATION AND UNCERTAINTY</b> .....	<b>5</b>
4.1. <i>MEASURING INSTRUMENT CALIBRATION</i> .....	5
4.2. <i>MEASUREMENT UNCERTAINTY</i> .....	5
<b>5. DYNAMIC FREQUENCY SELECTION</b> .....	<b>6</b>
5.1. <i>OVERVIEW</i> .....	6
5.1.1. <i>LIMITS</i> .....	6
5.1.2. <i>TEST AND MEASUREMENT SYSTEM</i> .....	10
5.1.3. <i>SETUP OF EUT</i> .....	13
5.1.4. <i>DESCRIPTION OF EUT</i> .....	14
5.2. <i>MASTER DEVICE RESULTS</i> .....	15
5.2.1. <i>TEST CHANNEL</i> .....	15
5.2.2. <i>PLOTS OF RADAR WAVEFORMS AND WLAN TRAFFIC</i> .....	15
5.2.3. <i>CHANNEL AVAILABILITY CHECK TIME</i> .....	22
5.2.4. <i>OVERLAPPING CHANNEL TESTS</i> .....	27
5.2.5. <i>MOVE AND CLOSING TIME</i> .....	28
5.2.6. <i>NON-OCCUPANCY PERIOD</i> .....	34
5.2.7. <i>DETECTION BANDWIDTH</i> .....	35
5.2.8. <i>IN-SERVICE MONITORING</i> .....	37
5.3. <i>SLAVE DEVICE CONFIGURATION</i> .....	44
5.3.1. <i>TEST CHANNEL</i> .....	44
5.3.2. <i>PLOT OF WLAN TRAFFIC</i> .....	44
5.3.3. <i>MOVE AND CLOSING TIME</i> .....	45
5.3.4. <i>SLAVE NON-OCCUPANCY</i> .....	50
<b>6. SETUP PHOTOS</b> .....	<b>52</b>

# 1. ATTESTATION OF TEST RESULTS

**COMPANY NAME:** MOTOROLA POINT TO POINT FIXED WIRELESS SOLUTIONS  
UNIT A1, LINHAY BUSINESS PARK  
EASTERN ROAD  
ASHBURTON  
DEVON  
TQ13 7UP  
UNITED KINGDOM

**EUT DESCRIPTION:** MOTOROLA POINT TO POINT WIRELESS BRIDGE

**MODEL:** PTP54500, PTP54300

**SERIAL NUMBER:** 00045620000C(SERVER), 000456200000(CLIENT)

**DATE TESTED:** JANUARY 28-29, 2008

APPLICABLE STANDARDS	
STANDARD	TEST RESULTS
DFS Portion of CFR 47 Part 15 Subpart E	No Non-Compliance Noted
DFS Portion of RSS-210 Issue 7 Annex 9	No Non-Compliance Noted

Compliance Certification Services, Inc. tested the above equipment in accordance with the requirements set forth in the above standards. The test results show that the equipment tested is capable of demonstrating compliance with the requirements as documented in this report.

**Note:** The results documented in this report apply only to the tested sample, under the conditions and modes of operation as described herein. This document may not be altered or revised in any way unless done so by Compliance Certification Services and all revisions are duly noted in the revisions section. Any alteration of this document not carried out by Compliance Certification Services will constitute fraud and shall nullify the document. No part of this report may be used to claim product certification, approval, or endorsement by NVLAP, NIST, or any government agency.

Approved & Released For CCS By:

Tested By:



MICHAEL HECKROTTE  
DIRECTOR OF ENGINEERING  
COMPLIANCE CERTIFICATION SERVICES

DOUGLAS ANDERSON  
EMC TECHNICIAN  
COMPLIANCE CERTIFICATION SERVICES

## 2. TEST METHODOLOGY

The tests documented in this report were performed in accordance with the DFS portions of FCC CFR 47 Part 15, FCC MO&O 06-96, and RSS-210 Issue 7.

## 3. FACILITIES AND ACCREDITATION

The test sites and measurement facilities used to collect data are located at 47173 Benicia Street, Fremont, California, USA.  
CCS is accredited by NVLAP, Laboratory Code 200065-0. The full scope of accreditation can be viewed at <http://www.ccsemc.com>.

## 4. CALIBRATION AND UNCERTAINTY

### 4.1. MEASURING INSTRUMENT CALIBRATION

The measuring equipment utilized to perform the tests documented in this report has been calibrated in accordance with the manufacturer's recommendations, and is traceable to recognized national standards.

### 4.2. MEASUREMENT UNCERTAINTY

Where relevant, the following measurement uncertainty levels have been estimated for tests performed on the apparatus:

PARAMETER	UNCERTAINTY
Power Line Conducted Emission	+/- 2.3 dB
Radiated Emission	+/- 3.4 dB

Uncertainty figures are valid to a confidence level of 95%.

## 5. DYNAMIC FREQUENCY SELECTION

### 5.1. OVERVIEW

#### 5.1.1. LIMITS

##### INDUSTRY CANADA

IC RSS-210 is closely harmonized with FCC Part 15 DFS rules. The deviations are as follows:

RSS-210 Issue 7 A9.4 (b) (ii) **Channel Availability Check Time:** ...

**Additional requirements for the band 5600-5650 MHz:** Until further notice, devices subject to this Section shall not be capable of transmitting in the band 5600-5650 MHz, so that Environment Canada weather radars operating in this band are protected.

RSS-210 Issue 7 A9.4 (b) (iv) **Channel closing time:** the maximum channel closing time is 260 ms.

##### FCC

§15.407 (h) and FCC 06-96 APPENDIX "COMPLIANCE MEASUREMENT PROCEDURES FOR UNLICENSED-NATIONAL INFORMATION INFRASTRUCTURE DEVCIES OPERATING IN THE 5250-5350 MHz AND 5470-5725 MHz BANDS INCORPORATING DYNAMIC FREQUENCY SELECTION".

**Table 1: Applicability of DFS requirements prior to use of a channel**

Requirement	Operational Mode		
	Master	Client (without radar detection)	Client (with radar detection)
Non-Occupancy Period	Yes	Not required	Yes
DFS Detection Threshold	Yes	Not required	Yes
Channel Availability Check Time	Yes	Not required	Not required
Uniform Spreading	Yes	Not required	Not required

**Table 2: Applicability of DFS requirements during normal operation**

Requirement	Operational Mode		
	Master	Client (without DFS)	Client (with DFS)
DFS Detection Threshold	Yes	Not required	Yes
Channel Closing Transmission Time	Yes	Yes	Yes
Channel Move Time	Yes	Yes	Yes

**Table 3: Interference Threshold values, Master or Client incorporating In-Service Monitoring**

Maximum Transmit Power	Value (see note)
≥ 200 milliwatt	-64 dBm
< 200 milliwatt	-62 dBm
<p>Note 1: This is the level at the input of the receiver assuming a 0 dBi receive antenna          Note 2: Throughout these test procedures an additional 1 dB has been added to the amplitude of the test transmission waveforms to account for variations in measurement equipment. This will ensure that the test signal is at or above the detection threshold level to trigger a DFS response.</p>	

**Table 4: DFS Response requirement values**

Parameter	Value
<i>Non-occupancy period</i>	30 minutes
<i>Channel Availability Check Time</i>	60 seconds
<i>Channel Move Time</i>	10 seconds
<i>Channel Closing Transmission Time</i>	200 milliseconds + approx. 60 milliseconds over remaining 10 second period
<p>The instant that the <i>Channel Move Time</i> and the <i>Channel Closing Transmission Time</i> begins is as follows:            For the Short pulse radar Test Signals this instant is the end of the <i>Burst</i>.            For the Frequency Hopping radar Test Signal, this instant is the end of the last radar burst generated.            For the Long Pulse radar Test Signal this instant is the end of the 12 second period defining the radar transmission.            The Channel Closing Transmission Time is comprised of 200 milliseconds starting at the beginning of the Channel Move Time plus any additional intermittent control signals required to facilitate channel changes (an aggregate of approximately 60 milliseconds) during the remainder of the 10 second period. The aggregate duration of control signals will not count quiet periods in between transmissions.</p>	



**Table 5 – Short Pulse Radar Test Waveforms**

Radar Type	Pulse Width (Microseconds)	PRI (Microseconds)	Pulses	Minimum Percentage of Successful Detection	Minimum Trials
1	1	1428	18	60%	30
2	1-5	150-230	23-29	60%	30
3	6-10	200-500	16-18	60%	30
4	11-20	200-500	12-16	60%	30
Aggregate (Radar Types 1-4)				80%	120

**Table 6 – Long Pulse Radar Test Signal**

Radar Waveform	Bursts	Pulses per Burst	Pulse Width (µsec)	Chirp Width (MHz)	PRI (µsec)	Minimum Percentage of Successful Detection	Minimum Trials
5	8-20	1-3	50-100	5-20	1000-2000	80%	30

**Table 7 – Frequency Hopping Radar Test Signal**

Radar Waveform	Pulse Width (µsec)	PRI (µsec)	Burst Length (ms)	Pulses per Hop	Hopping Rate (kHz)	Minimum Percentage of Successful Detection	Minimum Trials
6	1	333	300	9	.333	70%	30

### 5.1.2. TEST AND MEASUREMENT SYSTEM

#### CONDUCTED METHOD SYSTEM BLOCK DIAGRAM

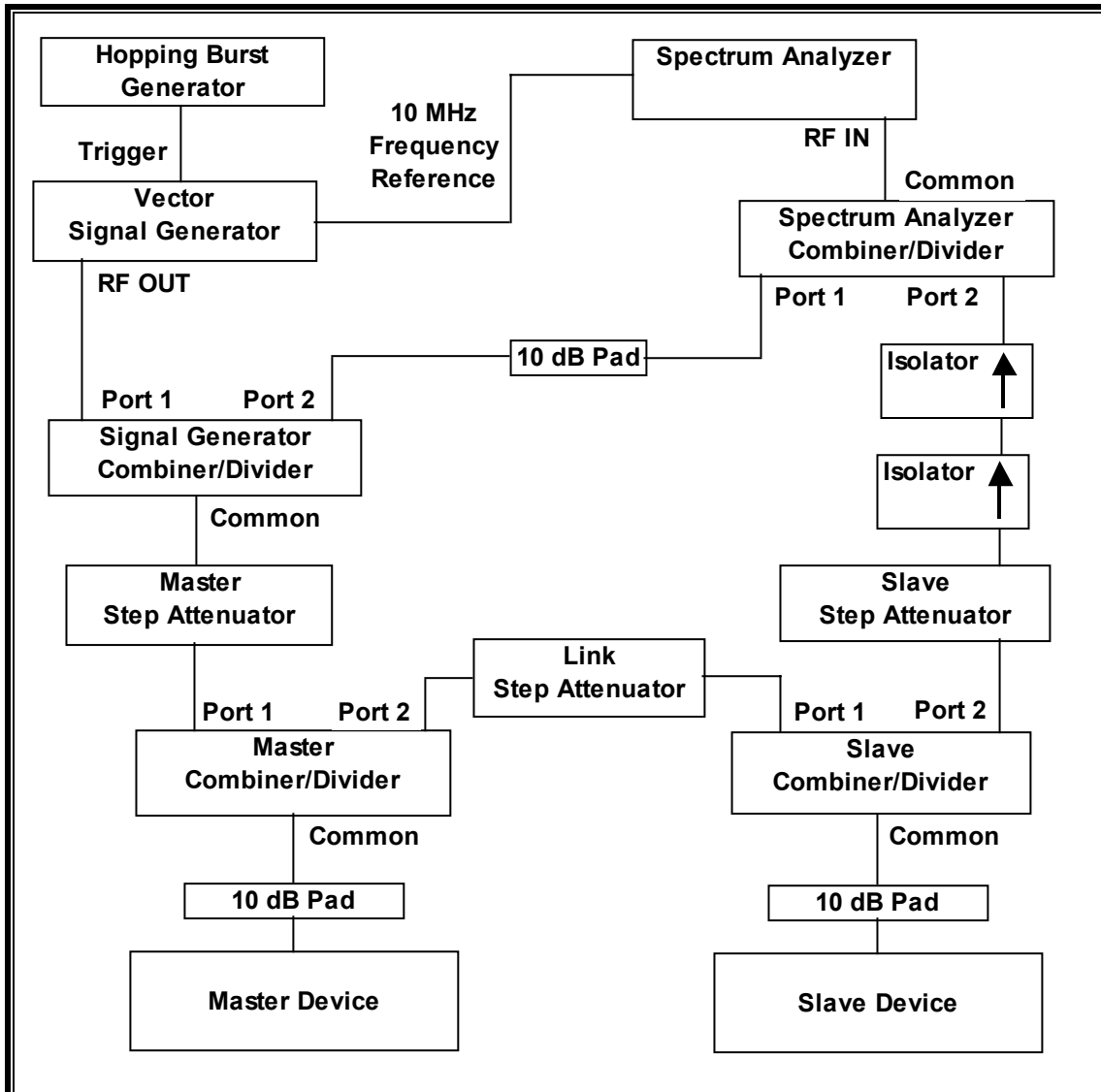

## **SYSTEM OVERVIEW**

The short pulse and long pulse signal generating system utilizes the NTIA software. The Vector Signal Generator has been validated by the NTIA. The hopping signal generating system utilizes the CCS simulated hopping method and system, which has been validated by the DoD, FCC and NTIA. The software selects waveform parameters from within the bounds of the signal type on a random basis using uniform distribution.

The short pulse types 2, 3 and 4, and the long pulse type 5 parameters are randomized at run-time.

The hopping type 6 pulse parameters are fixed while the hopping sequence is based on the August 2005 NTIA Hopping Frequency List. The initial starting point randomized at run-time and each subsequent starting point is incremented by 475. Each frequency in the 100-length segment is compared to the boundaries of the EUT Detection Bandwidth and the software creates a hopping burst pattern in accordance with Section 7.4.1.3 Method #2 Simulated Frequency Hopping Radar Waveform Generating Subsystem of FCC 06-96 APPENDIX. The frequency of the signal generator is incremented in 1 MHz steps from  $F_L$  to  $F_H$  for each successive trial. This incremental sequence is repeated as required to generate a minimum of 30 total trials and to maintain a uniform frequency distribution over the entire Detection Bandwidth.

The signal monitoring equipment consists of a spectrum analyzer set to display 8001 bins on the horizontal axis. The time-domain resolution is 2 msec / bin with a 16 second sweep time, meeting the 10 second short pulse reporting criteria. The aggregate ON time is calculated by multiplying the number of bins above a threshold during a particular observation period by the dwell time per bin, with the analyzer set to peak detection and max hold.

## **SYSTEM CALIBRATION**

A 50-ohm load is connected in place of the spectrum analyzer, and the spectrum analyzer is connected in place of the master device and the signal generator is set to CW mode. The amplitude of the signal generator is adjusted to yield a level of -64 dBm as measured on the spectrum analyzer.

Without changing any of the instrument settings, the spectrum analyzer is reconnected to the Common port of the Spectrum Analyzer Combiner/Divider. Measure the amplitude and calculate the difference from -64 dBm. Adjust the Reference Level Offset of the spectrum analyzer to this difference.

The spectrum analyzer displays the level of the signal generator as received at the antenna ports of the Master Device. The interference detection threshold may be varied from the calibrated value of -64 dBm and the spectrum analyzer will still indicate the level as received by the Master Device.

Set the signal generator to produce a radar waveform, trigger a burst manually and measure the level on the spectrum analyzer. Readjust the amplitude of the signal generator as required so that the peak level of the waveform is at a displayed level equal to the required or desired interference detection threshold. Separate signal generator amplitude settings are determined as required for each radar type.

### **ADJUSTMENT OF DISPLAYED TRAFFIC LEVEL**

Establish a link between the Master and Slave, adjusting the Link Step Attenuator as needed to provide a suitable received level at the Master and Slave devices. Stream the video test file to generate WLAN traffic. Confirm that the WLAN traffic level, as displayed on the spectrum analyzer, is at lower amplitude than the radar detection threshold. For Master Device testing confirm that the displayed traffic does not include Slave Device traffic. For Slave Device testing confirm that the displayed traffic does not include Master Device traffic.

If a different setting of the Master Step Attenuator is required to meet the above conditions, perform a new System Calibration for the new Master Step Attenuator setting.

### **TEST AND MEASUREMENT EQUIPMENT**

The following test and measurement equipment was utilized for the DFS tests documented in this report:

<b>TEST EQUIPMENT LIST</b>				
<b>Description</b>	<b>Manufacturer</b>	<b>Model</b>	<b>Asset Number</b>	<b>Cal Due</b>
<b>Spectrum Analyzer, 44 GHz</b>	<b>Agilent / HP</b>	<b>E4446A</b>	<b>C00986</b>	<b>05/30/09</b>
<b>Vector Signal Generator, 20GHz</b>	<b>Agilent / HP</b>	<b>E8267C</b>	<b>C01066</b>	<b>11/16/2009</b>
<b>Arbitrary Waveform Generator</b>	<b>Agilent / HP</b>	<b>33220A</b>	<b>C01146</b>	<b>05/02/08</b>

### 5.1.3. SETUP OF EUT

#### CONDUCTED METHOD EUT TEST SETUP

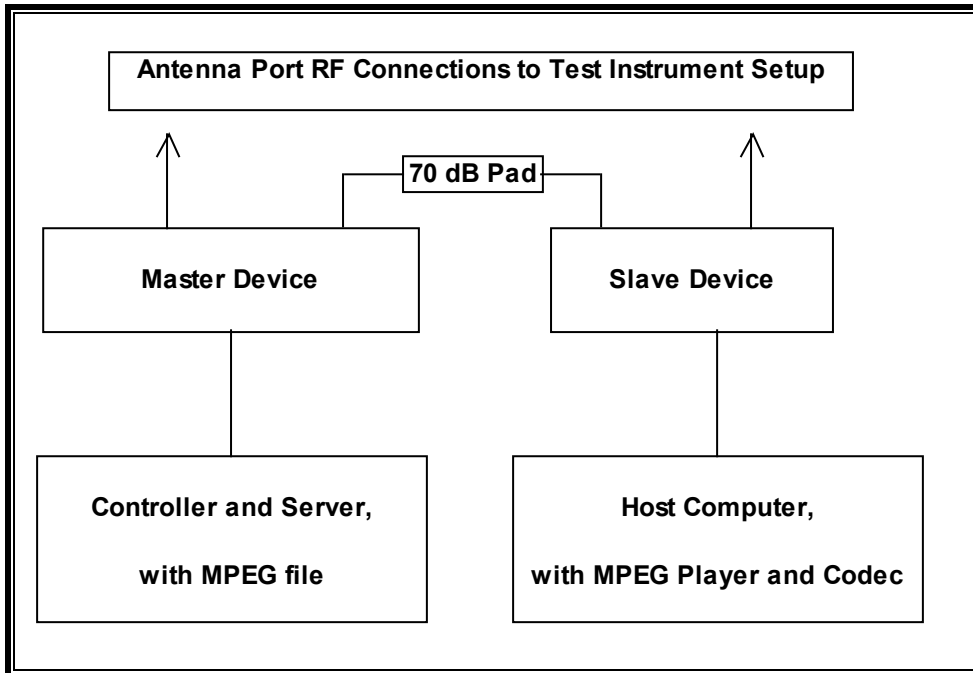

#### SUPPORT EQUIPMENT

The following test and measurement equipment was utilized for the DFS tests documented in this report:

PERIPHERAL SUPPORT EQUIPMENT LIST				
Description	Manufacturer	Model	Serial Number	FCC ID
Laptop PC (Master)	Compaq	PP2160	CNU327025L	DoC
AC Adapter (Master)	Compaq	PA-1900-05H	CT-565BC0ALLOJ1BE	N/A
Desktop PC (Slave)	Dell	DCTA	04GYXB1	DoC
Monitor	LG	L1718S	608UXMT17275	DoC
USB Keyboard	Dell	L100	CN-0RH659-73571-6HT-01F0	DoC
USB Mouse	Dell	MO58UC	F1900CX2	DoC
PDIU (Master)	Motorola	WB2521	0736299880	DoC
PDIU (Slave)	Motorola	WB2521	0736299735	DoC

#### **5.1.4. DESCRIPTION OF EUT**

The EUT operates over the 5470-5725 MHz range.

The EUT can be configured as a Master Device or a Slave Device without Radar Detection.

The highest power level within these bands is 28 dBm EIRP.

The highest gain antenna assembly utilized with the EUT has a gain of 33.9 dBi. The lowest gain antenna assembly utilized with the EUT has a gain of 23 dBi

The rated output power of the Master unit is > 23dBm (EIRP). Therefore the required interference threshold level is -64 dBm. After correction for antenna gain and procedural adjustments, the required conducted threshold at the antenna port is  $-64 + 23 + 1 = -40$  dBm.

The calibrated conducted DFS Detection Threshold level is set to -41 dBm. The tested level is lower than the required level hence it provides margin to the limit.

The EUT uses two transmitter/receiver chains, each connected to a 50-ohm coaxial antenna port. The Vertical antenna ports are connected to the test system to perform conducted tests. The Horizontal antenna ports are connected via 70 dB attenuation.

The Slave device associated with the EUT during these tests does not have radar detection capability.

WLAN traffic is generated by streaming the video file TestFile.mp2 "6 ½ Magic Hours" from the Master to the Slave in full motion video mode using the media player with the V2.61 Codec package.

TPC is required since the maximum EIRP is greater than 500 mW (27 dBm).

The EUT utilizes a proprietary, frame-based architecture. One nominal channel bandwidth, 15 MHz, is implemented. The channel spacing is 5 MHz.

The frame timing parameters are set to a Tx / Rx ratio of 48% / 52%, which is worst-case compared to the suggested ratio of 40% / 60%.

The software installed in the EUT is revision B484.

#### **MANUFACTURER'S STATEMENT REGARDING UNIFORM CHANNEL SPREADING**

This statement is in a separate document.

## 5.2. MASTER DEVICE RESULTS

### 5.2.1. TEST CHANNEL

All tests were performed at a channel center frequency of 5550 MHz. Measurements were performed using conducted test methods.

### 5.2.2. PLOTS OF RADAR WAVEFORMS AND WLAN TRAFFIC

#### PLOTS OF RADAR WAVEFORMS

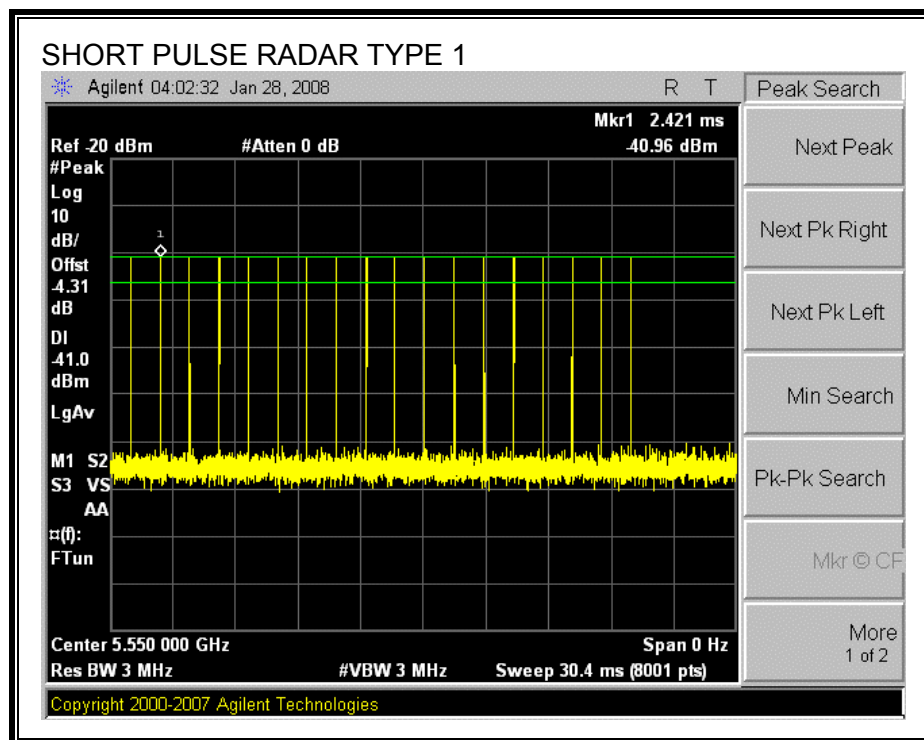

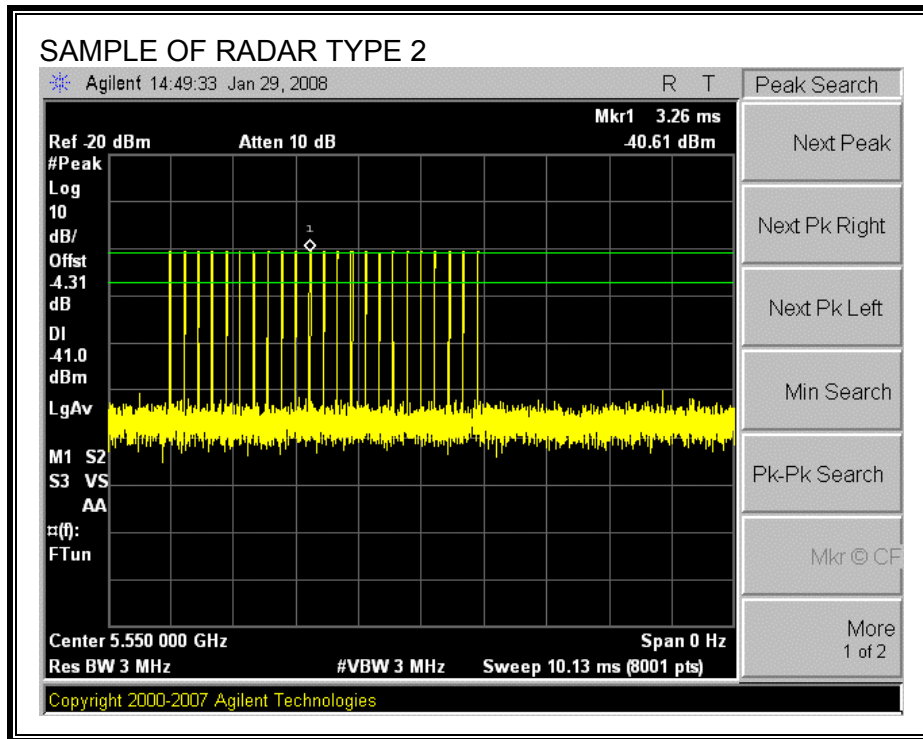



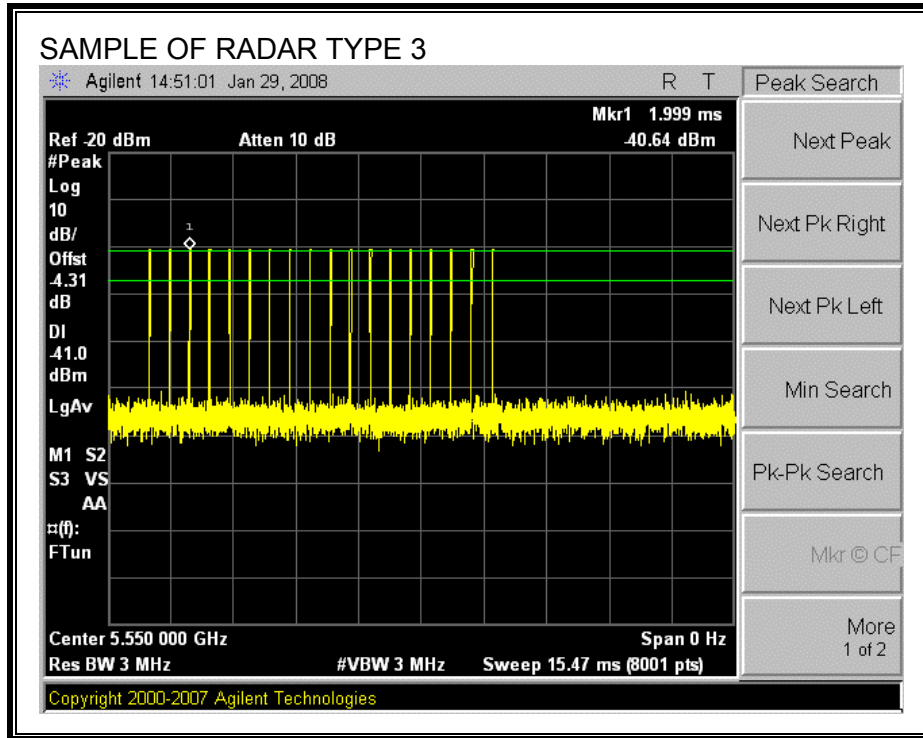

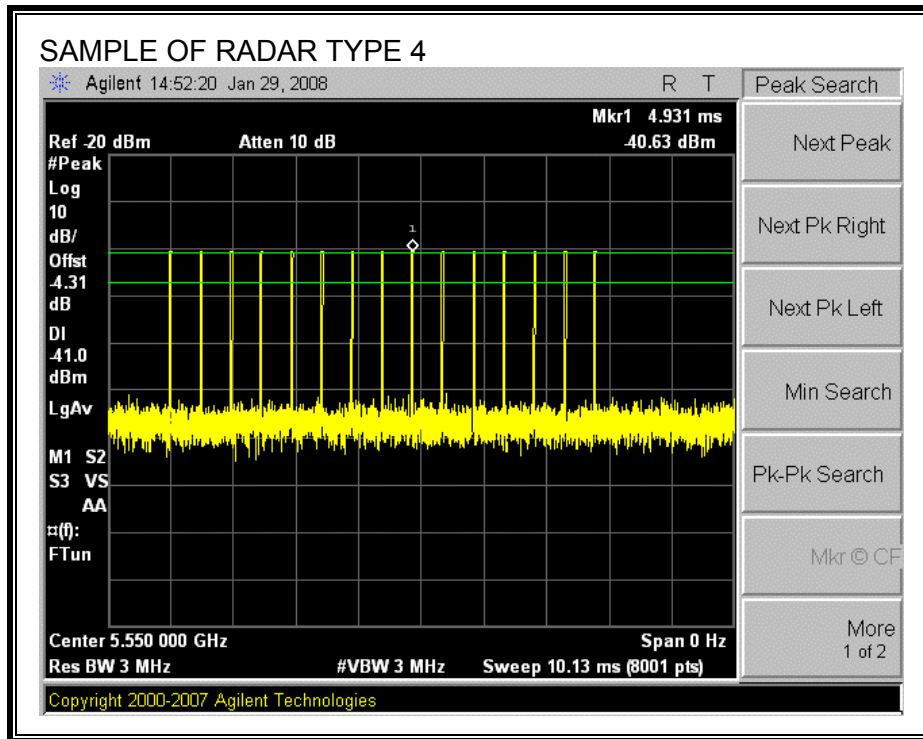

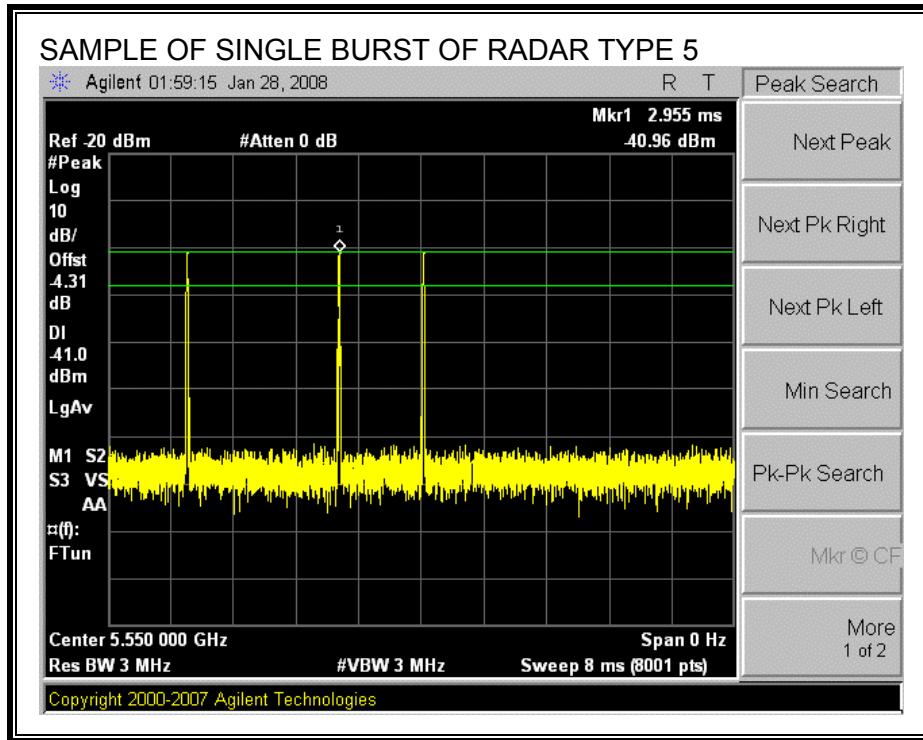

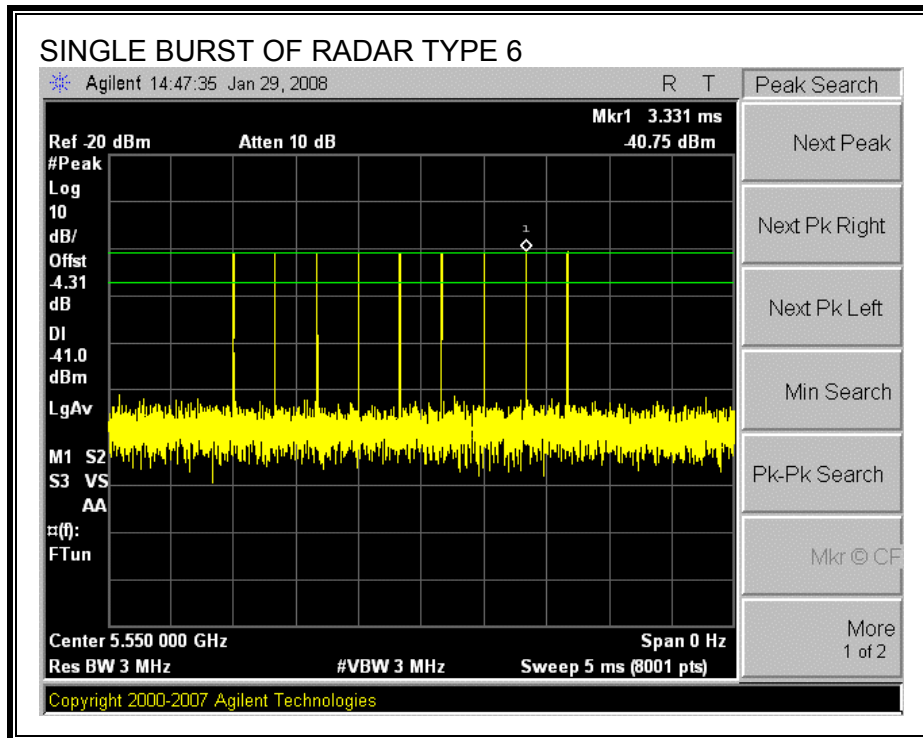

**PLOT OF WLAN TRAFFIC FROM MASTER**

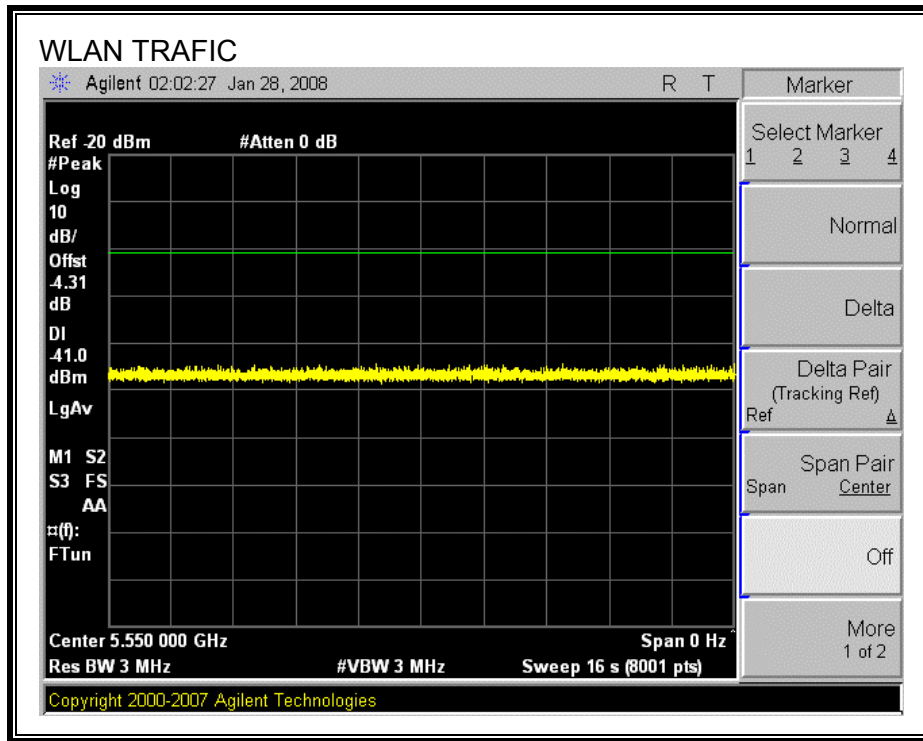

### **5.2.3. CHANNEL AVAILABILITY CHECK TIME**

#### **PROCEDURE TO DETERMINE INITIAL POWER-UP CYCLE TIME**

A link was established on channel then the EUT was rebooted. The time from the cessation of traffic to the re-initialization of traffic was measured as the time required for the EUT to complete the total power-up cycle. The time to complete the initial power-up period is 60 seconds less than this total power-up time.

#### **PROCEDURE FOR TIMING OF RADAR BURST**

With a link established on channel, the EUT was rebooted. A radar signal was triggered within 0 to 6 seconds after the initial power-up period, and transmissions on the channel were monitored on the spectrum analyzer.

The Non-Occupancy list was cleared. With a link established on channel, the EUT was rebooted. A radar signal was triggered within 54 to 60 seconds after the initial power-up period, and transmissions on the channel were monitored on the spectrum analyzer.

**QUANTITATIVE RESULTS**

**No Radar Triggered**

Timing of Reboot (sec)	Timing of Start of Traffic (sec)	Total Power-up Cycle Time (sec)	Initial Power-up Cycle Time (sec)
2.93	108.9	106.0	46.0

**Radar Near Beginning of CAC**

Timing of Reboot (sec)	Timing of Radar Burst (sec)	Radar Relative to Reboot (sec)	Radar Relative to Start of CAC (sec)
10.45	58.1	47.6	1.6

**Radar Near End of CAC**

Timing of Reboot (sec)	Timing of Radar Burst (sec)	Radar Relative to Reboot (sec)	Radar Relative to Start of CAC (sec)
10.6	113.1	102.5	56.5

**QUALITATIVE RESULTS**

Timing of Radar Burst	Display on Control Computer	Spectrum Analyzer Display
No Radar Triggered	EUT marks Channel as active	Transmissions begin on channel after completion of the initial power-up cycle and the CAC
Within 0 to 6 second window	EUT indicates radar detected EUT does not display any radar parameter values	No transmissions on channel
Within 54 to 60 second window	EUT indicates radar detected EUT does not display any radar parameter values	No transmissions on channel

**TIMING PLOT WITHOUT RADAR DURING CAC**

AP is rebooted  
Traffic ceases  
Start of Initial Power-up cycle

End of Initial Power-up cycle  
Start of CAC

End of CAC  
Traffic is Initiated

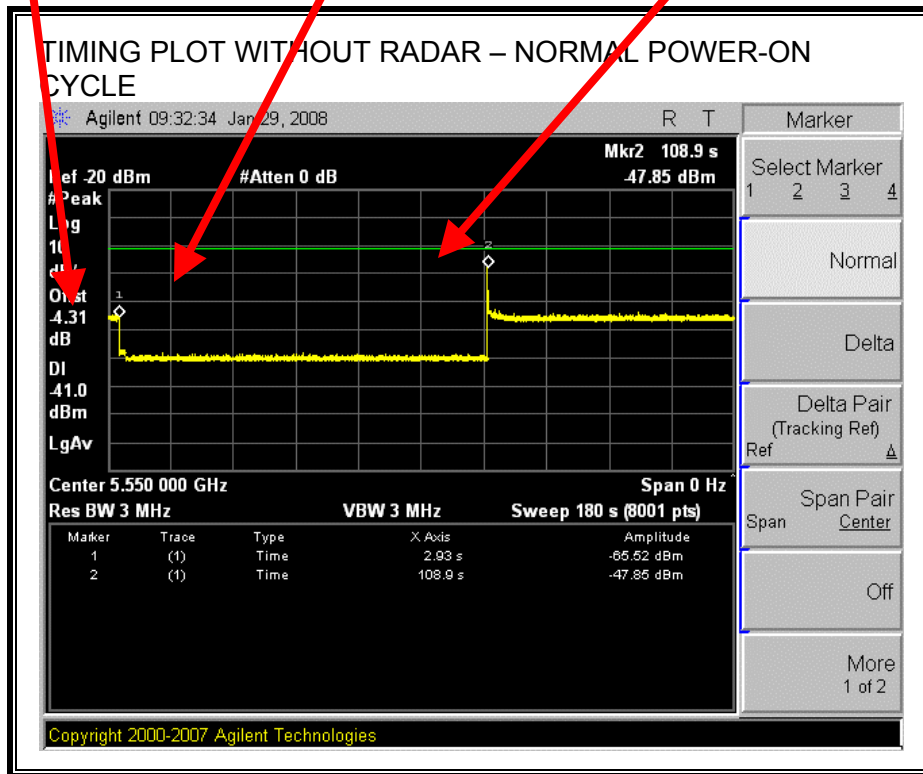

Transmissions begin on channel after completion of the initial power-up cycle and the CAC.



**TIMING PLOT WITH RADAR NEAR BEGINNING OF CAC**

AP is rebooted  
Traffic ceases  
Start of Initial Power-up cycle

End of Initial Power-up cycle  
Start of CAC

Radar Signal Applied

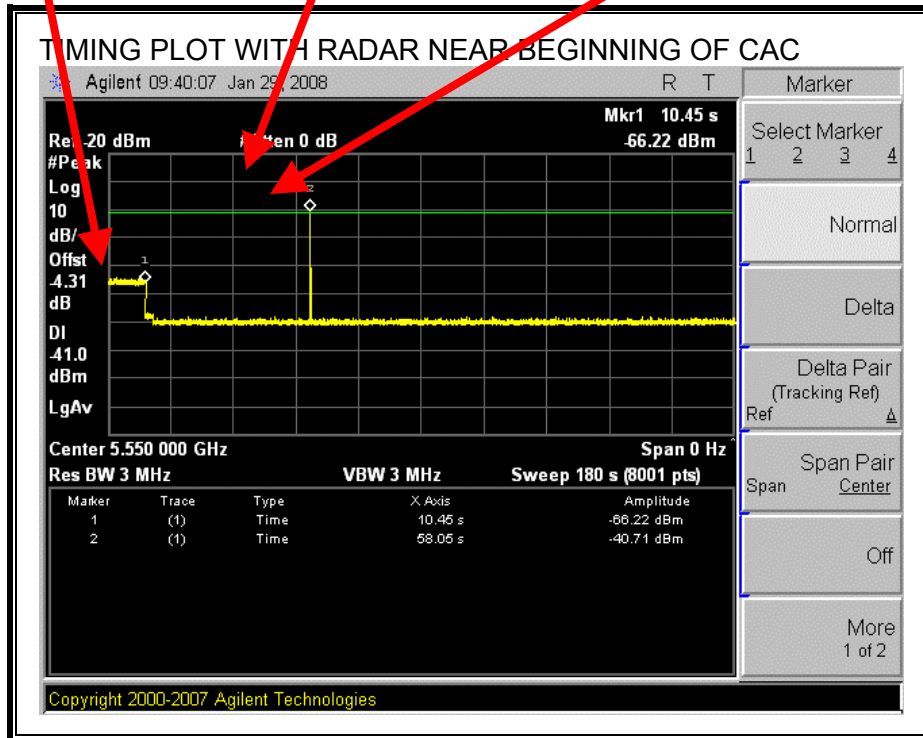

No EUT transmissions were observed after the radar signal.

**TIMING PLOT WITH RADAR NEAR END OF CAC**

AP is rebooted  
Traffic ceases  
Start of Initial Power-up cycle

End of Initial Power-up cycle  
Start of CAC

Radar Signal Applied

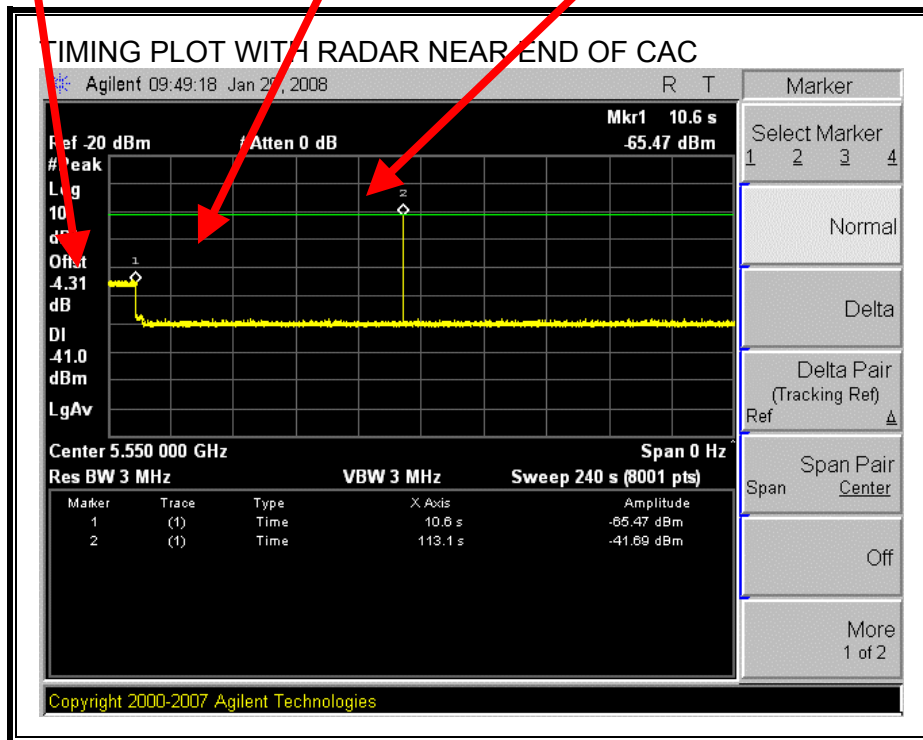

No EUT transmissions were observed after the radar signal.

## 5.2.4. OVERLAPPING CHANNEL TESTS

### PROCEDURE

The EUT was set to block all channels except 5550 MHz and 5555 MHz, which are overlapping. The active channel was 5550 MHz and the radar test frequency was 5550 MHz. A link was established on the active channel with the video file streaming. A radar burst was triggered and a stopwatch timer was started. The EUT was confirmed to vacate the active channel then a second radar burst was triggered approximately 45 seconds after the first.

### RESULTS

The EUT display indicated that 5550 MHz was blocked after the first radar burst was transmitted, but 5555 MHz remained available until the second radar burst was transmitted, at which time the display indicated that both 5550 MHz and 5555 MHz were blocked.

No beacons or traffic was observed on the spectrum analyzer after the first radar burst was transmitted.

### 5.2.5. MOVE AND CLOSING TIME

#### REPORTING NOTES

The reference marker is set at the end of last radar pulse.

The delta marker is set at the end of the last WLAN transmission following the radar pulse. This delta is the channel move time.

The aggregate channel closing transmission time is calculated as follows:

Aggregate Transmission Time =  
(Number of analyzer bins showing transmission) \* (dwell time per bin)

The observation period over which the FCC aggregate time is calculated begins at (Reference Marker + 200 msec) and ends no earlier than (Reference Marker + 10 sec).

The observation period over which the IC aggregate time is calculated begins at (Reference Marker) and ends no earlier than (Reference Marker + 10 sec).

#### RESULTS

Agency	Channel Move Time (sec)	Limit (sec)
FCC / IC	0.042	10

Agency	Aggregate Channel Closing Transmission Time (msec)	Limit (msec)
FCC	0.0	60
IC	42.0	260

**MOVE TIME**

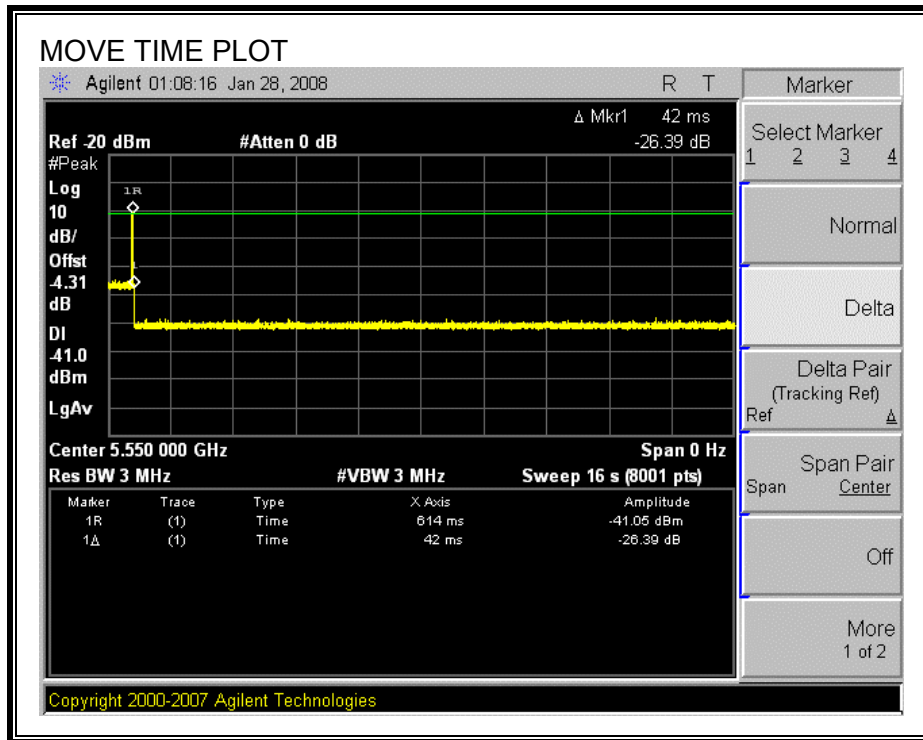

**CHANNEL CLOSING TIME**

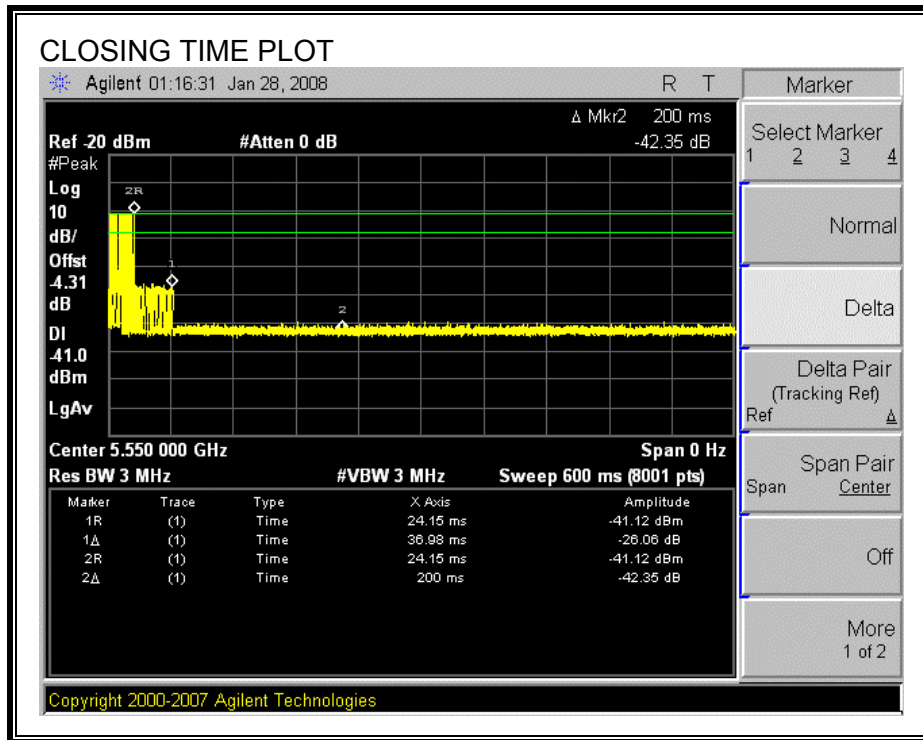

**AGGREGATE CHANNEL CLOSING TRANSMISSION TIME**

No transmissions are observed during the FCC aggregate monitoring period.

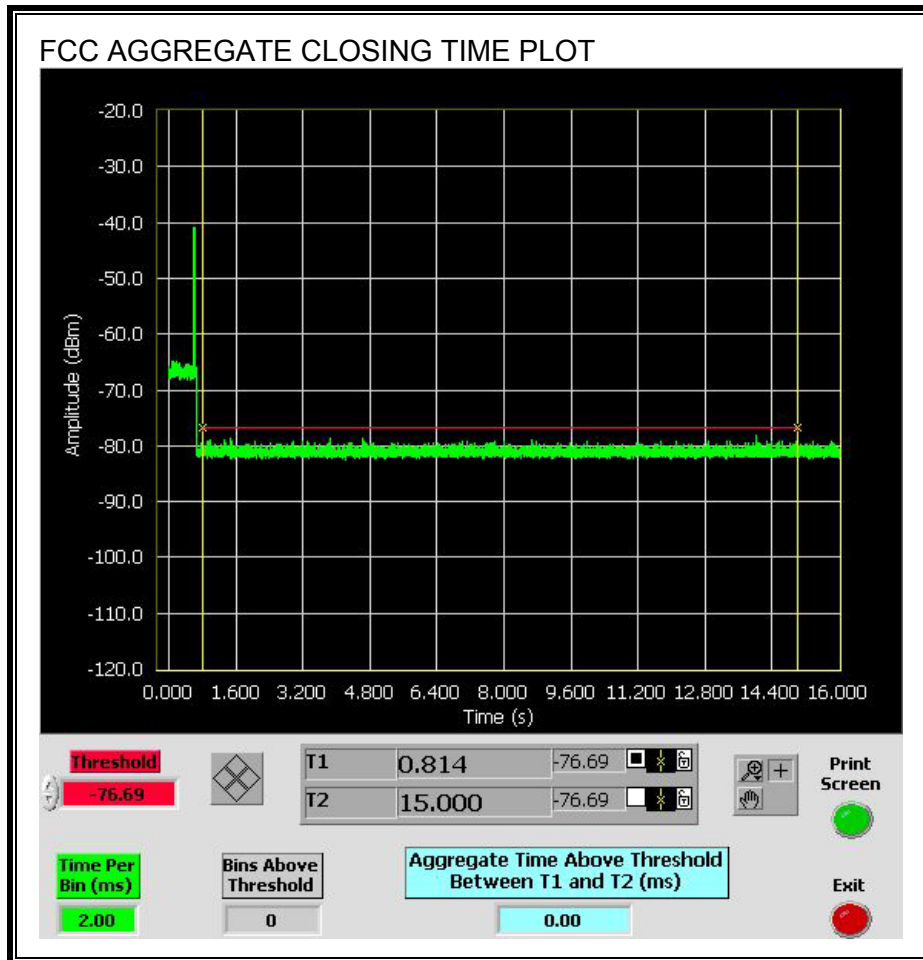

Only intermittent transmissions are observed during the IC aggregate monitoring period.

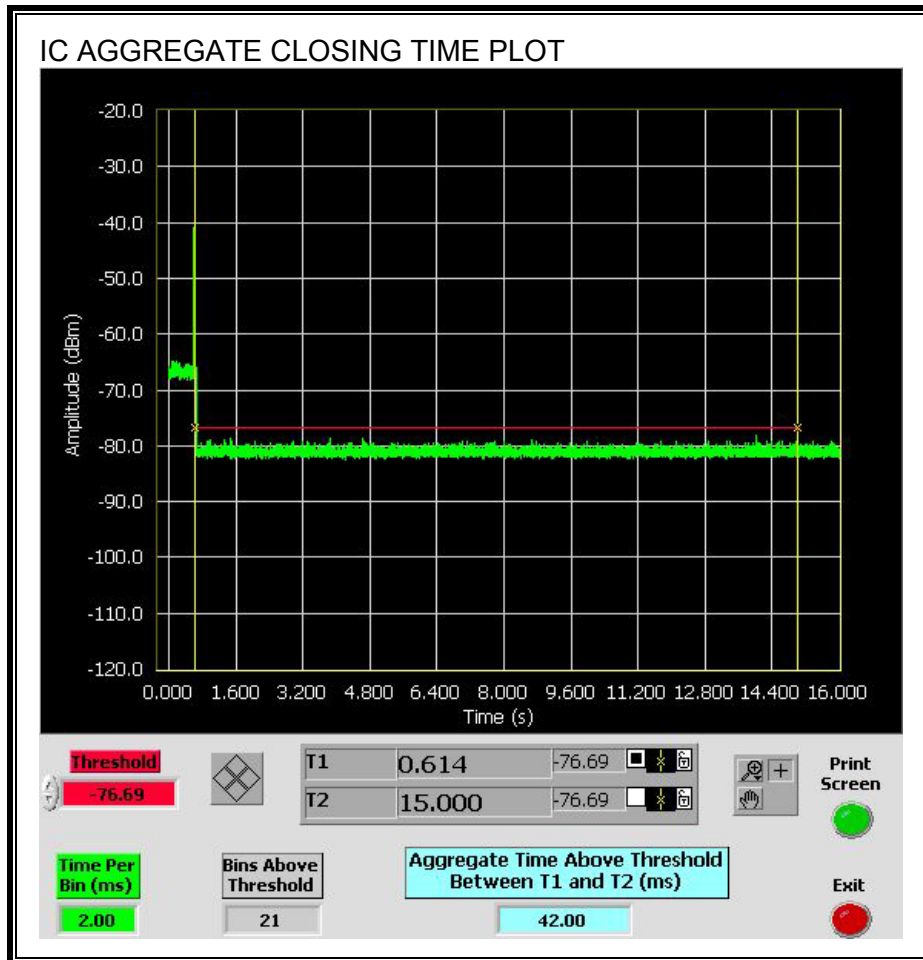



**LONG PULSE CHANNEL MOVE TIME**

The traffic ceases prior to 10 seconds after the end of the radar waveform.

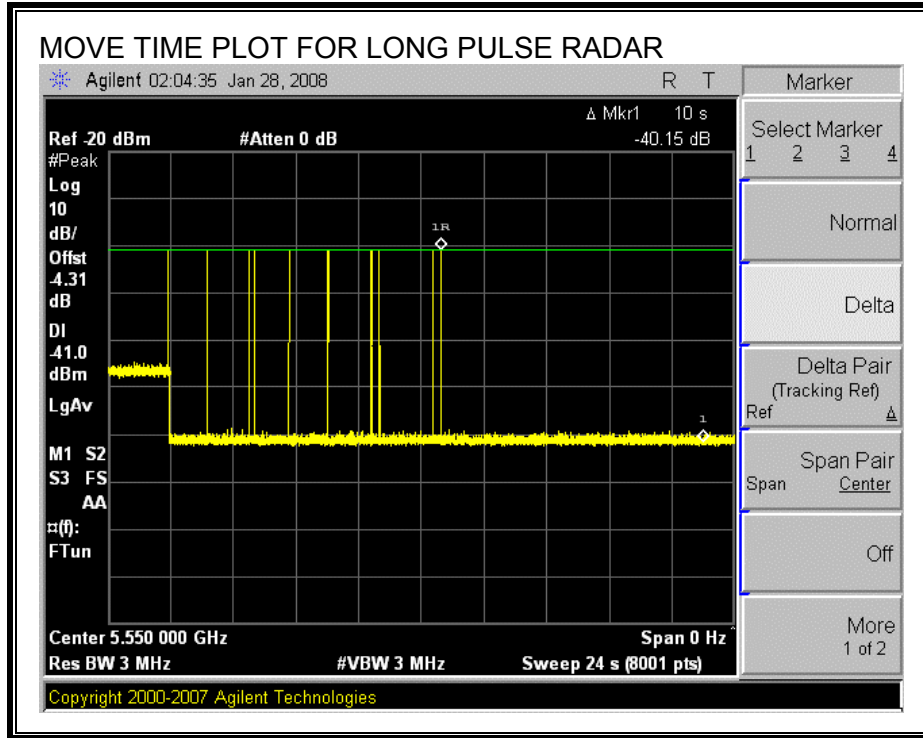

### 5.2.6. NON-OCCUPANCY PERIOD

#### RESULTS

No EUT transmissions were observed on the test channel during the 30-minute observation time.

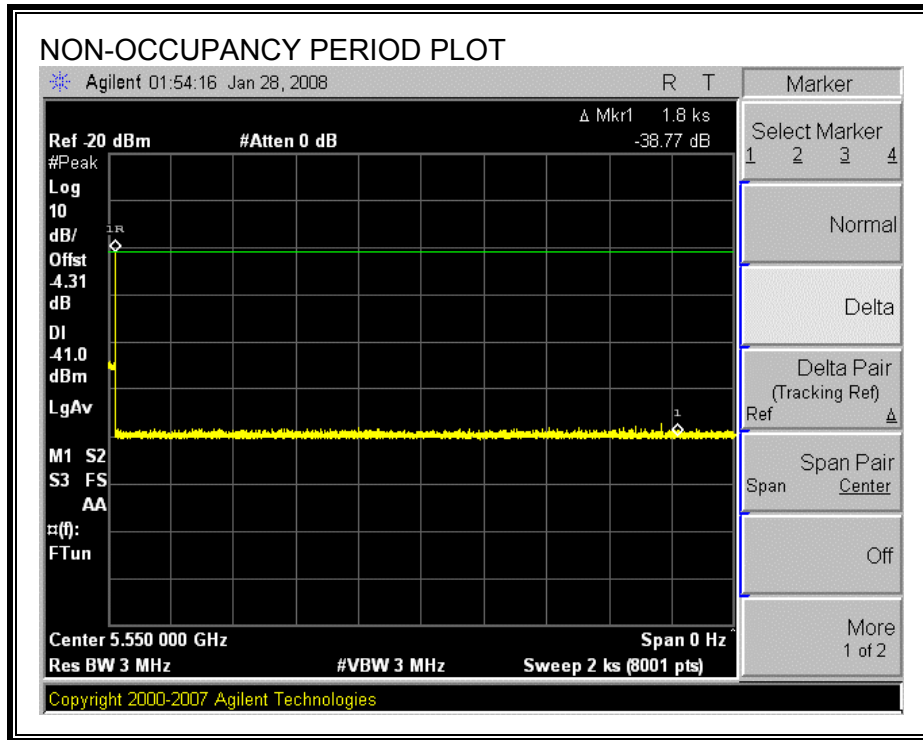

### 5.2.7. DETECTION BANDWIDTH

#### REFERENCE PLOT OF 99% POWER BANDWIDTH

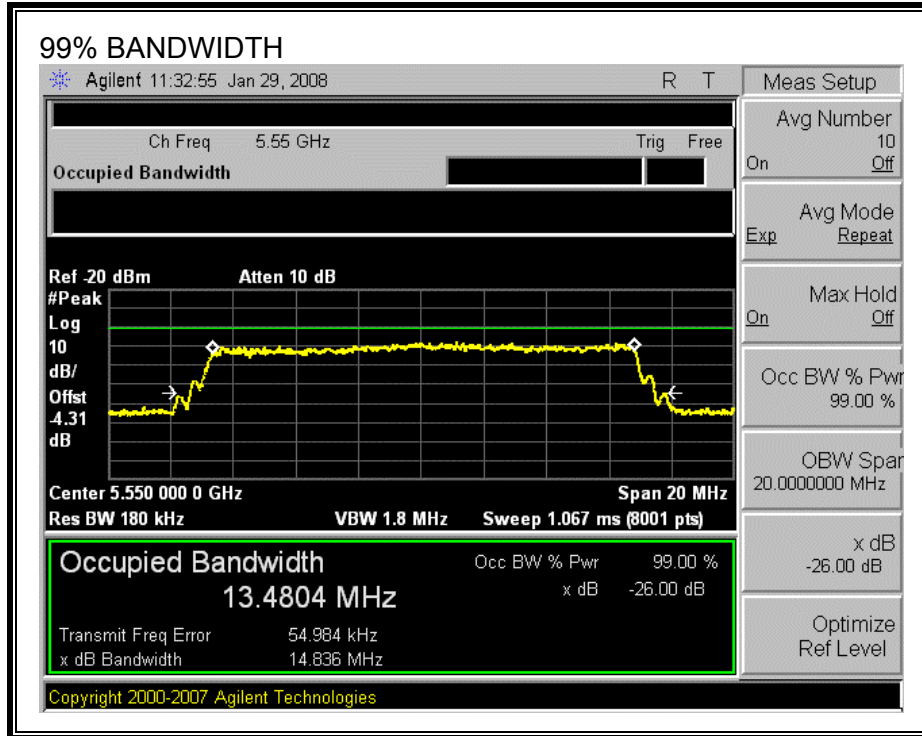

#### RESULTS

FL	FH	Detection Bandwidth	99% Power Bandwidth	Ratio of Detection BW to 99% Power BW	Minimum Limit
(MHz)	(MHz)	(MHz)	(MHz)	(%)	(%)
5543	5557	14	13.480	103.9	80

**DETECTION BANDWIDTH PROBABILITY**

<b>DETECTION BANDWIDTH PROBABILITY RESULTS</b>				
<b>Detection Bandwidth Test Results</b>				
<b>FCC Type 1 Waveform: 1 us Pulse Width, 1428 us PRI, 18 Pulses per Burst</b>				
<b>Frequency (MHz)</b>	<b>Number of Trials</b>	<b>Number Detected</b>	<b>Detection (%)</b>	<b>Mark</b>
5543	10	10	100	FL
5544	10	10	100	
5545	10	10	100	
5546	10	10	100	
5547	10	10	100	
5548	10	10	100	
5549	10	10	100	
5550	10	10	100	
5551	10	10	100	
5552	10	10	100	
5553	10	10	100	
5554	10	10	100	
5555	10	10	100	
5556	10	10	100	
5557	10	10	100	FH

### 5.2.8. IN-SERVICE MONITORING

#### RESULTS

<b>FCC Radar Test Summary</b>				
<b>Signal Type</b>	<b>Number of Trials</b>	<b>Detection (%)</b>	<b>Limit (%)</b>	<b>Pass/Fail</b>
FCC TYPE 1	30	100.00	60	Pass
FCC TYPE 2	30	100.00	60	Pass
FCC TYPE 3	30	100.00	60	Pass
FCC TYPE 4	30	100.00	60	Pass
Aggregate		100.00	80	Pass
FCC TYPE 5	30	100.00	80	Pass
FCC TYPE 6	30	100.00	70	Pass

**TYPE 1 DETECTION PROBABILITY**

<b>Data Sheet for FCC Fixed Radar Type 1</b>	
<b>1 us Pulse Width, 1428 us PRI, 18 Pulses per Burst</b>	
<b>Trial</b>	<b>Successful Detection (Yes/No)</b>
1	Yes
2	Yes
3	Yes
4	Yes
5	Yes
6	Yes
7	Yes
8	Yes
9	Yes
10	Yes
11	Yes
12	Yes
13	Yes
14	Yes
15	Yes
16	Yes
17	Yes
18	Yes
19	Yes
20	Yes
21	Yes
22	Yes
23	Yes
24	Yes
25	Yes
26	Yes
27	Yes
28	Yes
29	Yes
30	Yes

**TYPE 2 DETECTION PROBABILITY**

<b>Data Sheet for FCC Short Pulse Radar Type 2</b>				
<b>Waveform</b>	<b>Pulse Width (us)</b>	<b>PRI (us)</b>	<b>Pulses Per Burst</b>	<b>Successful Detection (Yes/No)</b>
2001	4	226.00	23	Yes
2002	2.7	218.00	26	Yes
2003	3.1	193.00	28	Yes
2004	1.4	213.00	23	Yes
2005	3	212.00	25	Yes
2006	4.6	191.00	25	Yes
2007	3.3	153.00	27	Yes
2008	4.5	185.00	26	Yes
2009	1.1	208.00	27	Yes
2010	1.3	195.00	25	Yes
2011	1.5	160.00	24	Yes
2012	4.1	203.00	28	Yes
2013	3.4	165.00	29	Yes
2014	1.8	211.00	23	Yes
2015	2.7	204.00	26	Yes
2016	1	216.00	23	Yes
2017	2.5	197.00	23	Yes
2018	1.3	156.00	25	Yes
2019	1.8	192.00	25	Yes
2020	5	191.00	28	Yes
2021	4.2	201.00	24	Yes
2022	1.9	219.00	27	Yes
2023	1.1	199.00	24	Yes
2024	3.8	212.00	24	Yes
2025	4.9	156.00	26	Yes
2026	3.8	167.00	28	Yes
2027	4.3	223.00	26	Yes
2028	2.8	164.00	28	Yes
2029	4.2	219.00	26	Yes
2030	1.1	189.00	25	Yes

**TYPE 3 DETECTION PROBABILITY**

<b>Data Sheet for FCC Short Pulse Radar Type 3</b>				
<b>Waveform</b>	<b>Pulse Width (us)</b>	<b>PRI (us)</b>	<b>Pulses Per Burst</b>	<b>Successful Detection (Yes/No)</b>
3001	9	498.00	18	Yes
3002	6.6	329.00	17	Yes
3003	7.2	390.00	16	Yes
3004	7.4	356.00	16	Yes
3005	5.1	343.00	16	Yes
3006	7.5	441.00	18	Yes
3007	8.9	361.00	16	Yes
3008	6.6	458.00	18	Yes
3009	5	270.00	18	Yes
3010	10	250.00	16	Yes
3011	8.2	266.00	17	Yes
3012	5.1	282.00	18	Yes
3013	9.2	430.00	18	Yes
3014	8.2	387.00	16	Yes
3015	7.2	329.00	18	Yes
3016	5.1	400.00	17	Yes
3017	6.4	262.00	16	Yes
3018	9.3	340.00	16	Yes
3019	9.3	319.00	16	Yes
3020	6.3	500.00	18	Yes
3021	6.4	471.00	17	Yes
3022	8.4	417.00	18	Yes
3023	6	419.00	17	Yes
3024	5.4	284.00	16	Yes
3025	7.4	311.00	16	Yes
3026	7.1	429.00	18	Yes
3027	9.2	339.00	16	Yes
3028	7	428.00	17	Yes
3029	8.1	416	16	Yes
3030	6.2	444	17	Yes



**TYPE 4 DETECTION PROBABILITY**

<b>Data Sheet for FCC Short Pulse Radar Type 4</b>				
<b>Waveform</b>	<b>Pulse Width (us)</b>	<b>PRI (us)</b>	<b>Pulses Per Burst</b>	<b>Successful Detection (Yes/No)</b>
4001	18.5	490.00	15	Yes
4002	13	264.00	13	Yes
4003	19.1	344.00	12	Yes
4004	15.9	317.00	15	Yes
4005	14.1	314.00	15	Yes
4006	19	403.00	14	Yes
4007	13.7	394.00	14	Yes
4008	11.2	445.00	14	Yes
4009	11.3	439.00	16	Yes
4010	19.4	446.00	16	Yes
4011	10.6	359.00	15	Yes
4012	14.4	330.00	12	Yes
4013	12.4	308.00	12	Yes
4014	14.1	396.00	16	Yes
4015	14	398.00	16	Yes
4016	19.3	453.00	14	Yes
4017	12.2	350.00	15	Yes
4018	12.2	472.00	16	Yes
4019	20	269.00	15	Yes
4020	16	365.00	12	Yes
4021	15.2	279.00	16	Yes
4022	10.2	422.00	15	Yes
4023	14.7	384.00	14	Yes
4024	13.2	342.00	14	Yes
4025	15.9	334.00	15	Yes
4026	15.3	284.00	15	Yes
4027	10.6	378.00	12	Yes
4028	18	355.00	16	Yes
4029	19.9	436.00	14	Yes
4030	10.3	269.00	12	Yes

**TYPE 5 DETECTION PROBABILITY**

<b>Data Sheet for FCC Long Pulse Radar Type 5</b>	
<b>Trial</b>	<b>Successful Detection (Yes/No)</b>
1	Yes
2	Yes
3	Yes
4	Yes
5	Yes
6	Yes
7	Yes
8	Yes
9	Yes
10	Yes
11	Yes
12	Yes
13	Yes
14	Yes
15	Yes
16	Yes
17	Yes
18	Yes
19	Yes
20	Yes
21	Yes
22	Yes
23	Yes
24	Yes
25	Yes
26	Yes
27	Yes
28	Yes
29	Yes
30	Yes

Note: The Type 5 randomized parameters are shown in a separate document.

**TYPE 6 DETECTION PROBABILITY**

Data Sheet for FCC Hopping Radar Type 6				
1 us Pulse Width, 333 us PRI, 9 Pulses per Burst, 1 Burst per Hop				
NTIA August 2005 Hopping Sequence				
Trial	Starting Index Within Sequence (Base 1)	Signal Generator Frequency (MHz)	Hops within Detection BW	Successful Detection (Yes/No)
1	128	5543	1	Yes
2	603	5544	6	Yes
3	1078	5545	1	Yes
4	1553	5546	5	Yes
5	2028	5547	1	Yes
6	2503	5548	2	Yes
7	2978	5549	2	Yes
8	3453	5550	4	Yes
9	3928	5551	1	Yes
10	4403	5552	1	Yes
11	4878	5553	1	Yes
12	5353	5554	2	Yes
13	5828	5555	4	Yes
14	6303	5556	4	Yes
15	6778	5557	5	Yes
16	7253	5543	2	Yes
17	7728	5544	2	Yes
18	8203	5545	2	Yes
19	8678	5546	4	Yes
20	9153	5547	6	Yes
21	9628	5548	3	Yes
22	10103	5549	3	Yes
23	11053	5550	4	Yes
24	12003	5551	3	Yes
25	12478	5552	3	Yes
26	12953	5553	3	Yes
27	13428	5554	4	Yes
28	13903	5555	4	Yes
29	14378	5556	1	Yes
30	14853	5557	4	Yes

### 5.3. SLAVE DEVICE CONFIGURATION

#### 5.3.1. TEST CHANNEL

All tests were performed at a channel center frequency of 5550 MHz. Measurements were performed using conducted test methods.

#### 5.3.2. PLOT OF WLAN TRAFFIC

##### PLOT OF WLAN TRAFFIC

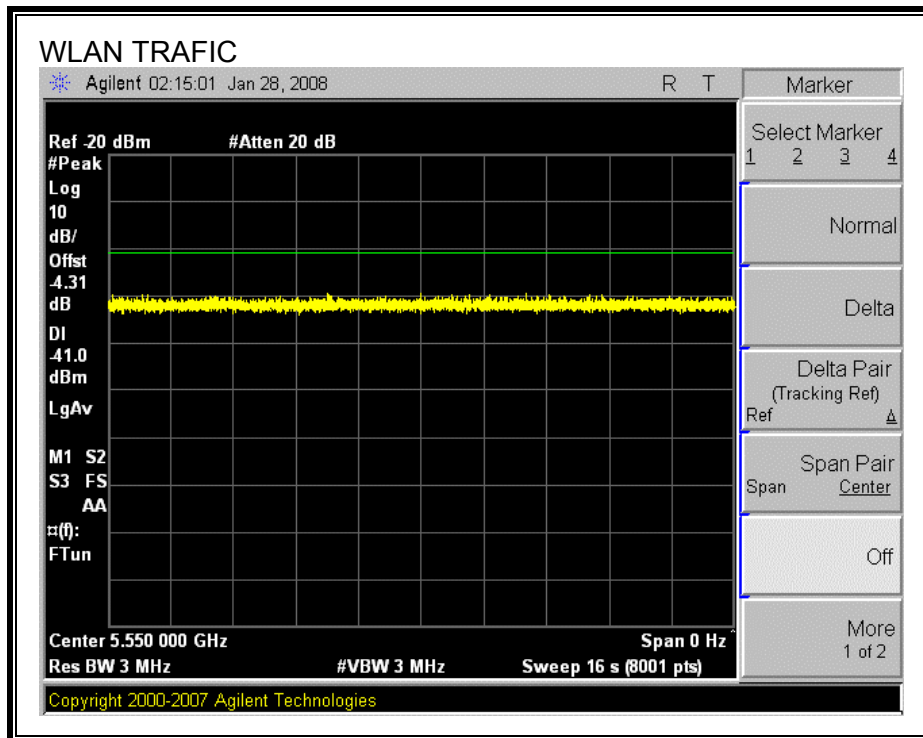

### 5.3.3. MOVE AND CLOSING TIME

#### REPORTING NOTES

The reference marker is set at the end of last radar pulse.

The delta marker is set at the end of the last WLAN transmission following the radar pulse. This delta is the channel move time.

The aggregate channel closing transmission time is calculated as follows:

Aggregate Transmission Time =  
(Number of analyzer bins showing transmission) \* (dwell time per bin)

The observation period over which the FCC aggregate time is calculated begins at (Reference Marker + 200 msec) and ends no earlier than (Reference Marker + 10 sec).

The observation period over which the IC aggregate time is calculated begins at (Reference Marker) and ends no earlier than (Reference Marker + 10 sec).

#### RESULTS

Agency	Channel Move Time (sec)	Limit (sec)
FCC / IC	0.0	10

Agency	Aggregate Channel Closing Transmission Time (msec)	Limit (msec)
FCC	0.0	60
IC	0.0	260

**MOVE TIME**

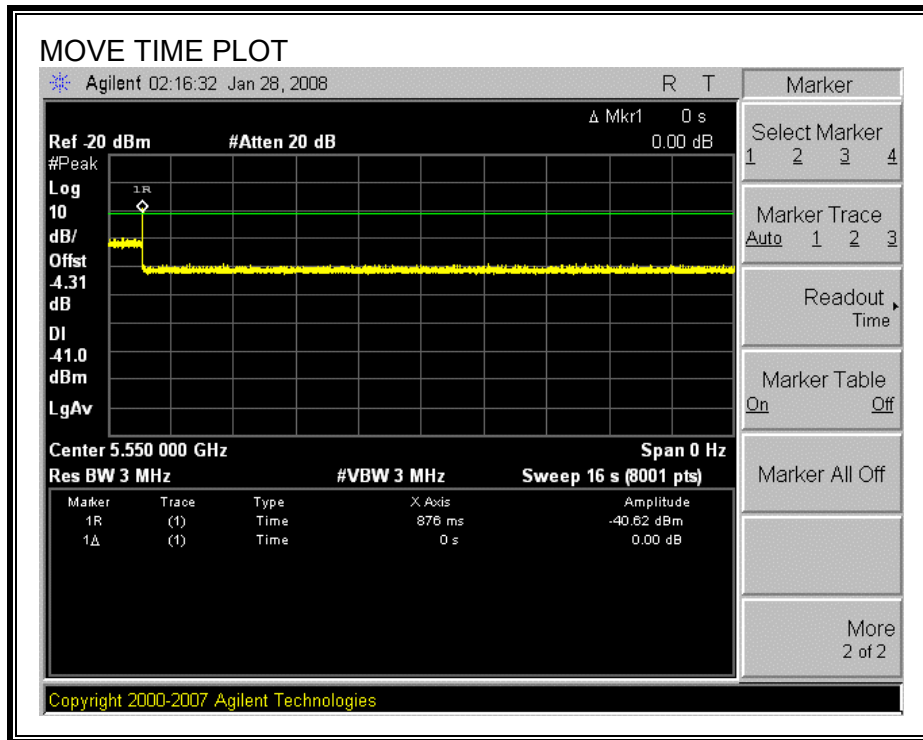

**CHANNEL CLOSING TIME**

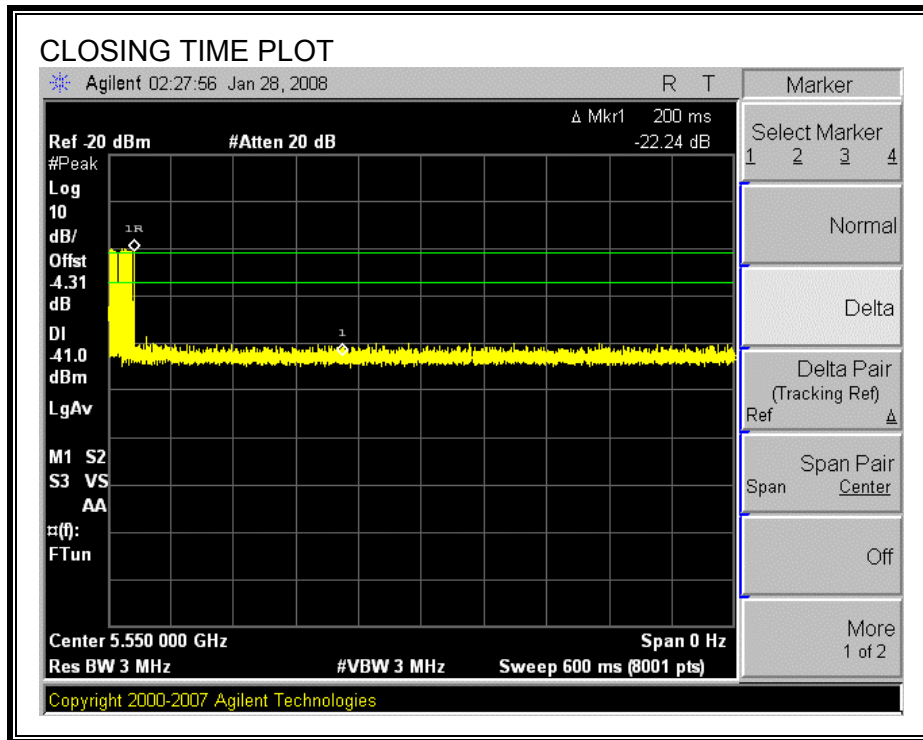

**AGGREGATE CHANNEL CLOSING TRANSMISSION TIME**

No transmissions are observed during the FCC aggregate monitoring period.

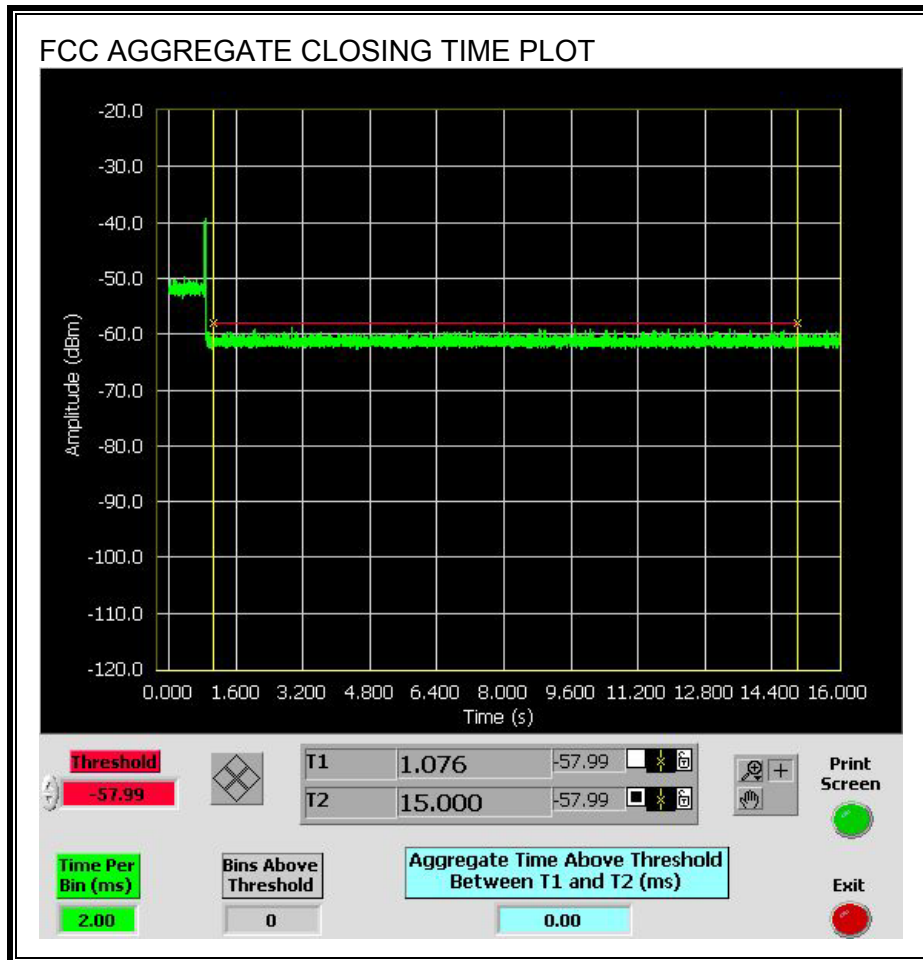



No transmissions are observed during the IC aggregate monitoring period.

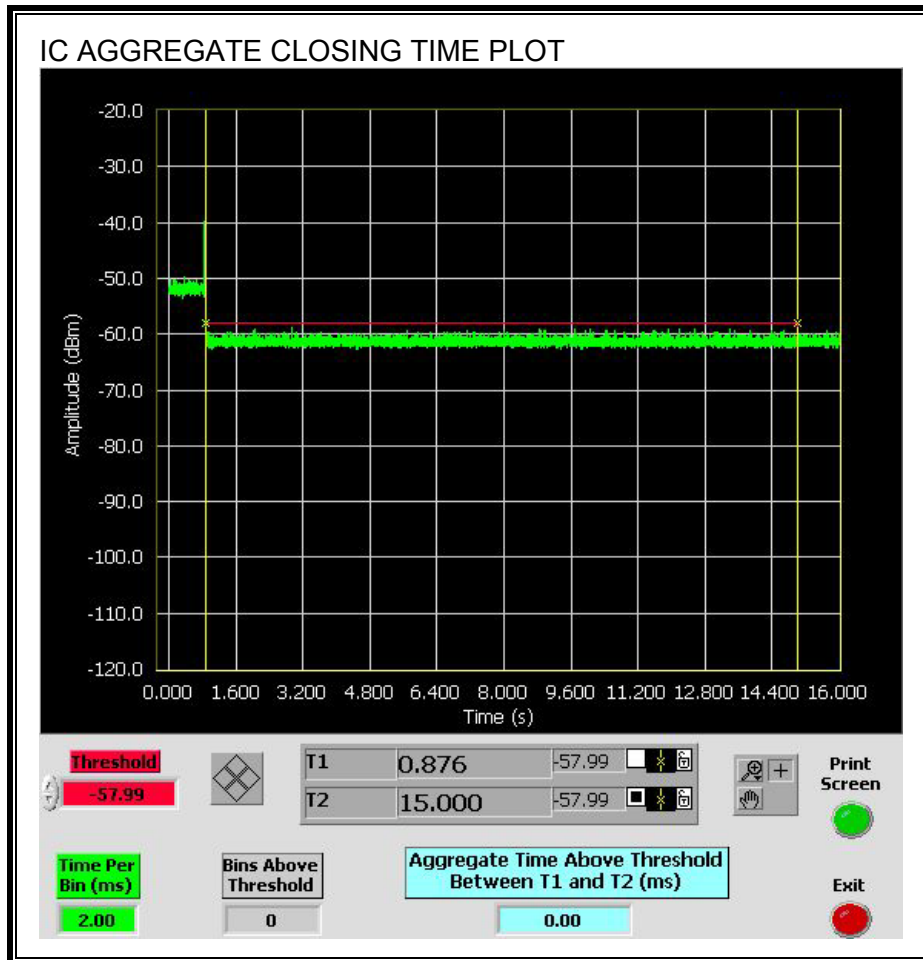

### 5.3.4. SLAVE NON-OCCUPANCY

#### TEST PROCEDURE

The spectrum analyzer is monitoring the emissions from the Slave.

The AP and Slave are linked in a 15 MHz bandwidth mode, with streaming video. The spectrum analyzer trace is started, then the radar is triggered, and the channel is monitored for > 30 minutes.

Then the AP is powered down. The spectrum analyzer trace is started, then the Slave is rebooted, and the channel is monitored for > 30 minutes.

#### ASSOCIATED TEST RESULTS

No EUT transmissions were observed on the test channel during the 30-minute observation time.

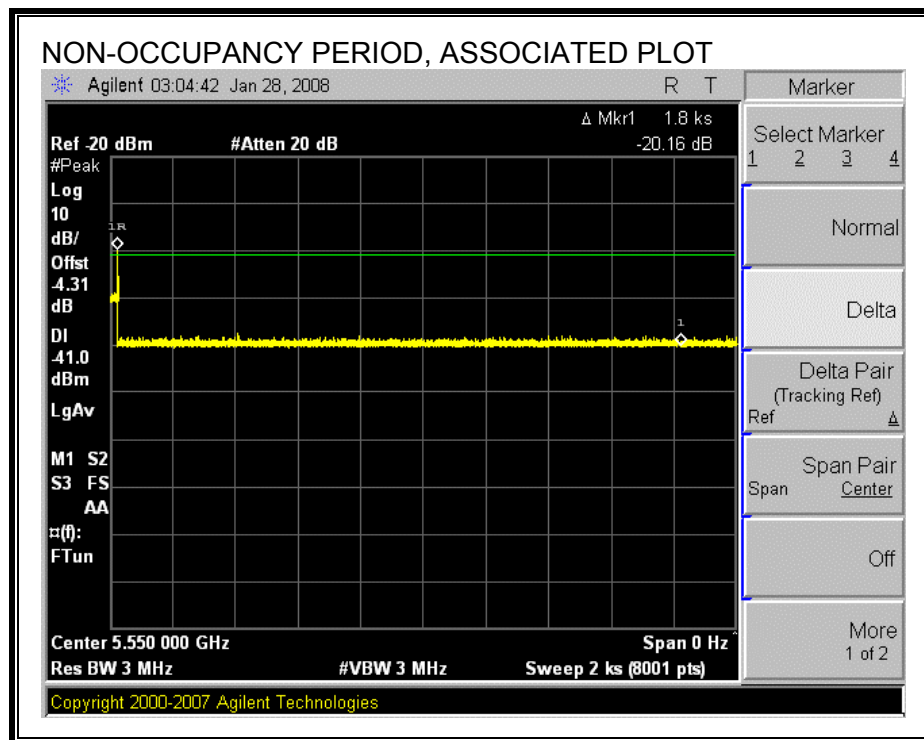

**NON-ASSOCIATED TEST RESULTS**

No EUT transmissions were observed on the test channel during the 30-minute observation time.

