

PTP 600 Series User Guide



MOTOROLA POINT-TO-POINT WIRELESS SOLUTIONS





MOTOROLA, Inc.

Point-to-Point Wireless Bridges – PTP 600 Series

Software Release PTP 600-04-01

System User Manual

June 18th, 2007

Ref: PHN-0896-01.05

Copyright Information

This document is the confidential property of Motorola, Inc. and without its prior written consent may not be copied or released to third parties.

MOTOROLA, the stylized M Logo and all other trademarks indicated as such herein are trademarks of Motorola, Inc. ® Reg. U.S. Pat & Tm. Office. PTP 600 is a trademark of Motorola, Inc. All other product or service names are the property of their respective owners.

© 2007 Motorola, Inc. All rights reserved.

<http://www.motorola.com/ptp>

Compliance

General

Changes or modifications not expressly approved by Motorola could void the user's authority to operate the system.

NOTE: This system has achieved Type Approval in various countries around the world. This means that the system has been tested against various local technical regulations and found to comply. The frequency band in which the system operates is 'unlicensed' and the system can be used provided it does not cause interference. Further, it is not guaranteed protection against interference from other products and installations.



The system has basically been shown to comply with the limits for emitted spurious radiation for a Class B digital device¹, pursuant to Part 15 of the FCC Rules in the USA as well as comparable regulations in other countries. These limits have been designed to provide reasonable protection against harmful interference in a residential installation. This equipment generates uses and can radiate radio frequency energy and, if not installed and used in accordance with the instructions, may cause harmful interference to radio communications. However, there is no guarantee that interference will not occur in a particular installation.

If this equipment does cause harmful interference to radio or television reception, which can be determined by turning the equipment off and on, the user is encouraged to try to correct the interference by one or more of the following measures:

- Reorient or relocate the Outdoor Unit (ODU).
- Increase the separation between the equipment and ODU.
- Connect the equipment into a power outlet on a circuit different from that to which the receiver is connected.
- Consult your installer or supplier for help.

Deployment and Operation

The Radio Regulations of various countries' limits constrain the operation of radio products generally. In particular the local regulator may limit the amount of conducted or radiated transmitter power and may require registration of the radio link.

The power transmitted by the PTP 600 Series Bridge is controlled by the use of Region-specific License Keys.

The following examples show how the regulatory limits apply in some specific countries at the current time. Operators should note that regulations are subject to change.

Contact your supplier/installer to ensure that your product is set for the correct License Key for your Country/Region and to ensure that you have fulfilled all the local regulatory requirements, especially if you are intending to use a link with external antennas. Footnotes to the table below indicate countries where registration of the link is currently mandatory.

¹ Class B Digital Device, A digital device that is marketed for use in a residential environment notwithstanding use in commercial, business and industrial environments.

Regulations applicable to 5.4GHz PTP 600 Series Bridge variant

	Examples of Regulatory Limits at 5.4GHz
Non-FCC and Non-ETSI ²	Equipment can be operated in any mode, best results will be obtained using Region 8 settings (Region 7 if i-DFS is required)
FCC	Under FCC Regulations, operation of this product is only allowed with a License Key for Region 12 (30dBm EIRP with Radar Detection)
Canada	Under IC Regulations, operation of this product is only allowed with a License Key for Region 13 (30dBm EIRP with Radar Detection and barring of the band 5600-5650MHz)
ETSI	Under ETSI Regulations, operation of this product is only allowed with a License Key for Region 12 (30dBm EIRP with Radar Detection)

General Notice Applicable to Europe
This equipment complies with the essential requirements for the EU R&E Directive 1999/5/EC.



² Note: In regions other than EU/USA, specific local regulations may apply. It is the responsibility of the installer/user to check that the equipment as deployed meets local regulatory requirements.

Regulations applicable to 5.8GHz PTP 600 Series Bridge variant

	Examples of Regulatory Limits
USA/ Canada/ Taiwan/ Brazil	Equipment can be operated in any mode, best results will be obtained using Region 1 settings
UK ³	Under UK Regulations, operation of this product is allowed with a License Key for Region 4 (2W EIRP with Radar Detection)
Eire ⁴	Under Eire Regulations, operation of this product is only allowed with a License Key for Region 6 (2W EIRP)
Norway	Norwegian rules allow a 200W EIRP but also require Radar Detection (i-DFS) and barring of part of the band. The license key for Region 7 is required, although Region 4 could also be used for lower power requirements.
Australia	Australian laws prohibit use/operation of this product except where it is used with a License Key for Region 3 (4W EIRP)
Singapore	Under Singapore Regulations, operation of this product is only allowed with a License Key for Region 5 (100mW EIRP)
Hong Kong	Under Hong Kong Regulations, operation of this product is only allowed with a License Key for Region 3 (4W EIRP)
Korea	Under Korean Regulations, operation of this product is only allowed with a License Key for Region 11 (100mW TX Power, Band restricted to 5725 to 5825MHz)

³UK Registration of Links – OfCom

The application form may be found at

<http://www.ofcom.org.uk/radiocomms/>

⁴Eire Registration of Links – Commission for Communication Regulation (ComReg)

The application form may be found at

http://www.comreg.ie/5_8GHzRegPart1.asp?S=4&NavID=198&M

General Notice Applicable to Europe
This equipment complies with the essential requirements for the EU R&E Directive 1999/5/EC.
The use of 5.8GHz for Point to Point radio links is not harmonized across the EU and currently the product may only be deployed in the UK and Eire (IRL); Norway will be available for deployment from December 2005.
However, the regulatory situation in Europe is changing and the radio spectrum may become available in other countries in the near future. Please contact Motorola for the latest situation.

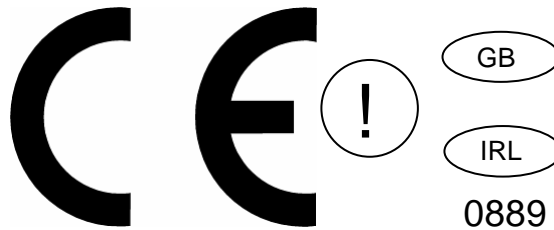

Disclaimer

The parameters quoted in this document must be specifically confirmed in writing before they become applicable to any particular order or contract. The company reserves the right to make alterations or amendments to the detail specification at its discretion. The publication of information in this document does not imply freedom from patent or other rights of Motorola, Inc. or others.

1	About This User Guide	19
1.1	Interpreting Typeface and Other Conventions	19
1.2	Getting Additional Help	21
1.3	Sending Feedback	21
2	Avoiding Hazards	22
2.1	Preventing Overexposure to RF Energy	22
2.1.1	Calculations for Separation Distances and Power Compliance Margins.....	22
2.1.1.1	Calculated Distances and Power Compliance Margins	23
3	Getting Started	24
3.1	For Your Safety	24
3.2	Welcome	25
3.2.1	About This Guide.....	25
3.2.2	Who Should Use This Guide.....	25
3.2.3	Contact Information	26
3.2.4	Repair and Service.....	26
3.3	Product Description.....	27
3.3.1	The Outdoor Unit (ODU)	29
3.3.2	PIDU Plus – PTP 600 Series Bridge.....	30
3.3.3	Redundancy and Alternate Powering Configurations	32
3.3.3.1	External DC Supply Only	32
3.3.3.2	External DC Supply and AC Supply.....	33
3.3.3.3	External DC Supply and Redundant AC Supply	33
3.3.4	Remote LEDs and Recovery Switch	34
3.3.5	Cables and connectors	34
3.3.6	Surge Arrestor.....	35
3.3.7	Mounting Brackets.....	35
3.3.8	Configuration and Management.....	36
3.4	Warranty.....	36
4	Product Architecture	37
5	General Considerations	39
5.1	Spectrum Planning.....	39
5.2	Region Codes.....	40
5.3	Operational Restrictions.....	41
5.3.1	Radar Avoidance.....	41
5.3.2	RTTT Avoidance and Other Channel Use Restrictions	42

5.4	5.4GHz Specific Frequency Planning Considerations	43
5.4.1	Raster Considerations.....	43
5.4.2	Transmit Power Reduction at the Band Edges	43
5.4.3	5.8GHz Specific Frequency Planning Considerations	44
5.4.4	Raster Considerations.....	44
5.4.5	Transmit Power Reduction at the Band Edges	44
5.5	Distance	45
5.6	Networking Information	46
5.7	Lightning Protection.....	46
5.8	Electrical Requirements	46
6	Site Planning.....	47
6.1	Site Selection Criteria.....	47
6.1.1	ODU Site Selection	47
6.1.2	PTP 600 Series Bridge PIDU Plus Site Selection.....	47
6.1.3	Path Loss Considerations	48
6.1.4	Aggregate Ethernet throughput rate v maximum link loss	49
7	Installation	51
7.1	Preparation.....	51
7.2	Installation Procedure	51
7.3	Tools Required.....	51
7.4	Installation Support.....	52
7.5	Legal Disclaimer.....	52
7.6	Mounting the ODUs.....	52
7.7	Connecting Up.....	54
7.7.1	Preparing The PIDU Plus To ODU Cable	54
7.7.2	Making the Connections at the ODU.....	56
7.7.3	Making the PTP 600 Series Bridge PIDU Plus Connection At The ODU	57
7.7.4	Routing the Cable.....	58
7.7.5	Fitting A Surge Arrestor.....	58
7.7.6	Grounding the Installation	59
7.7.7	Making the ODU Connection at the PTP 600 Series Bridge PIDU Plus.....	59
7.7.8	Making the Network Connection at The PIDU Plus – PTP 600 Series Bridge	60
7.7.9	Mounting the PTP 600 Series Bridge PIDU Plus	61
7.7.10	Powering Up.....	63
7.7.11	Aligning the PTP 600 Series Bridge ODUs	64
8	Web Page Reference.....	66

8.1	Home Page – PTP 600 Series Bridge.....	68
8.1.1	Home Page Alarm Display	69
8.2	Systems Status Page	72
8.3	System Administration Pages	77
8.3.1	System Configuration.....	78
8.3.1.1	General Configuration Page.....	79
8.3.1.2	LAN Configuration Page	81
8.3.1.3	LAN Configuration Page – Use VLAN For Management Interfaces	84
8.3.1.4	LAN Configuration Page – Manual Ethernet Configuration	86
8.3.1.5	Save and Restore Configuration File	87
8.3.1.6	Telecoms Configuration Page.....	92
8.3.2	Statistics Page.....	94
8.3.3	Detailed Counters Page	97
8.3.4	Install Pages.....	99
8.3.4.1	Manually Configuring The Wireless Units	101
8.3.4.2	Internet Protocol Configuration	102
8.3.4.3	Telecoms Interface.....	104
8.3.4.4	Wireless Configuration	105
8.3.4.5	Disarm	111
8.3.5	Graphical Install.....	113
8.3.6	Software Upgrade	114
8.3.7	Spectrum Management.....	117
8.3.7.1	Wireless Channels	118
8.3.7.2	Spectrum Management Measurements.....	118
8.3.7.3	Measurement Analysis.....	118
8.3.7.4	The Spectrum Management Master / Slave Relationship.....	119
8.3.7.5	Spectrum Management Configuration	122
8.3.7.6	Barring Channels.....	123
8.3.7.7	Local and Peer Channel Spectrum Graphics.....	123
8.3.7.8	Active Channel History	125
8.3.7.9	Viewing Historic Spectrum Management Metrics	126
8.3.8	Spectrum Management (Fixed Frequency and WIMAX)	127
8.3.9	Spectrum Management Control - With Operational Restrictions	129
8.3.10	Remote Management Page	132
8.3.10.1	SNMP (Simple Network Management Protocol).....	133
8.3.10.2	Supported Management Information Bases (MIBS)	133

8.3.10.3	SNMP Configuration.....	134
8.3.10.4	SMTP (Simple Mail Transport Protocol).....	134
8.3.10.5	SNTP (Simple Network Time Protocol).....	135
8.3.10.6	Setting the clock.....	135
8.3.11	Diagnostics.....	136
8.3.11.1	Diagnostic Plotter.....	137
8.3.11.2	Diagnostics Download.....	138
8.3.12	Change System Administration Password.....	139
8.3.13	License Key.....	140
8.3.14	Properties.....	142
8.3.15	Reboot.....	143
9	Recovery Mode.....	144
9.1	Upgrade Software Image.....	146
9.2	Reset IP & Ethernet Configuration.....	148
9.3	Erase Configuration.....	149
9.4	Reboot.....	152
10	Fault Finding.....	153
10.1	Hardware.....	153
10.1.1	Power.....	153
10.1.2	Ethernet.....	154
10.1.3	Checking your wiring.....	155
10.2	Radio.....	156
10.2.1	No Activity.....	156
10.2.2	Some Activity.....	157
11	Lightning Protection.....	158
11.1	Overview.....	158
11.1.1	Lightning Protection Zones.....	158
11.2	Detailed Installation.....	159
11.3	Testing Your Installation.....	166
11.3.1	Pre-Power Testing.....	166
11.3.2	Post-Power Testing.....	166
12	Wind Loading.....	168
12.1	General.....	168
12.2	Calculation of Lateral Force.....	168
12.3	Capabilities of the PTP 600 Series Bridges.....	169
12.4	Wind Speed Statistics.....	169

13	PTP 600 Series Bridge – Connectorized Model	171
13.1	Scope	171
13.2	Product Description	171
13.2.1	Hardware	171
13.2.2	Antenna Choices – 5.8 GHz.....	172
13.3	Software/Features	173
13.3.1	Status Page	173
13.3.2	Configuration Pages.....	174
13.3.3	Installation Pages	175
13.4	Deployment Considerations	179
13.5	Link Budget	179
13.6	Regulatory Issues.....	179
13.6.1	Antenna Choice (FCC Regions Only)	179
13.6.2	Cable Losses (FCC Regions Only).....	180
13.7	Antennas for USA / Canada.....	180
13.8	Installation	183
13.8.1	Antenna Choice.....	183
13.8.2	Cables and Connectors.....	183
13.8.3	Tools.....	183
13.8.4	Miscellaneous supplies	184
13.8.5	Mounting the Connectorized 600 Series Bridge	184
13.8.6	Mounting the antennas.....	184
13.8.7	Alignment Process	185
13.8.8	Aligning Dual Polar Antennas	185
13.8.9	Aligning Separate Antennas.....	185
13.8.10	Completing the Installation.....	186
13.8.11	Antenna Cable Fixing.....	186
13.8.12	Antenna Connection Weatherproofing.....	186
13.9	Additional Lightning Protection.....	188
13.9.1	ODU Mounted Outdoors	188
13.9.2	ODU Mounted Indoors	189
14	E1/T1 Installation Guide	191
14.1	Preparing the PTP 600 Series Bridge E1/T1 Cable.....	191
14.2	Making the Connection at the ODU	193
14.3	Routing the Cable.....	196
14.4	Fitting a Surge Arrestor	196

14.5	Customer Cable Termination	196
14.6	Lightning Protection.....	198
14.6.1	Overview	198
14.6.2	Recommended Additional Components for E1/T1 Installation.	198
14.7	Surge Arrestor Wiring.....	201
14.8	Testing Your Installation.....	203
14.8.1	Pre-Power Testing.....	203
15	Data Rate Calculations	205
16	AES Encryption Upgrade	210
16.1	Configuring Link Encryption	211
16.1.1	License Keys	211
16.1.2	Encryption Mode and Key	213
16.2	Wireless Link Encryption FAQ	214
16.2.1	Encryption data entry fields are not available	214
16.2.2	Link fails to bridge packets after enabling link encryption.....	214
17	Legal and Regulatory Notices.....	215
17.1	Important Note on Modifications	215
17.2	National and Regional Regulatory Notices – 5.8 GHz variant	215
17.2.1	U.S. Federal Communication Commission (FCC) and Industry Canada (IC) Notification..	215
17.2.2	European Union Notification	216
17.2.3	UK Notification.....	217
17.3	National and Regional Regulatory Notices – 5.4 GHz Variant	218
17.3.1	U.S. Federal Communication Commission (FCC) and Industry Canada (IC) Notification..	218
17.3.2	European Union Notification	219
17.4	Exposure	221
17.5	Legal Notices.....	221
17.5.1	Software License Terms and Conditions	221
17.5.2	Hardware Warranty in U.S.	225
17.5.3	Limit of Liability	225
18	Glossary	226
19	FAQs.....	227
20	Index	230
21	Specifications	231
21.1	System Specifications	231
21.1.1	Wireless 5.4GHz Variant.....	231
21.1.2	Wireless 5.8GHz Variant.....	234

21.1.3	Management	237
21.1.4	Physical	238
21.1.5	Powering	238
21.1.6	Telecoms Interface	238
21.2	Safety Compliance	239
21.2.1	5.4 GHz Variant.....	239
21.2.2	5.8GHz Variant.....	239
21.3	EMC Emissions Compliance	240
21.3.1	5.4GHz Variant.....	240
21.3.2	5.8GHz Variant.....	240
21.4	EMC Immunity Compliance.....	241
21.5	Radio Certifications	242
21.5.1	5.4GHz Variant.....	242
21.5.2	5.8GHz Variant.....	242
21.6	Environmental Specifications	242
21.7	System Connections	243
21.7.1	PIDU Plus to ODU and ODU to Network Equipment Connections.....	243

List of Figures

Figure 1 - Typical PTP 600 Series Bridge Deployment	27
Figure 2 - Mod Record Label.....	28
Figure 3 – PTP 600 Series Bridge Outdoor Unit (ODU).....	29
Figure 4 - Power Indoor Unit (PIDU Plus) – PTP 600 Series.....	30
Figure 5 – PIDU Plus Recovery Switch Location.....	30
Figure 6 – PTP 600 Series Bridge PIDU Plus Power Input.....	31
Figure 7 – PTP 600 Series Bridge PIDU Plus to ODU Cable Length Graph.....	32
Figure 8 - External DC Supply Only.....	32
Figure 9 - External DC Supply and AC Supply.....	33
Figure 10 - External DC Supply and Redundant AC Supply.....	33
Figure 11 - Remote LED and Recovery Switch Wiring.....	34
Figure 12 – PTP 600 Series Bridge Layer Diagram.....	38
Figure 13 - 5.8 GHz UK RTTT Channel Avoidance.....	42
Figure 14 - 5.4 GHz Available Spectrum Settings.....	43
Figure 15 - 5.8 GHz Available Spectrum Settings.....	44
Figure 16 - 5.8 GHz Band Edge TX Power Reduction (Region Code 1 Only).....	45
Figure 17 - Mounting to pole diameters 25mm (1”) to 50mm (2”).....	53
Figure 18 - Integral Safety Loop.....	53
Figure 19 - Completed ODU connector.....	55
Figure 20 - RJ45 Pin Connection (T568B Color Coding).....	55
Figure 21 – PTP 600 Series Bridge PIDU Plus Connection.....	56
Figure 22 - Disconnecting the ODU.....	58
Figure 23 - Making the Network Connection at the PIDU Plus.....	60
Figure 24 – PTP 600 Series PIDU Plus Drip Loop Configuration.....	62
Figure 25 - Menu Navigation Bar.....	67
Figure 26 - System Summary Page.....	68
Figure 27 - Alarm Warning Triangle.....	69
Figure 28 - Status Page.....	72
Figure 29 - System Administration Login Page.....	77
Figure 30 - System Configuration Page.....	79
Figure 31 - LAN Configuration Page.....	81
Figure 32 - Configuration Reboot Page.....	83
Figure 33 - Configuration Reboot Page - Ethernet Auto Negotiation Disabled.....	83
Figure 34 - VLAN Configuration Fields.....	85
Figure 35 - LAN Configuration Page - Manual Ethernet Configuration.....	86

Figure 36 - Save and Restore Configuration Page	87
Figure 37 - Save Configuration File Screen	88
Figure 38 – PTP 600 Example Configuration File	89
Figure 39 - Restore Configuration File Pop Up Screen.....	90
Figure 40 - Reset Configuration and Reboot Confirmation Pop-up	91
Figure 41 - Telecoms Data Entry.....	92
Figure 42 - System Statistics.....	94
Figure 43 - Detailed Counters Page	97
Figure 44 - License Key Data Entry.....	101
Figure 45 - Installation Wizard Internet Protocol Configuration.....	102
Figure 46 - VLAN Warning	103
Figure 47 - Telecoms Configuration Interface	104
Figure 48 - Installation Wizard Wireless Configuration	105
Figure 49 - Fixed Frequency Operation.....	108
Figure 50 - Installation Wizard Confirm Configuration.....	109
Figure 51 - Reboot Confirmation Pop Up	110
Figure 52 - Disarm Installation.....	111
Figure 53 - Optional Post Disarm Configuration 1.....	112
Figure 54 - Optional Post Disarm Configuration 2.....	112
Figure 55 – Graphical Installation Screen	113
Figure 56 - Software Upgrade	114
Figure 57 - Software Upgrade Image Check.....	115
Figure 58 - Software Download Progress Indicator.....	116
Figure 59 - Software Upgrade Complete.....	116
Figure 60 - Reboot Confirmation Pop Up	117
Figure 61 - Spectrum Management as seen from the Master.....	120
Figure 62 - Spectrum Management as seen from the Slave.....	121
Figure 63 - Example Spectrum Management Graphic.....	123
Figure 64 - Active Channel History Screen	125
Figure 65 - Spectrum Management Time Series Plot	126
Figure 66 - Spectrum Management Fixed Frequency Screen	127
Figure 67 - Spectrum Management Help Page (Fixed Frequency)	129
Figure 68 - Spectrum Management Master Screen With Operational Restrictions	130
Figure 69 - Spectrum Management Slave Screen With Operational Restrictions	131
Figure 70 - Remote Management.....	132
Figure 71 - Diagnostic Plotter	137
Figure 72 - CSV Download.....	138

Figure 73 - Password Change.....	139
Figure 74 - Software License Key Data Entry	140
Figure 75: License Key reboot Screen	141
Figure 76 - Reboot Confirmation Pop Up	141
Figure 77 - Properties	142
Figure 78 - System Reboot.....	143
Figure 79 - Reboot Confirmation Pop Up	143
Figure 80 - Recovery Mode Warning Page	144
Figure 81 - Recovery Options Page	145
Figure 82 - Software Download Progress Indicator Page	146
Figure 83 - Software Download Complete Page	147
Figure 84 - Reboot Confirmation Pop Up	147
Figure 85 - Confirm Reset to Factory Default Pop Up.....	148
Figure 86 - IP and Ethernet Erased Successfully page.....	148
Figure 87 - Reboot Confirmation Pop Up	149
Figure 88 - Confirm Erase Configuration Pop Up.....	149
Figure 89 - Erase Configuration Successful Page	150
Figure 90 - Reboot Confirmation Pop Up	151
Figure 91 - Reboot Confirmation Pop Up	152
Figure 92 - Main System Connections	153
Figure 93 - ODU mounted in Zones A & B	160
Figure 94 - Showing how the use of a Finial enables the ODU to be mounted inside Zone B	160
Figure 95 - Diagrammatically showing typical wall and mast installations	161
Figure 96 - Upper Grounding Configuration	162
Figure 97 - Lower Grounding Configuration	163
Figure 98 - Surge Arrestor ALPU-ORT Connection Illustration.....	165
Figure 99 - Simplified Circuit Diagram (Only One Transtector Shown For Clarity).....	166
Figure 100 – Connectorized 600 Series Bridge Outdoor Unit.....	171
Figure 101 - Connectorized 600 Series bridge Status Page	173
Figure 102 - Connectorized 600 Series bridge ‘System Configuration’ Page	174
Figure 103 - Connectorized PTP 600 Series Bridge ‘Installation Wizard’ Page	175
Figure 104 - Connectorized 600 Series bridge ‘Confirm Installation’ Page.....	177
Figure 105 - Connectorized 600 Series bridge ‘Disarm Installation’ Page.....	178
Figure 106 - Forming a Drip Loop	186
Figure 107 - Weatherproofing the Antenna Connections.....	187
Figure 108- Additional Grounding When Using Connectorized Units	188
Figure 109 - Lightning Arrestor Mounting.....	189

Figure 110 - Polyphaser Assembly.....	190
Figure 111 - Completed ODU Connector	191
Figure 112 - RJ45 Pin Connection (T568B Color Coding)	192
Figure 113 - PIDU Plus and E1-T1 Connection	193
Figure 114 - Disconnecting the ODU.....	195
Figure 115 - Example of a Balun.....	196
Figure 116 - Diagrammatically Showing the E1-T1 Connections.....	197
Figure 117 - Typical Mast Installation with the addition of the E1-T1 cable	199
Figure 118 - Wall Installation with the addition of E1-T1 cable	200
Figure 119 - Surge Arrestor ALPU-ORT Connection Illustration.....	202
Figure 120 - Simplified Circuit Diagram (Only One Transtector Shown For Clarity)	203
Figure 121 - BPSK 0.63 Single Payload.....	205
Figure 122 - QPSK 0.63 Single Payload	205
Figure 123 - QPSK 0.87 Single Paylaod	206
Figure 124 - 16 QAM 0.63 Single Payload	206
Figure 125 - 16 QAM 0.87 Single Paylaod.....	206
Figure 126 - 64 QAM 0.75 Single Payload.....	207
Figure 127 - 64 QAM 0.92 Single Payload.....	207
Figure 128 - 256 QAM 0.81 Single Payload.....	207
Figure 129 - 16 QAM 0.63 Dual Payload	208
Figure 130 - 16 QAM 0.87 Dual Payload	208
Figure 131 - 64 QAM 0.75 Dual Payload	208
Figure 132 - 64 QAM 0.92 Dual Payload	209
Figure 133 - 256 QAM 0.81 Dual Payload	209
Figure 134 – AES Software License Key Data Entry	211
Figure 135 – AES Configuration Data Entry Page	213
Figure 136 - Configuration Reboot Screen.....	214
Figure 137 - Cable Connection Diagram (T568B Color Coding).....	243

List of Tables

Table 1 - Font types	19
Table 2 - Admonition types	20
Table 3 - Power Compliance Margins	23
Table 4 - Contact Information	26
Table 5 - PTP 600 Series Bridge Frequency Variants	39
Table 6 – PTP 600 Series Bridge Region Code Definitions	41
Table 7 - 5.4GHz Aggregate Ethernet throughput rate versus maximum link loss	49
Table 8 - 5.8GHz Aggregate Ethernet throughput rate versus maximum link loss	50
Table 9 - Audio indications from the ODU	64
Table 10 – 600 Series Bridge Factory Configuration Values	100
Table 11 - Spectrum Management change state key	124
Table 12 - Spectrum Management Time Series Key	126
Table 13 - Spectrum Management Change State Key With Operational Restrictions	132
Table 14 - Resistance Table Referenced To The RJ45 at the PIDU+	156
Table 15 - Protection Requirements	161
Table 16 - Surge Arrestor ALPU-ORT Cable 1 Termination	164
Table 17 - Surge Arrestor ALPU-ORT Cable 2 Termination	164
Table 18 - Lateral Force – Imperial	168
Table 19 - Lateral Force – Metric	169
Table 20 - Cable Losses per Length	180
Table 21 - Allowed Antennas for Deployment in USA/Canada	182
Table 22 - Protection Requirements	198
Table 23 - Surge Arrestor ALPU-ORT Cable 1 Termination	201
Table 24 - Surge Arrestor ALPU-ORT Cable 2 Termination	201
Table 25 - Resistance Table Referenced To The E1/T1 Source	204
Table 26 - US FCC IDs and Industry Canada certification numbers	216
Table 27 - US FCC IDs and Industry Canada certification numbers	218
Table 28 - Receive Sensitivity and System Gains	232
Table 29 - Receive Sensitivity and System Gains	235
Table 30 - Telecoms Connection Pin Out	243

List of Equations

Equation 1 - Path Loss	48
Equation 2 - Link Loss	75



1 About This User Guide

This guide covers the installation, commissioning, operation and fault finding of the Motorola PTP 600 Series of Point-to-Point Wireless Ethernet Bridges.

1.1 Interpreting Typeface and Other Conventions

This document employs distinctive fonts to indicate the type of information, as described in Table 1.

Font	Type of Information
variable width bold	Selectable option in a graphical user interface or settable parameter in a web-based interface.
constant width regular	Literal system response in a command-line interface.
<i>constant width italic</i>	Variable system response in a command-line interface.
constant width bold	Literal user input in a command-line interface.
<i>constant width bold italic</i>	Variable user input in a command-line interface.

Table 1 - Font types

This document employs specific imperative terminology as follows:

- Type means press the following characters.
- Enter means type the following characters and then press Enter.
- Highlight means click anywhere in a row of data to highlight the entire row.
- Select means use the mouse to click on or branch to the menu item that follows.

Use this table and the Glossary to aid in interpreting the technical acronyms used throughout this User Guide.

This document also employs a set of consistently used admonitions. Each type of admonition has a general purpose that underlies the specific information in the box. These purposes are indicated in Table 2.





Admonition Label	General Message
	<p>Note Informative content that may:</p> <ul style="list-style-type: none"> • Defy common or cursory logic. • Describe a peculiarity of the 600 Series solutions implementation. • Add a conditional caveat. • Provide a reference. • Explain the reason for a preceding statement or provide background for what immediately follows. <p>Recommendation Suggestion for an easier, quicker, or safer action or practice.</p>
	<p>Important Informative content that may:</p> <ul style="list-style-type: none"> • Identify an indication that you should watch for. • Advise that your action can disturb something that you may not want disturbed. • Reiterate something that you presumably know but should always keep in mind.
	<p>Caution! A notice that the risk of harm to equipment or service exists.</p>
	<p>Warning! A notice that the risk of harm to person exists.</p>

Table 2 - Admonition types

1.2 Getting Additional Help

To get information or assistance as soon as possible for problems that you encounter, use the following sequence of action:

1. Search this document, the user manuals that support the modules, and the software release notes of supported releases:
 - a. In the Table of Contents for the topic.
 - b. In the Adobe Reader® search capability for keywords that apply.⁵
2. Visit the Motorola website at www.motorola.com/ptp
3. Ask your Motorola products supplier to help.
4. Gather information from affected units such as:
 - a. the IP addresses and MAC addresses
 - b. the software releases
 - c. the configuration of software features
 - d. any available diagnostic downloads
5. Escalate the problem to Motorola Technical Support as follows. You may either:
 - a. Send e-mail to support.ptpt@motorola.com
 - b. Call +1 (0) 877 515 0400

For warranty assistance, contact your reseller or distributor for the process.

1.3 Sending Feedback

We welcome your feedback on the PTP 600 Series Bridge system documentation. This includes feedback on the structure, content, accuracy, or completeness of our documents, and any other comments you have.

⁵ Reader is a registered trademark of Adobe Systems, Incorporated.

2 Avoiding Hazards

2.1 Preventing Overexposure to RF Energy



Caution To protect from overexposure to RF energy, install the radios for the 600 family of PTP wireless solutions so as to provide and maintain the minimum separation distances from all persons as shown in Table 3.

When the system is operational, avoid standing directly in front of the antenna. Strong RF fields are present when the transmitter is on. The Outdoor Unit (ODU) must not be deployed in a location where it is possible for people to stand or walk inadvertently in front of the antenna.

At these and greater separation distances, the power density from the RF field is below generally accepted limits for the general population.



Note These are conservative distances that include compliance margins. In the case of the reflector, the distance is even more conservative because the equation used models the reflector as a point source and ignores its physical dimensions.

2.1.1 Calculations for Separation Distances and Power Compliance Margins

Limits and guidelines for RF exposure come from:

- US FCC limits for the general population. See the FCC web site at <http://www.fcc.gov>, and the policies, guidelines, and requirements in Part 1 of Title 47 of the Code of Federal Regulations, as well as the guidelines and suggestions for evaluating compliance in FCC OET Bulletin 65.
- Health Canada limits for the general population. See the Health Canada web site at <http://www.hc-sc.gc.ca/rpb> and Safety Code 6.
- ICNIRP (International Commission on Non-Ionizing Radiation Protection) guidelines for the general public. See the ICNIRP web site at <http://www.icnirp.de/> and Guidelines for Limiting Exposure to Time-Varying Electric, Magnetic, and Electromagnetic Fields.

The applicable power density exposure limits from the documents referenced above are:

- 6 W/m² for RF energy in the 900-MHz frequency band in the US and Canada.
- 10 W/m² for RF energy in the 2.4-, 5.2-, 5.4-, and 5.8-GHz frequency bands.

Peak power density in the far field of a radio frequency point source is calculated as follows:

$$S = \frac{P \cdot G}{4\pi d^2}$$

Where S = power density in W/m²
 P = Maximum Average transmit power capability of the radio, in W
 G = total Tx gain as a factor, converted from dB
 d = distance from point source, in m

Rearranging terms to solve for distance yields

$$d = \sqrt{\frac{P \cdot G}{4\pi S}}$$

2.1.1.1 Calculated Distances and Power Compliance Margins

Table 3 shows calculated minimum separation distances *d*, recommended distances and resulting power compliance margins for each frequency band and antenna combination.

Band	Antenna	Max Average Transmit Power in Burst (Watt)	Variable			D ¹ (m)	Recommended Distance (m)	Power Compliance Margin
			P (Watt)	G	S (W/m ²)			
5.4 GHz	Integrated	0.005 (7dBm)	0.0025	200 (23dBi)	10	0.11	1	9
5.8 GHz	Integrated	0.32 (25dBm)	0.16	200 (23dBi)	10	0.5	2	4
	External 2ft Flat Plate	0.32 (25dBm)	0.16	631 (28dBi)	10	0.9	4	4.5
	External 6ft Dish	0.32 (25dBm)	0.16	6310 (38dBi)	10	2.83	10	3.5
1. Calculated								

Table 3 - Power Compliance Margins

Notes:



- The regulations require that the power used for the calculations is the maximum power in the transmit burst subject to allowance for source-based time-averaging.
- At 5.4GHz the product is generally to a fixed EIRP which can be achieved with the Integrated Antenna. If there are no EIRP limits, use the distance calculations for 5.8GHz.
- At 5.8GHz, for antennas between 2ft and 6ft, alter the distance proportionally to the antenna gain.

3 Getting Started



3.1 For Your Safety

WARNING: Use extreme care when installing antennas near power lines.

WARNING: Use extreme care when working at heights.

WARNING: The Outdoor Unit (ODU) for the PTP 600 Series Bridge must be properly grounded to protect against lightning. It is the user's responsibility to install the equipment in accordance with Section 810 of the National Electric Code, ANSI/NFPA No.70-1984 or Section 54 of the Canadian Electrical Code. These codes describe correct installation procedures for grounding the outdoor unit, mast, lead-in wire and discharge unit, size of grounding conductors and connection requirements for grounding electrodes. It is recommended that installation of the outdoor unit be contracted to a professional installer.

WARNING: The ODU for the PTP 600 Series Bridge must be grounded to a Protective Earth as described in Section 5.7.6 "Grounding The Installation" of this Installation Manual and in accordance with the Local Electrical Regulations.

WARNING: It is recommended that the supplied Power Indoor Plus (PIDU Plus) – PTP 600 Series is used to power the PTP 600 Series Bridge ODU. The use of other power sources may invalidate safety approval and affect your warranty.

WARNING: When using alternate DC supplies (via the PIDU Plus DC in terminals as described in Section 1.3.3 "Redundancy and Alternate Powering Configurations"), such as battery-backed DC power source, the supply **MUST** comply with the following requirements:

- The voltage and polarity is correct and is applied to the correct terminals in the PIDU Plus
- The power source is rated as SELV
- The power source is rated to supply at least 1A continuously, and
- The power source cannot provide more than the Energy Hazard Limit as defined by IEC/EN/UL6090, Clause 2.5, Limited Power (The Energy Hazard Limit is 240VA)

CAUTION: When the system is operational, avoid standing directly in front of the antenna. Strong RF fields are present when the transmitter is on. The Outdoor Unit (ODU) must not be deployed in a location where it is possible for people to stand or walk inadvertently in front of the antenna.

CAUTION: Users and installers should note that the main power supply is the primary disconnect device.



CAUTION: Safety will be compromised if external quality cables are not used for connections that will be exposed to the weather.

CAUTION: Safety will be compromised if a different power supply is used than the one supplied by Motorola as part of the system.

3.2 Welcome

Congratulations on the purchase of PTP 600 Series Bridge from Motorola. The PTP 600 Series Bridge is the latest innovation in high-speed wireless networking that lets you deploy wireless networks in areas previously unattainable.

3.2.1 About This Guide

This guide covers the installation, commissioning, operation and fault finding of the PTP 600 Series Bridge.

3.2.2 Who Should Use This Guide

The guide is for use by the system installer and the end user IT professional. The system installer will require expertise in the following areas:

- Outdoor radio equipment installation
- Network configuration
- Use of web browser for system configuration, monitoring and fault finding

3.2.3 Contact Information

Postal Address:	Motorola, Inc. Unit A1, Linhay Business Park, Eastern Road, Ashburton, Devon. TQ13 7UP United Kingdom
Web Site:	http://www.motorola.com/ptp
Sales Enquiries:	mailto:sales.ptp@motorola.com
Web Support:	http://www.motorola.com/ptp/
Email Support:	mailto:support.ptp@motorola.com
All Other Enquiries:	mailto:info.ptp@motorola.com
Telephone Enquiries and Global Support (Toll Free in the USA):	+1 (0) 877 515 0400

Table 4 - Contact Information

3.2.4 Repair and Service

For unit repair or service, contact your service provider or an authorized Motorola Point-to-Point Distributor for Return Material Authorization (RMA) and shipping instructions. Alternatively, contact the PTP Global Technical Support Center to process an RMA (following troubleshooting).

3.3 Product Description

This User Manual is specifically written for the 600 family of point-to-point broadband wireless solutions. The PTP 600 Series Bridge has been developed to provide Point-to-Point data connectivity via a 5.4 GHz or 5.8 GHz wireless Ethernet bridge operating at broadband data rates. The PTP 600 Series Bridge is aimed at a wide range of applications. An example application is an enterprise that has a requirement to connect together the Local Area Network (LAN) of two or more buildings as shown in Figure 1.

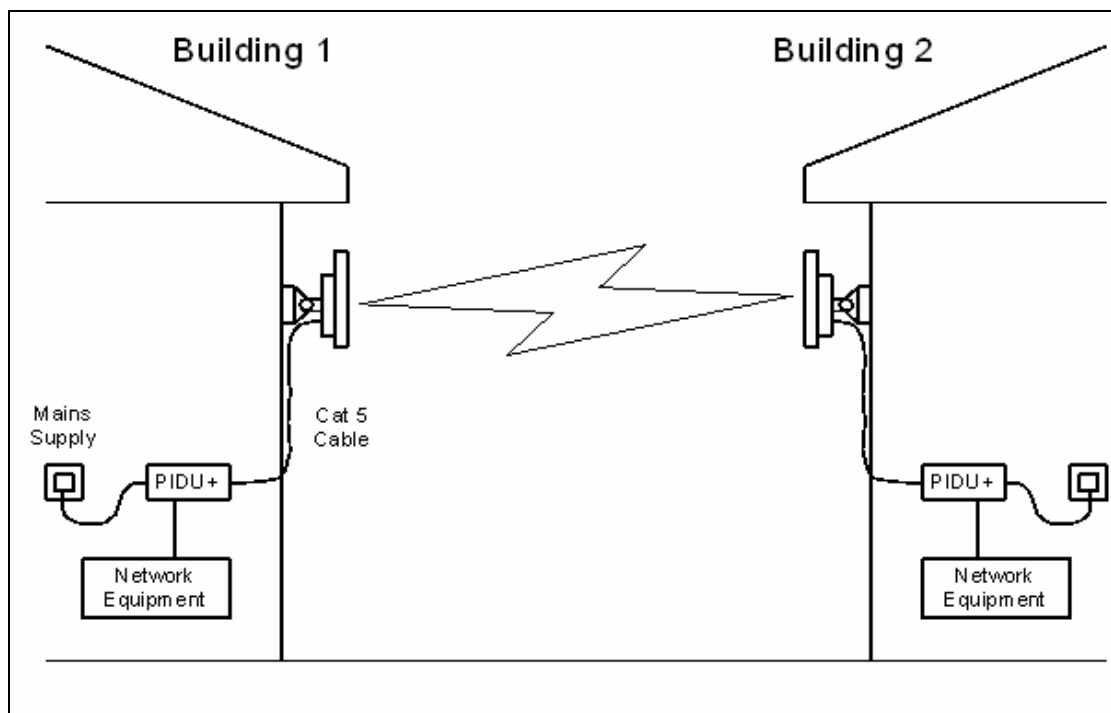

Figure 1 - Typical PTP 600 Series Bridge Deployment

The PTP 600 Series Bridge offers true non-line-of-sight (NLOS) operation by using a combination of Orthogonal Frequency Division Multiplexing (OFDM) modulation and Multiple-Input Multiple-Output (MIMO) techniques. These technologies enable the PTP 600 Series Bridge to drive through foliage and around buildings to such an extent that almost universal coverage can be expected at short range.

A PTP 600 Series Bridge system consists of a pair of identical devices that are deployed one at each end of the link. At installation, the user sets up one unit as the Master and the other as the Slave. Either unit can be configured as master or slave.

Each end of the link consists of:

- An integrated outdoor transceiver unit containing all the radio and networking electronics hereafter referred to as the Outdoor Unit (ODU).
- An indoor connection box containing a mains power supply, status indicators and network connection port. Hereafter referred to as the Power Indoor Unit Plus (PIDU Plus).

A pair of units is normally supplied pre-configured as a link.

The network connection to a PTP 600 Series Bridge is made via a 1000BaseT Ethernet connection. Power is provided to the ODU over the 1000BaseT Ethernet connection using a patented non-standard powering technique.

Previous releases of the PTP 600 Series Bridge platform used different powering and connection arrangements. Users of equipment prior to “Mod Record 1” should refer to the User Guide shipped with the original equipment. The “Mod Record” label can be found on the back of the ODU as shown in Figure 2.



Figure 2 - Mod Record Label

Alternately, the network connection to a PTP 600 Series Bridge can be made using a 1000BaseSX Fiber Optic cable connected directly to the ODU. In this case power is still provided over the 1000BaseT Ethernet connection. In the case of Fiber Optic cable failure the PTP 600 Series Bridge will automatically fall back to the copper Ethernet connection (provided the cable length $\leq 100\text{m}$ [330 ft]). “PTP 600 Series Optical Interface Upgrade Kits” can be obtained from your distributor, reseller or system integrator.

Power is fed into the PTP 600 Series Bridge PIDU Plus from the mains via a standard “figure of eight” mains plug. Connection between the ODU and PIDU Plus is made using standard CAT5e outdoor UV resistant cable. Connection between the PIDU Plus and the Network Equipment is made using standard CAT5e cable.

3.3.1 The Outdoor Unit (ODU)

The ODU (Figure 3) is a self-contained unit. It houses both radio and networking electronics. The ODU for the PTP 600 Series Bridge should only be deployed using the supplied PTP 600 Series Bridge PIDU Plus.



Figure 3 – PTP 600 Series Bridge Outdoor Unit (ODU)

3.3.2 PIDU Plus – PTP 600 Series Bridge

The PTP 600 Series Bridge PIDU Plus is used to generate the ODU supply voltage from the mains supply and inject this supply voltage into the 1000BaseT Ethernet connection to the ODU. Connection uses a CAT5e cable using standard RJ45 wiring.



WARNING Care should be taken not to connect equipment other than an ODU for the PTP 600 Series Bridge to a PIDU Plus ODU port as equipment damage may occur. The PTP 600 Series Bridge PIDU Plus is not compatible with the PTP 600 Series Bridge PIDU Plus.



Figure 4 - Power Indoor Unit (PIDU Plus) – PTP 600 Series

The front panel contains indicators showing the status of the power and Ethernet connections.

The power indicator is illuminated when the PIDU Plus is receiving mains power.

The Ethernet indicator normally illuminates when the Ethernet link is working, flashing when there is Ethernet activity. The fact that it lights also indicates that the ODU is powered. At power up the LED will flash 10 times to indicate that a correct start up sequence has occurred. See Section 8 “Fault Finding” for further fault finding information.

At the bottom of the PIDU Plus is an entry point for the PIDU Plus to ODU cable, the 1000BaseT Ethernet network port and the Recovery switch.



Figure 5 – PIDU Plus Recovery Switch Location

The Recovery switch is used to recover the unit from configuration errors or software image corruption. To put a PTP 600 Series Bridge into Recovery mode the Recovery switch should be pressed then the power applied. The Recovery switch should be kept pressed for at least 20 seconds after the power has been applied. Full instruction on the recovery mode can be found in section 9 “Recovery Mode”.

A simple reboot can be performed by removing and re-applying the mains power to the PTP 600 Series Bridge PIDU Plus.

On the left hand side of the PIDU Plus, 48V DC input and output connections can be found. These are used to power the PTP 600 Series Bridge from an external DC source or to provide a level of power supply redundancy, as shown in Section 1.3.3 “Redundancy and Alternate Powering Configurations”.



WARNING When using alternate DC supplies the supply **MUST** comply with the following requirements:

- The voltage and polarity is correct and is applied to the correct terminals in the PIDU Plus
- The power source is rated as SELV
- The power source is rated to supply at least 1A continuously, and
- The power source cannot provide more than the Energy Hazard Limit as defined by IEC/EN/UL6090, Clause 2.5, Limited Power (The Energy Hazard Limit is 240VA)

Also on the left hand side of the PTP 600 Series Bridge PIDU Plus, connectors and jumpers can be found that allow the remote connection of power LED, Ethernet LED and Recovery switch. The connection instructions can be found in Section 1.3.4 “Remote LEDs and Recovery Switch”

The input supply range for the 600 Series PIDU Plus is 100V-240V AC, 47-63Hz. Mains connection to the PIDU Plus is made using a standard “figure of eight” mains lead as shown in Figure 6.



Figure 6 – PTP 600 Series Bridge PIDU Plus Power Input

3.3.3 Redundancy and Alternate Powering Configurations

NOTE: The use of DC supplies of less than 55v will reduce the usable distance between the PIDU Plus and ODU see Figure 7.

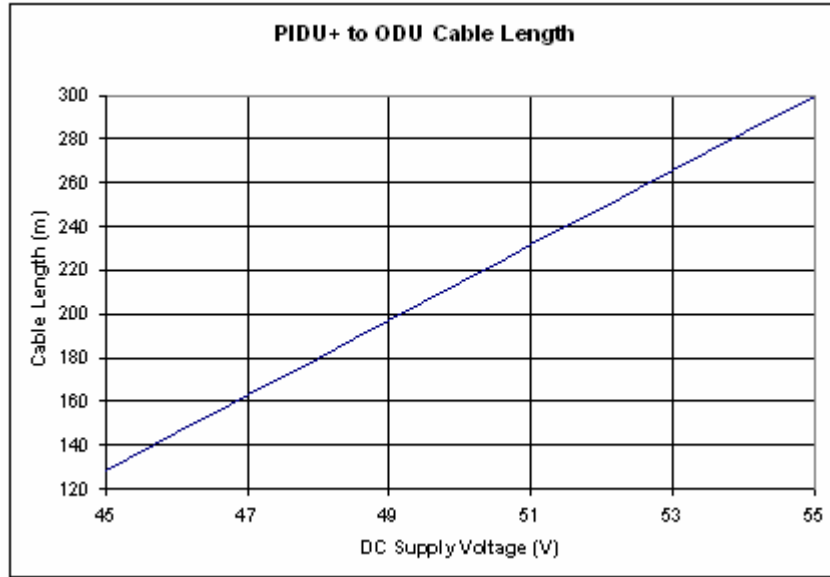

Figure 7 – PTP 600 Series Bridge PIDU Plus to ODU Cable Length Graph



WARNING: The maximum distance from the ODU to the connected network equipment is 100m (330 ft) when using 1000BaseT. Powering distances over 100m (330 ft) are only applicable when using a 1000BaseSX (Fiber Optic) connection.

3.3.3.1 External DC Supply Only

For use where there is no mains supply.

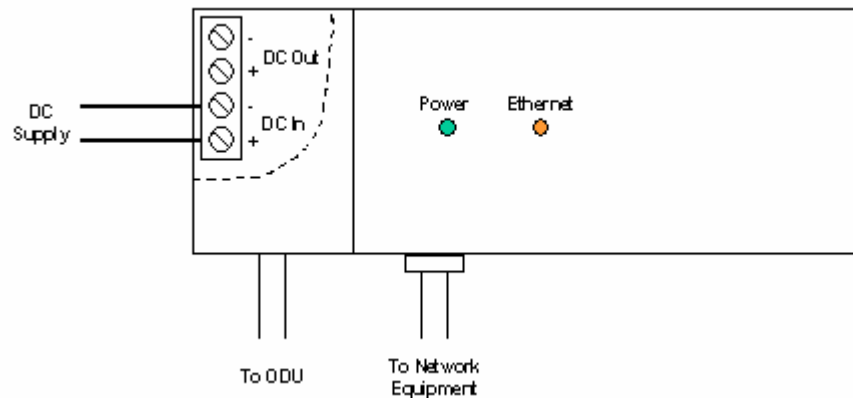

Figure 8 - External DC Supply Only

3.3.3.2 External DC Supply and AC Supply

To give redundancy through the use of mains and DC supply.

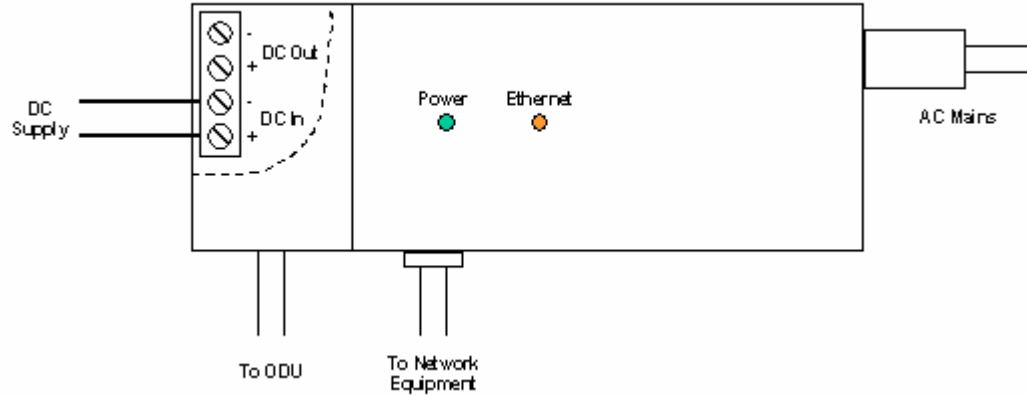

Figure 9 - External DC Supply and AC Supply

3.3.3.3 External DC Supply and Redundant AC Supply

To guard against mains failure, DC supply failure of PTP 600 Series Bridge PIDU Plus failure.

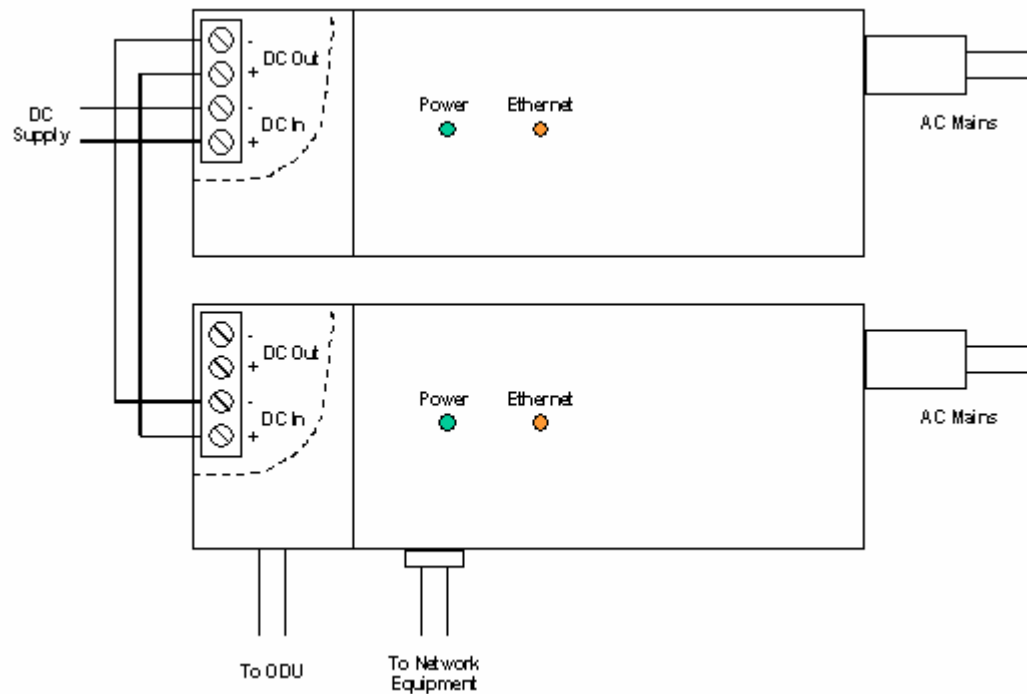

Figure 10 - External DC Supply and Redundant AC Supply

3.3.4 Remote LEDs and Recovery Switch

The PTP 600 Series Bridge PIDU Plus provides a facility to connect remote LEDs and Recovery switch allowing the PIDU Plus to be mounted inside an enclosure. At the left hand end of the PIDU Plus under the ODU connection cover can be found a PCB header and three jumpers. Jumpers J906 and J907 should be removed and connection to the remote LEDs and Recovery switch made to J908 as shown in Figure 11.

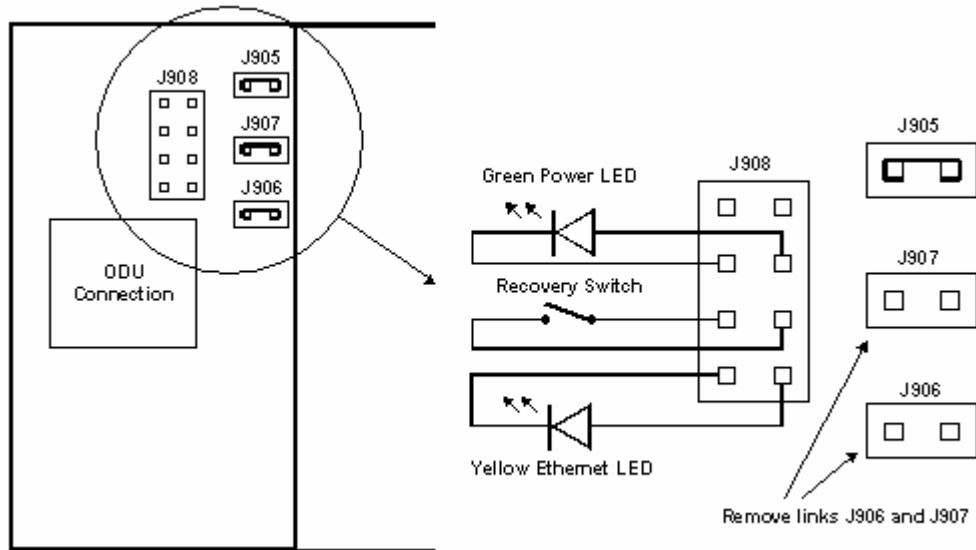

Figure 11 - Remote LED and Recovery Switch Wiring

3.3.5 Cables and connectors

The cable used to connect the PTP 600 Series Bridge PIDU Plus to the ODU can be any standard CAT5e type provided that it is suitable for outdoor deployment. Motorola recommends that cables to the specification below be used:

NEC/CEC: CMR (ETL) C (ETL) 75C SUN RES OIL RES II

Failure to use the recommended (or equivalent) standard of cable may invalidate the system's safety certification.

The cable used to connect the PTP 600 Series Bridge PIDU Plus to the users Network Equipment can be any standard CAT5e Cable.

The PIDU Plus to ODU and the PIDU Plus to Network Equipment cables may be unshielded (UTP) or shielded (STP). However, unshielded cables reduce the system's ability to cope with nearby lightning strikes. If lightning activity is common in the area of deployment, the use of shielded cable is highly recommended. See Section 10 "Lightning Protection".

The PIDU Plus provides screen continuity between the ODU and Network Equipment connections.

The ODU network connection implements automatic MDI/MDI-X sensing and pair swapping allowing connection to another piece of networking equipment or directly to end user equipment.

3.3.6 Surge Arrestor



The PTP 600 Series Bridge PIDU Plus meets the low level static discharge specifications identified in Section 21 "Specifications", but does not provide lightning or surge suppression. Installations will generally require lightning or surge suppression, a separate Ethernet surge suppressor must be used and appropriately earthed. Suitable surge suppressors can be sourced from your Motorola Point-to-Point Distributor or Solutions Provider. See Section 11 "Lightning Protection".

3.3.7 Mounting Brackets

The PTP 600 Series Bridge is supplied with a mounting bracket suitable for mounting the ODU to a pole of 50mm (2") to 75mm (3") in diameter. For more details on mounting, see section 7 "Installation".

The bracket allows for adjustment in both azimuth and elevation. The bracket may be split allowing the pole mount section of the bracket to be mounted to the pole first. This allows the installer to take the weight of the unit and secure it, one handed, with a single mounting bolt.

The PIDU Plus can either be desk or wall mounted. The preference is wall mounted with the cables dressed to a cable channel. Wall mounting is achieved by screwing through the mounting lugs on either side of the unit. Remember to leave space for access to the Recovery button. See section 3.3.2.



3.3.8 Configuration and Management

Configuration and Management of the PTP 600 Series Bridge is implemented using an inbuilt web server hosting a number of Configuration and Management web pages. This approach allows Configuration and Management to be carried out on any standard web browsing technology. The PTP 600 Series Bridge can also be managed remotely using the SNMP management protocol. Connection to the bridge is via the Ethernet connection carrying the bridge network traffic. Connection to the unit is via a preset IP address. This address can be changed via the Network Interface Configuration web page. A full explanation of the available web pages and their use can be found in Section 6 “Web Page Reference”.

3.4 Warranty

Motorola’s standard hardware warranty is for one (1) year from date of shipment from Motorola or a Motorola Point-to-Point Distributor. Motorola warrants that hardware will conform to the current relevant published specifications and will be free from material defects in material and workmanship under normal use and service. Motorola shall within this time, at its own option, either repair or replace the defective product within thirty (30) days of receipt of the defective product. Repaired or replaced product will be subject to the original warranty period but not less than thirty (30) days.

Motorola warranty for software is for six (6) months from date of shipment from Motorola or Distributor. Motorola warrants that software will perform substantially in accordance with the published specifications for that release level of the software and will be free from material defects in material and workmanship under normal use and service. Motorola shall within this time correct or replace software to correct program or documentation errors.

IN NO EVENT SHALL MOTOROLA, INC. BE LIABLE TO YOU OR ANY OTHER PARTY FOR ANY DIRECT, INDIRECT, GENERAL, SPECIAL, INCIDENTAL, CONSEQUENTIAL, EXEMPLARY OR OTHER DAMAGE ARISING OUT OF THE USE OR INABILITY TO USE THE PRODUCT (INCLUDING, WITHOUT LIMITATION, DAMAGES FOR LOSS OF BUSINESS PROFITS, BUSINESS INTERRUPTION, LOSS OF BUSINESS INFORMATION OR ANY OTHER PECUNIARY LOSS, OR FROM ANY BREACH OF WARRANTY, EVEN IF MOTOROLA, INC. HAS BEEN ADVISED OF THE POSSIBILITY OF SUCH DAMAGES. (Some States in the USA do not allow the exclusion or limitation of incidental or consequential damages, so the above exclusion or limitation may not apply to you.) IN NO CASE SHALL MOTOROLA’S LIABILITY EXCEED THE AMOUNT YOU PAID FOR THE PRODUCT.

4 Product Architecture

The PTP 600 Series Bridge consists of an identical pair of units deployed one at each end of the link. The radio link operates on a single frequency channel in each direction using Time Division Duplex (TDD). One unit is deployed as a master and the other as a slave. The master unit takes responsibility for controlling the link in both directions.

The non-line-of-sight (NLOS) aspects of the product are provided by Multiple-Input Multiple-Output (MIMO), coupled with Orthogonal Frequency Division Multiplexing (OFDM) modulation.

The PTP 600 Series Bridge has been developed to operate within license exempt frequency bands.

The current product range supports:

- ETSI 5.4 GHz band B (5.470-5.725 GHz)
- ETSI 5.8 GHz band C (5.725–5.850 GHz) and the USA 5 GHz ISM band (5.725-5.850 GHz)

The PTP 600 Series Bridge has been designed to coexist with other users of the band in an optimal fashion using a combination of Transmit Power Control (TPC), Spectrum Management functionality and Antenna beam shape.

In order to maintain link availability, the product employs adaptive modulation techniques that dynamically reduce the data rate in severe or adverse conditions. To the data network the PTP 600 Series Bridge is implemented as a learning bridge. A learning bridge builds up a picture of which addresses are connected to which port. This means that it will not bridge a packet if it knows that the destination address is connected to the same port on which the bridge saw the packet. Figure 12 illustrates the PTP 600 Series Bridge layer diagram.

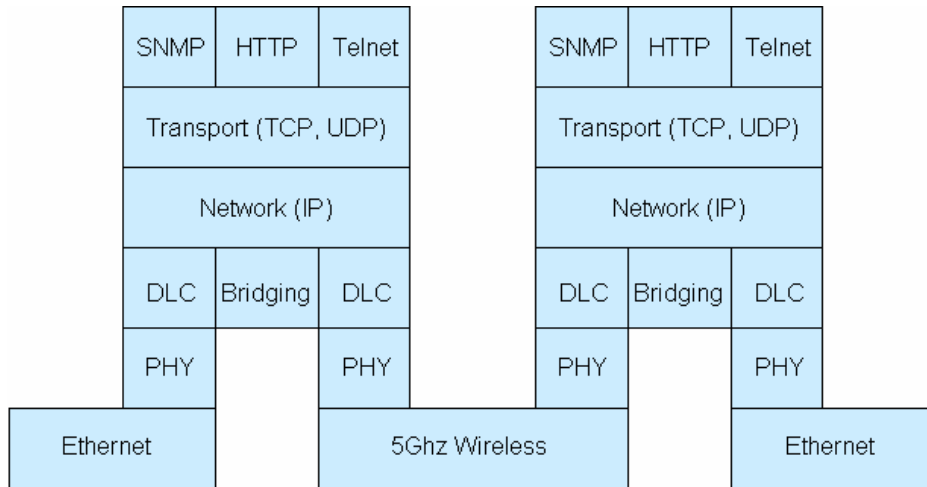

Figure 12 – PTP 600 Series Bridge Layer Diagram

The PTP 600 Series Bridge functionality has been extended to encompass the specification IEEE 802.1p. IEEE 802.1p uses Ethernet packets extended by 4 bytes, as specified in IEEE 802.1q for VLAN tagging, to prioritize packets over the wireless interface. The PTP 600 Series Bridge will forward all VLAN tagged packets regardless of the VLAN ID value.

Each unit in the link is manageable through an IP connection. Standard IP protocols are utilized for all management functions e.g. HP, SNMP, etc. The unit can be configured to use VLAN tags on the management interfaces.

The PTP 600 Series Bridge is fully software upgradeable. New software images are first downloaded from the Motorola website <http://www.motorola.com/ptp> to a convenient computer. The image is then uploaded to the ODU via the web management page described in section 8.3.6 “Software Upgrade”. The compressed image is first loaded into RAM and check-summed. If the compressed image transfer has completed successfully the image is decompressed and written to Flash memory. On completion of this process the unit can be rebooted to use the newly uploaded image. Should this process fail, the unit will revert to a protected compressed image installed during manufacturing to allow the unit to be recovered.

5 General Considerations

5.1 Spectrum Planning

The PTP 600 Series Bridge has two frequency variants in its product range.

Band	Definition	Frequency Coverage	Channel Width	Channel Raster
5.4 GHz	ETSI 5 GHz band B, USA UNII Band	5470-5725 MHz	30 MHz	10 MHz
5.8 GHz	USA ISM Band / ETSI 5 GHz band C	5725-5850 MHz	30 MHz	10 MHz

Table 5 - PTP 600 Series Bridge Frequency Variants

There are two distinct approaches to spectrum planning:

- First an operator can utilize the default spectrum management mode i-DFS (intelligent Dynamic Frequency Selection). This mode uses the PTP 600 Series Bridge ability to measure the interference levels in all channels to build up a picture of the interference / noise levels in all channels. The PTP 600 Series Bridge uses statistical techniques to select the most appropriate transmit and receive channels. I-DFS can be influenced in its channel decision process by selectively barring channels from use. The use of this functionality is described in detail in section 8.3.7 “Spectrum Management”.
- Second, when detailed control of the spectrum allocation is required, it is recommended that the fixed frequency mode is used to statically allocate transmit and receive channels.

5.2 Region Codes

The PTP 600 Series Bridge uses a system of Region Codes to control the operation of the radio link. The Region Code is set by a License Key.



WARNING To meet the regulatory requirements of your region you should set the correct Region Code by obtaining a new License Key from you reseller or distributor.

Region Code	Frequency Band	Regulations / Countries	Max Tx Power	EIRP Limit	Operational Restrictions (see section 5.3)
1	5.8 GHz	FCC Compliant (e.g. USA, Canada, Taiwan, Brazil)	25dBm	None	Reduced TX Power at Band Edges see section 5.4.2 "Transmit Power Reduction at the Band Edges"
2	5.8 GHz	China	10dBm	33dBm	
3	5.8 GHz	Australia , Hong Kong	13dBm	36dBm	
4	5.8 GHz	UK	10dBm	33dBm	Radar and RTTT (Road Transport and Traffic Telematics, 5795 to 5815 MHz) Radar Avoidance Enabled
5	5.8 GHz	Singapore	-3dBm	20dBm	
6	5.8 Ghz	Eire	10dBm	33dBm	
7	5.8 Ghz	Norway	25dBm	53dBm	Radar and RTTT (Road Transport and Traffic Telematics, 5795 to 5815 MHz) Radar Avoidance Enabled
8	5.4 / 5.8 GHz	Unregulated /Internal Use	25dBm	None	
11	5.4 GHz	Korea	20dBm	43dBm	Band restricted : 5725 MHz to 5825 MHz

Region Code	Frequency Band	Regulations / Countries	Max Tx Power	EIRP Limit	Operational Restrictions (see section 5.3)
12	5.4 GHz	ETSI, USA	7dBm	30dBm	Radar Avoidance Enabled
13	5.4 GHz	Australia, Canada	7dBm	30dBm	Radar Avoidance Enabled; Weather Radar Band (5600 to 5650MHz) barred

Table 6 – PTP 600 Series Bridge Region Code Definitions

When shipped from the factory units⁶ are configured as follows:

- PTP 600 Series Bridge 5.4 GHz – Region Code 12⁷
- PTP 600 Series Bridge 5.8 GHz – Region Code 1

5.3 Operational Restrictions

5.3.1 Radar Avoidance

Radar Avoidance requires that equipment used in the region:

- Detects interference from other systems and avoids co-channel operation with these systems, notably radar systems.
- Provide on aggregate a uniform loading of the spectrum across all devices.

To address the primary aims the Spectrum Management algorithm implements a radar detection function which looks for impulsive interference on the active channel only. If impulsive interference is detected Spectrum Management will mark the current active channel as having detected radar and initiate a channel hop to an available channel. The previous active channel will remain in the radar detected state for thirty minutes after the last impulsive interference pulse was detected. After the thirty minutes have expired the channel will be returned to the available channel pool.

⁶ Note that 5.8GHz and 5.4GHz are different products.

⁷ Note that the Quickstart Guide also contains the license keys for region 10. This bars operation in the Band 5600 – 5650 MHz and MUST be used for equipment deployed in Canada and Australia.

The radar detection algorithm will always scan the active channel for 60 seconds for radar interference before using the channel. This compulsory channel scan will mean that there is a 60 seconds service outage every time radar is detected and that the installation time is extended by 60 seconds even if there is found to be no radar on the channel.



NOTE: On system installation or start-up this extends the initial scan time of the Master unit by 60 seconds.

To address the “provide aggregate uniform loading of the spectrum across all devices” requirement, the channel selection algorithm will choose a channel at random from a list of available channels. The channel selection algorithm is initiated at link initialization and when radar interference is detected.

5.3.2 RTTT Avoidance and Other Channel Use Restrictions

Where regulatory restrictions apply to certain channels these channels are barred. The user should note that the number of channels barred is dependant on the channel raster selected. For example see the effect of the UK RTTT channel restrictions in Figure 13. Barred channels are indicated by a “No Entry” symbol displayed on the “Spectrum Management” web page, see section 8.3.9 “Spectrum Management Control - With Operational Restrictions”.

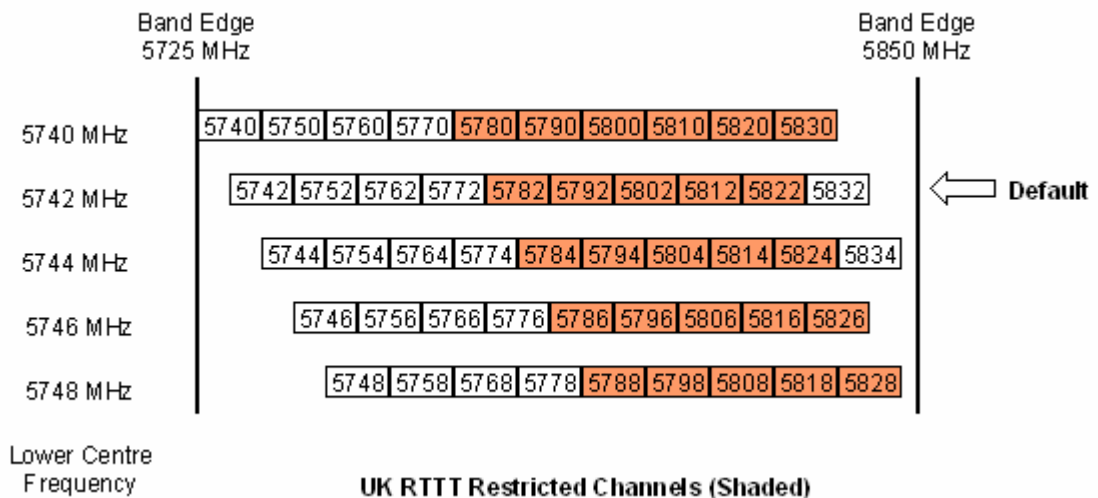

Figure 13 - 5.8 GHz UK RTTT Channel Avoidance

5.4 5.4GHz Specific Frequency Planning Considerations

Adjustment of the lower center frequency allows the operator to slide the available frequency settings up and down the 5.4 GHz band. See Figure 14.

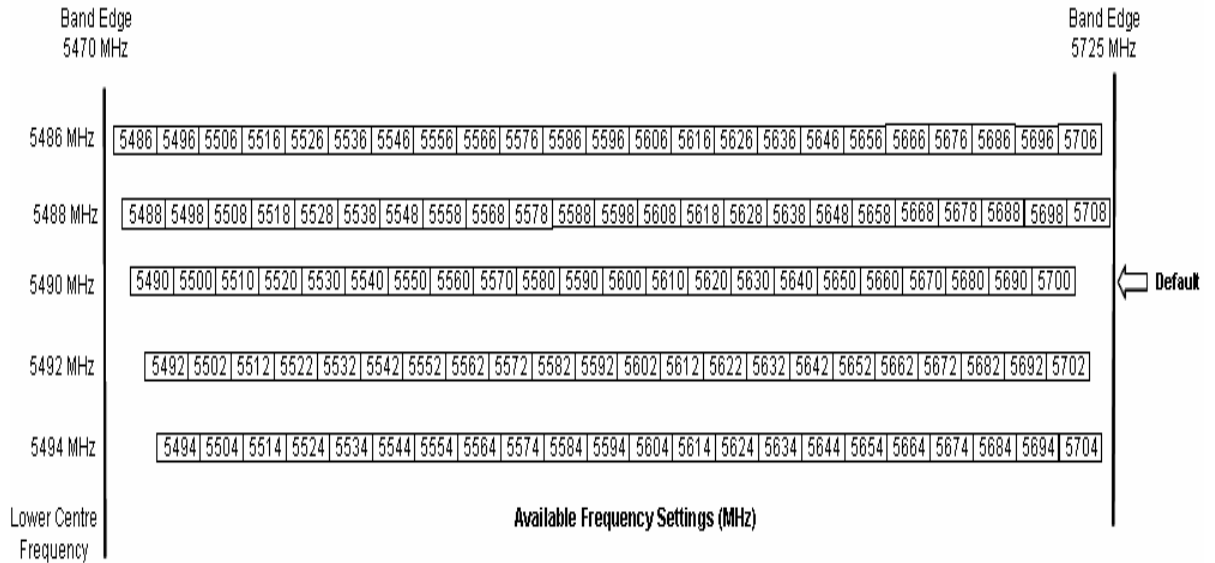

Figure 14 - 5.4 GHz Available Spectrum Settings

5.4.1 Raster Considerations

The PTP 600 Series Bridge 5.4 GHz variant operates on a 10 MHz channel raster that is set to even center frequencies. See Figure 14.

5.4.2 Transmit Power Reduction at the Band Edges

The 5.4 GHz product variant does not apply any band edge power reduction.

5.4.3 5.8GHz Specific Frequency Planning Considerations

Adjustment of the lower center frequency allows the operator to slide the available frequency settings up and down the 5.8 GHz band. See Figure 15.

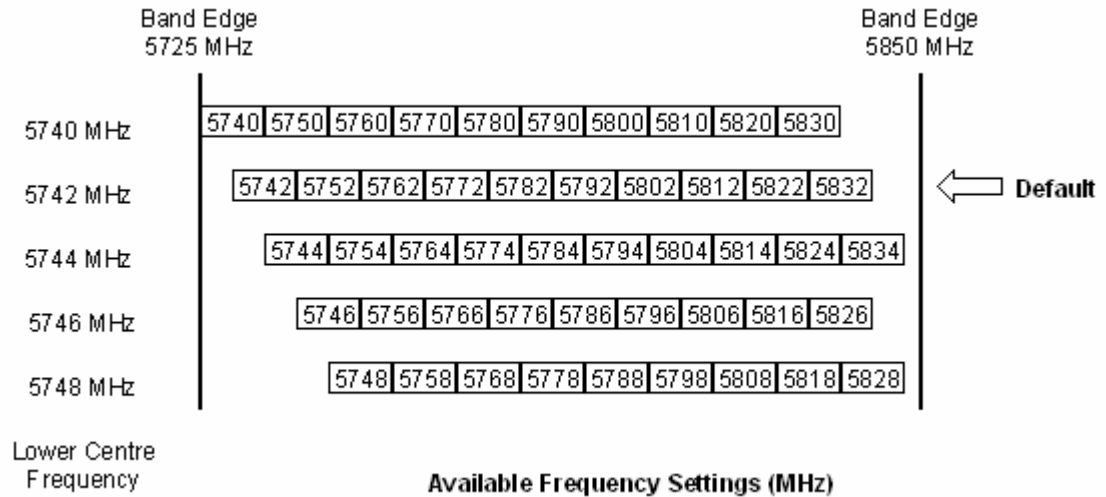

Figure 15 - 5.8 GHz Available Spectrum Settings

5.4.4 Raster Considerations

The PTP 600 Series Bridge 5.8 GHz variant operates on a 10 MHz channel raster that is set to even center frequencies. See Figure 15.

5.4.5 Transmit Power Reduction at the Band Edges

Operation at or near the 5.8 GHz band edges can result in a lower maximum transmit power. In some configurations the PTP 600 Series Bridge solution reduces the power when operating at the edge channels. The amount of reduction, if any, is dependant on the region code of the region of operation. This currently only affects systems configured with Region Code 1.

The power reduction in the edge channels is presented in Figure 16.

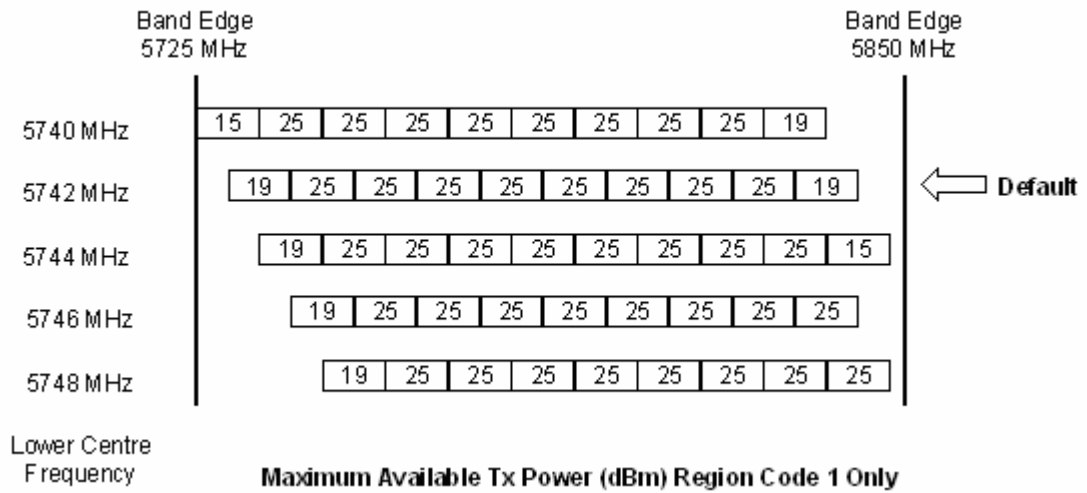

Figure 16 - 5.8 GHz Band Edge TX Power Reduction (Region Code 1 Only)

5.5 Distance

The PTP 600 Series Bridge will operate at ranges from 100 m (330 ft) to 200 km (124 miles), within 3 modes: 0-40km (0-25 miles), 0-100km (0-62 miles) and 0-200km (0-124 miles). Operation of the system will depend on obstacles in the path between the units. Operation at 40 km (25 miles) or above will require a near line-of-sight path. Operation at 100m (330 ft) could be achieved with one unit totally obscured from the other unit, but with the penalty of transmitting at higher power in a non-optimal direction, thereby increasing interference in the band. This subject is covered in more detail in section 6.1.3 "Path Loss Considerations".

5.6 Networking Information

The PTP 600 Series Bridge operates as a transparent Ethernet bridge. Each unit requires an IP address. This IP address is for management purposes only and it plays no part in the operation of the system. IP addresses are assigned during initial configuration as described in section 7.2 “Installation Procedure”.

5.7 Lightning Protection

The amount of lightning protection is dependent on regulatory requirements and the end user requirements. The standard ODU for the PTP 600 Series Bridge is fitted with surge limiting circuits and other features to minimize the risk of damage due to nearby lightning strikes. These standard features may require some additional equipment to be configured as part of the system installation to be fully effective. Motorola recommends the use of screened cable and a surge arrestor to protect connected equipment from nearby strikes.

NOTE: The PTP 600 Series Bridge is not designed to survive direct lightning strikes. For this reason the unit should not be installed as the highest point in a localized area, unless specific precautions are taken. See section 11 “Lightning Protection”.

5.8 Electrical Requirements

The PTP 600 Series Bridge is supplied with a variable input voltage (100-240V, 47-63Hz AC) inline power supply unit which is incorporated into the Power Indoor Unit (PIDU Plus). The PTP 600 Series Bridge requires one mains supply outlet at each end of the link.

6 Site Planning

6.1 Site Selection Criteria

The following are guidelines for selecting the installation location of the ODU and PDU Plus for a PTP 600 Series Bridge.

6.1.1 ODU Site Selection

When selecting a site for the ODU the following should be taken into consideration:

- It is not possible for people to stand or walk inadvertently in front of the antenna
- Height and location to achieve the best radio path
- Height in relation to other objects with regard to lightning strikes
- Protection from the weather
- Aesthetics and planning permission issues
- Distance from the ODU and connected Network equipment (Maximum cable run from the ODU to the connected equipment is 100m [330 ft])
- Distance from the PIDU Plus to the ODU (Maximum cable run from the PIDU Plus to the ODU is 100m [330 ft] when using the 1000BaseT interface)

6.1.2 PTP 600 Series Bridge PIDU Plus Site Selection

When selecting a site for the PIDU Plus the following should be taken into consideration:

- Availability of a mains electricity supply
- Accessibility for viewing status indicators and pressing reset switch (See section 3.3.2 and section 10)

6.1.3 Path Loss Considerations

The path loss is the amount of attenuation the radio signal undergoes between the two ends of the link. The path loss is the sum of the attenuation of the path if there were no obstacles in the way (Free Space Path Loss), the attenuation caused by obstacles (Excess Path Loss) and a margin to allow for possible fading of the radio signal (Fade Margin).

$$L_{free_space} + L_{excess} + L_{fade} + L_{seasonal} < L_{capability}$$

Where

L_{free_space} Free Space Path Loss (dB)

L_{excess} Excess Path Loss (dB)

L_{fade} Fade Margin Required (dB)

$L_{seasonal}$ Seasonal Fading (dB)

$L_{capability}$ Equipment Capability (dB)

Equation 1 - Path Loss

6.1.4 Aggregate Ethernet throughput rate v maximum link loss

The equipment capability is given in Table 7 and Table 8. These tables give the Ethernet throughput rate versus link loss for PTP 600 Series Bridge in all modes. Adaptive modulation will ensure that the highest throughput that can be achieved instantaneously will be obtained taking account of propagation and interference. The calculation of Equation 1 needs to be performed to judge whether a particular link can be installed. When the link has been installed, web pages provide information about the link loss currently measured by the equipment both instantaneously and averaged. The averaged value will require maximum seasonal fading to be added, and then the radio reliability of the link can be computed.

Modulation Mode / Payload Type	Maximum Aggregate Data Rate ^{8 9} (Mbit/s)	Threshold Value (dBm)	Output Power (dBm)	Maximum Link Loss (dB)
256QAM 0.81 dual	300.2	-61.0	+18	126.0
64QAM 0.92 dual	252.9	-63.9	+18	128.8
64QAM 0.75 dual	206.7	-68.6	+18	133.6
16QAM 0.87 dual	160.8	-71.8	+20	138.8
16QAM 0.63 dual	115.6	-77.0	+22	146.0
16QAM 0.63 single	57.8	-80.1	+22	149.1
QPSK 0.87 single	40.2	-82.4	+23	152.4
QPSK 0.63 single	28.9	-85.9	+24	156.9
BPSK 0.63 single	14.4	-88.9	+25	160.9
256QAM 0.81 single	150.1	-65.4	+18	130.4
64QAM 0.92 single	126.4	-67.6	+18	132.6
64QAM 0.75 single	103.3	-73.0	+18	138.0
16QAM 0.87 single	80.4	-75.9	+20	142.9

Table 7 - 5.4GHz Aggregate Ethernet throughput rate versus maximum link loss

⁸ Aggregate data rate in 40:40 mode for a 1km link length

⁹ Data rates for PTP 600 Series Bridge Lite product are 50% of the figures shown

Modulation Mode / Payload Type	Maximum Aggregate Data Rate ^{10 11} (Mbit/s)	Threshold Value (dBm)	Output Power (dBm)	Maximum Link Loss (dB)
256QAM 0.81 dual	300.2	-59.1	+18	124.1
64QAM 0.92 dual	252.9	-62.0	+18	127.0
64QAM 0.75 dual	206.7	-68.1	+18	133.1
16QAM 0.87 dual	160.8	-71.0	+20	138.0
16QAM 0.63 dual	115.6	-75.2	+22	144.2
16QAM 0.63 single	57.8	-79.3	+22	148.3
QPSK 0.87 single	40.2	-81.6	+23	151.6
QPSK 0.63 single	28.9	-84.6	+24	155.6
BPSK 0.63 single	14.4	-88.1	+25	160.1
256QAM 0.81 single	150.1	-64.0	+18	129.0
64QAM 0.92 single	126.4	-65.9	+18	130.9
64QAM 0.75 single	103.3	-71.7	+18	136.7
16QAM 0.87 single	80.4	-74.8	+20	141.8

Table 8 - 5.8GHz Aggregate Ethernet throughput rate versus maximum link loss

The full calculation is relatively complicated and thus Motorola has supplied a link estimator that calculates the radio propagation and reliability of NLOS links using the PTP 600 Series Bridge equipment.

A more detailed discussion on data rates can be found in Section 16.

¹⁰ Aggregate data rate in 40:40 mode for a 1km link length

¹¹ Data rates for PTP 600 Series Bridge Lite product are 50% of the figures shown

7 Installation

Motorola recommends that only qualified personnel undertake the installation of a PTP 600 Series Bridge solution.

7.1 Preparation

Before proceeding with the installation you should:

- Check the contents of all packages against the parts lists shown in the packing list.
- Ensure that you have the correct tools for the job.
- Ensure that you are qualified to undertake the work.
- Ensure that you have taken the correct safety precautions.
- Have completed the site planning as described in section 6 “Site Planning”.

7.2 Installation Procedure

The 600 Series installation procedure consists of the following steps:

- Mounting the ODUs, section 7.6
- Connecting up, section 7.7
- Mounting the PIDU Plus units, section 7.7.8
- Powering Up, section 7.7.10
- Aligning the ODUs, section 7.7.11

7.3 Tools Required

The following specific tools are required to install a PTP 600 Series Bridge in addition to general tools:

- 13mm Spanner / Wrench
- RJ45 Crimp Tool
- IBM Compatible Personal Computer (PC) running Windows 98 or later with 10, 100 or 1000 BaseT Ethernet (Ability to change IP settings easily is recommended)
- Either Internet Explorer version 6 or higher, or FireFox 1.5 or higher are recommended.
- Ethernet patch cable
- 6mm general purpose crimp tool for the grounding lug (optional for Lightning Protection)

7.4 Installation Support

Online installation support and contact details for your regional support can be found at <http://www.motorola.com/ptp>

A Frequently Asked Questions (FAQ) section can be found in section 19.

7.5 Legal Disclaimer

IN NO EVENT SHALL MOTOROLA, INC. BE LIABLE FOR ANY INJURY TO ANY PERSONS OR ANY DAMAGE CAUSED DURING THE INSTALLATION OF THE MOTOROLA PTP 600 SERIES PRODUCT.

7.6 Mounting the ODU_s

The ODU mounting bracket is designed to ease installation by fixing the bracket to a pole and then bringing the ODU into position using a single bolt fixing. The ODU should be mounted using the following steps ensuring that the cable entry is at the bottom.

The ODU mounting bracket is design to work with poles with diameters in the range 50mm (2") to 75mm (3").

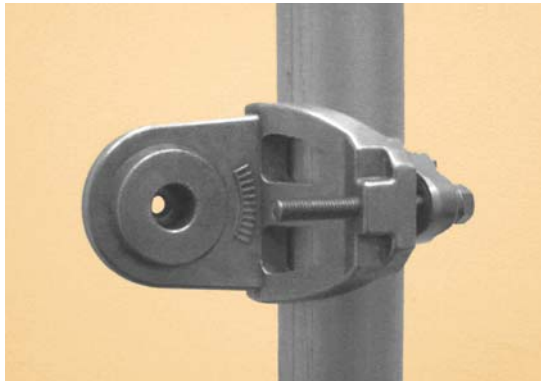

Step 1: Mount the bracket to the pole.

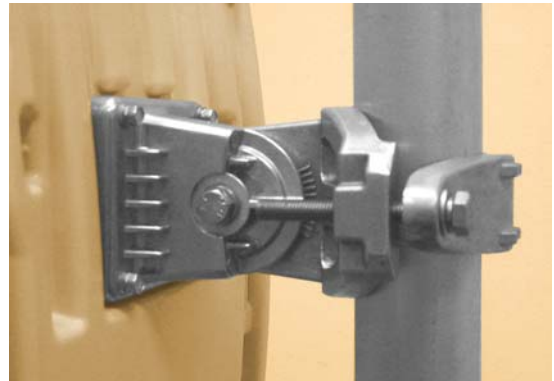

Step 2: Mate the unit to the bracket together and tighten the nut and bolt.

Pole diameters of 25mm (1") to 50mm (2") can be accommodated by inverting the back of the bracket as shown in Figure 17.



Figure 17 - Mounting to pole diameters 25mm (1") to 50mm (2")

When adjustment is complete tighten all bolts to 14Nm (11lb ft).



Warning: Do not over tighten the bolts as bracket failure may occur.

The enclosure and mounting brackets of the PTP 600 Series Bridge product range are capable of withstanding wind speeds up to 151mph (242kph). The installer should ensure that the structure the bridge is fixed to is also capable of withstanding the prevalent wind speeds and loads. See Section 11 "Wind Loading".



The integral safety loop should be used both for hoisting the ODU up a mast or building and into position, and also as a fixing point to secure a permanent safety lanyard from the tower/building to the ODU in case of mounting failure.

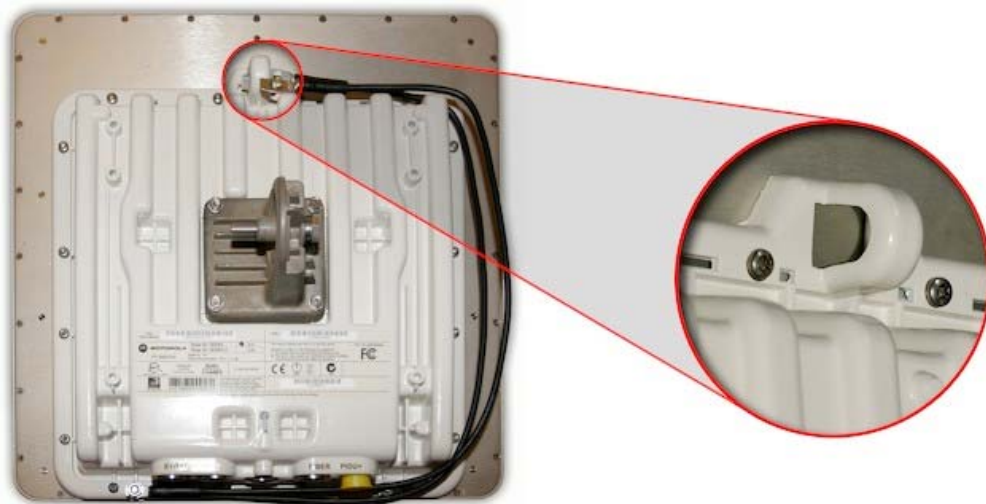

Figure 18 - Integral Safety Loop

The length of the safety lanyard must not exceed 1m (approx 3 ft) in length. The lanyard should be made from a material that does not degrade in an outdoor environment.

The safety lanyard must be fixed to a separate fixing point that is not part of the direct mounting system for the ODU.

7.7 Connecting Up

7.7.1 Preparing The PIDU Plus To ODU Cable

NOTE: The maximum cable length between the ODU and the user's Network Equipment is 100m (330 ft). Cable lengths up to 300m (984 ft) can be used where the PIDU Plus to ODU cable is supplying power only, i.e., when using the PTP 600 Series Bridge Optical Interface.

The cable should be assembled to the following instructions:



Step 1: Assemble gland on cable as shown



Step 2: Strip the outer insulation

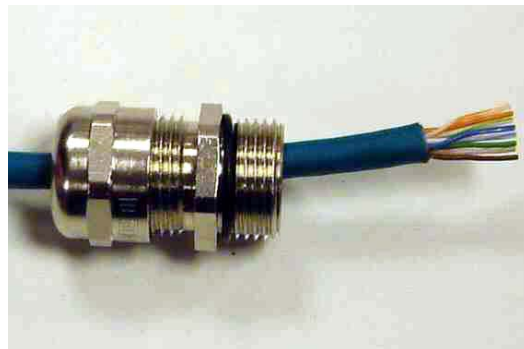

Step 3: Arrange conductors as shown in Figure 19 and cut to length

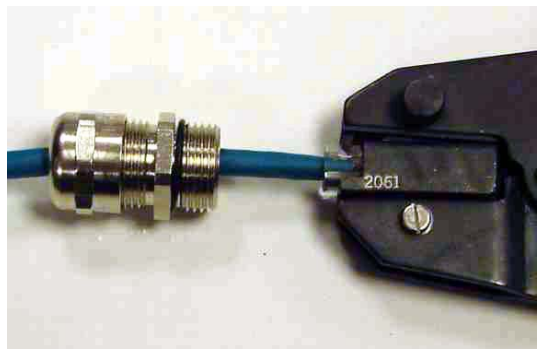

Step 4: Insert conductors and crimp



Figure 19 - Completed ODU connector

Both ends of the ODU cable are terminated in the same way. The above procedure should be repeated for the PIDU Plus end of the cable when the cable routing process is complete.

NOTE: The PIDU Plus end of the cable does not employ a cable gland.

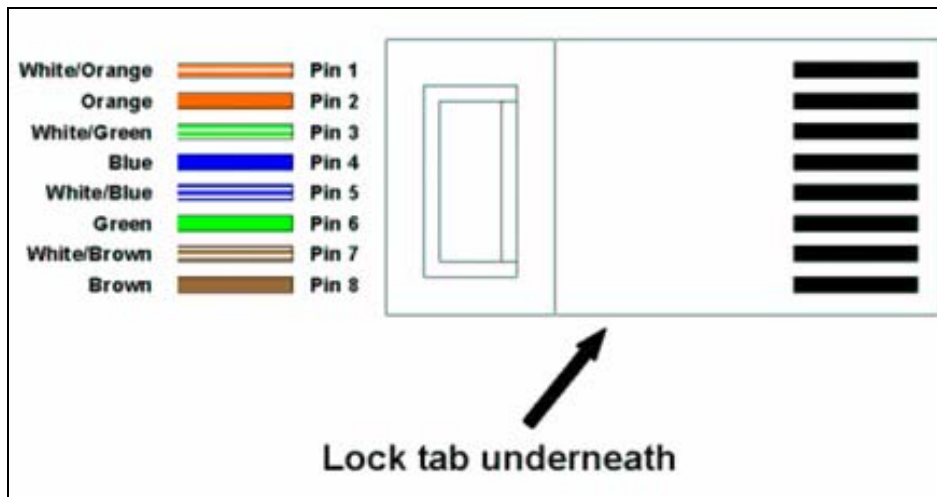

Figure 20 - RJ45 Pin Connection (T568B Color Coding)

7.7.2 Making the Connections at the ODU

Looking at the back of the unit with the cable entry at the bottom, the PTP 600 Series Bridge PIDU Plus connection is the first hole on the right (Figure 21) and is labeled “PIDU +”.

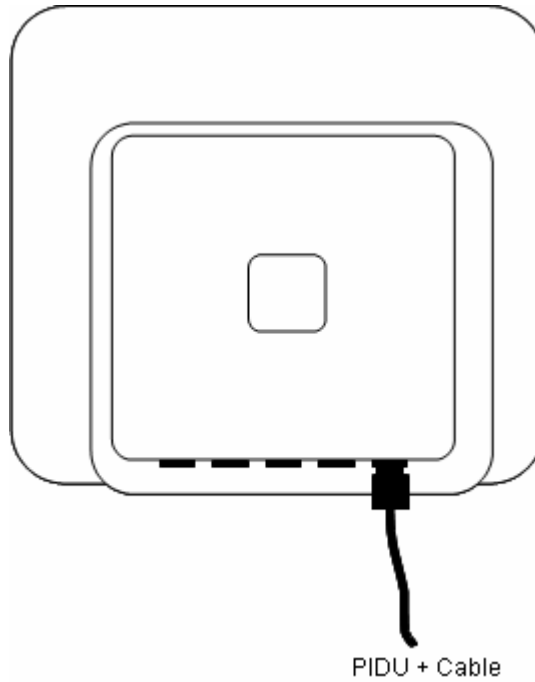

Figure 21 – PTP 600 Series Bridge PIDU Plus Connection

7.7.3 Making the PTP 600 Series Bridge PIDU Plus Connection At The ODU

The following procedure describes how connection is made at the ODU. It is often easier to carry out this procedure on the ground or a suitable surface prior to mounting the ODU.

Ensure that no power is connected to the PIDU Plus or present on the cable before connecting the ODU.



Step 1: Assemble the cable as described in 5.7.1 above



Step 2: Insert the RJ45 connector making sure that the locking tab snaps home



Step 3: Screw in the body of the weatherproofing gland and tighten



Step 4: Screw on the clamping nut and tighten

Should it be necessary to disconnect the PIDU Plus to ODU cable at the ODU, this can be achieved by removing the weather proofing gland and depressing the RJ45 locking tab with a small screwdriver as shown below:



Figure 22 - Disconnecting the ODU



Warning: Ensure that power is removed from the system at the PIDU Plus to prevent damage to the ODU while making or breaking the connection.

7.7.4 Routing the Cable

After connecting the cable to the ODU it can be routed and secured using standard cable routing and securing techniques. When the cable is in place it can then be cut to the desired length at the PIDU Plus prior to connection to the PIDU Plus

7.7.5 Fitting A Surge Arrestor

If you have opted to fit a Surge Arrestor, this should be installed by following the manufacturer's instruction. For recommended types see Section 10 "Lightning Protection"

7.7.6 Grounding the Installation

The Outdoor Unit (ODU) must be properly grounded to protect against power surges. It is the user's responsibility to install the equipment in accordance with Section 810 of the National Electric Code, ANSI/NFPA No.70-1984 or Section 54 of the Canadian Electrical Code or the National Electrical Code in the country of installation. These codes describe correct installation procedures for grounding the outdoor unit, mast, lead-in wire and discharge unit, size of grounding conductors and connection requirements for grounding electrodes. It is recommended that installation of the outdoor unit be contracted to a professional installer. See Section 10 "Lightning Protection" for recommended grounding kits".

7.7.7 Making the ODU Connection at the PTP 600 Series Bridge PIDU Plus

The ODU is connected to the PIDU Plus by means of a concealed RJ45 connector. The RJ45 connection has been placed inside the PIDU Plus hinged cover to prevent the user from inadvertently plugging other equipment into the ODU RJ45 socket.



Warning: Plugging other equipment into the ODU RJ45 socket may damage the equipment due to the non-standard techniques employed to inject DC power into the 1000BaseT connection between the PIDU Plus and the ODU. Plugging the ODU into other equipment may damage the ODU and/or the other equipment.



Step 1: Undo the retaining screw and hinge back the cover.



Step 2: Plug in the ODU into the PIDU Plus Cable ensuring that it snaps home



Step 3: Replace the cover and secure with the retaining screw

7.7.8 Making the Network Connection at The PIDU Plus – PTP 600 Series Bridge

The Network connection is made by connecting the user's Network Equipment directly to the PIDU Plus LAN port as shown in Figure 23.



Figure 23 - Making the Network Connection at the PIDU Plus

7.7.9 Mounting the PTP 600 Series Bridge PIDU Plus

This step is optional. Motorola recommends that you mount the PIDU Plus on a wall or other suitable mounting surface. This prevents the unit from being knocked or kicked and can help maintain link availability. Ensure that the reset switch can be accessed when mounting the unit.



Step 1: Fix the PIDU Plus to the wall using the lugs provided.



Step 2: Make connections as per Section 5.7.7



WARNING: The PIDU Plus is not waterproof and should be mounted away from sources of moisture. If mounted outdoors, the unit should be mounted in a rain proof enclosure, preferably ventilated.

It is also recommended that you fit a drip loop on the PIDU Plus to ODU cable to ensure that any moisture that runs down the cable into the cabinet or enclosure cannot enter the PIDU Plus. As shown in Figure 24. The network connection and mains cable should be treated in the same way if there is a risk that they can carry moisture to the PIDU Plus.

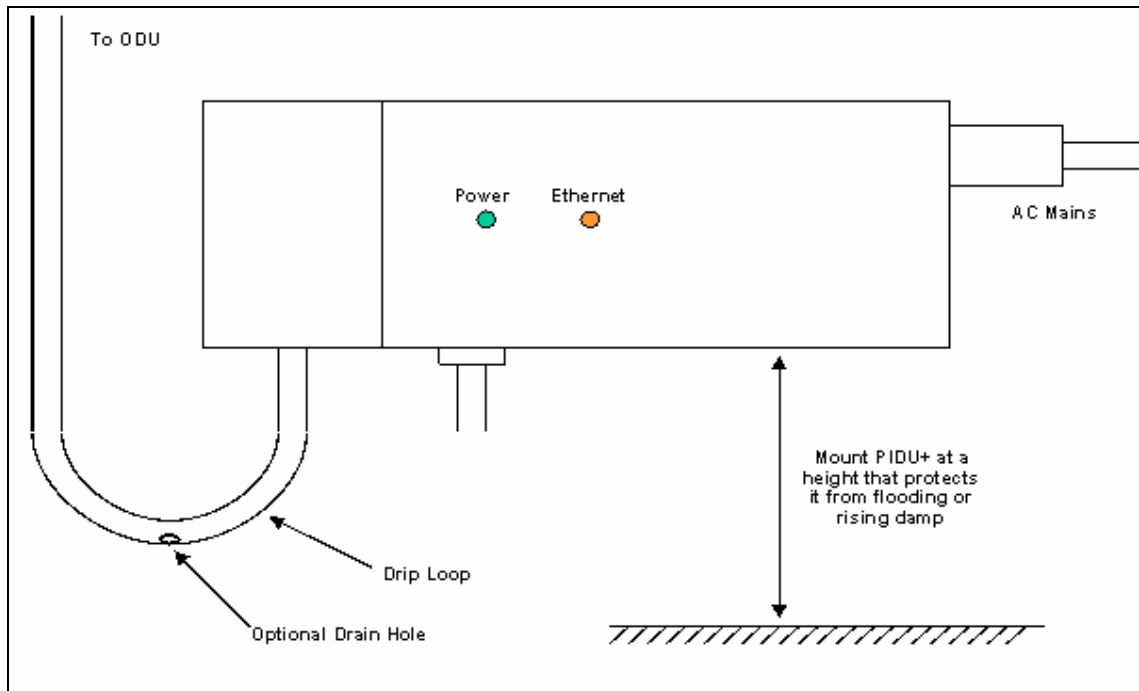

Figure 24 – PTP 600 Series PIDU Plus Drip Loop Configuration



WARNING: It is possible for moisture to enter the cable due to damage to the outer protective layer. This moisture can track down the inside of the cable, filling up the drip loop and eventually finding its way into the PIDU Plus. To protect against this the outer protective layer of the cable can be opened up at the bottom of the drip loop to allow this moisture to escape.



WARNING: Some network operators employ gel filled cables to get around the problem of moisture ingress and transmission. The PTP 600 Series Bridge has NOT been tested against these cables. Use of gel filled cables may affect the performance of 600 Series bridge.

7.7.10 Powering Up

The PTP 600 Series Bridge is supplied as a pair of matched Master/Slave units. The Master unit can now be powered up and accessed using the default URL <http://169.254.1.2/> ; the Slave unit can be accessed using <http://169.254.1.1/>.

Prior to powering up the PTP 600 Series Bridge, a computer with web browsing capabilities should be configured with an IP address of 169.254.n.n and subnet mask of 255.255.0.0 where n is any value between 1 and 254 but excluding 1.1 or 1.2. If the default addresses of the unit 169.254.1.1/2 clashes with an address you are already using on your LAN, or you are not sure, you should set up an isolated LAN. As the LAN connection presented at the PIDU Plus has a default configuration as a hub/switch (and auto-sensing MDI/MDIX cross over is employed), connection can be made directly to the computer using a standard CAT 5 patch cable.

Before physical installation takes place the units to be installed should be set up as described in the section 8.3.4. This process will give the installer the opportunity to set the unit's IP address to one that is in the desired address range and set each unit up with the MAC address of its peer unit ready to establish a radio link. It is recommended that this procedure be carried out on the bench before physical installation commences. Providing it is safe to do so, the installer should take the process to the point where a radio link is established before proceeding to the installation site.



NOTE: It is possible that some units may not be accessed using the above default URL. This is because these units may have been previously configured with IP addresses 10.10.10.11 (Master) and 10.10.10.10 (Slave). Therefore, users must use the URL <http://10.10.10.10/> and/or URL <http://10.10.10.11/> to configure the units. Please ensure that a computer with web browsing capabilities is configured with an IP address of 10.10.10.n, where n is any value between 2 and 254 but excluding 10 and 11, to configure these units.

7.7.11 Aligning the PTP 600 Series Bridge ODUs

The following is a description of the steps taken to establish a radio link between the two units forming the bridge and align the units for the best signal strength.

The PTP 600 Series Bridge uses audible tones during installation to assist the installer with alignment. The installer should adjust the alignment of the ODU in both azimuth and elevation until highest pitch tone is achieved¹². The tones and their meanings are as follows:

State Name	Tone Description	State Description	Pitch Indication (Higher pitch = higher power)
Free Channel Search	Regular beep	Executing band scan	N/A
Scanning	Slow broken tone	Not demodulating the wanted signal	Rx Power
Synchronized	Fast broken tone	Demodulating the wanted signal	Rx Power
Registered	Solid tone	Both Master and Slave units exchanging Radio layer MAC management messages	Rx Power

Table 9 - Audio indications from the ODU

The term ‘wanted signal’ refers to that of the peer unit being installed.

In each of the states detailed above, the unit should be aligned to give the highest pitch tone. It should be noted that if, when in the Synchronized or Registered state, the tone varies wildly, you may be suffering from interference or a fast fading link. Installing in this situation may not give a reliable link. The cause of the problem should be investigated.

For the ease of alignment, both Master and Slave units use the install tones in the same way but with some small behavioral differences. This allows the installer to install the Slave unit first and carry out the initial alignment with the Master unit if desired. However, due to the behavioral differences of Master and Slave units, it is recommended that the Master unit is installed first and the initial alignment carried out at the Slave unit.

¹² The pitch of the alignment tone is proportional to the received power of the wireless signals. The best results are usually achieved by making small incremental movement in angular alignment.

The following behavior should be noted:

- When first started up and from time to time, the Master unit will carry out a band scan to determine which channels are not in use. During this time, between 10 and 15 seconds, the Master unit will not transmit and as a consequence of this neither will the Slave unit. During this time the installation tone on the master unit will drop back to the band scan state, and the Slave unit will drop back to the Scanning state with the pitch of the tone set to the background noise level. Alignment of the unit should cease during this time.
- The master unit can take up to 60 seconds in 0-40km (0-25 miles) mode, 90 seconds in 0-130km (0-81 miles) mode and 120 seconds in 0-200km (0-124 miles) mode to determine the range of the link being installed¹³. The Master unit will remain in the Scanning state until the range of the link has been established. The Master unit will only move to the Synchronized state when the range of the link has been established.
- If, at the end of the ranging period, the Registered state is not achieved due to interference or other reasons, the Master unit will retry twice more on the same channel before moving to another available channel. Should this occur it might take a number of minutes to establish a link in the Registered state.
- The Slave unit does not have a ranging process. The slave unit will change to the Synchronized state as soon as the wanted signal is demodulated.

When the alignment process is complete the installer **MUST REMEMBER TO DISARM BOTH UNITS** in the link as described in section 8.3.4. This is necessary in order to:

- Turn off the audible alignment aid
- Enable Adaptive Modulation
- Fully enable Advanced Spectrum Management with i-DFS
- Clear unwanted installation information from the various systems statistics
- Store the link range for fast link acquisition on link drop
- Enable higher data rates

¹³ If the unit is operating where mandatory radar avoidance algorithms are implemented the ranging behaviour for the PTP 600 Series Bridge may be affected. The Master has to monitor the initially chosen channel for 60 seconds to make sure it is clear of radar signals before transmitting. If a radar is detected during any of the installation phases a further compulsory 60 seconds channel scan will take place as the master unit attempts to locate a new channel that is free of radar interference

8 Web Page Reference

The web user interface has three main sections. The home page presents to the operator a high level summary of the PTP 600 Series Bridge point-to-point wireless link. The status page presents a more detailed set of system parameters describing the performance of the wireless link together with other key system performance metrics. The final section is the system administration section. This section is password protected and allows the system administrator to perform all the day-to-day administrative procedures, e.g. software upgrade and performing configuration changes.

The following subsections give a detailed usage guide for all the web user interfaces. The web pages are best viewed using a screen resolution of at least 1024 x 768 pixels on a PC using Microsoft Internet Explorer Version 6¹⁴.

¹⁴ The web pages have also been tested with Firefox 1.0.6. Other browsers may function correctly but have not been tested.

The navigation bar on the left hand side of the web page is used to move between the various management pages. The currently selected page is always highlighted with a dark blue background. The menu is hierarchical. Selecting a menu item which has associated submenu options will automatically display all sub options. A sample web page with the navigation menu is shown in Figure 25 when the 'Home' Link is highlighted as the current page.

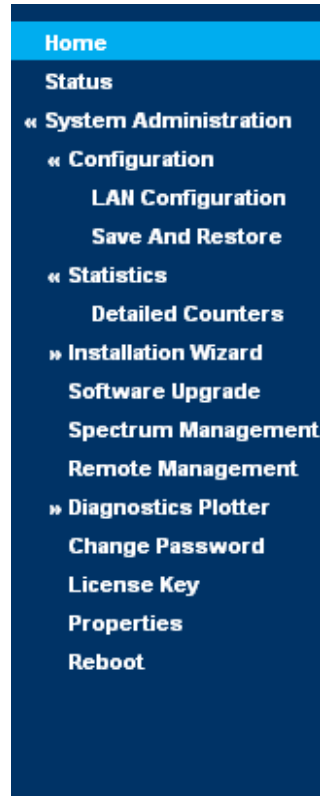

Figure 25 - Menu Navigation Bar

8.1 Home Page – PTP 600 Series Bridge

The home page for the PTP 600 Series Bridge has been designed to display a high level summary of the status of the wireless link and associated equipment. The home page (Figure 26) normally displays four key system attributes:

Wireless Link Status: The Wireless Link Status attribute displays the current status of the PTP 600 Series Bridge wireless link. A state of 'Up' on a green background indicates that a point-to-point link is established. A state of 'Down' on a red background indicates that the wireless link is not established. If the link is down for an unknown reason the system administrator should first consult the status web page for a more detailed summary of up to date system diagnostics.

Link Name: The link name attribute is a name and/or handle allocated by the system administrator to aid the identification of the unit, network or building.

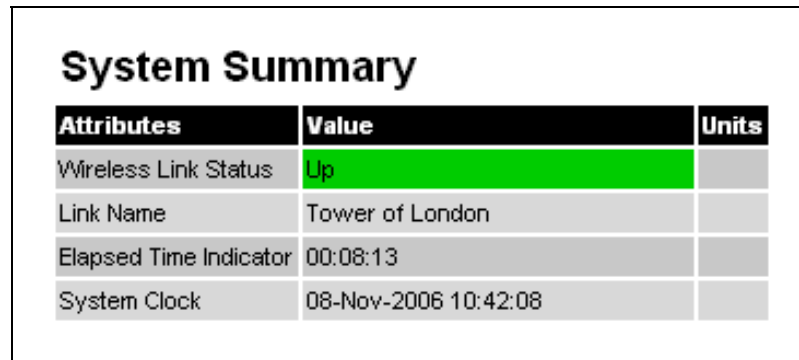

Attributes	Value	Units
Wireless Link Status	Up	
Link Name	Tower of London	
Elapsed Time Indicator	00:08:13	
System Clock	08-Nov-2006 10:42:08	

Figure 26 - System Summary Page

Elapsed Time Indicator: The elapsed time indicator attribute presents the total time in days, hours, minutes and seconds since the last system restart. The system can restart for several reasons, e.g., commanded reboot from the system reboot webpage, or a power cycle of the equipment.

System Clock: If SNTP (Simple Network Time Protocol) is enabled, or the clock has been set, then a system clock attribute is displayed giving the date and time of the last page refresh. Section 8.3.10.5 explains how to enable SNTP and section 8.3.10.6 explains how to set the clock.

8.1.1 Home Page Alarm Display

The home page is also used to display all outstanding major system alarms. Whenever system alarms are asserted, a yellow warning triangle is displayed on web page navigation bar. The warning triangle will be visible from all web pages. Clicking the warning triangle will cause the web page to jump back to the system homepage. Figure 27 shows a sample alarm screen.

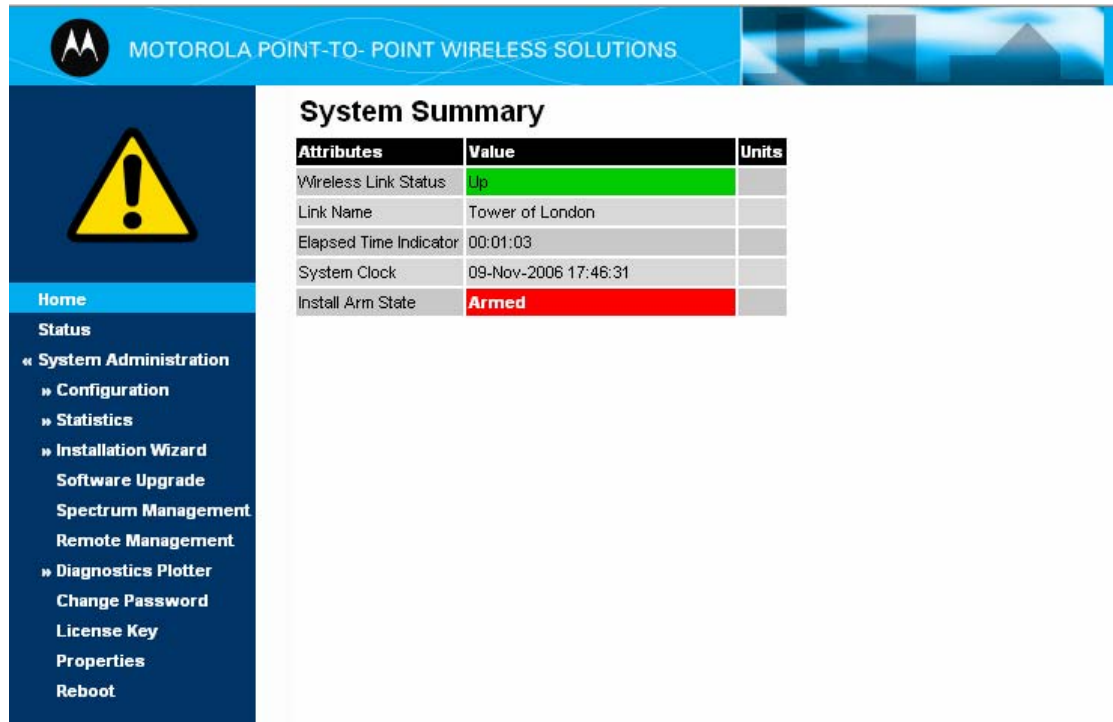

System Summary

Attributes	Value	Units
Wireless Link Status	Up	
Link Name	Tower of London	
Elapsed Time Indicator	00:01:03	
System Clock	09-Nov-2006 17:46:31	
Install Arm State	Armed	

Figure 27 - Alarm Warning Triangle

The following major system alarms are defined:

Install Arm State: The Install Arm State alarm is displayed. This alarm warns when a wireless unit is in installation mode. After installation the wireless unit should be disarmed. This will increase the wireless link's data-carrying capacity and stop the installation tone generator. The wireless link is disarmed from the 'Installation Wizard' see section 8.3.4.



Install Status: If any errors are detected during the installation process, the unit will automatically raise an audible alarm. The install status alarm will be raised with an appropriate reason code, e.g. the alarm will be raised if an incorrect target MAC address is specified for the peer 600 Series bridge.

Ethernet Link Status: If there are any problems with the Ethernet interface, this alarm will be asserted. This alarm will most likely be seen if the unit has no Ethernet cable plugged into its Ethernet socket.

Master And Slave Have Incompatible Region Codes: The 600 Series bridge uses region codes to comply with local regulatory requirements governing the transmission of wireless signals in the 5.8 and 5.4 GHz bands. Region codes can only be changed by obtaining a new 600 Series license key. If this alarm is encountered the appropriate license keys from the country of operation should be obtained from your distributor. Applying license keys containing the same region codes to both ends of the link will remove the alarm.

Spectrum Management Channel Warning: This alarm warns the user when the intelligent spectrum management feature can't find a suitable wireless channel.

Hardware Authentication Alarm: If the Hardware Authentication Alarm is displayed on the front page please contact Motorola Customer support for further assistance.

Ethernet Link Disable Warning: This warning is displayed if the Ethernet link has been administratively disabled via the SNMP Interface. The Ethernet Interface MIB-II ifAdminStatus attribute has been set to DOWN. To enable the Ethernet interface, set the ifAdminStatus attribute to UP.

Wireless Link Disabled Warning: This warning is displayed if the Wireless link has been administratively disabled via the SNMP Interface. The Wireless Interface MIB-II ifAdminStatus attribute has been set to DOWN. To enable the Ethernet interface, set the ifAdminStatus attribute to UP.

Fiber Link Disabled Warning: This warning is displayed if an SFP is installed but has been disabled because your license key does not include fiber support.

Ethernet Configuration Mismatch Alarm: This warning is an indication that Ethernet fragments are being detected on the Ethernet port. This is an indication of an auto negotiation or forced Ethernet configuration mismatch.

SNTP No Sync Warning: This warning indicates that SNTP has been enabled but that the unit is unable to synchronize with the specified SNTP server. Section 6.3.9.5 explains how to configure SNTP.

Telecoms Channel A Status: Indicates that there is a problem with the telecoms channel A. Possible problems are "No Signal (local)", "No Signal (Remote)", and "No Signal (Local and Remote)".

Telecoms Channel B Status: Indicates that there is a problem with the telecoms channel B. Possible problems are "No Signal (local)", "No Signal (Remote)", and "No Signal (Local and Remote)".

Telecoms Interface A Loopback: The telecoms loopback features are intended for installation testing only and should be set to 'None' for normal operation. The loopback can be disabled from the telecoms configuration sub menu (see section 8.3.1.6).

Telecoms Interface B Loopback: The telecoms loopback features are intended for installation testing only and should be set to 'None' for normal operation. The loopback can be disabled from the telecoms configuration sub menu (see section 8.3.1.6).

Incompatible Master and Slave: This warning is displayed when the master and slave ends of the wireless link have incompatible configurations. The two possible scenarios for seeing this warning are:

1. "Incompatible Master and Slave product variants". The product variant is controlled by the unit's license key. Check that the correct set of compatible license keys have been inserted into the units.
2. "Master and Slave are running different software versions". Check the software versions on each end of the wireless link and upgrade one or both of the software versions to remedy the incompatibility.

8.2 Systems Status Page

The status page has been designed to give the system administrator a detailed view of the operation of the 600 Series Bridge from both the wireless and network perspectives.

The page is subdivided into three main categories Equipment, Wireless, Telecoms and Ethernet/Internet. The 'Equipment' section contains the unit's inventory and identification information. The 'Wireless' section presents the key wireless metrics, which are displayed as a series of measurements and histograms. The 'Ethernet/Internet' section describes the unit's network identity and connectivity. "Telecoms" controls the unit's E1/T1 telecoms interfaces.

The status page can be configured to refresh itself at an operator defined rate (if the user is logged in as system administrator). The refresh period defaults to 3600 seconds and can easily be changed to refresh at any period between 3 seconds and 3600 seconds. Pressing the 'Update Page Refresh Period' button causes a new page refresh period to be adopted by the system. The page refresh mechanism uses a HTML Meta refresh command. Therefore the refresh is always initiated by the local browser and not by the 600 Series Bridge at this interval.

The two 600 Series bridges units are arranged in a master and slave relationship. The roles of the units in this relationship are displayed in the page title. The master unit will always have the title '- Master', and the slave will always have '- Slave' appended to the 'Systems Status' page title.

System Status - Master

Equipment			Wireless		
Attributes	Value	Units	Attributes	Value	Units
Link Name	Tower of London		Wireless Link Status	Up	
Link Location	London, England		Maximum Transmit Power	25	dBm
Software Version	58600-04-99		Remote Maximum Transmit Power	25	dBm
Hardware Version	D04-R02-C		Transmit Power	25.0, 19.6, 18.0, 18.0	dBm
Region Code	1		Receive Power	-34.3, -52.1, -110.0, -42.6	dBm
Elapsed Time Indicator	00:01:41		Vector Error	7.2, -16.7, -30.3, -29.0	dB
Ethernet / Internet			Link Loss	111.3, 69.8, 0.0, 107.6	dB
Ethernet Link Status	Copper Link Up		Transmit Data Rate	141.13, 80.53, 0.00, 141.13	Mbps
Ethernet Speed And Duplex	1000 Mbps Full Duplex		Receive Data Rate	141.13, 81.14, 0.00, 141.13	Mbps
MAC Address	00:04:56:80:0f:ff		Link Capacity	300.16	Mbps
Telecoms			Transmit Modulation Mode	256QAM 0.81 (Dual)	
Channel A	Disabled		Receive Modulation Mode	256QAM 0.81 (Dual)	
Channel B	Disabled		Receive Modulation Mode Detail	Running At Maximum Receive Mode	
Automatic page refresh period in seconds	<input type="text" value="3600"/>	Seconds	Range	0.1	km
			<input type="button" value="Update Page Refresh Period"/> <input type="button" value="Reset form"/>		

Figure 28 - Status Page

The following section details all the attributes displayed on the status page:

Link Name: The link name is allocated by the system administrator and is used to identify the equipment on the network. The link name attribute is limited to a maximum size of 63 ASCII characters.

Link Location: The link location is allocated by the system administrator and can be used as a generic scratch pad to describe the location of the equipment or any other equipment related notes. The link location attribute is limited to a maximum size of 63 ASCII characters.

Software Version: The attribute describes the version of software installed on the equipment. The format of the attributes is *FFSSS-XX-YY* where *FF* is the frequency variant (5.4 or 5.8GHz), *SSS* is the System Release, *XX* is the major release version and *YY* is the minor release version.

Hardware Version: The hardware version attribute contains all the combined hardware version information. The attribute is formatted as *DXX-RYY-Z* where *DXX* contain the version of the digital card, *RYY* contains the version of the RF (radio frequency) card and *Z* describes the antenna type which can be *I* (integrated) or *C* (connectorized).

Region Code: The region code is used by the system to constrain the wireless to operate within regulatory regime of the particular country. The region code is encoded in the product license key. If the operator wishes to change region code, a new license key must be obtained from Motorola or the local point-to-point distributor / system integrator.

Elapsed Time Indicator: The elapsed time indicator attribute presents the total time in years, days, hours, minutes and seconds since the last system restart. The system can restart for several reasons, e.g. commanded reboot from the system reboot web page, or a power cycle of the equipment.

Ethernet Link Status: Current status of the Ethernet link. A state of 'Up' with a green background indicates that an Ethernet link is established. A state of 'Down' with a red background indicates that the Ethernet link is not established.

Ethernet Speed and Duplex: The negotiated speed and duplex setting of the Ethernet interface. The speed setting is specified in Mbps. Full Duplex data transmission means that data can be transmitted in both directions on a signal carrier at the same time. For example, on a local area network with a technology that has full duplex transmission, one workstation can be sending data on the line while another workstation is receiving data. Half Duplex data transmission means that data can be transmitted in both directions on a signal carrier, but not at the same time. For example, on a local area network using a technology that has half duplex transmission, one workstation can send data on the line and then immediately receive data on the line from the same direction in which data was just transmitted.

Channel A: The status of telecoms interface A.

Channel B: The status of telecoms interface B.

Wireless Link Status: As the attribute name suggests it displays the current status of the wireless link. A state of 'Up' on a green background indicates that a point-to-point link is established. A state of 'Down' on a red background indicates that the wireless link is not established.

Maximum Transmit Power: The maximum transmit power that the local wireless unit is permitted to use to sustain a link.

Remote Maximum Transmit Power: The maximum transmit power that the remote wireless unit is permitted to use to sustain a link.

Transmit Power: Transmit power histogram¹⁵ is expressed in dBm and presented as: max, mean, min, and latest. The max, min and latest are true instantaneous measurements, the mean is the mean of a set of one second means.

Receive Power: Receive power histogram is expressed in dBm and presented as: max, mean, min, and latest. The max, min and latest are true instantaneous measurements, the mean is the mean of a set of one second means. See note 15.

¹⁵ All histograms are calculated over a one hour period. If the equipment has been running for less than one hour then the histograms are calculated over the current elapsed time.

The data used to compute the histogram statistics can be downloaded in an ASCII comma separated value (CSV) format via the diagnostics CSV Download page, see section 8.3.11.2.

Vector Error: The vector error measurement compares the received signal's In phase / Quadrature (IQ) modulation characteristics to an ideal signal to determine the composite error vector magnitude. The results are stored in a histogram and expressed in dB and presented as: max, mean, min and latest. The max, min and latest are true instantaneous measurements, the mean is the mean of a set of one second means. The expected range for Vector Error would be approximately -2dB (NLOS link operating at sensitivity limit on BPSK 0.67) to -33dB (short LOS link running 256 QAM 0.83). See note 15.

Link Loss: The link loss is the total attenuation of the wireless signal between the two point-to-point units. See note 15.

The link loss calculation presented below:

$$P_{ll} = P_{T_x} - P_{R_x} + g_{T_x} + g_{R_x}$$

Where

P_{ll}	Link Loss (dB)
P_{T_x}	Transmit power of the remote wireless unit (dBm)
P_{R_x}	Received signal power at the local unit (dBm)
g_{T_x}, g_{R_x}	Antenna gain at the remote and local units respectively (dBi). The antenna gain of the 600 Series bridge (23.5 dBi) is used unless one or both of the Gemini units is a Connectorized version. See Section 11.3 for more details

Equation 2 - Link Loss

Transmit Data Rate: The data rate in the transmit direction, expressed in Mbps and presented as: max, mean, min, and latest histogram format. The max, min and latest are true instantaneous measurements, the mean is the mean of a set of one second means.

See note 15. Expected data rates can be found in section 4.1.4 “Aggregate Ethernet throughput rate v maximum link loss”.

Receive Data Rate: The data rate in the receive direction, expressed in Mbps and presented as: max, mean, min, and latest histogram format. The max, min and latest are true instantaneous measurements, the mean is the mean of a set of one second means.

See note 15. Expected data rates can be found in section 6.1.4.

Link Capacity: The maximum aggregate data rate capacity available for user traffic, assuming the units have been connected using Gigabit Ethernet. The link capacity is variable and depends of the prevailing wireless conditions as well as the distance (range) between the two wireless units. When the link is idle and in ‘IP Mode’ the wireless link will adaptively configure itself into a lower latency mode, this will cause the displayed link capacity and aggregate data rates to diverge. This is because the aggregate data rate displays the instantaneous capacity of the wireless link not the maximum potential capacity of the link as displayed by link capacity.

Transmit Modulation Mode: The modulation mode currently being used on the transmit channel. Details on the modulation modes can be found in section 21.1 “System Specifications”.

Receive Modulation Mode: The modulation mode currently being used on the receive channel. Details on the modulation modes can be found in section 21.1 “System Specifications”.

Receive Modulation Mode Detail: This supplies the user with information regarding the receive modulation mode in use. Possible values are:

- Running at maximum receive mode
- Running at user-configured Max Modulation Mode
- Restricted due to byte errors on the wireless link or local Ethernet Tx Fifo Drops
- Restricted because a DFS channel change is in progress
- Restricted due to telecoms acquisition mode
- Restricted due to the low Ethernet link speed
- Limited by the wireless conditions

Range: The range¹⁶ between the 600 Series bridge ODUs.

Refresh Page Period: The Status page refreshes automatically according to the setting entered here (in seconds). This attribute is only displayed when the user is logged on as System Administrator.

8.3 System Administration Pages

The following menu options are available for the system administrator and can be password protected. Figure 29 shows the system administration login page. By default a system administrator password is not set. Simply click the login button to access the system administration features.

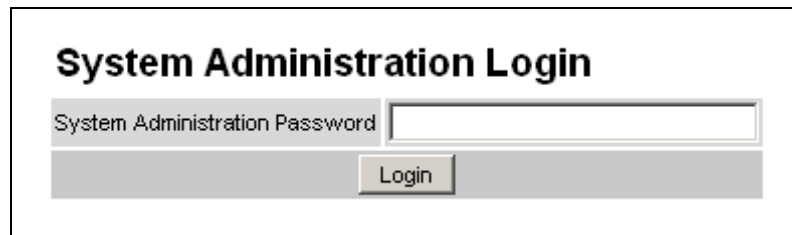

The image shows a screenshot of the 'System Administration Login' page. It features a title 'System Administration Login' at the top. Below the title is a text input field labeled 'System Administration Password'. At the bottom of the form is a 'Login' button.

Figure 29 - System Administration Login Page

Once the password has been set using the 'Change Password' menu item the system administration pages will only be available after the user has entered the correct password.

¹⁶ The PTP 600 Series Bridge displays range in km by default, if the user would prefer to display range using Miles the 'Distance Units' attribute should be set to imperial, see the "Properties" web page section 8.3.14.



The features that are only available to the system administrator are:

- Configuration
- Statistics
- The Installation Wizard
- Software Upgrade
- Spectrum Management including DFS
- Remote management
- Diagnostics Plotter
- Password Management
- License Key Management
- Properties
- System Reboot

8.3.1 System Configuration

The configuration of the 600 Series Bridge is organized into three sections:

- General configuration
- LAN configuration
- Telecoms Configuration
- Save and Restore

The general configuration allows modification of high level administrative (descriptive) attributes and high level wireless configuration.

The LAN configuration sub menu allows the system administrator to modify the Ethernet and IP configuration of the 600 Series Bridge.

The telecoms submenu displays the current status of the telecoms interface and allows the configuration of interface loopbacks.

The save and restore submenu allows the system administrator to backup and restore the bridge configuration. It is recommended after a unit has been successfully installed, a copy of the active configuration is taken and archived by the system administrator.

8.3.1.1 General Configuration Page

The general configuration page (Figure 30) is used by the system administrator to configure the 600 Series Bridge's high level administrative (descriptive) attributes and high level wireless configuration.

System Configuration

This page controls the day to day configuration of the PTP wireless unit.

Equipment

Attributes	Value	Units
Link Name	<input type="text" value="Tower of London"/>	
Link Location	<input type="text" value="London, England"/>	
Master Slave Mode	Master	
Link Mode Optimization	IP Traffic	
Max Receive Modulation Mode	<input type="text" value="256QAM 0.81"/>	
Ethernet Capped Max Wireless Speed	<input type="radio"/> Disabled <input checked="" type="radio"/> Enabled	
Max Transmit Power	<input type="text" value="25"/>	dBm

Figure 30 - System Configuration Page

While the majority of the system configuration is entered during installation and should never require changing, this page offers the system administrator the ability to change the basic system parameters for both the wireless and Ethernet components.

Link Name: User defined identity for the unit (max 63 characters).

Link Location: Can be used as a generic scratch pad to describe the location of the equipment.

Max Receive Modulation Mode: This is the maximum mode the unit will use as its adaptive modulation. The modulation modes available are specified in section 21.1 "System Specifications".

By default the Max Receive Modulation Mode is the highest mode available.

For minimum error rates on TDM links the user should set the maximum modulation mode to 64QAM 0.75 at both ends of the link.

Ethernet Capped Max Wireless Speed: When enabled this option will cap the wireless speed to a mode that the connected Ethernet connection can sustain.

Maximum Transmit Power: This specifies the maximum transmit power in dBm of the system. It is country dependent and although the user can change this in 1dB steps, it will be limited to that country's regulations¹⁷.

Why Reduce Transmit Power?

If the link losses are low and the link data rate and availability targets are being easily achieved, the transmitted power level may be reduced with a consequent benefit to other users of the band, .e.g. fixed satellite links.

¹⁷ In the UK there is a legal requirement to provide a minimum of 19dB of transmit power control range. When the equipment is operating with a UK Licence Key, an additional facility is provided on the configuration page that allows the transmitted power to be reduced by 19dB compared to the maximum allowed with a simple single step control.

8.3.1.2 LAN Configuration Page

The LAN configuration page (Figure 31) is used by the system administrator to configure the 600 Series bridge's LAN interface.

LAN Configuration

This page controls the LAN configuration of the PTP wireless unit.

Attributes	Value	Units
IP Address	169 . 254 . 1 . 1	
Subnet Mask	255 . 255 . 0 . 0	
Gateway IP Address	169 . 254 . 0 . 0	
VLAN High Priority Traffic Threshold	VLAN User Priority 1 and Above ▼	
Use VLAN For Management Interfaces	<input type="radio"/> Disabled <input type="radio"/> Enabled	
Ethernet Auto Negotiation	<input type="radio"/> Disabled <input checked="" type="radio"/> Enabled	
Auto Neg Advertisement	<input checked="" type="checkbox"/> 1000 Mbps Full Duplex	
	<input checked="" type="checkbox"/> 100 Mbps Full Duplex	
	<input checked="" type="checkbox"/> 100 Mbps Half Duplex	
	<input checked="" type="checkbox"/> 10 Mbps Full Duplex	
	<input checked="" type="checkbox"/> 10 Mbps Half Duplex	
Ethernet Auto Mdx	<input type="radio"/> Disabled <input checked="" type="radio"/> Enabled	
Drop Ethernet Link On Wireless Link Down	<input checked="" type="radio"/> Disabled <input type="radio"/> Enabled	
Local Packet Filtering	<input checked="" type="radio"/> Disabled <input type="radio"/> Enabled	

Figure 31 - LAN Configuration Page

IP Address: Internet protocol (IP) address. This address is used by the family of Internet protocols to uniquely identify this unit on a network.

Subnet Mask: A subnet allows the flow of network traffic between hosts to be segregated based on a network configuration.

Gateway IP Address: The IP address of a computer / router on the current network that acts as a gateway.

VLAN High Priority Traffic Threshold: All packets with an 802.1P priority tag greater than or equal to the indicated value will be treated as a high priority packet for transmission over the wireless link.

Use VLAN For Management Interfaces: This controls whether the management interfaces (WWW/SNMP/SMTP/SNTP) use 802.1Q VLAN tags or not. See section 8.3.1.3.

Ethernet Auto Negotiation This enables the Ethernet configuration to be forced rather than auto negotiated.



Warning: *The configuration should only be forced if you are having problems with auto negotiation. You must ensure that you configure both this unit and the Ethernet port to which it is connected identically. If you force a fixed Ethernet Configuration on the 600 Series bridge then you MUST also force the same fixed configuration on the equipment to which it is connected. If you fail to force the configuration of the connected equipment, its automatic configuration mechanisms will normally cause a duplex mismatch, and you will receive greatly reduced throughput!*

When Ethernet Auto Negotiation is Disabled the format of the LAN configuration page will change see Section 8.3.1.4 “LAN Configuration Page – Manual Ethernet Configuration”.



Auto Neg Advertisement: This controls the rates that the auto negotiation mechanism will advertise as available. **Warning:** *Over the air throughput will be capped to the rate of the Ethernet interface at the receiving end of the link.*

Ethernet Auto Mdx: This enables/disables the Auto Medium Dependent Interface (MDI)/Medium Dependent Interface Crossover (MDIX) capability.

Drop Ethernet Link On Wireless Link Down: When this option is enabled the Ethernet link is momentarily dropped when the wireless link goes down. This feature is used to indicate to the connected network equipment that this Ethernet link is no longer available, thus causing STP (Spanning Tree Protocol) to re-route packets through an alternate link.

Local Packet Filtering: When Local Packet Filtering is Enabled, the bridge learns the source MAC addresses of devices transmitting Ethernet packets on the local Ethernet network, and only bridges packets to the remote unit if the destination MAC address has not been learned as a 'local' device. When Local Packet Filtering is 'Disabled' the bridge does not learn the source MAC addresses of devices transmitting Ethernet packets on the local Ethernet network, and bridges ALL Ethernet packets received to the remote unit. Local Packet Filtering should be disabled when external Ethernet switching hardware or a router is present. The default setting for Local Packet Filtering is disabled.

All of the above attributes are non-volatile, once set they will be used by the unit even after a power on reboot. A number of attributes, such as IP Address, Subnet Mask and Gateway IP Address and VLAN settings will require a reboot before they are used. If any of these attributes are changed a reboot screen appears asking the user to verify the reboot (Figure 32 or Figure 33).



Figure 32 - Configuration Reboot Page

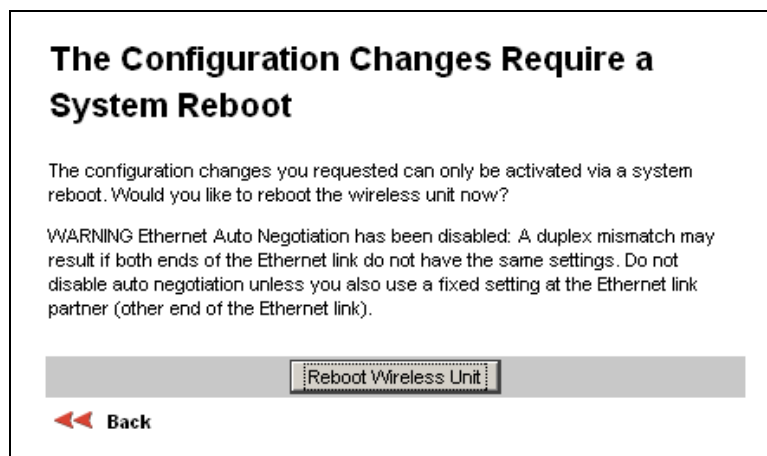

Figure 33 - Configuration Reboot Page - Ethernet Auto Negotiation Disabled

This will be followed by a pop-up dialogue box asking to confirm the action.

Note: At this point you will lose connection to the unit. If you have just changed the IP Address you now have to reconnect to the unit using the address just set.

8.3.1.3 LAN Configuration Page – Use VLAN For Management Interfaces

The layout of the LAN Configuration page changes if this attribute is enabled in order to allow the VLAN VID and VLAN Priority to be set, see Figure 34. The VLAN settings are applied only after the unit is rebooted.



Warning: You must ensure that you can access the VLAN which you configure here, otherwise you will be unable to access the unit following the next reboot.

LAN Configuration

This page controls the LAN configuration of the PTP wireless unit.

WARNING configuration changed

The configuration on this page will only take effect after you have rebooted the unit.

Attributes	Value	Units
IP Address	169 . 254 . 1 . 1	
Subnet Mask	255 . 255 . 0 . 0	
Gateway IP Address	169 . 254 . 0 . 0	
VLAN High Priority Traffic Threshold	VLAN User Priority 1 and Above ▾	
Use VLAN For Management Interfaces	<input type="radio"/> Disabled <input checked="" type="radio"/> Enabled	
VLAN Management VID	1	
VLAN Management Priority	0	
VLAN Management VID Validation	<input checked="" type="radio"/> Disabled <input type="radio"/> Enabled	
Ethernet Auto Negotiation	<input type="radio"/> Disabled <input checked="" type="radio"/> Enabled	
Auto Neg Advertisement	<input checked="" type="checkbox"/> 1000 Mbps Full Duplex	
	<input checked="" type="checkbox"/> 100 Mbps Full Duplex	
	<input checked="" type="checkbox"/> 100 Mbps Half Duplex	
	<input checked="" type="checkbox"/> 10 Mbps Full Duplex	
	<input checked="" type="checkbox"/> 10 Mbps Half Duplex	
Ethernet Auto Mdx	<input type="radio"/> Disabled <input checked="" type="radio"/> Enabled	
Drop Ethernet Link On Wireless Link Down	<input checked="" type="radio"/> Disabled <input type="radio"/> Enabled	
Local Packet Filtering	<input checked="" type="radio"/> Disabled <input type="radio"/> Enabled	
<input type="button" value="Submit Updated System Configuration"/> <input type="button" value="Reset Form"/>		

Figure 34 - VLAN Configuration Fields

VLAN Management VID: This 802.1Q VLAN VID will be included in packets generated by the management interfaces. Valid settings are in the range 0 to 4094.

VLAN Management Priority: This 802.1Q VLAN Priority will be included in packets generated by the management interfaces. Valid settings are in the range 0 to 7.

VLAN Management VID Validation: If enabled, the management interfaces will only respond to Ethernet packets tagged with the configured 802.1Q VLAN Management VID, otherwise packets with any VID will be accepted.

8.3.1.4 LAN Configuration Page – Manual Ethernet Configuration

LAN Configuration

This page controls the LAN configuration of the PTP wireless unit.

WARNING configuration changed

The configuration on this page will only take effect after you have rebooted the unit.

Attributes	Value	Units
IP Address	169 . 254 . 1 . 1	
Subnet Mask	255 . 255 . 0 . 0	
Gateway IP Address	169 . 254 . 0 . 0	
VLAN High Priority Traffic Threshold	VLAN User Priority 1 and Above ▼	
Use VLAN For Management Interfaces	<input checked="" type="radio"/> Disabled <input type="radio"/> Enabled	
Ethernet Auto Negotiation	<input checked="" type="radio"/> Disabled <input type="radio"/> Enabled	
Forced Configuration	100 Mbps Copper Full Duplex ▼	
Ethernet Auto Mdx	<input type="radio"/> Disabled <input checked="" type="radio"/> Enabled	
Drop Ethernet Link On Wireless Link Down	<input checked="" type="radio"/> Disabled <input type="radio"/> Enabled	
Local Packet Filtering	<input checked="" type="radio"/> Disabled <input type="radio"/> Enabled	

Figure 35 - LAN Configuration Page - Manual Ethernet Configuration

Force Configuration: This option allows the user to force the speed and duplex setting of the Ethernet interface.



Warning: *Over the air throughput will be capped to the rate of the Ethernet interface at the receiving end of the link*

8.3.1.5 Save and Restore Configuration File

The save and restore feature of a PTP 600 Series Bridge allows the system administrator to backup the operation configuration of the wireless unit. It is recommended that this facility is used immediately after a successful PTP 600 Series Bridge installation or prior to any software upgrade. In the unlikely event that a unit has to be replaced in the field, the replacement unit can be reconfigured by simply playing back the saved configuration file.

To save the configuration file click on the 'Save Configuration File' button (Figure 36) and save the configuration file (.cfg) to the hard drive of your computer¹⁸, ¹⁹.

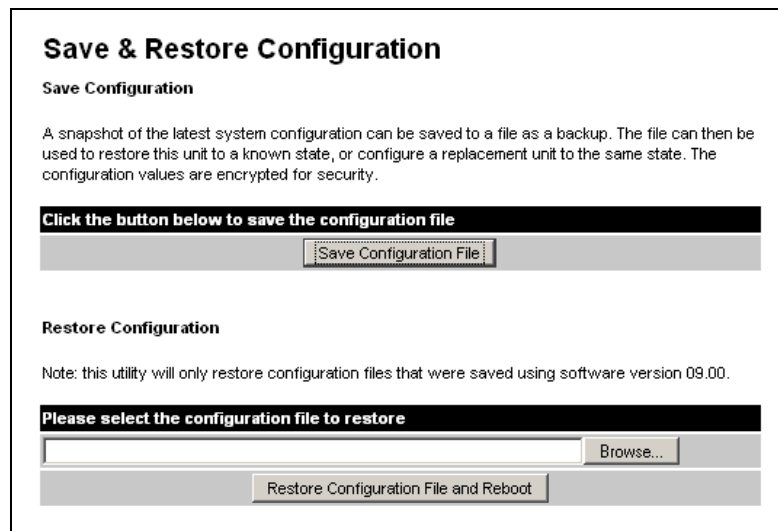

Save & Restore Configuration

Save Configuration

A snapshot of the latest system configuration can be saved to a file as a backup. The file can then be used to restore this unit to a known state, or configure a replacement unit to the same state. The configuration values are encrypted for security.

Click the button below to save the configuration file

Save Configuration File

Restore Configuration

Note: this utility will only restore configuration files that were saved using software version 09.00.

Please select the configuration file to restore

Browse...

Restore Configuration File and Reboot

Figure 36 - Save and Restore Configuration Page

¹⁸ There is a feature of Internet Explorer (all versions) that will always look at the content of any downloadable file as make an assessment whether to treat the file as an ASCII or binary file. Unfortunately the configuration file is always treated as ASCII and the browser attempts to display it instead of downloading it. Firefox (all versions) makes no such assumptions.

¹⁹ The configuration file format is MAC-mm-mm-mm_IP-iii-iii-iii-iii.cfg where mm and iii are the lower 3 bytes of the MAC address and the unit IP address respectively.

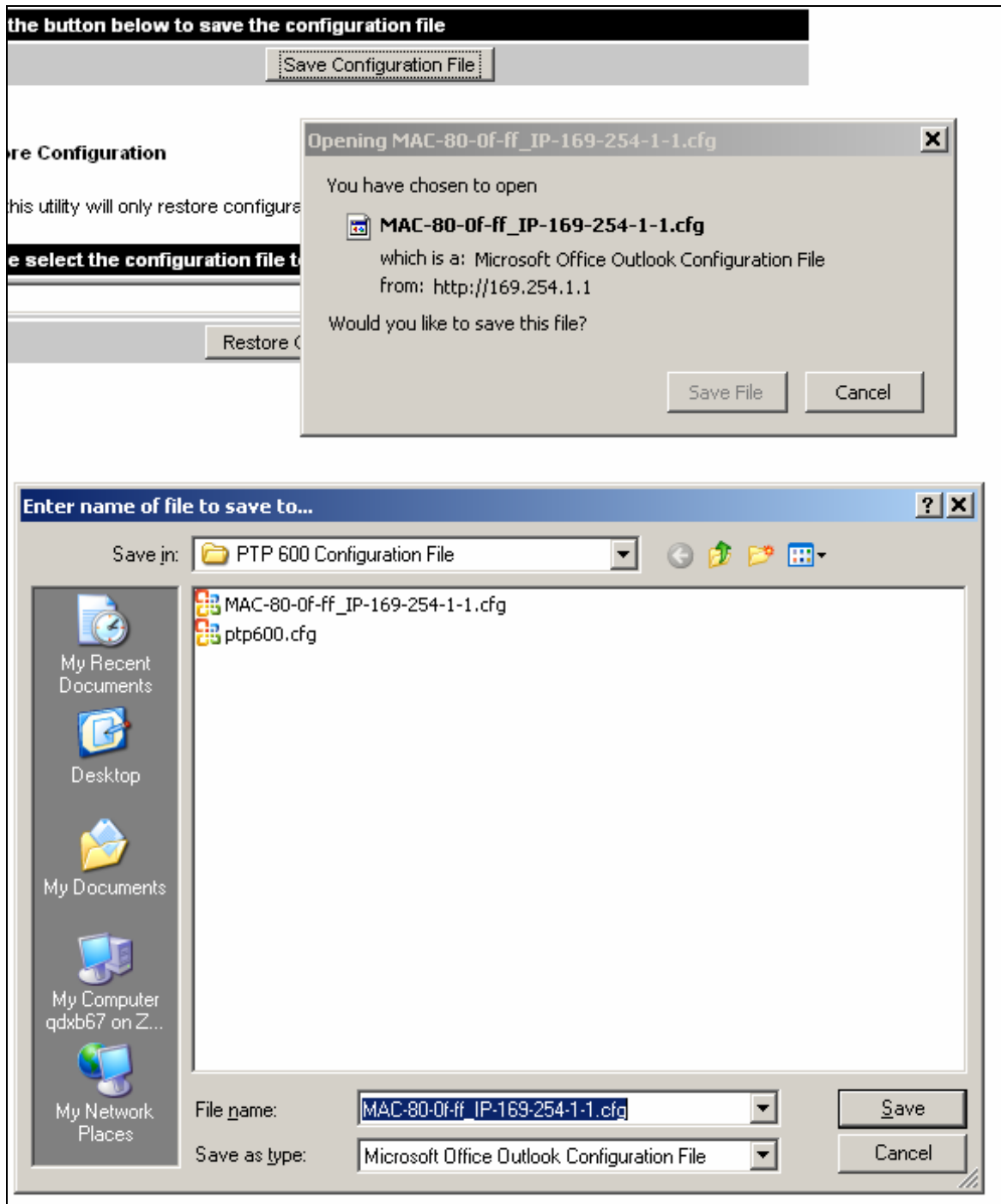

Figure 37 - Save Configuration File Screen

The configuration file is encoded using an ASCII encoding scheme. An example is show in Figure 38.

Motorola PTP 600 Series Configuration file
#
MAC Address :- 00:04:56:80:0f:ff
IP Address :- 169.254.1.1
License Key :- DCBD-A7AA-6851-4679
Software Version :- 09-01
Creation Date :- 07-Mar-07 20:03:23
#
To playback this configuration file into the unit, use the Save and Restore configuration webpage:
#
<config>+.BP9)7HC;O)DS.UNPAGUTLIHJ:"\K.]3F60*XR14+>) I3-MZ-VF
...
</config>

Figure 38 – PTP 600 Example Configuration File



WARNING: The configuration file is currently restricted to a single software version and can only be restored into a wireless unit operating the software version indicated in the configuration file header.

The configuration file can also be used when swapping out a faulty wireless unit. If one of the wireless units is replaced on a wireless link a configuration file captured from the faulty unit can be replaced into the new unit to speed up replacement. It should be noted that when placing a configuration file into a wireless unit with a different MAC Address the license key will not be restored and may need to be entered. This can be obtained either from the Quick Install guide supplied with replacement wireless unit or directly from Motorola. Note that the target MAC address at the other hand needs to change.

The restoration of configuration files can be performed using the Restore configuration tool. Using the browser button to locate the configuration file you wish to restore then click the 'Restore Configuration File and Reboot' button (Figure 39). The user will then be prompted to confirm the action (Figure 40).

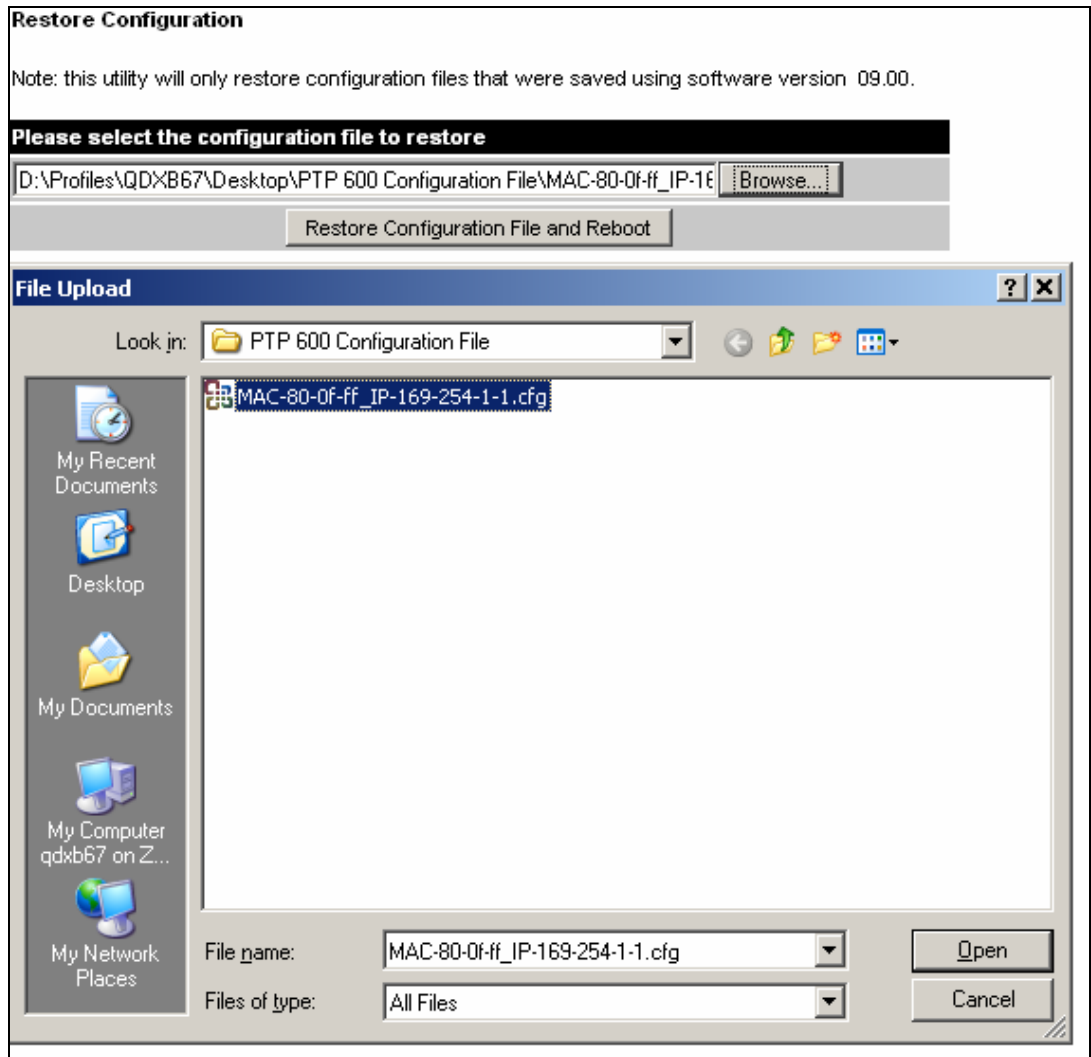

Figure 39 - Restore Configuration File Pop Up Screen

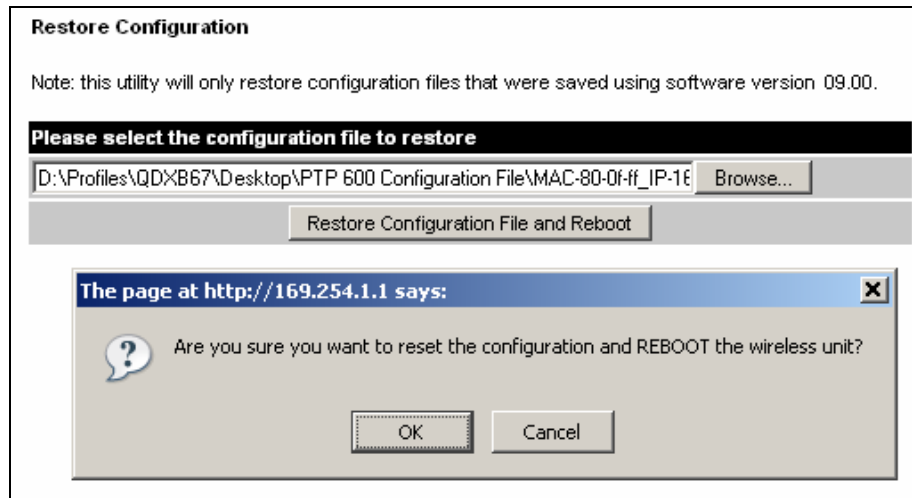

Figure 40 - Reset Configuration and Reboot Confirmation Pop-up

On confirmation the PTP 600 Series Bridge will:

- Upload the configuration file
- Perform data integrity checking
- Erase previous configuration
- Apply the new configuration
- Restart

After the unit has restarted the entire configuration from the configuration file will now be active. Note: The IP address of the unit may have also been changed. The user can check the new IP address by reading the header of the configuration file, Figure 38.



WARNING: A reboot is always required to restore a configuration file.

8.3.1.6 Telecoms Configuration Page

The Telecoms page is only available when the Telecoms Interface has been set to either T1 or E1 in the Installation Wizard.

It displays the interface setting and line code for the available telecoms channels. The PTP 600 Series Bridge is able to support two T1 or E1 channels. However, in the Lite configuration one of these channels is disabled. The channels are referred to as "Channel A" and "Channel B".

The "Channel B" configuration and controls will be displayed only when the second channel is enabled.

Telecoms

This page controls the telecoms configuration of the wireless unit.

Attributes	Value	Units
Telecoms Interface	T1	
Channel A Line Code	B8ZS/HDB3	
Channel A Cable Length	133	feet
Channel A Loopback	<input checked="" type="radio"/> None <input type="radio"/> Copper <input type="radio"/> Wireless	
Channel B Line Code	B8ZS/HDB3	
Channel B Cable Length	133	feet
Channel B Loopback	<input checked="" type="radio"/> None <input type="radio"/> Copper <input type="radio"/> Wireless	

Figure 41 - Telecoms Data Entry



Telecoms Interface: May be either T1, E1 reflecting the Installation Wizard setting.

Line Code: Displays the Line Code setting for each channel. The Line Code configuration must match the configuration of the connected equipment and may be set using the Installation Wizard.

Cable Length: The Cable Length setting is applicable in T1 mode only and shows the cable length specified in the installation wizard.

Loopback: Allows the T1 or E1 data stream to be looped back at the copper or wireless interface. During normal operation the loopback must be set to "None".

It may be helpful during installation to test the telecoms links by performing loopback connections.

A "Copper" loopback connects the received data on a given telecoms interface to the transmit. A "Copper" loopback may be used, in conjunction with an appropriate test unit, to confirm that the correct connections have been made to the ODU.

A "Wireless" loopback sends the telecoms data received across the wireless link back across the link on the same channel. The link may be checked using, for example, a Bit Error Rate Tester.

A typical T1 or E1 installation might include a "Copper" loopback on the local unit followed by a "Wireless" loopback on the remote unit.

It is important to remove all loopbacks on channels for normal operation.

Alarms on the Home Page indicate the presence of loopbacks on either channel.

8.3.2 Statistics Page

The 600 Series bridge statistics page is designed to display some key statistics of the Ethernet Bridge and the underlying wireless performance.

System Statistics					
Attributes	Value				Units
Wireless Tx Packets	1,718 (+1,718)				
Wireless Rx Packets	51 (+51)				
Ethernet Tx Packets	1,684 (+1,684)				
Ethernet Rx Packets	1,243 (+1,243)				
Packets To Internal Stack	1,174 (+1,174)				
Packets From Internal Stack	1,637 (+1,637)				
Transmit Data Rate	141.13, 128.61, 0.00, 141.13				Mbps
Receive Data Rate	141.13, 128.65, 0.00, 141.13				Mbps
Aggregate Data Rate	282.26, 257.26, 0.00, 282.26				Mbps
Link Capacity	300.16				Mbps
Transmit Modulation Mode	256QAM 0.81 (Dual)				
Receive Modulation Mode	256QAM 0.81 (Dual)				
Receive Modulation Mode Detail	Running At Maximum Receive Mode				
Signal Strength Ratio	0.8, 0.6, -1.0, 0.7				dB
Wireless Link Availability	100.0000				%
Byte Error Ratio	1.724e-9				
Elapsed Time Indicator	00:08:14				
Statistics Page Refresh Period	<input type="text" value="3600"/>				Seconds
<input type="button" value="Submit Updated Values"/> <input type="button" value="Reset Form"/>					
<input type="button" value="Reset system counters"/>					
<input type="button" value="Reset system histograms"/>					

Figure 42 - System Statistics

Wireless Tx Packets: This displays the total number of good packets the bridge has sent for transmission by the wireless interface²⁰.

Wireless Rx Packets: This displays the total number of good packets the bridge has received from the wireless interface. See note 20.

Ethernet Tx Packets: This displays the total number of good packets the bridge has sent for transmission by the local Ethernet interface. . See note 20.

Ethernet Rx Packets: This displays the total number of good packets the bridge has received from the local Ethernet interface. . See note 20.

Packets To Internal Stack: This displays the total number of good packets the bridge has transmitted to the internal stack (e.g., ARP requests, PING requests, HTTP requests). . See note 20.

Packets From Internal Stack: This displays the total number of good packets the bridge has received from the internal stack (e.g. ARP responses, PING replies, HTTP responses). . See note 20.

Transmit Data Rate: The data rate in the transmit direction, expressed in Mbps and presented as: max, mean, min, and latest histogram format. The max, min and latest are true instantaneous measurements, the mean is the mean of a set of one second means. See Note 15. Expected data rates can be found in section 6.1.4.

Receive Data Rate: The data rate in the receive direction, expressed in Mbps and presented as: max, mean, min, and latest histogram format. The max, min and latest are true instantaneous measurements, the mean is the mean of a set of one second means. . See Note 15. Expected data rates can be found in section 6.1.4.

Aggregate Data Rate: The sum of the data rate in the directions, expressed in Mbps and presented as: max, mean, min, and latest histogram format. The max, min and latest are true instantaneous measurements, the mean is the mean of a set of one second means. See Note 15. Expected data rates can be found in section 6.1.4.

Link Capacity: The maximum aggregate data capacity available for user traffic under the current radio link conditions, assuming the units have been connected using Gigabit Ethernet. The sum of the displayed Transmit and Receive data rates may be lower than this figure if the link isn't fully loaded by the current traffic profile.

²⁰ The number in (+nn) displays the number of packets received since the last page refresh.

Transmit Modulation Mode: The modulation mode currently being used on the transmit channel. The number in brackets after the modulation mode and coding rate string is the effective data rate available to all MAC layer protocols. Details on the modulation modes can be found in section 21.1 “System Specifications”.

Receive Modulation Mode: The modulation mode currently being used on the receive channel. The number in brackets after the modulation mode and coding rate string is the effective data rate available to all MAC layer protocols. Details on the modulation modes can be found in section 21.1 “System Specifications”.

Receive Modulation Mode Detail: This supplies the user with information regarding the receive modulation mode in use. Possible values are:

- Running at maximum receive mode
- Running at user-configured Target Modulation Mode
- Restricted because Installation is armed
- Restricted because of byte errors on the wireless link
- Restricted because a DFS channel change is in progress
- Restricted due to the low Ethernet link speed
- Limited by the radio conditions

Signal Strength Ratio: The Signal Strength Ratio is the ratio of the power received by the Vertical / Horizontal receivers.

Wireless Link Availability: Expresses the link availability as a percentage of time since the first successful registration after a system restart, expressed as a percentage to four decimal places.

Byte Error Ratio: The ratio of detected Byte errors to the total number of Bytes since the last system reboot. This is a true measure of link quality as this measurement is made continually using null frames when there is no user data to transport.

Statistics Page Refresh Period: The statistics page refreshes automatically according to the setting entered here (in seconds).

Reset System Counters: By pressing this button all counters in the system are reset to zero.

Reset System Histograms: All histograms are reset, and the calculation period is restarted.

8.3.3 Detailed Counters Page

Ethernet			Wireless		
Attributes	Value	Units	Attributes	Value	Units
Ethernet Rx Octets	98,199 (+98,199)		Wireless Rx Octets	6,352 (+6,352)	
Ethernet Tx Octets	732,279 (+732,279)		Wireless Tx Octets	735,455 (+735,455)	
Ethernet Rx Drops	0 (+0)		Wireless Rx Drops	0 (+0)	
Ethernet Rx Packets	1,277 (+34)		Wireless Rx Packets	51 (+0)	
Ethernet Rx Broadcasts	84 (+84)		Wireless Rx Broadcasts	0 (+0)	
Ethernet Rx Multicasts	0 (+0)		Wireless Rx Multicasts	0 (+0)	
Ethernet Rx Crc And Align	0 (+0)		Wireless Rx Crc And Align	0 (+0)	
Ethernet Rx Undersize	0 (+0)		Wireless Rx Undersize	0 (+0)	
Ethernet Rx Oversize	0 (+0)		Wireless Rx Oversize	0 (+0)	
Ethernet Rx Fragments	0 (+0)		Wireless Rx Fragments	0 (+0)	
Ethernet Rx Jabbers	0 (+0)		Wireless Rx Jabbers	0 (+0)	
Ethernet Rx 64 Bytes	975 (+975)		Wireless Rx 64 Bytes	33 (+33)	
Ethernet Rx 65 To 127 Bytes	204 (+204)		Wireless Rx 65 To 127 Bytes	12 (+12)	
Ethernet Rx 128 To 255 Bytes	101 (+101)		Wireless Rx 128 To 255 Bytes	0 (+0)	
Ethernet Rx 256 To 511 Bytes	1 (+1)		Wireless Rx 256 To 511 Bytes	0 (+0)	
Ethernet Rx 512 To 1023 Bytes	0 (+0)		Wireless Rx 512 To 1023 Bytes	6 (+6)	
Ethernet Rx 1024 To Max Bytes	0 (+0)		Wireless Rx 1024 To Max Bytes	0 (+0)	
Ethernet Tx Drops	0 (+0)		Wireless Tx Drops	1 (+1)	
Ethernet Tx Packets	1,759 (+75)		Wireless Tx Packets	1,793 (+75)	
Ethernet Tx Broadcasts	1 (+1)		Wireless Tx Broadcasts	47 (+47)	
Ethernet Tx Multicasts	0 (+0)		Wireless Tx Multicasts	0 (+0)	
Ethernet Tx Collisions	0 (+0)		Wireless Tx Collisions	0 (+0)	
Ethernet Tx 64 Bytes	670 (+670)		Wireless Tx 64 Bytes	690 (+690)	
Ethernet Tx 65 To 127 Bytes	227 (+227)		Wireless Tx 65 To 127 Bytes	245 (+245)	
Ethernet Tx 128 To 255 Bytes	121 (+121)		Wireless Tx 128 To 255 Bytes	122 (+122)	
Ethernet Tx 256 To 511 Bytes	230 (+230)		Wireless Tx 256 To 511 Bytes	231 (+231)	
Ethernet Tx 512 To 1023 Bytes	177 (+177)		Wireless Tx 512 To 1023 Bytes	171 (+171)	
Ethernet Tx 1024 To Max Bytes	341 (+341)		Wireless Tx 1024 To Max Bytes	341 (+341)	
Ethernet Tx Fifo Drops	0 (+0)		Wireless Tx Fifo Drops	0 (+0)	
Ethernet Rx High Priority Frames	0 (+0)		Wireless Rx High Priority Frames	0 (+0)	
Ethernet Rx Low Priority Frames	1,292 (+1,292)		Wireless Rx Low Priority Frames	51 (+51)	
Ethernet Tx High Priority Frames	0 (+0)		Wireless Tx High Priority Frames	0 (+0)	
Ethernet Tx Low Priority Frames	1,773 (+1,773)		Wireless Tx Low Priority Frames	1,807 (+1,807)	
Ethernet Rx Pause Frames	0 (+0)		Wireless Rx Pause Frames	0 (+0)	
Ethernet Tx Pause Frames	0 (+0)		Wireless Tx Pause Frames	0 (+0)	
Ethernet Rx Classified Drops	0 (+0)		Wireless Rx Classified Drops	0 (+0)	
Statistics Page Refresh Period	<input type="text" value="3600"/>	Seconds	<input type="button" value="Update Page Refresh Period"/>	<input type="button" value="Reset System Counters"/>	

Figure 43 - Detailed Counters Page



The detailed counters page is subdivided into two columns. Column one presents the detailed statistics for the bridge's Ethernet interface. Column two relates to the wireless interface.

The Counters have the following definitions:

Tx & Rx Octets: Total number of octets (bytes) transmitted or received over the interface.

Rx Drops: Total number of frames dropped due to the lack of sufficient capacity in the receive buffer.

Rx Packets: Total number of packets received by the interface. This includes both good and bad packets.

Rx Broadcasts: Total number of good broadcast packets.

Rx Multicasts: Total number of good multicast packets.

Rx CRC and Align: Total number of packets with CRC or frame alignment errors.

Rx Undersize: Total number of packets received that are less than 64 bytes and have a valid CRC.

Rx Oversize: Total number of packets received that are greater than the maximum number of bytes with a valid CRC.

Rx Fragments: Total number of packets that are less than 64 bytes with an invalid CRC (these packet types are also known as runts).

Rx Jabbers: Total number of packets received that are greater than the maximum number of bytes with an invalid CRC.

Rx 64 Bytes: Total number 64 byte frames received

Rx 65 to 127 Bytes: Total number of frames received in the size range 65 to 127 bytes.

Rx 128 to 255 Bytes: Total number of frames received in the size range 128 to 255 bytes.

Rx 256 to 511 Bytes: Total number of frames received in the size range 256 to 511 bytes.

Rx 512 to 1023 Bytes: Total number of frames received in the size range 512 to 1023 bytes.

Rx 1024 to Max: Total number of frames received in the size range 1024 to Maximum bytes.

Tx Drops: Total number of frames dropped due excessive collisions, late collision and frame ageing.

Tx Packets: Total number of packets received by the interface. This includes both good and bad packets.

Tx Broadcasts: Total number of good broadcast packets.



Tx Multicasts: Total number of good multicast packets.

Tx Collisions: Total number frames experiencing collisions.

Tx 64 Bytes: Total number 64 byte frames transmitted

Tx 65 to 127 Bytes: Total number frames transmitted in the size range 65 to 127 bytes.

Tx 128 to 255 Bytes: Total number frames transmitted in the size range 128 to 255 bytes.

Tx 256 to 511 Bytes: Total number frames transmitted in the size range 256 to 511 bytes.

Tx 512 to 1023 Bytes: Total number frames transmitted in the size range 512 to 1023 bytes.

Tx 1024 to Max: Total number frames transmitted in the size range 1024 to Maximum bytes.

Tx FIFO Drops: Total number frames dropped due to lack of capacity in the transmit buffer, for example when the 600 Series bridge is connected to the local Ethernet at a connection speed of less than 1 Gbps.

Rx & Tx High Priority: Total number of received or transmitted frames marked as high priority.

Rx & Tx Low Priority: Total number of received or transmitted frames marked as low priority.

Rx & Tx Pause Frames: Total number of received or transmitted pause frames.

Rx Classifier Drops: Total number of received frames dropped due to the application of classifier rules.

Statistics Page Refresh Period: The statistics page refreshes automatically according to the setting entered here (in seconds).

8.3.4 [Install Pages](#)

These pages are used during system installation. There follows a description of the install pages along with their use during the installation configuration process. The actual installation process is described in section 7.7.11.

All wireless links are shipped as paired units. They are pre-configured at the factory so that they can be installed without the user supplying any configuration. Each wireless link is shipped with a quick start guide. Attached to the quick start guide is a summary of the pre-configured configuration data. Table 10 shows a sample link configuration. The values **highlighted** have been committed to the wireless unit's non-volatile storage.

<u>Example PTP 600 Series Configuration Data</u>	
For your convenience these two units have been pre-configured as a link	
<u>Units:</u>	
ODU serial number	ODU serial number
016780000FFF	016780000FC7
Ethernet MAC address	Ethernet MAC address
00:04:56:80:0F:FF	00:04:56:80:0F:C7
<u>Configured as:</u>	
Master	Slave
Target MAC address	Target MAC address
00:04:56:80:0F:C7	00:04:56:80:0F:FF
License Key	License Key
A471-FE88-428D-E1F3	534F-4F54-D1B0-E2DA
IP Address	IP Address
169.254.1.2	169.254.1.1

Table 10 – 600 Series Bridge Factory Configuration Values



The factory default configuration is limited in range to 40 Km (25 miles). If you wish to install a wireless link with a range of > 40 Km (> 25 miles) and < 200 Km (< 124 miles) or < 5 Km (< 3 miles) you must follow the 'Manually Configuring The Wireless Units' in section 8.3.4.1.



The factory default configuration is set to Region 1. Region 1 allows the 600 Series bridge a maximum transmit power of 25 dBm. If the local regulatory regime limits the maximum transmit power (EIRP) to less than 25 dBm you should obtain a new license key containing the correct region code from your local distributor or direct from Motorola. Alternatively in the short term, you should reduce the maximum transmit power by following the procedures in 'Manually Configuring The Wireless Units' in section 8.3.4.1.

8.3.4.1 Manually Configuring The Wireless Units

If the installer / system administrator wishes, they may modify the default installation configuration. If only the IP addresses (network configuration) are incorrect it is recommended that the values are changed via the configuration menu (Section 6.3.1.2). If any other parameters require modification then it is recommended that the system administrator use the Installation Wizard.

A detailed description of the Installation Wizard follows:

The 600 Series bridge operational software requires a license key to enable the wireless bridging capability and programs region code specific parameters in to the unit.

Software License Key

A valid software license key is required before installation of the PTP (Point to Point) wireless link can commence. If you do not have a valid license key please contact your distributor.

License key data entry

Attributes	Value	Units
License Key	<input type="text" value="3D7C-06FF-6596-BFB0"/>	
<input type="button" value="Validate license key"/> <input type="button" value="Reset Form"/>		

Capability summary

Attributes	Value	Units
Product Name	Motorola PTP 58600 Full	
MAC Address	00:04:56:80:0f:ff	
Region Code	1	
Frequency Variant	5800 MHz	

Figure 44 - License Key Data Entry

A license key is programmed into each unit during production and can be found written on the Configuration Data Summary Label which is attached to the Quick Install Guide. If subsequently the license key has been mislaid, replacement keys can be applied for online or via your distributor.

If a valid license key is not detected in the unit's non-volatile memory then the user is prompted to enter a valid key. It should be noted that 600 Series bridge units are shipped as link pairs and, as such, valid license keys are entered during the production process. To enter a license key simply type or paste the license key into the data entry box (Figure 44) and click the 'validate license key' button.

8.3.4.2 Internet Protocol Configuration

Step 1 of the installation wizard requires the installer to enter the Internet Protocol (IP) configuration.

Step 1 of 3: Interface Configuration

Please complete the wizard in order to arm the unit.

A valid IP address address and subnet mask is required before the PTP unit can be used on a network. Please see your network administrator if you are unsure of the correct values to enter here.

Interface configuration data entry

Attributes	Value	Units
IP Address	<input type="text" value="169"/> . <input type="text" value="254"/> . <input type="text" value="1"/> . <input type="text" value="1"/>	
Subnet Mask	<input type="text" value="255"/> . <input type="text" value="255"/> . <input type="text" value="0"/> . <input type="text" value="0"/>	
Gateway IP Address	<input type="text" value="169"/> . <input type="text" value="254"/> . <input type="text" value="0"/> . <input type="text" value="0"/>	
Use VLAN For Management Interfaces	<input checked="" type="radio"/> Disabled <input type="radio"/> Enabled	
Telecoms Interface	<input checked="" type="radio"/> None <input type="radio"/> E1 <input type="radio"/> T1	

Next

Figure 45 - Installation Wizard Internet Protocol Configuration

IP Address: Internet protocol (IP) address. This address is used by the family of Internet protocols to uniquely identify this unit on a network.

Subnet Mask: A subnet allows the flow of network traffic between hosts to be segregated based on a network configuration. By organizing hosts into logical groups, subnetting can improve network security and performance.

Gateway IP Address: The IP address of a computer / router on the current network that acts as a gateway. A gateway acts as an entrance / exit to packets from / to other networks.

Use VLAN Management Interface: This controls whether the management interfaces (HTTP/SNMP/SMTP/SNTP) use a VLAN. Selecting this option presents the user with extra fields in which to enter the Management VLAN ID, Priority and whether to validate the VLAN ID. If the user modifies this control that a warning dialog is displayed see Figure 46.

Telecoms Interface This allows the activation of the 600 Series bridge telecoms interface. If the selection options are disabled, T1 or E1 note mixed T1/E1 configurations are not permitted.

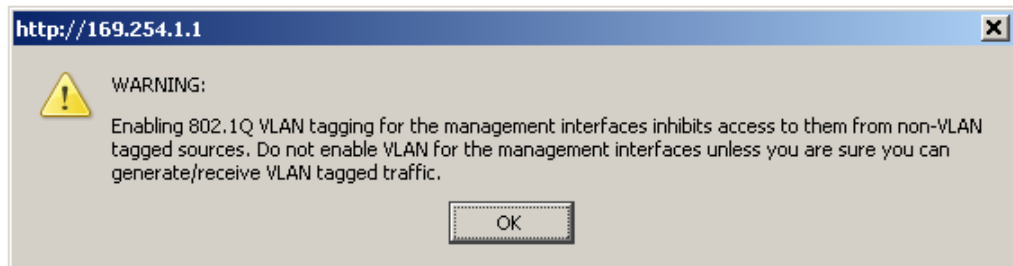

Figure 46 - VLAN Warning

Once complete, click the 'Submit Internet Protocol Configuration' button or the 'Next' link.

8.3.4.3 Telecoms Interface

If the telecoms interface is configured to either T1 or E1 then the web page will reconfigure itself with the following additional configuration options.

Step 1 of 3: Interface Configuration

Please complete the wizard in order to arm the unit.

A valid IP address address and subnet mask is required before the PTP unit can be used on a network. Please see your network administrator if you are unsure of the correct values to enter here.

Interface configuration data entry

Attributes	Value	Units
IP Address	169 . 254 . 1 . 2	
Subnet Mask	255 . 255 . 0 . 0	
Gateway IP Address	169 . 254 . 0 . 0	
Use VLAN For Management Interfaces	<input checked="" type="radio"/> Disabled <input type="radio"/> Enabled	
Telecoms Interface	<input type="radio"/> None <input type="radio"/> E1 <input checked="" type="radio"/> T1	
Telecoms Channel Selection	<input type="radio"/> Channel A Only <input checked="" type="radio"/> Channels A and B	
Channel A Line Code	<input type="radio"/> AMI <input checked="" type="radio"/> B8ZS/HDB3	
Channel A Cable Length	<input checked="" type="radio"/> 133 <input type="radio"/> 266 <input type="radio"/> 399 <input type="radio"/> 533 <input type="radio"/> 655	feet
Channel B Line Code	<input type="radio"/> AMI <input checked="" type="radio"/> B8ZS/HDB3	
Channel B Cable Length	<input checked="" type="radio"/> 133 <input type="radio"/> 266 <input type="radio"/> 399 <input type="radio"/> 533 <input type="radio"/> 655	feet

Next

Figure 47 - Telecoms Configuration Interface

Telecoms Channel Selection: This controls the selection of the telecoms interface standard supported options or T1 and E1.

Channel A Line Code: The line code setting of the telecoms interface. This must match the setting of the device connected to this interface.

Channel B Line Code: The line code setting of the telecoms interface. This must match the setting of the device connected to this interface.

Cable Length: This field is applicable to the T1 operating mode only. It configures the T1 transceiver to output a signal suitable for driving a cable of the specified length. This should be set to reflect the length of cable between the wireless unit and the connected equipment.

8.3.4.4 Wireless Configuration

Step 2 of the installation wizard requires the installer to enter the wireless configuration parameters.

Step 2 of 3: Wireless Configuration

Please enter the following wireless configuration parameters

Wireless data entry

Attributes	Value	Units
Target MAC Address	00:04:56: 80 : 0f : c7	
Master Slave Mode	<input checked="" type="radio"/> Master <input type="radio"/> Slave	
Link Mode Optimization	<input checked="" type="radio"/> IP Traffic <input type="radio"/> TDM Traffic	
Max Transmit Power	25	dBm
Ranging Mode	<input checked="" type="radio"/> Auto 0 to 40 km <input type="radio"/> Auto 0 to 100 km <input type="radio"/> Auto 0 to 200 km <input type="radio"/> Target Range	
Target Range	0.0	km
Platform Variant	<input checked="" type="radio"/> Integrated Antenna <input type="radio"/> Connectorized	
Spectrum Management Control	<input checked="" type="radio"/> i_DFS <input type="radio"/> Fixed Frequency	
Lower Center Frequency	5742	MHz
Installation Tones	<input checked="" type="radio"/> Disabled <input type="radio"/> Enabled	

◀ Back
Next ▶

Figure 48 - Installation Wizard Wireless Configuration



Target MAC Address: The MAC Address of the peer unit that will be at the other end of the wireless link. This is used by the system to ensure the unit establishes a wireless link to the correct peer.

The MAC Address can be found embedded within the serial number of the unit. The last six characters of the serial number are the last three bytes of the unit's MAC address.

(Note: A PTP 600 Series system is shipped as a pair of units with pre-loaded correct MAC addresses. MAC addresses will only need to be entered if an existing unit has to be replaced in the field or the units configuration has been erased).

Master Slave Mode: At this point it is necessary to decide which end will designate a Master. The Master unit is the controlling unit with respect to the point-to-point link and its maintenance. The master transmits until the link is made, while the Slave listens for its peer and only transmits when the peer has been identified.

Link Mode Optimization: Optimizes the link behavior according to the type of traffic that will be bridged.

Max Transmit Power: This attribute controls the maximum transmit power the unit is permitted to use when installing and executing the wireless link. The maximum setting for a particular region or country is controlled by the License Key.

Ranging Mode: During installation the wireless units perform automatic ranging. The ranging mode allows the installer to control the behavior of the system's automatic ranging algorithms. The default value is 0 to 40 km²¹ (0 to 25 miles). If the installer is required to install a link of greater than 40 km (25 miles) then the ranging mode attribute MUST be configured to '0 to 100km' (0 to 62 miles) or '0 to 200km' (0 to 124 miles) mode depending on the range of the link.

Target Range: Installers that know the range between the two wireless units to within ± 1 km can use the target range mode. The main advantage of the target range mode is that it reduces the time taken by the units to range. To use the target range mode the installer MUST select Target Range as the ranging mode and enter the approximate range in km in the Target range data entry field at both ends of the link.

²¹ If preferred PTP 600 Series Bridge range functions can be configured to operate in miles, see the Properties page in section 8.3.14.

Spectrum Management Control: Is used to configure the PTP 600 Series Bridge's Spectrum Management features, see section 8.3.7 for more details. I-DFS is the abbreviation for intelligent Dynamic Frequency Selection. This feature continually monitors the spectrum looking for the channel with the lowest level of on channel and co-channel interference. Fixed frequency mode allows the installer to fix transmit and receive frequencies on the units. The frequencies may be configured symmetrically or asymmetrically.

Lower Center Frequency: The software for the PTP 600 Series Bridge allows a user to optionally adjust the channel center frequencies. Changing the Lower Center Frequency attribute causes all channel center frequencies to be offset. It effectively slides the channelization up or down. See Sections 5.4 and 5.4.3 for more detail.



Warning: The lower center frequency attribute must be configured to the same value for both the master and slave. Failure to do so will cause the wireless link to fail reestablishment. The only way to recover from this situation is to modify the Lower Center Frequency attribute so that they are identical on both the master and slave unit.

Fixed Transmit Frequency, Fixed Receive Frequency: The software for the PTP 600 Series Bridge allows a user to optionally fix transmit and receive frequencies for a wireless link. The settings must be compatible at each end of the link. Once configured the spectrum management software will not attempt to move the wireless link to a channel with lower co or adjacent channel interference. Therefore this mode of operation is only recommended for deployments where the installer has a good understanding the prevailing interference environment. Figure 49 shows a sample fixed frequency configuration. In the example the lower center frequency is set to its default values and the Fixed Transmit Frequency is set to 5742 MHz and the Fixed Receive Frequency is set to 5742 MHz. Care must be taken when configuring the Fixed Transmit and Receive Frequencies to ensure that both frequencies are on the same 10 MHz channel raster as the Lower Center Frequency. For example both the Fixed Transmit and Receive Frequencies must be a multiple of 10 MHz from the Lower Center Frequency ($5752 = 5742 + 10 \text{ MHz}$) and ($5782 = 5742 + 10 \text{ MHz} \times 3$). See Sections 5.4 and 5.4.3 for more detail.

Step 2 of 3: Wireless Configuration

Please enter the following wireless configuration parameters

Wireless data entry

Attributes	Value	Units
Target MAC Address	00:04:56: [80] : [0f] : [c7]	
Master Slave Mode	<input checked="" type="radio"/> Master <input type="radio"/> Slave	
Link Mode Optimization	<input checked="" type="radio"/> IP Traffic <input type="radio"/> TDM Traffic	
Max Transmit Power	[25]	dBm
Ranging Mode	<input checked="" type="radio"/> Auto 0 to 40 km <input type="radio"/> Auto 0 to 100 km <input type="radio"/> Auto 0 to 200 km <input type="radio"/> Target Range	
Target Range	[0.0]	km
Platform Variant	<input checked="" type="radio"/> Integrated Antenna <input type="radio"/> Connectorized	
Spectrum Management Control	<input type="radio"/> i_DFS <input checked="" type="radio"/> Fixed Frequency	
Default Raster	<input checked="" type="radio"/> On <input type="radio"/> Off	
Fixed Tx Frequency	[5742]	MHz
Fixed Rx Frequency	[5742]	MHz
Installation Tones	<input checked="" type="radio"/> Disabled <input type="radio"/> Enabled	
<input type="button" value="Submit Wireless Configuration"/> <input type="button" value="Reset Form"/>		

[<< Back](#)

[Next >>](#)

Figure 49 - Fixed Frequency Operation

Installation Tones: Where the use of audio installation tones is not required this control allows the installer to optionally disable the tone generator during the installation process.

Once the installer is satisfied with the wireless configuration options then the “Submit Wireless Configuration” button or the “Next” link should be clicked.

Step 3 of 3: Confirm Installation Configuration

Please review your entered configuration. If any of the configuration items are incorrect please use the back button to apply the corrections.

Once you're happy with the configuration press the 'Confirm Configuration, Arm Installation Agent and Reboot' button, this will commit the parameters to non-volatile memory and reboot this wireless unit.

Installation configuration

Attributes	Value	Units
IP Address	169.254.1.1	
Subnet Mask	255.255.0.0	
Gateway IP Address	169.254.0.0	
Use VLAN For Management Interfaces	Disabled	
Telecoms Interface	None	
Target MAC Address	00:04:56:80:0f:c7	
Master Slave Mode	Master	
Link Mode Optimization	IP Traffic	
Max Transmit Power	25	dBm
Ranging Mode	Auto 0 to 40 km	
Platform Variant	Integrated Antenna	
Spectrum Management Control	i_DFS	
Lower Center Frequency	5742	MHz
Installation Tones	Disabled	

Confirm Configuration, Arm Installation Agent and Reboot

 **Back**

Figure 50 - Installation Wizard Confirm Configuration

If the settings are correct and appropriate, click the “Confirm Configuration, Arm Installation and Reboot” button. The user will now be prompted to confirm the action (Figure 51).

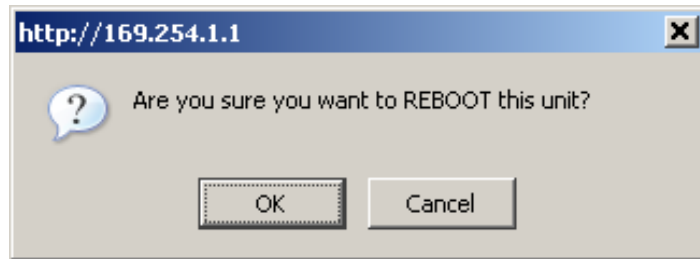

Figure 51 - Reboot Confirmation Pop Up

All the attributes are committed to non-volatile memory. Immediately following the write to non-volatile memory the unit is reset.

Note: If you have changed the Ethernet parameters you must reconnect using the correct network and address settings.

8.3.4.5 Disarm

Step 5 of the installation wizard is the disarm phase.

Disarm Installation

The installation agent is armed. If you wish to disarm installation then use the 'Disarm Installation Agent' button. If you wish to reconfigure the installation agent then use the wizards 'back' button

Installation configuration

Attributes	Value	Units
IP Address	169.254.1.1	
Subnet Mask	255.255.0.0	
Gateway IP Address	169.254.0.0	
Use VLAN For Management Interfaces	Disabled	
Telecoms Interface	None	
Target MAC Address	00:04:56:80:0f:c7	
Master Slave Mode	Master	
Link Mode Optimization	IP Traffic	
Max Transmit Power	25	dBm
Ranging Mode	Auto 0 to 40 km	
Platform Variant	Integrated Antenna	
Spectrum Management Control	i_DFS	
Lower Center Frequency	5742	MHz
Installation Tones	Disabled	

<< **Back**

Figure 52 - Disarm Installation

Once section 8.3.4.4 is complete pressing the “Disarm Installation Agent” button completes the installation process²² and the audible installation tone will be switched off. If the installer wishes to modify the installation configuration then the ‘Back’ link can be used to access the installation wizard steps described above.

After disarming the wireless link the user is presented with one of two possible configuration pages, see Figure 53 and Figure 54. The screen presents hyperlinks to the main configuration and spectrum management pages.

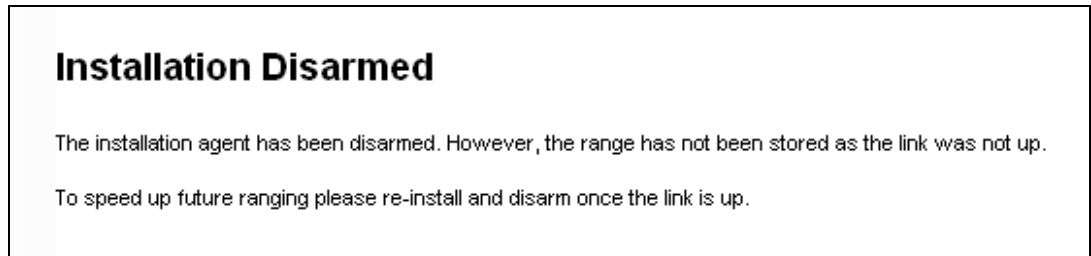

Figure 53 - Optional Post Disarm Configuration 1

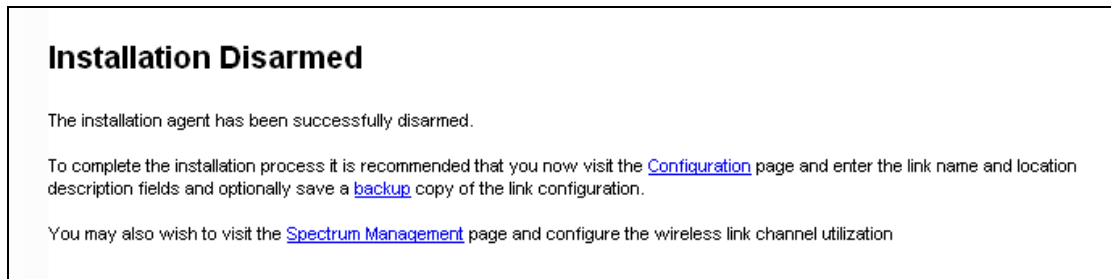

Figure 54 - Optional Post Disarm Configuration 2

²² The installation process is completed when both ends of the link are ‘disarmed’.

After installation the system administrator may wish to modify the wireless units descriptive configuration (link name and link location). In addition the system administrator may wish to change the spectrum management configuration of the wireless unit, or look at the analysis of the 5.8 GHz spectrum to see if the automatic channel selection is appropriate for the system administrator's network. It is also recommended that a backup copy of the wireless units configuration is taken. Hyperlinks are provided on the post disarm page for ease of use.

8.3.5 Graphical Install

To aid the installation of wireless links two graphical installation aids have been introduced in this 600 Series system version.

- A PDA installation screen
- A larger installation screen available from the main HTTP management interface.

The design of the installation screen has been deliberately kept simple and uncluttered. An example of the installation screen is shown in Figure 55. Both the PDA and the large format installation screen have the same content and only differ in size. The PDA installation screen is 232 by 220 pixels to be compatible with the typical size of a PDA screen.

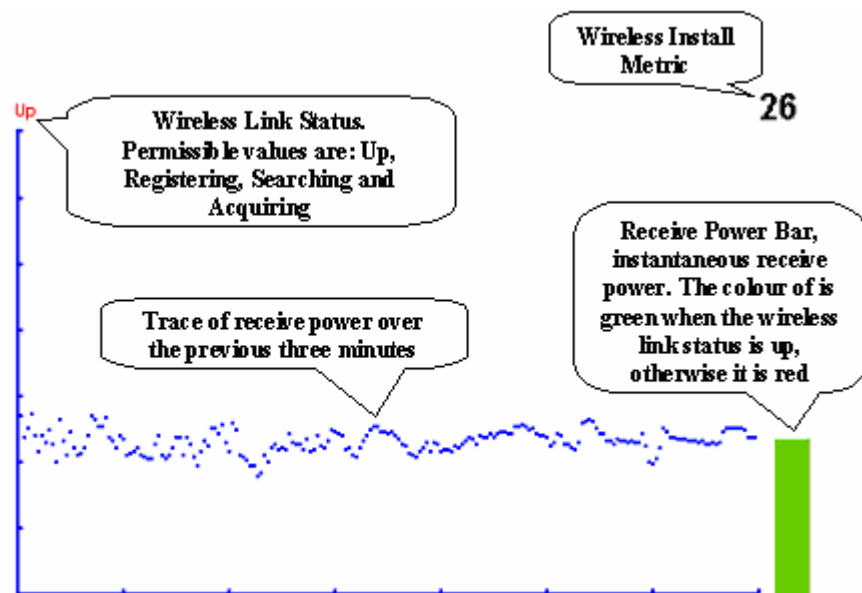

Figure 55 – Graphical Installation Screen

The screen displays the receive power over the last three minutes. This will allow the installer to slowly sweep the antenna during installation and monitor the variation in signal strength with angular position. The screen automatically refreshes every three seconds.

The screen also displays the current state of the wireless link in two ways. First, the actual state of the wireless link is written in the top left corner of the screen. The instantaneous receive power bar also encodes the state of the wireless link using green to signify that the wireless link is up and red for all other states.

For the more technically, aware the installation metric is simply the instantaneous receive power in dBm + 100.

The PDA installation tool is accessed via a hidden URL `http://<ip-address>/pda.cgi`. It should be noted that this link is only available after the user has logged in as system administrator.

The large screen version of the graphical user interface is available as a submenu option of the installation wizard.

8.3.6 Software Upgrade

The 600 Series system has two software image banks; one is a fixed image which is stored in protected non-volatile memory and cannot be modified by the user. The second bank is used by the system administrator to upgrade the firmware when necessary. Figure 56 shows the main software upgrade web page.

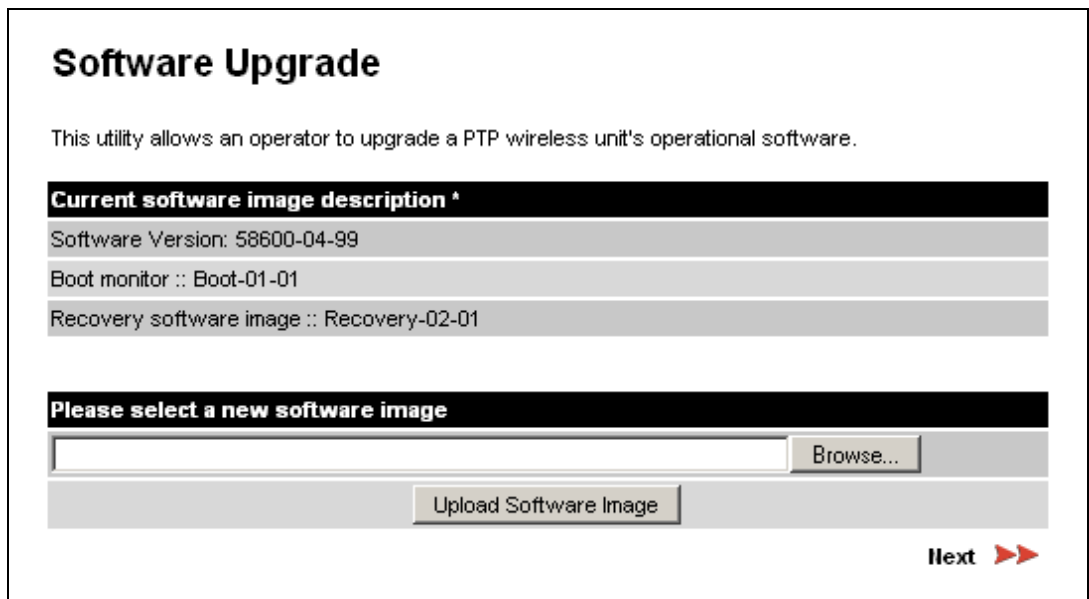

Software Upgrade

This utility allows an operator to upgrade a PTP wireless unit's operational software.

Current software image description ^

Software Version: 58600-04-99

Boot monitor :: Boot-01-01

Recovery software image :: Recovery-02-01

Please select a new software image

Next >>

Figure 56 - Software Upgrade

The 'Fixed' or 'Recovery' image is used by the System Administrator to:

- Reset Ethernet configuration to default settings
- Erase Configuration
- Upgrade software

For a full description of the Recovery image see section 9.

The software upgrade pages are used to update a unit's operational software. The software image to be uploaded should be downloaded to local storage from the Motorola web site. The software image is delivered by Motorola as a compressed zip file. Once the zip file has been downloaded, the user should extract the PTP 600 Series Software image, identifiable by its '.dld' file extension.

The first step (Figure 56) is to use the "Browse" button to locate the software image previously downloaded to local storage from the [Motorola](#) web site. Once the image is located, the user should press the "Upload image to wireless unit" button to start the software upgrade process.

The software image will now be uploaded to the unit. This upload should only take a few seconds. Once complete the image is verified and validated to ensure that no errors occurred during transfer and that the image is valid to run on the current platform. If there are any problems a warning screen will appear.

The unit being upgraded will now display information about the build it currently has stored in the image bank and the one that's just been uploaded. If the image is not the right one, the user has the option to go back and reload a new image. (See Figure 57)

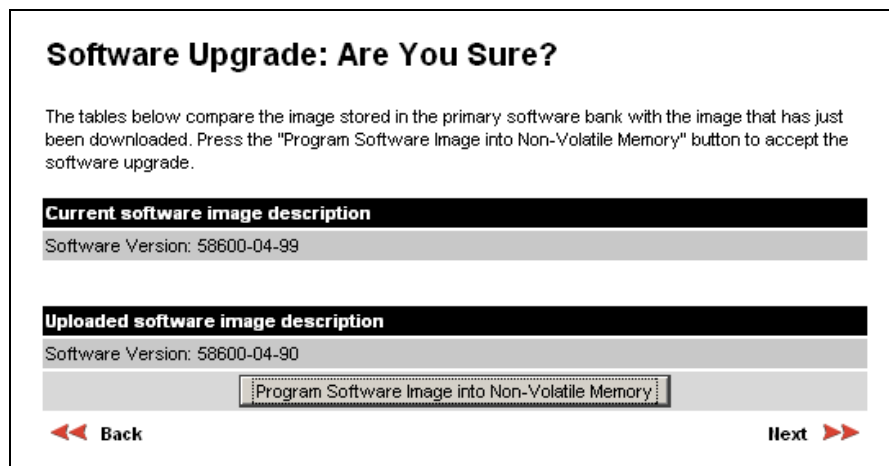

Figure 57 - Software Upgrade Image Check

The user should ensure that the correct image is shown before pressing the “Program Software Image into Non-Volatile Memory” button. Once this button has been pressed the image is stored into non-volatile memory, this process can take up to 60 seconds and must not be interrupted.



If the upgrade process is interrupted during the erasure of the image bank, or during the reprogramming of the image bank, the image bank will be left in a corrupt state. If this occurs the software must be reloaded. All software images that are stored in non-volatile memory are protected via the use of CRCs. If the software detects an invalid CRC the image bank is marked as ‘corrupt’ and the 600 Series bridge boot code will boot the fixed software image. If this occurs the user must attempt to reload the correct version of software.

During the write process the progress of the upgrade is displayed on the progress tracking page (Figure 58). The upgrade process should not be interrupted. Interruption of this process can result in a corrupt main software image, which will result in the recovery image been booted at the next reset cycle.

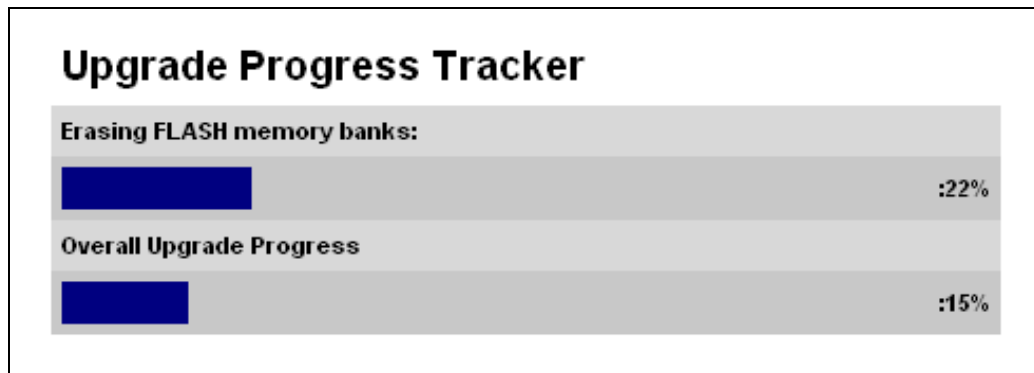

Figure 58 - Software Download Progress Indicator

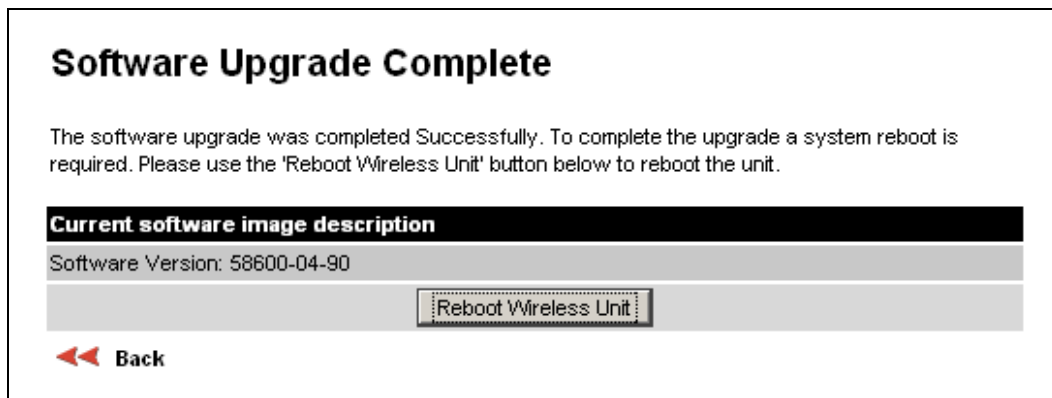

Figure 59 - Software Upgrade Complete

When the software image has been written to non-volatile memory Figure 59 will be displayed showing the status of the software upload.

Reboot the unit by clicking the “Reboot Wireless Unit” button. You will be asked to confirm this action as shown in Figure 60.

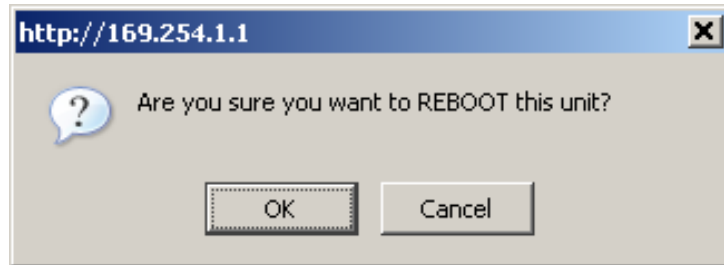

Figure 60 - Reboot Confirmation Pop Up

This will reboot the unit, taking up to 120 seconds. During this time you will not be able to communicate with the unit.

If you cannot communicate with the unit after 120 seconds, this could indicate a problem with the memory update process. Under these circumstances the user should enter “Recovery Mode”, see section 9.

After the reboot the user should check that the required software image is loaded and running.

NOTE: Please ensure that you are upgrading the correct units. Units cannot be downgraded and license keys cannot be swoped once upgraded.

8.3.7 Spectrum Management

Spectrum Management Selection is the PTP 600 Series Bridge feature that monitors the available wireless spectrum and directs both ends of the wireless link to operate on a channel with a minimum level of co-channel and adjacent channel interference.

8.3.7.1 Wireless Channels

The PTP 600 Series Bridge operates using a set of predefined overlapping channels. There are a different number of channels, depending on the raster mode selected. Each channel occupies 30 MHz of wireless spectrum and is offset in center frequency from its neighboring channel by 10 MHz. It is important to note that adjacent channels on the Spectrum management display have a 10 MHz overlap to the adjacent channel.

The default channelization can be modified by varying the lower center frequency attribute in the installation wizard - see section 8.3.4.4. See Section 5.4 and 5.4.3 for more detail.

8.3.7.2 Spectrum Management Measurements

The 600 Series bridge performs two mean signal measurements per TDD cycle, per channel. This mean measurement represents the mean received signal power for the 40 μ S measurement period.

The Spectrum Management algorithm collects measurements equally from all channels. This process is called the Channel Availability Check (hereafter referred to by the acronym CAC). The CAC uses a round-robin channel selection process to collect an equal amount of measurements from each channel. It is important to note that the CAC measurement process is not altered by the channel barring process. Measurements are still collected for all channels irrespective of the number of barred channels.

8.3.7.3 Measurement Analysis

Spectrum Management uses statistical analysis to process the received peak and mean measurement. The statistical analysis is based on a fixed, one minute, measurement quantization period. Spectrum Management collects data for the specified quantization period and only at the end of the period is the statistical analysis performed.

The analysis produces three key metrics for each channel:

- Peak of Means
- 99.9% Percentile of the Means
- Mean of Means

Peak of Means is the largest mean interference measurement encountered during the quantization period. The peak of means is similar to the peak of peaks and is useful for detecting slightly longer duration spikes in the interference environment.

99.9% Percentile of the Means is the value of mean interference measurement which 99.9% of all mean measurements fall below, during the quantization period. The 99.9% percentile metric is useful for detecting short duration repetitive interference that by its very nature has a minimal effect of the mean of means.

Mean of Means is the arithmetic mean²³ of the measured means during a quantization period. The mean of means is a coarse measure of signal interference and gives an indication of the average interference level measured during the quantization period. The metric is not very good at predicting intermittent interference and is included to show the spread between the mean of means, the 99.9% percentile and the peak of means.

Important Note: Spectrum Management uses the 99.9% percentile as the prime interference measurement. All subsequent references to interference level refer to this percentile measurement.

The display of statistical measurement on the spectrum management page always shows a statistical summary of all channel measurement. The statistical summary is controlled by the Statistics Window attribute. This attribute defaults to a value of twenty minutes, which means that the mean and percentile values displayed for each channel are calculated over the 20 minute period. All channel decisions are made using the values computed over the statistics window period.

8.3.7.4 [The Spectrum Management Master / Slave Relationship](#)

By default Spectrum Management operates in a master / slave relationship. The master is assumed to be the link master configured during installation. All Spectrum Management configuration changes **MUST** be performed from the master. To enforce this the Spectrum Management web page has a different appearance depending if you are viewing the data from the master or slave.

²³ The arithmetic mean is the true power mean and not the mean of the values expressed in dBm.

All configuration changes are applied at the master only. These changes are then messaged from the master to the slave. Any Spectrum Management configuration messages received at the slave are stored in non-volatile memory. This enables both master and slave to keep identical copies of Spectrum Management configuration data in their non-volatile memories. It is therefore possible to swap master and slave roles on an active Point-to-Point link without modifying Spectrum Management configuration.

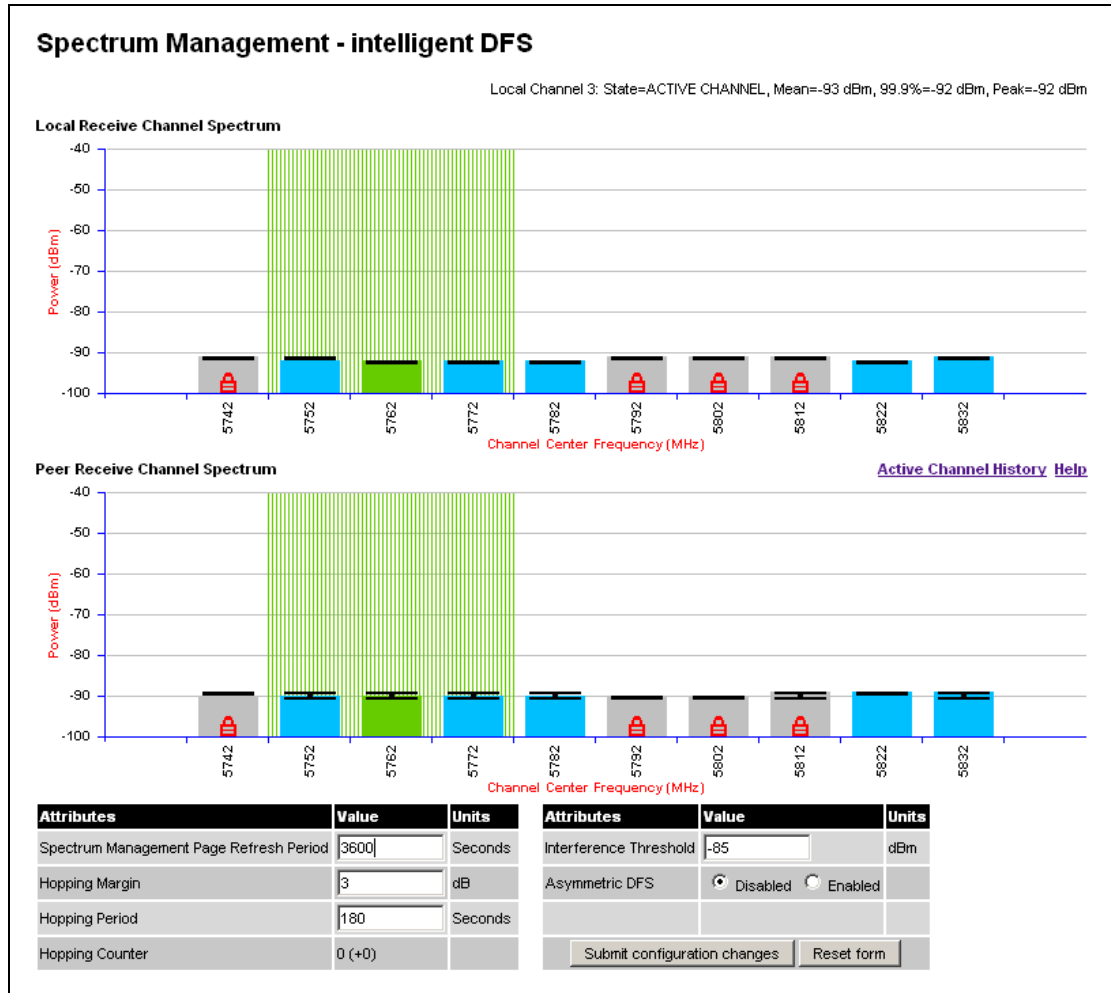

Figure 61 - Spectrum Management as seen from the Master

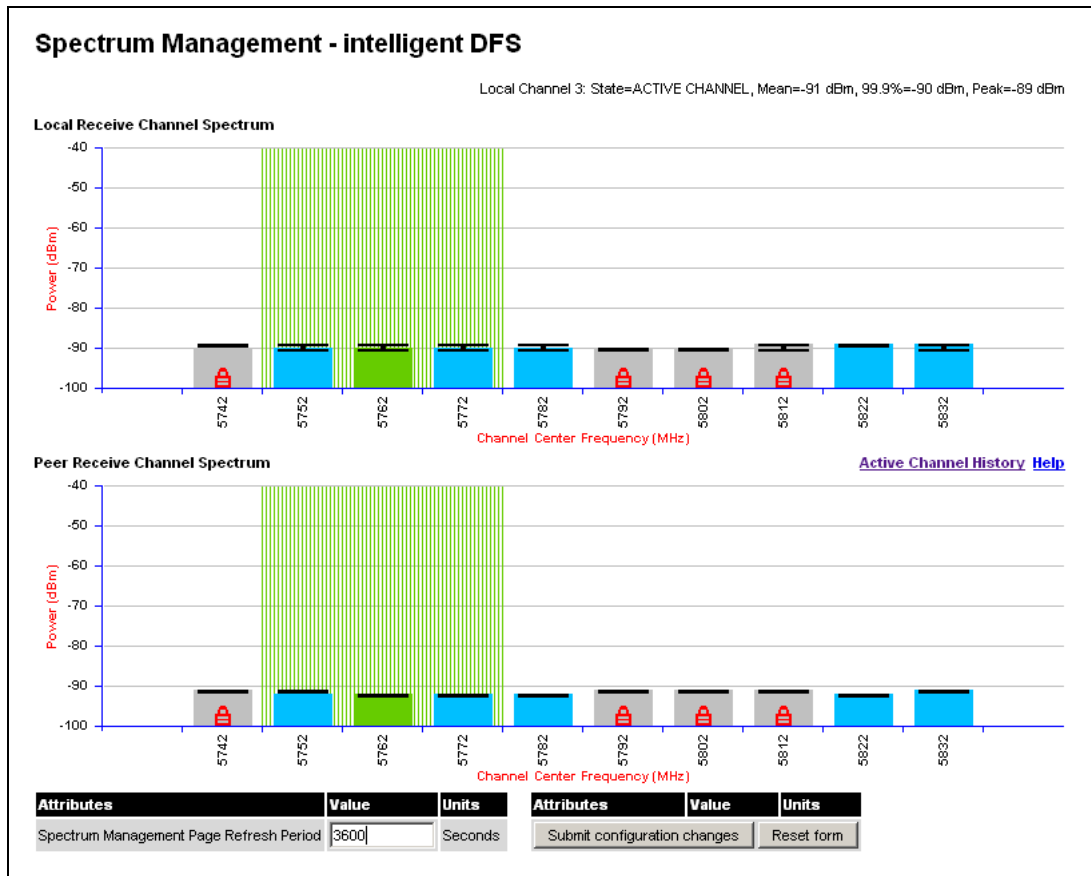

Figure 62 - Spectrum Management as seen from the Slave

Figure 61 shows an example Spectrum Management webpage as seen from the master.

Figure 62 shows an example Spectrum Management webpage as seen from the slave. It should be noted that the key configuration attributes are not available on the slave web page.

8.3.7.5 Spectrum Management Configuration

The following section describes the user modifiable configuration accessible from the Spectrum Management webpage. It is recommended that the default values are maintained. If the user believes that the performance of the Spectrum Management algorithm requires some modifications this should only be done after consulting your Motorola Point-to-Point distributor or one of the system field support engineers.

Refresh Page Period: The page refreshes automatically according to the setting entered here (in seconds).

Hopping Margin: Spectrum Management uses this margin when making a channel hop decision. The target channel has to have an interference level 3 dB (default) better than the current active channel.

Hopping Period: The Spectrum Management algorithm evaluates the metrics every 'Hopping Period' seconds (180 seconds by default) looking for a channel with lower levels of interference. If a better channel is located, Spectrum Management performs an automated channel hop. If SNMP or SMTP alerts are enabled an SNMP TRAP or an email alert is sent warning the system administrator of the channel change.

Hopping Counter: is used to record the number of channel hops. The number in the "(+)" brackets indicates the number of channel changes since the last screen refresh.

Interference Threshold: Spectrum Management uses the interference threshold to perform instantaneous channel hops. If the measured interference on a channel exceeds the specified threshold, then iDFS will instruct the wireless to immediately move to a better channel. If a better channel cannot be found the 600 Series bridge will continue to use the current active channel. (Default -85 dBm)

Asymmetric DFS: The default configuration of symmetric operation constrains the link to operate symmetrically, using the same transmit and receive channels. When in symmetric mode the slave unit will always follow the master. If the master moves to a new channel the slave will hop to the same channel. When the Point-to-Point link is configured as an asymmetric link both the master and slave are free to select the best channel from their own set of local interference metrics.

8.3.7.6 Barring Channels

Channels can only be barred/unbarred by the system administrator from the master Spectrum Management web page. The barring/unbarring operations are disabled on the slave web page. If an attempt to bar/unbar a channel is made at the slave, a warning dialog is generated.

Barring/Unbarring of channels is performed by clicking the appropriate channel on the local or peer channel spectrum plots on the master web page. Each bar/unbar attempt will be preceded by a confirmation dialog. It should be noted that the channel bar will take effect immediately and is not related to the measurement quantization period.

8.3.7.7 Local and Peer Channel Spectrum Graphics

Spectrum Management presents its computed statistical measurements in a graphical display on both the master and slave Spectrum Management web page.

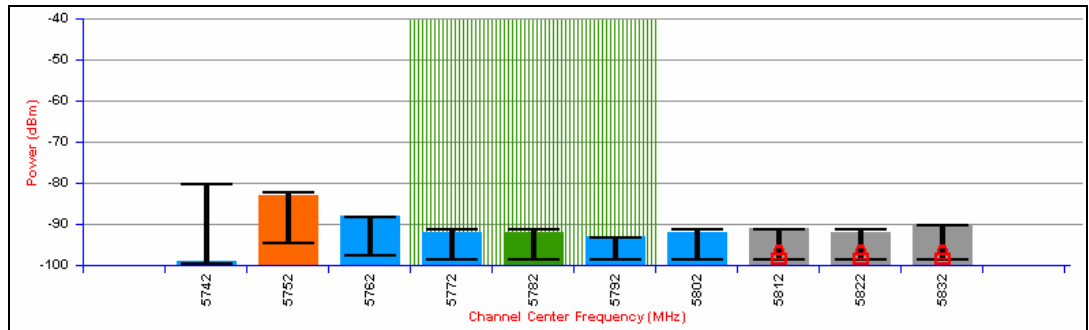

Figure 63 - Example Spectrum Management Graphic

The X-axis shows a stylized view of the 9 or 10 selectable wireless channels. It is important to note that adjacent channels on the display have a 10 MHz overlap. The display separates the display of channels to help the clarity of the resultant display. The axis is labeled using the channel center frequencies in MHz.

The Y-axis shows the interference power levels from –100 to –40 dBm.

The active channel (channel 5 in Figure 63) is always marked using hatched green and white lines. The width of the hatching is directly proportional the 30 MHz spectral occupancy of the channel.

The individual channel metrics are displayed using a colored bar and an 'I' bar.

The colored bar represents the following channel state:

Green	Active	The channel is currently in use, hosting the Point-to-Point wireless link
Orange	Interference	The channel has interference above the interference threshold
Blue	Available	The channel has an interference level below the interference threshold and is considered by the Spectrum Management algorithm suitable for hosting the Point-to-Point link
Grey	Barred	The system administrator has barred this channel from use. For improved visibility, an additional red 'lock' symbol is used to indicate that a channel is barred.

Table 11 - Spectrum Management change state key

The top of the colored bar represents the 99.9% percentile metric for specific channel.

The 'I' Bar is used to display the mean of means and peak of means metrics. The lower horizontal bar represents the mean of means and the upper horizontal bar represents the peak of means. The vertical bar is used as a visual cue to highlight the statistical spread between the peak and the mean of the statistical distribution.

8.3.7.8 Active Channel History

The active channel history is a time series display of the channels used by the PTP 600 Series Bridge over the last 25 hours. The active channel history is activated from the main Spectrum Management page using the 'Active Channel History' hyperlink. An example of the active channel history display is shown in Figure 64. Where there are parallel entries on the display this signifies that the wireless link occupied this channel during the measurement period. The measurement periods are one minute (from zero to sixty minutes) and twenty minutes from (60 minutes to twenty five hours).

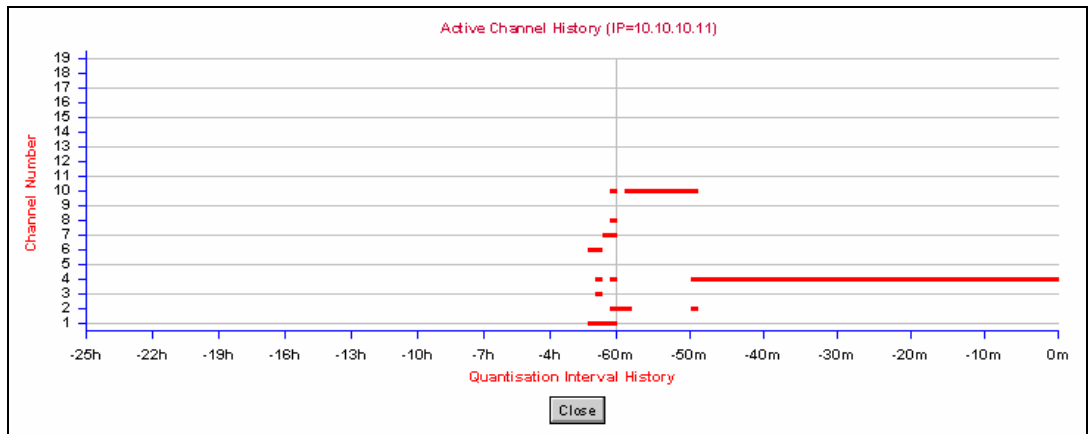

Figure 64 - Active Channel History Screen

8.3.7.9 Viewing Historic Spectrum Management Metrics

Spectrum Management allows the system administrator to view the results of previous measurement quantization periods. Holding down the shift key and clicking the appropriate channel on the local channel spectrum plots activates this feature. This feature is available on both the master and slave web page.

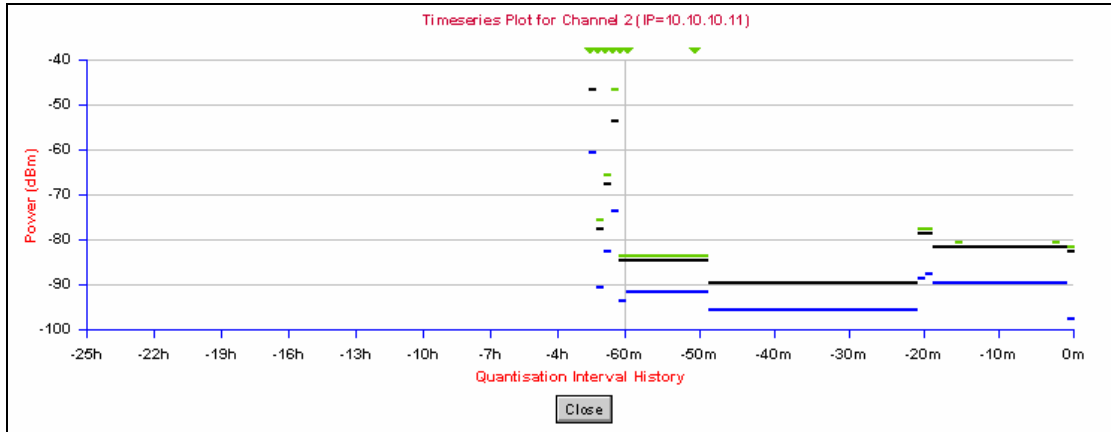

Figure 65 - Spectrum Management Time Series Plot

Figure 65 shows an example time series plot. A time series plot displays the previous 132 measurement quantization periods. If the PTP 600 Series Bridge has not been running for 132 quantization periods then only the number of measurement quantization periods that are available are displayed.

GREEN	Peak of Means interference measurement
BLACK	99.9% percentile of means interference measurement
BLUE	Mean of Means interference measurement

Table 12 - Spectrum Management Time Series Key

8.3.8 Spectrum Management (Fixed Frequency and WIMAX)

The PTP 600 Series Bridge software allows a user to optionally fix transmit and receive frequencies for a wireless link. Once configured, the spectrum management software will not attempt to move the wireless link to a channel with lower co and adjacent channel interference. Therefore this mode of operation is only recommended for deployments where the installer has a good understanding the prevailing interference environment. (See section 8.3.4.4). Care must also be taken to ensure that the frequency allocations at each end of the link are compatible. To help the user when identifying the mode of operation Spectrum Management uses two visual cues. See Figure 66. The main page title identifies the mode of operation using the “Fixed Frequency Mode” postfix and the selected channels are identified by a red capital ‘F’.

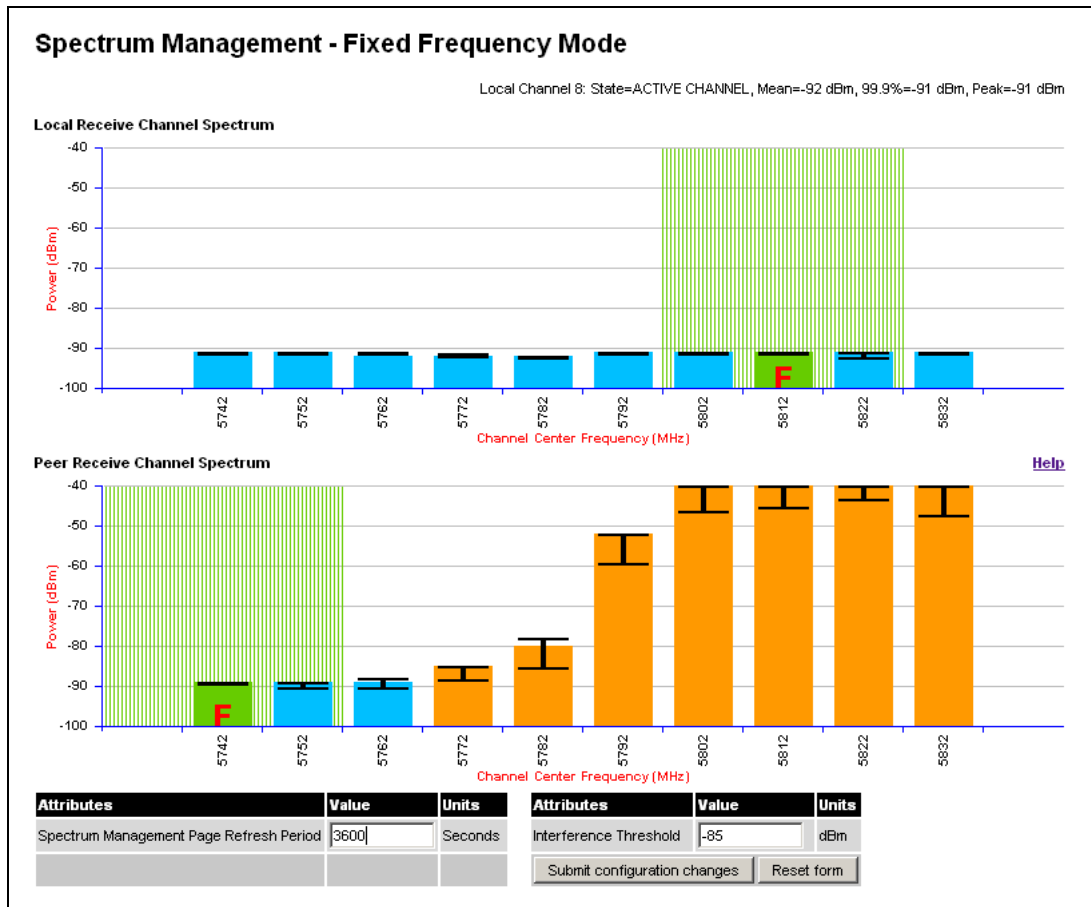

Figure 66 - Spectrum Management Fixed Frequency Screen



Channel barring is disabled in fixed frequency mode; it is not required as dynamic channel hopping is prohibited in this mode.

The only controls available to the master are the Statistics Window and Interference Threshold attributes. They will have no effect on the operation of the wireless link and will only effect the generation of the channel spectrum graphics.

The active channel history menu is removed in this mode of operation as channel hopping is prohibited.

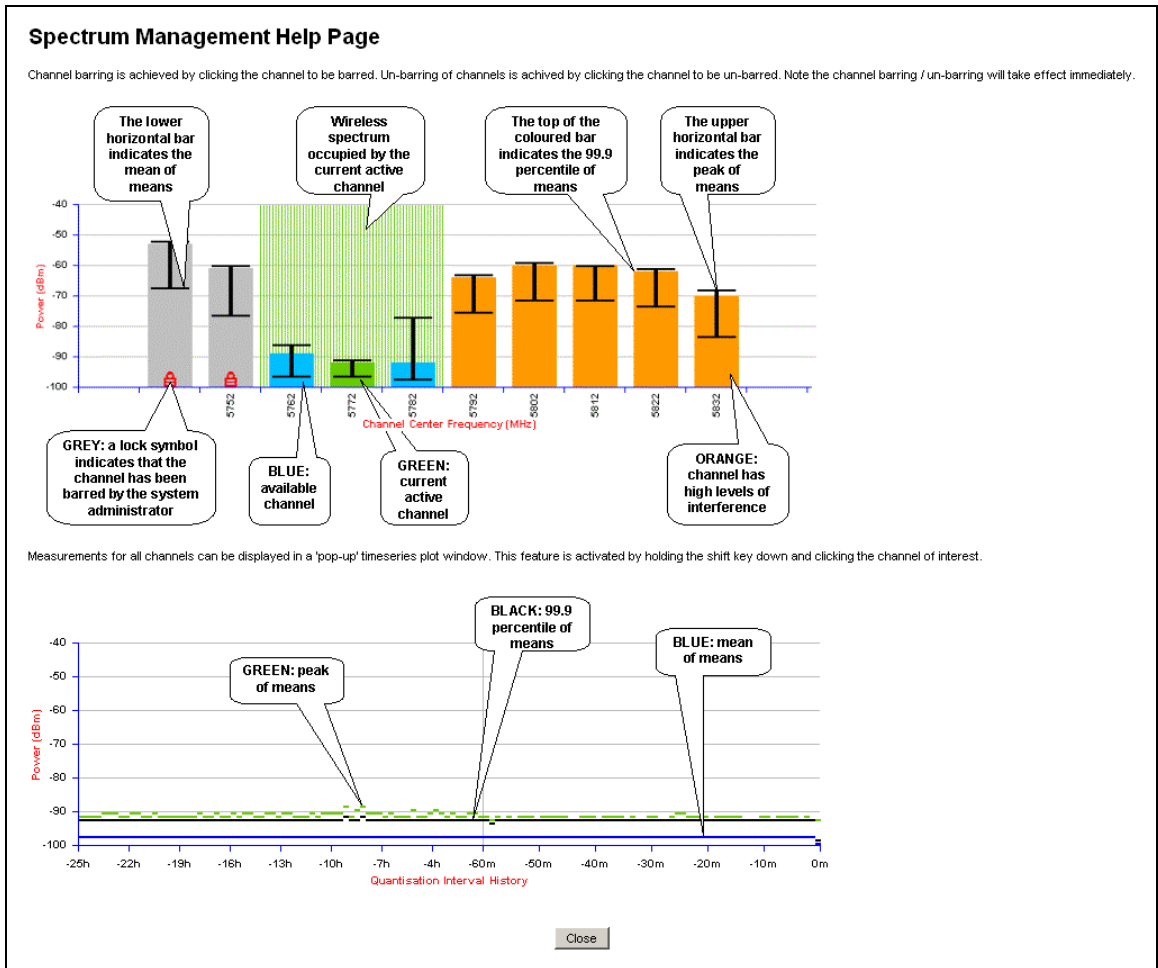

Figure 67 - Spectrum Management Help Page (Fixed Frequency)

8.3.9 Spectrum Management Control - With Operational Restrictions

When operating with Radar Avoidance enabled the following variances in operation apply:

- The words “Radar Avoidance” are appended to the “Spectrum Management” title at the top of the screen. See Figure 68 and Figure 69.
- The only controls available to the master are the Interference Threshold attribute. This has no effect on the operation of the wireless link and will only affect the generation of the channel spectrum graphics. See Figure 68.
- Extra color coding of the interference histogram is provided. See Table 13.

When operating with RTTT Avoidance enabled or other regulatory restrictions on channel usage the following variances apply:

- A channel marked with a ‘no entry’ symbol with their associated statistics colored black are the prohibited channels. See Figure 68 and Figure 69. These channels are never

used to host the wireless link, but CAC measurements are still taken so that adjacent channel biases can be calculated correctly and so the user can see if other equipment is in use.

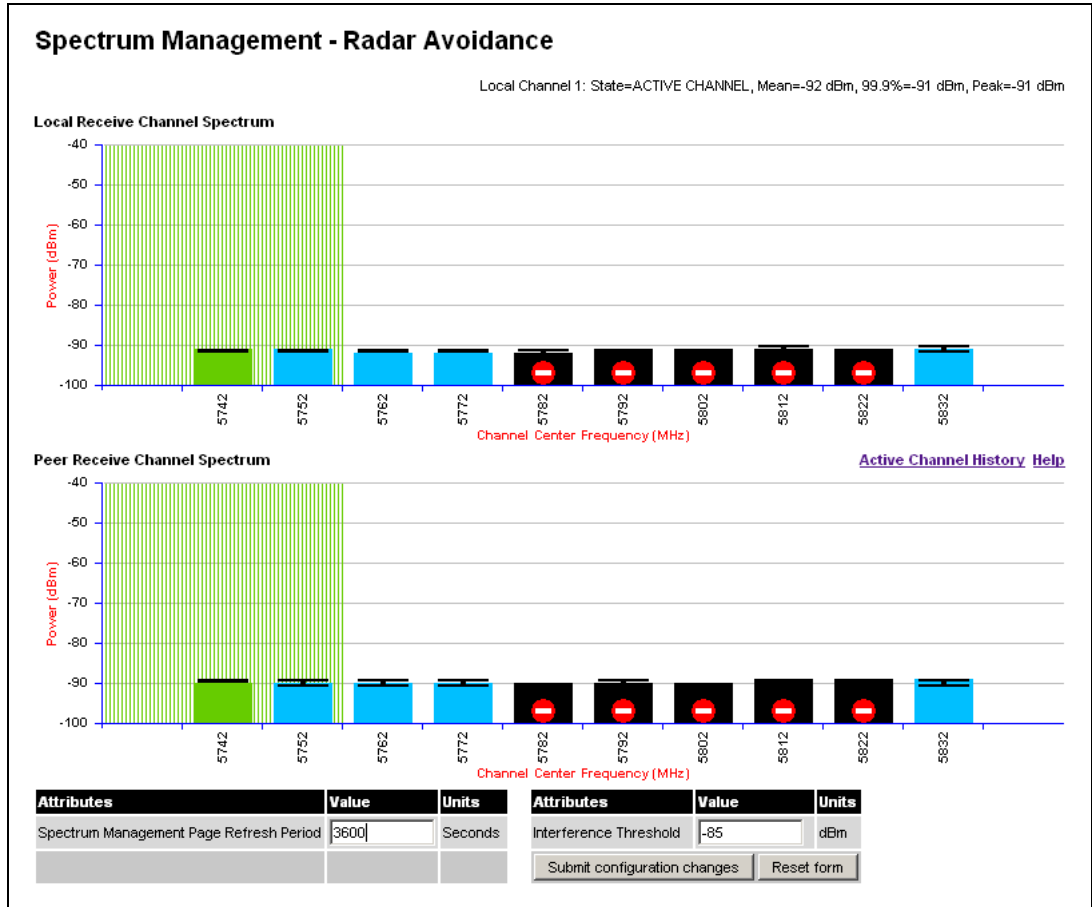

Figure 68 - Spectrum Management Master Screen With Operational Restrictions

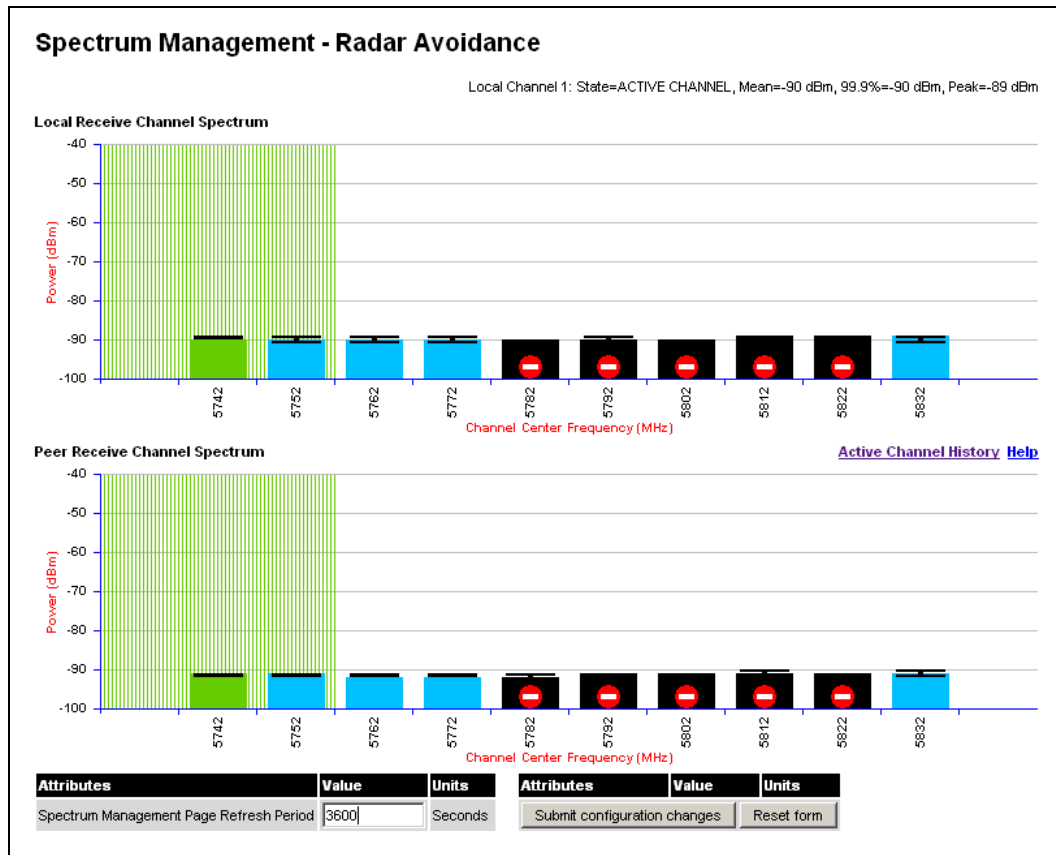

Figure 69 - Spectrum Management Slave Screen With Operational Restrictions

The colored bar represents the following channel state:

Green	Active	The channel is currently in use hosting the Point-to-Point wireless link
Orange	Interference	The channel has interference above the interference threshold
Blue	Available	The channel has an interference level below the interference threshold and is considered by the Spectrum Management algorithm suitable for hosting the Point-to-Point link
Grey	Barred	The system administrator has barred this channel from use. Because the low signal levels encountered when a unit is powered up in a laboratory environment prior to installation (which makes the grey of the channel bar difficult to see). An additional red 'lock' symbol is used to indicate that a channel is barred.
Red	Radar Detected	Impulsive Radar Interference has been detected on this channel.
Region Bar	Region Bar	This channel has been barred from use by the local region regulator

Table 13 - Spectrum Management Change State Key With Operational Restrictions

8.3.10 Remote Management Page

The Remote Management page (Figure 70) allows the system administrator to configure the remote management of the PTP 600 Series Bridge.

Remote Management

Simple Network Management Protocol (SNMP)

Attributes	Value	Units
SNMP State	<input checked="" type="radio"/> Disabled <input type="radio"/> Enabled	
SNMP Enabled Traps	<input checked="" type="checkbox"/> Coldstart	
	<input checked="" type="checkbox"/> PTP Link Status Change	
	<input checked="" type="checkbox"/> DFS Channel Change	
	<input checked="" type="checkbox"/> DFS Impulse Interference	
SNMP Trap Version	<input type="radio"/> SNMP version 1 <input checked="" type="radio"/> SNMP version 2c	
SNMP Trap IP Address	0 . 0 . 0 . 0	
SNMP Trap Port Number	162	
SNMP Community String	public	
SNMP Port Number	161	
VMAX MIB	<input checked="" type="radio"/> Disabled <input type="radio"/> Enabled	

Simple Mail Transfer Protocol (SMTP)

SMTP Email Alert	<input checked="" type="radio"/> Disabled <input type="radio"/> Enabled	
SMTP Enabled Messages	<input checked="" type="checkbox"/> PTP Link Status Change	
	<input checked="" type="checkbox"/> DFS Channel Change	
	<input checked="" type="checkbox"/> DFS Impulse Interference	
SMTP Server Port Number	25	
SMTP Server IP Address	0 . 0 . 0 . 0	
SMTP Source Email Address		
SMTP Destination Email Address		

Clock

SNTP State	<input checked="" type="radio"/> Disabled <input type="radio"/> Enabled	
Set Time	00 : 00 : 00	
Set Date	2005 Jan 1	
Time Zone	GMT 00.00	
Daylight Saving	<input checked="" type="radio"/> Disabled <input type="radio"/> Enabled	

Figure 70 - Remote Management



8.3.10.1 SNMP (Simple Network Management Protocol)

The industry standard remote management technique is SNMP (Simple Network Management Protocol). The PTP 600 Series Bridge supports version 1 and version 2c of the SNMP protocol.

8.3.10.2 Supported Management Information Bases (MIBS)

The PTP 600 Series Bridge SNMP stack currently supports three distinct MIBs:

- MIB-II, RFC-1213, The PTP 600 Series Bridge supports the 'System Group' and 'Interfaces Group'.
- Bridge MIB, RFC-1493, The PTP 600 Series Bridge supports the 'dot1dBase Group' and the 'dot1dBasePortTable Group'.
- PTP 600 Series Bridge proprietary MIB
- RFC-2233 (High capacity counter) MIB
- WiMAX MIB

SNMP TRAPs supported:

- Cold Start
- Link Up
- Link Down
- DFS Channel Change
- DFS Impulsive Interference

Motorola MIB, Proprietary MIB definition

For a copy of the Motorola proprietary version 1 and version 2 MIB RFCs please consult the installation CD.

8.3.10.3 SNMP Configuration

SNMP State: The SNMP state attribute controls the creation of the SNMP features. Changing the SNMP state attribute requires a mandatory reboot of the unit. Only when the SNMP state is enabled at system start-up will the SNMP processor task be created.

SNMP Enabled Traps: The SNMP Enabled Traps attribute controls which SNMP Traps the unit will send.

SNMP Community String: The SNMP community string acts like a password between the networks SNMP management entity and the distributed SNMP clients (600 Series bridge). Only if the community string is configured correctly on all SNMP entities can the flow of management information take place. By convention the default value is set to 'public'. When the community string is changed the system requires a mandatory reboot before the new string or phrase is adopted.

SNMP Port Number: Is the port the SNMP management agent is listening to for commands from an SNMP manager. The default value for this port number is 161.

SNMP Trap IP Address: Is the address of either the network SNMP manager or Trap receiver. When asynchronous events (Traps in SNMP terminology) are generated, the client unicasts these to this IP Address. When the address is changed the system requires a mandatory reboot before the setting is adopted

SNMP Trap Port Number: The SNMP Trap Port Number is the port number of either the networked SNMP manager or Trap receiver. By convention the default value for the port number is 162. When the port number is changed the system requires a mandatory reboot before the setting is adopted.

WiMAX Control: Enables and Disables the WiMAX (802.16) MIB. This control is only displayed when 'Fixed Frequency' is selected during installation.

8.3.10.4 SMTP (Simple Mail Transport Protocol)

The SMTP client is an alternative method for the 600 Series bridge to alert a system administrator when there are or have been system errors

SMTP Email Alert: This attribute controls the activation of the SMTP client.

SMTP Enabled Messages: The SMTP Enabled Messages attribute controls which email alerts the unit will send.

SMTP IP Address: The IP address of the networked SMTP server.

SMTP Port Number: The SMTP Port Number is the port number used by the networked SMTP server. By convention the default value for the port number is 25.

SMTP Source Email Address: The email address used by the 600 Series bridge to log into the SMTP server with. This must be a valid email address that will be accepted by your SMTP Server

SMTP Destination Email Address: The email address to which the 600 Series bridge will send the alert messages.

8.3.10.5 SNTP (Simple Network Time Protocol)

The SNTP client allows the 600 Series bridge to obtain accurate date and time updates from a networked timeserver. The system time is used for SNMP and event logging.

SNTP State: When enabled, the Remote Management web page permits the following attributes to be set:

SNTP IP Address: The IP address of the networked SNTP server.

SNTP Port Number: The port number of the networked SNTP server. By convention the default value for the port number is 123.

SNTP Poll Interval: The period at which the SNTP client polls the server for time correction updates. Default 1 hour. If for any reason an SNTP poll fails, the client will automatically perform 3 retries before waiting for the user defined poll period.

Time Zone: The time zone is a fixed offset from GMT that is added to the SNTP time to allow the expression of time in all geographic time zones.

Daylight Saving: Allows a fixed offset of one hour to be added to the SNTP time in order to reflect the local daylight saving time.

8.3.10.6 Setting the clock

The PTP 600 Series bridge has a system clock which can be used to supply accurate date and time information in the absence of a SNTP server. The system clock is battery backed and will continue to operate for several days if the 600 Series bridge has been switched off.

SNTP State: If the SNTP State is set to “Disabled”, see Figure 70, then the Remote Management web page allows the following attributes to be set:

Set Time: Shows the current time in 24 hour mode. The three editable fields display hours minutes and seconds.



Set Date: Displays the current date. The year, month and day can be set using the drop-down selection boxes.

Time Zone: See section 8.3.10.6.

Daylight Saving: See section 8.3.10.6.

8.3.11 Diagnostics

To further enhance the diagnostic capabilities of the PTP 600 Series, the storage of link performance histograms has been extended to 31. To optimize RAM (volatile memory) usage a cascading histogram approach has been adopted. The root histogram is identical to the histograms in 58100 that is data is stored for one hour at a resolution of one second. In 58100 the histograms were simple cyclic buffers which never stored more than the last one hour of data. The new cascading histogram approach daisy chains multiple histograms together. When the first histogram fills up the overflow from the first is used as an input to the next histogram in line. To optimize memory utilization a statistical analysis is performed on the overflow to reduce the amount of data to be stored. In the case of the PTP 600 Series the cascading histograms are defined as:

- Histogram 1: 1 hour at a resolution of 1 second
- Histogram 2: 24 hours at a resolution of 1 minute
- Histogram 3: 30 Days at a resolution of 1 hour

For example, when histogram 1 fills up and starts to overflow the first minute of overflow is analyzed and the maximum, minimum and mean over that minute are computed and inserted into histogram 2. When histogram 2 fills up and starts to overflow the first hour of overflow is analyzed and the maximum, minimum and mean over that hour is computed and inserted into histogram 3. When histogram 3 start to overflow the overflow data is simply discarded.

8.3.11.1 Diagnostic Plotter

New for the PTP 600 Series is the system administration diagnostic plotter facility see Figure 71.

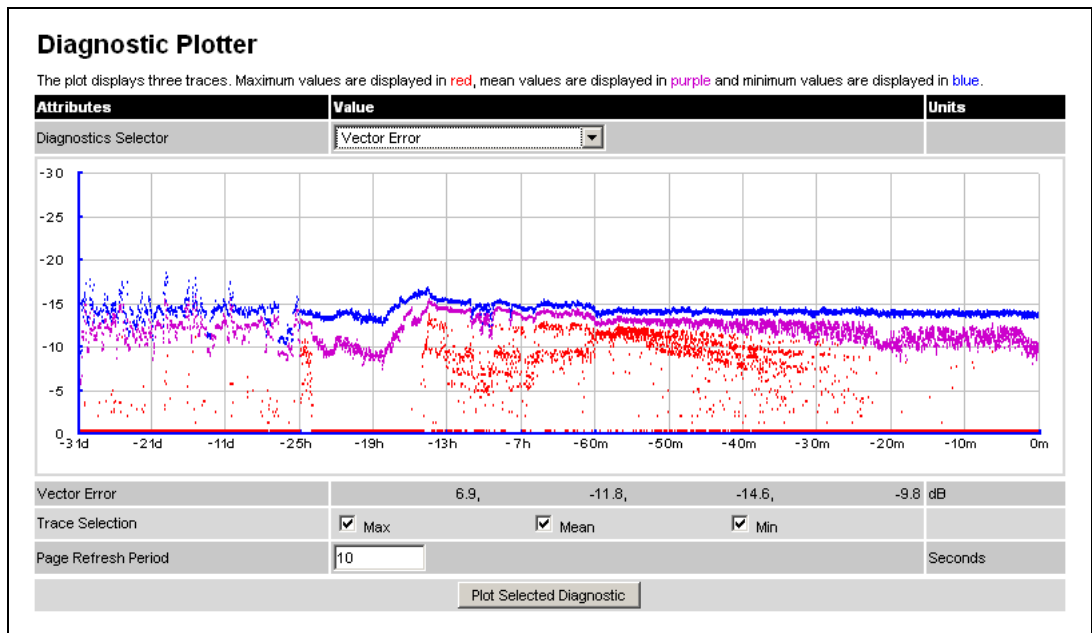

Figure 71 - Diagnostic Plotter

The diagnostic plotter allows the system administrator to view the cascading histogram data in an easily accessible graphical form. The plot always displays three traces, maximum, minimum and mean by default. The diagnostic selector allows the user to select the various categories of histogram.

The histograms that are available are:

- Vector Error
- Rx Power
- Tx Power
- Signal Strength Ratio
- Link Loss
- Rx Data Rate
- Tx Data Rate
- Aggregate Data Rate

The diagnostic plotter uses a novel time representation in the x-axis which compresses the timeline of the plot without sacrificing resolution.

The trace selection allows the user to control which traces are plotted.

As with other management pages the page refresh period can be used to interactively monitor the wireless link.

8.3.11.2 Diagnostics Download

The diagnostics Download page allows the system administrator to download snapshots of system diagnostics.

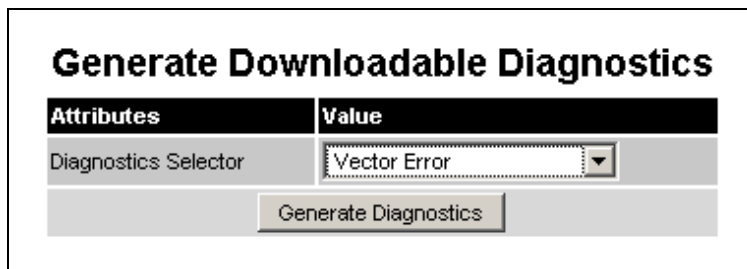

Attributes	Value
Diagnostics Selector	Vector Error

Generate Diagnostics

Figure 72 - CSV Download

The following diagnostics are available:

- Vector Error
- Rx Power
- Tx Power
- Signal Strength Ratio V/H
- Link Loss
- Rx Data Rate
- Tx Data Rate
- Aggregate Data Rate
- Receive SNR
- Rx Gain

All diagnostics are extracted from the associated status and statistics web page histograms. They are translated in a CSV file containing at most 5784²⁴ entries.

8.3.12 Change System Administration Password

This page (Figure 73) is used to change the password for the system administration (The factory default is blank).

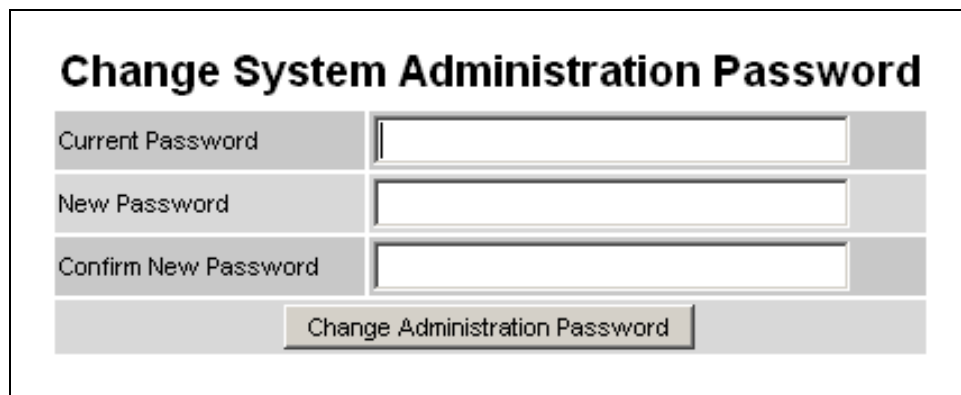

Change System Administration Password	
Current Password	<input type="text"/>
New Password	<input type="text"/>
Confirm New Password	<input type="text"/>
<input type="button" value="Change Administration Password"/>	

Figure 73 - Password Change

²⁴ 5784 entries comprises 3600 entries for the first hour, 1440 entries for the next 24 hours and 744 entries for the next 31 days.

To change the password any combination of alphanumeric characters, up to 31 characters in length, can be used.

8.3.13 License Key

The License Key data entry page allows the system administrator to update the 600 Series bridge license key. Figure 74 shows a sample license key data entry page.

Software License Key

A valid software license key is required before installation of the PTP (Point to Point) wireless link can commence. If you do not have a valid license key please contact your distributor.

License key data entry

Attributes	Value	Units
License Key	<input style="width: 90%;" type="text" value="3D7C-06FF-6596-BFB0"/>	

Capability summary

Attributes	Value	Units
Product Name	Motorola PTP 58600 Full	
MAC Address	00:04:56:80:0f:ff	
Region Code	1	
Frequency Variant	5800 MHz	

Figure 74 - Software License Key Data Entry

The user must enter the license key and click the 'Validate License Key' button to check that the key is valid and program it to non-volatile memory.

If a valid license key is detected then the user will be presented by a system reboot screen.

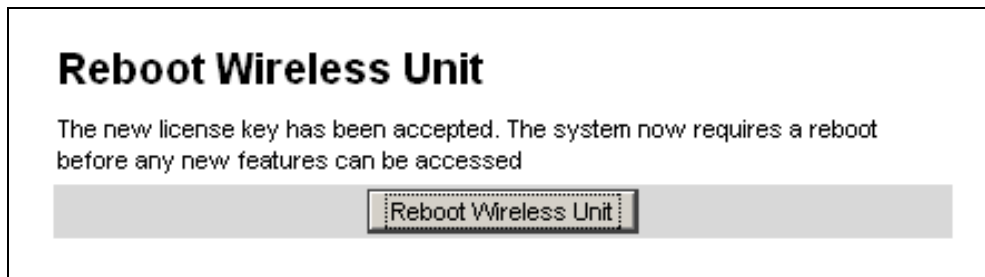

Figure 75: License Key reboot Screen

The user will then be asked to confirm the reboot (Figure 76).

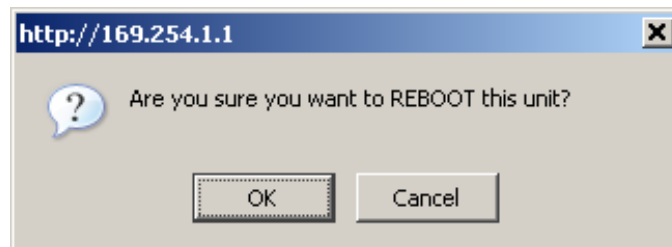
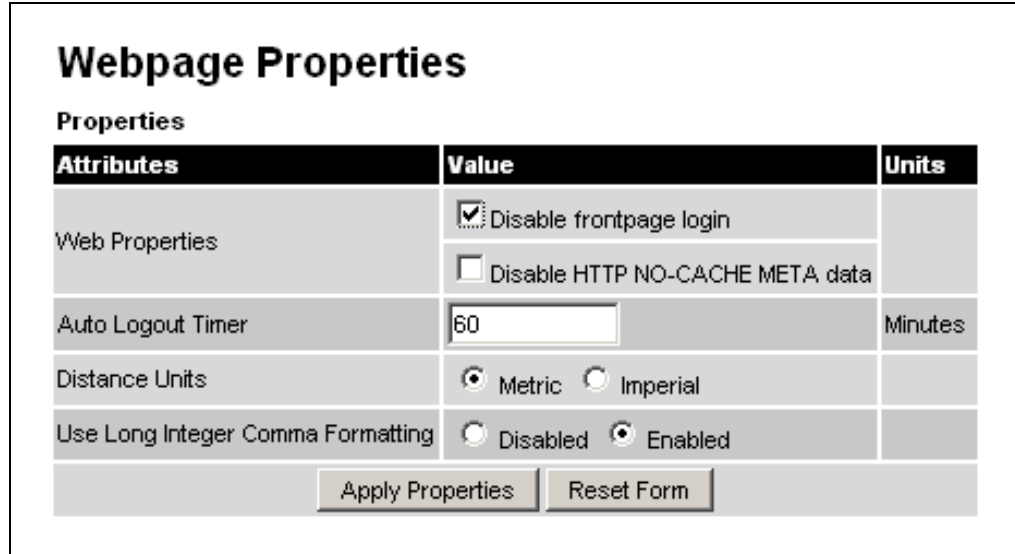

Figure 76 - Reboot Confirmation Pop Up

8.3.14 Properties

The web page properties screen allows the user to configure the web page interface.



Attributes	Value	Units
Web Properties	<input checked="" type="checkbox"/> Disable frontpage login	
	<input type="checkbox"/> Disable HTTP NO-CACHE META data	
Auto Logout Timer	60	Minutes
Distance Units	<input checked="" type="radio"/> Metric <input type="radio"/> Imperial	
Use Long Integer Comma Formatting	<input type="radio"/> Disabled <input checked="" type="radio"/> Enabled	

Apply Properties Reset Form

Figure 77 - Properties

WEB Properties: Disable Front Page Login Allows access to homepage and status page web pages without forcing a login as the system administrator.

WEB Properties: Disable HP NO-CACHE META data Removes the HTTP NO-CACHE META clause from all dynamically created web pages.

Auto Logout Timer Configures the time, in minutes, when the system administrator is automatically logged out if no web page activity is detected.

Distance Units Swaps the default metric display of distance in to imperial units, for example km to Miles.

Use Long Integer Comma Formatting Changes the format of long integers from 1000000 to 1,000,000.

8.3.15 Reboot

The reboot page allows the system administrator to perform commanded reboots of the wireless unit. The reboot page also allows the system administrator to view a list of past reboot reasons. The “Previous Reasons For Reset/Reboot” field has been implemented as a drop down selection box, where the latest reason for reboot is located at the top of the list.

If the SNTP service from the remote management section above is active, or the system time has been set, then the command reboot reason will be accompanied by the date and time at which the reboot occurred.

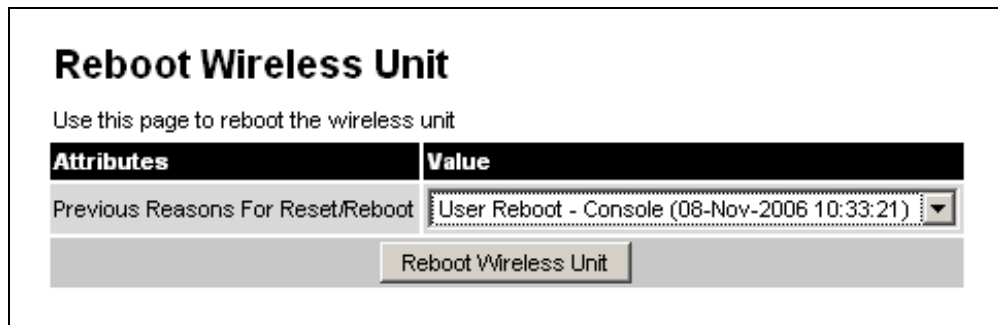

Attributes	Value
Previous Reasons For Reset/Reboot	User Reboot - Console (08-Nov-2006 10:33:21)

Reboot Wireless Unit

Figure 78 - System Reboot

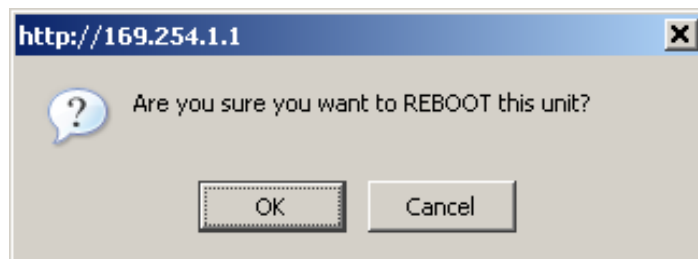

Figure 79 - Reboot Confirmation Pop Up

9 Recovery Mode

The Motorola PTP 600 point-to-point wireless Ethernet bridges have a special mode of operation that allows the user to recover a unit from configuration errors or software image corruption.

Recovery mode is entered by depressing the Recovery Switch located on the underside of the PIDU Plus while applying mains power, as shown in section 3.3.2. The Recovery Switch should be held in the depressed state for between 10 and 20 seconds after the application of mains power. The Ethernet LED will flash with 10 double flashes at power up.

When in recovery mode the user will be able to access the unit via the Ethernet interface. The Ethernet interface will have its IP address set to 169.254.1.1. On connection to a unit in recovery mode the following screen is displayed (Figure 80):



Figure 80 - Recovery Mode Warning Page

Clicking on the warning page image will take the user on to the Recovery Option Page (Figure 81).

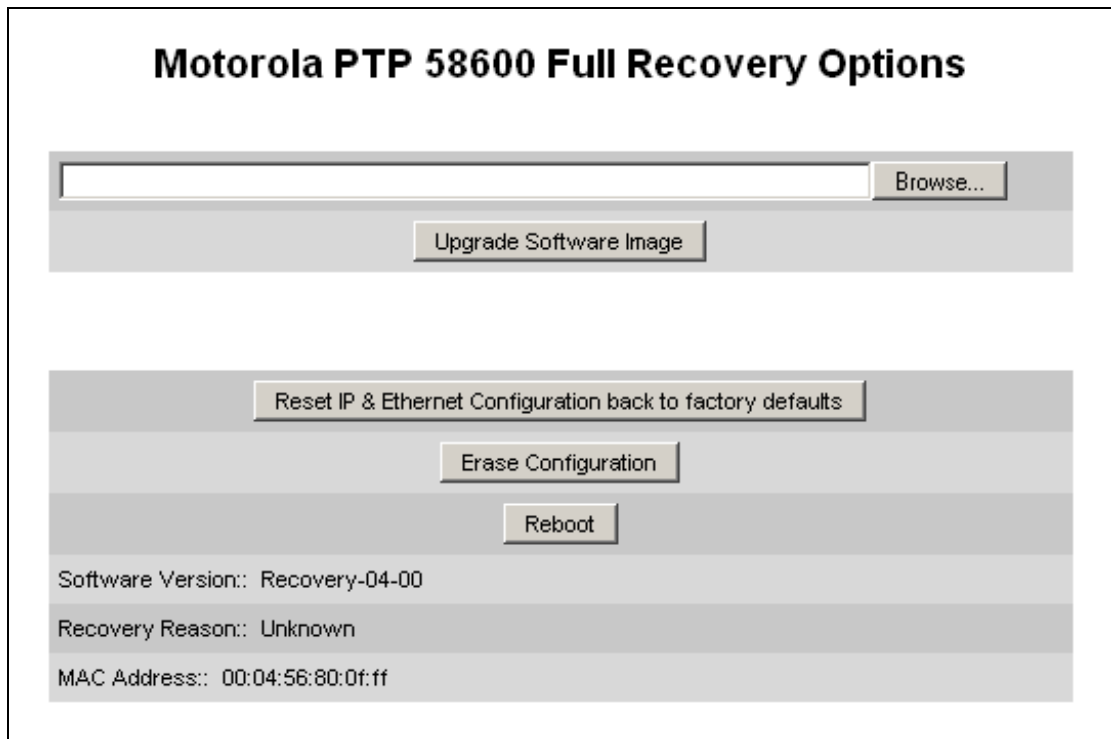

Figure 81 - Recovery Options Page

The recovery options available are:

Upgrade Software Image: This allows the user to reload a software image. This may be the original image if software corruption is suspected or a step back to an old image if an incorrect image has just been loaded.

Reset IP & Ethernet Configuration back to factory defaults: This allows the user to reset the unit back to the factory defaults:

- IP Address 169.254.1.1
- Netmask 255.255.0.0
- Gateway 169.254.1.0
- Ethernet Interface Auto-negotiate, Auto-MDI/MDIX

Erase Configuration: This allows the user to erase the unit’s entire configuration. Executing this option will also erase factory settings such as target MAC address, range setting, license key, etc.

Reboot: This allows the user to reboot the unit. This option must be executed after resetting the IP & Ethernet configuration or erasing the configuration detailed above.

Software Version: This is the software version of the recovery operating system permanently installed during manufacture.

Recovery Reason: Indicates the reason the unit is operating in Recovery mode. Possible reasons are “Recovery button active” or “Invalid or corrupt image”

MAC Address: The MAC address shown here is the MAC address of the unit programmed during manufacture.

9.1 Upgrade Software Image

The first step (Figure 81) is to use the ‘Browse’ button to locate the software image to be downloaded. Once located the user should press the “Upgrade Software Image” button to start the software download process.

During software download, progress is indicated by a pair of progress bars (Figure 82).

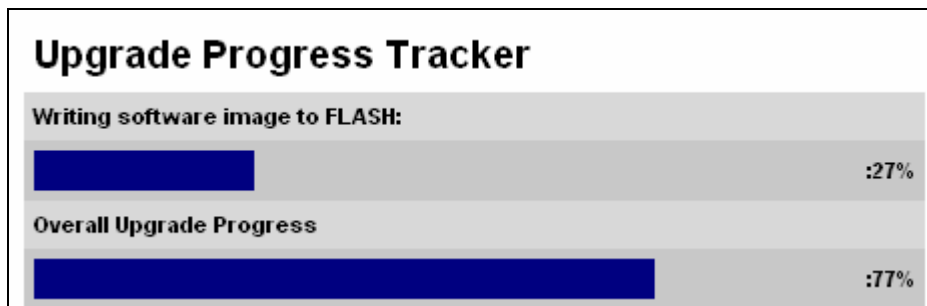

Figure 82 - Software Download Progress Indicator Page

When the download is complete a page is displayed indicating the status of the software download (Figure 83).



Figure 83 - Software Download Complete Page

After carefully checking that correct image has been downloaded the user should reboot the unit by pressing the "Reboot Wireless Unit" button. The user will then be presented with a pop up box asking them to confirm the action (Figure 84)

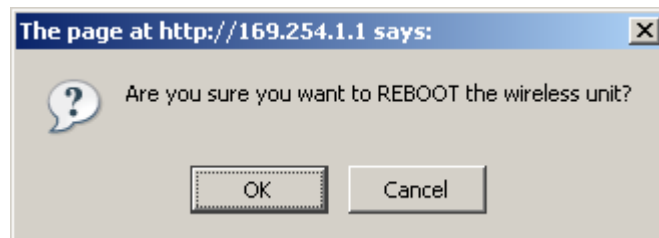

Figure 84 - Reboot Confirmation Pop Up

The unit will now reboot. Providing the unit configuration is still intact the unit should restart in normal operational mode and the link should recover. Should the unit or link fail to recover the user should refer to section 10.

9.2 Reset IP & Ethernet Configuration

To reset IP & Ethernet configuration back to factory defaults the user should press the “Reset IP & Ethernet Configuration back to factory defaults” button on the “Recovery Options” page (Figure 81). The user will now be presented with a pop up box asking them to confirm the action (Figure 85).

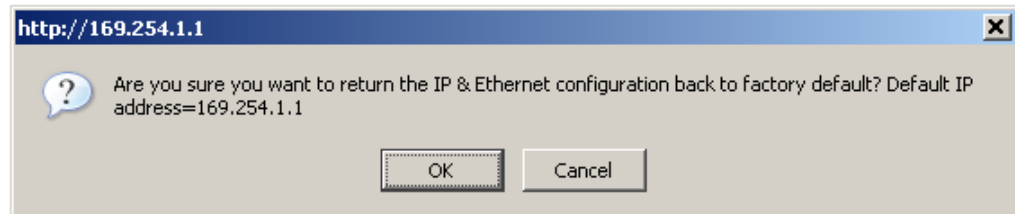

Figure 85 - Confirm Reset to Factory Default Pop Up

On confirmation the following page will be displayed (Figure 86). The user should now reboot the unit by pressing the “Reboot” button.

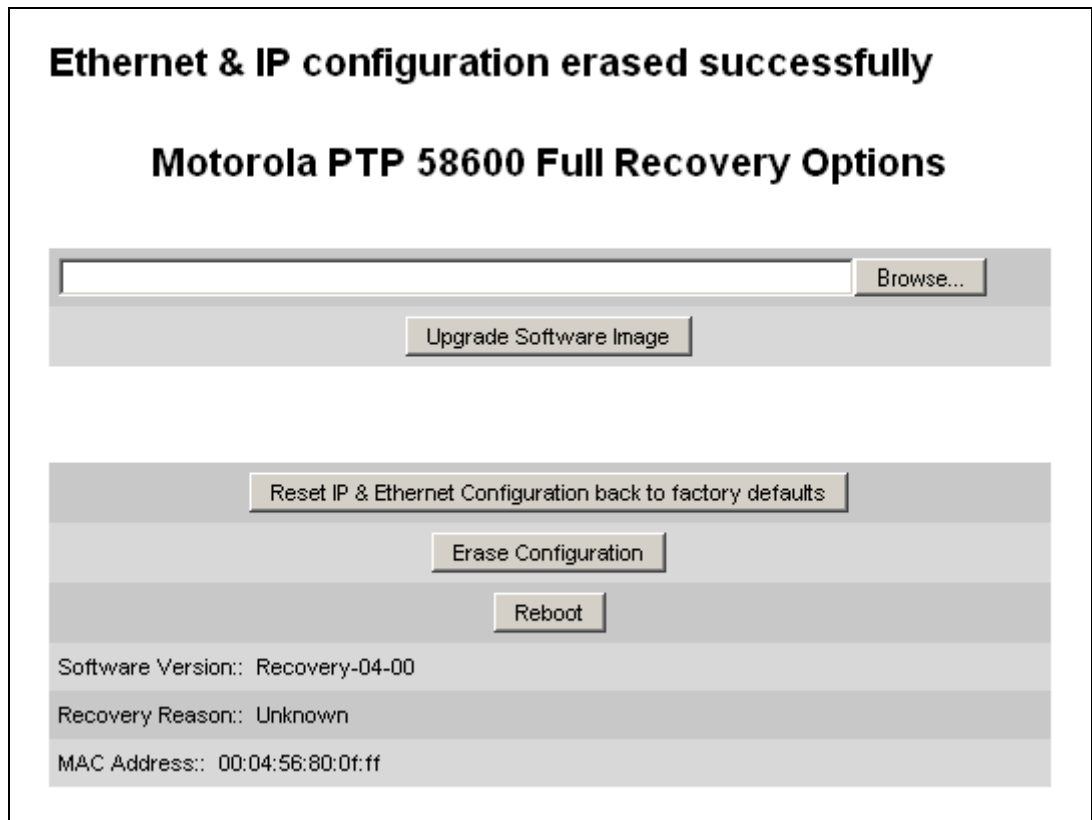

Figure 86 - IP and Ethernet Erased Successfully page

The user will now be presented with a pop up box asking them to confirm the action (Figure 87)

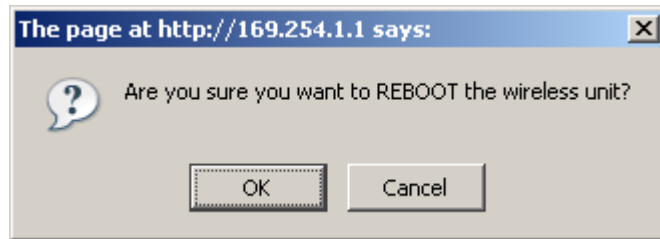

Figure 87 - Reboot Confirmation Pop Up

The unit will now reboot. The unit should now start up in normal mode but with the IP address set to 169.254.1.1 and the Ethernet interface set to auto-negotiate and auto-MDI/MDIX. Should the unit fail to start up the user should refer to section 10.

9.3 Erase Configuration

To erase the unit's configuration the user should press the "Erase Configuration" button on the "Recovery Options" page (Figure 81). The user will now be presented with a pop up box asking them to confirm the action (Figure 88).

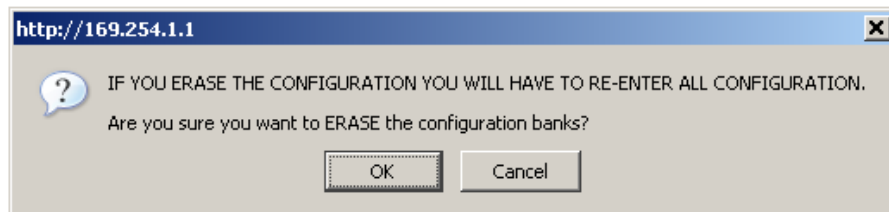

Figure 88 - Confirm Erase Configuration Pop Up

On confirmation the following page will be displayed (Figure 89). The user should now reboot the unit by pressing the “Reboot” button.

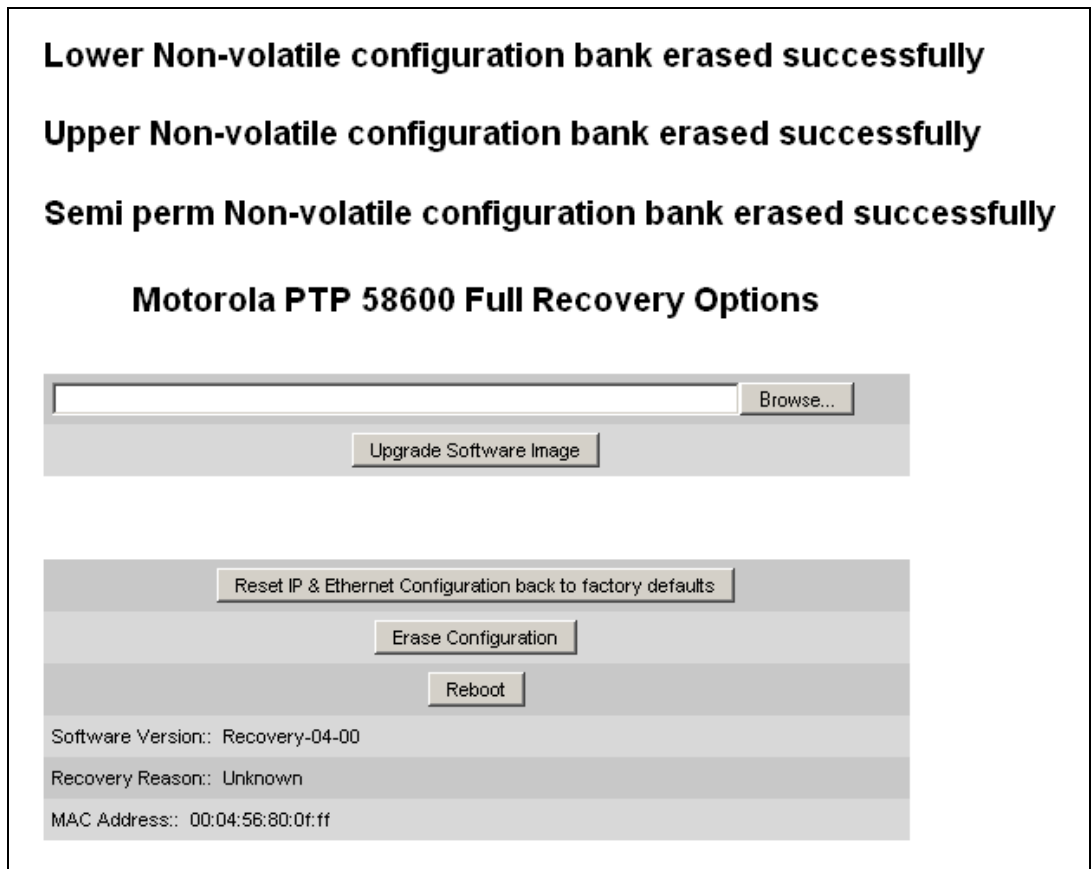

Figure 89 - Erase Configuration Successful Page

The user will now be presented with a pop up box asking them to confirm the action (Figure 90)

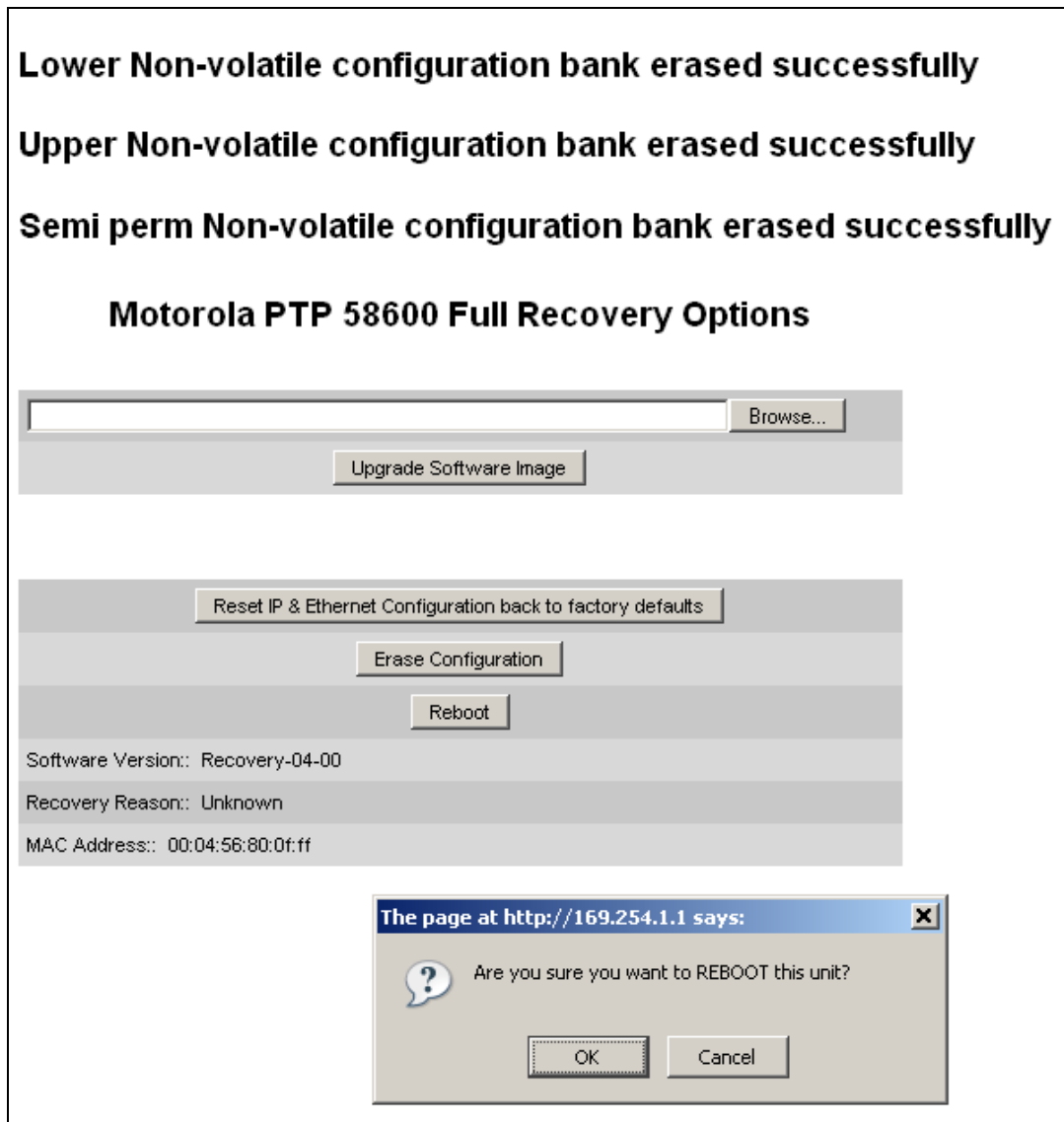

Figure 90 - Reboot Confirmation Pop Up

The unit will now reboot. The unit should now start up in normal mode but with all configuration erased. Should the unit fail to start up the user should refer to section 10.

9.4 Reboot

To erase the unit's configuration the user should press the "Reboot" button on the "Recovery Options" page (Figure 81). The user will now be presented with a pop up box asking them to confirm the action (Figure 91).

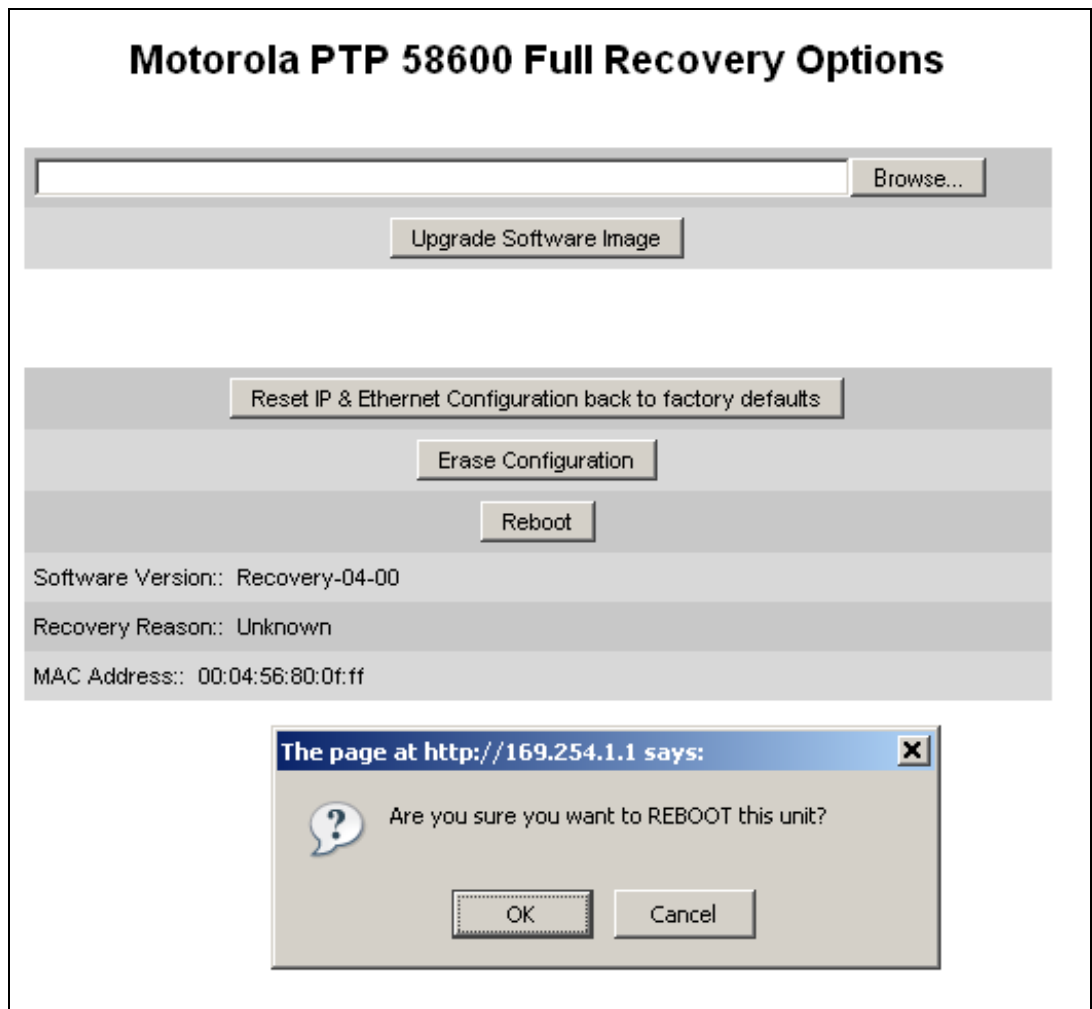

Figure 91 - Reboot Confirmation Pop Up

The unit will now reboot. The unit should now start up in normal operational mode. Should the unit fail to start up the user should refer to section 10.

10 Fault Finding

If communication has been lost with the unit at the near end of the link then there may be a hardware fault with the wiring, network or hardware. Go to the hardware section below. If communication with the far end of the link is lost then go to the radio section below.

10.1 Hardware

If there are problems suspected with the link hardware the following procedure is recommended.

The following diagram illustrates the main system connections:

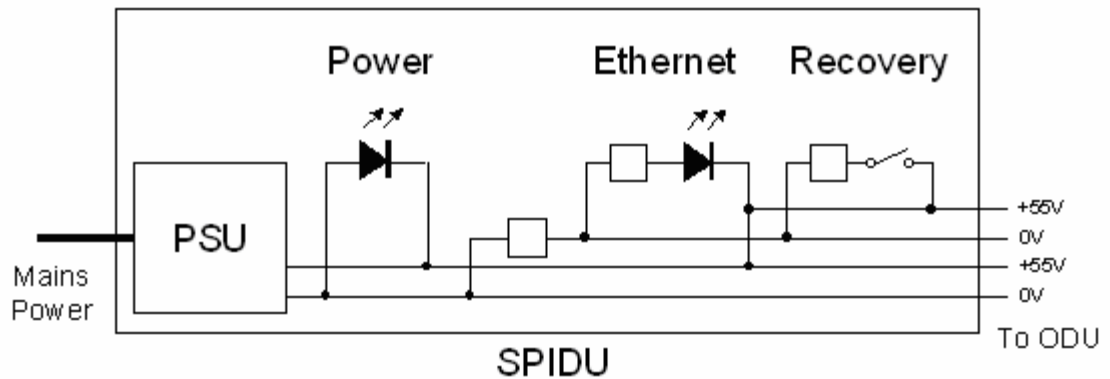

Figure 92 - Main System Connections

10.1.1 Power

Check the power LED at each end of the link. If the power lights are illuminated go to the Ethernet section below. If at either end they are not illuminated then²⁵ check the Ethernet LED.

²⁵ The power indicator LED should be continually illuminated.

If neither is illuminated then there is no voltage on the power wires to the ODU.

- Check that the mains power is connected and switched on.
- Check that the lamp illuminates if the ODU connector is disconnected at the PIDU Plus (Remove the PIDU Plus cover).

If it does illuminate then either the ODU is drawing too much current, or the power wiring to the ODU is short circuit or the PSU is supplying insufficient power. The likely fault can be determined by removing the jumper (J906), found inside the removable cover of the PIDU Plus, and measuring the current taken with an ammeter placed across the 2 jumper pins. This is normally 10mA without the ODU connected and 300mA to 1A when the ODU is connected.

If it does not illuminate then recheck that power is applied to the PIDU Plus by measuring the voltage across +55V and 0V pads inside the removable cover in the PIDU Plus. Check that the PIDU Plus is not short circuit by measuring the impedance across the Power connector. Is the lamp faulty?

10.1.2 Ethernet

The Ethernet LED is driven from the ODU processor and thus is capable of informing you of many conditions using different flash sequences. If the Ethernet indicator does not illuminate at all there are four possible conditions.

- There is no power reaching the ODU because of a wiring fault
- The ODU is faulty
- The PIDU Plus is faulty
- The Ethernet network side is faulty

Look at the following table to check the LED response for power up, disconnect the power and reapply and note what happens.

Differentiating between 1-3 and 4 can be achieved by removing the power for 1 second. Watch the Ethernet indicator for 1 minute, if it never flashes then the problem is 1-3. Take the jumper (J906) out of the PIDU Plus and check the current taken by the ODU. This should be 300mA to 1A when starting to running normally.

If the Ethernet indicator flashes to begin with but then stops flashing, the ODU is powered and software loaded but Ethernet connectivity has been lost between the ODU and the users connected equipment. All Ethernet connections should be rechecked.

Power Indoor Unit LED check chart:

Mode	Green LED	Yellow LED No Ethernet Cable Connected	Yellow LED Ethernet Cable Connected between PIDU Plus and NIC/Switch/Hub
No Power Applied	Off	Off	Off
Power Applied	On	Will flash once per second regularly approximately 30 seconds after power applied for 10 seconds then will go out and stay out	Will flash once per second regularly approximately 30 seconds after power applied for 10 seconds then operate as Ethernet Link/Activity LED
Valid Ethernet Link and no traffic	On	N/A	Will be on solid for a valid link.
Valid Ethernet Link with traffic	On	N/A	Will be on solid, but will blink randomly as traffic passes through
Recovery Switch Pressed and held for >10 seconds from power on (Recovery is pressed while power is applied)	On	Off while switch pressed. Approximately 30 seconds after releasing the switch, flashes twice per second regularly for 10 seconds, then boots in "Recovery Mode" While in "Recovery Mode" the unit will only be accessible via the IP address 10.10.10.10.	

10.1.3 Checking your wiring

If the above procedures fail to diagnose the issue you may have a wiring fault. Unplug the RJ45 from the PIDU+ and check the following resistances at the RJ45:

1. Check the cable resistance between pins 1 & 2, 3 & 6, 4 & 5 and 7 & 8 at the RJ45. Check against column 2 in Table 14.
2. Check the cable resistance between pins 1 & 3 at the RJ45. Check against column 3 in Table 14.
3. Check the cable resistance between pins 4 & 7 at the RJ45. Check against column 4 in Table 14.
4. Ensure that there is greater than 100K ohms between pins 1 & 8 for all cable lengths.

5. Ensure that there is greater than 100K ohms between pin 1 and ODU ground for all cable lengths.
6. Ensure that there is greater than 100K ohms between pin 8 and ODU ground for all cable lengths

CAT-5 Length (Meters)	Resistance between pins 1 & 2, 3 & 6 , 4 & 5 and pins 7 & 8 (ohms)	Resistance between pins 1 & 3 (ohms)	Resistance between pins 4 & 7 (ohms)
0	0.8	1.0	1.6
10	2.5	2.7	3.3
20	4.2	4.4	5.0
30	5.9	6.1	6.7
40	7.6	7.8	8.4
50	9.3	9.5	10.1
60	11.0	11.2	11.8
70	12.7	12.9	13.5
80	14.4	14.6	15.2
90	16.1	16.3	16.9
100	17.8	18.0	18.6

Table 14 - Resistance Table Referenced To The RJ45 at the PIDU+

10.2 Radio

10.2.1 No Activity

If communication over the radio link has been lost and the unit at the other end of the link can be managed on its local network, the following procedure should be adopted:

If there is no wireless activity then the configuration should be checked. It is essential that the following items are correct:

- Check for Alarm conditions on Home page
- Check that the software at each end of the link is the same version
- Check that the Target Mac address has not been mis-configured at each end of the link.
- Check Range
- Check Tx Power



- Check License key
- Check Master Slave
- Check that the link has not been further obscured or the ODU misaligned.
- Check the DFS page at each end of the link and establish that there is a quiet wireless channel to use.

If there are no faults found in the configuration and there is absolutely no wireless signal retry the installation procedure. If this doesn't work then the ODU may be faulty.

10.2.2 Some Activity

If there is some activity but the link is unreliable or doesn't achieve the data rates required then:

- Check that the interference has not increased using the i-DFS measurements
- If a quieter channel is available check that it is not barred
- Check that the path loss is low enough for the communication rates required
- Check that the ODU has not become misaligned

11 Lightning Protection

EMD (Lightning) damage is not covered under warranty

The recommendations in this user manual when installed correctly give the user the best protection from the harmful effects of EMD
However 100% protection is not implied or possible

11.1 Overview

The idea of lightning protection is to protect structures, equipment and people against lightning by conducting the lightning current to ground via a separate preferential solid path and by reducing the electromagnetic field.

The following should be treated as a guide only, the actual degree of lightning protection required depends on local conditions and weather patterns and applicable local regulations. Full details of lightning protection methods and requirements can be found in the international standards IEC 61024-1 and IEC 61312-1, the U.S. National Electric Code ANSI/NFPA No. 70-1984 or section 54 of the Canadian Electric Code.

11.1.1 Lightning Protection Zones

The installation of the ODU can be classified into two different lightning protection zones.

Zone A — In this zone a direct lightning strike is possible.

Zone B — In this zone a direct lightning strike is unusual, but the un-attenuated electromagnetic field is still present.

The zones are determined using the 'rolling sphere method', an imaginary sphere, typically 50 meter in radius is rolled over the structure. All structure points that contact the sphere, (Zone A) indicate the zone where a direct strike is possible. Similarly points that do not contact the sphere indicate a zone (zone B) where a direct strike is less likely.

The following diagrams (Figure 93 & Figure 94) show this zoning pictorially:

Equipment mounted in Zone A should be capable of carrying the full lightning current. Mounting of the ODU in Zone A is not recommended. Mounting in Zone A should only be carried out observing the rules governing installations in Zone A²⁶. Failure to do so may put structures, equipment and life at risk.

Equipment mounted in Zone B should be grounded using grounding wire of at least 10 AWG. This grounding wire should be connected to a grounding rod or the building grounding system before entry in to building.

The 600 Series bridge ODU grounding point can be found on the bottom of the unit. The 600 Series Bridge is supplied with an appropriate grounding lug for attachment to the ODU.

11.2 Detailed Installation

The recommended components for an installation protected for nearby strikes are:

- Grounding Kits — Andrew Type 223158-2 (<http://www.andrew.com>)
- Screened CAT 5e Cable also known as Shielded CAT 5e or CAT 5e STP (Shielded Twisted Pair)
- NB: Only use Outdoor rated, gel filled CAT5e if it contains a shield.
- Surge Arrestor: Transtector Type ALPU-ORT - 4 per link (www.transtector.com)
- Grounding Stake
- RJ45 screened connectors
- 8 AWG Grounding Cable – Minimum size, preferably 6 or 4

NOTE: There may be a local regulatory requirement to cross bond the CAT 5e cable at regular intervals to the mast. This may be as frequent as every 10 meters (33 feet)

²⁶ Local regulations may also require the fitting of the 8 AWG ground wire referred below.

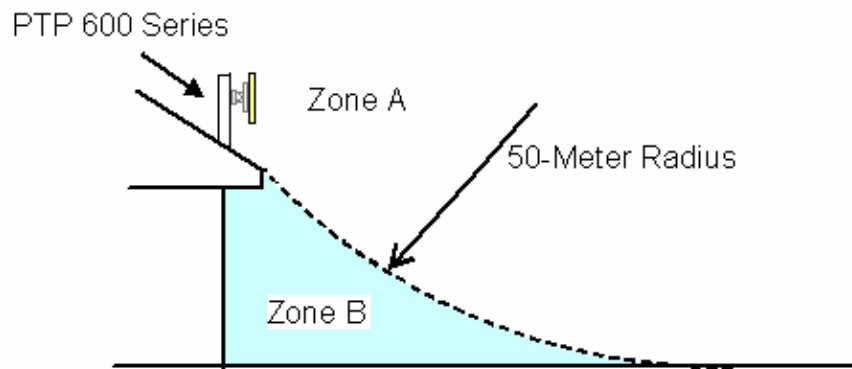
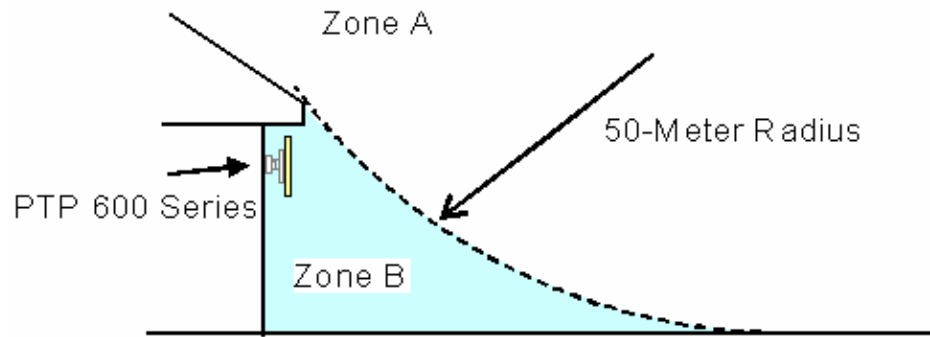

Figure 93 - ODU mounted in Zones A & B

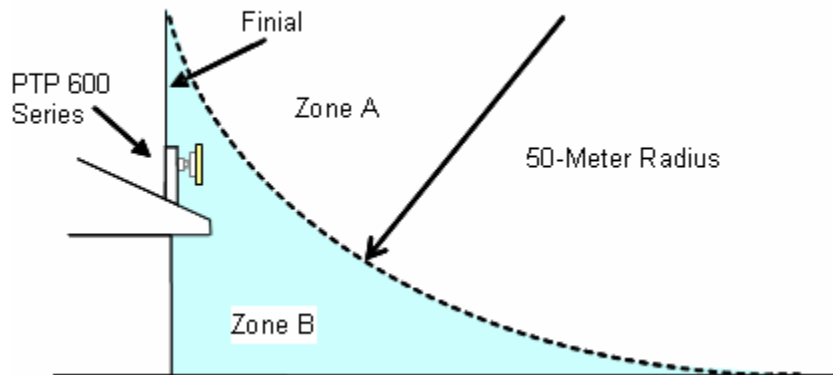

Figure 94 - Showing how the use of a Finial enables the ODU to be mounted inside Zone B

	Zone A	Zone B
Earth ODU	Mandatory	Mandatory
Screen Cable	Mandatory	Mandatory
Surge Arrestor Unit at ODU – ALPU-ORT	Mandatory	Mandatory
Earth Cable at Building Entry	Mandatory	Mandatory
Surge Arrestor Unit at Building Entry – ALPU-ORT	Mandatory	Mandatory

Table 15 - Protection Requirements

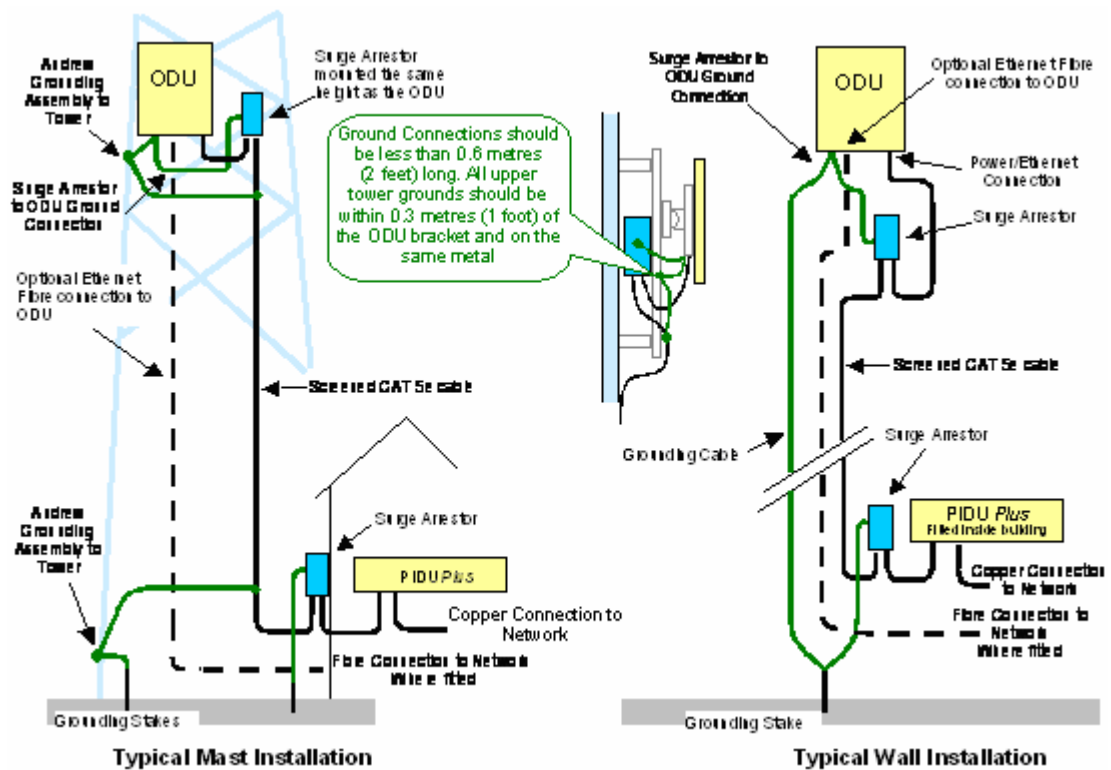

Figure 95 - Diagrammatically showing typical wall and mast installations

A typical installation is shown in Figure 96 and Figure 97.

Note: Grounding Points are shown unprotected for clarity. Grounding points should be adequately weatherproofed to prevent corrosion and possible loss of ground continuity.



Figure 96 - Upper Grounding Configuration



Figure 97 - Lower Grounding Configuration

An Andrew Grounding Kit and Surge Arrestor Unit must be located at the ODU and reliably grounded as shown in Figure 95. There may also be a regulatory requirement to crossbond the screened CAT-5 at regular intervals up the mast. Refer to local regulatory requirements for further details.

A second Surge Arrestor Unit should be mounted at the building entry point and must be grounded.

The termination of the CAT-5 Cable into the Surge Arrestor Unit is illustrated in Table, Table 17 and Figure 98. The screen from the cable must be terminated into the ground terminal within the unit to ensure the continuity of the screen. Earth Sleeving should be used to cover the shield ground connection to prevent internal shorting within the unit.

Terminal Identification	Conductor	RJ45 Pin
CON3 Pin 1	Orange/White	1
CON3 Pin 2	Orange	2
CON3 Pin 3	Green/White	3
CON3 Pin 6	Green	6
CON1 Pin 4	Blue	4
CON1 Pin 5	Blue/White	5
CON1 Pin 7	Brown/White	7
CON1 Pin 8	Brown	8

Table 16 - Surge Arrestor ALPU-ORT Cable 1 Termination

Terminal Identification	Conductor	RJ45 Pin
CON4 Pin 1	Orange/White	1
CON4 Pin 2	Orange	2
CON4 Pin 3	Green/White	3
CON4 Pin 6	Green	6
CON2 Pin 4	Blue	4
CON2 Pin 5	Blue/White	5
CON2 Pin 7	Brown/White	7
CON2 Pin 8	Brown	8

Table 17 - Surge Arrestor ALPU-ORT Cable 2 Termination

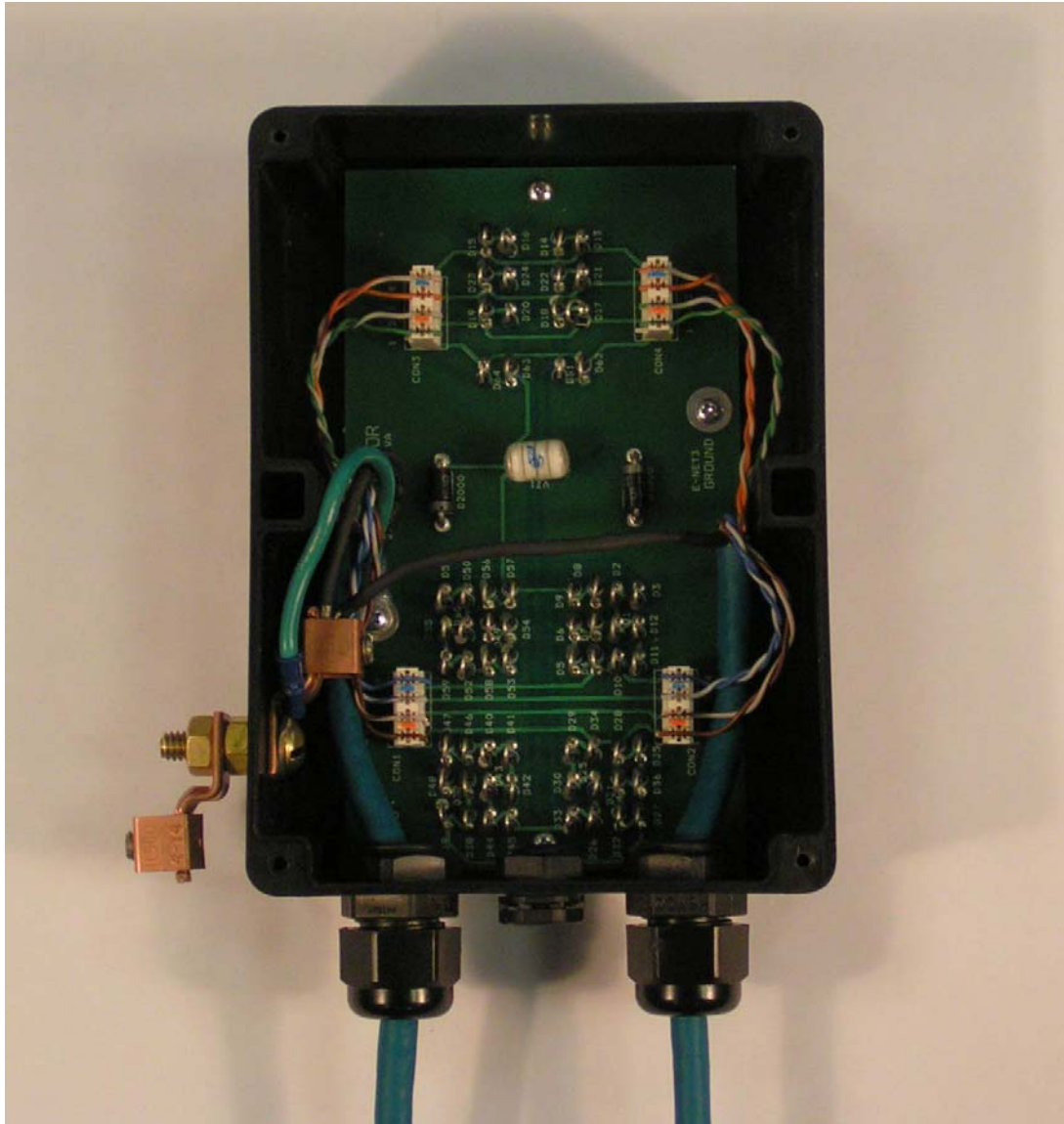

Figure 98 - Surge Arrester ALPU-ORT Connection Illustration

Note: Cable screens have been sleeved.

11.3 Testing Your Installation

If you have followed the above instructions you will have wired your system to the following diagram:

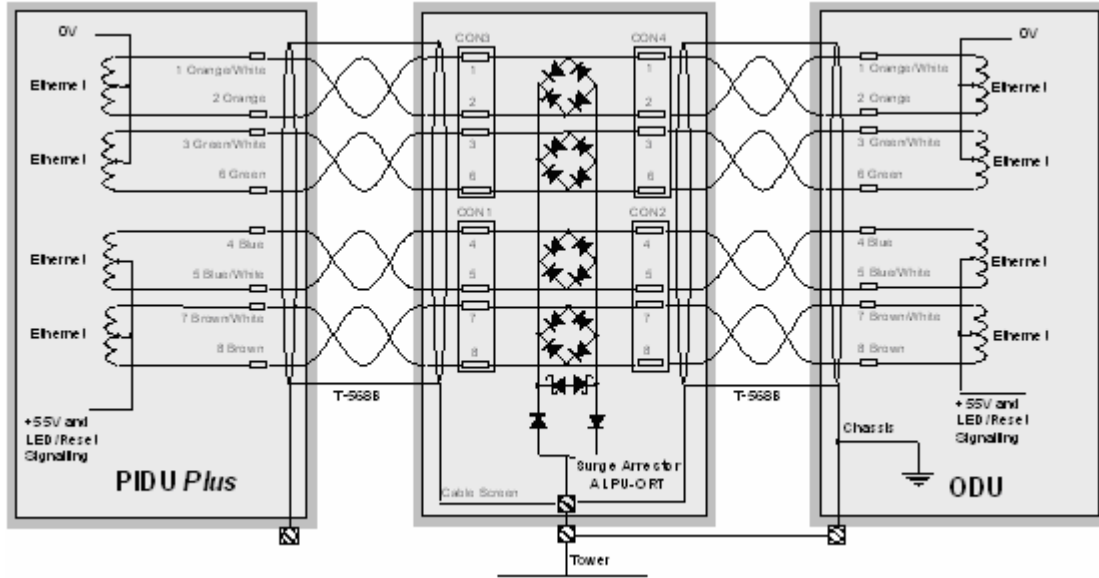

Figure 99 - Simplified Circuit Diagram (Only One Transtector Shown For Clarity)

11.3.1 Pre-Power Testing

Before plugging in the RJ45 to the PIDU check the impedances at the RJ45 as described in 10.1.3.

11.3.2 Post-Power Testing

The Correct Operation is as follows

1. Connect the RJ45 to the PIDU and apply power to the PIDU, the power LED should illuminate continuously.
2. 45 seconds after powering, the Ethernet LED should be observed starting with 10 slow flashes.
3. If there is a network connection the Ethernet LED will then show Ethernet activity.

The Ethernet LED does not flash 10 times

Failure of the Ethernet LED to illuminate can be due to wiring to pins 4&5 and 7&8 being incorrect, for example if the wiring to pins 4 and 7 are crossed.



The Ethernet LED flashes ten times but irregularly

Irregularly flashing, seen as a short gap followed by a long gap, indicates that the ODU has booted in recovery mode. This may be due to either the installation wiring or a corrupted main code image in the ODU.

The Ethernet LED flashes ten times but does not show Ethernet activity

Failure of the Ethernet LED to show Ethernet activity can be due to wiring to pins 1&2 and 3&6 being incorrect, for example if the wiring to pins 1 and 3 are crossed.

The Ethernet connection to the network is only 10/100 BaseT, when 1000 BaseT was expected

It is likely there is a fault with the wiring to pins 4&5 and 7&8.

12 Wind Loading

12.1 General

Antennas and electronic equipment mounted on towers or pole mounted on buildings will subject the mounting structure to lateral forces when there is appreciable wind. Antennas are normally specified by the amount of force (in pounds) for specific wind strengths.

The magnitude of the force depends on both the wind strength and size of the antenna.

12.2 Calculation of Lateral Force

The 600 Series bridge with or without the integral antenna is essentially a flat structure and so the magnitude of the lateral force can be estimated from:

$$\text{Force (in pounds)} = 0.0042 \cdot A \cdot v^2$$

Where A is the surface area in square feet and v is the wind speed in miles per hour.

The lateral force produced by a single 600 Series bridge (integrated or connectorized model) at different wind speeds is shown in Table 18 and Table 19.

	Largest Surface Area (sq ft)	Lateral Force (Pound) at wind speed (mph)				
		80	100	120	140	150
PTP 600 Series Bridge - Integrated	1.36	37	57	82	112	129
PTP 600 Series Bridge - Connectorized	1.00	27	42	60	82	95

Table 18 - Lateral Force – Imperial

	Largest Surface Area (sq m)	Lateral Force (kg) at wind speed (m/s)				
		30	40	50	60	70
PTP 600 Series Bridge - Integrated	0.130	12	22	34	49	66
PTP 600 Series Bridge - Connectorized	0.093	9	16	24	35	48

Table 19 - Lateral Force – Metric

Note: When the connectorized version of 600 Series bridge is used with external antennas, the figures from the antenna manufacturer for lateral force should be included to calculate to total loading on the mounting structure.

12.3 Capabilities of the PTP 600 Series Bridges

The structure and mounting brackets of the PTP Series systems are capable of withstanding wind speeds up to 151mph (242 kph). The installer should ensure that the structure to which the 600 Series bridge is fixed to is also capable of withstanding the prevalent wind speeds and loads.

12.4 Wind Speed Statistics

Installers are recommended to contact the national meteorological office for the country concerned to identify the likely wind speeds prevalent at the proposed location. This will enable the installer to estimate the total wind loading on the support structures.

Examples of the sort of statistics that are available are:

USA - Reported Fastest Single Wind Velocities for Selected U.S. Cities

(Source: National Weather Service)

City, State	Wind Velocity (mph)
Bismarck, North Dakota	72
Buffalo, New York	91

Chicago, Illinois	87
Hatteras, North Carolina	110
Miami, Florida	132
New York, New York	99
Pensacola, Florida	114

UK Meteorological Office, www.metoffice.gov.uk

Peak wind speed contour maps can be found as Fig 3a/3b at:

<http://www.metoffice.gov.uk/education/historic/1987.html>

13 PTP 600 Series Bridge – Connectorized Model

13.1 Scope

This section details the changes and additional features relevant to the connectorized version of the PTP 600 Series systems.

NOTE: The PTP54600 product does not have approval in the USA and Canada to operate with external antennas and connectorized versions of the PTP54600 are not shipped to USA and Canada. Therefore, this section of the Manual does not apply to PTP54600 in USA and Canada.

13.2 Product Description

13.2.1 Hardware

The Connectorized PTP 600 Series bridge is a variant designed to provide the system integrator and installer with the ability to provide extra capability to cope with very difficult radio links compared to the PTP 600 Series Integrated model. The variant allows the use of a variety of externally mounted antennas, either Flat Plate or Dish, which have higher gains than provided by the integrated antenna that is normally used.



Figure 100 – Connectorized 600 Series Bridge Outdoor Unit

13.2.2 Antenna Choices – 5.8 GHz

The integrated antenna has a gain of 23 dBi.

In non-FCC regions antenna choice is not restricted but any region specific EIRP limit should be obeyed, see Table 6 in section 5.2 “Region Codes”

In FCC regions external antennas from the list in Section 13.7 “Antennas for USA / Canada” can be used with the Connectorized version of the 600 Series Bridge. These are approved by the FCC for use with the product and are basically constrained by the following limits:

- Single Polarization Flat Plate Antennas – up to 28dBi per antenna.
- Single/Dual Polarization Parabolic Dish Antennas – up to 37.7dBi per polarization or antenna.

In FCC regions when using external antennas – cable loss between the connectorized version of the 600 Series bridge and the antenna ports must not be less than 1.2dB

13.3 Software/Features

The variant operates in the same way as the basic 600 Series bridge and is released initially with the feature set of the Connectorized 600 Series bridge. The areas where the functionality is modified are:

13.3.1 Status Page

The link loss calculation presented on the Status Page of the management interface has to be modified to allow for the increased antenna gains at each end of the link. The manufacturing process of the Connectorized 600 Series bridge configures the standard hardware of the unit for use with external antennas. The installer is prompted, as part of the installation process, to enter the gain of the external antenna(s) and cable losses at each end of the link. Peer-to-peer messaging is used to pass the effective antenna gain to each end of the link so that the link loss calculations can be correctly computed.

Equipment			Wireless		
Attributes	Value	Units	Attributes	Value	Units
Link Name	Tower of London		Wireless Link Status	Up	
Link Location	London, England		Maximum Transmit Power	25	dBm
Software Version	58600-04-99		Remote Maximum Transmit Power	25	dBm
Hardware Version	D04-R02-C		Transmit Power	25.0, 19.6, 18.0, 18.0	dBm
Region Code	1		Receive Power	-34.3, -52.1, -110.0, -42.6	dBm
Elapsed Time Indicator	00:01:41		Vector Error	7.2, -16.7, -30.3, -29.0	dB
Ethernet / Internet			Link Loss	111.3, 69.8, 0.0, 107.6	dB
Ethernet Link Status	Copper Link Up		Transmit Data Rate	141.13, 80.53, 0.00, 141.13	Mbps
Ethernet Speed And Duplex	1000 Mbps Full Duplex		Receive Data Rate	141.13, 81.14, 0.00, 141.13	Mbps
MAC Address	00:04:56:80:0f:ff		Link Capacity	300.16	Mbps
Telecoms			Transmit Modulation Mode	256QAM 0.81 (Dual)	
Channel A	Disabled		Receive Modulation Mode	256QAM 0.81 (Dual)	
Channel B	Disabled		Receive Modulation Mode Detail	Running At Maximum Receive Mode	
			Range	0.1	km
Automatic page refresh period in seconds	<input type="text" value="3600"/>	Seconds	<input type="button" value="Update Page Refresh Period"/> <input type="button" value="Reset form"/>		

Figure 101 - Connectorized 600 Series bridge Status Page

13.3.2 Configuration Pages

The amended Configuration web page is shown below as Figure 102.

System Configuration

This page controls the day to day configuration of the PTP wireless unit.

Equipment

Attributes	Value	Units
Link Name	<input type="text" value="Tower of London"/>	
Link Location	<input type="text" value="London, England"/>	
Master Slave Mode	Master	
Link Mode Optimization	IP Traffic	
Max Receive Modulation Mode	<input type="text" value="256QAM 0.81"/>	
Ethernet Capped Max Wireless Speed	<input type="radio"/> Disabled <input checked="" type="radio"/> Enabled	
Max Transmit Power	<input type="text" value="25"/>	dBm
Antenna Gain	<input type="text" value="23.5"/>	dBi
Cable Loss	<input type="text" value="0.0"/>	dB
EIRP	48.5	dBm

Figure 102 - Connectorized 600 Series bridge 'System Configuration' Page

13.3.3 Installation Pages

The installer is prompted to enter the Antenna Gain and Cable Loss (Connectorized PTP 600 Series Bridge to antenna) at each end of the link. The Installation Page(s) is shown as Figure 103 to Figure 105.

Step 2 of 3: Wireless Configuration

Please enter the following wireless configuration parameters

Wireless data entry

Attributes	Value	Units
Target MAC Address	00:04:56: <input style="width: 30px;" type="text" value="80"/> : <input style="width: 30px;" type="text" value="0f"/> : <input style="width: 30px;" type="text" value="c7"/>	
Master Slave Mode	<input checked="" type="radio"/> Master <input type="radio"/> Slave	
Link Mode Optimization	<input checked="" type="radio"/> IP Traffic <input type="radio"/> TDM Traffic	
Max Transmit Power	<input style="width: 50px;" type="text" value="25"/>	dBm
Ranging Mode	<input checked="" type="radio"/> Auto 0 to 40 km <input type="radio"/> Auto 0 to 100 km <input type="radio"/> Auto 0 to 200 km <input type="radio"/> Target Range	
Target Range	<input style="width: 50px;" type="text" value="0.0"/>	km
Platform Variant	<input type="radio"/> Integrated Antenna <input checked="" type="radio"/> Connectorized	
Antenna Gain	<input style="width: 50px;" type="text" value="23.5"/>	dBi
Cable Loss	<input style="width: 50px;" type="text" value="0.0"/>	dB
Spectrum Management Control	<input checked="" type="radio"/> i_DFS <input type="radio"/> Fixed Frequency	
Lower Center Frequency	<input style="width: 50px;" type="text" value="5742"/> ▾	MHz
Installation Tones	<input checked="" type="radio"/> Disabled <input type="radio"/> Enabled	

◀ Back
Next ▶▶

Figure 103 - Connectorized PTP 600 Series Bridge 'Installation Wizard' Page



Antenna Gain: Gain of the antenna you are connecting to the unit, see Table 21.

Cable Loss: Loss in the cable between the ODU and the antenna. Note: In the event that there is a significant difference in length of the antenna cables for the two antenna ports, then the average value should be entered.

Spectrum Management Control: Is used to configure the 600 Series bridge Spectrum Management features, see section 8.3.7 for more details. iDFS is the abbreviation for intelligent Dynamic Frequency Selection, which continually monitors the 5.8 GHz spectrum looking for the channel with the lowest level of on channel and co-channel interference. Fixed frequency mode allows the installer to fix the transmit and receive frequencies on the units. The frequencies may be configured symmetrically or asymmetrically.

Step 3 of 3: Confirm Installation Configuration

Please review your entered configuration. If any of the configuration items are incorrect please use the back button to apply the corrections.

Once you're happy with the configuration press the 'Confirm Configuration, Arm Installation Agent and Reboot' button, this will commit the parameters to non-volatile memory and reboot this wireless unit.

Installation configuration

Attributes	Value	Units
IP Address	169.254.1.1	
Subnet Mask	255.255.0.0	
Gateway IP Address	169.254.0.0	
Use VLAN For Management Interfaces	Disabled	
Telecoms Interface	None	
Target MAC Address	00:04:56:80:0f:c7	
Master Slave Mode	Master	
Link Mode Optimization	IP Traffic	
Max Transmit Power	25	dBm
Ranging Mode	Auto 0 to 40 km	
Platform Variant	Connectorized	
Antenna Gain	23.5	dBi
Cable Loss	0.0	dB
EIRP	48.5	dBm
Spectrum Management Control	i_DFS	
Lower Center Frequency	5742	MHz
Installation Tones	Disabled	
<input type="button" value="Confirm Configuration, Arm Installation Agent and Reboot"/>		

 **Back**

Figure 104 - Connectorized 600 Series bridge 'Confirm Installation' Page

EIRP The Confirm Installation Page displays the EIRP (Effective Isotropic Radiated Power), which describes the strength of the radio signal leaving the wireless unit. This allows the operator to verify that their link configuration (Max Transmit Power, Antenna Gain and Cable Loss) do not cause the link to exceed any applicable regulatory limit.

Disarm Installation

The installation agent is armed. If you wish to disarm installation then use the 'Disarm Installation Agent' button. If you wish to reconfigure the installation agent then use the wizards 'back' button

Installation configuration

Attributes	Value	Units
IP Address	169.254.1.2	
Subnet Mask	255.255.0.0	
Gateway IP Address	169.254.0.0	
Use VLAN For Management Interfaces	Disabled	
Telecoms Interface	None	
Target MAC Address	00:04:56:80:0f:ff	
Master Slave Mode	Slave	
Link Mode Optimization	IP Traffic	
Max Transmit Power	10	dBm
Ranging Mode	Auto 0 to 40 km	
Platform Variant	Connectorized	
Antenna Gain	23.5	dBi
Cable Loss	0.0	dB
EIRP	33.5	dBm
Spectrum Management Control	i_DFS	
Lower Center Frequency	5742	MHz
Installation Tones	Disabled	

Disarm Installation Agent

 **Back**

Figure 105 - Connectorized 600 Series bridge 'Disarm Installation' Page

13.4 Deployment Considerations

The majority of radio links can be successfully deployed with the 600 Series bridge. It should only be necessary to use external antennas where the Link Budget Calculator indicates marginal performance for a specific link – for example when the link is heavily obscured by dense woodland on an NLOS link or extremely long LOS links (>80km or > 50 miles) over water.

The external antennas can be either dual-polarization (as the integrated antenna) or two single polarized antennas can be used in a spatially diverse configuration. It is expected that the dual-polarization antennas would normally be used to simplify the installation process; spatially diverse antennas may provide additional fade margin on very long LOS links where there is evidence of correlation of the fading characteristics on Vertical and Horizontal polarizations.

Dual polarization antennas (with a gain greater than the integrated antenna) are currently only available in parabolic dish form.

13.5 Link Budget

An estimate of the link budget for a specific application can be obtained by using the Motorola Systems link estimation tools. For more information see the Motorola web site.

13.6 Regulatory Issues

In countries where FCC regulations are not relevant, installations should conform to any applicable local regulations for the Equivalent Isotropic Radiated Power (EIRP).

Ensuring compliance becomes more complex when the connectorized unit is used with external antennas which may be locally sourced. With higher gain external antennas fitted, the Maximum Transmit power may need to be reduced for operation in specific countries.

See Table 6 in section 5.2 “Region Codes” for any EIRP restrictions that may apply in your region.

NOTE: The PTP54600 product does not have approval in the USA and Canada to operate with external antennas and connectorized versions of the PTP54600 are not shipped to USA and Canada. Therefore, this section of the Manual does not apply to PTP54600 in USA and Canada.

13.6.1 Antenna Choice (FCC Regions Only)



The antennas which can be deployed with the Connectorized 600 Series Bridge are shown in Table 21.

13.6.2 Cable Losses (FCC Regions Only)

The FCC approval for the product is based on tests with a cable loss between the units of approximately 1.2dB at 5.8GHz. The use of lower cable losses would result in the installation being outside the FCC rules.

As an indication, 1.2dB of cable loss corresponds to the following cable lengths excluding connector losses (source: Times Microwave).

Cable	Length for 1.2dB Cable Loss at 5.8GHz	
	(ft)	(m)
LMR100	1.9	0.6
LMR200	4.6	1.4
LMR300	7.25	2.2
LMR400	11.1	3.4
LMR600	16.5	5.0

Table 20 - Cable Losses per Length

13.7 Antennas for USA / Canada

Manufacturer	Antenna Type	Gain (dBi)	Flat Plate	Parabolic Dish
Andrew	Andrew 1-foot Flat Panel, FPA5250D12-N (23.6dBi)	23.6	Y	
Andrew	Andrew 2-foot Flat Panel, FPA5250D24-N (28dBi)	28	Y	
Gabriel	Gabriel 1-foot Flat Panel, DFPD1-52 (23.5dBi)	23.5	Y	
Gabriel	Gabriel 2-foot Flat Panel, DFPD2-52 (28dBi)	28	Y	
MTI	MTI 17 inch Diamond Flat Panel, MT-485009 (23dBi)	23	Y	
MTI	MTI 15 inch Dual-Pol Flat Panel, MT-485025/NVH (23dBi)	23	Y	
MTI	MTI 2 ft Directional Flat Panel, MT-20004 (28dBi)	28	Y	
MTI	MTI 2 ft Flat Panel, MT-486001 (28dBi)	28	Y	

Manufacturer	Antenna Type	Gain (dBi)	Flat Plate	Parabolic Dish
RFS	RFS 1-foot Flat Panel, MA0528-23AN (23dBi)	23	Y	
RFS	RFS 2-foot Flat Panel, MA0528-28AN (28dBi)	28	Y	
Teletronics	Teletronics 2-foot Flat Plate Antenna, ANT-P5828 (28dBi)	28	Y	
Andrew	Andrew 2-foot Parabolic, P2F-52 (29.4dBi)	29.4		Y
Andrew	Andrew 2-foot Dual-Pol Parabolic, PX2F-52 (29.4dBi)	29.4		Y
Andrew	Andrew 3-foot Parabolic, P3F-52 (33.4dBi)	33.4		Y
Andrew	Andrew 3-foot Dual-Pol Parabolic, PX3F-52 (33.4dBi)	33.4		Y
Andrew	Andrew 4-foot Parabolic, P4F-52 (34.9dBi)	34.9		Y
Andrew	Andrew 4-foot Dual-Pol Parabolic, PX4F-52 (34.9dBi)	34.9		Y
Andrew	Andrew 6-foot Parabolic, P6F-52 (37.6dBi)	37.6		Y
Andrew	Andrew 6-foot Dual-Pol Parabolic, PX6F-52 (37.6dBi)	37.6		Y
Gabriel	Gabriel 2-foot High Performance QuickFire Parabolic, HQF2-52-N	28.2		Y
Gabriel	Gabriel 4-foot High Performance QuickFire Parabolic, HQF4-52-N	34.4		Y
Gabriel	Gabriel 6-foot High Performance QuickFire Parabolic, HQF6-52-N	37.4		Y
Gabriel	Gabriel 2-foot High Performance Dual QuickFire Parabolic, HQFD2-52-N	28.1		Y
Gabriel	Gabriel 4-foot High Performance Dual QuickFire Parabolic, HQFD4-52-N	34.3		Y
Gabriel	Gabriel 6-foot High Performance Dual QuickFire Parabolic, HQFD6-52-N	37.3		Y
Gabriel	Gabriel 2-foot Standard QuickFire Parabolic, QF2-52-N	28.5		Y
Gabriel	Gabriel 2-foot Standard QuickFire Parabolic, QF2-52-N-RK	28.5		Y
Gabriel	Gabriel 2.5-foot Standard QuickFire Parabolic, QF2.5-52-N	31.2		Y
Gabriel	Gabriel 4-foot Standard QuickFire Parabolic, QF4-52-N	34.8		Y
Gabriel	Gabriel 4-foot Standard QuickFire Parabolic, QF4-52-N-RK	34.8		Y
Gabriel	Gabriel 6-foot Standard QuickFire Parabolic, QF6-52-N	37.7		Y
Gabriel	Gabriel 2-foot Standard Dual QuickFire Parabolic, QFD2-52-N	28.4		Y
Gabriel	Gabriel 2.5-foot Standard Dual QuickFire Parabolic, QFD2.5-52-N	31.1		Y
Gabriel	Gabriel 2-foot Standard Dual QuickFire Parabolic, QFD2-52-N-RK	28.4		Y

Manufacturer	Antenna Type	Gain (dBi)	Flat Plate	Parabolic Dish
Gabriel	Gabriel 4-foot Standard Dual QuickFire Parabolic, QFD4-52-N	34.7		Y
Gabriel	Gabriel 4-foot Standard Dual QuickFire Parabolic, QFD4-52-N-RK	34.7		Y
Gabriel	Gabriel 6-foot Standard Dual QuickFire Parabolic, QFD6-52-N	37.7		Y
RadioWaves	Radio Waves 2-foot Dual-Pol Parabolic, SPD2-5.2 (28.1dBi)	28.1		Y
RadioWaves	Radio Waves 2-foot Parabolic, SP2-5.2 (29.0dBi)	29		Y
RadioWaves	Radio Waves 3-foot Dual-Pol Parabolic, SPD3-5.2 (31.1dBi)	31.1		Y
RadioWaves	Radio Waves 3-foot Parabolic, SP3-5.2 (31.4dBi)	31.4		Y
RadioWaves	Radio Waves 4-foot Dual-Pol Parabolic, SPD4-5.2 (34.4dBi)	34.4		Y
RadioWaves	Radio Waves 4-foot Parabolic, SP4-5.2 (34.8dBi)	34.8		Y
RadioWaves	Radio Waves 6-foot Dual-Pol Parabolic, SPD6-5.2 (37.5dBi)	37.5		Y
RadioWaves	Radio Waves 6-foot Parabolic, SP6-5.2 (37.7dBi)	37.7		Y
RadioWaves	Radio Waves 2-foot Parabolic, SP2-2/5 (28.3dBi)	28.3		Y
RadioWaves	Radio Waves 3-foot Parabolic, SP3-2/5 (31.4dBi)	31.4		Y
RadioWaves	Radio Waves 4-foot Parabolic, SP4-2/5 (34.6dBi)	34.6		Y
RadioWaves	Radio Waves 6-foot Parabolic, SP6-2/5 (37.7dBi)	37.7		Y
RFS	RFS 2-foot Parabolic, SPF2-52AN or SPFX2-52AN (27.9dBi)	27.9		Y
RFS	RFS 3-foot Parabolic, SPF3-52AN or SPFX3-52AN(31.4dBi)	31.4		Y
RFS	RFS 4-foot Parabolic, SPF4-52AN or SPFX4-52AN(33.9dBi)	33.9		Y
RFS	RFS 6-foot Parabolic, SPF6-52AN or SPFX6-52AN (37.4dBi)	37.4		Y
RFS	RFS 2-foot HP Parabolic, SDF2-52AN or SDFX2-52AN (31.4dBi)	31.4		Y
RFS	RFS 4-foot HP Parabolic, SDF4-52AN or SDFX4-52AN (33.9dBi)	33.9		Y
RFS	RFS 6-foot HP Parabolic, SDF6-52AN or SDFX6-52AN (37.4dBi)	37.4		Y
StellaDoradus	StellaDoradus 45 inch Parabolic Antenna, 58PSD113	33.8		Y

Table 21 - Allowed Antennas for Deployment in USA/Canada

13.8 Installation

The section covers the generic installation instructions for the Connectorized versions of the PTP 600 Series point-to-point wireless Ethernet bridges. The actual installation procedure will depend on antenna choice, cable choice, required antenna separation etc.

13.8.1 Antenna Choice

Table 21 shows a wide variety of antennas that can be used with the Connectorized 600 Series bridge. The main selection criteria will be the required antenna gain. The secondary criteria should be the ease of mounting and alignment. For example the Radio Waves Parabolic dishes are supplied with a mount that allows adjustment for alignment independent of the actual antenna mounting. This type of antenna is much easier to align than those that have to be rotated around the mounting pole for alignment.

13.8.2 Cables and Connectors

Cables should be selected using the above criteria. However it should be noted that a cable of a type similar to LMR400 is a lot more difficult to handle and route than a cable of a type similar to LMR100.

Motorola recommends the use of weatherproof connectors -- preferably, ones that come supplied with adhesive lined heat shrink sleeve that is fitted over the cable/connector interface.

The connectors required at the Connectorized 600 Series bridge end of the antenna cables are N-Type Male.

The connectors required at the antenna end of the antenna cables is dependant on the antenna type chosen.

13.8.3 Tools

The tools required for mounting a Connectorized 600 Series bridge unit are the same as those required for an Integrated 600 Series bridge detailed in section 7.3. The tools required for mounting the antennas are specific to the antenna chosen. The installer should refer to the antenna manufacturer's instructions.

13.8.4 Miscellaneous supplies

The following miscellaneous supplies will be required:

- Cable ties, cable cleats – for securing cables
- Self-amalgamating tape – to weatherproof the RF connectors
- PVC tape – for additional protection of the RF connectors and securing cables

13.8.5 Mounting the Connectorized 600 Series Bridge

A Connectorized 600 Series bridge is shipped with the same bracket as supplied with an Integrated unit. Details on the use of this bracket can be found in section 3.3.7. The 600 Series bridge should be mounted in a position that gives it maximum protection from the elements, but still allows easy access for making off the various connections and applying the recommended weatherproofing.

When using dual polar antennas the Connectorized 600 Series bridge should be mounted in such a position as to minimize the cable length, keeping losses to a minimum (taking into account the minimum cable lengths required by the FCC regulations, see section 13.7).

When using separate antennas the Connectorized 600 Series bridge should be mounted in such a position as to minimize both cable runs between the unit and the antennas. It is not necessary to mount the Connectorized 600 Series bridge at the mid point between the antennas.

13.8.6 Mounting the antennas

The Antennas should be mounted according to the manufacturer's instructions. Actual antenna position will depend on the available mounting positions and link requirements. It may be necessary to mount the antennas 20m apart or at a certain distance from the ground to get the desired results.

13.8.7 Alignment Process

When aligning antennas deployed with a Connectorized 600 Series bridge unit it may not be possible to hear the alignment tone emanating from the unit. In this case it may be necessary for a second installer to assist in the operation. Alternatively, it may be possible to extend the tube on the supplied stethoscope to give a longer reach.

Tip: Fine antenna alignment can sometimes be achieved by tightening and loosening the bolts on either side of the antenna mounting bracket, rather than trying to turn the whole bracket on the mounting pole.

13.8.8 Aligning Dual Polar Antennas

The process for aligning a dual polar antenna is the same as aligning an Integrated unit with an integrated antenna. This procedure is detailed in section 7.7.11.

13.8.9 Aligning Separate Antennas

When using separate antennas to achieve spatial diversity, one should be mounted with Horizontal polarization and the other with Vertical polarization.

The following steps should be followed:

- Step 1: Mount the Antennas
- Step 2: Mount the connectorized version of the PTP 600 Series Bridge unit
- Step 3: Route and make off the ends of the Antenna cables
- Step 4: Connect the antenna cables at the antennas
- Step 5: Connect one of the antenna cables at the Connectorized version of the 600 Series bridge unit.
- Step 6: Connect the Connectorized 600 Series bridge ODU to PIDU Plus cable and configure the unit as described in section 7.7.
- Step 7: Align the connected antenna using the tones as described in section 7.7.11.
- Step 8: Connect the other antenna to the Connectorized 600 Series bridge.
- Step 9: Disconnect the cable to the already aligned antenna.
- Step 10: Align the second antenna using the tones as described in section 7.7.11.
- Step 11: Re-connect the second antenna to the Connectorized 600 Series bridge (Note: you will notice the tone pitch increase as you re-connect the second antenna due to the additional received signal).
- Step 12: Use the relevant status web pages to check that you are getting the results you expect from your link planning.
- Step 13: Complete the installation as detailed below.

13.8.10 Completing the Installation

The installation should be completed by checking all mounting nuts bolts and screws, securing all cables and weatherproofing the installation.

Warning: Finally tightening the antenna mountings may cause the antenna alignment to be altered, due to distortion in the mounting bracket caused by action of tightening. It is recommended that the installation tone be left turned on (armed) during this process so that any movement can be noticed and counteracted by tightening the other side of the bracket.

13.8.11 Antenna Cable Fixing

Cables should be secured in place using cable ties, cleats or PVC tape. Care should be taken to ensure that no undue strain is placed on the connectors on both the Connectorized 600 Series bridge and the Antennas and also to ensure that the cables do not flap in the wind. Flapping cables are prone to damage and induce unwanted vibrations in the mast to which the units are attached.

13.8.12 Antenna Connection Weatherproofing

Where a cable connects to an antenna or unit from above, a drip loop should be left to ensure that water is not constantly channeled towards the connector.

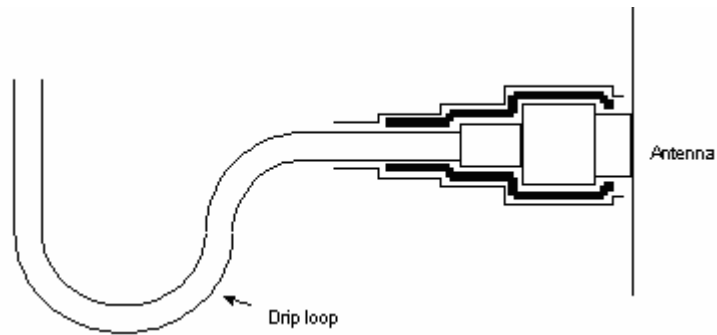

Figure 106 - Forming a Drip Loop

All joints should be weatherproofed using self-amalgamating tape. It is recommended that a layer of PVC tape be placed over the self-amalgamating tape to protect the joint while the self-amalgamating tape cures and gives additional protection. Figure 107 shows this diagrammatically for the 600 Series bridge end of the antenna cables. If the antenna manufacturer has not supplied guidance on this matter, the same technique should be employed at the antenna end of the cable.

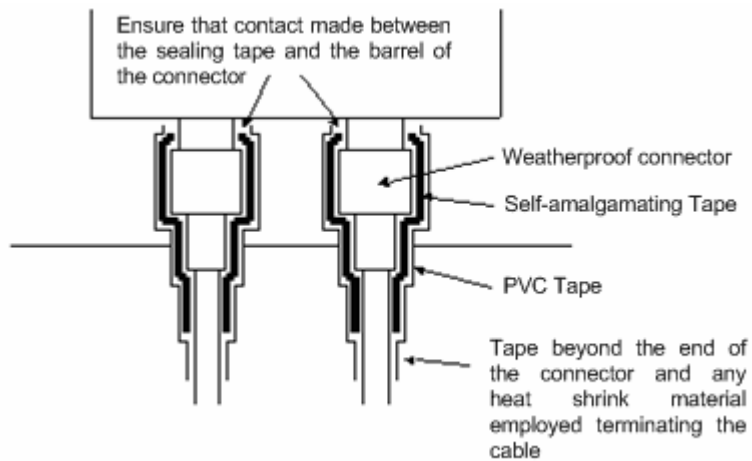

Figure 107 - Weatherproofing the Antenna Connections

13.9 Additional Lightning Protection

The following guidelines should be applied in addition to those described in Section 11 "Lightning Protection".

13.9.1 ODU Mounted Outdoors

Where the ODU is mounted outdoors and is mounted some distance from the antenna, it is advisable to add additional grounding by utilizing Andrew Assemblies (such as Andrew Type 223158 www.andrew.com) as shown in Figure 108.

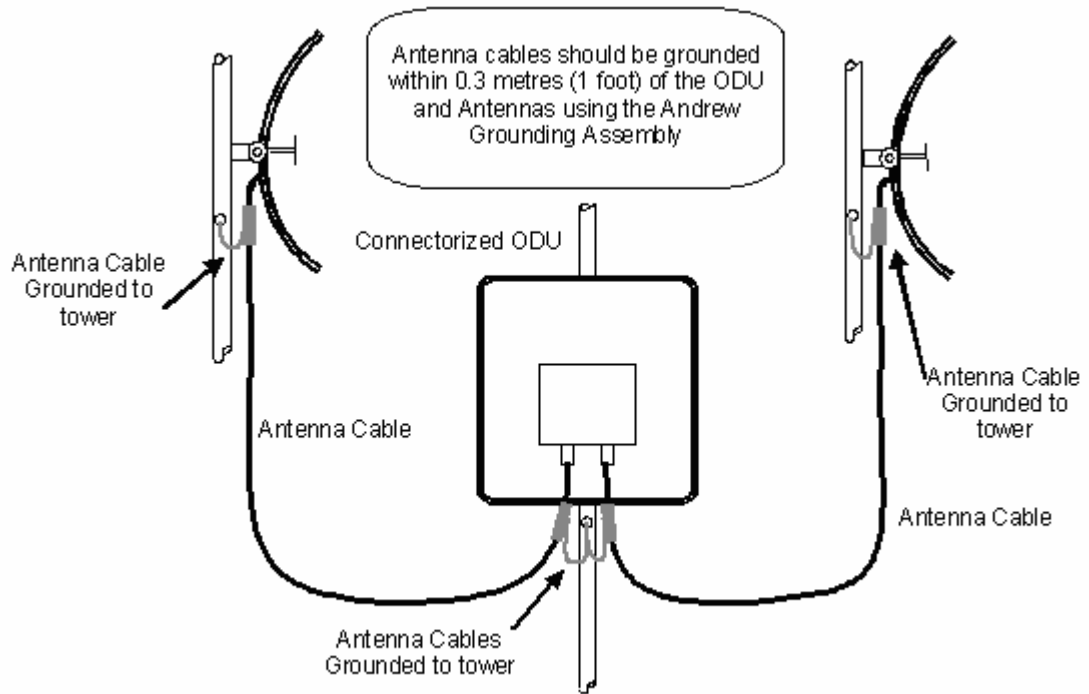

Figure 108- Additional Grounding When Using Connectorized Units

13.9.2 ODU Mounted Indoors

Where the ODU is mounted indoors, lightning arrestors should be deployed where the antenna cables enter the building as shown in Figure 109.

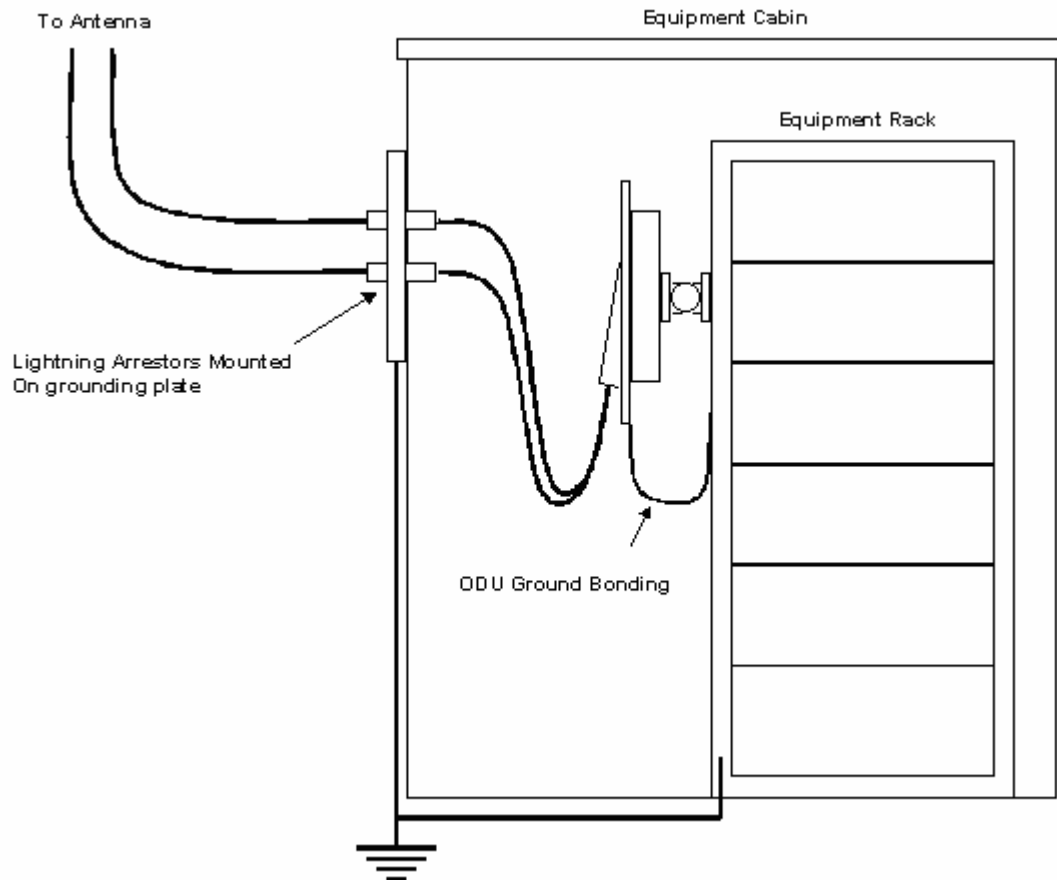

Figure 109 - Lightning Arrester Mounting

The lighting arrestors should be ground bonded to the building ground at the point of entry. Motorola recommends Polyphaser LSXL-ME or LSXL lighting arrestors. These should be assembled as show in Figure 110.

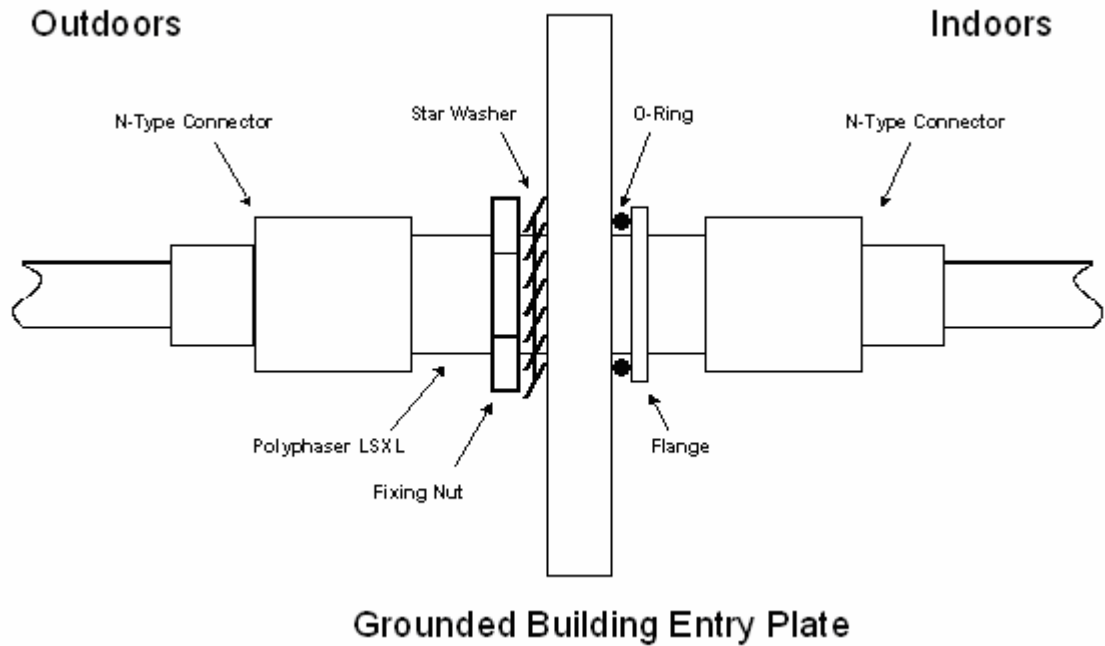

Figure 110 - Polyphaser Assembly

14 E1/T1 Installation Guide

14.1 Preparing the PTP 600 Series Bridge E1/T1 Cable

Note: The maximum cable length between the ODU and the customers terminating equipment is 200m (656 feet) for T1.

The E1/T1 cable should be assembled to the following instructions:



Step 1: Assemble gland on cable as shown

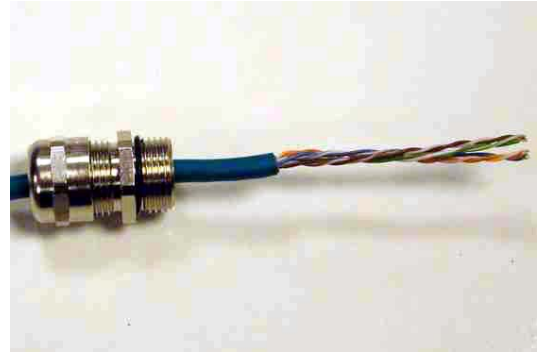

Step 2: Strip the outer insulation

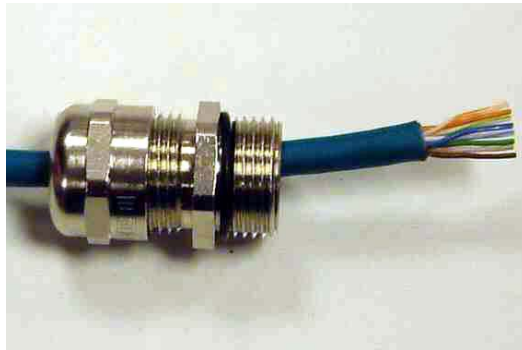

Step 3: Arrange conductors as shown in fig. A2 and cut to length

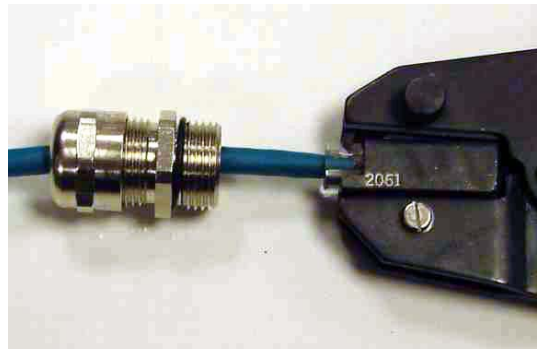

Step 4: Insert conductors and crimp



Figure 111 - Completed ODU Connector

This procedure applies to the ODU termination. The above procedure should be repeated for the customer equipment end of the cable when the cable is terminated with a RJ45.

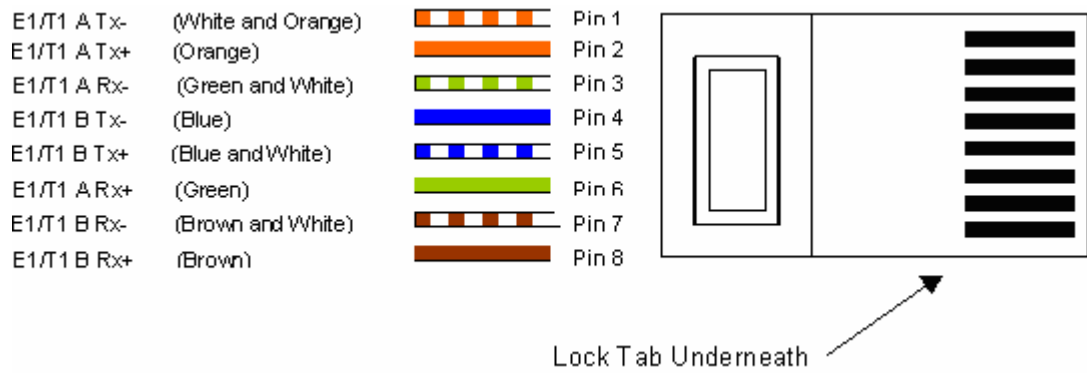

Figure 112 - RJ45 Pin Connection (T568B Color Coding)

14.2 Making the Connection at the ODU

Looking at the back of the unit with the cable entry at the bottom, the PTP 600 Series Bridge E1/T1 connection is the first hole on the left (Figure 113) and is labeled E1/T1.

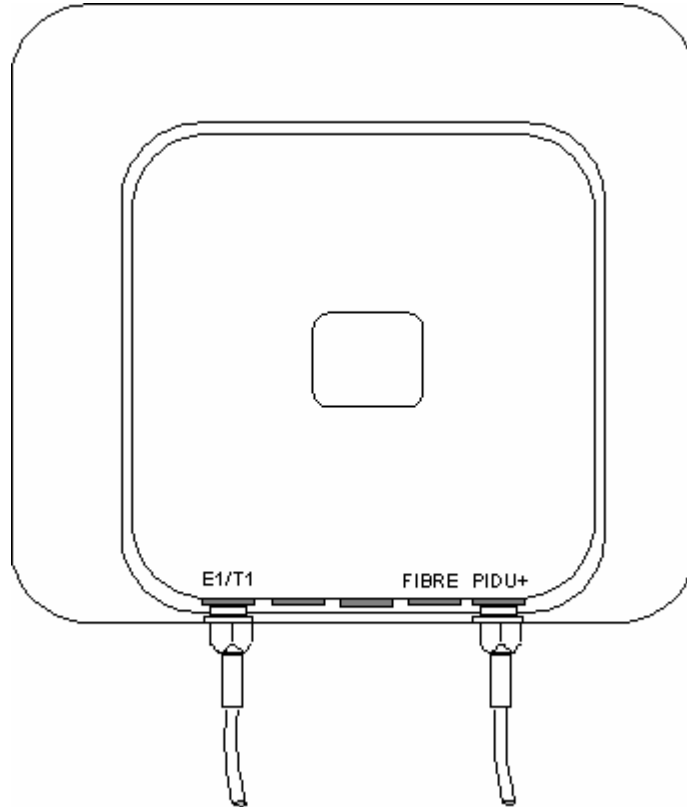

Figure 113 - PIDU Plus and E1-T1 Connection

The following procedure describes how connection is made at the ODU. It is often easier to carry out this procedure on the ground or a suitable surface prior to mounting the ODU.

Ensure no power is connected to the PIDU Plus.



Step 1: Assemble the cable as described in above



Step 2: Insert the RJ45 connector making sure that the locking tab snaps home



Step 3: Screw in the body of the weather proofing gland and tighten



Step 4: Screw on the clamping nut and tighten

Should it be necessary to disconnect the E1/T1 cable at the ODU this can be achieved by removing the weatherproofing gland and depressing the RJ45 locking tab with a small screwdriver as shown opposite.



Figure 114 - Disconnecting the ODU

14.3 Routing the Cable

After connecting the cable to the ODU it can be routed and secured using standard cable routing and securing techniques. When the cable is in place it can then be cut to the desired length.

14.4 Fitting a Surge Arrestor

If you have opted to fit a Surge Arrestor, it should be installed as described in Section A1.5 “Lightning Protection”

14.5 Customer Cable Termination

The two channels can be separated by means of a patch panel which may include Baluns for transmission over 75 Ohm co-axial unbalanced lines. Such equipment should conform to the requirements of C.C.I.T.T. G703. An example of a Balun is shown below. It allows the transmit and receive data carried over a 75 Ohm cable to be converted to a balanced form for transmission over a 120 Ohm signal balanced twisted pair.



Figure 115 - Example of a Balun

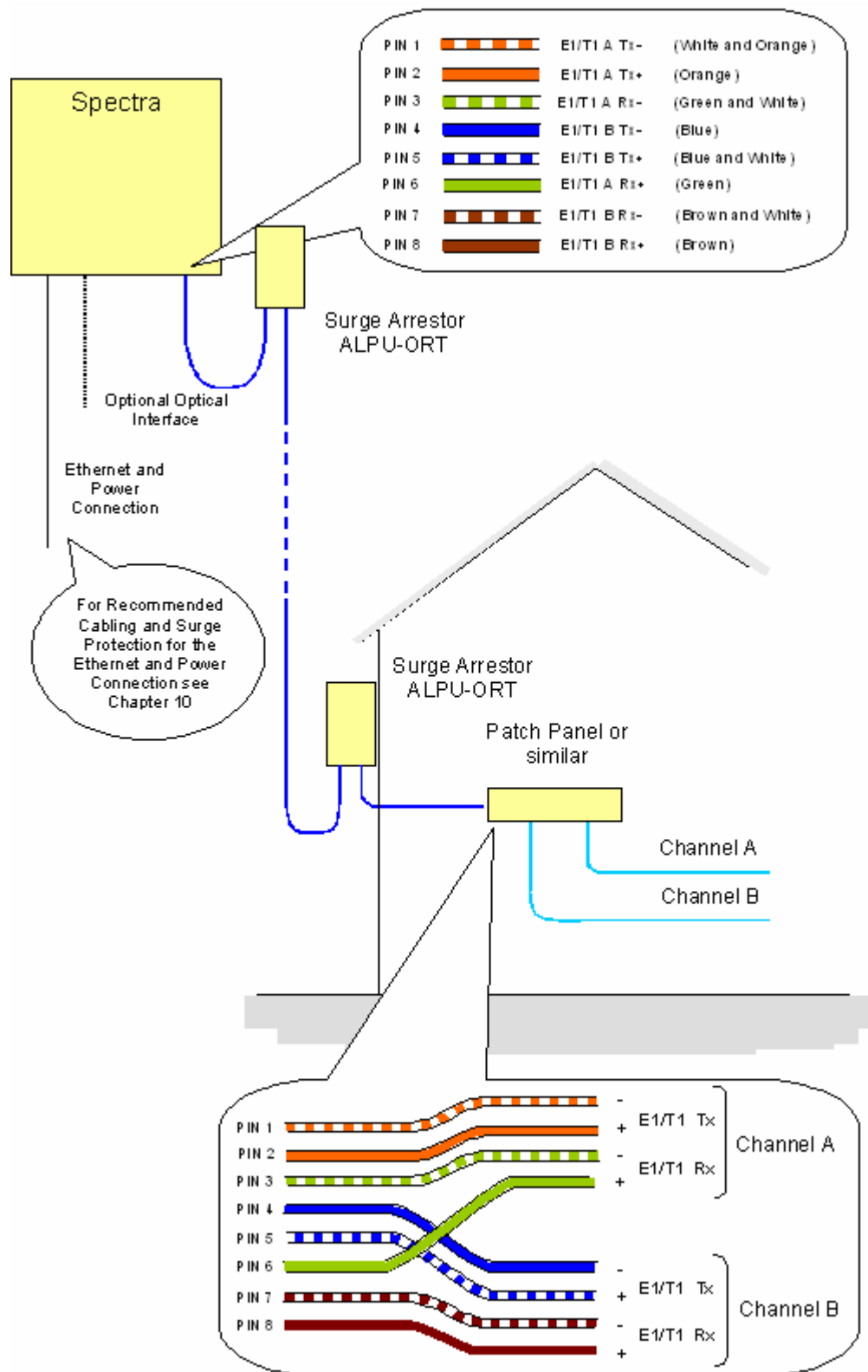

Figure 116 - Diagrammatically Showing the E1-T1 Connections

14.6 Lightning Protection

14.6.1 Overview

Section 11 in the main body of this manual contains the requirements for the Motorola PTP 600 Series deployment. This section details the additional requirements for the deployment of E1/T1.

14.6.2 Recommended Additional Components for E1/T1 Installation.

The recommended components below are in addition to those listed in section 11, the extra components required for the E1/T1 installation are:

- Screened Cat 5 Cable
- Surge Arrestor Units — Transtector type ALPU-ORT, 4 required per link.
(www.transtector.com)
- RJ45 screened connectors
- 8 AWG Grounding Cable

For a description of Zone A and Zone B refer to section 11.

	Zone A	Zone B
Earth ODU	Mandatory	Mandatory
Screen Cable	Mandatory	Mandatory
Surge Arrestor Unit ALPU-ORT at ODU	Mandatory	Mandatory
Earth Cable at Building Entry	Mandatory	Mandatory
Surge Arrestor Unit ALPU-ORT at Building Entry	Mandatory	Mandatory

Table 22 - Protection Requirements

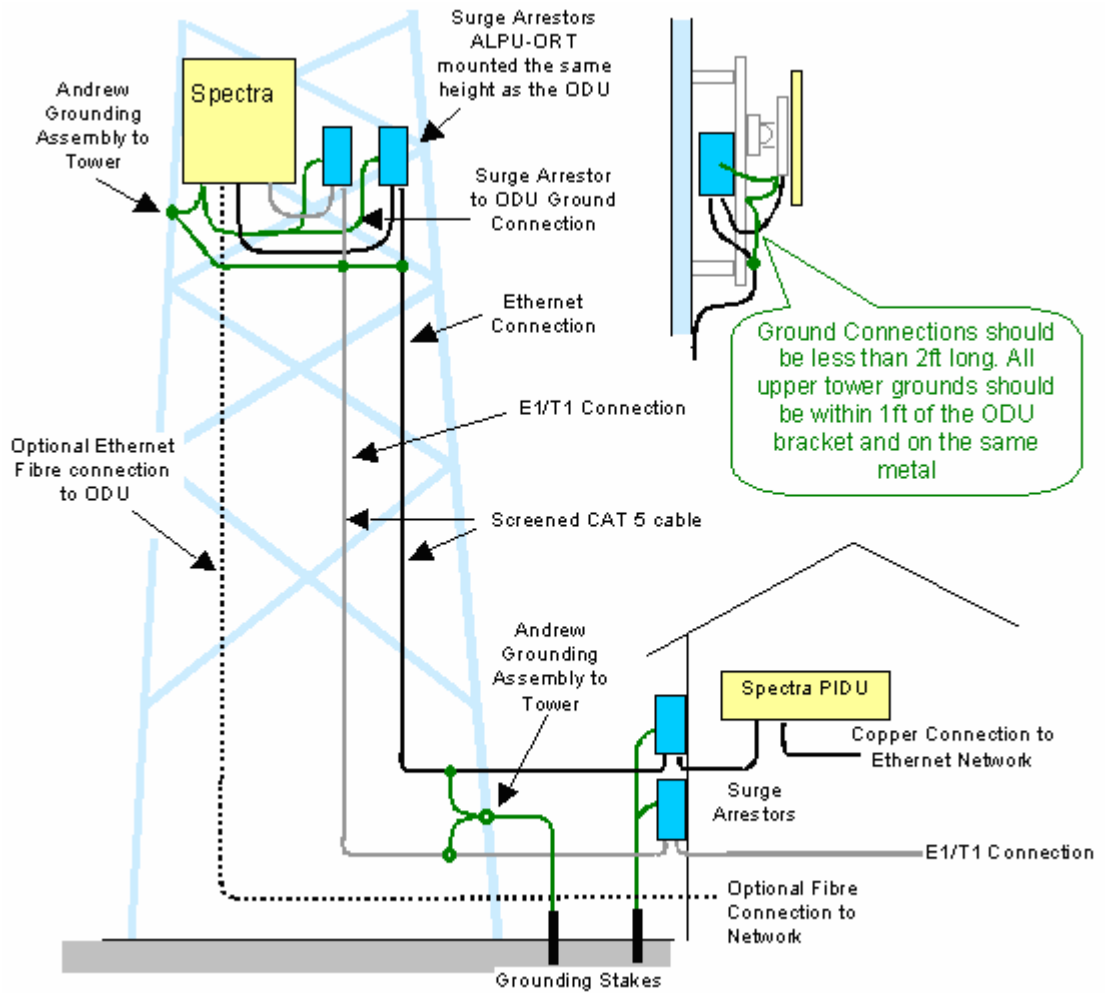

Figure 117 - Typical Mast Installation with the addition of the E1-T1 cable

Note: There may be a local regulatory requirement to cross bond the CAT 5 drop cable at regular intervals to the mast. This may be as frequent as every 10 meters (33 feet).

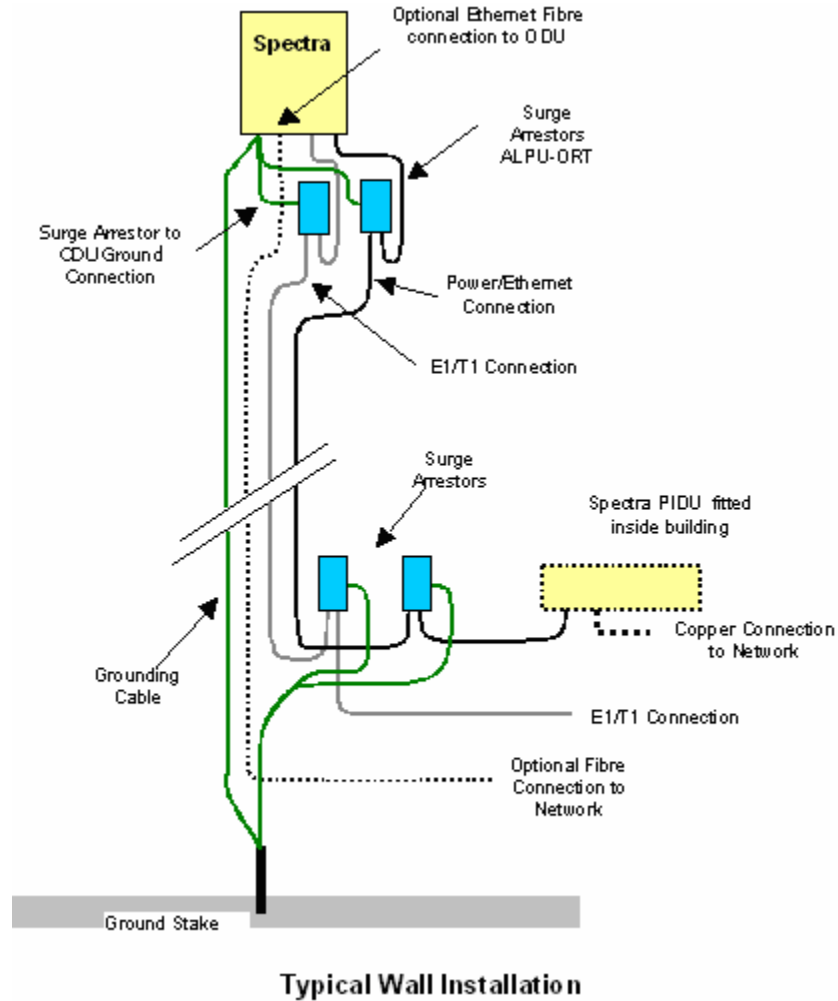

Figure 118 - Wall Installation with the addition of E1-T1 cable

14.7 Surge Arrestor Wiring

An Andrew Grounding Kit and Surge Arrestor Unit must be located at the ODU and reliably grounded as shown in Figure 95. There may also be a regulatory requirement to crossbond the screened CAT-5 at regular intervals up the mast. Refer to local regulatory requirements for further details.

A second Surge Arrestor Unit should be mounted at the building entry point and must be grounded.

The termination of the CAT-5 Cable into the Surge Arrestor Unit is illustrated in Table 23, Table 24 and Figure 119. The screen from the cable must be terminated into the ground terminal within the unit to ensure the continuity of the screen. Earth Sleeving should be used to cover the shield ground connection to prevent internal shorting within the unit.

Terminal Identification	Conductor	RJ45 Pin
CON3 Pin 1	Orange/White	1
CON3 Pin 2	Orange	2
CON3 Pin 3	Green/White	3
CON3 Pin 6	Green	6
CON1 Pin 4	Blue	4
CON1 Pin 5	Blue/White	5
CON1 Pin 7	Brown/White	7
CON1 Pin 8	Brown	8

Table 23 - Surge Arrestor ALPU-ORT Cable 1 Termination

Terminal Identification	Conductor	RJ45 Pin
CON4 Pin 1	Orange/White	1
CON4 Pin 2	Orange	2
CON4 Pin 3	Green/White	3
CON4 Pin 6	Green	6
CON2 Pin 4	Blue	4
CON2 Pin 5	Blue/White	5
CON2 Pin 7	Brown/White	7
CON2 Pin 8	Brown	8

Table 24 - Surge Arrestor ALPU-ORT Cable 2 Termination

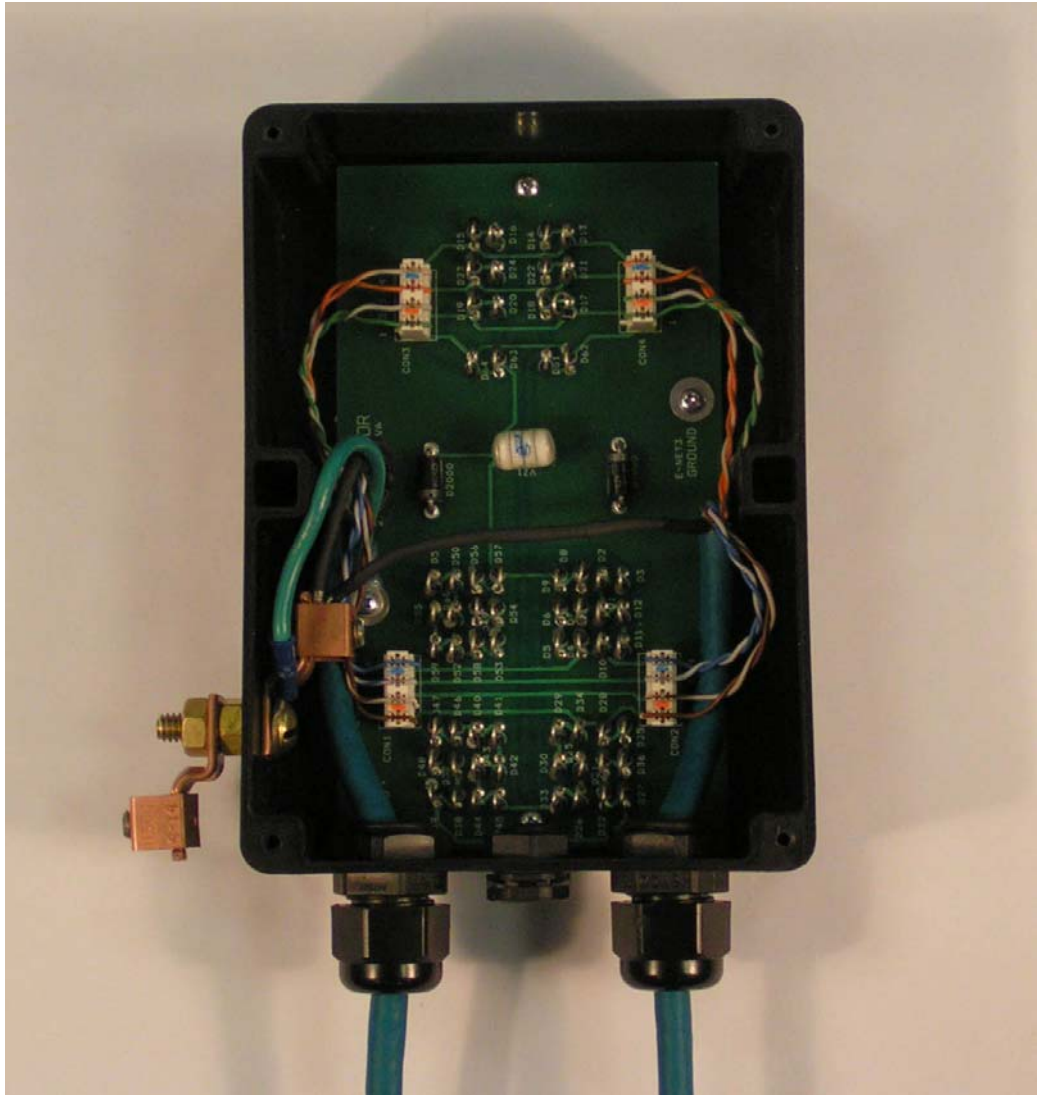

Figure 119 - Surge Arrester ALPU-ORT Connection Illustration

14.8 Testing Your Installation

If you have followed the above instructions you will have wired your systems to the following diagram:

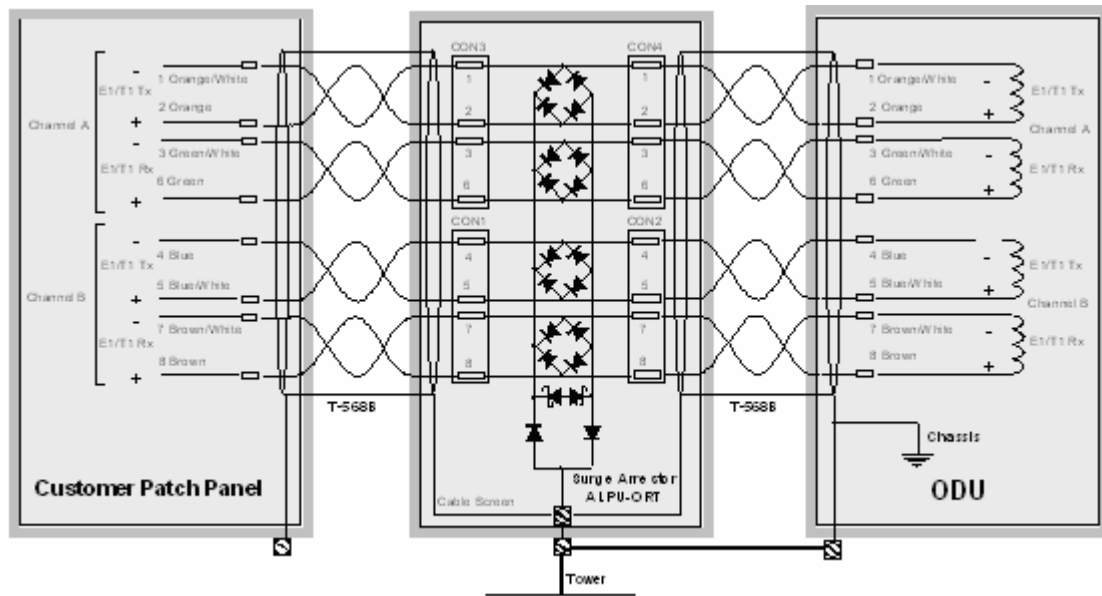

Figure 120 - Simplified Circuit Diagram (Only One Transactor Shown For Clarity)

14.8.1 Pre-Power Testing

Before connecting your E1/T1 source, check the following resistances:

1. Check the cable resistance between pins 3 & 6 (Green/White & Green) and 7 & 8 (Brown/White & Brown). Check against Table 25 column 2.
2. Check the cable resistance between pins 1 & 2 (Orange/White & Orange) and 4 & 5 (Blue & Blue/White). Check against Table 25 column 3.

CAT-5 Length (Meters)	Resistance between pins 3 & 6 and pins 7 & 8 (ohms)	Resistance between pins 1 & 2 and pins 4 & 5 (ohms)
0	0.8	1.3
10	2.5	3.0
20	4.2	4.7
30	5.9	6.4
40	7.6	8.2
50	9.3	9.8
60	11.0	11.5
70	12.7	13.2
80	14.4	14.9
90	16.1	18.2
100	17.8	18.3

Table 25 - Resistance Table Referenced To The E1/T1 Source

15 Data Rate Calculations

To aid the calculation of data rate throughput, the following plots of throughput verses link range have been produced for all the PTP 600 Series modulation modes, assuming the units are connected using Gigabit Ethernet.

Aggregate data rate capacity can be calculated using four key system parameters:

- Receive modulation mode
- Transmit modulation mode
- Range Between the two wireless units
- Wireless link mode (IP or TDM)

Using these parameters the Receive and Transmit data rates can be looked up using the plots Figure 121 through Figure 133.

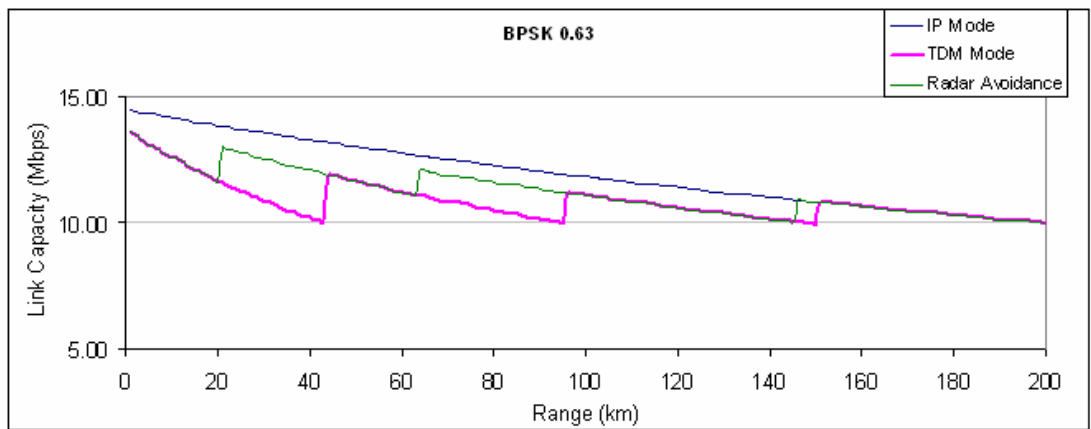

Figure 121 - BPSK 0.63 Single Payload

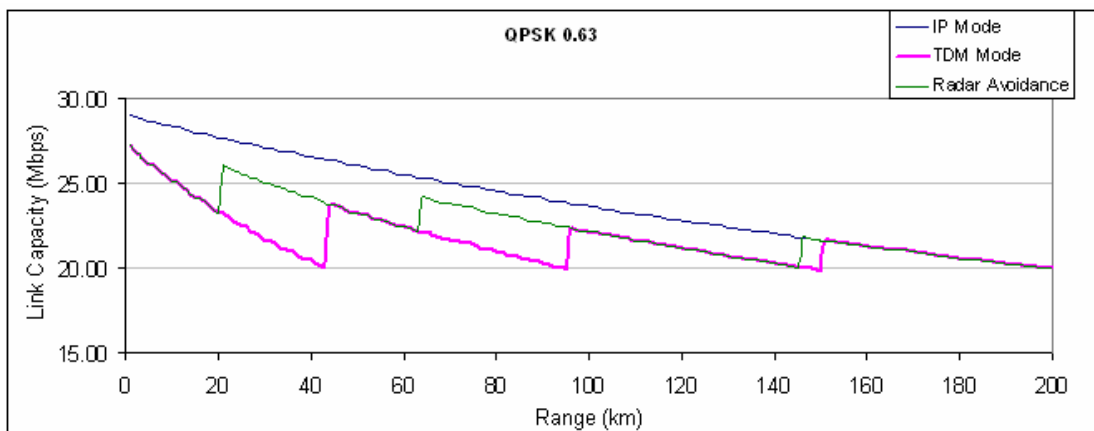

Figure 122 - QPSK 0.63 Single Payload

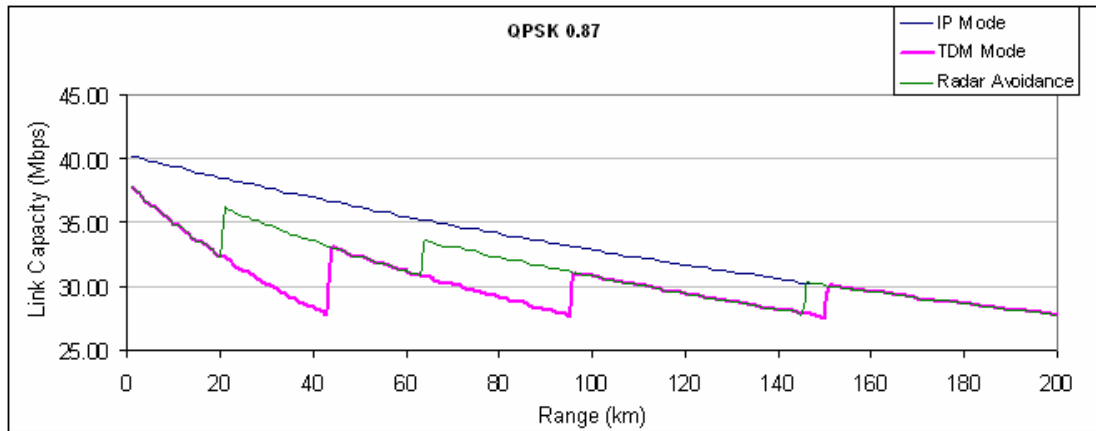

Figure 123 - QPSK 0.87 Single Payload

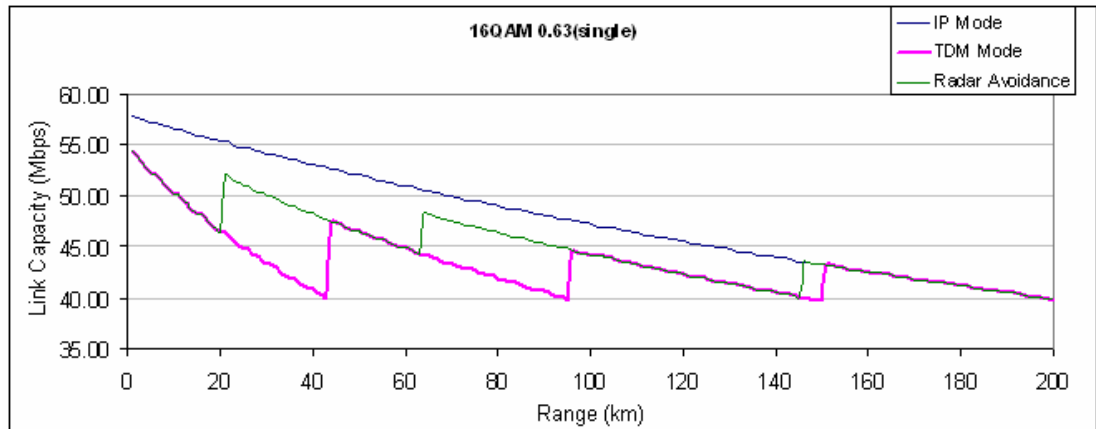

Figure 124 - 16 QAM 0.63 Single Payload

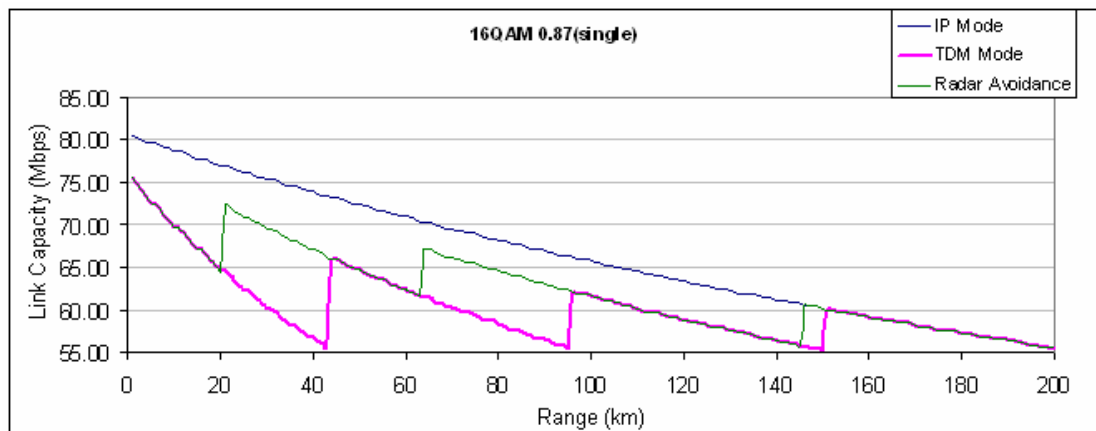

Figure 125 - 16 QAM 0.87 Single Payload

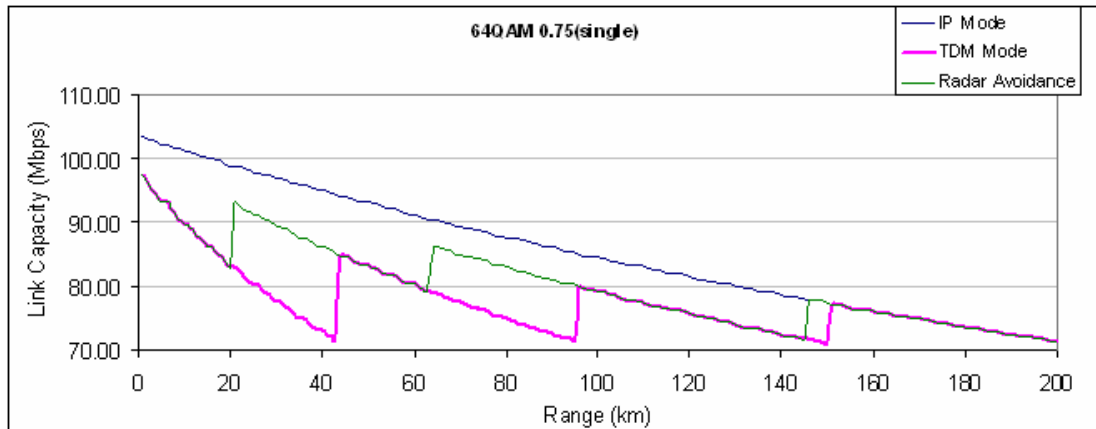

Figure 126 - 64 QAM 0.75 Single Payload

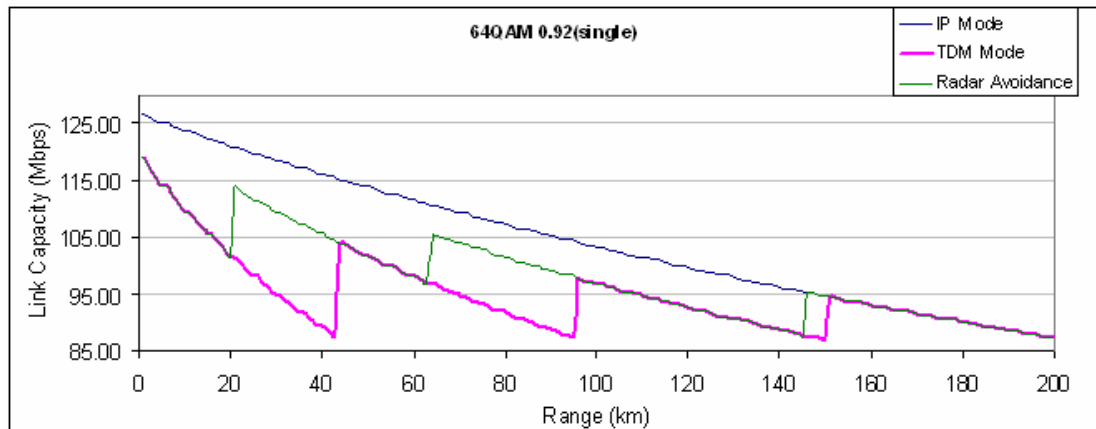

Figure 127 - 64 QAM 0.92 Single Payload

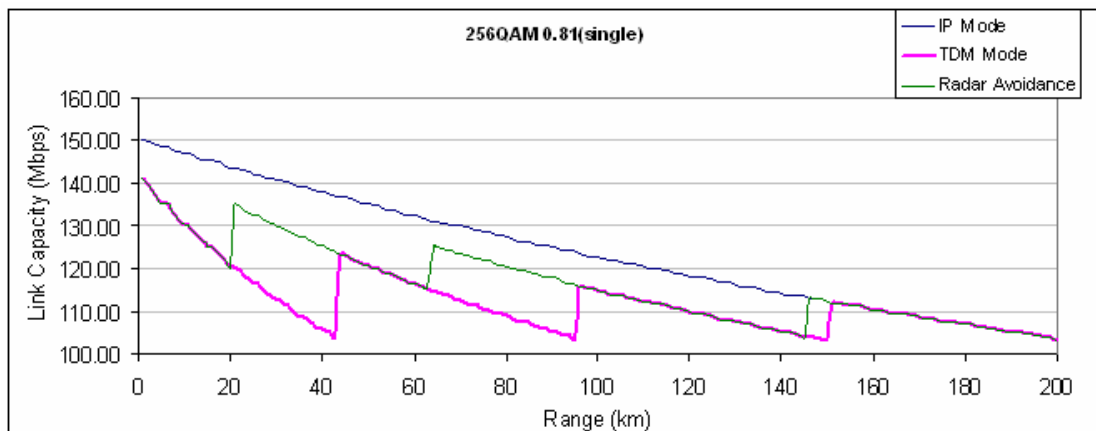

Figure 128 - 256 QAM 0.81 Single Payload

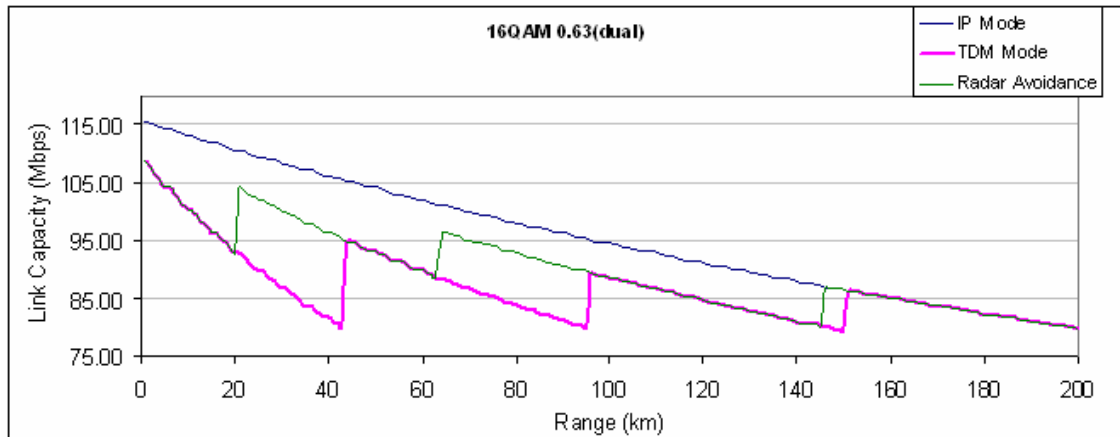

Figure 129 - 16 QAM 0.63 Dual Payload

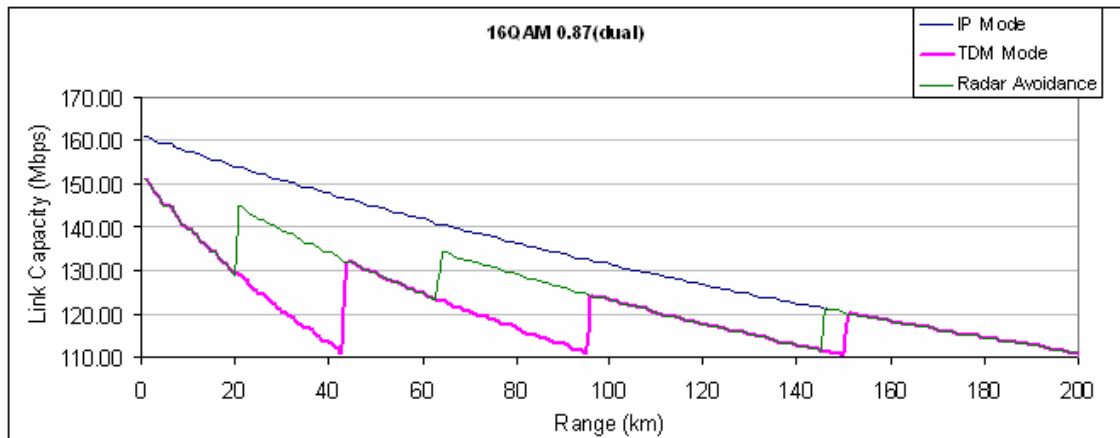

Figure 130 - 16 QAM 0.87 Dual Payload

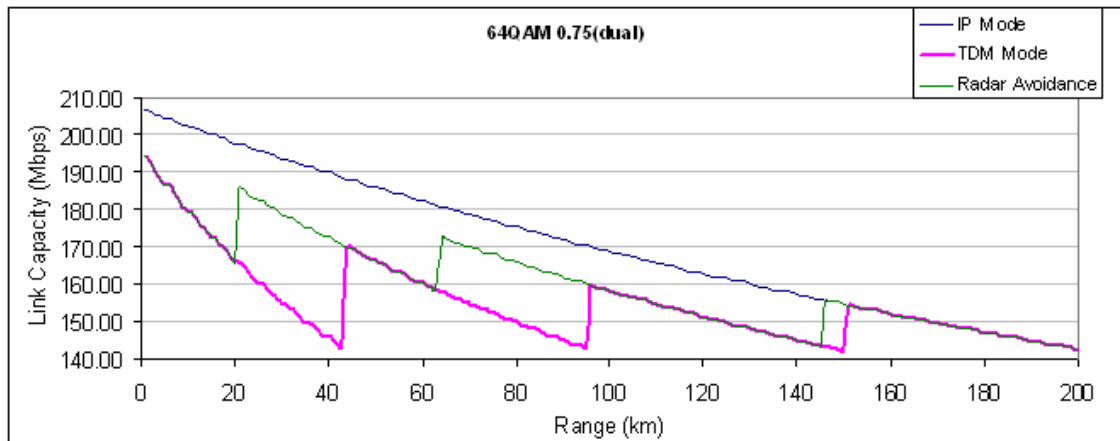

Figure 131 - 64 QAM 0.75 Dual Payload

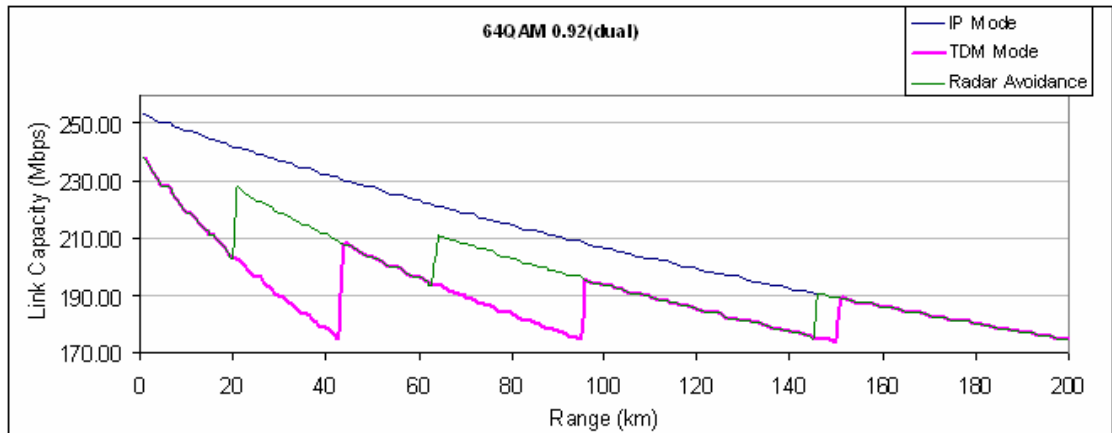

Figure 132 - 64 QAM 0.92 Dual Payload

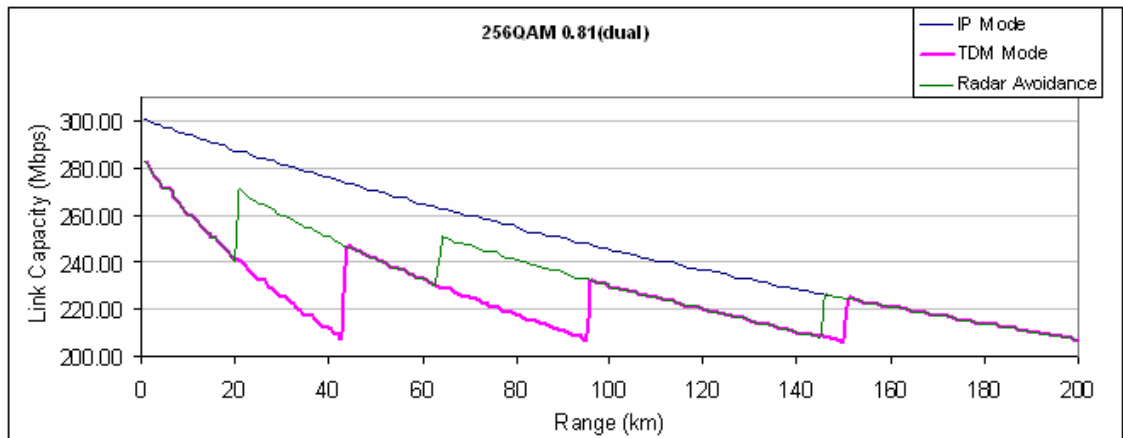

Figure 133 - 256 QAM 0.81 Dual Payload

16 AES Encryption Upgrade

The Motorola PTP 600 Series bridges support link encryption using the NIST approved Advanced Encryption Standard, HFIPS-197H. This standard specifies AES (Rijndael) as a FIPS-approved symmetric encryption algorithm that may be used by U.S. Government organizations (and others) to protect sensitive information.

Link Encryption is not available in the standard PTP 600 Series system. A license key to enable link encryption can be purchased from your Motorola Point-to-Point Distributor or Solutions Provider. AES can be activated on receipt of the activation on the [Motorola Systems Support Page](#).

There are two levels of encryption that are available to purchase:

- 128-bit
- 128 and 256-bit

Option 1 allows the user to encrypt all traffic sent over the wireless link using 128-bit encryption. Option 2 allows the user to encrypt traffic using either 128 or 256-bit encryption. The configuration process for both encryption variants is identical except for the selection of algorithm. The following configuration example is for a 256-bit encryption key.

16.1 Configuring Link Encryption

After purchasing AES encryption for the PTP 600 Series wireless link, two new license keys will be issued, one for each end of the wireless link. The following configuration process gives a step by step guide to enabling AES link encryption on a PTP 600 Series bridge.

16.1.1 License Keys

The first step when configuring link encryption is to enter the new license keys in both 600 Series wireless units.

Software License Key

A valid software license key is required before installation of the PTP (Point to Point) wireless link can commence. If you do not have a valid license key please contact your distributor.

License key data entry

Attributes	Value	Units
License Key	<input style="width: 100%;" type="text" value="AE6F-A4E2-CD55-399B"/>	

Capability summary

Attributes	Value	Units
Product Name	Motorola PTP 58600 Full	
MAC Address	00:04:56:80:0f:ff	
Region Code	1	
Encryption Algorithm	AES 128-bit (Rijndael)	
Frequency Variant	5800 MHz	

Figure 134 – AES Software License Key Data Entry



Figure 134 shows the license key data entry screen. This screen can only be accessed by the system administrator. If you do not have access to the PTP 600 Series system administration pages then please contact your designated system administrator.

It must be noted that configuring link encryption will necessitate a 600 Series bridge service outage. Therefore it is recommended that the configuration process be scheduled during an appropriate period of low link utilization. Motorola recommends the following process for entering new license keys and minimizing service outage.

1. Open two browsers, one for each end of the link
2. Navigate to the 'License Key' data entry page for each end of the link
3. Enter the license keys and click the 'Validate license key' button at each end of the link. This will allow the software to validate the license key prior to the system reset. (DO NOT CLICK ARE YOU SURE POPUP DIALOG)
4. When both license keys have been successfully validated confirm the reboot for both ends of the link. The software is designed to allow five seconds so that a user can command both ends of the link to reset before the wireless link drops.
5. The link will automatically re-establish.

16.1.2 Encryption Mode and Key

Entering the license keys only does not initialize AES link encryption. Link encryption can only be enabled via the Configuration or Installation Wizard pages. Motorola recommends that the Configuration page Figure 135 be used to configure AES link encryption.

Step 2 of 3: Wireless Configuration

Please enter the following wireless configuration parameters

Wireless data entry

Attributes	Value	Units
Target MAC Address	00:04:56: 80 : 0f : c7	
Master Slave Mode	<input checked="" type="radio"/> Master <input type="radio"/> Slave	
Link Mode Optimization	<input checked="" type="radio"/> IP Traffic <input type="radio"/> TDM Traffic	
Encryption Algorithm	<input type="radio"/> None <input checked="" type="radio"/> AES 128-bit (Rijndael)	
Encryption Key	*****	
Max Transmit Power	25	dBm
Ranging Mode	<input checked="" type="radio"/> Auto 0 to 40 km <input type="radio"/> Auto 0 to 100 km <input type="radio"/> Auto 0 to 200 km <input type="radio"/> Target Range	
Target Range	0.0	km
Platform Variant	<input checked="" type="radio"/> Integrated Antenna <input type="radio"/> Connectorized	
Spectrum Management Control	<input checked="" type="radio"/> i_DFS <input type="radio"/> Fixed Frequency	
Lower Center Frequency	5742	MHz
Installation Tones	<input checked="" type="radio"/> Disabled <input type="radio"/> Enabled	

◀ Back
Next ▶▶

Figure 135 – AES Configuration Data Entry Page

Motorola recommends the following process for entering AES link encryption configuration:-

1. Open two browsers, one for each end of the link
2. Navigate to the 'Configuration' data entry page for each end of the link
3. At both ends of the link select the 'AES (Rijndael)' Encryption Algorithm required.
4. At both ends of the link enter either an 128-bit or 256-bit encryption key. Note the key consists of 32/64 case insensitive hexadecimal characters. The same Key must be entered at both ends of the link. Failure to enter the same key will cause the link to fail.
5. Submit configuration on both ends of the link, but do not reboot.

6. Reboot both ends of the link Figure 136. The software is designed to allow five seconds so that a user can command both ends of the link to reboot before the wireless link drops.

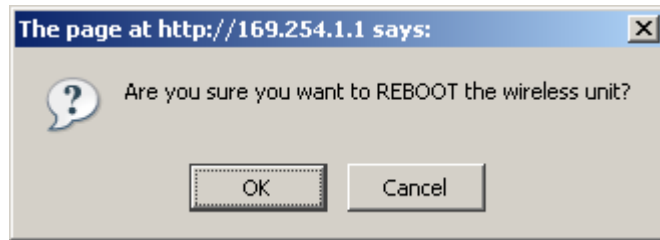

Figure 136 - Configuration Reboot Screen

16.2 Wireless Link Encryption FAQ

16.2.1 Encryption data entry fields are not available

Check that the correct license key has been inserted into the unit. The current license key is displayed on the 'License Key' data entry page.

16.2.2 Link fails to bridge packets after enabling link encryption

If the wireless link status on the status web page indicates that the link is 'Searching', and you can browse to the local end of the link but not to the remote end, then check that the same encryption algorithm and key have been entered at both ends of the link. Failure to enter the same algorithm and key will result in received packets not being decrypted correctly.

17 Legal and Regulatory Notices

17.1 Important Note on Modifications

Intentional or unintentional changes or modifications to the equipment must not be made unless under the express consent of the party responsible for compliance. Any such modifications could void the user's authority to operate the equipment and will void the manufacturer's warranty.

17.2 National and Regional Regulatory Notices – 5.8 GHz variant

17.2.1 U.S. Federal Communication Commission (FCC) and Industry Canada (IC) Notification

This system has achieved Type Approval in various countries around the world. This means that the system has been tested against various local technical regulations and found to comply. The frequency band in which the system operates is 'unlicensed' and the system is allowed to be used provided it does not cause interference. Further, it is not guaranteed protection against interference from other products and installations.

This device complies with part 15 of the US FCC Rules and Regulations and with RSS-210 of Industry Canada. Operation is subject to the following two conditions: (1) This device may not cause harmful interference, and (2) This device must accept any interference received, including interference that may cause undesired operation. In Canada, users should be cautioned to take note that high power radars are allocated as primary users (meaning they have priority) of 5250 – 5350 MHz and 5650 – 5850 MHz and these radars could cause interference and/or damage to license-exempt local area networks (LELAN).

This equipment has been tested and found to comply with the limits for a Class B digital device, pursuant to Part 15 of the US FCC Rules and with RSS-210 of Industry Canada. These limits are designed to provide reasonable protection against harmful interference in a residential installation. This equipment generates, uses, and can radiate radio-frequency energy and, if not installed and used in accordance with these instructions, may cause harmful interference to radio communications. If this equipment does cause harmful interference to radio or television reception, which can be determined by turning the equipment on and off, the user is encouraged to correct the interference by one or more of the following measures:

- Increase the separation between the affected equipment and the unit;
- Connect the affected equipment to a power outlet on a different circuit from that which the receiver is connected to;
- Consult the dealer and/or experienced radio/TV technician for help.
- FCC IDs and Industry Canada Certification Numbers are listed in Table 26

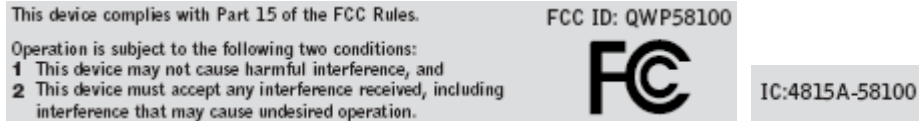

Table 26 - US FCC IDs and Industry Canada certification numbers

Where necessary, the end user is responsible for obtaining any National licenses required to operate this product and these must be obtained before using the product in any particular country. Contact the appropriate national administrations for details on the conditions of use for the bands in question and any exceptions that might apply. Also see www.ero.dk for further information.

17.2.2 European Union Notification

The 5.8 GHz connectorized product is a two-way radio transceiver suitable for use in Broadband Wireless Access System (WAS), Radio Local Area Network (RLAN), or Fixed Wireless Access (FWA) systems. It is a Class 2 device and uses operating frequencies that are not harmonized throughout the EU member states. The operator is responsible for obtaining any national licenses required to operate this product and these must be obtained before using the product in any particular country.

This equipment complies with the essential requirements for the EU R&TTE Directive 1999/5/EC.

The use of 5.8GHz for Point to Point radio links is not harmonized across the EU and currently the product may only be deployed in the UK and Eire (IRL). However, the regulatory situation in Europe is changing and the radio spectrum may become available in other countries in the near future.

This equipment is marked



to show compliance with the European R&TTE directive 1999/5/EC.



The relevant Declaration of Conformity can be found at www.motorola.com/ptp

European Union (EU) Waste of Electrical and Electronic Equipment (WEEE) directive

The European Union's WEEE directive requires that products sold into EU countries must have the crossed out trash bin label on the product (or the package in some cases). As defined by the WEEE directive, this cross-out trash bin label means that customers and end-users in EU countries should not dispose of electronic and electrical equipment or accessories in household waste. Customers or end-users in EU countries should contact their local equipment supplier representative or service center for information about the waste collection system in their country.

17.2.3 UK Notification

The 5.8 GHz connectorized product has been notified for operation in the UK, and when operated in accordance with instructions for use it is compliant with UK Interface Requirement IR2007. For UK use, installations must conform to the requirements of IR2007 in terms of EIRP spectral density against elevation profile above the local horizon in order to protect Fixed Satellite Services. The frequency range 5795-5815 MHz is assigned to Road Transport & Traffic Telematics (RTTT) in the U.K. and shall not be used by FWA systems in order to protect RTTT devices. UK Interface Requirement IR2007 specifies that radiolocation services shall be protected by a Dynamic Frequency Selection (DFS) mechanism to prevent co-channel operation in the presence of radar signals.

Important Note

This equipment operates as a secondary application, so it has no rights against harmful interference, even if generated by similar equipment, and cannot cause harmful interference on systems operating as primary applications.

17.3 National and Regional Regulatory Notices – 5.4 GHz Variant

17.3.1 U.S. Federal Communication Commission (FCC) and Industry Canada (IC) Notification²⁷

This device complies with part 15.407 of the US FCC Rules and Regulations and with RSS-210 Issue 7 of Industry Canada. Operation is subject to the following two conditions: (1) This device may not cause harmful interference, and (2) This device must accept any interference received, including interference that may cause undesired operation. In Canada, users should be cautioned to take note that high power radars are allocated as primary users (meaning they have priority) of 5250 – 5350 MHz and 5650 – 5850 MHz and these radars could cause interference and/or damage to license-exempt local area networks (LELAN).

This equipment has been tested and found to comply with the limits for a Class B digital device, pursuant to Part 15E of the US FCC Rules and with RSS-210 Issue 7 of Industry Canada. These limits are designed to provide reasonable protection against harmful interference in a residential installation. This equipment generates, uses, and can radiate radio-frequency energy and, if not installed and used in accordance with these instructions, may cause harmful interference to radio communications. If this equipment does cause harmful interference to radio or television reception, which can be determined by turning the equipment on and off, the user is encouraged to correct the interference by one or more of the following measures:

- Increase the separation between the affected equipment and the unit;
- Connect the affected equipment to a power outlet on a different circuit from that which the receiver is connected to;
- Consult the dealer and/or experienced radio/TV technician for help.
- FCC IDs and Industry Canada Certification Numbers are listed in Table 27

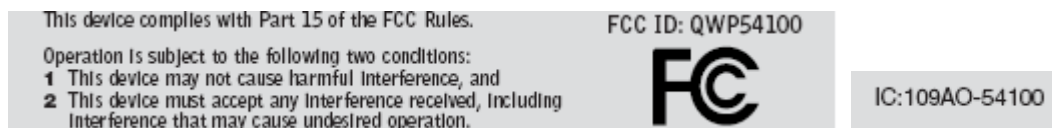

Table 27 - US FCC IDs and Industry Canada certification numbers

²⁷ FCC and IC certification approval applies ONLY to INTEGRATED variant.



Where necessary, the end user is responsible for obtaining any National licenses required to operate this product and these must be obtained before using the product in any particular country. Contact the appropriate national administrations for details on the conditions of use for the bands in question and any exceptions that might apply. Also see www.eor.dk for further information.

17.3.2 European Union Notification

The 5.4 GHz product is a two-way radio transceiver suitable for use in Broadband Wireless Access System (WAS), Radio Local Area Network (RLAN), or Fixed Wireless Access (FWA) systems. It is a Class 2 device and uses operating frequencies that are not harmonized throughout the EU member states. The operator is responsible for obtaining any national licenses required to operate this product and these must be obtained before using the product in any particular country.

This equipment complies with the essential requirements for the EU R&TTE Directive 1999/5/EC.

The use of 5.4GHz for Point to Point radio links is harmonized across the EU.

This equipment is marked



to show compliance with the European R&TTE directive 1999/5/EC.



The relevant Declaration of Conformity can be found at www.motorola.com

European Union (EU) Waste of Electrical and Electronic Equipment (WEEE) directive

The European Union's WEEE directive requires that products sold into EU countries must have the crossed out trash bin label on the product (or the package in some cases). As defined by the WEEE directive, this cross-out trash bin label means that customers and end-users in EU countries should not dispose of electronic and electrical equipment or accessories in household waste. Customers or end-users in EU countries should contact their local equipment supplier representative or service center for information about the waste collection system in their country.



17.4 Exposure

See **Preventing Overexposure to RF** on Page 22.

17.5 Legal Notices

17.5.1 Software License Terms and Conditions

ONLY OPEN THE PACKAGE, OR USE THE SOFTWARE AND RELATED PRODUCT IF YOU ACCEPT THE TERMS OF THIS LICENSE. BY BREAKING THE SEAL ON THIS DISK KIT / CDROM, OR IF YOU USE THE SOFTWARE OR RELATED PRODUCT, YOU ACCEPT THE TERMS OF THIS LICENSE AGREEMENT. IF YOU DO NOT AGREE TO THESE TERMS, DO NOT USE THE SOFTWARE OR RELATED PRODUCT; INSTEAD, RETURN THE SOFTWARE TO PLACE OF PURCHASE FOR A FULL REFUND. THE FOLLOWING AGREEMENT IS A LEGAL AGREEMENT BETWEEN YOU (EITHER AN INDIVIDUAL OR ENTITY), AND MOTOROLA, INC. (FOR ITSELF AND ITS LICENSORS). THE RIGHT TO USE THIS PRODUCT IS LICENSED ONLY ON THE CONDITION THAT YOU AGREE TO THE FOLLOWING TERMS.

Now, therefore, in consideration of the promises and mutual obligations contained herein, and for other good and valuable consideration, the receipt and sufficiency of which are hereby mutually acknowledged, you and Motorola agree as follows:

Grant of License. Subject to the following terms and conditions, Motorola, Inc., grants to you a personal, revocable, non-assignable, non-transferable, non-exclusive and limited license to use on a single piece of equipment only one copy of the software contained on this disk (which may have been pre-loaded on the equipment)(Software). You may make two copies of the Software, but only for backup, archival, or disaster recovery purposes. On any copy you make of the Software, you must reproduce and include the copyright and other proprietary rights notice contained on the copy we have furnished you of the Software.



Ownership. Motorola (or its supplier) retains all title, ownership and intellectual property rights to the Software and any copies, including translations, compilations, derivative works (including images) partial copies and portions of updated works. The Software is Motorola's (or its supplier's) confidential proprietary information. This Software License Agreement does not convey to you any interest in or to the Software, but only a limited right of use. You agree not to disclose it or make it available to anyone without Motorola's written authorization. You will exercise no less than reasonable care to protect the Software from unauthorized disclosure. You agree not to disassemble, decompile or reverse engineer, or create derivative works of the Software, except and only to the extent that such activity is expressly permitted by applicable law.

Termination. This License is effective until terminated. This License will terminate immediately without notice from Motorola or judicial resolution if you fail to comply with any provision of this License. Upon such termination you must destroy the Software, all accompanying written materials and all copies thereof, and the sections entitled Limited Warranty, Limitation of Remedies and Damages, and General will survive any termination.

Limited Warranty. Motorola warrants for a period of ninety (90) days from Motorola's or its customer's shipment of the Software to you that (i) the disk(s) on which the Software is recorded will be free from defects in materials and workmanship under normal use and (ii) the Software, under normal use, will perform substantially in accordance with Motorola's published specifications for that release level of the Software. The written materials are provided "AS IS" and without warranty of any kind. Motorola's entire liability and your sole and exclusive remedy for any breach of the foregoing limited warranty will be, at Motorola's option, replacement of the disk(s), provision of downloadable patch or replacement code, or refund of the unused portion of your bargained for contractual benefit up to the amount paid for this Software License.



THIS LIMITED WARRANTY IS THE ONLY WARRANTY PROVIDED BY MOTOROLA, AND MOTOROLA AND ITS LICENSORS EXPRESSLY DISCLAIM ALL OTHER WARRANTIES, EITHER EXPRESS OF IMPLIED, INCLUDING BUT NOT LIMITED TO IMPLIED WARRANTIES OF MERCHANTABILITY AND FITNESS FOR A PARTICULAR PURPOSE AND NONINFRINGEMENT. MOTOROLA DOES NOT WARRANT THAT THE OPERATION OF THE SOFTWARE WILL BE UNINTERRUPTED OR ERROR-FREE, OR THAT DEFECTS IN THE SOFTWARE WILL BE CORRECTED. NO ORAL OR WRITTEN REPRESENTATIONS MADE BY MOTOROLA OR AN AGENT THEREOF SHALL CREATE A WARRANTY OR IN ANY WAY INCREASE THE SCOPE OF THIS WARRANTY. MOTOROLA DOES NOT WARRANT ANY SOFTWARE THAT HAS BEEN OPERATED IN EXCESS OF SPECIFICATIONS, DAMAGED, MISUSED, NEGLECTED, OR IMPROPERLY INSTALLED. BECAUSE SOME JURISDICTIONS DO NOT ALLOW THE EXCLUSION OR LIMITATION OF IMPLIED WARRANTIES, THE ABOVE LIMITATIONS MAY NOT APPLY TO YOU.

Limitation of Remedies and Damages. Regardless of whether any remedy set forth herein fails of its essential purpose, IN NO EVENT SHALL MOTOROLA OR ANY OF THE LICENSORS, DIRECTORS, OFFICERS, EMPLOYEES OR AFFILIATES OF THE FOREGOING BE LIABLE TO YOU FOR ANY CONSEQUENTIAL, INCIDENTAL, INDIRECT, SPECIAL OR SIMILAR DAMAGES WHATSOEVER (including, without limitation, damages for loss of business profits, business interruption, loss of business information and the like), whether foreseeable or unforeseeable, arising out of the use or inability to use the Software or accompanying written materials, regardless of the basis of the claim and even if Motorola or a Motorola representative has been advised of the possibility of such damage. Motorola's liability to you for direct damages for any cause whatsoever, regardless of the basis of the form of the action, will be limited to the price paid for the Software that caused the damages. THIS LIMITATION WILL NOT APPLY IN CASE OF PERSONAL INJURY ONLY WHERE AND TO THE EXTENT THAT APPLICABLE LAW REQUIRES SUCH LIABILITY. BECAUSE SOME JURISDICTIONS DO NOT ALLOW THE EXCLUSION OR LIMITATION OF LIABILITY FOR CONSEQUENTIAL OR INCIDENTAL DAMAGES, THE ABOVE LIMITATION MAY NOT APPLY TO YOU.

Maintenance and Support. Motorola shall not be responsible for maintenance or support of the software. By accepting the license granted under this agreement, you agree that Motorola will be under no obligation to provide any support, maintenance or service in connection with the Software or any application developed by you. Any maintenance and support of the Related Product will be provided under the terms of the agreement for the Related Product.



Transfer. In the case of software designed to operate on Motorola equipment, you may not transfer the Software to another party except: (1) if you are an end-user, when you are transferring the Software together with the Motorola equipment on which it operates; or 2) if you are a Motorola licensed distributor, when you are transferring the Software either together with such Motorola equipment or are transferring the Software as a licensed duly paid for upgrade, update, patch, new release, enhancement or replacement of a prior version of the Software. If you are a Motorola licensed distributor, when you are transferring the Software as permitted herein, you agree to transfer the Software with a license agreement having terms and conditions no less restrictive than those contained herein. You may transfer all other Software, not otherwise having an agreed restriction on transfer, to another party. However, all such transfers of Software are strictly subject to the conditions precedent that the other party agrees to accept the terms and conditions of this License, and you destroy any copy of the Software you do not transfer to that party. You may not sublicense or otherwise transfer, rent or lease the Software without our written consent. You may not transfer the Software in violation of any laws, regulations, export controls or economic sanctions imposed by the US Government.

Right to Audit. Motorola shall have the right to audit annually, upon reasonable advance notice and during normal business hours, your records and accounts to determine compliance with the terms of this Agreement.

Export Controls. You specifically acknowledge that the software may be subject to United States and other country export control laws. You shall comply strictly with all requirements of all applicable export control laws and regulations with respect to all such software and materials.

US Government Users. If you are a US Government user, then the Software is provided with "RESTRICTED RIGHTS" as set forth in subparagraphs (c)(1) and (2) of the Commercial Computer Software-Restricted Rights clause at FAR 52 227-19 or subparagraph (c)(1)(ii) of the Rights in Technical Data and Computer Software clause at DFARS 252.227-7013, as applicable.



Disputes. You and Motorola hereby agree that any dispute, controversy or claim, except for any dispute, controversy or claim involving intellectual property, prior to initiation of any formal legal process, will be submitted for non-binding mediation, prior to initiation of any formal legal process. Cost of mediation will be shared equally. Nothing in this Section will prevent either party from resorting to judicial proceedings, if (i) good faith efforts to resolve the dispute under these procedures have been unsuccessful, (ii) the dispute, claim or controversy involves intellectual property, or (iii) interim relief from a court is necessary to prevent serious and irreparable injury to that party or to others.

General. Illinois law governs this license. The terms of this license are supplemental to any written agreement executed by both parties regarding this subject and the Software Motorola is to license you under it, and supersedes all previous oral or written communications between us regarding the subject except for such executed agreement. It may not be modified or waived except in writing and signed by an officer or other authorized representative of each party. If any provision is held invalid, all other provisions shall remain valid, unless such invalidity would frustrate the purpose of our agreement. The failure of either party to enforce any rights granted hereunder or to take action against the other party in the event of any breach hereunder shall not be deemed a waiver by that party as to subsequent enforcement of rights or subsequent action in the event of future breaches.

17.5.2 Hardware Warranty in U.S.

Motorola U.S. offers a warranty covering a period of one year from the date of purchase by the customer. If a product is found defective during the warranty period, Motorola will repair or replace the product with the same or a similar model, which may be a reconditioned unit, without charge for parts or labor.

17.5.3 Limit of Liability

IN NO EVENT SHALL MOTOROLA BE LIABLE TO YOU OR ANY OTHER PARTY FOR ANY DIRECT, INDIRECT, GENERAL, SPECIAL, INCIDENTAL, CONSEQUENTIAL, EXEMPLARY OR OTHER DAMAGE ARISING OUT OF THE USE OR INABILITY TO USE THE PRODUCT (INCLUDING, WITHOUT LIMITATION, DAMAGES FOR LOSS OF BUSINESS PROFITS, BUSINESS INTERRUPTION, LOSS OF BUSINESS INFORMATION OR ANY OTHER PECUNIARY LOSS, OR FROM ANY BREACH OF WARRANTY, EVEN IF MOTOROLA HAS BEEN ADVISED OF THE POSSIBILITY OF SUCH DAMAGES. (Some states do not allow the exclusion or limitation of incidental or consequential damages, so the above exclusion or limitation may not apply to you.) IN NO CASE SHALL MOTOROLA'S LIABILITY EXCEED THE AMOUNT YOU PAID FOR THE PRODUCT.

18 Glossary

ARP	Address Resolution Protocol	NLOS	non-Line-of-Sight
ARQ	Automatic Repeat reQuest	ODU	Outdoor Unit
BPSK	Binary Phase Shift Keying	OFDM	Orthogonal Frequency Division Multiplex
DC	Direct Current		
DFS	Dynamic Frequency Selection	PC	IBM Compatible Personal Computer
ETSI	European Telecommunications Standards Institute	PIDU +	Power Indoor Unit
FAQ	Frequently Asked Question	PING	Packet Internet Groper
GPS	Global Positioning System	POE	Power over Ethernet
HP	Hypertext Transfer Protocol	PSU	Power Supply Unit
ID	Identity	PTP	Point-to-Point
IEEE	Institute of Electrical and Electronic Engineers	QAM	Quadrature Amplitude Modulation
IP	Internet Protocol	RAM	Random Access Memory
IQ	In phase / Quadrature	STC	Space Time Coding
ISM	Industrial Scientific and Medical	STP	Shielded Twisted Pair
I	International Telecommunications Union	TCP	Transmission Control Protocol
LAN	Local Area Network	TPC	Transmit Power Control
MAC	Medium Access Control Layer	URL	Universal Resource Location
MDI	Medium Dependent Interface	USA	United States of America
MDIX	Medium Dependent Interface Crossover	UTP	Unshielded Twisted Pair
		UV	Ultraviolet
		VLAN	Virtual Local Area Network

19 FAQs

Can I source and use my own PoE adaptor with the 600 Series bridge? No. The 600 Series bridge uses a non-standard PoE configuration. Failure to use the Motorola supplied Power Indoor Unit could result in equipment damage and will invalidate the safety certification and may cause a safety hazard.

Who is Motorola, Inc.? Motorola, Inc. is a specialist wireless manufacturer with a high quality engineering team that is developing advanced radio solutions that allows high capacity building-to-building bridges to be established even in deep non-line-of-sight conditions.

Why has Motorola launched the 600 Series bridge? The 600 Series bridge is the first product in this band to feature Multiple-Input Multiple-Output (MIMO). The PTP 600 Series solutions allow wireless connections of up to 200km (124 miles) in near line-of-sight conditions and up to 10km (6 miles) in deep non-line-of-sight conditions.

What is Multiple-Input Multiple-Output (MIMO)? The 600 Series bridge radiates multiple beams from the antenna - the effect of which is to significantly protect against fading and to radically increase the probability that the receiver will decode a usable signal. When the effects of MIMO are combined with those of OFDM techniques and a best in class link budget, there is a significant improvement to the probability of a robust connection over a non-line-of-sight path.

What do you mean by “non-line-of-sight”? A wireless connection between two points without optical line-of-sight, i.e., with obstructions between the antennas the transmitted signal is still able to reach the receiver and produce a good quality link.

What else is special about the 600 Series bridge ? There are many special features built-in to the hardware of the 600 Series bridge. The product offers the highest system gain in its class through high sensitivity antennas for improved signal recovery. It also features a Software Defined Radio system that operates on ultra fast digital signal processors but is controlled by firmware giving the ability to download new firmware when enhancements become available. The 600 Series bridge has a built-in web server for advanced management capabilities including detailed radio signal diagnosis.

In which frequency bands does the 600 Series bridge operate? The Motorola point-to-point 600 Series bridge operates in the unlicensed 5.4 GHz (ETSI Band B) and 5.8 GHz (ETSI Band C and FCC ISM band). This means no license is required to operate the 600 Series bridge.



Why does the 600 Series bridge operate in the 5GHz band? The 5 GHz band offers the dual benefits of high data throughput and good radio propagation characteristics. The wide band of spectrum available is subdivided into several channels such that multiple systems can operate in the vicinity without causing interference to one another.

Is the 600 Series bridge an 802.11a device? No, although similar, the 600 Series bridge uses different encoding and radio transmission systems than 802.11a. In areas where 802.11a systems are operating, the 600 Series bridge will detect the 802.11a radio signals and choose a clear channel away from any interference.

How much power does the 600 Series bridge transmit? At all times the 600 Series bridge operates within country / region specific regulations for radio power emissions. In addition, the 600 Series bridge uses a technique known as Transmit Power Control (TPC) to ensure that it only transmits sufficient radio power such that the other antenna can receive a high quality signal.

How does the PTP 600 Series Bridge avoid interference from other devices nearby? At initialization, the 600 Series bridge monitors the available frequency channels to find a channel that is clear of interference. In operation 600 Series bridge continuously monitors the spectrum to ensure it is operating on the cleanest channel.

How does the 600 Series bridge integrate into my data network? The 600 Series bridge acts as a transparent bridge between two segments of your network. In this sense, it can be treated like a virtual wired connection between the two buildings. The 600 Series bridge forwards 802.3 Ethernet packets destined for the other part of the network and filters packets it does not need to forward. The system is transparent to higher-level management systems such as VLANs and Spanning Tree.

How does the 600 Series bridge provide security for data traffic? The 600 Series bridge has a range of security features. At installation time each link must be programmed with the serial ID of its partner. The two ends of the link will only communicate with one another, eliminating any chance of "man in the middle" attacks. Over the air security is achieved through a proprietary scrambling mechanism that cannot be disabled, spoofed or snooped by commercial tools.

Can I use Apple Macintosh OS X to control and monitor my 600 Series bridge? Yes, but there are some restrictions. Mozilla 1.6 or higher is recommended. There are some issues with Internet Explorer 5.2(IE) and Safari, which could mislead the user.



How will my investment be protected as new features are developed? Future enhancements can be downloaded to the unit, meaning advances in technology or changes in regulations can quickly be applied to the system without any further hardware investment.

20 Index

Alarm	67, 68	Management.....	35, 130
Alignment.....	62, 184	MIB	131
antenna.....	23, 171, 172	Mounting.....	34, 50, 59
Antenna	171, 175, 178, 182, 184	Networking.....	44
Architecture.....	36	Password.....	137
Cable Loss.....	175, 178	Path Loss.....	46
Cables.....	56, 182, 185	Planning.....	38, 45
channels	40, 128	Properties	140
Channels.....	116, 121, 123	radio.....	2, 5
Clock.....	133	Radio	154, 237
Compliance.....	235, 236	Reboot	141, 144, 150
Configuration	35, 76, 85, 99, 100, 103, 120, 144, 147, 173	Recovery.....	142
Connecting.....	52, 54, 55, 57, 58, 185, 238	Regulatory	178
Connectors	182	Repair	25
Contact	25	Reset	143, 146
Deployment.....	178	Restore	85
diagnostics.....	72, 136, 137	Safety.....	23
Diagnostics	136	Save.....	85
Disarm	109	Service.....	25
Distance.....	43	SMTP.....	132
EIRP	176	SNMP	131, 132
Environmental.....	237	SNTP	133
Ethernet	26, 80, 93, 152	Software.....	144, 172
Fault Finding.....	151	Spectrum Management	115, 175
Glossary.....	221	Statistics	92
Grounding.....	57	Status.....	70, 172
Installation.....	49, 97, 157, 174, 182, 185, 196	Support	50
IP address.....	61	Surge	34, 56
Licence Key	138	Throughput	47
license.....	36	Tools	49, 182
Lightning	34, 44, 156	Upgrade.....	112, 143, 144
Link Budget.....	178	Warning	68, 69
MAC Address.....	144	Wind.....	167

21 Specifications

21.1 System Specifications

21.1.1 Wireless 5.4GHz Variant

Radio Technology	Specification
RF Band	5.470-5.725GHz
Channel Selection	By dynamic frequency control and manual intervention Automatic detection on start-up and continual adaptation to avoid interference.
Dynamic Frequency Control	Initial capture 10-15 sec. Out of service on interference 100 ms.
Channel size	30 MHz
Manual Power Control	Maximum power can be controlled lower than the power limits shown above in order to control interference to other users of the band.
Receiver Noise Figure	Typically 6 dB

The receive sensitivities and system gains for each mode are as follows:

Mode	Receive Sensitivity (dBm)	Transmit Power (dBm)	Link Budget (dB)
BPSK 0.63 single	-88.9	+25	160.9
QPSK 0.63 single	-85.9	+24	156.9
QPSK 0.87 single	-82.4	+23	152.4
16QAM 0.63 single	-80.1	+22	149.1
16QAM 0.63 dual	-77.0	+22	146.0
16QAM 0.87 single	-75.9	+20	142.9
16QAM 0.87 dual	-71.8	+20	138.8
64QAM 0.75 single	-73.0	+18	138.0
64QAM 0.75 dual	-68.6	+18	133.6
64QAM 0.92 single	-67.6	+18	132.6
256QAM 0.81 single	-65.4	+18	130.4
64QAM 0.92 dual	-63.9	+18	128.9
256QAM 0.81 dual	-61.0	+18	126.0

Table 28 - Receive Sensitivity and System Gains

The values for Receive Sensitivity are typical values in a flat radio channel for an Ethernet frame loss rate of 3E-5. For minimum error rates on TDM links the maximum modulation mode should be limited to 64QAM 0.75.

The un-shaded value above (BPSK) is a static receive sensitivity measurement. The shaded values above are static receive sensitivity measurements with an AMOD threshold applied. The AMOD threshold applied is for a benign radio channel.

Antenna	
Antenna Type	Integrated flat plate antenna
Antenna Gain	23 dBi typical
Antenna Beamwidth	8 Degrees

Wireless PHY	
Max Path Loss	161 dB
Duplex Scheme	TDD, Symmetric (1:1)
Range	125 miles (200km) optical Line-of-Sight 6 miles (10km) non-Line-of-Sight
Over-the-Air Encryption	Proprietary scrambling mechanism.
Weather Sensitivity	Sensitivity at higher modes may be reduced during high winds through trees due to Adaptive Modulation Threshold changes
Error Correction	FEC

21.1.2 Wireless 5.8GHz Variant

Radio Technology	Specification
RF Band	5.725-5.850GHz
Channel Selection	By dynamic frequency control and manual intervention Automatic detection on startup and continual adaptation to avoid interference.
Dynamic Frequency Control	Initial capture 10-15 sec. Out of service on interference 100 ms.
Channel size	30 MHz
Manual Power Control	Maximum power can be controlled lower than the power limits shown above in order to control interference to other users of the band.
Receiver Noise Figure	Typically 6 dB

The receive sensitivities and system gains for each mode are as follows:

Mode	Receive Sensitivity (dBm)	Transmit Power (dBm)	Link Budget (dB)
BPSK 0.63 single	-88.1	+25	160.1
QPSK 0.63 single	-84.6	+24	155.6
QPSK 0.87 single	-81.6	+23	151.6
16QAM 0.63 single	-79.3	+22	148.3
16QAM 0.63 dual	-75.2	+22	144.2
16QAM 0.87 single	-74.8	+20	141.8
16QAM 0.87 dual	-71.0	+20	138.0
64QAM 0.75 single	-71.7	+18	136.7
64QAM 0.75 dual	-68.1	+18	133.1
64QAM 0.92 single	-65.9	+18	130.9
256QAM 0.81 single	-64.0	+18	129.0
64QAM 0.92 dual	-62.0	+18	127.0
256QAM 0.81 dual	-59.1	+18	124.1

Table 29 - Receive Sensitivity and System Gains

The values for Receive Sensitivity are typical values in a flat radio channel for an Ethernet frame loss rate of 3E-5. For minimum error rates on TDM links the maximum modulation mode should be limited to 64QAM 0.75.

The un-shaded value above (BPSK) is a static receive sensitivity measurement. The shaded values above are static receive sensitivity measurements with an AMOD threshold applied. The AMOD threshold applied is for a benign radio channel.

Antenna	
Antenna Type	Integrated flat plate antenna
Antenna Gain	23 dBi typical
Antenna Beamwidth	8 Degrees

Wireless PHY	
Max Path Loss	161 dB
Duplex Scheme	TDD, Symmetric (1:1)
Range	125 miles (200km) optical line-of-sight 6 miles (10km) non-line-of-sight
Over-the-Air Encryption	Proprietary scrambling mechanism.
Weather Sensitivity	Sensitivity at higher modes may be reduced during high winds through trees due to Adaptive Modulation Threshold changes
Error Correction	FEC

21.1.3 Management

Management	
Status Indication	Power status Ethernet Link Status Data activity
Installation	Web server and browser for setup Audio tone feedback during installation , plus graphical installation tool suitable for laptop and PDA computing devices Web server for confirmation
Radio Performance and Management	Via web server and browser, SNMP
Alarms	Via configurable email alerts, SNMP

Ethernet Bridging	
Protocol	IEEE802.1; IEEE802.1p; IEEE802.3 compatible
Interface	10/100/1000BaseT (RJ-45), Supports MDI/MDIX Auto Crossover
Data Rates	See Section 15

Note: Practical Ethernet rates will depend on network configuration, higher layer protocols and platforms used.



Warning: Over the air throughput will be capped to the rate of the Ethernet interface at the receiving end of the link.

21.1.4 Physical

Physical Integrated	
Dimensions	Width 14.5" (370mm), Height 14.5" (370mm), Depth 3.75" (95mm)
Weight	12.1 lbs (5.5 Kg) including bracket

Physical Connectorized	
Dimensions	Width 12" (305mm), Height 12" (305mm), Depth 4.01" (105mm)
Weight	9.1 lbs (4.3 Kg) including bracket

21.1.5 Powering

Power Supply	Separate power supply unit (included)
Dimensions	Width 9.75" (250mm), Height 1.5" (40mm), Depth 3" (80mm)
Weight	1.9 lbs (0.864 Kg)
Power source	90 – 264 VAC, 50 – 60 Hz / 36 – 60 VDC
Power consumption	55 W max

21.1.6 Telecoms Interface

Telecoms	
Interfaces	2 E1 balanced 120R or 2 T1 balanced 100R over a CAT5 screened twisted pair cable
Jitter and Wander	Compliant with G.823/ G.824.
Surge Protection and Power Cross	Compliant with GR1089, EN60950, K20, K21).

21.2 Safety Compliance

21.2.1 5.4 GHz Variant

Region	Specification
USA	UL 60950
Canada	CSA C22.2 No.60950
International	CB certified & certificate to IEC 60950

21.2.2 5.8GHz Variant

Region	Specification
USA	UL 60950
Canada	CSA C22.2 No.60950
International	CB certified & certificate to IEC 60950

21.3 EMC Emissions Compliance

21.3.1 5.4GHz Variant

Region	Specification
USA	FCC Part 15 Class B
Canada	CSA Std C108.8, 1993 Class B
Europe	EN55022 CISPR 22

21.3.2 5.8GHz Variant

Region	Specification
USA	FCC Part 15 Class B
Canada	CSA Std C108.8, 1993 Class B
Europe	EN55022 CISPR 22

21.4 EMC Immunity Compliance

Top-level Specification ETSI 301-489.

Specification	Comment
EN 55082-1 Generic EMC and EMI requirements for Europe	
EN 61000-4-2: 1995 Electro Static Discharge (ESD), Class 2, 8 kV air, 4 kV contact discharge	Testing will be carried to ensure immunity to 15kV air and 8kV contact
EN 61000-4-3: 1995 ENV50140: 1993 (radiated immunity) 3 V/m	
EN 61000-4-4: 1995 (Bursts/Transients), Class 4, 4 kV level (power lines AC & DC)	Signal lines @ 0.5 kV open circuit voltage.
EN 6100045:1995, (Surge Immunity)	Requires screened connection to users network
EN 61000-4-6: 1996 (Injected RF), power line, Class 3 @ 10 V/m	Signal lines, Class 3 @ 3 V RMS un-modulated.

21.5 Radio Certifications

21.5.1 5.4GHz Variant

Region	Specification (Type Approvals)
USA	FCC Part 15.407
EU	EN301 893 V1.2.3/V1.3.1
CANADA	RSS 210 Issue 7

21.5.2 5.8GHz Variant

Region	Specification (Type Approvals)
USA	FCC Part 15.247
CANADA	RSS 210 Issue 7
UK	IR 2007
Eire	ComReg 03/42

21.6 Environmental Specifications

Category	Specification
Temperature	ODU: -40°F (-40°C) to 140°F (+60°C) PIDU Plus: 32°F (0°C) to 104°F(+40°C) PIDU Plus: -40°F (-40°C) to 140°F (+60°C)
Wind Loading	150mph Max (242kph). See section 12 for a full description.
Humidity	100% Condensing
Waterproof	IP65 (ODU), IP53 (PIDU Plus)
UV Exposure	10 year operational life (UL746C test evidence)

21.7 System Connections

21.7.1 PIDU Plus to ODU and ODU to Network Equipment Connections



Figure 137 - Cable Connection Diagram (T568B Color Coding)

Telecoms	Connector Pinout Signal Name
Pin 1	E1T1A_TX-
Pin 2	E1T1A_TX+
Pin 3	E1T1A_RX-
Pin 4	E1T1B_TX-
Pin 5	E1T1B_TX+
Pin 6	E1T1A_RX+
Pin 7	E1T1B_RX-
Pin 8	E1T1B_RX+

Table 30 - Telecoms Connection Pin Out



Unit A1, Linhay Business Park
Eastern Road, Ashburton
Devon, TQ 13 7UP, UK
Telephone Support: +1 877 515-0400
www.motorola.com/ptp