



REGULATORY USER GUIDE

60 GHz cnWave Products

System Release 1.0



Accuracy

While reasonable efforts have been made to assure the accuracy of this document, Cambium Networks assumes no liability resulting from any inaccuracies or omissions in this document, or from use of the information obtained herein. Cambium reserves the right to make changes to any products described herein to improve reliability, function, or design, and reserves the right to revise this document and to make changes from time to time in content hereof with no obligation to notify any person of revisions or changes. Cambium does not assume any liability arising out of the application or use of any product, software, or circuit described herein; neither does it convey license under its patent rights or the rights of others. It is possible that this publication may contain references to, or information about Cambium products (machines and programs), programming, or services that are not announced in your country. Such references or information must not be construed to mean that Cambium intends to announce such Cambium products, programming, or services in your country.

Copyrights

This document, Cambium products, and 3rd Party software products described in this document may include or describe copyrighted Cambium and other 3rd Party supplied computer programs stored in semiconductor memories or other media. Laws in the United States and other countries preserve for Cambium, its licensors, and other 3rd Party supplied software certain exclusive rights for copyrighted material, including the exclusive right to copy, reproduce in any form, distribute and make derivative works of the copyrighted material. Accordingly, any copyrighted material of Cambium, its licensors, or the 3rd Party software supplied material contained in the Cambium products described in this document may not be copied, reproduced, reverse engineered, distributed, merged or modified in any manner without the express written permission of Cambium. Furthermore, the purchase of Cambium products shall not be deemed to grant either directly or by implication, estoppel, or otherwise, any license under the copyrights, patents or patent applications of Cambium or other 3rd Party supplied software, except for the normal non-exclusive, royalty free license to use that arises by operation of law in the sale of a product.

Restrictions

Software and documentation are copyrighted materials. Making unauthorized copies is prohibited by law. No part of the software or documentation may be reproduced, transmitted, transcribed, stored in a retrieval system, or translated into any language or computer language, in any form or by any means, without prior written permission of Cambium.

LicenseAgreements

The software described in this document is the property of Cambium and its licensors. It is furnished by express license agreement only and may be used only in accordance with the terms of such an agreement.

HighRisk Materials

Cambium and its supplier(s) specifically disclaim any express or implied warranty of fitness for any high-risk activities or uses of its products including, but not limited to, the operation of nuclear facilities, aircraft navigation or aircraft communication systems, air traffic control, life support, or weapons systems ("High Risk Use").

This product is not restricted in the EU. Any High Risk is unauthorized, is made at your own risk and you shall be responsible for any and all losses, damage or claims arising out of any High-Risk Use.

Contents

Contents	3
Chapter 1: About This User Guide	7
Purpose.....	7
Cross-references	7
Feedback.....	7
Important regulatory information	7
Complying with rules for the country of operation.....	7
Application firmware	9
Ethernet networking skills	9
Lightning protection	10
Specific expertise and training for professional installers	10
Problems and warranty	10
Reporting problems	10
Repair and service.....	10
Hardware warranty	10
Warnings, cautions, and notes	11
In non-EU countries.....	12
Chapter 2: Product Description	13
Purpose.....	13
Introduction to 60 GHz.....	13
Understanding of 60 GHz.....	13
Frequency bands	13
Characteristics of 60 GHz	14
Introduction to 802.11ay and advantages	15
Hardware overview	16
V1000 – Mid Gain Client node	16
V3000 – High Gain Client node.....	17
V5000 – Distribution node	18
Modulation	19
Wireless security and protocols	19
IPv6.....	19

Chapter 3: System Hardware.....	20
Wireless nodes	20
V1000 Client Node	20
V3000 Client Node	21
V5000 Distribution Node	22
Radio mounting brackets	23
Radio Accessories.....	28
Radio External Interfaces	29
Radio specifications	31
Power supply units (PSU)	32
V1000 power over Ethernet	32
V3000, V5000 power over Ethernet	33
V3000, V5000 DC power supply	34
PSU part numbers	35
PSU specifications	36
Ethernet and DC cables	38
Cable accessories	40
SFP module kits	41
Chapter 4: System planning.....	42
Site planning	42
Grounding and lightning protection	42
ODU location.....	43
Drop cable grounding points.....	43
PSU DC power supply.....	44
PSU AC power supply	44
PSU location	44
Outdoor AC PSU.....	44
Chapter 5: Legal and Regulatory information	45
Definitions	45
Acceptance of this agreement.....	45
Grant of license.....	46
Conditions of use	46
Title and restrictions	46
Confidentiality	47

Right to use Cambium’s name	47
Transfer	47
Updates	47
Maintenance	47
Disclaimer	48
Limitation of liability.....	48
U.S. government.....	48
Term of license.....	48
Governing law.....	49
Assignment.....	49
Survival of provisions	49
Entire agreement.....	49
Third party software	49
Compliance with safety standards.....	49
Electrical safety compliance	49
FCC compliance	54
ISED compliance.....	54
Chapter 6: Installation.....	56
Safety.....	56
Power lines	56
Working at heights	56
PSU	56
Grounding and protective earth.....	56
AC supply.....	56
Powering down before servicing.....	56
Primary disconnect device	56
External cables	57
Drop cable tester.....	57
RF exposure near the antenna	57
60 GHz cnWave radios and mounting bracket options	58
Installing the cnWave radio nodes.....	58
Mount the radio on the mast.....	59
Install the PSU.....	66
Installing the V1000 power injector.....	68

[Intentionally Blank]

Chapter 1: About This User Guide

This document explains how to deploy the 60 GHz products along with important safety measures. It is intended for use by the system designer, system installer and system administrator.

Purpose

Cambium Networks 60 GHz products documents are intended to instruct and assist personnel in the operation, installation, and maintenance of the equipment and ancillary devices. It is recommended that all personnel engaged in such activities be properly trained.

Cambium Networks disclaims all liability whatsoever, implied or express, for any risk of damage, loss or reduction in system performance arising directly or indirectly out of the failure of the customer, or anyone acting on the customer's behalf, to abide by the instructions, system parameters, or recommendations made in this document.

Cross-references

References to external publications are shown in italics. Other cross-references, emphasized in blue text in electronic versions, are active links to the references.

This document is divided into numbered chapters that are divided into sections. Sections are not numbered but are individually named at the top of each page, and are listed in the table of contents.

Feedback

We appreciate feedback from the users of our documents. This includes feedback on the structure, content, accuracy, or completeness of our documents. To provide feedback, visit our support website: <https://support.cambiumnetworks.com>.

Important regulatory information

Complying with rules for the country of operation

USA specific information



Caution

This device complies with Part 15 of the FCC Rules. Operation is subject to the following two conditions:

- This device may not cause harmful interference, and
- This device must accept any interference received, including interference that may cause undesired operation.



NOTE: This equipment has been tested and found to comply with the limits for a Class B digital device, pursuant to part 15 of the FCC Rules. These limits are designed to provide reasonable protection against harmful interference in a residential installation. This equipment generates, uses and can radiate radio frequency energy and, if not installed and used in accordance with the instructions, may cause harmful interference to radio communications. However, there is no guarantee that interference will not occur in a particular installation. If this equipment does cause harmful interference to radio or television reception, which can be determined by turning the equipment off and on, the user is encouraged to try to correct the interference by one or more of the following measures:

- Reorient or relocate the receiving antenna.
- Increase the separation between the equipment and receiver.
- Connect the equipment into an outlet on a circuit different from that to which the receiver is connected.
- Consult the dealer or an experienced radio/TV technician for help.

Canada specific information

Caution

This device complies with ISED's license-exempt RSSs. Operation is subject to the following two conditions:

- This device may not cause interference; and
- This device must accept any interference, including interference that may cause undesired operation of the device.



Renseignements spécifiques au Canada

Attention

Le présent appareil est conforme aux CNR d'Industrie Canada applicables aux appareils radio exempts de licence. L'exploitation est autorisée aux deux conditions suivantes :

- l'appareil ne doit pas produire de brouillage, et
- l'utilisateur de l'appareil doit accepter tout brouillage radioélectrique subi, même si le brouillage est susceptible d'en compromettre le fonctionnement.



European specific information

Cambium Networks 60 GHz cnWave™ products are compliant with applicable European Directives required for CE marking:

- 2014/53/EU of the European Parliament and of the Council of 16 April 2014 on the harmonisation of the laws of the Member States relating to the making available on the market of radio equipment and repealing Directive 1999/5/EC; Radio Equipment Directive (RED)
- 2011/65/EU of the European Parliament and of the Council of 8 June 2011 on the restriction of the use of certain hazardous substances in electrical and electronic equipment (RoHS Directive).

EU Declaration of Conformity

Hereby, Cambium Networks declares that the Cambium Networks 60 GHz cnWave™ Series of Wireless Ethernet Bridge complies with the essential requirements and other relevant provisions of Directive 2014/53/EU. The declaration of conformity may be consulted at: https://www.cambiumnetworks.com/eu_dofc.

Application firmware

Download the latest 60GHz products family software and install it in the Outdoor Units (ODUs) before deploying the equipment. Instructions for installing software are provided in this guide.

Ethernet networking skills

The installer must have the ability to configure IP addressing on a PC and to set up and control products using a web browser interface.

Lightning protection

To protect outdoor radio installations from the impact of lightning strikes, the installer must be familiar with the normal procedures for site selection, bonding and grounding. Installation guidelines for the 60 GHz cnWave Family can be found in [Chapter 2: System hardware](#) and [Chapter 3: System planning](#).

Specific expertise and training for professional installers

To ensure that the 60 GHz cnWave™ Series are installed and configured in compliance with the requirements of the EU, ISEDC and the FCC, installers must have the radio engineering skills and training described in this section.

The Cambium Networks technical training program details can be accessed from below link:

<https://www.cambiumnetworks.com/training/>

Problems and warranty

Reporting problems

If any problems are encountered when installing or operating this equipment, follow this procedure to investigate and report:

1. Search this document and the software release notes of supported releases.
2. Visit the support website (<http://www.cambiumnetworks.com/support>).
3. Ask for assistance from the Cambium product supplier.
4. Gather information from affected units, such as any available diagnostic downloads.
5. Escalate the problem by emailing or telephoning support.

Repair and service

If unit failure is suspected, obtain details of the Return Material Authorization (RMA) process from the support website (<http://www.cambiumnetworks.com/support>).

Hardware warranty

Cambium's standard hardware warranty is for one (1) year from date of shipment from Cambium Networks or a Cambium distributor. Cambium Networks warrants that hardware will conform to the relevant published specifications and will be free from material defects in material and workmanship under normal use and service. Cambium shall within this time, at its own option, either repair or replace the defective product within thirty (30) days of receipt of the defective product. Repaired or replaced product will be subject to the original warranty period but not less than thirty (30) days.

To register positioner products or activate warranties, visit the support website. For warranty assistance, contact the reseller or distributor. The removal of the tamper-evident seal will void the warranty.



Caution

Using non-Cambium parts for repair could damage the equipment or void warranty. Contact Cambium for service and repair instructions.

Portions of Cambium equipment may be damaged from exposure to electrostatic discharge. Use precautions to prevent damage.

Security advice

Cambium Networks systems and equipment provide security parameters that can be configured by the operator based on their particular operating environment. Cambium recommends setting and using these parameters following industry recognized security practices. Security aspects to be considered are protecting the confidentiality, integrity, and availability of information and assets. Assets include the ability to communicate, information about the nature of the communications, and information about the parties involved.

In certain instances, Cambium makes specific recommendations regarding security practices, however the implementation of these recommendations and final responsibility for the security of the system lies with the operator of the system.

Warnings, cautions, and notes

The following describes how warnings and cautions are used in this document and all Cambium Networks document sets:

Warnings

Warnings precede instructions that contain potentially hazardous situations. Warnings are used to alert the reader to possible hazards that could cause loss of life or physical injury. A warning has the following format:



Warning

Warning text and consequence for not following the instructions in the warning.

Cautions

Cautions precede instructions and are used when there is a possibility of damage to systems, software, or individual items of equipment within a system. However, this damage presents no danger to personnel. A caution has the following format:



Caution

Caution text and consequence for not following the instructions in the caution.

Notes

A note means that there is a possibility of an undesirable situation or provides additional information to help the reader understand a topic or concept. A note has the following format:



Note

Note text.

Caring for the environment

The following information describes national or regional requirements for the disposal of Cambium Networks supplied equipment and for the approved disposal of surplus packaging.

In EU countries

The following information is provided to enable regulatory compliance with the European Union (EU) directives identified and any amendments made to these directives when using Cambium equipment in EU countries.

In accordance with 2014/53/EU Radio Equipment Directive (RED) Article 10(10) the packaging of 60 GHz cnWave products includes a pictogram compliant with Implementing Directive 2017/1354/EU identifying the member states within the EU where a restriction on putting into service or a requirement for authorization of use applies. In the case of 60 GHz cnWave products the spectrum is unlicensed and harmonised, compliance with the essential requirements of the RED Article 3.2 apply.

Disposal of Cambium equipment

European Union (EU) Directive 2002/96/EC Waste Electrical and Electronic Equipment (WEEE).

Do not dispose of Cambium equipment in landfill sites. For disposal instructions, refer to <http://www.cambiumnetworks.com/support/weee-compliance>

Disposal of surplus packaging

Do not dispose of surplus packaging in landfill sites. In the EU, it is the individual recipient's responsibility to ensure that packaging materials are collected and recycled according to the requirements of EU environmental law.

In non-EU countries

In non-EU countries, dispose of Cambium equipment and all surplus packaging in accordance with national and regional regulations.

Chapter 2: Product Description

Purpose

Cambium Networks' 60 GHz cnWave solution provides easy, fast and cost-effective wireless gigabit connectivity for edge access and/or high-capacity backhaul for edge access solutions at a significantly lower TCO than fiber infrastructure. Service providers and enterprises now have access to Gigabit for business and residential connectivity, backhaul for Wi-Fi access or LTE/5G small cell. Certified for Facebook Terragraph, cnWave mesh solutions are highly efficient at handling high-density deployments in cities and suburban areas.

Introduction to 60 GHz

The 60 GHz band boasts a wide spectrum of up to 12 GHz that is typically divided into channels of roughly 2 GHz each. It is largely uncongested compared to the 2.5 GHz and 5 GHz public bands currently used for Wi-Fi. The 60 GHz band is a millimeter wave band that can provide massive speeds and throughput with Line of Sight (LOS) applications.

Understanding of 60 GHz

The V band is located in the millimeter-wave portion of the electromagnetic spectrum, where the wavelength varies from 10 mm (30 GHz) down to 1 mm (300 GHz).

The millimeter-wave portion of the RF spectrum has been largely unexploited for commercial wireless applications. In addition to the high-data rates that can be accomplished in this spectrum, energy propagation in the 60 GHz band has unique characteristics that make possible many other benefits such as excellent immunity to interference, high security, and frequency re-use.

Frequency bands

60 GHz is divided into 11 channels each with bandwidth of 2.16 GHz starting from **57.24** to **70.2 GHz**. Channel 1 to 6 has 2.16 GHz bandwidth and are defined in 802.11ad, channel 9 to 13 has 4.32 GHz bandwidth and are added in 802.11ay.

Channel 9 to 13 uses Channel Bonding feature to combine adjacent channel to create wider channel bandwidth

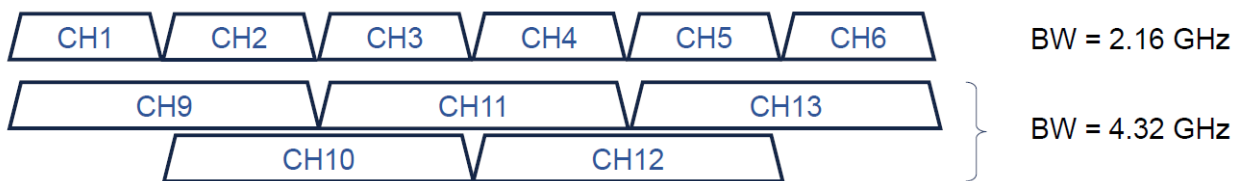

Figure 1 : Frequency bands

The following table describes the channels and corresponding bandwidths:

Channel	Bandwidth(GHz)	Center (GHz)	Min. (GHz)	Max. (GHz)
1	2.16	58.32	57.24	59.40
2	2.16	60.48	59.40	61.56
3	2.16	62.64	61.56	63.72
4	2.16	64.80	63.72	65.88
5	2.16	66.96	65.88	68.04

6	2.16	69.12	68.04	70.20
9	4.32	59.40	57.24	61.56
10	4.32	61.56	59.40	63.72
11	4.32	63.72	61.56	65.88
12	4.32	65.88	63.72	68.04
13	4.32	68.04	65.88	70.20

Characteristics of 60 GHz

Here are some of the important 60 GHz characteristics:

- **High Throughput capability**

With multi-gigabit channel bandwidth, it is possible to gain multi-gigabit capacity, based on 802.11ad it is possible to get 5 Gbps PHY rate and with 802.11ay it is possible to get 10 Gbps PHY rate. cnWave products are capable of providing 15 Gbps with channel bonding enabled.

- **Unlicensed and interference free**

Typically, V Band is either unlicensed or lightly licensed band and since this band is relatively newly opening there would be limited interference compared to 2.4 and 5 GHz bands.

- **Line of Sight**

60 GHz is affected by oxygen absorption, it varies throughout the band. The absorption gets reduced if the frequency gets increased. For example, the absorption is 15 dB/km in 60 GHz frequency, 5 dB/km in 64 GHz and 0.5 dB/km in 68 GHz. If the total channel is divided into 6 channels, then the mid channel that is channels 2 and 3 has more absorption loss. From channel 4, the absorption level starts to drop. So only Line of Sight links are available & Near LOS or non LOS does not work with 60 GHz.

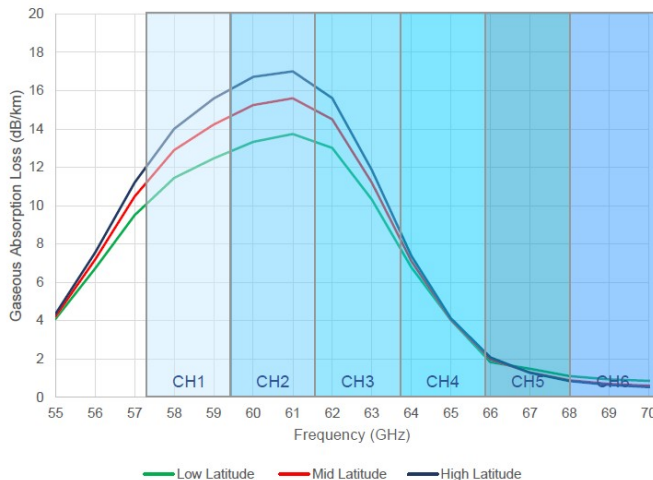

- **Rain fade**

User can expect to see significant rain fade for 60 GHz links, particularly those pushing the longer distances. Attenuation depends on the rain rate which must be factored in while planning the network. Rain attenuation (water absorption due to rain) depends on the level of the rain. The following table describes the rain level and absorption loss:

Rain	Attenuation
Drizzle (0.25 mm/hr)	0.2 dB/km
Light Rain (2.5 mm/hr)	1.8 dB/km
Medium Rain (12.5 mm/hr)	5.6 dB/km
Heavy Rain (25 mm/hr)	9.5 dB/km
Downpour (50 mm/hr)	17 dB/km
Tropical (100 mm/hr)	28 dB/km
Monsoon (200 mm/hr)	38 dB/km

- **Short range**

The max range of 60 GHz links are limited to up to 2 km under best of circumstances. The range gets limited due to oxygen absorption and rain fade which needs to be factored in for link planning. One advantage of shorter range is frequency re-usability and security (since the signal does not travel long distances).

Introduction to 802.11ay and advantages

802.11ay is IEEE standard which covers 60 GHz, this is standard is an upgrade from 802.11ad standard. There are 802.11 ay is designed with a higher throughput capacity of over 10 Gbps data rate over distances of 200 to 500 meters. 802.11ay includes features such as **Channel Bonding** and **Synchronization**. 802.11ay based 60 GHz solution really transforms fixed wireless access from a broadband option of last resort into a competitive alternative to fiber and cable-based solution.

802.11ay standard has following advantages with Terragraph solution:

- **Channel Bonding**

802.11ay **standard** has channel bonding capability to combine adjacent channels to form wider channels, in this case wider channel combine to form 4.32 GHz, there are additional wider channels created which provide double capacity throughput compared to 802.11 ad standard.

- **Network Synchronization**

Synchronization is used to control the transmit and receive signals to prevent self-interference. Radios assigned with the same polarity will be transmitting and receiving at the same time.

There are two types of polarity:

- Odd Polarity
- Even Polarity

- **Mesh Routing**

Mesh is interconnection among devices which could have multiple paths between any two nodes, some advantages of using mesh are better connectivity, capacity sharing, Load balancing and re-routing in case of link failure.

Hardware overview

Cambium Networks 60 GHz solution consists of Distribution Node which act as Access Point but can connect to other DN. V5000 is Dual radio Distribution Node. There are two Client node V3000 and V1000 which act as Subscriber Module, they can also be operated in Point to Point mode.

V1000 – Mid Gain Client node

60 GHz cnWave V1000 is featured with wide-range, 80 degrees beamforming for easy installation. It is powered by 802.3af PoE and supports up to 2 Gbps with 1 Gbps in the uplink direction and 1 Gbps in the downlink direction.

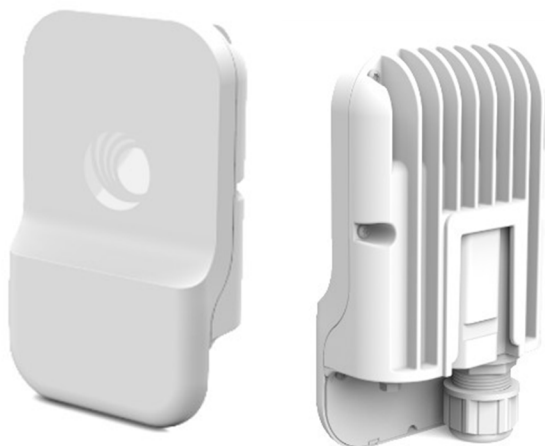

Figure 3 : V1000 – Mid Gain Client node

Frequency	57 to 66 GHz
Modulation	BPSK to 16 QAM (MCS 1 to MCS 12) with ACM
Throughput	1 Gbps Uplink + 1 Gbps Downlink
EIRP	38 dBm
Antenna gain with beam forming	<ul style="list-style-type: none">• +/- 40.0 (Azimuth), +/- 20.0 (Elevation)• 22.5dBi (Antenna Gain)
Low latency	<1 ms
Data interface	1 x 1 GE + PoE in (802.3af)
Power consumption	10 W
Physical	<ul style="list-style-type: none">• IP66/67• 140x85x40mm(5.5x3.3x1.6Inches),0.25 kg (0.55 lbs.)• -40to+60°C(-40to+140°F)

V3000 – High Gain Client node

60 GHz cnWave V3000 is featured with a 44.5 dBi high-gain antenna with beamforming. The client nodes can support up to 7.6 Gbps with channel bonding for both PMP and PTP configurations.

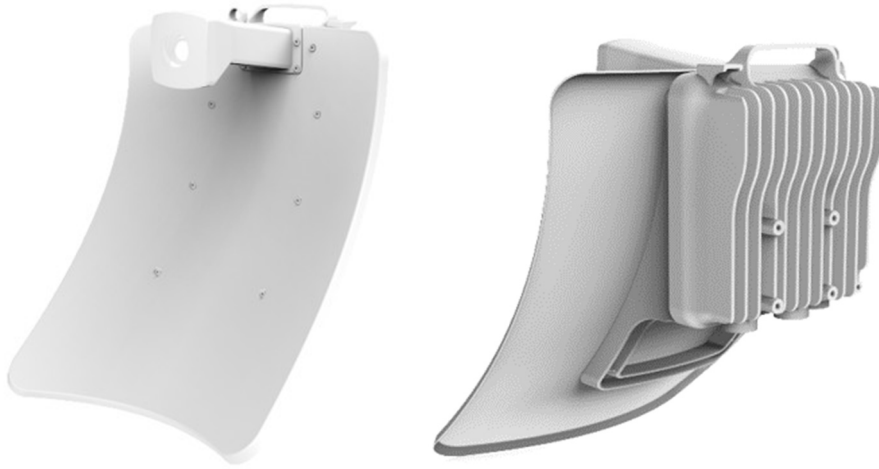

Figure 4 : V3000 – High Gain Client node

Frequency	57 to 66 GHz
Modulation	BPSK to 16 QAM (MCS 0 to MCS 12) with ACM
Throughput	<ul style="list-style-type: none"> ▮ 1.9GbpsUplink+1.9bpsDownlink ▮ 3.8GbpsUplink+3.8GbpsDownlinkwithchannel bonding*
EIRP	60.0 dBm (EU and CEPT Countries Limited to 55 dBm)
Ultra high antenna gain with beam forming	<ul style="list-style-type: none"> ▮ +/-2.0(Azimuth),+/-1.0(Elevation) ▮ 44.5dBi AntennaGain
Synchronization	IEEE-1588 TC*
Low latency	< 1 ms
Data interface	<ul style="list-style-type: none"> • 1x10GE+PoEin(Passive) • 1x1GE+PoEout(802.3at) - 1xSFP+
Physical	<ul style="list-style-type: none"> • 346x414x344mm(13.6x16.3x13.5Inches),2.5kg(5.5 lbs.) without clamp - -40°Cto+60°C(-40to+140° F)

*Available in future

V5000 – Distribution node

60 GHz cnWave V5000 is featured with two sectors covering up to 280 degrees with beamforming. A single V5000 can connect up to 30 client nodes out of which the client node can be replaced with distribution nodes. V5000 can be used for PTP, PMP and mesh configurations.



Figure 5: V5000 – Distribution node

Frequency	57 to 66 GHz
Modulation	BPSK to 16 QAM (MCS 0 to MCS 12) with ACM
Throughput	<ul style="list-style-type: none"> • 1.9GbpsUplink+1.9GbpsDownlinkpersector • 3.8 Gbps Uplink+3.8 Gbps Downlink with channel bonding per sector*
Dual sector - 280 degree coverage with beam forming	<ul style="list-style-type: none"> • +/- 140.0 (Azimuth), +/- 20.0 (Elevation) - EIRP38dBm
PMP/Mesh	Up to 30 x CNs or 4 x DNs + 26 x CNs
Synchronization	IEEE-1588 TC*
Low latency	< 1 ms
Data interface	<ul style="list-style-type: none"> • 1x10GE+PoEin (Passive) • 1x1GE+PoEout (802.3at) - 1xSFP+
Physical	280 x 185 x 102 mm (11 x 7.3 x 4 Inches), 2.5 kg (5.5 lbs.) without clamp, -40°C to +60°C (-40°F to +140°F)

*Available in future

Modulation

MCS	Modulation	Coding Rate	L2 Throughput (Mb/s) (2.16 GHz Channel)	L2 Throughput (Mb/s) (4.32 GHz Channel)
2	BPSK	1/2	733.0	1466.0
3	BPSK	5/8	914.0	1828.0
4	BPSK	3/4	1085.0	2170.0
5	BPSK	4/5	1175.0	2350.0
6	QPSK	1/2	1421.0	2842.0
7	QPSK	5/8	1748.0	3496.0
8	QPSK	3/4	2059.0	4118.0
9	QPSK	4/5	2221.0	4442.0
10	16-QAM	1/2	2673.0	5346.0
11	16-QAM	5/8	3245.0	6490.0
12	16-QAM	3/4	3737.0	7474.0

Network management

cnMaestro is a Cambium Network Management System (NMS). This is single plane to manage the complete Cambium Product Portfolio. It uses Websocket (encrypted and using https port 443) for management traffic that can be used to manage all Cambium products on the same system. Configurations can be pushed from the cnMaestro through E2E to the end devices.

cnMaestro NMS is used to:

- ▮ Manage cnWave network including E2E, CN, DN
- ▮ Show the connection topologies
- ▮ Collect KPIs/statistics, alarms, logs (via the E2E device agent)
- ▮ Performs software upgrade

Wireless security and protocols

Link can be secured using PSK or 802.1x, the default is Open. For 802.1x we support the EAP-TLS protocol. AES128 is supported for data communications. By default, Cambium provides a client certificate and a server certificate.

IPv6

CnWave support IPv6 address only, dynamic IP address assignment is done by using DHCPv6 and SLAAC. cnWave products uses **SLAAC** (Stateless Address Autoconfiguration) for dynamic IP address assignment. System gets the IP address dynamically by listening Router Advertisement (RA), and attach this IP address to the unique physical (MAC) address. SLAAC is also used to discover DNS by using multiple methods.

Chapter 3: System Hardware

This chapter describes the hardware components of cnWave product family Wireless nodes.

Wireless nodes

The 60 GHz cnWave solution includes three types of wireless node:

- V1000ClientNode
- V3000ClientNode
- V5000 DistributionNode

V1000 Client Node

V1000 is an outdoor Client node which can be connected to a distribution node wirelessly. V1000 supports gigabit ethernet interface and is powered by 802.3af/at POE compliant Power supply or a passive POE.

Figure 1: V1000 Client Node, front and rear views



V1000 part numbers

Order the V1000 Client Node (CN) from Cambium Networks ("V1000 Client Node part numbers" below). Each V1000 CN is supplied with a mounting bracket for wall mount or pole mount, and an indoor power supply.

Table 1: V1000 Client Node part numbers

Cambium description	Cambium part number
60GHz cnWave V1000 Client Node with US cord	C600500C001A
60GHz cnWave V1000 Client Node with EU cord	C600500C003A
60GHz cnWave V1000 Client Node with UK Cord	C600500C004A
60GHz cnWave V1000 Client Node with ANZ Cord	C600500C008A
60GHz cnWave V1000 Client Node with Brazil Cord	C600500C009A
60GHz cnWave V1000 Client Node with Argentina Cord	C600500C010A
60GHz cnWave V1000 Client Node with China Cord	C600500C011A
60GHz cnWave V1000 Client Node with South Africa Cord	C600500C012A
60GHz cnWave V1000 Client Node with India Cord	C600500C013A
60GHz cnWave V1000 Client Node with no Cord	C600500C014A

V3000 Client Node

V3000 is an outdoor Client node which can be connected to a distribution node or another V3000 Client Node wirelessly. V3000 supports 10Gigabit Ethernet interface, an 10G SFP+ interface port and a Gigabit ethernet Aux interface.

V3000 can be powered by 802.3bt compliant POE or a passive POE and can also power 802.3af/at compliant auxiliary device through Gigabit Aux port.

Figure 2: V3000 Client Node, with and without Antenna Assembly



V3000 part numbers

Order the V3000 Client Node (CN) from Cambium Networks (" V3000 Client Node part numbers" on the next page). The V3000 CN is supplied without a bracket or power supply. See [Precision Brackets](#) for details of suitable brackets and power supplies.



Note

The V3000 CN requires use of a dedicated antenna assembly.
Order one Antenna Assembly for each client Node Radio

Table 2:V3000 Client Node part numbers

Cambiumdescription	Cambium part number
60GHz cnWave V3000 Client Node Radio Only	C600500C024A
60GHz cnWave V3000 Client Node Antenna Assembly	C600500D001A

V5000 Distribution Node

V5000 is an outdoor Distribution Node which can be connected to a Multiple V1000 or V3000 Client Nodes wirelessly. V5000 supports 10Gigabit Ethernet interface, an 10G SFP+ interface port and a Gigabit ethernet Aux interface.

V5000 can be powered by 802.3bt compliant POE or a passive POE and can also power 802.3af/at compliant auxiliary device through Gigabit Aux port.

Figure 3: V5000 Distribution Node, front and rear views



V5000 part numbers

Order the V5000 Distribution Node (DN) from Cambium Networks (" V5000 Distribution Node part numbers" below). The V5000 DN is supplied without a mounting bracket or power supply.

Table 3:V5000 Distribution Node part numbers

Cambiumdescription	Cambium part number
60GHz cnWave V5000 Distribution Node	C600500A004A

Radio mounting brackets

V1000 wall and pole mount

The V1000 CN is supplied with a mounting plate and band clamp. The mounting plate can be used for mounting the V1000 on a wall, or it can be used with the band clamp to mount the V1000 on a pole with diameter in the range 40 mm to 77 mm (1.6 inches to 3.0 inches).

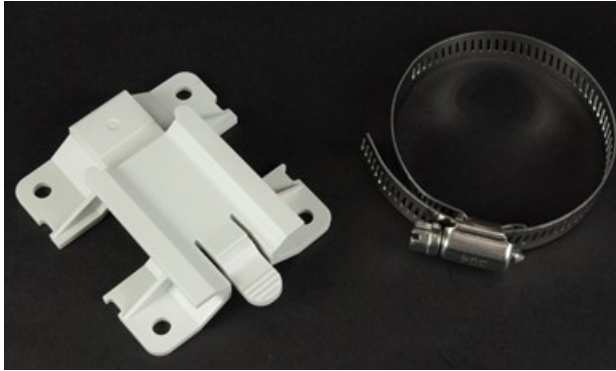

Figure 4: V1000 mounting plate and band clamp

V1000 adjustable pole mount

The Adjustable Pole Mount is used to provide elevation adjustment when a V1000 CN is mounted on a pole. The Adjustable Pole Mount works with poles with diameter in the range 40 mm to 77 mm (1.6 inches to 3.0 inches).

Figure 5: V1000 Adjustable Pole Mount



V3000/5000 Tilt Bracket

The Tilt Bracket ("Tilt Bracket Assembly" below) is used to provide elevation adjustment when a V3000 CN or V5000 DN is mounted on a pole. The Tilt Bracket works with poles with diameter in the range 25 mm to 80 mm (1.0 inches to 3.1 inches). The Tilt Bracket Assembly may be used with third-party band clamps to mount the ODU on larger pole with diameter in the range 90 mm to 230 mm (3.6 inches to 9.0 inches).



Figure 6: Tilt Bracket Assembly

V5000 Wall Mount

The Wall Mount ("Wall Mount" below) is used to mount a V5000 DN on a vertical wall. It does not provide azimuth or elevation adjustment. The Wall Mount requires additional fixing hardware suitable for the type of wall.

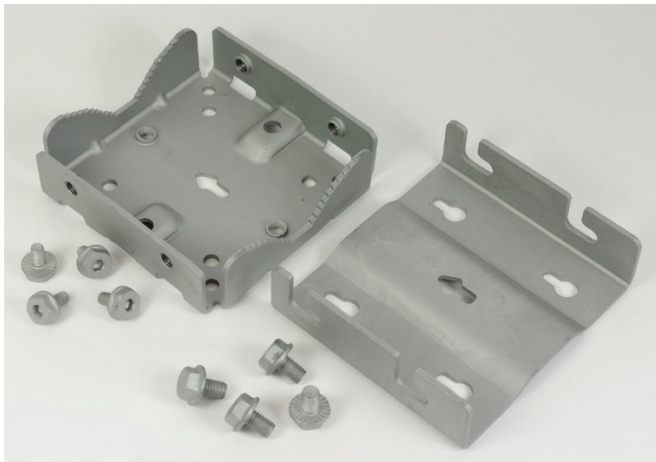

Figure 7: Wall Mount

V5000 Pole Mount

The Pole Mount ("Pole Mount" below) is used to mount a V5000 DN on a vertical pole with diameter in the range 25 mm to 80 mm (1.0 inches to 3.1 inches). It provides coarse azimuth (but not elevation) adjustment.

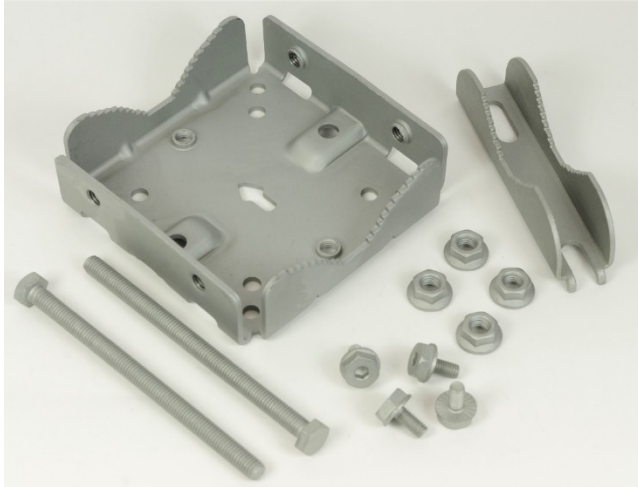

Figure 8: Pole Mount

V3000 Precision Bracket

The Precision Bracket ("Precision Bracket" below and Figure 10) is used to mount the V3000 CN on a vertical pole with diameter in the range 25 mm to 80 mm (1.0 inches to 3.1 inches). The Precision Bracket provides fine adjustment of up to 18° in azimuth and +/-30° in elevation for accurate alignment of the V3000.

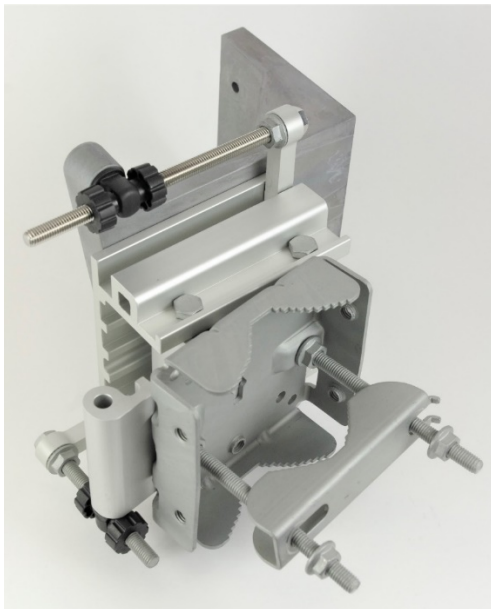
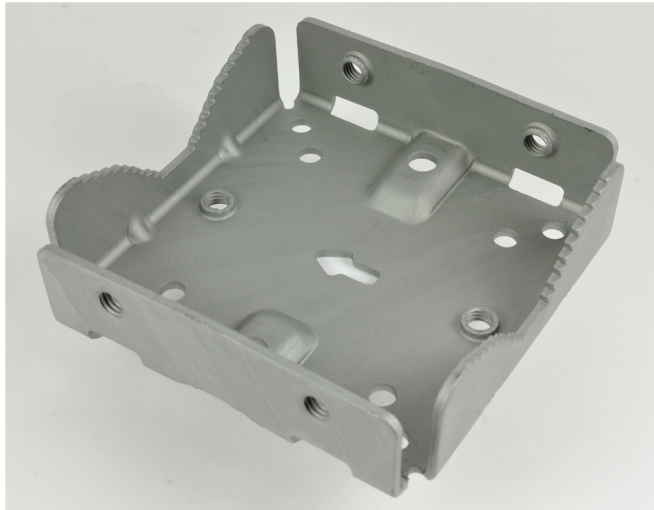

Figure 9: Precision Bracket



Bracket body



Azimuth arm



Long (120 mm) M8 screws and flange nuts

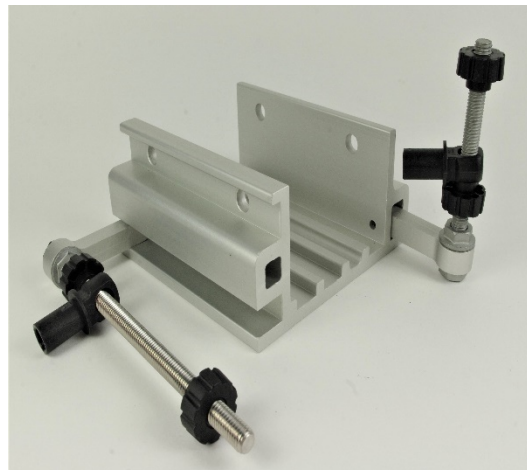

Bracket base



40 mm M8 screws, plain washers and Nyloc nuts



V3000 mount



28 mm M6 screws, M8 spacers and pole mount clamp

Figure 10: Precision Bracket Components

Bracket Part Numbers

Order mounting brackets using the Cambium Part Number in " Radio mounting bracket part numbers" below.

Table 4: Radio mounting bracket part numbers

Bracket	Radio nodes	Cambium Part Number
Adjustable Pole Mount	V1000	N000900L022A
Tilt Bracket Assembly	V3000, V5000	N000045L002A
Wall Mount Bracket	V5000	C000000L136A
Pole Mount Bracket	V5000	C000000L137A
Precision Bracket	V3000	C000000L125A

Radio Accessories

Telescope mounting kit for Precision Brackets

An alignment telescope provides the most accurate option for alignment of the Precision Bracket during installation. The telescope is temporarily mounted on the bracket using the Telescope Mounting Kit for Precision Brackets.

The Telescope Mounting Kit consists of a mounting plate, a knurled screw and two rubber O-rings. Order the Telescope Mounting Kit from Cambium.

Order a suitable telescope from a specialist supplier specifying the following:

- Right angle, erecting, 9x50mm alignment scope with 5° field of view

Figure 11: Telescope mounting kit



Figure 12: Typical alignment telescope



Order radio accessories using the Cambium Part Number in "Radio accessory part numbers" below.

Table 5: Radio accessory part numbers

Accessory	Radio nodes	Cambium Part Number
Telescope mounting kit	V3000	C000000L139A

Radio External Interfaces

V1000 Client Node

Figure 13: External interfaces for V1000 Client Node



Table 6: External interfaces V1000 CN

Port name	Connector	Interface	Description
PSU	RJ45	POE input	Standard IEEE 802.3af PoE
		100/1000BASE-T Ethernet	Data and management

V3000 Client Node

Figure 14: External interfaces for V3000 Client Node



Table 7: External interfaces V3000 CN

Port name	Connector	Interface	Description
SFP+	SFP	10GBASE-SR/10GBASE-LR using optional SFP+ module	Data and management
PSU	RJ45	POE input	Passive PoE or IEEE 802.3at
		100/1000/2.5GBASE-T/5GBASE-T/ 10GBASE-T Ethernet	Data and management
AUX	RJ45	POE output	Standard IEEE 802.3at
		100/1000BASE-T Ethernet	Data and management

V5000 Distribution Node

Figure 15: External interfaces for V5000 Distribution Node

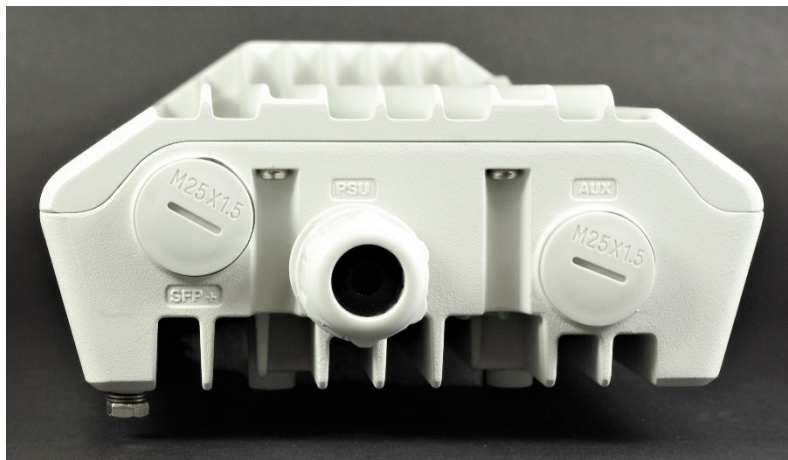

Table 8: External interfaces V5000 DN

Port name	Connector	Interface	Description
SFP+	SFP	10GBASE-SR/10GBASE-LR using optional SFP+ module	Data and management
PSU	RJ45	POE input	Passive PoE or IEEE 802.3at
		100/1000/2.5GBASE-T/5GBASE-T/ 10GBASE-T Ethernet	Data and management
AUX	RJ45	POE output	Standard IEEE 802.3at
		100/1000BASE-T Ethernet	Data and management

Radio specifications

The 60 GHz cnWave Radios conform to the specifications listed in " Radio node specifications" on the next page.

Table 9: Radio node specifications

Category	Specification	
Dimensions	V1000 Client Node	140 mm ×85 mm ×40 mm (5.5 in ×3.3 in ×1.6 in)
	V3000 Client Node	346 mm ×414 mm ×344 mm (13.6 in ×16.3 in ×13.5 in)
	V5000 Distribution Node	280 mm ×185 mm ×102 mm (11.0 in ×7.3 in ×4.0 in)
Weight	V1000 Client Node	0.25 kg (0.55 lbs)
	V3000 Client Node	4.0 kg (8.8 lbs) including antenna
	V5000 Distribution Node	4.0 kg (8.8 lbs) including antenna
Temperature	-40°C (-40°F) to +60°C (140°F)	
Wind survival	200 kph (124 mph) maximum.	
Humidity	100% condensing	
Liquid and particle ingress	IP66, IP67	
Power consumption	V1000 Client Node	10 W
	V3000 Client Node	30 W, up to 55 W with PoE out enabled
	V5000 Distribution Node	35 W, up to 60 W with PoE out enabled
Power input interface	V1000 Client Node	IEEE 802.3af
	V3000 Client Node	Passive PoE, IEEE 802.3at
	V5000 Distribution Node	Passive PoE
Power output interface	V3000 Client Node	IEEE 802.3af/at, 25 W maximum
	V5000 Distribution Node	IEEE 802.3af/at, 25 W maximum

Power supply units (PSU)

PSU options

Select PSUs for 60 GHz cnWave radios according to " PSU selection" below.

Table 10: PSU selection

Radio	Configuration	PSU	Cambium part number
V1000	PoE, indoor power injector	Gigabit DC Injector	N000900L017A
	PoE, PoE switch	PSU not required	-
V3000	Outdoor DC power	Outdoor AC/DC PSU, 60W, 54VDC	N000000L178A
		Waterproof PSU Cable Joiner	N000000L180A
		DC to RJ45 Plug Power Adaptor	C000000L184A
	PoE, indoor power injector	PoE, 60W, 56V, 5GbE DC Injector	N000000L142A
V5000	Outdoor DC power	Outdoor AC/DC PSU, 60W, 54VDC	N000000L178A
		Outdoor AC/DC PSU, 100W, 54VDC	N000000L179A
		Waterproof PSU Cable Joiner	N000000L180A
		DC to RJ45 Plug Power Adaptor	C000000L184A
	PoE, indoor power injector	PoE, 60W, 56V, 5GbE DC Injector	N000000L142A

Refer *Maximum cable lengths* for details of the maximum cable lengths and the maximum PoE output power for different powering options.

V1000 power over Ethernet

The V1000 Client Node is always powered using power over Ethernet (PoE) at a nominal 56 V, as shown in " PoE power supply to V1000" below using the Gigabit power injector supplied with the radio, or using an IEEE 802.3af PoE output from an Ethernet switch.

Figure 16: PoE power supply to V1000





Note



The Gigabit Power Injector is supplied with the cnWave V1000 Client Node. Order part N000900L017A to obtain spares.



Warning

Always use an appropriately rated and approved AC supply cord-set in accordance with the regulations of the country of use.

V3000, V5000 power over Ethernet

The V3000 Client Node and V5000 Distribution Node can be powered using power over Ethernet (PoE) at a nominal 56 V, using the 5 Gbit/s 60 W PoE Injector (N000000L142A) as shown in Figure 21.

Figure 22: PoE power supply to V3000 or V5000



The PoE power injectors must be installed indoors, in a protected environment.
Chapter 3: System Hardware

V3000, V5000 DC power supply

The V3000 Client Node and V5000 Distribution Node can be powered using DC power at a nominal 54 V, using 14 AWG or 16 AWG cable, as shown in "DC power supply to V3000 or V5000" below.

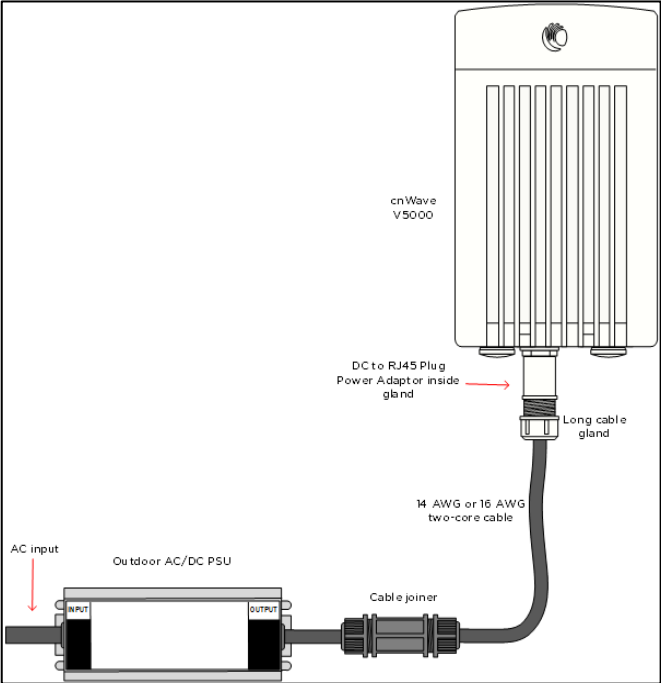

Figure 17: DC power supply to V3000 or V5000

The Outdoor PSU can be installed indoors, in an outdoor cabinet, or inside street furniture.

Figure 18: Outdoor AC/DC PSU, 60W, 54VDC



Figure 19: Outdoor AC/DC PSU, 100W, 54VDC



Figure 20: Cable joiner



Figure 21: DC to RJ45 Plug Power Adaptor

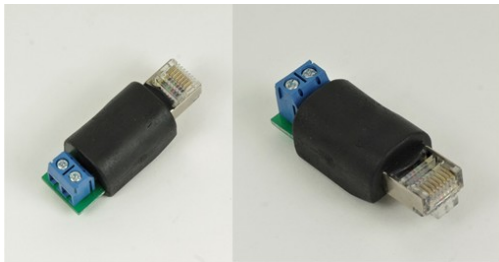

PSU part numbers

Order PSUs from Cambium Networks (" Power supply component part numbers" below).

Table 11: Power supply component part numbers

Cambium description	Radio node	Cambium part number
Outdoor AC/DC PSU, 60W, 54VDC	V3000, V5000	N000000L178A
Outdoor AC/DC PSU, 100W, 54VDC	V5000	N000000L179A
Waterproof PSU Cable Joiner 14-16 AWG	V3000, V5000	N000000L180A
DC to RJ45 Plug Power Adaptor	V3000, V5000	C000000L184A
Cable Gland, Long, M25, Qty 5	V3000, V5000	C000000L124A
PoE, 60W, 56V, 5GbE DC Injector, Indoor, Energy Level 6 Supply	V3000, V5000	N000000L142A
PoE Gigabit DC Injector, 15W Output at 56V, Energy Level 6, 0C to 50C	V1000	N000900L017A

PSU specifications

The PSUs conform to the specifications listed in "Outdoor AC/DC PSU, 54VDC" on the next page.

Table 12: Outdoor AC/DC PSU, 54VDC

Category	PSU	Specification
Dimensions	60 W	171 mm (6.7 in) x 62 mm (2.4 in) x 37 mm (1.5 in)
	100 W	220 mm (8.7 in) x 68 mm (2.7 in) x 39 mm (1.5 in)
Power	60 W	
	100 W	
Temperature	-40°C (-40°F) to +60°C (140°F)	
Humidity	20 to 95 % non-condensing	
Waterproofing	IP65/IP67	
AC Input	90-305 V AC, 47-63 Hz	
DC Output Voltage	54 V	
DC Output current	60 W	1.15 A
	100 W	1.77 A
Efficiency	Better than 90% at full load	
Over Current Protection	Hiccup mode, recovers automatically after fault condition is removed	
Hold up time	At least 16 milliseconds	
Power factor	Better than 0.95	

Table 13: PoE, 60W, 56V, 5GbE POEDC Injector (N000000L142A)

Category	Specification
Dimensions	140 mm (5.5 in) x 53mm (2.08 in) x 35 mm (1.37 in)
Weight	0.24 Kg (0.5 lbs)
Temperature	0°C (32°F) to +50°C (140°F)
Humidity	10% to 95 % non-condensing
AC Input	90-264 V AC, 47-63 Hz
DC Output Voltage	56 V
DC Output current	1.07A
Efficiency	Better than 88% at full load
Over Current Protection	Hiccup mode, recovers automatically after fault condition is removed
Hold up time	At least 10 milliseconds
RJ45 POE Port	1,2,7,8 ----- V- 3,4,5,6 ----- V+

Table 14: 15W,56V Gigabit POE DC Injector (N000900L017A)

Category	Specification
Dimensions	118 mm (4.64 in) x 43mm (1.69 in) x 32.4 mm (1.27 in)
Weight	0.18 Kg (0.39 lbs)
Temperature	0°C (32°F) to +50°C (140°F)
Humidity	10% to 95 % non-condensing
AC Input	90-264 V AC, 47-63 Hz
DC Output Voltage	56 V
DC Output current	0.25A (240VDC) 0.5A (120VDC)
Efficiency	Better than 84% at full load
Over Current Protection	Hiccup mode, recovers automatically after fault condition is removed
Hold up time	At least 10 milliseconds
RJ45 POE Port	7,8 ----- V- 5,6 ----- V+

Ethernet and DC cables

Maximum cable lengths Ethernet

For all cnWave radios, the maximum cable length for data transmission over copper Ethernet (100BASE-TX, 1000BASE-T, 2.5GBASE-T, 5GBASE-T, 10GBASE-T) is 100 m (328 ft) from the radio to the connected equipment.

The maximum cable length for fiber Ethernet (10GBASE-SR, 10GBASE-LR) connections depends on the fiber used. See SFP module kits on page 19 for details of the Ethernet standards supported and maximum permitted cable lengths.

Power over Ethernet

The maximum length for supplying power from a 60 W DC injector over a CAT6A Ethernet cable is shown in "Maximum cable length for power over Ethernet" below.

Table 15: Maximum cable length for power over Ethernet

Radio	PoE enabled	Maximum cable length
V3000	-	390 m
	25 W	72 m
V5000	-	330 m
	25 W	Not supported

The available output power for auxiliary Power over Ethernet output in V3000 and V5000 is reduced at longer PoE cable lengths, as shown in Table 16.

Table 16: Maximum PoE output power

Radio	Cable length	Maximum PoE output
V3000	0 m to 72 m	25.0 W
	25.0 W	24.6 W
	100 m	23.6 W
V5000	10 m	23.1 W
	20 m	22.6 W
	30 m	22.1 W
	40 m	21.6 W
	60 m	20.6 W
	80 m	19.6 W
	100 m	18.6 W

DC power feed

The maximum length for supplying power over a CAT6A Ethernet cable is shown in "Maximum cable length for DC power" below.

Table 17: Maximum cable length for DC power

Radio	PSU	PoE enabled	Maximum cable length 14 AWG	Maximum cable length 16 AWG
V3000	60 W	-	780 m	490 m
		25 W	140 m	90 m
	100 W	-	780 m	490 m
		25 W	390 m	250 m

Radio	PSU	PoE enabled	Maximum cable length 14 AWG	Maximum cable length 16 AWG
V5000	60 W	-	660 m	410 m
		25 W	Not supported	
	100 W	-	660 m	410 m
		25 W	360 m	220 m

Outdoor copper Ethernet cable

Select an outdoor rated CAT6A cable, ready terminated with RJ45 connectors in the one of the following lengths:

- 25 m
- 50 m
- 100 m

Alternatively, terminate bulk CAT6A cable with RJ45 connectors at a length to suit each installation.



Attention

Always use CAT6A or better cable that has an overall copper braid shield, outdoor rated, with UV-resistant sheath

Table 18: Terminated Ethernet cable part numbers

Cambium Description	Cambium part number
CAT6A Outdoor Cable, 305m	N000082L172B
RJ45 Connector for CAT6A Cable	N000082L174B
CAT6A Outdoor Cable, 100m	N000000L155A

Cable accessories

Figure 23: Standard cable gland

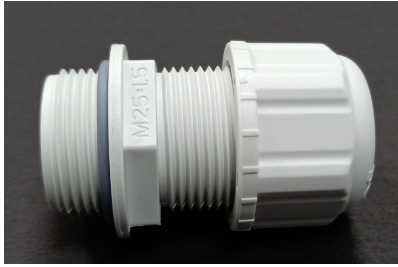

Figure 24: Long cable gland



Cable accessories available from Cambium Networks are listed in " Cable accessory part numbers" below.

Table 20: Cable accessory part numbers

Cambium description	Cambium part number
Cable Gland for 6-9mm cable, M25, Qty 10	C000000L123A
Cable Gland Long, M25, Qty 5	C000000L124A
Grounding Cable, 0.6m with M6 ring to M6 ring	C000000L138A
Cable Gland for 4-6mm cable, M25, Qty 10	C000000L176A
DC to RJ45 Plug Power Adaptor	C000000L184A
Grounding Cable, 1m with M6 ring to M6 ring	N000082L116A



Note

One cable gland for 6-9 mm cable size is included with each cnWave radio. Order additional cable glands as spares, where smaller cable size is to be used, or where the V3000 or V5000 Aux port is to be used.

SFP module kits

SFP module kits allow connection of a V3000 CN or V5000 DN radio to a network over a 10 Gigabit optical Ethernet interface in one of the following full-duplex modes:

- 10GBASE-SR
- 10GBASE-LR

Order SFP+ module kits from Cambium Networks ("SFP module part numbers" below).

The SFP+ module must be used with the long cable gland.

Table 21: SFP module part numbers

Cambium description	Cambium part number
10G SFP+ MMF SR Transceiver, 850nm. -40C to 85C	SFP-10G-SR
10G SFP+ SMF LR Transceiver, 1310nm. -40C to 85C	SFP-10G-LR
1G SFP MMF SX Transceiver, 850nm. -40C to 85C	SFP-1G-SX
1G SFP SMF LX Transceiver, 1310nm. -40C to 85C	SFP-1G-LX
10G SFP+ BaseT (RJ45), -40C to 85C	SFP-10G-Cu-EXT
1000Base-T (RJ45) SFP Transceiver. -40C to 85C	SFP-1G-Copper
Cable Gland Long, M25, Qty 5	C000000L124A

Optical cable and connectors

Order an optical cable with LC connectors from a specialist fabricator, quoting the specification shown in "Optical optic cable and connector specification" below. It must be the correct length to connect the ODU to the other device. LC connectors should be supplied with dust caps to prevent dust build up.

Figure 25: Optical optic cable and connector specification

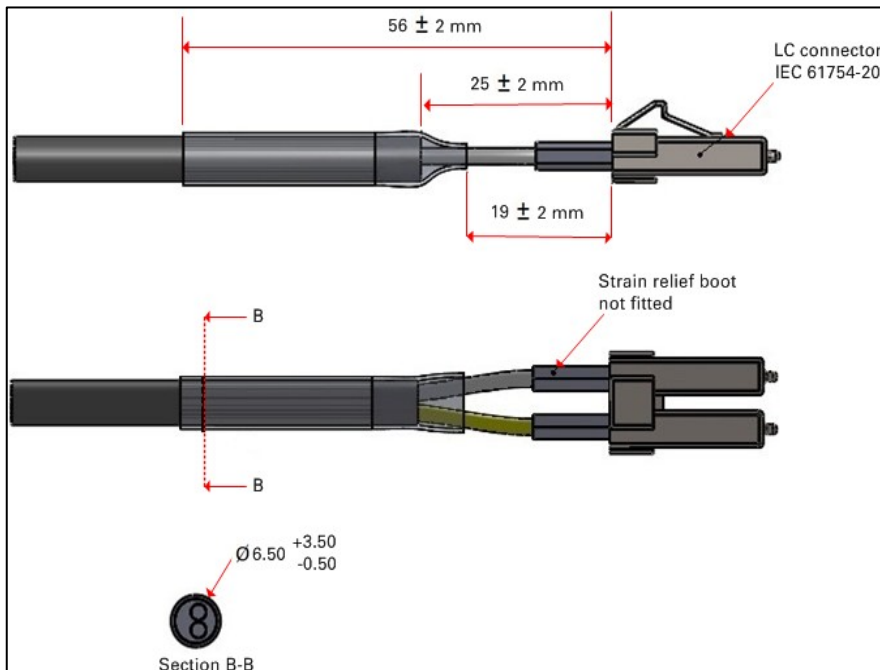

Chapter 4: System planning

Site planning

This section describes factors to be considered when planning the proposed link end sites, including grounding, lightning protection and equipment location for the ODU and PSU.

Grounding and lightning protection



Warning

Electro- magnetic discharge (lightning) damage is not covered under warranty. The recommendations in this guide, when followed correctly, give the user the best protection from the harmful effects of EMD. However, 100% protection is neither implied nor possible.

Structures, equipment and people must be protected against power surges (typically caused by lightning) by conducting the surge current to ground via a separate preferential solid path. The actual degree of protection required depends on local conditions and applicable local regulations. To adequately protect a PTP installation, both ground bonding and transient voltage surge suppression are required.

Full details of lightning protection methods and requirements can be found in the International Standards IEC 61024-1 and IEC 61312-1, the U.S. National Electric Code ANSI/NFPA No. 70-1984 or section 54 of the Canadian Electric Code.



Note

International and national standards take precedence over the requirements in this guide.

Lightning protection zones

Use the rolling sphere method (Rolling sphere method to determine the lightning protection zones) to determine where it is safe to mount equipment. An imaginary sphere, typically 50 meters in radius, is rolled over the structure. Where the sphere rests against the ground and a strike termination device (such as a finial or ground bar), all the space under the sphere is in the zone of protection (Zone B). Similarly, where the sphere rests on two finials, the space under the sphere is in the zone of protection.

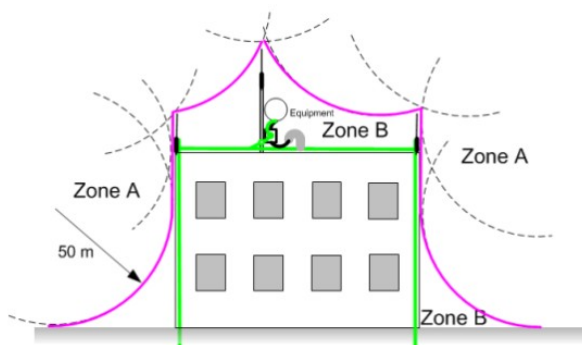

Figure 26 : Rolling sphere method to determine the lightning protection zones



Warning

Never mount equipment in Zone A. Mounting in Zone A may put equipment, structures and life at risk.

Site grounding system

Confirm that the site has a correctly installed grounding system on a common ground ring with access points for grounding ODU.

If the outdoor equipment is to be installed on the roof of a high building, refer to **Installation** section. Ensure that the system meets the following additional requirements:

- A grounding conductor is installed around the roof perimeter to form the main roof perimeter lightning protection ring.
- Air terminals are installed along the length of the main roof perimeter lightning protection ring, typically every 6.1m (20ft).
- The main roof perimeter lightning protection ring contains at least two down conductors connected to the grounding electrode system. The down conductors should be physically separated from one another, as far as practical.

ODU location

Find a location for the ODU (and external antenna for connectorized units) that meets the following requirements:

- The equipment is high enough to achieve the best radio path.
- People can be kept a safe distance away from the equipment when it is radiating. The safe separation distances are defined in [Legal and regulatory information](#).
- The equipment is lower than the top of the supporting structure (tower, mast or building) or its lightning air terminal.
- If the ODU is connectorized, select a mounting position that gives it maximum protection from the elements, but still allows easy access for connecting and weatherproofing the cables. To minimize cable losses, select a position where the antenna cable lengths can be minimized. If diverse or two external antennas are being deployed, it is not necessary to mount the ODU at the midpoint of the antennas.

Drop cable grounding points

To estimate how many grounding kits are required for each drop cable, refer to site installation and use the following criteria:

- The drop cable shield must be grounded near the ODU at the first point of contact between the drop cable and the mast installation, tower or building.
- The drop cable shield must be grounded at the building entry point.

For mast or tower installations installation, use the following additional criteria:

- The drop cable shield must be grounded at the bottom of the tower, near the vertical to horizontal transition point. This ground cable must be bonded to the tower or tower ground busbar (TGB), if installed.
- If the tower is greater than 61 m (200 ft) in height, the drop cable shield must be grounded at the tower midpoint, and at additional points as necessary to reduce the distance between ground cables to 61 m (200 ft) or less.

- In lightning-prone geographical areas, the drop cable shield must be grounded at spacing between 15 to 22 m (50 to 75 ft). This is especially important on towers taller than 45 m (150 ft).

For roof installations, use the following additional criteria:

- The drop cable shield must be bonded to the building grounding system at its top entry point (usually on the roof).
- The drop cable shield must be bonded to the building grounding system at the entry point to the equipment room.

PSU DC power supply

Use Cambium recommended DC PSU for Wireless nodes and ensure Power cords and cables are appropriately rated and in accordance with the regulations of the country of use.

PSU AC power supply

Use Cambium recommended AC power supply for Wireless nodes and ensure Power cords and cables are appropriately rated and in accordance with the regulations of the country of use.

PSU location

Find a location for the PSU that meets the following requirements:

DC PSU Injector

- DC Power Injector can be mounted on a flat surface.
- PSU is installed in a dry location where no condensation, flooding or rising damp is possible.
- The PSU is located in an environment where it is not likely to exceed its operational temperature rating, allowing for natural convection cooling and placed not close to any fire source.
- PSU can be connected to the ODU drop cable and network terminating equipment.
- PSU can be connected to a compatible power supply.

Outdoor AC PSU

Find a location for the PSU that meets the following requirements:

- The PSU is installed in a dry location where no flooding or rising damp is possible.
- The PSU is located in an environment where it is not likely to exceed its operational temperature rating, allowing for natural convection cooling and placed not close to any fire source.
- The PSU is not stacked and placed on the adjacent to the heat generating equipment.
- The PSU shall be connected to protective Earth.
- The PSU shall be connected to ODU drop cable using cable joiner and appropriate rated cables shall be used.

Chapter 5: Legal and Regulatory information

This chapter provides end user license agreements and regulatory notifications.



Caution

Intentional or unintentional changes or modifications to the equipment must not be made unless under the express consent of the party responsible for compliance. Any such modifications could void the user's authority to operate the equipment and will void the manufacturer's warranty.



Attention

Les changements ou modifications intentionnels ou non intentionnels à l'équipement ne doivent pas être effectués sauf avec le consentement exprès de la partie responsable de la conformité. De telles modifications pourraient annuler l'autorisation de l'utilisateur à faire fonctionner l'équipement et annulera la garantie du fabricant.

The following topics are described in this chapter:

- Cambium Networks end user license agreement contains the Cambium and third-party license agreements for the 60GHz cnWave™ Family of ODU's.
- Compliance with safety standards lists the safety specifications against which the 60 GHz cnWave™ Family of ODU's has been tested and certified. It also describes how to keep RF exposure within safe limits.
- Compliance with radio regulations describes how the 60GHz cnWave™ Family of ODU's complies with the radio regulations that are in force in various countries.

End user license agreement

Definitions

In this Agreement, the word "Software" refers to the set of instructions for computers, in executable form and in any media, (which may include diskette, CD-ROM, downloadable internet, hardware, or firmware) licensed to you. The word "Documentation" refers to electronic or printed manuals and accompanying instructional aids licensed to you. The word "Product" refers to Cambium Networks' fixed wireless broadband devices for which the Software and Documentation is licensed for use.

Acceptance of this agreement

In connection with Cambium Networks' delivery of certain proprietary software or products containing embedded or pre-loaded proprietary software, or both, Cambium Networks is willing to license this certain proprietary software and the accompanying documentation to you only on the condition that you accept all the terms in this End User License Agreement ("Agreement").

IF YOU DO NOT AGREE TO THE TERMS OF THIS AGREEMENT, DO NOT USE THE PRODUCT OR INSTALL THE SOFTWARE. INSTEAD, YOU MAY, FOR A FULL REFUND, RETURN THIS PRODUCT TO THE LOCATION WHERE YOU ACQUIRED IT OR PROVIDE WRITTEN VERIFICATION OF DELETION OF ALL COPIES OF THE SOFTWARE. ANY USE OF THE SOFTWARE, INCLUDING BUT NOT LIMITED TO USE ON THE PRODUCT, WILL CONSTITUTE YOUR ACCEPTANCE TO THE TERMS OF THIS AGREEMENT.

Grant of license

Cambium Networks Limited (“Cambium”) grants you (“Licensee” or “you”) a personal, nonexclusive, non-transferable license to use the Software and Documentation subject to the Conditions of Use set forth in “Conditions of use” and the terms and conditions of this Agreement. Any terms or conditions relating to the Software and Documentation appearing on the face or reverse side of any purchase order, purchase order acknowledgment or other order document that are different from, or in addition to, the terms of this Agreement will not be binding on the parties, even if payment is accepted.

Conditions of use

Any use of the Software and Documentation outside of the conditions set forth in this Agreement is strictly prohibited and will be deemed a breach of this Agreement.

1. Only you, your employees or agents may use the Software and Documentation. You will take all necessary steps to insure that your employees and agents abide by the terms of this Agreement.
2. You will use the Software and Documentation (i) only for your internal business purposes; (ii) only as described in the Software and Documentation; and (iii) in strict accordance with this Agreement.
3. You may use the Software and Documentation, provided that the use is in conformance with the terms set forth in this Agreement.
4. Portions of the Software and Documentation are protected by United States copyright laws, international treaty provisions, and other applicable laws. Therefore, you must treat the Software like any other copyrighted material (for example, a book or musical recording) except that you may either: (i) make 1 copy of the transportable part of the Software (which typically is supplied on diskette, CD-ROM, or downloadable internet), solely for back-up purposes; or (ii) copy the transportable part of the Software to a PC hard disk, provided you keep the original solely for back-up purposes. If the Documentation is in printed form, it may not be copied. If the Documentation is in electronic form, you may print out 1 copy, which then may not be copied. With regard to the copy made for backup or archival purposes, you agree to reproduce any Cambium Networks copyright notice, and other proprietary legends appearing thereon. Such copyright notice(s) may appear in any of several forms, including machine-readable form, and you agree to reproduce such notice in each form in which it appears, to the extent it is physically possible to do so. Unauthorized duplication of the Software or Documentation constitutes copyright infringement, and in the United States is punishable in federal court by fine and imprisonment.
5. You will not transfer, directly or indirectly, any product, technical data or software to any country for which the United States Government requires an export license or other governmental approval without first obtaining such license or approval.

Title and restrictions

If you transfer possession of any copy of the Software and Documentation to another party outside of the terms of this agreement, your license is automatically terminated. Title and copyrights to the Software and Documentation and any copies made by you remain with Cambium Networks and its licensors. You will not, and will not permit others to: (i) modify, translate, decompile, bootleg, reverse engineer, disassemble, or extract the inner workings of the Software or Documentation, (ii) copy the look-and-feel or functionality of the Software or Documentation; (iii) remove any proprietary notices, marks, labels, or logos from the Software or Documentation; (iv) rent or transfer all or some of the Software or

Documentation to any other party without Cambium’s prior written consent; or (v) utilize any computer software or hardware which is designed to defeat any copy protection device, should the Software and Documentation be equipped with such a protection device. If the Software and Documentation is provided on multiple types of media (such as diskette, CD-ROM, downloadable internet), then you will only use the medium which best meets your specific needs, and will not loan, rent, lease, or transfer the other media contained in the package without Cambium’s written consent. Unauthorized copying of the Software or Documentation, or failure to comply with any of the provisions of this Agreement, will result in automatic termination of this license.

Confidentiality

You acknowledge that all Software and Documentation contain valuable proprietary information and trade secrets and that unauthorized or improper use of the Software and Documentation will result in irreparable harm to Cambium Networks for which monetary damages would be inadequate and for which Cambium Networks will be entitled to immediate injunctive relief. If applicable, you will limit access to the Software and Documentation to those of your employees and agents who need to use the Software and Documentation for your internal business purposes, and you will take appropriate action with those employees and agents to preserve the confidentiality of the Software and Documentation, using the same degree of care to avoid unauthorized or improper disclosure as you use for the protection of your own proprietary software, but in no event less than reasonable care.

You have no obligation to preserve the confidentiality of any proprietary information that: (i) was in the public domain at the time of disclosure; (ii) entered the public domain through no fault of yours; (iii) was given to you free of any obligation to keep it confidential; (iv) is independently developed by you; or (v) is disclosed as required by law provided that you notify Cambium Networks prior to such disclosure and provide Cambium Networks with a reasonable opportunity to respond.

Right to use Cambium’s name

Except as required in “Conditions of use”, you will not, during the term of this Agreement or thereafter, use any trademark of Cambium Networks, or any word or symbol likely to be confused with any Cambium Networks trademark, either alone or in any combination with another word or words.

Transfer

The Software and Documentation may not be transferred to another party without the express written consent of Cambium Networks, regardless of whether or not such transfer is accomplished by physical or electronic means. Cambium’s consent may be withheld at its discretion and may be conditioned upon transferee paying all applicable license fees and agreeing to be bound by this Agreement.

Updates

During the first 12 months after purchase of a Product, or during the term of any executed Maintenance and Support Agreement for the Product, you are entitled to receive Updates. An “Update” means any code in any form which is a bug fix, patch, error correction, or minor enhancement, but excludes any major feature added to the Software. Updates are available for download at the support website.

Major features may be available from time to time for an additional license fee. If Cambium Networks makes available to your major features and no other end user license agreement is provided, then the terms of this Agreement will apply.

Maintenance

Except as provided above, Cambium Networks is not responsible for maintenance or field service of the Software under this Agreement.

Disclaimer

CAMBIUM NETWORKS DISCLAIMS ALL WARRANTIES OF ANY KIND, WHETHER EXPRESS, IMPLIED, STATUTORY, OR IN ANY COMMUNICATION WITH YOU. CAMBIUM NETWORKS SPECIFICALLY DISCLAIMS ANY WARRANTY INCLUDING THE IMPLIED WARRANTIES OF MERCHANTABILITY, NONINFRINGEMENT, OR FITNESS FOR A PARTICULAR PURPOSE. THE SOFTWARE AND DOCUMENTATION ARE PROVIDED “AS IS.” CAMBIUM NETWORKS DOES NOT WARRANT THAT THE SOFTWARE WILL MEET YOUR REQUIREMENTS, OR THAT THE OPERATION OF THE SOFTWARE WILL BE UNINTERRUPTED OR ERROR FREE, OR THAT DEFECTS IN THE SOFTWARE WILL BE CORRECTED. CAMBIUM NETWORKS MAKES NO WARRANTY WITH RESPECT TO THE CORRECTNESS, ACCURACY, OR RELIABILITY OF THE SOFTWARE AND DOCUMENTATION. Some jurisdictions do not allow the exclusion of implied warranties, so the above exclusion may not apply to you.

Limitation of liability

IN NO EVENT SHALL CAMBIUM NETWORKS BE LIABLE TO YOU OR ANY OTHER PARTY FOR ANY DIRECT, INDIRECT, GENERAL, SPECIAL, INCIDENTAL, CONSEQUENTIAL, EXEMPLARY OR OTHER DAMAGE ARISING OUT OF THE USE OR INABILITY TO USE THE PRODUCT (INCLUDING, WITHOUT LIMITATION, DAMAGES FOR LOSS OF BUSINESS PROFITS, BUSINESS INTERRUPTION, LOSS OF BUSINESS INFORMATION OR ANY OTHER PECUNIARY LOSS, OR FROM ANY BREACH OF WARRANTY, EVEN IF CAMBIUM NETWORKS HAS BEEN ADVISED OF THE POSSIBILITY OF SUCH DAMAGES. (Some states do not allow the exclusion or limitation of incidental or consequential damages, so the above exclusion or limitation may not apply to you.) IN NO CASE SHALL CAMBIUM’S LIABILITY EXCEED THE AMOUNT YOU PAID FOR THE PRODUCT.

U.S. government

If you are acquiring the Product on behalf of any unit or agency of the U.S. Government, the following applies. Use, duplication, or disclosure of the Software and Documentation is subject to the restrictions set forth in subparagraphs (c) (1) and (2) of the Commercial Computer Software – Restricted Rights clause at FAR 52.227-19 (JUNE 1987), if applicable, unless being provided to the Department of Defense. If being provided to the Department of Defense, use, duplication, or disclosure of the Products is subject to the restricted rights set forth in subparagraph (c) (1) (ii) of the Rights in Technical Data and Computer Software clause at DFARS 252.227-7013 (OCT 1988), if applicable. Software and Documentation may or may not include a Restricted Rights notice, or other notice referring specifically to the terms and conditions of this Agreement. The terms and conditions of this Agreement will each continue to apply, but only to the extent that such terms and conditions are not inconsistent with the rights provided to you under the aforementioned provisions of the FAR and DFARS, as applicable to the particular procuring agency and procurement transaction.

Term of license

Your right to use the Software will continue in perpetuity unless terminated as follows. Your right to use the Software will terminate immediately without notice upon a breach of this Agreement by you. Within 30 days after termination of this Agreement, you will certify to Cambium Networks in writing that through your best efforts, and to the best of your knowledge, the original and all copies, in whole or in part, in any form, of the Software and all related material and Documentation, have been destroyed, except that, with prior written consent from Cambium Networks, you may retain one copy for archival or backup purposes. You may not sublicense, assign or transfer the license or the Product, except as expressly provided in this Agreement. Any attempt to otherwise sublicense, assign or transfer any of the rights, duties or obligations hereunder is null and void.

Governing law

This Agreement is governed by the laws of the United States of America to the extent that they apply and otherwise by the laws of the State of Illinois.

Assignment

This agreement may not be assigned by you without Cambium’s prior written consent.

Survival of provisions

The parties agree that where the context of any provision indicates an intent that it survives the term of this Agreement, then it will survive.

Entire agreement

This agreement contains the parties’ entire agreement regarding your use of the Software and may be amended only in writing signed by both parties, except that Cambium Networks may modify this Agreement as necessary to comply with applicable laws.

Third party software

The software may contain one or more items of Third-Party Software supplied by other third-party suppliers. The terms of this Agreement govern your use of any Third- Party Software UNLESS A SEPARATE THIRD-PARTY SOFTWARE LICENSE IS INCLUDED, IN WHICH CASE YOUR USE OF THE THIRD-PARTY SOFTWARE WILL THEN BE GOVERNED BY THE SEPARATE THIRD-PARTY LICENSE. The list of Open Source Software packages are available in [here](#).

Compliance with safety standards

This section lists the safety specifications against which the 60 GHz cnWave™ Platform Family has been tested and certified. It also describes how to keep RF exposure within safe limits.

Electrical safety compliance

The 60 GHz cnWave™ Platform Family hardware has been tested for compliance to the electrical safety specifications listed in following table.

Table 24 :Safety compliance specifications

Region	Specification
USA	UL 62368-1, UL 60950-22
Canada	CSA C22.2 No.62368-1, CSA C22.2 No. 60950-22
Europe	EN 62368-1, EN 60950-22
International	CB certified IEC 62368-1 Edition 2 IEC 60950 -22

Electromagnetic compatibility (EMC) compliance

The EMC specification type approvals that have been granted for 60 GHz cnWave™ Platform Family are listed in following table.

Table 25 :EMC compliance

Region	Specification
USA	FCC Part 15 Class B
Canada	RSS Gen
Europe/International	EN 301 489-1 V2.1.1, EN 301 489-17 V3.1.1

Human exposure to radio frequency energy

Relevant standards (USA and EC) applicable when working with RF equipment are:

- ANSI/IEEE C95.1-2005, IEEE Standard for Safety Levels with Respect to Human Exposure to Radio Frequency Electromagnetic Fields, 3 kHz to 300 GHz
- Council recommendation of 12 July 1999 on the limitation of exposure of the general public to electromagnetic fields (0 Hz to 300 GHz) (1999/519/EC) and respective national regulations
- *Directive 2013/35/EU - electromagnetic fields* of 26 June 2013 on the minimum health and safety requirements regarding the exposure of workers to the risks arising from physical agents (electromagnetic fields) (20th individual Directive within the meaning of Article 16(1) of Directive 89/391/EEC) and repealing Directive 2004/40/EC.
- US FCC limits for the general population. See the FCC website at <http://www.fcc.gov>, and the policies, guidelines, and requirements in Part 1 of Title 47 of the Code of Federal Regulations, as well as the guidelines and suggestions for evaluating compliance in FCC OET Bulletin 65
- Health Canada limits for the general population. See the Health Canada website at <https://www.canada.ca/en/health-canada/services/environmental-workplace-health/consultations/limits-human-exposure-radiofrequency-electromagnetic-energy-frequency-range-3-300.html> and [Safety Code 6](#)
- EN 62232: 2017 Determination of RF field strength, power density and SAR in the vicinity of radiocommunication base stations for the purpose of evaluating human exposure (IEC 62232:2017)
- EN 50385: 2017 Product standard to demonstrate the compliance of base station equipment with radio frequency electromagnetic field exposure limits (110 MHz - 100 GHz), when placed on the market
- ICNIRP (International Commission on Non-Ionizing Radiation Protection) guidelines for the general public. See the ICNIRP website at <https://www.icnirp.org/cms/upload/publications/ICNIRPmfgdl.pdf> and Guidelines for Limiting Exposure to Time-Varying Electric, Magnetic, and Electromagnetic Fields.

Power density exposure limit

Install the radios for the 60 GHz cnWave™ Platform Family of wireless solutions so as to provide and maintain the minimum separation distances from all persons.

The applicable FCC power density exposure limit for RF energy in the 57 – 66 GHz frequency bands is 10 W/m². For more information, see [Human exposure to radio frequency energy](#).

Calculation of power density

The following calculation is based on the ANSI IEEE C95.1-1991 method, as that provides a worst case analysis.

Peak power density in the far field of a radio frequency point source is calculated as follows:

$$S = \frac{P \cdot G}{4\pi d^2}$$

Where:

S: power density in W/m²

p: maximum average transmit power capability of the radio, in W G: total Tx gain as a factor, converted from dB

d: distance from point source, in m Rearranging terms to

solve for distance yields:

$$d = \sqrt[4]{\frac{P \cdot G}{4\pi S}}$$

Calculated distances and power compliance margins

The following tables show calculated recommended separation distances, for the 60 GHz cnWave™ for Europe the USA and Canada. These are conservative distances that include compliance margins.

Les tableaux suivants indiquent les distances de séparation recommandées calculées pour le cnWave™ 60 GHz pour l'Europe, les États-Unis et le Canada. Ce sont des distances prudentes qui incluent des marges de conformité.

At these and greater separation distances, the power density from the RF field is below generally accepted limits for the general population.

À ces distances de séparation et à des distances supérieures, la densité de puissance du champ RF est inférieure aux limites généralement acceptées pour la population générale

60 GHz cnWave™ Platform Family ODU adheres to all applicable EIRP limits for transmit power when operating in MIMO mode. Separation distances and compliance margins include compensation for the antenna configuration of each product.

L'ODU de la famille de plates-formes cnWave™ 60 GHz respecte toutes les limites EIRP applicables pour la puissance de transmission lors d'un fonctionnement en mode MIMO. Les distances de séparation et les marges de conformité incluent la compensation de la configuration d'antenne de chaque produit.

Product	Countries	EIRP (dBm)	EIRP (W)	Maximum power density (W/m ²)	Compliance distance (m)
V1000	USA, Canada, EU	38	6.3	10	0.22
V3000	USA, Canada	60	1000	10	2.82
V3000	EU and CEPT	55	316.2	10	1.6
V5000	USA, Canada, EU	38	6.3	10	0.22



Note

The regulations require that the power used for the calculations is the maximum power in the transmit burst subject to allowance for source-based time-averaging.

The calculations above are based upon platform maximum EIRP and worst case 100% duty cycle.



Remarque

Les réglementations exigent que la puissance utilisée pour les calculs soit la puissance maximale de la rafale d'émission sous réserve de la moyenne temporelle basée sur la source.

Les calculs ci-dessus sont basés sur la PIRE maximale de la plate-forme et le pire des cas, un cycle de service de 100%.

Compliance with radio regulations

This section describes how the 60 GHz cnWave™ Platform Family complies with the radio regulations that are in force in various countries.



Caution

Where necessary, the end user is responsible for obtaining any National licenses required to operate this product and these must be obtained before using the product in any particular country. Contact the appropriate national administrations for details of the conditions of use for the bands in question and any exceptions that might apply.



Attention

Le cas échéant, l'utilisateur final est responsable de l'obtention des licences nationales nécessaires pour faire fonctionner ce produit. Celles-ci doivent être obtenus avant d'utiliser le produit dans un pays particulier. Contactez les administrations nationales concernées pour les détails des conditions d'utilisation des bandes en question, et toutes les exceptions qui pourraient s'appliquer.

**Caution**

Changes or modifications not expressly approved by Cambium Networks could void the user's authority to operate the system.

**Attention**

Les changements ou modifications non expressément approuvés par les réseaux de Cambium pourraient annuler l'autorité de l'utilisateur à faire fonctionner le système.

Type approvals

The system has been tested against various local technical regulations and found to comply. Table 26 to Table 26 list the radio specification type approvals that have been granted for the 60GHz cnWave products.

Some of the frequency bands in which the system operates are “license exempt” and the system is allowed to be used provided it does not cause interference. In these bands, the licensing authority does not guarantee protection against interference from other products and installations.

Table 26:Type approvals

Region	Regulatory approvals	FCC ID	IC ID
USA	Part 15C	QWP-60V1000 QWP-60V3000 QWP-60V5000	
Canada	ISED RSS-210		109AO-60V1000 109AO-60V3000 109AO-60V5000

FCC compliance

The 60 GHz cnWave V1000, V3000 and V5000 comply with the regulations that are in force in the USA.



Caution

If this equipment does cause interference to radio or television reception.

FCC notification

This device complies with part 15C of the US FCC Rules. Operation is subject to the following two conditions: (1) This device may not cause harmful interference, and (2) This device must accept any interference received, including interference that may cause undesired operation.

ISED compliance

The 60 GHz cnWave V1000, V3000 and V5000 comply with the regulations that are in force in the Canada.



Caution







If this equipment does cause interference to radio or television reception.

















Attention







Si cet équipement cause des interférences à la réception radio ou télévision.

60 GHz cnWave product labels

<p>Model No/HVIN:V5000  Part No:C600500A004A  SERIAL NO (MSN):#####  MAC (ESN):##### </p> <p>This device complies with part 15 of the FCC Rules. Operation is subject to the following two conditions: (1) This device may not cause harmful interference, and (2) this device must accept any interference received, including interference that may cause undesired operation</p> <p>IMPORTANT: See the System User Guide before connecting to AC Power. The Guide is available online at www.cambiumnetworks.com/guides</p> <p>MADE IN CHINA X-SZHO-H</p>	<p> Cambium Networks™ IP66/67 Ashburton, TQ13 7UP, UK 60GHz cnWave V5000 Distribution Node VIN: 42.5-57V --- IMAX: 1.41A</p> <p> E112443 COMPLIES WITH UL62368-1 / CSA C22.2 No. 62368-1-14 UL60950-22 / CSA C22.2 No. 60950-22-17</p> <p>FCC ID: QWP-60V5000 IC: 109AO-60V5000</p> <p></p>
---	---

<p>Model No/HVIN:V3000  Part No:C600500C024A  SERIAL NO (MSN):#####  MAC (ESN):##### </p> <p>This device complies with part 15 of the FCC Rules. Operation is subject to the following two conditions: (1) This device may not cause harmful interference, and (2) this device must accept any interference received, including interference that may cause undesired operation</p> <p>IMPORTANT: See the System User Guide before connecting to AC Power. The Guide is available online at www.cambiumnetworks.com/guides</p> <p>MADE IN CHINA X-SZHO-H</p>	<p> Cambium Networks™ IP66/67 Ashburton, TQ13 7UP, UK 60GHz cnWave V3000 Client Node Radio Only VIN: 42.5-57V --- IMAX:1.29A</p> <p> E112443 COMPLIES WITH UL62368-1 / CSA C22.2 No. 62368-1-14 UL60950-22 / CSA C22.2 No. 60950-22-17</p> <p>FCC ID: QWP-60V3000 IC: 109AO-60V3000</p> <p></p>
---	---

<p>Model No/HVIN:V1000  Part No:C600500C001A  SERIAL NO (MSN):#####  MAC (ESN):##### </p> <p>This device complies with part 15 of the FCC Rules. Operation is subject to the following two conditions: (1) This device may not cause harmful interference, and (2) this device must accept any interference received, including interference that may cause undesired operation</p> <p>IMPORTANT: See the System User Guide before connecting to AC Power. The Guide is available online at www.cambiumnetworks.com/guides</p> <p>MADE IN CHINA X-SZHO-H</p>	<p> Cambium Networks™ IP66/67 Ashburton, TQ13 7UP, UK 60GHz cnWave V1000 Client Node with US cord VIN: 42.5-57V --- IMAX: 0.24A</p> <p> E112443 COMPLIES WITH UL62368-1 / CSA C22.2 No. 62368-1-14 UL60950-22 / CSA C22.2 No. 60950-22-17</p> <p>FCC ID: QWP-60V1000 IC: 109AO-60V1000</p> <p></p>
---	--

<p>Model No/HVIN:V1000  Part No:C600500C014A  SERIAL NO (MSN):#####  MAC (ESN):##### </p> <p>This device complies with part 15 of the FCC Rules. Operation is subject to the following two conditions: (1) This device may not cause harmful interference, and (2) this device must accept any interference received, including interference that may cause undesired operation</p> <p>IMPORTANT: See the System User Guide before connecting to AC Power. The Guide is available online at www.cambiumnetworks.com/guides</p> <p>MADE IN CHINA X-SZHO-H</p>	<p> Cambium Networks™ IP66/67 Ashburton, TQ13 7UP, UK 60GHz cnWave V1000 Client Node with no Cord VIN: 42.5-57V --- IMAX: 0.24A</p> <p> E112443 COMPLIES WITH UL62368-1 / CSA C22.2 No. 62368-1-14 UL60950-22 / CSA C22.2 No. 60950-22-17</p> <p>FCC ID: QWP-60V1000 IC: 109AO-60V1000</p> <p></p>
---	--

Chapter 6: Installation

Safety



Warning

To prevent loss of life or physical injury, observe the following safety guidelines. In no event shall Cambium Networks be liable for any injury or damage caused during the installation of the Cambium 60 GHz cnWave radio nodes. Ensure that only qualified personnel install 60 GHz cnWave radios.

Power lines

Exercise extreme care when working near power lines.

Working at heights

Exercise extreme care when working at heights.

PSU

Always use one of the approved power supply options. Failure to use the Cambium supplied PSUs could result in equipment damage and will invalidate the safety certification and may cause a safety hazard.

Grounding and protective earth

The cnWave radios must be properly grounded to protect against lightning. It is the user's responsibility to install the equipment in accordance with national regulations. In the USA follow the requirements of the National Electrical code NFPA 70-2005 and 780-2004 *Installation of Lightning Protection Systems*. In Canada, follow Section 54 of the *Canadian Electrical Code*. These codes describe correct installation procedures for grounding the outdoor unit, mast, lead-in wire and discharge unit, size of grounding conductors and connection requirements for grounding electrodes. Other regulations may apply in different countries and therefore it is recommended that installation of the outdoor unit be contracted to a professional installer.

AC supply

Always use an appropriately rated and approved AC supply cord-set in accordance with the regulations of the country of use.

Powering down before servicing

Before servicing 60 GHz cnWave equipment, always switch off the power supply and unplug it from the PSU.

Do not disconnect the RJ45 drop cable connectors from the radio while the PSU is connected to the power supply. Always remove the AC or DC input power from the PSU.

Primary disconnect device

The main power supply is the primary disconnect device.

External cables

Safety may be compromised if outdoor rated cables are not used for connections that will be exposed to the outdoor environment.

Drop cable tester

The PSU output voltage may be hazardous in some conditions, for example in wet weather. Do not connect a drop cable tester to the PSU, either directly or via LPUs.

RF exposure near the antenna

Strong radio frequency (RF) fields will be present close to the antenna when the transmitter is on. Always turn off the power to the radio before undertaking maintenance activities in front of the antenna.

Minimum separation distances

Ensure that personnel are not exposed to unsafe levels of RF energy. The units start to radiate RF energy as soon as they are powered up. Never work in front of the antenna when the radio is powered. Install the radios so as to provide and maintain the minimum separation distances from all persons. For minimum separation distances, see [Link to separation distances table](#).

Grounding and lightning protection requirements

Ensure that the installation meets the requirements defined in Installation section.

Grounding cable installation methods

To provide effective protection against lightning induced surges, observe these requirements:

- Grounding conductor runs are as short, straight and smooth as possible, with bends and curves kept to a minimum.
- Grounding cables must not be installed with drip loops.
- All bends must have a minimum radius of 200 mm (8 in) and a minimum angle of 90°. A diagonal run is preferable to a bend, even though it does not follow the contour or run parallel to the supporting structure.
- All bends, curves and connections must be routed towards the grounding electrode system, ground rod, or ground bar.
- Grounding conductors must be securely fastened.
- Braided grounding conductors must not be used.
- Approved bonding techniques must be used for the connection of dissimilar metals.

Siting radios

Radios are not designed to survive direct lightning strikes. For this reason, they must be installed in Zone B as defined in *Lightning protection zones*. Mounting in Zone A may put equipment, structures and life at risk.

60 GHz cnWave radios and mounting bracket options

Mounting bracket options

The 60 GHz cnWave series supports eight mounting bracket options. Select the optimum mounting bracket arrangement based on the ODU type and the choice of wall or pole mounting. The wall mount plate for V1000 is included with the ODU. Order the remaining brackets separately.

Table 22 :ODU mounting bracket part numbers

Bracket	Pole diameter	ODU variants	Bracket part number
V1000 Wall Mount	Wall mount	V1000	Included with V1000
V1000 Pole Mount	40 mm to 77 mm (1.6 inches to 3.0 inches)	V1000	Included with V1000
Adjustable Pole Mount	40 mm to 77 mm (1.6 inches to 3.0 inches)	V1000	N000900L022A
Tilt Bracket Assembly	40 mm to 77 mm (1.6 inches to 3.0 inches)	V3000, V5000	N000045L002A
Tilt Bracket Assembly with band clamps	90 mm to 230 mm (3.6 inches to 9.0 inches)	V3000, V5000	N000045L002A + third-party band clamps
Wall Mount Bracket	Wall mount	V5000	C000000L136A
Pole Mount Bracket	25 mm to 77 mm (1.0 inches to 3.0 inches)	V5000	C000000L137A
Precision Bracket	25 mm to 77 mm (1.0 inches to 3.0 inches)	V3000	C000000L125A

Installing the cnWave radio nodes

To install the radio, use the following procedures:

1. [Attach ground cables to the radio](#)
2. [Mount the radio on the mast](#)
3. [Ground the radio](#)

Attach ground cables to the radio

1. Fasten the ground cable to the radio grounding point using the M6 lug.

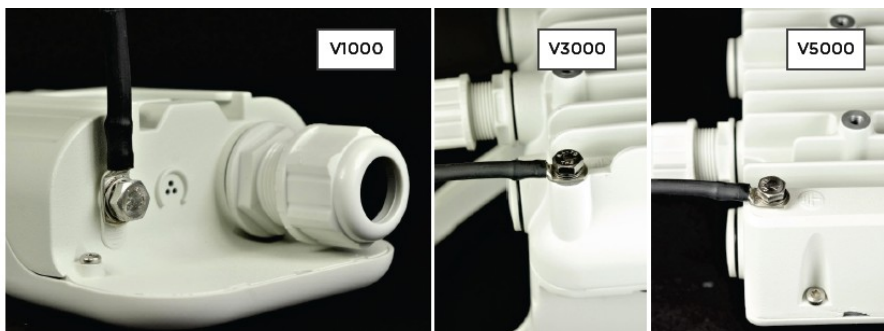

2. Tighten the ODU grounding bolt to a torque of 5 Nm (3.9 lb ft).

Mount the radio on the mast

Select the most appropriate bracket mounting arrangement from the options listed in Mounting bracket options on page 5-5. Refer to individual procedures below for each of the options:

- [V1000wallmount](#)
- [V1000polemount](#)
- [V1000adjustable pole mount](#)
- [V3000/V5000Tilt bracket assembly](#)
- [V3000/V5000Tilt Bracket assembly with band clamps](#)
- [V5000wallmountbracket](#)
- [V5000polemountbracket](#)
- [V3000 precision bracket](#)

V1000 wall mount

1. Fix the mounting plate (supplied with the V1000 ODU) securely to a vertical wall, using suitable fixings. Note that fixing hardware is not supplied with the V1000.
2. Slide the V1000 ODU onto the mounting plate from above, ensuring that the spring clip in the mounting plate clicks into place on the radio.

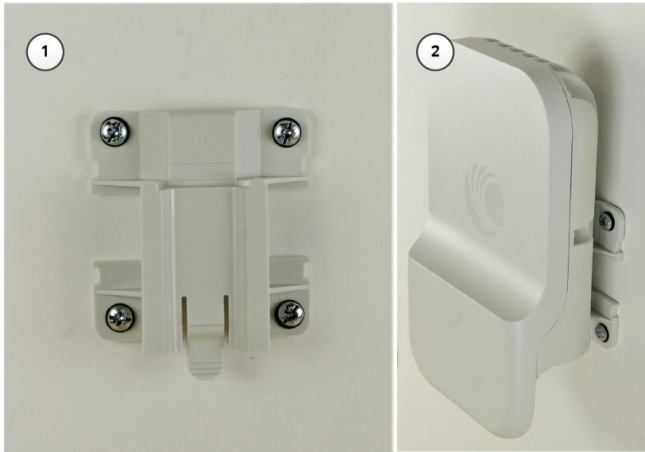

V1000 pole mount



V1000 adjustable pole mount

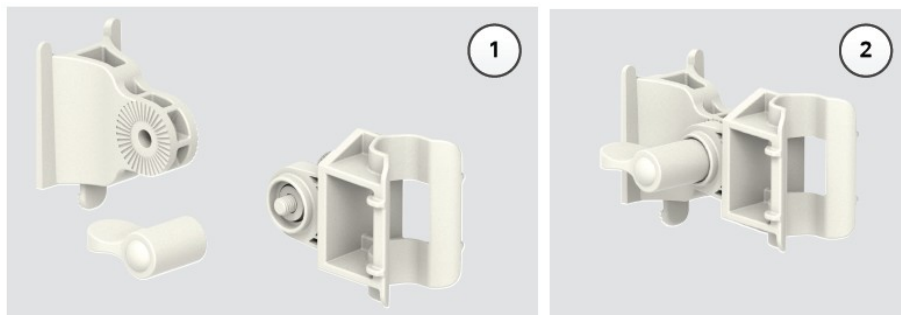

V3000 Tilt bracket assembly

1. Fix the mounting plate of the Tilt Bracket to the back of the radio using four of the short bolts, ensuring that the arrow in the plate points towards the top of the radio. Tighten the four bolts to a torque setting of 5.0 Nm (3.7 lb ft) using a 13 mm spanner or socket.
2. Fit the two long bolts through the bracket body so that the bolt heads engage in the slots as shown. Fit two of the short bolts into the side of the bracket body but do not tighten.
3. Thread two of the nuts to the long bolts and tighten against the bracket body using a 13 mm spanner. Fit the bracket strap and thread the remaining nuts onto the long bolts.
4. Fix the assembled bracket body to the pole, adjust the azimuth angle, and tighten the nuts to a torque setting of 10.0 Nm (7.4 lb ft) using a 13 mm spanner, ensuring that the arrow in the body is pointing upwards.
5. Fit the mounting plate to the bracket body by positioning the open-ended slots over the short bolts. Insert the remaining short bolts through the longer curved slots into the threaded holes in the bracket body. Adjust the elevation angle, and tighten the bolts to a torque setting of 5.0 Nm (3.7 lb ft) using a 13 mm spanner or socket.

V3000 Tilt Bracket assembly with band clamps

1. Follow **Step 1** for the Tilt Bracket assembly procedure [above](#).
2. Feed the band clamps through the slots in the bracket body. Secure the bracket body to the pole using band clamps (not supplied by Cambium), ensuring that the arrow in the body is pointing upwards. Adjust the azimuth angle, and tighten the band clamps to a torque setting of 6.0 Nm (4.5 lb ft).
3. Fix the mounting plate to the bracket body with four of the short bolts, using a 13 mm spanner or socket. Adjust the elevation angle, and tighten the bolts to a torque setting of 5.0 Nm (3.7 lb ft).

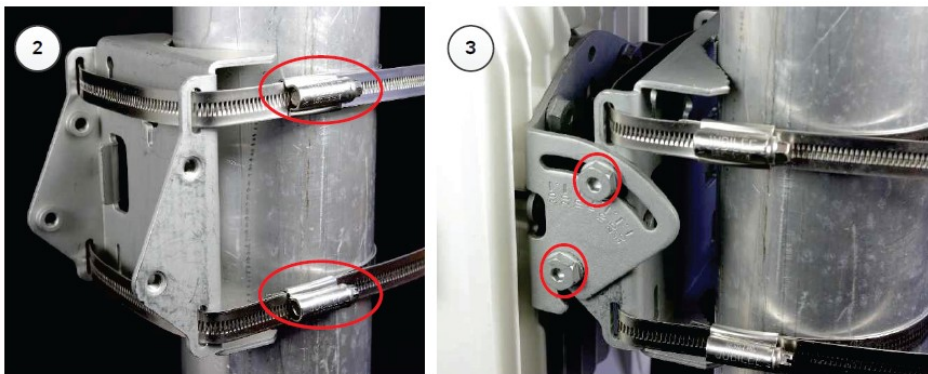

V5000 wall mount bracket

1. Install the mounting plate of the Wall Mount Bracket securely on a vertical wall, using suitable fixings.
Note that fixing hardware is not supplied with the Wall Mount Bracket.
2. Fix the bracket body to the back of the radio using the four short M6 bolts, ensuring that the arrow in the plate points towards the top of the radio. Tighten the four bolts to a torque setting of 5.0 Nm (3.7 lb ft) using a 13 mm spanner or socket.
Insert the four short M8 bolts into the sides of the bracket body.
3. Fit the bracket body to the mounting plate by positioning the short bolts into the open-ended slots.

Tighten the bolts to a torque setting of 5.0 Nm (3.7 lb ft) using a 13 mm spanner or socket.

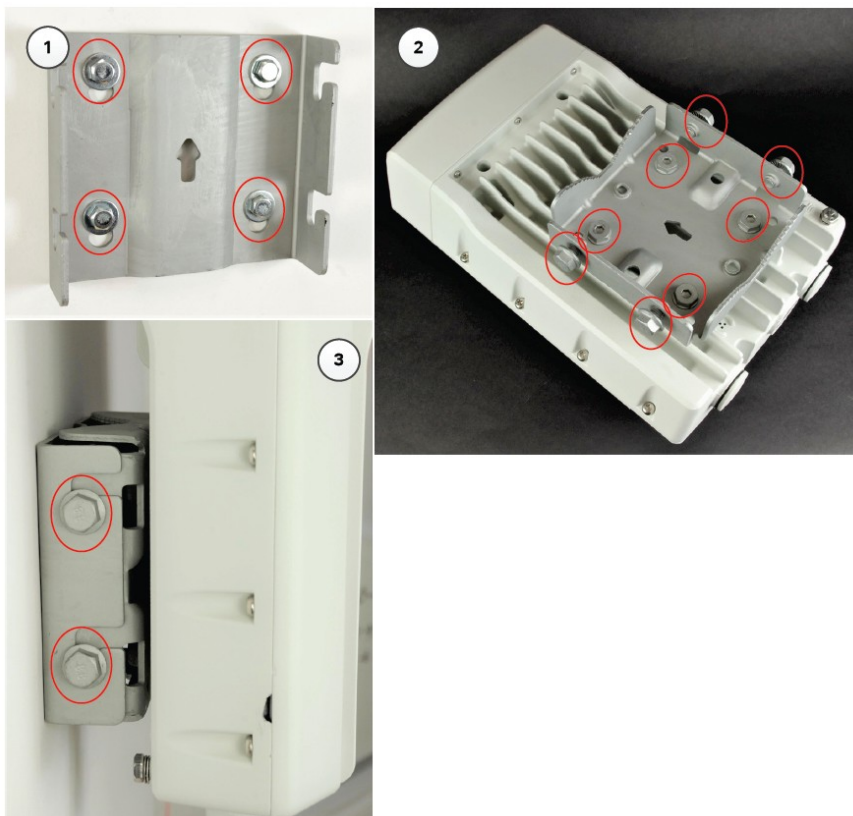

V5000 pole mount bracket

1. Pass the long screws through the bracket body. The screws locate in the recess in the bracket.
2. Fit two flanged nuts to the long screws on the back of the bracket. Tighten using a 13 mm spanner.
3. Fix the bracket to the back of the radio using the four short M6 bolts, ensuring that the arrow in the plate points towards the top of the radio. Tighten the four bolts to a torque setting of 5.0 Nm (3.7 lb ft) using a 13 mm spanner or socket.
4. Attach the pole-mount bracket to the pole using the clamp and the remaining flanged nuts. Adjust azimuth and tighten the nuts to 10 Nm (7.4 lbft) using a 13 mm spanner.

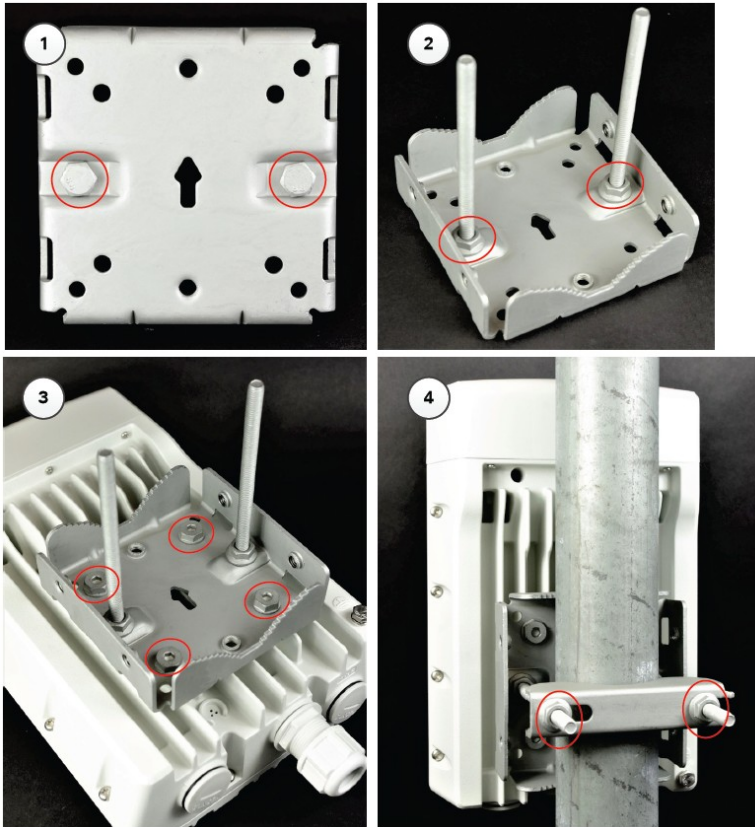

V3000 Precision Bracket

1. Pass two of the long (120 mm) screws through the azimuth arm and the bracket body. The screws locate in the slots in the azimuth arm.
2. Fit two flanged M8 nuts to the long screws on the back of the bracket. Tighten using a 13 mm spanner.

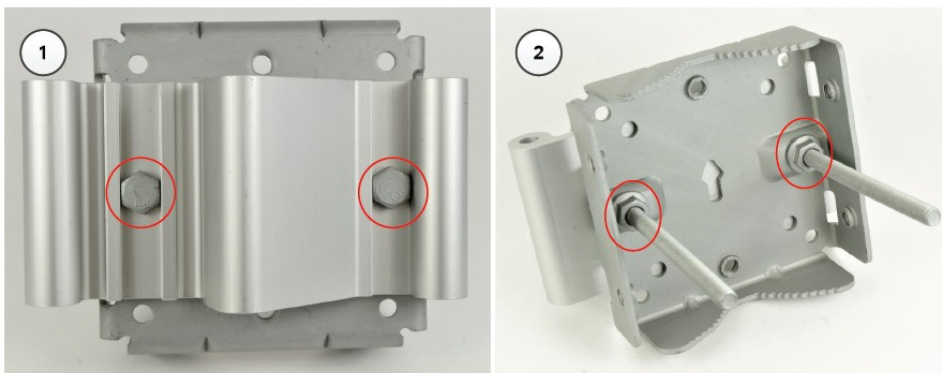

3. Pass the three medium length (40 mm) M8 screws through the bracket base and the V3000 mount. The screws locate in the slots in the bracket base.
4. Ensure that the pivot pin in the elevation adjuster is located in the circular hole in the V3000 mount.
5. Fit plain washers and M8 Nyloc nuts to the screws on the back of the bracket base. Tighten using a 13 mm spanner.

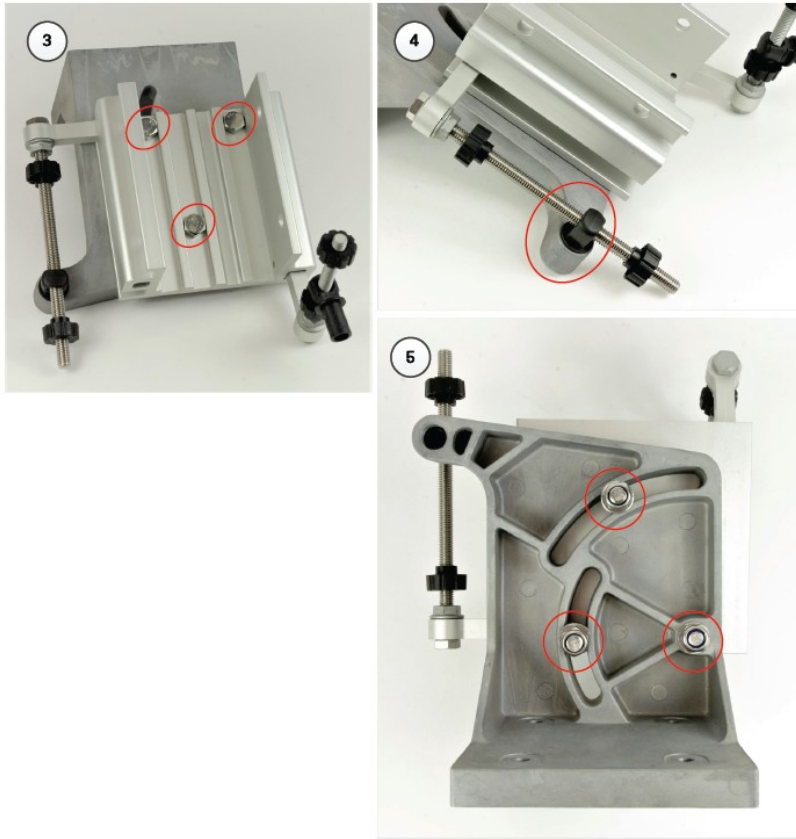

6. Pass the two remaining long (120 mm) M8 screws through the bracket body and the azimuth arm. The screws locate in the slots in the bracket body.
7. Ensure that the pivot pin in the azimuth adjuster is located in the circular hole in the bracket body.
8. Fit three sets of spacers, plain washers and M8 Nyloc nuts to the screws on the underside of the bracket base. Tighten using a 13 mm spanner.

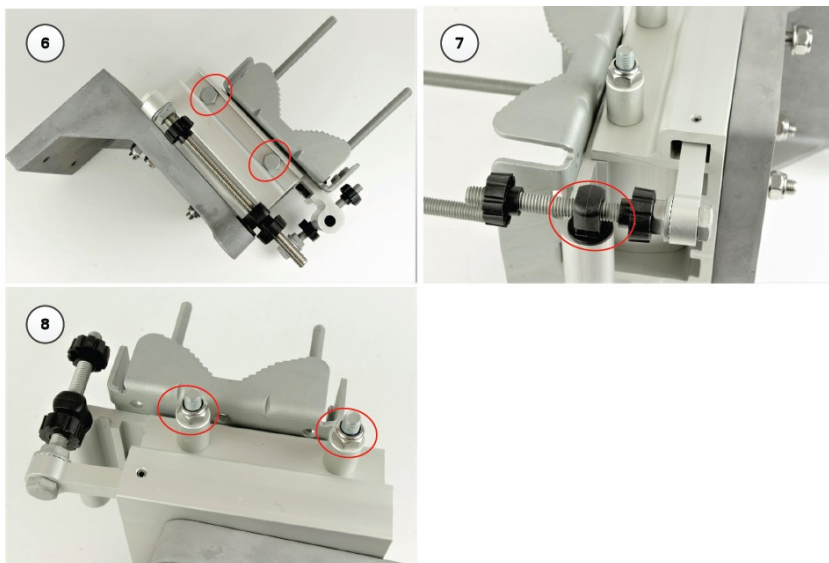

9. Attach the V3000 mount to the radio using the four short M6 bolts. Tighten the four bolts to a torque setting of 5.0

Nm (3.7 lb ft) using a 13 mm spanner or socket.

10. Attach the precision bracket to the pole using the clamp and the remaining flanged nuts. Adjust azimuth approximately and tighten the nuts to 10 Nm (7.4 lbft) using a 13 mm spanner.

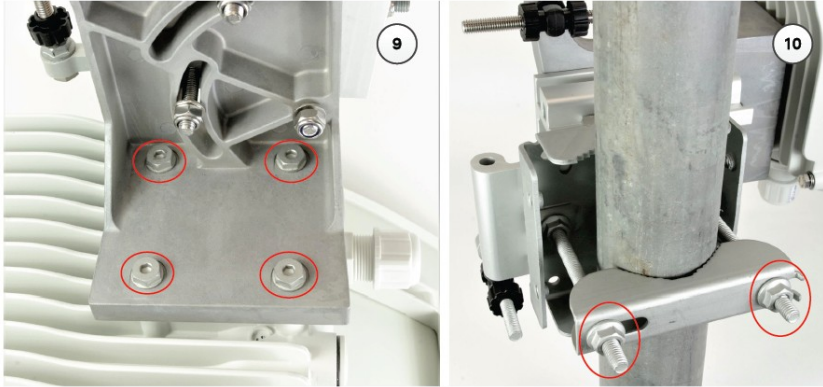

11. Align the antenna elevation using the fine elevation adjuster.
12. Align the antenna azimuth using the fine azimuth adjuster.
13. Lock the antenna alignment by tightening the five Nyloc nuts (see Steps 5 and 8) to 10 Nm (7.4 lbft) using a 13 mm spanner or socket.

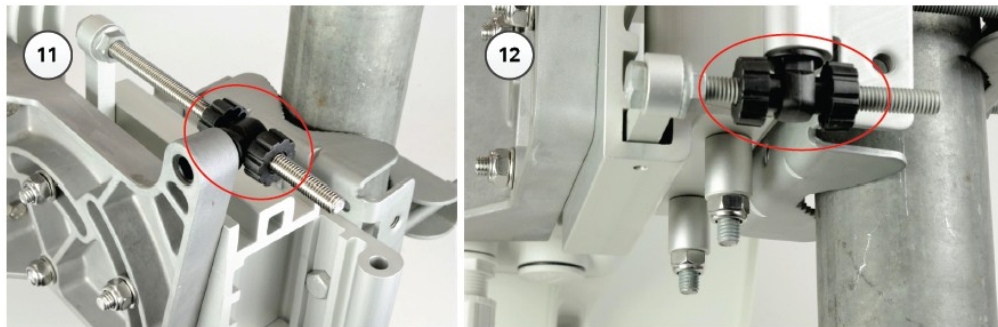

Precision bracket alignment telescope

1. Attach the telescope mount to the V3000 radio using the knurled screw.
2. Attach the telescope by looping the two elastic O-rings over the ears of the mount, ensuring that the telescope is located securely in the mount.



Install the PSU

Install one of the following types of PSU:

- DCPowerInjector
- DCPowerSupply
- V1000PowerInjector



Warning

Always use an appropriately rated and approved AC supply cord-set in accordance with the regulations of the country of use.



Attention

As the PSU is not waterproof, locate it away from sources of moisture, either in the equipment building or in a ventilated moisture-proof enclosure. Do not locate the PSU in a position where it may exceed its temperature rating.



Attention

Do not plug any device other than a PTP 700 ODU into the ODU port of the PSU. Other devices may be damaged due to the non-standard techniques employed to inject DC power into the Ethernet connection between the PSU and the ODU.

Do not plug any device other than a Cambium PTP 700 PSU into the PSU port of the ODU. Plugging any other device into the PSU port of the ODU may damage the ODU and device.

Installing the 60 W DC power injector

- Connect the 5GbE Port to ODU and 5GbE LAN port to the network equipment.

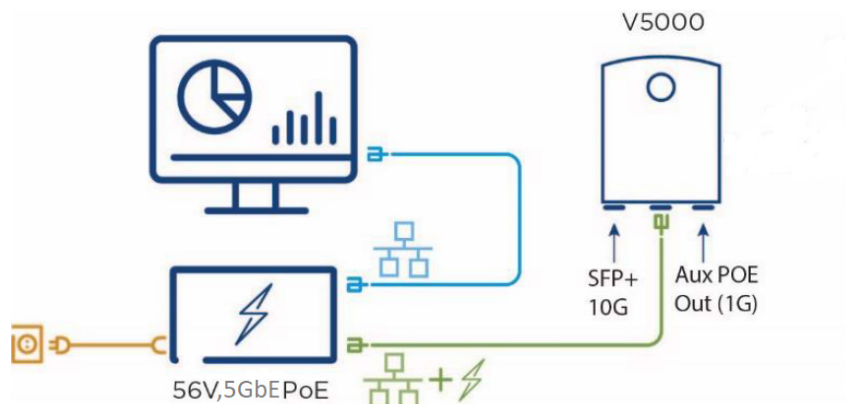

Installing the AC/DC PSU

- Connect Input side of the AC/DC PSU to AC power line.
- Connect the Output side of DC PSU to ODU through Cable joiner and DC mini Adapter

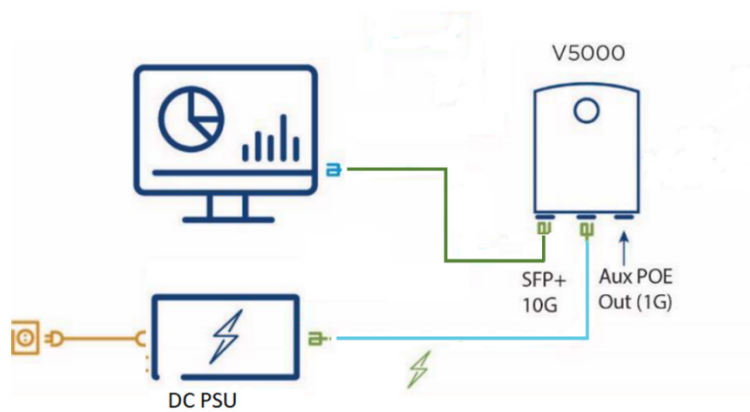

Installing the V1000 power injector

- Connect the 56V Gigabit Data + Power port to ODU and Gigabit Data port to the network equipment.



