

Cambium 450 Platform User Guide

System Release 15.1.4



Accuracy

While reasonable efforts have been made to assure the accuracy of this document, Cambium Networks assumes no liability resulting from any inaccuracies or omissions in this document, or from use of the information obtained herein. Cambium reserves the right to make changes to any products described herein to improve reliability, function, or design, and reserves the right to revise this document and to make changes from time to time in content hereof with no obligation to notify any person of revisions or changes. Cambium does not assume any liability arising out of the application or use of any product, software, or circuit described herein; neither does it convey license under its patent rights or the rights of others. It is possible that this publication may contain references to, or information about Cambium products (machines and programs), programming, or services that are not announced in your country. Such references or information must not be construed to mean that Cambium intends to announce such Cambium products, programming, or services in your country.

Copyrights

This document, Cambium products, and 3rd Party software products described in this document may include or describe copyrighted Cambium and other 3rd Party supplied computer programs stored in semiconductor memories or other media. Laws in the United States and other countries preserve for Cambium, its licensors, and other 3rd Party supplied software certain exclusive rights for copyrighted material, including the exclusive right to copy, reproduce in any form, distribute and make derivative works of the copyrighted material. Accordingly, any copyrighted material of Cambium, its licensors, or the 3rd Party software supplied material contained in the Cambium products described in this document may not be copied, reproduced, reverse engineered, distributed, merged or modified in any manner without the express written permission of Cambium. Furthermore, the purchase of Cambium products shall not be deemed to grant either directly or by implication, estoppel, or otherwise, any license under the copyrights, patents or patent applications of Cambium or other 3rd Party supplied software, except for the normal non-exclusive, royalty free license to use that arises by operation of law in the sale of a product.

Restrictions

Software and documentation are copyrighted materials. Making unauthorized copies is prohibited by law. No part of the software or documentation may be reproduced, transmitted, transcribed, stored in a retrieval system, or translated into any language or computer language, in any form or by any means, without prior written permission of Cambium.

License Agreements

The software described in this document is the property of Cambium and its licensors. It is furnished by express license agreement only and may be used only in accordance with the terms of such an agreement.

High Risk Materials

Cambium and its supplier(s) specifically disclaim any express or implied warranty of fitness for any high risk activities or uses of its products including, but not limited to, the operation of nuclear facilities, aircraft navigation or aircraft communication systems, air traffic control, life support, or weapons systems ("High Risk Use"). Any "High Risk Use" is unauthorized, is made at your own risk and you shall be responsible for any and all losses, damage or claims arising out of any High Risk Use.

© 2018 Cambium Networks Limited. All Rights Reserved.

Contents

Cambium 450 Platform User Guide	1
Contents	i
List of Figures	xiv
List of Tables.....	xix
About This User Guide.....	1
Contacting Cambium Networks.....	1
Purpose	2
Product notation conventions in document	2
Cross references.....	3
Feedback	3
Important regulatory information.....	4
Application software.....	4
USA specific information.....	4
Canada specific information	5
Renseignements spécifiques au Canada	6
EU Declaration of Conformity	7
Specific expertise and training for professional installers.....	7
Ethernet networking skills	7
Lightning protection.....	8
Training	8
Problems and warranty	9
Reporting problems	9
Repair and service.....	9
Hardware warranty	9
Security advice	10
Warnings, cautions, and notes	11
Warnings.....	11
Cautions	11
Notes	11
Caring for the environment.....	12
In EU countries	12
In non-EU countries	12
Chapter 1: Product description.....	1-1
Overview of the 450 Platform Family.....	1-2
Purpose	1-2
PMP 450m Series	1-2
PMP/PTP 450i Series	1-4

PMP 450b Series.....	1-8
PMP/PTP 450 Series.....	1-10
Supported interoperability for 450m/450i/450b/450 Series.....	1-13
Typical deployment.....	1-14
Product variants	1-16
Wireless operation	1-17
Time division duplexing	1-17
Encryption.....	1-20
MIMO.....	1-20
MU-MIMO	1-20
System management.....	1-22
Management agent.....	1-22
Web server.....	1-22
Remote Authentication Dial-in User Service (RADIUS).....	1-24
Network Time Protocol (NTP)	1-24
Wireless Manager (WM).....	1-25
cnMaestro™	1-26
Radio recovery mode.....	1-27
Chapter 2: System hardware.....	2-1
System Components	2-2
Point-to-Multipoint (PMP).....	2-2
Backhaul (PTP).....	2-5
450 Platform Family interfaces	2-7
ATEX/HAZLOC variants	2-14
Diagnostic LEDs.....	2-15
Power supply options	2-19
ODU mounting brackets & accessories.....	2-28
Lightning protection.....	2-28
ODU interfaces	2-29
PMP 450m Series AP.....	2-29
PMP/PTP 450i.....	2-30
PMP 450b	2-32
Cabling	2-33
Ethernet standards and cable lengths.....	2-33
Outdoor copper Cat5e Ethernet cable	2-34
SFP module kits.....	2-35
Main Ethernet port	2-37
Aux port	2-37
Lightning protection unit (LPU) and grounding kit.....	2-41
Cable grounding kit.....	2-42
Antennas and antenna cabling	2-43
Antenna requirements	2-43
Supported external AP antennas.....	2-43

Supported external BH/SM antenna.....	2-43
RF cable and connectors	2-43
Antenna accessories	2-44
GPS synchronization.....	2-45
GPS synchronization description.....	2-45
Universal GPS (UGPS)	2-45
CMM5	2-46
CMM5 Controller Module.....	2-48
CMM5 Injector Module	2-49
CMM5 Injector Compatibility Matrix	2-49
CMM5 Specifications	2-50
CMM4 (Rack Mount)	2-51
CMM4 (Cabinet with switch).....	2-54
CMM4 (Cabinet without switch)	2-54
CMM3/CMMmicro	2-55
Installing a GPS receiver	2-57
GPS receiver location.....	2-57
Mounting the GPS receiver	2-58
Cabling the GPS Antenna.....	2-59
Installing and connecting the GPS LPU	2-59
Ordering the components	2-60
Chapter 3: System planning	3-1
Typical deployment	3-2
ODU with PoE interface to PSU	3-2
Site planning.....	3-7
Site selection for PMP/PTP radios	3-7
Power supply site selection.....	3-8
Maximum cable lengths	3-8
Grounding and lightning protection.....	3-8
ODU and external antenna location	3-10
ODU ambient temperature limits	3-10
ODU wind loading.....	3-11
Hazardous locations.....	3-15
Drop cable grounding points	3-15
Lightning Protection Unit (LPU) location	3-16
Radio Frequency planning	3-17
Regulatory limits	3-17
Conforming to the limits.....	3-17
Available spectrum	3-17
Analyzing the RF Environment	3-18
Channel bandwidth	3-18
Anticipating Reflection of Radio Waves.....	3-18
Obstructions in the Fresnel Zone.....	3-19

Planning for co-location.....	3-19
Multiple OFDM Access Point Clusters.....	3-20
Considerations on back-to-back frequency reuse.....	3-22
Link planning.....	3-27
Range and obstacles.....	3-27
Path loss.....	3-27
Calculating Link Loss.....	3-28
Calculating Rx Signal Level.....	3-28
Calculating Fade Margin.....	3-29
Adaptive modulation.....	3-29
Planning for connectorized units.....	3-30
When to install connectorized units.....	3-30
Choosing external antennas.....	3-30
Calculating RF cable length (5.8 GHz FCC only).....	3-30
Data network planning.....	3-32
Understanding addresses.....	3-32
Dynamic or static addressing.....	3-32
DNS Client.....	3-33
Network Address Translation (NAT).....	3-33
Developing an IP addressing scheme.....	3-34
Address Resolution Protocol.....	3-34
Allocating subnets.....	3-35
Selecting non-routable IP addresses.....	3-35
Translation bridging.....	3-36
Engineering VLANs.....	3-36
Network management planning.....	3-40
Planning for SNMP operation.....	3-40
Enabling SNMP.....	3-40
Security planning.....	3-41
Isolating AP/BHM from the Internet.....	3-41
Encrypting radio transmissions.....	3-41
Planning for HTTPS operation.....	3-42
Planning for SNMPv3 operation.....	3-42
Managing module access by passwords.....	3-43
Planning for RADIUS operation.....	3-44
Filtering protocols and ports.....	3-44
Encrypting downlink broadcasts.....	3-48
Isolating SMs in PMP.....	3-48
Filtering management through Ethernet.....	3-48
Allowing management from only specified IP addresses.....	3-49
Configuring management IP by DHCP.....	3-49
Controlling PPPoE PADI Downlink Forwarding.....	3-50
Remote AP Deployment.....	3-51

Remote AP (RAP) Performance.....	3-52
Example Use Case for RF Obstructions	3-52
Example Use Case for Passing Sync.....	3-53
Physical Connections Involving the Remote AP	3-54
Passing Sync signal	3-56
Wiring to Extend Network Sync.....	3-59
Chapter 4: Legal and regulatory information	4-1
Cambium Networks end user license agreement.....	4-2
Definitions.....	4-2
Acceptance of this agreement	4-2
Grant of license	4-2
Conditions of use	4-3
Title and restrictions	4-4
Confidentiality	4-4
Right to use Cambium’s name.....	4-5
Transfer	4-5
Updates	4-5
Maintenance	4-5
Disclaimer	4-6
Limitation of liability	4-6
U.S. government	4-6
Term of license.....	4-7
Governing law	4-7
Assignment.....	4-7
Survival of provisions	4-7
Entire agreement.....	4-7
Third party software.....	4-7
Compliance with safety standards	4-22
Electrical safety compliance.....	4-22
Electromagnetic compatibility (EMC) compliance	4-22
Human exposure to radio frequency energy.....	4-22
Hazardous location compliance.....	4-31
Compliance with radio regulations	4-33
Type approvals	4-34
Brazil specific information.....	4-35
Australia Notification	4-35
Regulatory Requirements for CEPT Member States (www.cept.org)	4-35
Chapter 5: Preparing for installation	5-1
Safety	5-2
Hazardous locations.....	5-2
Power lines	5-2
Working at heights.....	5-2
Power supply	5-2

Grounding and protective earth	5-3
Powering down before servicing.....	5-3
Primary disconnect device	5-3
External cables	5-3
RF exposure near the antenna	5-3
Minimum separation distances	5-3
Grounding and lightning protection requirements.....	5-4
Grounding cable installation methods.....	5-4
Siting ODU's and antennas	5-4
Thermal Safety	5-4
Preparing for installation.....	5-6
ODU pre-configuration	5-6
Preparing personnel.....	5-6
Preparing inventory	5-6
Preparing tools	5-7
Testing system components	5-8
Unpacking Components	5-8
Preparing the ODU.....	5-8
Configuring Link for Test.....	5-17
Configuring the management PC	5-17
Logging into the web interface – AP/SM/BH	5-18
Using the Quick Start Configuration Wizard of the AP/BHM	5-18
Chapter 6: Installation	6-1
ODU variants and mounting bracket options.....	6-2
Mount the ODU, LPU and surge suppressor	6-3
Attach ground cables to the ODU.....	6-3
Mount the ODU on the mast	6-6
Mount the top LPU	6-10
Mount the Surge Suppressor.....	6-10
General protection installation	6-13
Installing the copper Cat5e Ethernet interface	6-19
Install the main drop cable.....	6-19
Install the bottom LPU to PSU drop cable	6-21
Installing external antennas to a connectorized ODU	6-23
PMP 450i Series.....	6-23
PMP 450 Series.....	6-31
PMP 450i Series AP 900 MHz	6-40
PMP 450 Series SM 900 MHz	6-47
Installing an integrated ODU.....	6-51
PMP 450m Series – AP.....	6-51
PMP/PTP 450i Series – AP/SM/BH.....	6-54
Connecting Cat5e Ethernet cable.....	6-55
Connecting an RJ45 and gland to a unit.....	6-55

Disconnecting an RJ45 and gland from a unit	6-57
Installing ODU	6-58
Installing a 450 Platform Family AP.....	6-58
Installing a 450 Platform Family SM.....	6-59
Installing a 450 Platform Family BHM	6-60
Installing a 450 platform BHS	6-61
Configuring the Link.....	6-62
Monitoring the Link.....	6-62
Installing the AC Power Injector	6-63
Installing the AC Power Injector	6-63
Installing CMM4	6-64
Supplemental installation information	6-65
Stripping drop cable	6-65
Creating a drop cable grounding point.....	6-66
Attaching and weatherproofing an N type connector	6-69
Chapter 7: Configuration.....	7-1
Preparing for configuration.....	7-2
Safety precautions	7-2
Regulatory compliance	7-2
Connecting to the unit	7-3
Configuring the management PC	7-3
Connecting to the PC and powering up	7-4
Using the web interface.....	7-5
Logging into the web interface	7-5
Web GUI.....	7-6
Using the menu options	7-7
Quick link setup	7-12
Initiating Quick Start Wizard	7-12
Configuring time settings.....	7-18
Powering the SM/BHS for test	7-19
Viewing the Session Status of the AP/BHM to determine test registration.....	7-20
Configuring IP and Ethernet interfaces.....	7-23
Configuring the IP interface	7-24
Auxiliary port.....	7-27
NAT, DHCP Server, DHCP Client and DMZ	7-28
DHCP – BHS	7-45
Reconnecting to the management PC.....	7-45
VLAN configuration for PMP	7-45
VLAN configuration for PTP	7-55
PPPoE page of SM.....	7-59
IP4 and IPv6	7-62
Upgrading the software version and using CNUT.....	7-66
Checking the installed software version	7-66

Upgrading to a new software version	7-66
General configuration	7-70
PMP 450m and PMP/PTP 450i Series	7-70
PMP/PTP 450 Series	7-88
Configuring Unit Settings page	7-93
Setting up time and date	7-97
Time page of 450 Platform Family - AP/BHM	7-97
Configuring synchronization	7-99
Configuring security	7-101
Managing module access by password	7-102
Isolating from the internet – APs/BHMs	7-105
Encrypting radio transmissions	7-105
Requiring SM Authentication	7-106
Filtering protocols and ports	7-107
Encrypting downlink broadcasts	7-110
Isolating SMs	7-110
Filtering management through Ethernet	7-111
Allowing management only from specified IP addresses	7-111
Restricting radio Telnet access over the RF interface	7-111
Configuring SNMP Access	7-114
Configuring Security	7-116
Configuring radio parameters	7-128
PMP 450m Series – configuring radio	7-129
PMP/PTP 450i Series – configuring radio	7-134
PMP 450b Series - configuring radio	7-153
PMP/PTP 450 Series – configuring radio	7-157
Custom Frequencies page	7-174
DFS for 5 GHz Radios	7-177
MIMO-A mode of operation	7-179
Improved PPS performance of 450 Platform Family	7-181
Setting up SNMP agent	7-182
Configuring SM/BHS’s IP over-the-air access	7-183
Configuring SNMP	7-185
Configuring syslog	7-191
Syslog event logging	7-192
Configuring system logging	7-192
Configuring remote access	7-197
Accessing SM/BHS over-the-air by Web Proxy	7-197
Monitoring the Link	7-198
Link monitoring procedure	7-198
Exporting Session Status page of AP/BHM	7-200
Configuring quality of service	7-201
Maximum Information Rate (MIR) Parameters	7-201

Token Bucket Algorithm	7-201
MIR Data Entry Checking	7-202
Committed Information Rate (CIR)	7-202
Bandwidth from the SM Perspective.....	7-203
Interaction of Burst Allocation and Sustained Data Rate Settings	7-203
High-priority Bandwidth	7-203
Traffic Scheduling	7-205
Setting the Configuration Source	7-206
Configuring Quality of Service (QoS).....	7-208
Installation Color Code	7-214
Zero Touch Configuration Using DHCP Option 66.....	7-215
Configuration Steps	7-215
Troubleshooting	7-220
Configuring Radio via config file	7-221
Import and Export of config file.....	7-221
Configuring cnMaestro™ Connectivity	7-223
Configuring a RADIUS server	7-229
Understanding RADIUS for PMP 450 Platform Family	7-229
Choosing Authentication Mode and Configuring for Authentication Servers - AP	7-230
SM Authentication Mode – Require RADIUS or Follow AP	7-235
Handling Certificates.....	7-240
Configuring RADIUS servers for SM authentication	7-241
Assigning SM management IP addressing via RADIUS.....	7-243
Configuring RADIUS server for SM configuration.....	7-243
Configuring RADIUS server for SM configuration using Zero Touch feature.....	7-247
Using RADIUS for centralized AP and SM user name and password management.....	7-248
RADIUS Device Data Accounting.....	7-253
RADIUS Device Re-authentication.....	7-257
RADIUS Change of Authorization and Disconnect Message	7-258
Microsoft RADIUS support.....	7-259
Cisco ACS RADIUS Server Support.....	7-263
Configuring VSA.....	7-266
Configuring Ping Watchdog.....	7-270
Chapter 8: Tools	8-1
Using Spectrum Analyzer tool.....	8-2
Mapping RF Neighbor Frequencies.....	8-2
Spectrum Analyzer tool	8-3
Remote Spectrum Analyzer tool.....	8-12
Using the Alignment Tool	8-15
Aiming page and Diagnostic LED – SM/BHS.....	8-16
Alignment Tone.....	8-20
Using the Link Capacity Test tool	8-22
Performing Link Test.....	8-22

Performing Extrapolated Link Test.....	8-27
Link Capacity Test page of AP.....	8-29
Link Capacity Test page of BHM/BHS/SM.....	8-30
Using AP Evaluation tool.....	8-32
AP Evaluation page.....	8-32
Using BHM Evaluation tool.....	8-36
BHM Evaluation page of BHS.....	8-36
Using the OFDM Frame Calculator tool.....	8-40
Using the Subscriber Configuration tool.....	8-45
Using the Link Status tool.....	8-46
Link Status – AP/BHM.....	8-46
Link Status – SM/BHS.....	8-49
Using BER Results tool.....	8-51
Using the Sessions tool.....	8-52
Using the Ping Test tool.....	8-53
Chapter 9: Operation.....	9-1
System information.....	9-2
Viewing General Status.....	9-2
Viewing Session Status.....	9-20
Viewing Remote Subscribers.....	9-29
Interpreting messages in the Event Log.....	9-29
Viewing the Network Interface.....	9-32
Viewing the Layer 2 Neighbors.....	9-33
System statistics.....	9-34
Viewing the Scheduler statistics.....	9-34
Viewing list of Registration Failures statistics.....	9-36
Interpreting Bridging Table statistics.....	9-38
Interpreting Translation Table statistics.....	9-38
Interpreting Ethernet statistics.....	9-39
Interpreting RF Control Block statistics.....	9-42
Interpreting Sounding statistics for AP.....	9-1
Interpreting Sounding statistics for SM.....	9-1
Interpreting VLAN statistics.....	9-2
Interpreting Data VC statistics.....	9-3
Interpreting MIR/Burst statistics.....	9-5
Interpreting Throughput statistics.....	9-7
Interpreting Overload statistics.....	9-11
Interpreting DHCP Relay statistics.....	9-13
Interpreting Filter statistics.....	9-14
Viewing ARP statistics.....	9-15
Viewing NAT statistics.....	9-15
Viewing NAT DHCP Statistics.....	9-17
Interpreting Sync Status statistics.....	9-18

Interpreting PPPoE Statistics for Customer Activities	9-19
Interpreting Bridge Control Block statistics	9-21
Interpreting Pass Through Statistics	9-24
Interpreting SNMPv3 Statistics	9-25
Interpreting syslog statistics	9-27
Interpreting Frame Utilization statistics	9-27
Radio Recovery	9-39
Radio Recovery Console– PMP/PTP 450i/450b and PMP 450m	9-39
Default Mode (or Default/Override Plug) - PMP/PTP 450 Series	9-41
Chapter 10: Reference information	10-1
Equipment specifications	10-2
Specifications for PMP 450m Series - AP	10-2
Specifications for PMP 450i Series - AP	10-6
Specifications for PMP 450i Series - SM	10-12
Specifications for PTP 450i Series - BH	10-17
Specifications for PMP 450b Series - SM	10-21
Specifications for PMP 450 Series - AP	10-26
Specifications for PMP 450 Series - SM	10-31
Specifications for PTP 450 Series - BH	10-36
PSU specifications	10-41
Data network specifications	10-43
Ethernet interface	10-43
Wireless specifications	10-44
General wireless specifications	10-44
Link Range and Throughput	10-45
Country specific radio regulations	10-46
Type approvals	10-46
DFS for 2.4 and 5 GHz Radios	10-48
Equipment Disposal	10-50
Waste (Disposal) of Electronic and Electric Equipment	10-50
Country specific maximum transmit power	10-51
Maximum transmit power 900 MHz band	10-51
Maximum transmit power 2.4 GHz band	10-52
Maximum transmit power 3.5 GHz band	10-53
Maximum transmit power 3.65 GHz band	10-54
Maximum transmit power 4.9 GHz band	10-54
Maximum transmit power 5.1 GHz band	10-56
Maximum transmit power 5.2 GHz band	10-59
Maximum transmit power 5.4 GHz band	10-62
Maximum transmit power 5.8 GHz band	10-67
Country specific frequency range	10-71
Frequency range 900 MHz band	10-71
Frequency range 2.4 GHz band	10-72

Frequency range 3.5 GHz band	10-72
Frequency range 3.65 GHz band	10-73
Frequency range 4.9 GHz band	10-74
Frequency range 5.1 GHz band	10-75
Frequency range 5.2 GHz band	10-78
Frequency range 5.4 GHz band	10-80
Frequency range 5.8 GHz band	10-86
FCC specific information	10-91
FCC compliance testing	10-91
FCC IDs	10-91
FCC approved antenna list	10-97
Innovation Science and Economic Development Canada (ISED) specific information	10-100
900 MHz ISED notification	10-100
4.9 GHz ISED notification	10-100
Utilisation de la bande 4.9 GHz FCC et ISED	10-100
5.2 GHz and 5.4 GHz ISED notification	10-100
Utilisation de la bande 5.2 and 5.4 GHz ISED	10-101
ISED notification 5.8 GHz	10-101
Utilisation de la bande 5.8 GHz ISED	10-101
ISED certification numbers	10-102
Canada approved antenna list	10-102
Chapter 11: Troubleshooting.....	11-1
General troubleshooting procedure	11-2
General planning for troubleshooting.....	11-2
General fault isolation process	11-3
Secondary Steps	11-4
Troubleshooting procedures.....	11-5
Module has lost or does not establish connectivity	11-5
NAT/DHCP-configured SM has lost or does not establish connectivity	11-7
SM Does Not Register to an AP	11-9
Module has lost or does not gain sync	11-10
Module does not establish Ethernet connectivity.....	11-11
CMM4 does not pass proper GPS sync to connected modules.....	11-12
Module Software Cannot be Upgraded	11-13
Module Functions Properly, Except Web Interface Became Inaccessible	11-13
Power-up troubleshooting	11-14
Registration and connectivity troubleshooting	11-15
SM/BMS Registration.....	11-15
Logs	11-16
Persistent Logging	11-16
Appendix A - 450m Reference information	
A.1 Specifications.....	
A.2 450m overload	

Contents

Glossary III

List of Figures

Figure 1 PMP/PTP 450 Platform Family typical bridge deployment.....	1-14
Figure 2 TDD frame division.....	1-17
Figure 3 PMP 450m Series interfaces.....	2-7
Figure 4 PMP/PTP 450i interfaces.....	2-8
Figure 5 PMP 450b Series - SM interfaces.....	2-9
Figure 6 PMP/PTP 450 Series - AP interfaces.....	2-10
Figure 7 PMP/PTP 450 Series – SM/BH interfaces.....	2-11
Figure 8 PMP/PTP 450 Series – SM/BH Connectorized interfaces.....	2-12
Figure 9 PMP 450d Series - SM Integrated Dish.....	2-13
Figure 10 PMP 450 Series – SM 3 GHz Integrated.....	2-13
Figure 11 PTP 450 Series – BHM/BHS.....	2-13
Figure 12 AP/BHM diagnostic LEDs, viewed from unit front.....	2-15
Figure 13 AP/BH diagnostic LEDs, viewed from unit front.....	2-17
Figure 14 AC Power Injector interfaces.....	2-21
Figure 15 AC+DC Enhanced Power Injector interfaces.....	2-22
Figure 16 -48 V DC Power Injector interfaces.....	2-24
Figure 17 -20 to 32 VDC Power Injector interfaces.....	2-25
Figure 18 Gigabit Enet Capable power supply.....	2-27
Figure 19 PMP 450m Series - AP rear interfaces.....	2-29
Figure 20 PMP/PTP 450i Series - ODU rear interfaces.....	2-30
Figure 21 PMP/PTP 450i Series – Connectorized ODU antenna interfaces.....	2-31
Figure 22 PMP 450b Series - ODU rear interfaces.....	2-32
Figure 23 Outdoor drop cable.....	2-34
Figure 24 Optical SFP transceiver module.....	2-36
Figure 25 Long cable gland.....	2-36
Figure 26 Alignment Tone Cable.....	2-38
Figure 27 RJ12 Alignment Tone Cable.....	2-39
Figure 28 Cable gland (part number #N000065L033).....	2-40
Figure 29 Cable grounding kit.....	2-42
Figure 30 UGPS.....	2-45
Figure 31 Cluster Management: Scenario 1.....	2-47
Figure 32 Cluster Management: Scenario 2.....	2-48
Figure 33 Controller Module.....	2-48
Figure 34 Injector Module.....	2-49
Figure 35 CMM4 (Rack Mount).....	2-51
Figure 36 CMM4 56 V power adapter (dongle).....	2-52
Figure 37 CMM4 power adapter cabling diagram.....	2-52
Figure 38 CMM4 (Cabinet with switch).....	2-54
Figure 39 CMM3.....	2-56

Figure 40 Pole mounted CMM3	2-56
Figure 41 GPS antenna mounting	2-58
Figure 42 Mast or tower installation.....	3-2
Figure 43 Wall installation	3-3
Figure 44 Roof installation.....	3-4
Figure 45 GPS receiver wall installation	3-5
Figure 46 GPS receiver tower or mast installation	3-6
Figure 47 Rolling sphere method to determine the lightning protection zones	3-9
Figure 48 Example layout of 16 Access Point sectors (ABCD), 90 degree sectors.....	3-20
Figure 49 Example layout of 6 Access Point sectors (ABC), 60 degree sectors	3-21
Figure 50 Reflection	3-23
Figure 51 Sector Antenna.....	3-24
Figure 52 cnMedusa Antenna	3-25
Figure 53 PMP 450m Series AP antenna beam	3-26
Figure 54 Determinants in Rx signal level	3-28
Figure 55 Cambium networks management domain	3-33
Figure 56 Example of IP address in Class B subnet.....	3-35
Figure 57 Categorical protocol filtering.....	3-46
Figure 58 Remote AP deployment.....	3-51
Figure 59 Example for 900-MHz remote AP behind 5 GHz SM	3-53
Figure 60 Remote AP wired to SM that also serves a customer.....	3-54
Figure 61 Remote AP wired to SM that serves as a relay	3-55
Figure 62 Additional link to extend network sync, Design 3	3-56
Figure 63 Additional link to extend network sync, Design 4.....	3-57
Figure 64 Additional link to extend network sync, Design 5.....	3-58
Figure 65 Co-located AP or BH timing master Sync Setting configuration	3-59
Figure 66 Pin 1 location	5-11
Figure 67 Straight-through Ethernet Cable.....	5-13
Figure 68 AP/BHM to UGPS cable	5-15
Figure 69 Alignment tone cable pin configuration	5-16
Figure 70 RJ-12 pinout for the default plug.....	5-16
Figure 71 PMP 450 900 MHz SM grounding	6-6
Figure 72 Gigabit Ethernet Surge Suppressor	6-11
Figure 73 600SSH Surge Suppressor – inside.....	6-12
Figure 74 Grounding cable minimum bend radius and angle	6-14
Figure 75 Grounding and lightning protection on wall	6-15
Figure 76 Grounding and lightning protection on mast or tower	6-17
Figure 77 Grounding and lightning protection on building	6-18
Figure 78 RJ45 cable	6-20
Figure 79 AP antenna parts	6-25
Figure 80 Antenna top plate.....	6-26
Figure 81 Attaching antenna plate to the AP	6-26
Figure 82 Attaching the plate	6-27

Figure 83 Connect the port A and B to the PMP 450i AP	6-27
Figure 84 AP antenna upper bracket assembly	6-28
Figure 85 AP antenna upper bracket attached to upper adjustment arms	6-28
Figure 86 Rear strap connected to upper AP antenna bracket.....	6-29
Figure 87 Assembled upper bracket connected to AP antenna	6-29
Figure 88 AP Antenna Lower Bracket Assembly	6-29
Figure 89 Lower bracket attached to AP antenna	6-30
Figure 90 Completed AP and antenna assembly	6-30
Figure 91 PMP 450 AP antenna parts	6-31
Figure 92 AP antenna upper bracket assembly	6-32
Figure 93 AP antenna upper bracket attached to upper adjustment arms	6-32
Figure 94 Rear strap connected to upper AP antenna bracket.....	6-33
Figure 95 Assembled upper bracket connected to AP antenna	6-33
Figure 96 AP Antenna Lower Bracket Assembly	6-34
Figure 97 Lower bracket attached to AP antenna	6-34
Figure 98 Attaching bracket to the rear of the AP	6-35
Figure 99 Lower bracket attached to AP antenna	6-35
Figure 100 Mounted PMP 450 AP and antenna assembly, viewed from back and back.....	6-36
Figure 101 Attaching the AP antenna upper bracket to the pole	6-37
Figure 102 Attaching the AP antenna lower bracket to the pole	6-37
Figure 103 Variables for calculating angle of elevation (and depression).....	6-39
Figure 104 PMP 450i AP 900 MHz antenna unbox view	6-40
Figure 105 PMP 450i AP 900 MHz antenna inventory	6-40
Figure 106 Attaching radio mounting PMP 450i AP 900 MHz antenna to the pole.....	6-45
Figure 107 900 MHz sector antenna alignment	6-46
Figure 108 PMP 450i SM 900 MHz external directional antenna	6-47
Figure 109 Attach the antenna to the pole.....	6-47
Figure 110 Fixing the nuts	6-48
Figure 111 Fixing the radio to the antenna	6-49
Figure 112 Connecting RF cable to the radio.....	6-49
Figure 113 Yagi antenna alignment - horizontally	6-50
Figure 114 Yagi antenna alignment - upward tilt.....	6-50
Figure 115 Yagi antenna alignment - downward tilt.....	6-50
Figure 116 PMP 450m Series - AP unbox view.....	6-51
Figure 117 Fixing the mounting plate to the back of the ODU.....	6-54
Figure 118 Attaching the bracket body	6-54
Figure 119 Ethernet cable gland for PMP/PTP 450 Series	6-56
Figure 120 Ethernet cable gland for PMP/PTP 450i Series	6-56
Figure 121 Disarm Installation page (top and bottom of page shown)	7-12
Figure 122 Regional Settings tab of AP/BHM	7-13
Figure 123 Radio Carrier Frequency tab of AP/BHM.....	7-14
Figure 124 Synchronization tab of AP/BHM.....	7-15
Figure 125 LAN IP Address tab of the AP/BHM	7-16

Figure 126 Review and Save Configuration tab of the AP/BHM.....	7-17
Figure 127 Time tab of the AP/BHM	7-18
Figure 128 Time and date entry formats.....	7-19
Figure 129 Session Status tab of AP	7-21
Figure 130 NAT disabled implementation	7-29
Figure 131 NAT with DHCP client and DHCP server implementation	7-30
Figure 132 NAT with DHCP client implementation	7-30
Figure 133 NAT with DHCP server implementation.....	7-31
Figure 134 NAT without DHCP implementation.....	7-31
Figure 135 General page attributes - PMP 450 AP	7-89
Figure 136 General page attributes - PMP 450 SM	7-90
Figure 137 General page attributes - PTP 450 BHM.....	7-91
Figure 138 General page attributes - PTP 450 BHS.....	7-92
Figure 139 Sync Setting configuration.....	7-99
Figure 140 AP Evaluation Configuration parameter of Security tab for PMP.....	7-104
Figure 141 BHM Evaluation Configuration parameter of Security tab for PTP	7-104
Figure 142 RF Telnet Access Restrictions (orange) and Flow through (green)	7-111
Figure 143 RF Telnet Access Restriction (orange) and Potential Security Hole (green).....	7-112
Figure 144 PMP 450i AP Radio attributes - 3 GHz	7-134
Figure 145 PMP 450i SM Radio attributes - 3 GHz	7-140
Figure 146 Multicast VC statistics	7-173
Figure 147 Multicast scheduler statistics	7-173
Figure 148 AP DFS Status.....	7-177
Figure 149 AP Session Status page.....	7-197
Figure 150 AP Remote Subscribers page.....	7-197
Figure 151 Session Status page.....	7-198
Figure 152 Exporting Session Status page of PMP 450m AP	7-200
Figure 153 Uplink and downlink rate caps adjusted to apply aggregate cap.....	7-202
Figure 154 Uplink and downlink rate cap adjustment example.....	7-202
Figure 155 Installation Color Code of AP	7-214
Figure 156 Configuration File upload and download page.....	7-221
Figure 157 Software Upgrade from cnMaestro™	7-224
Figure 158 DNS Test for cnMaestro™ connectivity	7-225
Figure 159 Device Agent Logs	7-226
Figure 160 Example cnMaestro™ screenshot	7-227
Figure 161 SM Certificate Management.....	7-241
Figure 162 User Authentication and Access Tracking tab of the SM	7-252
Figure 163 RADIUS accounting messages configuration.....	7-256
Figure 164 Device re-authentication configuration.....	7-257
Figure 165 RADIUS CoA configuration for AP.....	7-258
Figure 166 EAPPEAP settings.....	7-259
Figure 167 Importing certificate in NPS	7-260
Figure 168 Selecting MD5 from NPS console.....	7-261

Figure 169 User configuration.....	7-261
Figure 170 RADIUS VSA configuration	7-262
Figure 171 Adding RADIUS client.....	7-263
Figure 172 Creating users.....	7-263
Figure 173 Creating RADIUS instance.....	7-264
Figure 174 RADIUS protocols	7-264
Figure 175 Service selection	7-265
Figure 176 Adding Trusted CA.....	7-265
Figure 177 Installing Server Certificate	7-265
Figure 178 Monitoring logs	7-266
Figure 179 VSA list.....	7-267
Figure 180 Spectrum analysis - Results	8-3
Figure 181 Spectrum Analyzer page result – PMP 450 SM	8-11
Figure 182 Alignment Tool tab of SM – Receive Power Level > -70 dBm.....	8-15
Figure 183 Alignment Tool tab of SM – Receive Power Level between -70 to -80 dBm	8-15
Figure 184 Alignment Tool tab of SM – Receive Power Level < -80 dBm.....	8-15
Figure 185 PMP/PTP 450i Series link alignment tone	8-20
Figure 186 Link Capacity Test – PMP 450m Series AP.....	8-23
Figure 187 Link Test with Multiple VCs (1518-byte packet length).....	8-25
Figure 188 Link Capacity Test – PMP 450/450i Series AP	8-25
Figure 189 Link Test without Bridging (1714-byte packet length)	8-26
Figure 190 Extrapolated Link Test results.....	8-28
Figure 191 SM Configuration page of AP	8-45
Figure 192 BER Results tab of the SM.....	8-51
Figure 193 Sessions tab of the AP.....	8-52
Figure 194 Ping Test tab of the AP	8-53
Figure 195 Remote Subscribers page of AP	9-29
Figure 196 Event log data.....	9-30
Figure 197 Network Interface tab of the AP	9-32
Figure 198 Network Interface tab of the SM.....	9-32
Figure 199 Layer 2 Neighbors page.....	9-33
Figure 200 Bridging Table page.....	9-38
Figure 201 Translation Table page of SM.....	9-39
Figure 202 ARP page of the SM	9-15
Figure 203 Recovery Options page.....	9-40
Figure 204 SM Logs	11-16
Figure 205 SM Session log.....	11-16
Figure 206 SM Authentication log.....	11-16
Figure 207 SM Authorization log.....	11-17

List of Tables

Table 1 Main characteristics of the PMP 450m Series AP	1-3
Table 2 PMP 450m Series hardware configurations	1-4
Table 3 Main characteristics of the PMP/PTP 450i Series.....	1-5
Table 4 PMP/PTP 450i Series hardware configurations.....	1-6
Table 5 Main characteristics of the PMP 450b Series	1-8
Table 6 PMP 450b Series hardware configurations	1-9
Table 7 Main characteristics of the PMP/PTP 450 Series.....	1-11
Table 8 PMP/PTP 450 Series hardware configurations.....	1-12
Table 9 Supported Interoperability for PMP	1-13
Table 10 Supported Interoperability for PTP	1-13
Table 11 Modulation levels	1-19
Table 12 PMP 450m Series variants	2-2
Table 13 PMP 450i Series variants.....	2-3
Table 14 PMP 450b Series variants	2-3
Table 15 PMP 450 Series variants.....	2-4
Table 16 PTP 450i Series variants.....	2-5
Table 17 PTP 450 Series variants.....	2-6
Table 18 PMP 450m Series AP interface descriptions and cabling	2-7
Table 19 PMP/PTP 450i Series - AP/SM/BH interface descriptions and cabling	2-9
Table 20 PMP 450b Series - SM interface descriptions and cabling	2-10
Table 21 PMP/PTP 450 Series - AP interface descriptions and cabling – 2.4 GHz and 5 GHz	2-11
Table 22 AP/BHM LED descriptions.....	2-16
Table 23 SM/BHS LED descriptions.....	2-18
Table 24 PSU part numbers for PMP 450m AP	2-19
Table 25 PSU part numbers for PMP/PTP 450i Series	2-20
Table 26 AC Power Injector interface functions	2-21
Table 27 AC+DC Enhanced Power Injector interface functions	2-23
Table 28 -48V DC Power Injector interfaces.....	2-24
Table 29 -Power Injector interfaces	2-25
Table 30 PSU part numbers for PMP 450b SM.....	2-25
Table 31 PSU part numbers for PMP/PTP 450 Series	2-26
Table 32 –Gigabit Enet Capable power supply	2-26
Table 33 Accessories part numbers	2-28
Table 34 Lightning protection part numbers.....	2-28
Table 35 PMP 450m Series – AP rear interfaces.....	2-29
Table 36 PMP/PTP 450i Series – ODU rear interfaces	2-30
Table 37 PMP 450b Series – ODU rear interfaces	2-32
Table 38 PSU drop cable length restrictions	2-33
Table 39 Drop cable part numbers	2-34

Table 40 SFP module kit part numbers	2-35
Table 41 Single Mode Optical SFP Interface per ODU (part number C000065L008)	2-35
Table 42 Multi-mode Optical SFP Interface per ODU (part number C000065L009)	2-35
Table 43 Main port PoE cable pinout	2-37
Table 44 Aux port PoE cable pinout	2-37
Table 45 Aux port PoE cable pinout	2-38
Table 46 RJ12 Aux port PoE cable pinout.....	2-39
Table 47 Alignment tone adapter third party product details.....	2-39
Table 48 RJ45 connector and spare gland part numbers.....	2-40
Table 49 LPU and grounding kit contents.....	2-41
Table 50 LPU and grounding kit part number	2-42
Table 51 Cable grounding kit part numbers	2-42
Table 52 List of AP external antennas	2-43
Table 53 PTP 450i Series BH or PMP 450/450i Series SM external antenna.....	2-43
Table 54 RF cable and connector part numbers.....	2-44
Table 55 CMM5 Cluster Management Scenario 1.....	2-46
Table 56 CMM5 Cluster Management Scenario 2.....	2-47
Table 57 Injector Compatibility Matrix	2-49
Table 58 CMM5 Specifications.....	2-50
Table 59 CMM4 power adapter cable pinout.....	2-53
Table 60 PMP 450m Series ODU part numbers.....	2-60
Table 61 PMP 450i Series ODU part numbers.....	2-60
Table 62 PMP 450i ATEX/HAZLOC ODU models/part numbers.....	2-61
Table 63 PTP 450i Series ODU part numbers	2-62
Table 64 PTP 450i ATEX/HAZLOC ODU models/part numbers.....	2-63
Table 65 PMP 450b Series ODU part numbers.....	2-63
Table 66 PMP 450 Series ODU part numbers	2-64
Table 67 PTP 450 Series ODU part numbers	2-66
Table 68 PMP/PTP 450/450i Series Accessories	2-66
Table 69 PMP 450m Series wind loading (Newton).....	3-12
Table 70 PMP/PTP 450i Series wind loading (Newton)	3-12
Table 71 PMP 450m Series wind loading (lb force)	3-12
Table 72 PMP/PTP 450i Series wind loading (lb force)	3-13
Table 73 PMP/PTP 450 Series wind loading (Newton)	3-13
Table 74 PMP/PTP 450 Series wind loading (lb force)	3-14
Table 75 EIRP limits from ATEX and HAZLOC standards.....	3-15
Table 76 Example 5.8 GHz 4-channel assignment by access site.....	3-20
Table 77 Example 5.8 GHz 3-channel assignment by access site.....	3-21
Table 78 RF cable lengths required to achieve 1.2 dB loss at 5.8 GHz.....	3-31
Table 79 Special case VLAN IDs	3-37
Table 80 VLAN filters in point-to-multipoint modules.....	3-38
Table 81 Q-in-Q Ethernet frame	3-39
Table 82 HTTPS security material.....	3-42

Table 83 Ports filtered per protocol selections	3-47
Table 84 Device default port numbers	3-47
Table 85 Safety compliance specifications	4-22
Table 86 EMC emissions compliance	4-22
Table 87 FCC minimum safe distances – PMP 450m 5.1 GHz, 5.2 GHz, 5.4 GHz and 5.8 GHz	4-25
Table 88 FCC minimum safe distances – PMP/PTP 450i 900 MHz, 3.65 GHz, 4.9 GHz, 5.1 GHz, 5.2 GHz, 5.4 GHz and 5.8 GHz	4-26
Table 89 ISEDC minimum safe distances – PMP/PTP 450i, 900 MHz, 3.5 GHz, 3.65 GHz, 4.9 GHz, 5.2 GHz, 5.4 GHz, and 5.8 GHz	4-26
Table 90 FCC minimum safe distances – PMP/PTP 450 900 MHz, 2.4 GHz, 3.65 GHz and 5 GHz ...	4-28
Table 91 ISEDC minimum safe distances – PMP/PTP 450 900 MHz, 2.4 GHz, 3.5/3.65 GHz and 5 GHz	4-29
Table 92 Radio certifications	4-34
Table 93 Tools for PMP and PTP 450 Platform ODU installation	5-9
Table 94 Main port pinout	5-12
Table 95 Aux port pinout	5-12
Table 96 RJ-45 pinout for straight-through Ethernet cable	5-13
Table 97 RJ-45 pinout for crossover Ethernet cable	5-14
Table 98 AP/BHM to UGPS cable pinout	5-15
Table 99 PMP/PTP 450i Series - ODU mounting bracket part numbers	6-2
Table 100 RJ45 connector and cable color code	6-20
Table 101 Menu options and web pages	7-7
Table 102 Session Status Attributes – AP	7-22
Table 103 IP interface attributes	7-25
Table 104 SM/BHS private IP and LUID	7-26
Table 105 Aux port attributes	7-27
Table 106 IP attributes - SM with NAT disabled	7-33
Table 107 IP attributes - SM with NAT enabled	7-35
Table 108 NAT attributes - SM with NAT disabled	7-36
Table 109 NAT attributes - SM with NAT enabled	7-39
Table 110 SM DNS Options with NAT Enabled	7-44
Table 111 NAT Port Mapping attributes - SM	7-44
Table 112 VLAN Remarking Example	7-46
Table 113 AP/BHM VLAN tab attributes	7-48
Table 114 Q-in-Q Ethernet frame	7-49
Table 115 SM VLAN attributes	7-51
Table 116 SM VLAN Membership attributes	7-55
Table 117 BHM VLAN page attributs	7-55
Table 118 BHS VLAN page attributes	7-58
Table 119 SM PPPoE attributes	7-60
Table 120 DiffServ attributes – AP/BHM	7-62
Table 121 Packet Filter Configuration attributes	7-64
Table 122 General page attributes – PMP 450i AP	7-70
Table 123 General page attributes –PMP 450m AP	7-75

Table 124 General page attributes – PMP 450i SM	7-77
Table 125 General page attributes – PTP 450i BHM.....	7-80
Table 126 General page attributes – PTP 450i BHS.....	7-82
Table 127 General page attributes – PMP 450b SM.....	7-85
Table 128 Unit Settings attributes – 450 Platform Family AP/BHM.....	7-94
Table 129 SM Unit Settings attributes	7-96
Table 130 450 Platform Family - AP/BHM Time attributes	7-97
Table 131 Add User page of account page - AP/ SM/BH.....	7-102
Table 132 Delete User page - 450 Platform Family - AP/ SM/BH.....	7-103
Table 133 Change User Setting page - 450 Platform Family AP/ SM/BH.....	7-103
Table 134 User page –450 Platform Family AP/SM/BH.....	7-104
Table 135 AP/BHM Protocol Filtering attributes.....	7-107
Table 136 SM/BHS Protocol Filtering attributes.....	7-109
Table 137 Port Configuration attributes – AP/SM/BHM/BMS.....	7-110
Table 138 Security attributes –450 Platform Family AP.....	7-116
Table 139 Security attributes –450 Platform Family SM.....	7-121
Table 140 Security attributes - 450 Platform Family BHS.....	7-126
Table 141 PMP 450m AP Radio attributes - 5 GHz	7-129
Table 142 PMP 450i AP Radio attributes - 5 GHz.....	7-135
Table 143 PMP 450i SM Radio attributes – 5 GHz.....	7-141
Table 144 PMP 450i AP Radio attributes - 900 MHz	7-145
Table 145 PTP 450i BHM Radio page attributes – 5 GHz.....	7-147
Table 146 PTP 450i BHS Radio attributes – 5 GHz.....	7-150
Table 147 PMP 450b SM Radio attributes – 5 GHz.....	7-153
Table 148 PMP 450 AP Radio attributes - 5 GHz.....	7-157
Table 149 PMP 450 AP Radio attributes - 3.65 GHz.....	7-159
Table 150 PMP 450 AP Radio attributes - 3.5 GHz.....	7-160
Table 151 PMP 450 AP Radio attributes - 2.4 GHz.....	7-161
Table 152 PMP 450 SM Radio attributes – 5 GHz.....	7-162
Table 153 PMP 450 SM Radio attributes – 3.65 GHz.....	7-164
Table 154 PMP 450 SM Radio attributes – 3.5 GHz.....	7-165
Table 155 PMP 450 SM Radio attributes – 2.4 GHz.....	7-166
Table 156 PMP 450 SM Radio attributes –900 MHz	7-167
Table 157 PTP 450 BHM Radio attributes –5 GHz.....	7-169
Table 158 PTP 450 BHM Radio attributes –5 GHz.....	7-170
Table 159 Example for mix of multicast and unicast traffic scenarios.....	7-172
Table 160 450 Platform Family AP/SM/BH Custom Frequencies page – 5 GHz.....	7-174
Table 161 PMP/PTP 450 SM/BH Custom Frequencies page – 3.65 GHz.....	7-175
Table 162 PMP/PTP 450 SM/BH Custom Frequencies page – 3.5 GHz.....	7-176
Table 163 Contention slots and number of SMs.....	7-178
Table 164 450 Platform Family Modulation levels	7-179
Table 165 Co-channel Interference per (CCI) MCS.....	7-180
Table 166 Adjacent Channel Interference (ACI) per MCS.....	7-180

Table 167 LAN1 Network Interface Configuration tab of IP page attributes.....	7-183
Table 168 SNMP page attributes	7-185
Table 169 Syslog parameters.....	7-192
Table 170 Syslog Configuration attributes - AP	7-193
Table 171 Syslog Configuration attributes - SM	7-194
Table 172 Syslog Configuration attributes - BHS.....	7-195
Table 173 Characteristics of traffic scheduling.....	7-205
Table 174 Recommended combined settings for typical operations.....	7-206
Table 175 Where feature values are obtained for a SM with authentication required.....	7-207
Table 176 MIR, VLAN, HPC, and CIR Configuration Sources, Authentication Disabled	7-207
Table 177 QoS page attributes - AP.....	7-208
Table 178 QoS page attributes - SM.....	7-210
Table 179 QoS page attributes - BHM	7-212
Table 180 QoS page attributes - BHS	7-213
Table 181 Configuring cnMaestro	7-223
Table 182 Security tab attributes	7-231
Table 183 SM Security tab attributes	7-235
Table 184 RADIUS Vendor Specific Attributes (VSAs)	7-244
Table 185 AP User Authentication and Access Tracking attributes.....	7-250
Table 186 SM User Authentication and Access Tracking attributes.....	7-252
Table 187 Device data accounting RADIUS attributes.....	7-253
Table 188 Ping Watchdog attributes	7-270
Table 189 Spectrum Analyzer page attributes - AP	8-5
Table 190 Spectrum Analyzer page attributes - SM	8-7
Table 191 Spectrum Analyzer page attributes - BHM.....	8-8
Table 192 Spectrum Analyzer page attributes - BHS.....	8-9
Table 193 Remote Spectrum Analyzer attributes - AP.....	8-13
Table 194 Remote Spectrum Analyzer attributes - BHM.....	8-14
Table 195 Aiming page attributes – SM.....	8-17
Table 196 Aiming page attributes - BHS.....	8-19
Table 197 Alignment Tool Headsets and Alignment tone adapter third party product details.....	8-21
Table 198 Link Capacity Test page attributes – AP	8-29
Table 199 Link Capacity Test page attributes – BHM/BHS	8-31
Table 200 AP Evaluation tab attributes - AP.....	8-32
Table 201 BHM Evaluation tab attributes - BHS.....	8-36
Table 202 OFDM Frame Calculator page attributes	8-41
Table 203 OFDM Calculated Frame Results attributes	8-42
Table 204 Color code versus uplink/downlink rate column	8-46
Table 205 Link Status page attributes – AP/BHM	8-47
Table 206 Link Status page attributes – SM/BHS	8-49
Table 207 General Status page attributes – PMP 450m AP.....	9-3
Table 208 General Status page attributes – PMP 450/450i AP	9-8
Table 209 General Status page attributes - SM.....	9-11

Table 210 General Status page attributes - BHM	9-15
Table 211 General Status page attributes - BHS	9-18
Table 212 Device tab attributes.....	9-20
Table 213 Session tab attributes.....	9-21
Table 214 Power tab attributes	9-23
Table 215 Configuration tab attributes.....	9-25
Table 216 Session Status > Configuration CIR configuration denotations.....	9-27
Table 217 Link Quality tab attributes.....	9-28
Table 218 Event Log messages for abnormal events	9-31
Table 219 Event Log messages for normal events	9-31
Table 220 Scheduler tab attributes.....	9-34
Table 221 SM Registration Failures page attributes - AP	9-36
Table 222 BHS Registration Failures page attributes - BHM.....	9-37
Table 223 Flags status.....	9-37
Table 224 Ethernet tab attributes.....	9-39
Table 225 Radio (Statistics) page attributes – RF Control Block	9-42
Table 226 Radio (Statistics - AP) page attributes - Sounding	9-1
Table 227 Radio (Statistics - SM) page attributes - Sounding	9-1
Table 228 VLAN page attributes	9-2
Table 229 Data VC page attributes	9-3
Table 230 MIR/Burst page attributes for AP.....	9-5
Table 231 MIR/Burst page attributes for SM.....	9-6
Table 232 RF overload Configuration attributes – AP/BHM	9-8
Table 233 Overload page attributes – AP/SM/BHM/BHS	9-11
Table 234 DHCP Relay page attributes – AP/SM	9-13
Table 235 Filter page attributes - SM	9-14
Table 236 NAT page attributes - SM	9-16
Table 237 NAT DHCP Statistics page attributes - SM	9-17
Table 238 Sync Status page attributes - AP.....	9-18
Table 239 PPPoE Statistics page attributes - SM	9-19
Table 240 Bridge Control Block page attributes – AP/SM/BHM/BHS	9-21
Table 241 Pass Through Statistics page attributes – AP	9-24
Table 242 SNMPv3 Statistics page attributes – AP	9-25
Table 243 Syslog statistics page attributes – AP/SM/BH.....	9-27
Table 244 Frame utilization statistics for PMP 450m AP	9-28
Table 245 Frame utilization statistics for 450/450i/450m	9-36
Table 246 Recovery Options attributes	9-40
Table 247 PMP 450m Series - AP specifications	10-2
Table 248 PMP 450i Series - AP specifications.....	10-6
Table 249 PMP 450i Series - SM specifications.....	10-12
Table 250 PTP 450i Series - BH specifications.....	10-17
Table 251 PMP 450b Series - SM specifications.....	10-21
Table 252 PMP 450 Series - AP specifications.....	10-26

Table 253 PMP 450 Series - SM specifications	10-31
Table 254 PTP 450 Series - BH specifications	10-36
Table 255 PMP/PTP 450i AC power Injector specifications	10-41
Table 256 PMP/PTP 450 power supply specifications (part number: N000900L001A)	10-42
Table 257 450m/450i Series Main and Aux Ethernet bridging specifications	10-43
Table 258 450 Series Ethernet bridging specifications	10-43
Table 259 450 Platform Family - wireless specifications	10-44
Table 260 Radio certifications	10-46
Table 261 Country & Bands DFS setting	10-48
Table 262 Default combined transmit power per country – 900 MHz band PMP 450i Series.....	10-51
Table 263 Default combined transmit power per country – 2.4 GHz band PMP/PTP 450 Series..	10-52
Table 264 Default combined transmit power per country – 3.5 GHz band PMP/PTP 450 Series..	10-53
Table 265 Default combined transmit power per country – 3.65 GHz band PMP/PTP 450	10-54
Table 266 Default combined transmit power per country – 4.9 GHz band PMP/PTP 450i Series.	10-54
Table 267 Default combined transmit power per country – 4.9 GHz band PMP 450b Series	10-55
Table 268 Default combined transmit power per Country – 5.1 GHz band PMP/PTP 450i Series	10-56
Table 269 Default combined transmit power per country – 5.1 GHz band PMP 450b Series	10-57
Table 270 Default combined transmit power per Country – 5.1 GHz band PMP 450m Series	10-58
Table 271 Default combined transmit power per country – 5.2 GHz band PMP/PTP 450i Series.	10-59
Table 272 Default combined transmit power per country – 5.2 GHz band PMP 450b Series	10-60
Table 273 Default combined transmit power per Country – 5.2 GHz band PMP 450m Series	10-61
Table 274 Default combined transmit power per country – 5.4 GHz band PMP 450m Series	10-62
Table 275 Default combined transmit power per country – 5.4 GHz band PMP/PTP 450i Series.	10-63
Table 276 Default combined transmit power per country – 5.4 GHz band PMP 450b Series	10-65
Table 277 Default combined transmit power per country – 5.4 GHz band PMP 450 Series	10-66
Table 278 Default combined transmit power per Country – 5.8 GHz band PMP 450m Series	10-67
Table 279 Default combined transmit power per country – 5.8 GHz band PMP/PTP 450i Series.	10-68
Table 280 Default combined transmit power per country – 5.8 GHz band PMP 450b Series	10-68
Table 281 Default combined transmit power per country – 5.8 GHz band PMP 450 Series	10-69
Table 282 Frequency range per country – 900 MHz band	10-71
Table 283 Frequency range per country – 2.4 GHz band PMP/PTP 450 Series.....	10-72
Table 284 Frequency range per country – 3.5 GHz band PMP/PTP 450/450i Series.....	10-72
Table 285 Frequency range per country – 3.65 GHz band PMP/PTP 450/450i Series.....	10-73
Table 286 Frequency range per country – 4.9 GHz band PMP/PTP 450i/450b Series	10-74
Table 287 Frequency range per country – 4.9 GHz band PMP 450b Series	10-74
Table 288 Frequency range per country – 5.1 GHz band PMP/PTP 450i Series.....	10-75
Table 289 Frequency range per country – 5.1 GHz band PMP 450b Series	10-76
Table 290 Frequency range per country – 5.1 GHz band PMP 450m Series.....	10-77
Table 291 Frequency range per country – 5.2 GHz band PMP/PTP 450i Series.....	10-78
Table 292 Frequency range per country – 5.2 GHz band PMP 450b Series	10-79
Table 293 Frequency range per country – 5.2 GHz band PMP 450m Series.....	10-79
Table 294 Frequency range per country – 5.4 GHz band PMP/PTP 450i Series.....	10-80
Table 295 Frequency range per country – 5.4 GHz band PMP 450b Series	10-81

Table 296 Frequency range per country – 5.4 GHz band PMP/PTP 450 Series.....	10-82
Table 297 Frequency range per country – 5.4 GHz band PMP 450m Series.....	10-85
Table 298 Frequency range per country – 5.8 GHz band PMP/PTP 450i Series.....	10-86
Table 299 Frequency range per country – 5.8 GHz band PMP 450b Series.....	10-87
Table 300 Frequency range per country – 5.8 GHz band PMP/PTP 450 Series.....	10-87
Table 301 Frequency range per country – 5.8 GHz band PMP 450m Series.....	10-90
Table 302 US FCC IDs	10-91
Table 303 USA approved antenna list 4.9 GHz.....	10-97
Table 304 USA approved antenna list 5.1 and 5.2 GHz	10-98
Table 305 USA approved antenna list 5.4 GHz.....	10-99
Table 306 USA approved antenna list 5.8 GHz.....	10-99
Table 307 ISED Certification Numbers.....	10-102
Table 308 Canada approved antenna list 4.9 and 5.8 GHz	10-103
Table 309 Canada approved antenna list 5.2 and 5.4 GHz	10-104

About This User Guide

This guide describes the planning, installation, configuration and operation of the Cambium point-to-point and point-to-multipoint wireless Ethernet bridges. It covers PMP/PTP 450, 450i, 450b, 450d and PMP 450m platform Series. It is intended for use by the system designer, system installer and system administrator.

For radio network design, refer to the following chapters:

- [Chapter 1: Product description](#)
- [Chapter 2: System hardware](#)
- [Chapter 3: System planning](#)
- [Chapter 4: Legal and regulatory information](#)
- [Chapter 5: Preparing for installation](#)
- [Chapter 6: Installation](#)

For system configuration, tools and troubleshooting, refer to the following chapters:

- [Chapter 7: Configuration](#)
- [Chapter 8: Tools](#)
- [Chapter 9: Operation](#)
- [Chapter 10: Reference information](#)
- [Chapter 11: Troubleshooting](#)

Contacting Cambium Networks

Support website:	https://support.cambiumnetworks.com
Main website:	http://www.cambiumnetworks.com
Sales enquiries:	solutions@cambiumnetworks.com
Support enquiries:	https://support.cambiumnetworks.com
Repair enquiries:	https://support.cambiumnetworks.com
Telephone number list:	http://www.cambiumnetworks.com/contact
Address:	Cambium Networks Limited, Global Headquarters, 3800 Golf Road, Suite 360, Rolling Meadows, IL 60008 USA

Purpose

Cambium Networks Point-to-Multi-Point (PMP)/Point-To-Point (PTP) 450 documents are intended to instruct and assist personnel in the operation, installation and maintenance of the Cambium PMP/PTP equipment and ancillary devices of 450 Platform Family. It is recommended that all personnel engaged in such activities be properly trained.

Cambium disclaims all liability whatsoever, implied or express, for any risk of damage, loss or reduction in system performance arising directly or indirectly out of the failure of the customer, or anyone acting on the customer's behalf, to abide by the instructions, system parameters, or recommendations made in this document.

Product notation conventions in document

This document covers Cambium 450 Series, 450i Series and 450m Series products. The following notation conventions are followed while referring to product series and product family:

Product notation	Description
<ul style="list-style-type: none">450 Platform Family	Refers to the complete 450 Series family, which includes 450 Series, 450i Series, 450b Series and 450m Series
<ul style="list-style-type: none">450 Series	Refers to 450 Series devices in the following configurations: <ul style="list-style-type: none">- PMP 450<ul style="list-style-type: none">- AP [2.4GHz/3.5 GHz/3.65 GHz /5 GHz]<ul style="list-style-type: none">- Connectorized- SM [900 MHz/2.4GHz/3.5 GHz/3.65 GHz /5 GHz]<ul style="list-style-type: none">- Connectorized/ Integrated- PTP 450 BHM/ BHS [900 MHz/3.5 GHz/3.65 GHz/5 GHz]<ul style="list-style-type: none">- Connectorized/ Integrated- PMP 450d SM [5 GHz]
<ul style="list-style-type: none">450i Series	Refers to 450i Series devices in the following configurations: <ul style="list-style-type: none">- PMP 450i<ul style="list-style-type: none">- AP [900 MHz/3 GHz/5 GHz]<ul style="list-style-type: none">- Connectorized/ Integrated- SM [3 GHz/5 GHz]<ul style="list-style-type: none">- Connectorized/ Integrated- PTP 450i BHM/ BHS [3 GHz/5 GHz]<ul style="list-style-type: none">- Connectorized/ Integrated
<ul style="list-style-type: none">450b Series	Refers to 450b Series devices in the following configurations: <ul style="list-style-type: none">- PMP 450b<ul style="list-style-type: none">- SM [5 GHz]<ul style="list-style-type: none">- Integrated

Product notation	Description
<ul style="list-style-type: none">450m Series	Refers to 450m Series device configuration: <ul style="list-style-type: none">- PMP 450m AP 5 GHz- Integrated

Cross references

References to external publications are shown in italics. Other cross references, emphasized in blue text in electronic versions, are active links to the references.

This document is divided into numbered chapters that are divided into sections. Sections are not numbered, but are individually named at the top of each page, and are listed in the table of contents.

Feedback

We appreciate feedback from the users of our documents. This includes feedback on the structure, content, accuracy, or completeness of our documents. To provide feedback, visit our support website. <https://support.cambiumnetworks.com>.

Important regulatory information

The 450 Platform Family products are certified as an unlicensed device in frequency bands where it is not allowed to cause interference to licensed services (called primary users of the bands).

Application software

Download the latest 450 Platform Family software and install it in the Outdoor Units (ODUs) before deploying the equipment. Instructions for installing software are provided in [Upgrading the software version and using CNUT](#) on page 7-66.

USA specific information



Caution

This device complies with Part 15 of the FCC Rules. Operation is subject to the following two conditions:

- This device may not cause harmful interference, and
 - This device must accept any interference received, including interference that may cause undesired operation
-

The USA Federal Communications Commission (FCC) requires manufacturers to implement special features to prevent interference to weather radar systems that operate in the band 5600 MHz to 5650 MHz. These features must be implemented in all products able to operate outdoors in the band 5470 MHz to 5725 MHz.

Manufacturers must ensure that such radio products cannot be configured to operate outside of FCC rules; specifically it must not be possible to disable or modify the radar protection functions that have been demonstrated to the FCC.

Cambium supplies variants of the 450i and 450m Series specifically for operation in the USA in order to comply with FCC requirements (KDB 905462 D02 UNII DFS Compliance Procedures New Rules v01r02). These variants are only allowed to operate with license keys that comply with FCC rules.

Similarly, Cambium supplies variants of the 450 Series specifically for operation in the USA in order to comply with FCC requirements (KDB 443999 D01 Approval of DFS UNII Devices v01r04). These variants are only allowed to operate with license keys that comply with FCC rules. To ensure compliance when using PMP 450 Series and PTP 450 Series, follow the recommendation in [Avoidance of weather radars \(USA only\)](#).

External antennas

When using a connectorized version of the product, the conducted transmit power may need to be reduced to ensure the regulatory limit on transmitter EIRP is not exceeded. The installer must have an understanding of how to compute the effective antenna gain from the actual antenna gain and the feeder cable losses.

The range of permissible values for maximum antenna gain and feeder cable losses are included in this user guide together with a sample calculation. The product GUI automatically applies the correct conducted power limit to ensure that it is not possible for the installation to exceed the EIRP limit, when the appropriate values for antenna gain and feeder cable losses are entered into the GUI.

Avoidance of weather radars (USA only)

To comply with FCC rules (KDB 443999: Interim Plans to Approve UNII Devices Operating in the 5470 - 5725 MHz Band with Radar Detection and DFS Capabilities), units which are installed within 35 km (22 miles) of a Terminal Doppler Weather Radar (TDWR) system (or have a line of sight propagation path to such a system) must be configured to avoid any frequency within +30 MHz or -30 MHz of the frequency of the TDWR device. This requirement applies even if the master is outside the 35 km (22 miles) radius but communicates with outdoor clients which may be within the 35 km (22 miles) radius of the TDWRs. If interference is not eliminated, a distance limitation based on line-of-sight from TDWR will need to be used. Devices with bandwidths greater than 20 MHz may require greater frequency separation.

When planning a link in the USA, visit <http://spectrumbridge.com/udia/home.aspx>, enter the location of the planned link and search for TDWR radars. If a TDWR system is located within 35 km (22 miles) or has line of sight propagation to the PTP device, perform the following tasks:

- Register the installation on <http://spectrumbridge.com/udia/home.aspx>.
- Make a list of channel center frequencies that must be barred, that is, those falling within +30 MHz or -30 MHz of the frequency of the TDWR radars.

The 450 Platform Family AP must be configured to not operate on the affected channels.

Canada specific information



Caution

This device complies with ISED's license-exempt RSSs. Operation is subject to the following two conditions:

- (1) This device may not cause interference; and
 - (2) This device must accept any interference, including interference that may cause undesired operation of the device.
-

ISED requires manufacturers to implement special features to prevent interference to weather radar systems that operate in the band 5600 MHz to 5650 MHz. These features must be implemented in all products able to operate outdoors in the band 5470 MHz to 5725 MHz.

Manufacturers must ensure that such radio products cannot be configured to operate outside of ISEDC rules; specifically it must not be possible to disable or modify the radar protection functions that have been demonstrated to ISEDC .

In order to comply with these ISEDC requirements, Cambium supplies variants of the 450 Platform Family for operation in Canada. These variants are only allowed to operate with license keys that comply with ISEDC rules. In particular, operation of radio channels overlapping the band 5600 MHz to 5650 MHz is not allowed and these channels are permanently barred.

In addition, other channels may also need to be barred when operating close to weather radar installations.

Other variants of the 450 Platform Family are available for use in the rest of the world, but these variants are not supplied to Canada except under strict controls, when they are needed for export and deployment outside Canada.

Renseignements spécifiques au Canada



Attention

Le présent appareil est conforme aux CNR d'Industrie Canada applicables aux appareils radio exempts de licence. L'exploitation est autorisée aux deux conditions suivantes :

- (1) l'appareil ne doit pas produire de brouillage, et
 - (2) l'utilisateur de l'appareil doit accepter tout brouillage radioélectrique subi, même si le brouillage est susceptible d'en compromettre le fonctionnement.
-

ISEDC a demandé aux fabricants de mettre en œuvre des mécanismes spécifiques pour éviter d'interférer avec des systèmes radar fonctionnant dans la bande 5600 MHz à 5650 MHz. Ces mécanismes doivent être mis en œuvre dans tous les produits capables de fonctionner à l'extérieur dans la bande 5470 MHz à 5725 MHz.

Les fabricants doivent s'assurer que les produits de radiocommunications ne peuvent pas être configurés pour fonctionner en dehors des règles ISEDC , en particulier, il ne doit pas être possible de désactiver ou modifier les fonctions de protection des radars qui ont été démontrés à ISEDC .

Afin de se conformer à ces exigences de ISEDC , Cambium fournit des variantes du 450 Platform Family exclusivement pour le Canada. Ces variantes ne permettent pas à l'équipement de fonctionner en dehors des règles de ISEDC . En particulier, le fonctionnement des canaux de radio qui chevauchent la bande 5600-5650 MHz est interdite et ces canaux sont définitivement exclus.

ISEDC Approved Antennas

The list of antennas used to obtain ISEDC approvals is provided in section [Country specific radio regulations, Innovation Science and Economic Development Canada \(ISEDC\) , Table 308.](#)

Antennas externes

Lorsque vous utilisez une version du produit sans antenne intégrée, il peut être nécessaire de réduire la puissance d'émission pour garantir que la limite réglementaire de puissance isotrope rayonnée équivalente (PIRE) n'est pas dépassée. L'installateur doit avoir une bonne compréhension de la façon de calculer le gain de l'antenne réelle et les pertes dans les câbles de connections.

La plage de valeurs admissibles pour un gain maximal de l'antenne et des pertes de câbles de connections sont inclus dans ce guide d'utilisation avec un exemple de calcul. L'interface utilisateur du produit applique automatiquement la limite de puissance menée correct afin de s'assurer qu'il ne soit pas possible pour l'installation de dépasser la limite PIRE, lorsque les valeurs appropriées pour le gain d'antenne et les pertes de câbles d'alimentation sont entrées dans l'interface utilisateur.

Antennes approuvées par ISEDC

La liste des antennes approuvées pour l'opération au Canada est fournie dans le chapitre [Country specific radio regulations, Innovation Science and Economic Development Canada \(ISEDC\)](#) tableaux [Table 308](#).

EU Declaration of Conformity

Hereby, Cambium Networks declares that the Cambium 450 Series, 450i Series and 450m Series Wireless Ethernet Bridge complies with the essential requirements and other relevant provisions of Directive 1999/5/EC. The declaration of conformity may be consulted at:

<http://www.cambiumnetworks.com/support/ec-doc>

Specific expertise and training for professional installers

To ensure that the 450 Platform Family products – PMP/PTP 450 Series, PMP/PTP 450i Series, PMP 450m Series are installed and configured in compliance with the requirements of ISEDC and the FCC, installers must have the radio engineering skills and training described in this section.

The Cambium Networks technical training program details can be accessed from below link:

<http://www.cambiumnetworks.com/training/category/technical-training/>

Ethernet networking skills

The installer must have the ability to configure IP addressing on a PC and to set up and control products using a web browser interface.

Lightning protection

To protect outdoor radio installations from the impact of lightning strikes, the installer must be familiar with the normal procedures for site selection, bonding and grounding. Installation guidelines for the 450 Platform Family can be found in [Chapter 2: System hardware](#) and [Chapter 3: System planning](#).

Training

The installer needs to have basic competence in radio and IP network installation. The specific requirements applicable to the 450 Platform should be gained by reading [Chapter 5: Preparing for installation](#), [Chapter 6: Installation](#), [Chapter 7: Configuration](#), [Chapter 8: Tools](#) and [Chapter 9: Operation](#); and by performing sample set ups at base workshop before live deployments.

The Cambium Networks technical training program details can be accessed from below link:
<http://www.cambiumnetworks.com/training/category/technical-training/>

Problems and warranty

Reporting problems

If any problems are encountered when installing or operating this equipment, follow this procedure to investigate and report:

- 1 Search this document and the software release notes of supported releases.
- 2 Visit the support website.
- 3 Ask for assistance from the Cambium product supplier.
- 4 Gather information from affected units, such as any available diagnostic downloads.
- 5 Escalate the problem by emailing or telephoning support.

Repair and service

If unit failure is suspected, obtain details of the Return Material Authorization (RMA) process from the support website (<http://www.cambiumnetworks.com/support>).

Hardware warranty

Cambium's standard hardware warranty is for one (1) year from date of shipment from Cambium Networks or a Cambium distributor. Cambium Networks warrants that hardware will conform to the relevant published specifications and will be free from material defects in material and workmanship under normal use and service. Cambium shall within this time, at its own option, either repair or replace the defective product within thirty (30) days of receipt of the defective product. Repaired or replaced product will be subject to the original warranty period but not less than thirty (30) days.

To register PMP and PTP products or activate warranties, visit the support website. For warranty assistance, contact the reseller or distributor. The removal of the tamper-evident seal will void the warranty.



Caution

Using non-Cambium parts for repair could damage the equipment or void warranty. Contact Cambium for service and repair instructions.

Portions of Cambium equipment may be damaged from exposure to electrostatic discharge. Use precautions to prevent damage.

Security advice

Cambium Networks systems and equipment provide security parameters that can be configured by the operator based on their particular operating environment. Cambium recommends setting and using these parameters following industry recognized security practices. Security aspects to be considered are protecting the confidentiality, integrity, and availability of information and assets. Assets include the ability to communicate, information about the nature of the communications, and information about the parties involved.

In certain instances Cambium makes specific recommendations regarding security practices, however the implementation of these recommendations and final responsibility for the security of the system lies with the operator of the system.

Warnings, cautions, and notes

The following describes how warnings and cautions are used in this document and in all documents of the Cambium Networks document set.

Warnings

Warnings precede instructions that contain potentially hazardous situations. Warnings are used to alert the reader to possible hazards that could cause loss of life or physical injury. A warning has the following format:



Warning

Warning text and consequence for not following the instructions in the warning.

Cautions

Cautions precede instructions and are used when there is a possibility of damage to systems, software, or individual items of equipment within a system. However, this damage presents no danger to personnel. A caution has the following format:



Caution

Caution text and consequence for not following the instructions in the caution.

Notes

A note means that there is a possibility of an undesirable situation or provides additional information to help the reader understand a topic or concept. A note has the following format:



Note

Note text.

Caring for the environment

The following information describes national or regional requirements for the disposal of Cambium Networks supplied equipment and for the approved disposal of surplus packaging.

In EU countries

The following information is provided to enable regulatory compliance with the European Union (EU) directives identified and any amendments made to these directives when using Cambium equipment in EU countries.



Disposal of Cambium equipment

European Union (EU) Directive 2002/96/EC Waste Electrical and Electronic Equipment (WEEE)

Do not dispose of Cambium equipment in landfill sites. For disposal instructions, refer to <http://www.cambiumnetworks.com/support/weee-compliance>

Disposal of surplus packaging

Do not dispose of surplus packaging in landfill sites. In the EU, it is the individual recipient's responsibility to ensure that packaging materials are collected and recycled according to the requirements of EU environmental law.

In non-EU countries

In non-EU countries, dispose of Cambium equipment and all surplus packaging in accordance with national and regional regulations.

Chapter 1: Product description

This chapter provides a high level description of 450 Platform Family products. It describes in general terms the function of the product, the main product variants and the main hardware components. The following topics are described in this chapter:

- [Overview of the 450 Platform Family](#) on page 1-2 introduces the key features, typical uses, product variants and components of the 450 Platform Family.
- [Wireless operation](#) on page 1-17 describes how the 450 Platform Family wireless link is operated, including modulation modes and spectrum management.
- [System management](#) on page 1-22 introduces the 450 Platform Family management system, including the web interface, configuration, security, alerts and recovery.

Overview of the 450 Platform Family

This section introduces the key features, typical uses, product variants and components of the 450 Platform Family.

Purpose

Cambium 450 Platform Family products are designed for Ethernet bridging over point-to-point and point-to-multipoint microwave links in unlicensed and lightly-licensed frequency bands 900MHz, 2.4 GHz, 3.5/3.65 GHz and 4.9 to 5.925 GHz.

Users must ensure that the 450 Platform Family complies with local operating regulations.

The 450 Platform Family acts as a transparent bridge between two or more segments of the operator's network. In this sense, it can be treated as a virtual wired connection among points. The 450 Series platform forwards 802.3 Ethernet frames destined for the other part of the network and filters frames it does not need to forward.

450 Platform Family

The 450 Series platform supports following:

- PMP 450m Series
- PMP/PTP 450i Series
- PMP 450b Series
- PMP/PTP 450 Series

PMP 450m Series

The PMP 450m Series AP is a revolutionary product which is based on Multi-User Multiple-Input and Multiple-Output (MU-MIMO) technology. By combining a sophisticated beam forming antenna array with multiple transceivers, Cambium Networks is using leading edge technology to provide a substantial shift upward in capacity per sector.

Key features

The Cambium PMP 450m Series AP offers the following benefits:

- MU-MIMO Access Point is a technologically cutting-edge device providing more than 400 Mbps in 20 MHz Channel bandwidth using 2.5 ms frame size depending upon SMs position within sector. Even higher data rates are possible in releases 15.1.3 and beyond by using 5 ms frame sizes, or using 30 MHz or 40 MHz bandwidths.

- PMP 450m AP is compatible with existing PMP 450/450i Series Subscriber Modules(SM), providing an easy network upgrade path. This benefits to re-use existing SMs (i.e. capital investment). With releases 15.1.3 and beyond, PMP 450m also provides basic sector mode support for 430 SMs.
- 3x higher throughput packet rate compare 450 Series
- Integrated with 14x14 MU-MIMO antenna
- Gigabit copper/power port combined, 1000BaseT port with power out and SFP port, 2.5G Copper SFP
- More than 20 bps/Hz spectral efficiency and over 40 bps/Hz when deployed in frequency re-use configuration

Table 1 gives a summary of the main PMP 450m Series AP characteristics.

Table 1 Main characteristics of the PMP 450m Series AP

Characteristic	Value
Topology	PMP
Wireless link condition	LOS, near LOS or non-LOS
Range	PMP: Up to 40 mi (or 64 km)
Duplexing	TDD (symmetric and asymmetric)
Connectivity	1000Base-T Ethernet Main port with PoE input
Operating frequencies	5.150 to 5.925 GHz
Tx Power	42 dBm EIRP
Channel bandwidth	5, 10, 15, 20, 30, and 40 MHz
High spectral efficiency	More than 60 bps/Hz ¹
Timing synchronization	CMM5 or UGPS
Data rate	More than 400 Mbps with 20 MHz channel bandwidth and 2.5ms frame size. Additional data rate improvements are available in release 15.1.3 or later by using 30 MHz and 40 MHz channel bandwidths, or 5 ms frame size.

Frequency bands

The PMP 450m Series AP operates from 5150 to 5925 MHz bands.

¹ This is achieved in an ABAB frequency reuse AP deployment model.

Hardware components

The ODU (Outdoor unit) is a self-contained transceiver unit that houses both radio and networking electronics.

The **PMP 450m Series** is supplied in the following configurations:

Table 2 PMP 450m Series hardware configurations

ODU	Frequency	ODU type	
PMP 450m AP	5150 to 5925 MHz	Integrated	14 dBi, 90° MU-MIMO sector antenna

PMP/PTP 450i Series

The PMP/PTP 450i Series is a high performance wireless bridge for Ethernet traffic. It is capable of operating in line-of-sight (LOS), near-LOS and non-LOS propagation conditions. It supports 900 MHz, 3 GHz, and 4.9 to 5.925 GHz frequency band.

Key features

The PMP/PTP 450i Series has extensive quality of service (QoS) involving traffic classification, traffic policy and shaping capability.

The Cambium PMP/PTP 450i Series offers the following benefits:

- Cambium's high performing point-to-multipoint solution, with up to 310 Mbps (40 MHz Channel Bandwidth and 5 ms Frame Period) usable throughput for PMP and PTP
- State-of-the-art MIMO (Multi In Multi Out) technology
- Upto 7.5 bps/Hz spectral efficiency
- Increased Packet Processing rate
- Efficient GPS synchronized, scheduled TDD operation for easy AP/BHM site deployment and performance that is consistent regardless of SM/BHS loading
- A range of cost-effective subscriber device solutions to meet the business case of any network application
- MIMO B Mode: This technique provides for the ability to double the throughput of a radio transmission under proper RF conditions. Different data streams are transmitted simultaneously on two different antennas
- MIMO-A mode: This mode of operation has same modulation levels as the MIMO-B mode, namely: QPSK, 16-QAM, 64-QAM and 256-QAM. This mode increases system reliability in the links.
- Timing synchronization via CMM4, CMM5, or UGPS

[Table 3](#) gives a summary of the main PMP/PTP 450i Series characteristics.

Table 3 Main characteristics of the PMP/PTP 450i Series

Characteristic	Value
Topology	PMP/PTP
Wireless link condition	LOS, near LOS or non-LOS
Range	PTP: Up to 186 mi (or 299 km) depending on configuration for all bands PMP: Up to 40 mi (or 64 km) for 5 GHz band PMP: Up to 120 mi (or 193 km) for 900 MHz band
Duplexing	TDD (symmetric and asymmetric)
Connectivity	1000Base-T Ethernet Main port with PoE input
Operating frequencies	902 to 928 MHz 3.3 to 3.9 GHz 4.9 to 5.925 GHz
Tx Power	Max 25 dBm (3 GHz) Max 27 dBm (5 GHz) Max 25 dBm (900 MHz)
Channel bandwidth	5, 7, 10, 15, 20, 30, and 40 MHz
	 Note All bands do not support all channel bandwidths. For more information, refer to this link .
Spectral efficiency	Up to 7.5 bps/Hz
Timing synchronization	CMM4, CMM5, or UGPS
Data rate	Up to 310 Mbps (40 MHz channel BW) for PMP/PTP

Frequency bands

The PMP/PTP 450i Series ODU can operate in the following bands:

- 900 MHz band: 902 to 928 MHz
- 3 GHz band: 3300 to 3900 MHz
- 5 GHz band: 4900 to 5925 MHz

**Note**

900 MHz, 3 GHz, and 5 GHz bands with different frequencies require different hardware components.

Hardware components

The ODU (Outdoor unit) is a self-contained transceiver unit that houses both radio and networking electronics. The main hardware components of the PMP/PTP 450i Series are as follows:

- PMP 450i AP
- PMP 450i SM
- PTP 450i BH (BHM/BHS)

The **PMP/PTP 450i** Series is supplied in the following configurations:

Table 4 PMP/PTP 450i Series hardware configurations

ODU	Frequency	ODU type	
PMP 450i AP	902 to 928 MHz	Connectorized	Use with an external antenna
	3.3 to 3.9 GHz	Integrated	17 dBi, 90° sector dual slant antenna
		Connectorized	Use with an external antenna
	4.9 to 5.925 GHz (support 4.9, 5.1, 5.2, 5.4 and 5.8 GHz)	Integrated	17 dBi, 90°/120° sector antenna
Connectorized		Use with an external antenna	
PMP 450i SM	3.3 to 3.9 GHz	Integrated	19 dBi, SM/BH with MARS antenna
		Connectorized	Use with an external antenna
	4.9 to 5.925 GHz (support 4.9, 5.1, 5.2, 5.4 and 5.8 GHz)	Integrated	23 dBi flat panel antenna
		Connectorized	Use with an external antenna
PTP 450i BH	3.3 to 3.9 GHz	Integrated	19 dBi, SM/BH with MARS antenna
		Connectorized	Use with an external antenna
	4.9 to 5.925 GHz (support 4.9, 5.1, 5.2, 5.4 and 5.8 GHz)	Integrated	23 dBi flat panel antenna
		Connectorized	Use with an external antenna



Note

The BH ODU can be configured as a BHM or a BHS in PTP mode.

PMP 450b Series

The PMP 450b Series is a high performance wireless Subscriber Module. It supports 4.9 to 5.925 GHz frequency band.

Key features

The Cambium PMP 450b Series offers the following benefits:

- Ultra-wide band radios support the entire band from 4.9 to 5.925 GHz.
- Gigabit Ethernet Interface provides the maximum transfer rates to the device.
- 3.5 mm audio jack allows direct connection of headphones without any adapters.
- Updated FPGA enhances Packet Processing Power more than 4 times that of the 450 SM.
- Capable of up to 310 Mbps aggregate in a 40 MHz channel.

Table 5 gives a summary of the main PMP 450b Series characteristics.

Table 5 Main characteristics of the PMP 450b Series

Characteristic	Value
Topology	PMP
Wireless link condition	LOS, near LOS or non-LOS
Range	PMP: Up to 40 mi (or 64 km)
Duplexing	TDD (symmetric and asymmetric)
Connectivity	100/1000Base-T Ethernet Main port with PoE input
Operating frequencies	4.9 to 5.925 GHz
Tx Power	Max 27 dBm
Channel bandwidth	5, 10, 15, 20, 30, and 40 MHz
	 Note All bands do not support all channel bandwidths. For more information, refer to this link .
Spectral efficiency	Up to 7.5 bps/Hz
Timing synchronization	CMM4, CMM5, or UGPS
Data rate	Up to 310 Mbps (40 MHz channel BW) for PMP

Frequency bands

The PMP 450b Series ODU can operate in the following band:

- 5 GHz band: 4900 to 5925 MHz

Hardware components

The ODU (Outdoor unit) is a self-contained transceiver unit that houses both radio and networking electronics. The main hardware components of the PMP 450b Series are as follows:

- PMP 450b SM

The **PMP 450b** Series is supplied in the following configurations:

Table 6 PMP 450b Series hardware configurations

ODU	Frequency	ODU type	
PMP 450b SM	4.9 to 5.925 GHz (support 4.9, 5.1, 5.2, 5.4 and 5.8 GHz)	Integrated	17 dBi flat panel antenna

PMP/PTP 450 Series

Cambium PMP/PTP 450 Series networks are designed for wireless point-to-multipoint and point-to-point links in the unlicensed/licensed 900 MHz, 2.4 GHz, 3.5 GHz, 3.65 GHz, 5.4 GHz and 5.8 GHz bands. Users must ensure that the PMP/PTP 450 Series complies with local operating regulations.

The PMP/PTP 450 Series enables network operators to grow their business by offering more capacity for data, voice and video applications.

Key features

The Cambium PMP/PTP 450 Series offers the following benefits:

- Cambium's point-to-multipoint and point-to-point solution, with up to 310 Mbps usable throughput
- State-of-the-art MIMO (Multi In Multi Out) technology
- Efficient GPS synchronized, scheduled TDD operation for easy Access Point site deployment and performance that is consistent regardless of subscriber loading
- A range of cost-effective subscriber device solutions to meet the business case of a network application
- MIMO-B Mode: This technique provides for the ability to double the throughput of a radio transmission under proper RF conditions. Different data streams are transmitted simultaneously on two different antennas.
- MIMO-A Mode: This mode of operation using the same modulation levels as the MIMO-B mode, namely: QPSK, 16-QAM, 64-QAM and 256-QAM but it provides an additional combining gain.

[Table 7](#) gives a summary of PMP/PTP 450 Series products main characteristics .

Table 7 Main characteristics of the PMP/PTP 450 Series

Characteristic	Value
Topology	PMP/PTP
Wireless link condition	LOS, near LOS or non-LOS
Range	Up to 40 mi (or 64 km) for PMP Up to 186 mi (or 299 km) for PTP
Duplexing	TDD (symmetric and asymmetric)
Connectivity	100Base-T Ethernet Main port with PoE input
Operating frequencies	900 MHz, 2.4 GHz, 3.5 GHz, 3.65 GHz and 5 GHz
Tx Power	max 22 dBm (2.4 GHz and 5 GHz) max 25 dBm (3.5 GHz and 3.65 GHz) max 25 dBm (900 MHz - PMP 450 SM and BH)
Channel bandwidth	5, 7, 10, 15, 20, 30, and 40 MHz  NOTE All bands do not support all channel bandwidths. For more information, refer to this link .
High spectral efficiency	Up to 7.5 bps/Hz
Timing synchronization	CMM4 or UGPS
Data rate	Up to 310 Mbps (40 MHz channel BW) for PMP/PTP

Frequency bands

The PMP/PTP 450 Series ODU can operate in the following bands:

- 900 MHz band: 902 to 928 MHz (SM and BH)
- 2.4 GHz band: 2400 to 2483 MHz
- 3.5 GHz band: 3300 to 3600 MHz
- 3.65 GHz band: 3500 to 3850 MHz
- 5 GHz band: 5470 to 5875 MHz

Hardware components

The main hardware components of the PMP/PTP 450 are as follows:

- PMP 450 AP
- PMP 450 SM
- PTP 450 BH (BHM/BHS)

The **PMP/PTP 450** is supplied in the following configurations:

Table 8 PMP/PTP 450 Series hardware configurations

ODU	Frequency	ODU type	
PMP 450 AP	2.4 GHz	Connectorized	Use with an external antenna
		Integrated	18 dBi Dual Slant
	3.5/3.65 GHz	Connectorized	Use with an external antenna
		Integrated	16 dBi Dual Slant
	5 GHz (5.4 and 5.8 GHz)	Connectorized	Use with an external antenna
PMP 450 SM	900 MHz	Connectorized	Use with an external antenna
	2.4 GHz	Connectorized	Use with an external antenna
		Integrated	7 dBi Dual Slant, integrated patch
	3.5/3.65 GHz	Connectorized	Use with an external antenna
		Integrated	8 dBi Dual Slant, integrated patch
		Integrated	19 dBi Flat Plate, integrated patch
	5 GHz (5.4 and 5.8 GHz)	Connectorized	Use with an external antenna
		Integrated	9 dBi H+V, integrated patch
		Integrated	25 dBi H+V, Integrated dish
PTP 450 BH	902 to 928 MHz	Connectorized	Use with an external antenna
	3.5/3.65 GHz	Connectorized	Use with an external antenna
		Integrated	8 dBi Dual Slant
	5 GHz (5.4 and 5.8 GHz)	Connectorized	Use with an external antenna
		Integrated	9 dBi H+V

**Note**

The BH ODU can be configured as a BHM or a BHS in PTP mode

Supported interoperability for 450m/450i/450b/450 Series

The supported interoperability among various 450m/450i/450 Series hardwares are listed below:

Table 9 Supported Interoperability for PMP

Band	AP	SM
5.1, 5.2 and 5.9 GHz	PMP 450m AP	PMP 450i SM, PMP 450b SM
4.9, 5.1, 5.2 and 5.9 GHz	PMP 450i AP	PMP 450i SM, PMP 450b SM
5.4 and 5.8 GHz	PMP 450m AP	PMP 450i SM, PMP 450 SM, PMP 450d SM, and PMP 450b SM
	PMP 450i AP	
	PMP 450 AP	
3.5 and 3.65 GHz	PMP 450 AP	PMP 450 SM, PMP 450i SM
	PMP 450i AP	PMP 450i SM, PMP 450 SM
2.4 GHz	PMP 450 AP	PMP 450 SM
900 MHz	PMP 450i AP	PMP 450 SM

Table 10 Supported Interoperability for PTP

Band	BH
900 MHz	PTP 450 BHM and BHS
3.5 and 3.65 GHz	PTP 450/450i BHM and BHS
4.9, 5.1, 5.2, 5.4 and 5.8 GHz	PTP 450i BHM and BHS
5.4 and 5.8 GHz	PTP 450/450i BHM and BHS

Typical deployment

The 450 Platform Family is an “all outdoor” solution consisting of a wireless bridge across sites. Each site installation consists of an Integrated or Connectorized outdoor unit (ODU) and a power supply (PSU) (see [Figure 1](#)). The ODU provides the following interfaces:

- Ethernet port: This provides proprietary power over Ethernet and connection to the management and/or data networks.

Figure 1 PMP/PTP 450 Platform Family typical bridge deployment

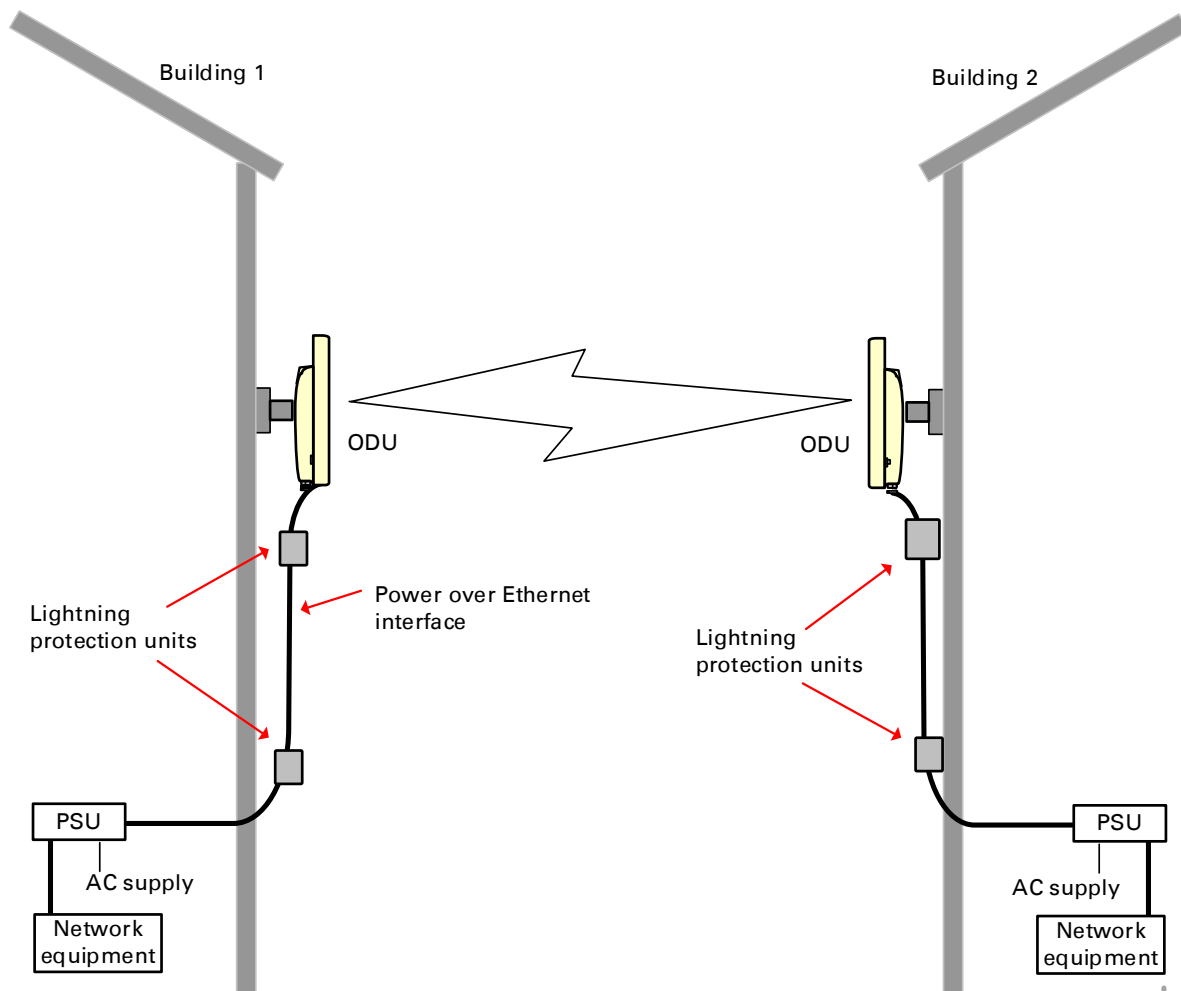

Point-to-Multipoint

The PMP configuration of 450 Platform Family consists of Access Point (AP) and Subscriber Module (SM) ODU. The radio link operates on a single frequency channel in each direction using Time Division Duplex (TDD). [The AP operates in TDMA mode to service multiple SMs.](#)

Applications for the PMP Series include:

- High throughput enterprise applications
- nLOS video surveillance in metro areas
- Urban area network extension
- Network extension into areas with foliage

Point-to-Point (Backhaul)

The PTP configuration of 450 Platform Family consists of two BH (Backhaul) ODUs. The customer can decide, via software configuration, if this unit is a BHM (Backhaul Master) or a BHS (Backhaul Slave). The radio link operates on a single frequency channel using Time Division Duplex (TDD). [The BHM operates in TDMA mode to service the BHS.](#)

Applications for the PTP Series include:

- Enterprise Access
- nLOS video surveillance
- Leased line replacements and backup solutions
- Network extension

Product variants

The 450 Platform Family is available in the following product variants:

- The ODU is supplied in the following regional variants:
 - FCC, intended for deployment in the USA
 - EU, intended for deployment in countries of the European Union or other countries following ETSI regulations
 - Rest of the World (RoW), intended for deployment in countries other than USA and EU countries.
 - IC, intended for deployment in Canada
- A ruggedized ODU Subscriber Module designed to meet IP-66 and IP-67 standards to withstand harsh environments
- An integrated Dish ODU Subscriber Module in a new, rugged and high gain design for 5 GHz band
- An indoor power supply module providing Power-over-Ethernet (PoE) supply to ODU (AP/SM/BH)
- Antennas and antenna cabling: Connectorized ODUs require external antennas connected using RF cable
- Ethernet cabling: All configurations require a copper Ethernet Cat5e connection from the ODU (Ethernet port) to the PoE
- Lightning protection unit (LPU): LPUs are installed in the ports copper drop cables to provide transient voltage surge suppression
- Surge Suppression: The Gigabit Surge Suppressor provides a path to ground (Protective Earth) that protects connected radio equipment from near-miss lightning strikes.
- Ground cables: ODU, LPUs and outdoor copper Ethernet cables are bonded to the site grounding system using ground cables.

For more information about these components, including interfaces, specifications and Cambium part numbers, refer to [Chapter 2: System hardware](#).

Wireless operation

This section describes how the 450 Platform Family wireless link is operated, including modulation modes, power control and security.

Time division duplexing

The system uses Time Division Duplexing (TDD) – one channel alternately transmits and receives rather than using one channel for transmitting and a second channel for receiving. The radio link operates on a single frequency channel in each direction using TDD. The AP operates in TDMA mode to service multiple SMs. To accomplish TDD, the AP/BHM must provide sync to its SM/BHS.

Furthermore, collocated APs/BHMs must be synced together – an unsynchronized AP/BHM that transmits during the receive cycle of a collocated AP/BHM can prevent a second AP/BHM from being able to decode the signals from its APs/BHSs. In addition, across a geographical area, APs/BHMs that can “hear” each other benefit from using a common sync to further reduce self-interference within the network.

Modules use TDD on a common frequency to divide frames for uplink (orange) and downlink (green) usage, as shown in the figure below.

For more information on synchronization configuration options, see [GPS synchronization](#) on page 2-45.

Figure 2 TDD frame division

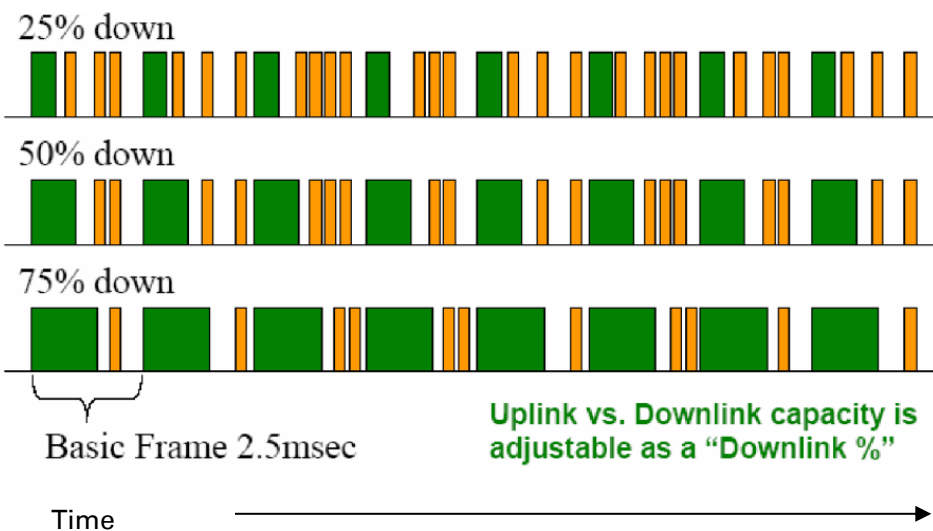

TDD frame parameters

The TDD burst duration varies depending on the following:

- Channel Bandwidth
- Cyclic Prefix
- Frame Period
- Frame configuration - Downlink Data
- Link operation – Dynamic Rate Adaptation

OFDM and channel bandwidth

The PMP/PTP 450 Platform Family transmits using Orthogonal Frequency Division Multiplexing (OFDM). This wideband signal consists of many equally spaced sub-carriers. Although each sub carrier is modulated at a low rate using conventional modulation schemes, the resultant data rate from the sub-carriers is high. OFDM works exceptionally over a Non-Line-of-Sight (NLoS) channel.

The channel bandwidth of the OFDM signal is configurable to one of the following values: 5, 7, 10, 15, 20 and 30 MHz. Higher bandwidths provide greater link capacity at the expense of using more bandwidth. Systems configured for a narrower channel bandwidth provide better receiver sensitivity and can also be an appropriate choice in deployments where the amount of free spectrum is limited.



Note

The channel bandwidth must be configured to the same value at both ends of the link. Not all channel bandwidths are available in all regulatory bands.

Cyclic Prefix

OFDM technology uses a cyclic prefix, where a portion of the end of a symbol (slot) is repeated at the beginning of the symbol (slot) to allow multi-pathing to settle before receiving the desired data. A 1/16 cyclic prefix means that for every 16 bits of throughput data transmitted, an additional bit is used. For your convenience, the 450 Platform Family ODUs have been locked to a 1/16 CP.

Frame Period

The frame period or frame duration is the time between the beginning of a frame and the end of the frame. The 450 Platform Family supports two frame periods: 2.5 ms and 5 ms.



Note

PMP 450m AP supports 2.5 ms Frame Period only.

The 5ms frame period configuration provides higher throughput as a result of reduced frame overhead during transmission. In turn, the 2.5 ms frame period configuration affords reduced latency in the system, half of that introduced by the 5 ms frame configuration.

Frame configuration - Downlink Data

The percentage of frame assigned to transport downlink data. The downlink data specifies the percentage of the aggregate throughput for the downlink (frames transmitted from the AP/BHM to the subscriber). The configurable range is 15% to 85%.



Note

The maximum configurable range is 34% to 66% for 40 MHz with 5 ms frame.

Link operation – Dynamic Rate Adapt

The 450 Platform Family ODUs offer eight levels or speeds of operation – 2X MIMO-B and 1X MIMO-A (QPSK), 4X MIMO-B and 2X MIMO-A (16-QAM), 6x MIMO-B and 3X MIMO-A (64-QAM) and 8X MIMO-B and 4X MIMO-A (265-QAM). If received power varies due to distance between the AP/BHM and the SM/BHS or due to obstructions, or if interference affects the RF environment, the system automatically and dynamically adjusts the links to the best operation level.

The system chooses its modulation rate dynamically, based on an internal ARQ (Automatic Repeat reQuest) error control method. With ARQ, every data slot of every frame sent over the air (except downlink broadcast) is expected to be acknowledged by the receiver, and if acknowledgement is not received, the data is resent. The sending unit monitors these re-sends and adjusts the modulation rate accordingly. It is normal to have links that change levels of operation as the RF environment changes. Furthermore, the uplink or downlink portions of TDD duty cycle operate independently.

The various modulation levels used by 450 Platform Family are shown in [Table 11](#).

Table 11 Modulation levels

Rate	MIMO-B	MIMO-A
QPSK	2X MIMO-B	1X MIMO-A
16-QAM	4X MIMO-B	2X MIMO-A
64-QAM	6X MIMO-B	3X MIMO-A
256-QAM	8X MIMO-B	4X MIMO-A

**Note**

MIMO-A achieves half the throughput of MIMO-B but adds a combining diversity (gain) which enhances the link budget or availability.

Encryption

The 450 Platform Family supports optional encryption for data transmitted over the wireless link. The 450 Platform Family supports the following forms of encryption for security of the wireless link:

- **DES (Data Encryption Standard):** An over-the-air link encryption option that uses secret 56-bit keys and 8 parity bits. DES performs a series of bit permutations, substitutions, and recombination operations on blocks of data. DES encryption does not affect the performance or throughput of the system.
- **AES (Advanced Encryption Standard):** An over-the-air link encryption option that uses the Rijndael algorithm and 128-bit keys and 256-bit key size to establish a higher level of security than DES. AES products are certified as compliant with the Federal Information Processing Standards (FIPS 197) in the U.S.A.

The default setting on an AP is "Disabled".

MIMO

Multiple-Input Multiple-Output (MIMO) techniques provide protection against fading and increase the probability that the receiver decodes a usable signal. When the effects of MIMO are combined with those of OFDM techniques and a high link budget, there is a high probability of a robust connection over a non-line-of-sight path.

The sub-features that comprises the MIMO techniques utilized in the 450 Platform Family ODU are:

- **MIMO-A:** This technique enables 450 Platform Family radio to use a scheme that optimizes coverage by transmitting the same data over both antennas. This redundancy improves the signal to noise ratio at the receiver making it more robust.
- **MIMO-B:** This technique provides the ability to double the throughput of a radio transmission under proper RF conditions. Different data streams are transmitted simultaneously on two different antennas.

MU-MIMO

Multiple-input multiple-output, or MIMO, is a range of technologies used to multiply the capacity of a wireless connection without requiring more spectrum.

Although traditional MIMO techniques are focused on increasing the bandwidth available between two wireless nodes, multi-user MIMO (MU-MIMO) applies these technologies to increase overall wireless network capacity by allowing an access point to communicate wirelessly with more than one wireless node at once.

A MU-MIMO access point features an array of antennas. When the AP decides to communicate with multiple nodes at the same time, it creates multiple simultaneous beams each directed to a specific node.

This is contrast to a traditional wireless system, where two wireless nodes cannot communicate on the same channel to the same access point at the same time, without causing significant self-interference and degrading the overall wireless network performance.

A MU-MIMO access point estimates and measures what a transmission from each wireless node 'sounds like', by applying knowledge of the wireless path characteristics between the access point and node. Known as channel estimation, this process is of vital importance; without it, the access point cannot distinguish properly between wireless nodes, affecting performance.

Channel estimation is achieved by the access point sending a specific signal to a wireless node, which the node then reflects back. By measuring how the signal was received back from the node, the access point can estimate the wireless conditions between itself and the node, and know to expect these same conditions to be applied to other communications from that node. This is known as channel sounding.

Channel estimation and sounding must be regularly repeated to ensure wireless network performance remains high; the speed at which a system is able to accurately estimate the channel has a large impact on performance.

Once channel estimation is completed for a wireless node, the MU-MIMO access point can electrically tune each antenna to provide the highest performance for that node. The access point uses beamforming to create a radio beam to that node which is tuned for optimum performance and avoids beams directed to other nodes, reducing interference and helping to improve overall wireless network capacity.

A MU-MIMO access point can communicate to multiple wireless nodes simultaneously using this process. As the majority of nodes are unable to make full use of the whole access point capacity at once, communicating with several nodes simultaneously can greatly improve the overall capacity achieved in the wireless network.

System management

This section introduces the 450 Platform Family management system, including the web interface, installation, configuration, alerts and upgrades.

Management agent

The 450 Platform Family radios are managed through an embedded management agent.

Management workstations, network management systems or PCs can be connected to this agent using the module's Ethernet port or over-the air (SM/BHS)

The management agent supports the following interfaces:

- Hypertext transfer protocol (HTTP)
- Hypertext transfer protocol secure (HTTPS)
- RADIUS authentication
- Simple network management protocol (SNMP) – v2c and v3
- Network time protocol (NTP)
- System logging (Syslog)
- Wireless Manager (WM) software
- Canopy Network Updater Tool (CNUT) software
- cnMaestro™

Web server

The 450 Platform Family management agent contains a web server. The web server supports access via the HTTP/HTTPS interface.

Web-based management offers a convenient way to manage the 450 Platform Family radios from a locally connected computer or from a network management workstation connected through a management network, without requiring any special management software. The web and SNMP are the interfaces supported for installation of 450 Platform Family radios and for the majority of configuration management tasks.

Web pages

The web-based management interfaces provide comprehensive web-based fault, configuration, performance and security management functions organized into the following groups:

Access Point or Backhaul Master:

- Home
- Configuration
- Statistics
- Tools
- Logs
- Accounts
- Quick Start
- Copyright

Subscriber Module or Backhaul Slave

- Home
- Configuration
- Statistics
- Tools
- Logs
- Accounts
- PDA
- Copyright

Identity-based user accounts

- When identity-based user accounts are configured, a security officer can define from one to four user accounts, each of which may have one of the four possible roles:
- ADMINISTRATOR, who has full read and write permissions. This is the level of the root and admin users, as well as any other administrator accounts that one of them creates.
- INSTALLER, who has permissions identical to those of ADMINISTRATOR except that the installer cannot add or delete users or change the password of any other user.
- TECHNICIAN, who has permissions to modify basic radio parameters and view informational web pages
- GUEST, who has no write permissions and only a limited view of General Status tab
- Admin, Installer and Tech accounts can be configured as READ-ONLY. This will allow the account to only see the items.

See [Managing module access by passwords](#) for detailed information on account permissions.

Remote Authentication Dial-in User Service (RADIUS)

The PMP configuration of 450 Platform Family includes support for RADIUS (Remote Authentication Dial In User Service) protocol functionality including:

- **SM Authentication:** Allows only known SMs onto the network (blocking “rogue” SMs), and can be configured to ensure SMs are connecting to a known network (preventing SMs from connecting to “rogue” APs). RADIUS authentication is used for SMs, but not used for APs.
- **SM Configuration:** Configures authenticated SMs with MIR (Maximum Information Rate), High Priority, and VLAN (Virtual LAN) parameters from the RADIUS server when a SM registers to an AP.
- **User Authentication** allows users to configure a separate User authentication server along with the SM authentication server. If firmware is upgraded while using this functionality and no User authentication servers are configured, then AP continues to use the SM authentication server for User authentication
- **SM Accounting** provides support for RADIUS accounting messages for usage-based billing. This accounting includes indications for subscriber session establishment, subscriber session disconnection, and bandwidth usage per session for each SM that connects to the AP.
- **Centralized AP and SM user name and password management:** Allows AP and SM usernames and access levels (Administrator, Installer, Technician and Read-Only) to be centrally administered in the RADIUS server instead of on each radio and tracks access events (logon/logoff) for each username on the RADIUS server. This accounting does not track and report specific configuration actions performed on radios or pull statistics such as bit counts from the radios. Such functions require an Element Management System (EMS) such as Cambium Wireless Manager. This accounting is not the ability to perform accounting functions on the subscriber/end user/customer account.
- **Framed-IP-Address:** Operators may use a RADIUS server to assign management IP addressing to SM modules. SNMP

The management agent supports fault and performance management by means of an SNMP interface. The management agent is compatible with SNMP v2c and SNMP v3 using Management Information Base (MIB) files which are available for download from the Cambium Networks Support website:

<https://support.cambiumnetworks.com/files/ptp450>

<https://support.cambiumnetworks.com/files/pmp450>

Network Time Protocol (NTP)

The clock supplies accurate date and time information to the system. It can be set to run with or without a connection to a network time server (NTP). It can be configured to display local time by setting the time zone and daylight saving in the Time web page.

If an NTP server connection is available, the clock can be set to synchronize with the server time at regular intervals. The 450 Platform Family radios may receive NTP data from a CMM4 module or an NTP server configured in the system’s management network.

The Time Zone option is configurable on the AP's/BHM's Time Configuration page, and may be used to offset the received NTP time to match the operator's local time zone. When set on the AP/BHM, the offset is set for the entire sector (AP/BHMs are notified of the current Time Zone upon initial registration). If a Time Zone change is applied, the AP/BHMs are notified of the change in a best effort fashion, meaning some AP/BHMs may not pick up the change until the next re-registration. Time Zone changes are noted in the Event Log.

An AP/BHM which is receiving NTP date and time information from an NTP server or from a GPS synchronization source may be used as an NTP server. Any client which has IP connectivity to the BHM may request NTP date and time information from the AP/BHM. No additional configuration (other than the AP/BHM receiving valid NTP data) is required to use the AP/BHM as an NTP server.

Wireless Manager (WM)

Cambium Networks Wireless Manager 4.0 is recommended for managing 450 Platform Family networks. You can achieve better uptime through better visibility of your network with the Cambium Wireless Manager. This network management software tool offers breakthrough map-based visualization capabilities using embedded Google maps, and combined with advanced configuration, provisioning, alerting and reporting features you can control your entire outdoor wireless network including Point-to-Multipoint and Point-to-Point solutions as well as other SNMP enabled devices. With its powerful user interface you can not only be able to control your network's access, distribution and backhaul layers, but can also have visibility to WLAN sites and be able to quickly launch indoor network management systems. Some key features of Wireless Manager are:

- **Template-Based Configuration:** With Wireless Manager's user-defined templates you can accelerate the process for the configuration of the devices you add to your network resulting in quicker and easier deployments. The template-based functionality provides an automated way to configure large numbers of network devices with just a few mouse clicks, and can be scheduled to occur at any time via Wireless Manager's Task Scheduler.
- **Ultralight Thin Client:** With the growing mobile workforce it is important to have access to the status of your network at any time. With Wireless Manager you can view the status and performance of your entire wireless network via a compact web interface accessible by your smart phone.
- **Map-Based Visualization:** Wireless Manager overlays sophisticated real-time information about your network elements onto building layouts and dynamic Google maps. Visuals can be scaled to view an entire city or building or a specific area, floor or link.
- **High Availability Architecture Support:** Wireless Manager offers a high availability option, providing a highly reliable and redundant network management solution that ensures you always have management access to your network.
- **High Scalability:** The enhanced Wireless Manager offers you server scalability with support for up to 10,000 nodes as well as support for distributed server architecture.

Cambium's Wireless Manager 4.0 available for download at:

<http://www.cambiumnetworks.com/support/management-tools/wireless-manager/>

Canopy Network Updater Tool (CNUT)

CNUT (Canopy Network Updater Tool) is the stand-alone software update tool for 450 Platform Family ODU. The CNUT 4.11.2 should be used for 450 Platform Family ODUs.

The Canopy Network Updater Tool has the following features:

- Automatically discovers all network elements
- HTTP and HTTPS
- Executes UDP command that initiates and terminates the Auto-update mode within APs/BHMs. This command is both secure and convenient:
 - For security, the AP/BHM accepts this command from only the IP address that specified in the Configuration page of ODU.
 - For convenience, Network Updater automatically sets this Configuration parameter in the AP/BHM to the IP address of the Network Updater server when the server performs any of the update commands.
- Allows you to choose among updating:
 - Entire network.
 - Only elements that you select.
 - Only network branches that you select.
- Provides a Script Engine that you can use with any script which:
 - The user can define.
 - Cambium supplies.

CNUT is available at:

<http://www.cambiumnetworks.com/support/management-tools/cnut/>

cnMaestro™

cnMaestro™ is a cloud-based or on-premises platform specialized for secure, end-to-end network lifecycle management: inventory management, device onboarding, daily operations, and maintenance. The cnMaestro wireless network manager simplifies device management by offering full network visibility. Network operators can have a real-time view of their complete end-to-end network and perform a full suite of wireless network management functions to optimize system availability, maximize throughput, and meet emerging needs of business and residential customers. In addition, the cnMaestro wireless network manager collects and displays compliance with service level agreements.

To learn about cnMaestro™, please visit <http://www.cambiumnetworks.com/products/software-tools/cnmaestro/>

See [Configuring cnMaestro™ Connectivity on 7-223](#) for details.

Radio recovery mode

The 450 Platform Family recovery mode provides a means to recover from serious configuration errors including lost or forgotten passwords and unknown IP addresses.

The recovery procedure for 450m/450i/450b series and 450 series ODUs differ due to difference in hardwares. This procedure for 450i/450m Series is known as Radio Recovery Console and for 450 Series is known as Default mode (or Default/Override Plug).

Radio Recovery Console – 450i, 450b and 450m Series

The Radio Recovery Console mode supports:

- Restoring factory default IP address 169.254.1.1 and password
- Boot with factory default Canopy system software settings
- Load previously installed SW images

See [Radio Recovery Console– PMP/PTP 450i/450b and PMP 450m](#) on page 9-39.

Default Mode (or Default Plug) – 450 Series

A default plug is available to provide access to a module whose password and/or IP address have been forgotten.

This plug allows the 450 Series ODUs to be accessed using IP address 169.254.1.1 and no password. During the override session, you can assign any new IP address and set either or both user passwords (display-only and/or full access) as well as make other parameter changes.

See [Default Mode \(or Default/Override Plug\) - PMP/PTP 450](#) on page 9-41.

Chapter 2: System hardware

This chapter describes the hardware components of a 450 Platform link.

The following topics are described in this chapter:

- [System Components](#) on page 2-2 describes system components of PTP and PMP including its accessories
- [Cabling](#) on page 2-33 describes about various cables.
- [Lightning protection unit \(LPU\) and grounding kit](#) on page 2-41 describes about lightning protection and grounding kit
- [Antennas and antenna cabling](#) on page 2-43 describes supported antennas and its accessories
- [GPS synchronization](#) on page 2-45 describes UGPS and CMM4.
- [Ordering the components](#) on page 2-60 specifies Cambium part numbers for 450 Platform Family components

System Components

Point-to-Multipoint (PMP)

The PMP radio is a transceiver device. It is a connectorized or radiated outdoor unit containing all the radio, networking, and surge suppression electronics. It can be purchased as:

- Access Point Module (AP)
- Subscriber Module (SM)

PMP 450 Platform Family Integrated or Connectorized ODU

The PMP 450i Series and PMP 450 Series ODUs are supplied in Integrated or Connectorized configurations. The PMP 450m Series AP is supplied in Integrated configuration only.

See [Table 2 PMP 450m Series hardware configurations](#) on page 1-4

See [Table 4 PMP/PTP 450i Series hardware configurations](#) on page 1-6

See [Table 6 PMP 450b Series hardware configurations](#) on page 1-9

See [Table 8 PMP/PTP 450 Series hardware configurations](#) on page 1-12

Product variants

Table 12 PMP 450m Series variants

Variant	Region	Antenna	Frequency Range	Channel Bandwidth	Max EIRP
5 GHz PMP 450m AP	FCC	90° integrated sector array, 14x14 MIMO system,	5150 – 5925 MHz	5, 10, 15, 20, 30, 40 MHz	42 dBm
	RoW				
	EU				
	DES only				
	IC				

Table 13 PMP 450i Series variants

Variant	Region	Antenna	Frequency Range	Channel Bandwidth	Max Tx Power
900 MHz PMP 450i AP	FCC	Connectorized	902 - 928 MHz	5, 7, 10, 15, 20 MHz	25 dBm
3 GHz PMP 450i AP	FCC, RoW, Canada, RoW DES, Europe	Connectorized Integrated 16 dBi	3300 – 3900 MHz	5, 7, 10, 15, 20, 30, 40 MHz	25 dBm
5 GHz PMP 450i AP	FCC, RoW, Canada, RoW DES, Europe	Connectorized Integrated 16 dBi 90 degree	4900 – 5925 MHz	5, 10, 15, 20, 30, 40 MHz	27 dBm

Table 14 PMP 450b Series variants

Variant	Region	Antenna	Frequency Range	Channel Bandwidth	Max Tx Power
5 GHz PMP 450b SM	FCC, RoW, Canada, RoW DES, Europe	Integrated 16 dBi	4900 – 5925 MHz	5, 10, 15, 20, 30, 40 MHz	27 dBm

**Note**

The Transmit power is limited based on regional setting.

Table 15 PMP 450 Series variants

Variant	Region	Antenna	Frequency Range	Channel Bandwidth	Max Tx Power
900 MHz PMP 450 SM	FCC	Connectorized	902 - 928 MHz	5, 7, 10, 15, 20 MHz	25 dBm
2.4 GHz PMP 450 AP	FCC ISM	Connectorized	2400 – 2483.5 MHz	5, 10, 15, 20 MHz	22 dBm
		Integrated 18 dBi			
2.4 GHz PMP 450 SM	FCC ISM	Connectorized	2400 – 2483.5 MHz	5, 10, 15, 20 MHz	22 dBm
		Integrated 7 dBi			
3.5 GHz PMP 450 AP	FCC ISM	Connectorized	3300 – 3600 MHz	5, 7, 10, 15, 20, 30, 40 MHz	25 dBm
		Integrated 16 dBi			
3.5 GHz PMP 450 SM	FCC ISM	Connectorized	3300 – 3600 MHz	5, 7, 10, 15, 20, 30, 40 MHz	25 dBm
		Integrated 8 dBi			
		Integrated 19 dBi			
3.65 GHz PMP 450 AP	FCC ISM	Connectorized	3500 – 3850 MHz	5, 7, 10, 15, 20, 30, 40 MHz	25 dBm
		Integrated 16 dBi			
3.65 GHz PMP 450 SM	FCC ISM	Connectorized	3500 – 3850 MHz	5, 7, 10, 15, 20, 30, 40 MHz	25 dBm
		Integrated 8 dBi			
		Integrated 19 dBi			
5.4/5.8 GHz PMP 450 AP	FCC, RoW, RoW DES	Connectorized	5470 – 5875 MHz	5, 10, 15, 20, 30, 40 MHz (5, 15 and 30 MHz not available in DFS regions)	22 dBm
		Integrated 17 dBi			
5.4/5.8 GHz PMP 450 SM	FCC, ROW, RoW DES	Connectorized	5470 – 5875 MHz	5, 10, 15, 20, 30, 40 MHz (5, 15 and 30 MHz not available in DFS regions)	22 dBm
		Integrated 9 dBi			
		Integrated 25 dBi			

**Note**

The Transmit power is limited based on regional setting.

Backhaul (PTP)

The Backhaul radio is a transceiver device. It is a connectorized or integrated outdoor unit containing all the radio, networking, and surge suppression electronics. It can be configured as:

- Backhaul Master (BHM)
- Backhaul Slave (BHS)

PTP 450 Platform Family Integrated or Connectorized ODU

See [Table 4 PMP/PTP 450i Series hardware configurations](#) on page 1-6

See [Table 8 PMP/PTP 450 Series hardware configurations](#) on page 1-12

Product variants

Table 16 PTP 450i Series variants

Variant	Region	Antenna	Frequency Range	Channel Bandwidth	Max Tx Power	Notes
3 GHz PTP 450i	FCC, RoW, Canada, Row DES, Europe	Connectorized <hr/> Integrated 23 dBi	3300 - 3900 MHz	5, 7, 10, 15, 20, 30, 40 MHz	25 dBm	Transmit power limited based on regional setting
5 GHz PTP 450i	FCC, RoW, Canada, Row DES, Europe	Connectorized <hr/> Integrated 23 dBi	4900 – 5925 MHz	5, 10, 15, 20, 30, 40 MHz	27 dBm	Transmit power limited based on regional setting

Table 17 PTP 450 Series variants

Variant	Region	Antenna	Frequency Range	Channel Bandwidth	Max Tx Power
900 MHz PTP 450 BH	FCC	Connectorized	902 – 928 MHz	5, 7, 10, 15, 20 MHz	25 dBm
3.5 GHz PTP 450 BH	ROW	Connectorized	3300 – 3600 MHz	5, 7, 10, 15, 20, 30, 40 MHz	25 dBm
		Integrated 16 dBi			
		Integrated 19 dBi			
3.65 GHz PTP 450 BH	ROW	Connectorized	3500 – 3850 MHz	5, 7, 10, 15, 20, 30, 40 MHz	25 dBm
		Integrated 16 dBi			
		Integrated 19 dBi			
5.4/5.8 GHz PTP 450 BH	FCC, RoW, RoW DES	Connectorized	5470 – 5875 MHz	5, 10, 15, 20, 30, 40 MHz	22 dBm
		Integrated 9 dBi			
		Integrated 25 dBi			

**Note**

The Transmit power is limited based on regional setting.

450 Platform Family interfaces

PMP 450m Series interfaces – AP

The 450m Series AP interfaces is illustrated below.

Figure 3 PMP 450m Series interfaces

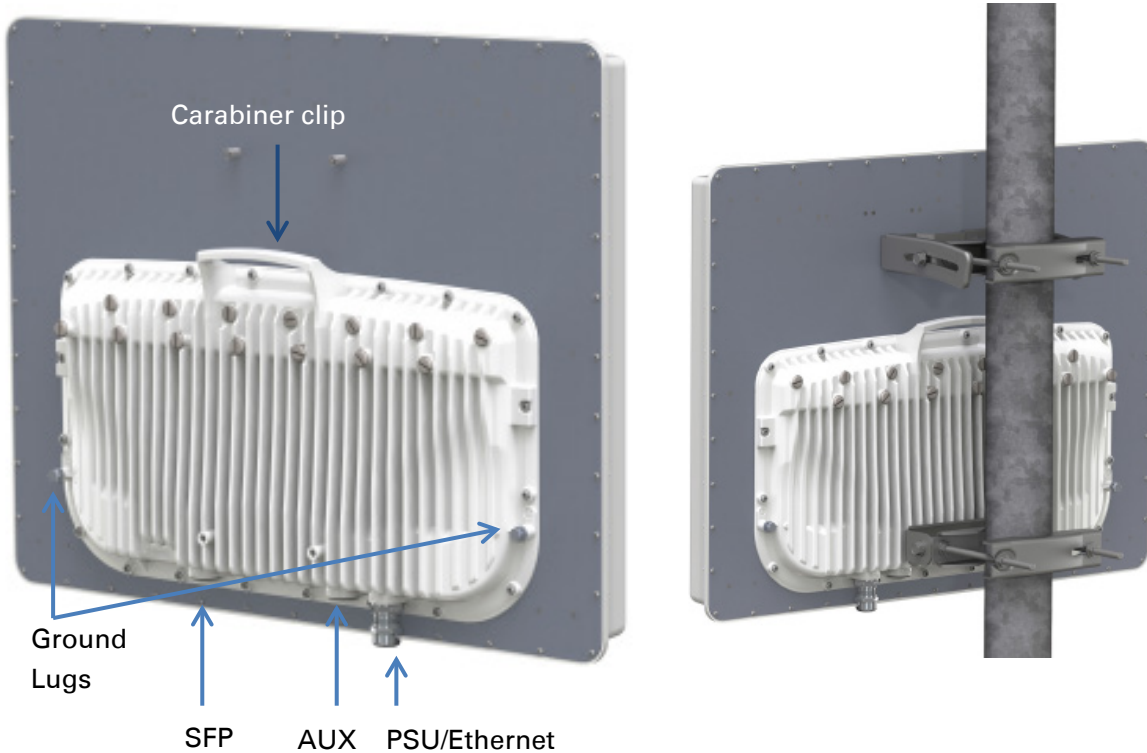

Table 18 PMP 450m Series AP interface descriptions and cabling

Interface	Function	Cabling
PSU/Ethernet	Power-over-Ethernet, Ethernet communications (management and data), CMM5 sync-over-power synchronization input	RJ45 Cable See Table 94 on page 5-12
Aux/Sync	GPS synchronization input and output, UGPS power output	RJ 45 Cable
	Audio tones	See Table 95 on page 5-12
	Data	
SFP	Real Ethernet communications (management and data)	
Ground Lugs	For grounding the unit	10 AWG copper wire

**Note**

For PMP 450m AP, the Sync-Over-Power is supported with CMM5 only.

For PMP 450m AP, the Sync-Over-Power will not work with CMM4 like PMP 450/450i Series.

**Note**

SFP kits (Single Mode Optical SFP Interface per ODU (part number C000065L008A),

Multi-mode Optical SFP Interface per ODU (part number C000065L009A), and

2.5GBASE-T Copper SFP Interface per ODU (part number C000065L011A)) are required for SFP port connectivity.

PMP/PTP 450i Series interfaces – AP/SM/BH

The AP/SM/BH interfaces are illustrated below.

Figure 4 PMP/PTP 450i interfaces

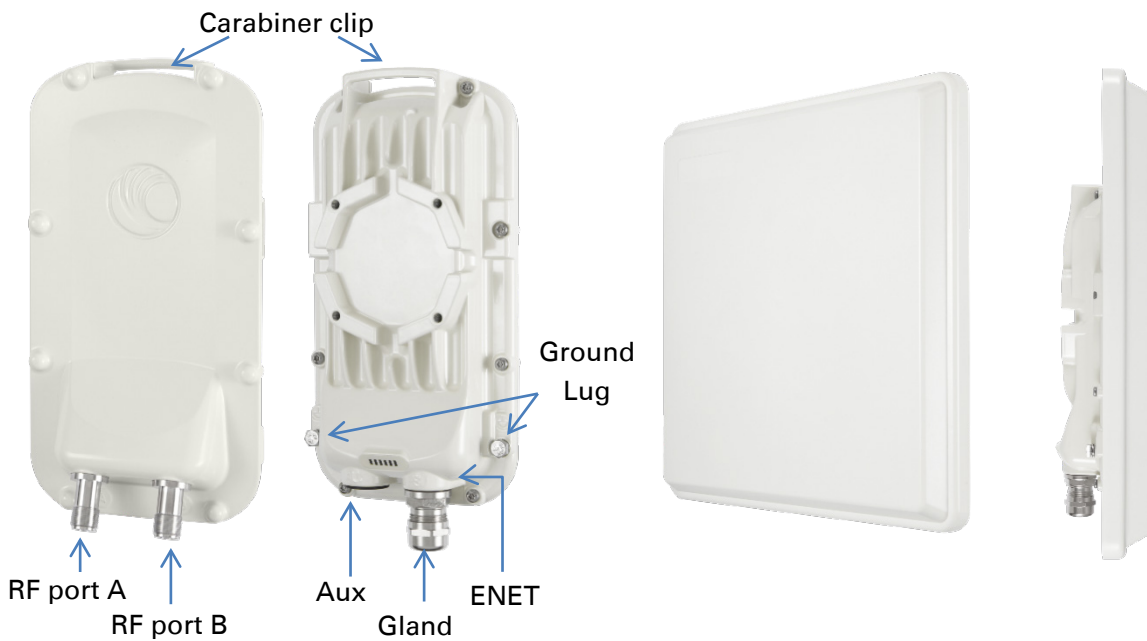

Table 19 PMP/PTP 450i Series - AP/SM/BH interface descriptions and cabling

Interface	Function	Cabling
PSU/Ethernet	Power-over-Ethernet, Ethernet communications (management and data), CMM sync-over-power synchronization input	RJ45 Cable See Table 94 on page 5-12
Aux/Sync	GPS synchronization input and output, UGPS power output	RJ 45 Cable
	Audio tones	See Table 95 on page 5-12
	Data	
RF Port A	Vertical RF connection to antenna	50 ohm RF cable, N-type
RF Port B	Horizontal RF connection to antenna	50 ohm RF cable, N-type
Ground Lugs	For grounding the unit	10 AWG copper wire

**Note**

If the Aux port will be used, a second Ethernet Gland will need to be ordered (Part Number: N000065L033A).

PMP 450b Series interfaces - SM

The PMP 450b Series - SM interfaces are illustrated below.

Figure 5 PMP 450b Series - SM interfaces

Table 20 PMP 450b Series - SM interface descriptions and cabling

Interface	Function	Cabling
PSU/Ethernet	Power-over-Ethernet, Ethernet communications (management and data)	RJ45 Cable
Audio AUX Port	3.5 mm audio jack for alignment tone	Standard 3.5 mm TRRS headphones

PMP/PTP 450 Series interfaces - AP

The PMP 450 Series - AP interfaces are illustrated below.

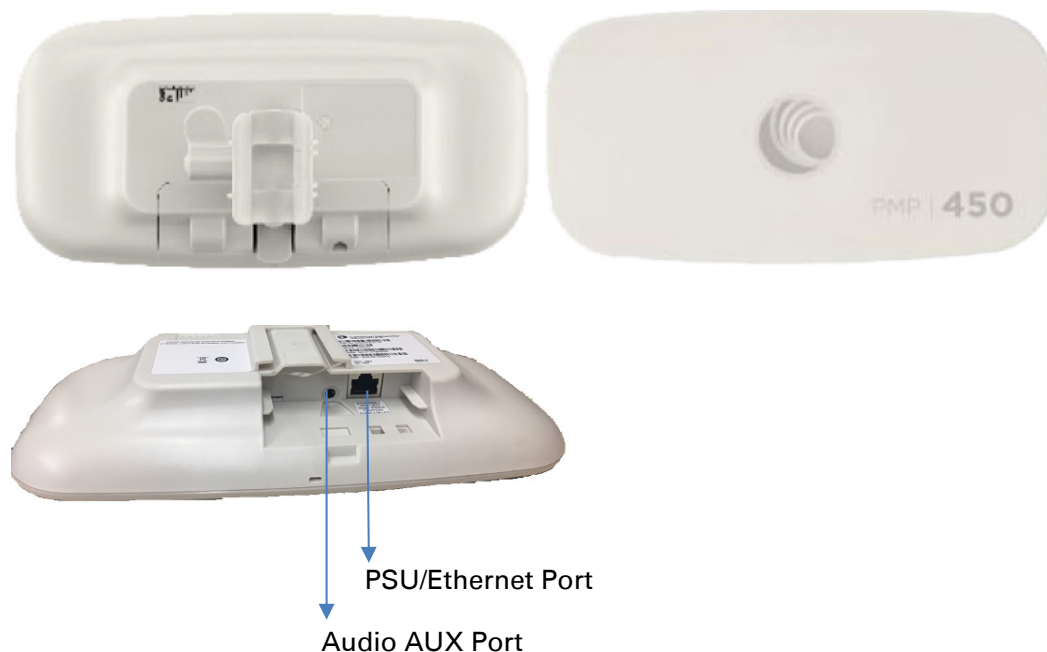
Figure 6 PMP/PTP 450 Series - AP interfaces

Table 21 PMP/PTP 450 Series - AP interface descriptions and cabling – 2.4 GHz and 5 GHz

Interface		Function	Cabling
PSU/Ethernet		Power-over-Ethernet, Ethernet communications (management and data)	RJ45 Cable
Sync/Default		GPS synchronization signaling, provides power to UGPS module. Default plug port.	RJ11 cable, default plug.
RF Port A	2.4 GHz	-45 degree RF connection to AP antenna	50 ohm RF cable, N-type
	5 GHz	Vertical RF connection to AP antenna	
RF Port B	2.4 GHz	+45 degree RF connection to AP antenna	50 ohm RF cable, N-type
	5 GHz	Horizontal RF connection to AP antenna	
Ground Lugs		For grounding the unit	10 AWG copper wire

PMP/PTP 450 Series interfaces – SM/BH

The PMP 450 Series SM/BH interfaces are illustrated below.

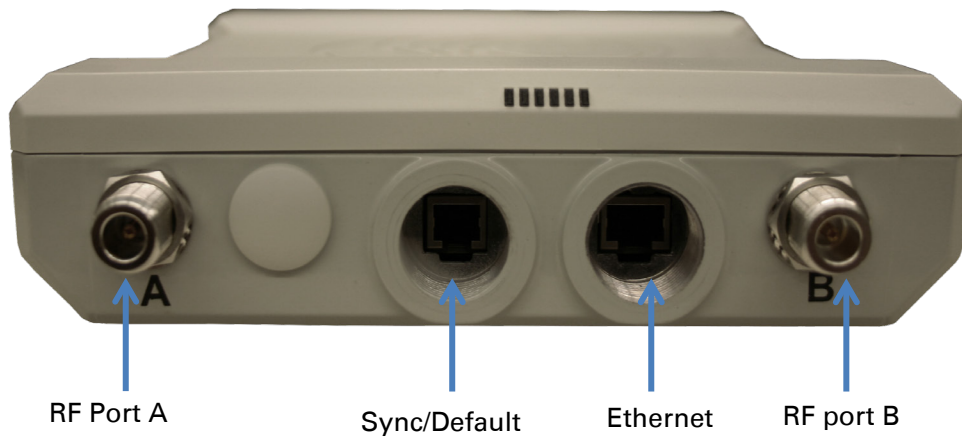
Figure 7 PMP/PTP 450 Series – SM/BH interfaces

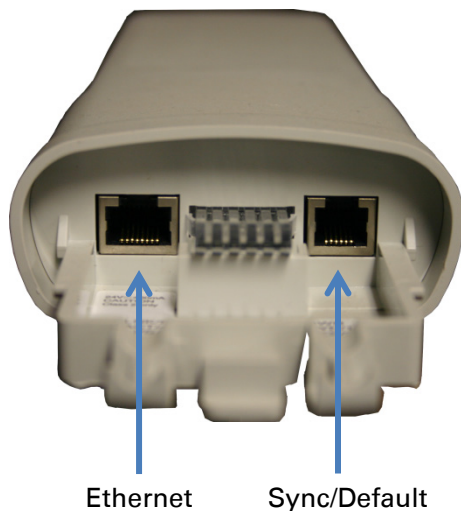

Figure 8 PMP/PTP 450 Series – SM/BH Connectorized interfaces



Note

As per Underwriters Laboratory (UL) guidelines, the Ground Lug on the radiated SM is not required.

Figure 9 PMP 450d Series - SM Integrated Dish



Figure 10 PMP 450 Series – SM 3 GHz Integrated



Figure 11 PTP 450 Series – BHM/BHS



ATEX/HAZLOC variants

PTP/PMP 450i series products are available in ATEX/Hazloc variants for operation in locations where explosive gas hazards exist, as defined by Hazloc (USA) and ATEX (Europe). ATEX/HAZLOC variants are similar to the standard product except that:

- ODUs are supplied with the Full capacity license
- The frequency range is restricted to 4940 MHz to 5850 MHz
- The maximum EIRP generated by ODU is restricted to comply with the ATEX and HAZLOC standards

In order to meet specific radio regulations in the USA, Canada and the EU, Cambium supplies products approved for USA, Canada, EU and the rest of the world under different models and part numbers. These models and part numbers are shown in [Table 62](#) and [Table 63](#).

Diagnostic LEDs

The diagnostic LEDs of 450 Platform Family ODUs are as shown below.



Note

The colors shown in the diagram may differ from the actual color displayed by the AP/BHM, depending on its current status.

AP/BHM LEDs

The diagnostic LEDs report the information about the status of the AP/BHM.

Figure 12 AP/BHM diagnostic LEDs, viewed from unit front











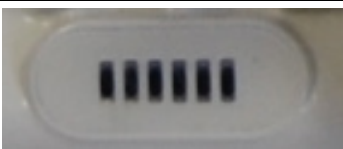









ODU LED Display	LED Labels					
PMP 450m Series - AP						
						
	MAIN LNK+ACT/5	AUX LNK+ACT/4	GPS/3	SES/2	SYN/1	PWR
PMP/PTP 450i Series - AP/BHM						
						
	MAIN LNK/5	ACT/4	GPS/3	SES/2	SYN/1	PWR
PMP/PTP 450 Series - AP/BHM						
						
	MAIN LNK/5	ACT/4	GPS/3	SES/2	SYN/1	PWR

Table 22 AP/BHM LED descriptions

LED	Color when active	Status information provided	Notes
PWR	Red	DC power	Always lit after 10-20 seconds of power on.
SYN/1	Yellow	Presence of sync	-
SES/2	Green	Unused	-
GPS/3	Red	Pulse of sync	Lit when the AP/BHM is getting a sync pulse from a GPS source goes along with SYN/1
ACT/4	For 450 and 450i Series Yellow	Presence of data activity on the Ethernet link	Flashes during data transfer. Frequency of flash is not a diagnostic indication.
AUX LNK + ACT/4	For 450m Series Red/ Green (bi-colored for 10/100)	Aux port link speed and activity	Flashes to indicate Ethernet activity on Aux port. Indicates speed based on the following colors: 10Base-T : Red 100Base-T : Green
MAIN LNK/5	For 450i Series Red/ Green/Orange (bi-colored for 10/100/1000)	Activity on Main port link	Continuously lit when link is present. Indicates speed based on the following colors: 10Base-T : Red 100Base-T : Green 1000Base-T : Orange
	For 450 AP Orange/Green/Yellow (10/100/1000)	Ethernet link	Continuously lit when link is present. 10Base-T : Orange 100Base-T : Green 1000Base-T : Yellow
MAIN LNK + ACT/5	For 450 BHM Green		Continuously lit when link is present. 10Base-T : Green 100Base-T : Green
	For 450m Series Red/ Green/Orange (bi-colored for 10/100/1000)	Main port link speed and activity	Flashes to indicate data transfer speed and activity.

SM/BHS LEDs

The SM/BHS LEDs provide different status of radio based on the operating modes. A SM/BHS in “operating” mode registers and passes traffic normally. A SM/BHS in “aiming” mode does not register or pass the traffic, but displays (via LED panel) the strength of received radio signals (based on radio channel selected via **Tools -> Alignment**).

Figure 13 AP/BH diagnostic LEDs, viewed from unit front



ODU LED Display	LED Labels					
PMP/PTP 450i Series - SM/BHS						
	MAIN LNK/5	ACT/4	GPS/3	SES/2	SYN/1	PWR
PMP 450b Series - SM						
	LNK/SPD/ ACT/4	GPS/3	SES/2	SYN/1	STDBY/ PWR	
PMP/PTP 450 Series - SM/BHS						
	MAIN LNK/5	ACT/4	GPS/3	SES/2	SYN/1	PWR

Table 23 SM/BHS LED descriptions

Status information provided				
LED	Color when active	SM / BHS in "Operating" Mode	SM / BHS in "Aiming" Mode	Notes
PWR	Red			Always lit after 10-20 seconds of power on.
STDBY/ PWR	Yellow/Blue	DC power	DC power	Flashes Yellow during boot-up. Flashes Blue when operating.
SYN/1	Yellow	Presence of sync	These three LEDs act as a bar graph to indicate the relative quality of alignment. As power level improves during alignment, more of these LEDs are lit.	Lit when SM/BHS is in sync with an AP/BHM.
SES/2	Green	Session Indicator		Lit when SM/BHS is in session.
GPS/3	Red	Unused		Unused
ACT/4	Yellow	Presence of data activity on the Ethernet link	Presence of data activity on the Ethernet link	Flashes during data transfer. Frequency of flash is not a diagnostic indication.
LNK/SP D/ACT/4	For 450b Series Red/Green/Orange (10/100/1000)	Ethernet Link	Ethernet Link	Flashes during data transfer. Frequency of flash is not a diagnostic indication. 10Base-T : Red 100Base-T : Green 1000Base-T : Orange
MAIN LNK/5	For 450i Series Red/ Green/ Orange (bi-colored for 10/100/1000)	Ethernet link	Ethernet link	Flashes during data transfer. 10Base-T : Red 100Base-T : Green 1000Base-T : Orange
	For 450 Series Green	Ethernet link	Ethernet link	Continuously lit when link is present.

Operating Mode

- Scanning: If the SM/BHS is not registered to AP/BHM, then these three LEDs cycle on and off from left to right (SYN/1, SES/2 and GPS/3).
- Ethernet Link:
 - For 450m AP, the MAIN LNK + ACT/5 LED is active when the Main port link is present and the AUX LNK + ACT/4 LED is active when the Aux port link is present.
 - For 450/450i AP/BHM, the MAIN LNK/5 LED is lit continuously when the link is present.
 - For 450/450i SM/BHS, the MAIN LNK/5 LED is lit continuously when the link is present.
- Data Transfer:
 - For 450m AP, the MAIN LNK + ACT/5 LED flashes to indicate data transfer speed and activity on the Main port and the AUX LNK + ACT/4 LED flashes to indicate data transfer speed and activity on the Aux port.
 - For 450/450i AP/BHM, the ACT/4 LED flashes during data transfer.
 - For 450/450i SM/BHS, the ACT/4 LED flashes during data transfer.
 - For 450b SM, the LNK/SPD/ACT/4 LED flashes during data transfer.

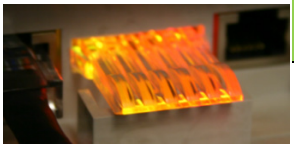
Aiming Mode

The 3 LEDs (SYN/1, SES/2, and GPS/3) are turned into a 3-position bar graph. The more LEDs that are lit, the better the received power the module is seeing. The colors of the LEDs have no particular meaning other than to assist in distinguishing one position from the next.

Power supply options

The 450 Platform Family ODUs are powered over its Main Ethernet cable using Power Over Ethernet (POE). The power injector is connected to the ODU and network terminating equipment using Cat5e cable with RJ45 connectors.

Power supply – PMP 450m Series

The PMP 450m Series - AP supports powering from AC+DC Enhanced Power Injector (see [AC+DC Enhanced Power Injector](#) on page 2-22)

- PSU part numbers

Table 24 PSU part numbers for PMP 450m AP

Cambium description	Cambium part number
AC+DC Enhanced Power Injector	C000065L002C

Power supply – PMP/PTP 450i Series

The PMP/PTP 450i Series supports powering from the following powering sources:

- Power Supply, 60 W, 56 V with 1000BASE-T or GigE
- AC+DC Enhanced Power Injector
- Power over Ethernet midspan, 60 W, -48 VDC Input
- CMM4 with external 56 V power supply and CMM4 to 450i Series ODU cable (Dongle)
- IEEE802.3at power injector



Note

The 900 MHz SM is based off of the 450 Series , please see [Power supply – PMP/PTP 450 Series](#) on page 2-26.



Warning

Always use an appropriately rated and approved AC supply cord-set in accordance with the regulations of the country of use.



Warning

The PMP 450 Ruggedized High Gain Integrated Subscriber Module (Cambium part numbers C035045C014A and C036045C014A), while encapsulated in a 450i-type enclosure, contains 450 circuitry which must be powered via 30 VDC. Powering these SMs with a 56 VDC will damage the device.

Please refer to [Cabling](#) on Page 2-33 for details on maximum cable lengths between power injector and PMP/PTP 450i.

○ PSU part numbers

Table 25 PSU part numbers for PMP/PTP 450i Series

Cambium description	Cambium part number
Power supply, 60 W, 56 V with Gbps support	N000065L001B
AC+DC Enhanced Power Injector	C000065L002C
Line Cord, Fig 8 – US	N000065L003A
Line Cord, Fig 8 – UK	N000065L004A
Line Cord, Fig 8 – EU	N000065L005A
Power over Ethernet midspan, 60 W, -48 VDC Input	N000000L036A
Power supply, 30 W, 56 V – Gbps support	N000000L034A

- **AC Power Injector N000065L001B**

The AC Power Injector interfaces are shown in [Figure 14](#) and described in [Table 26](#).

Figure 14 AC Power Injector interfaces

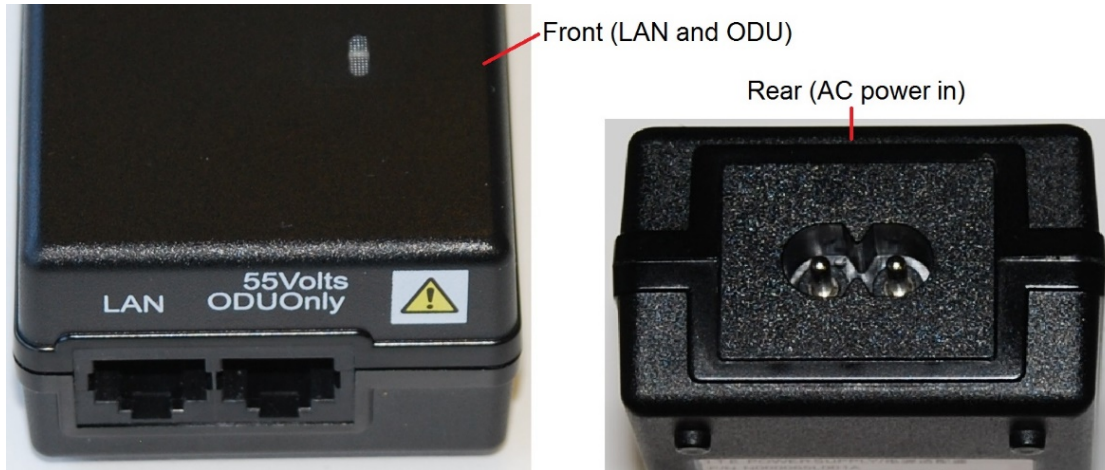

Table 26 AC Power Injector interface functions

Interface	Function
AC power in	AC power input (main supply)
ODU	RJ45 socket for connecting Cat5e cable to ODU
LAN	RJ45 socket for connecting Cat5e cable to network
Power (green) LED	Power supply detection

- **AC+DC Enhanced Power Injector C000065L002C**

The AC+DC Enhanced Power Injector interfaces are shown in [Figure 15](#) and described in [Table 27](#).

Figure 15 AC+DC Enhanced Power Injector interfaces

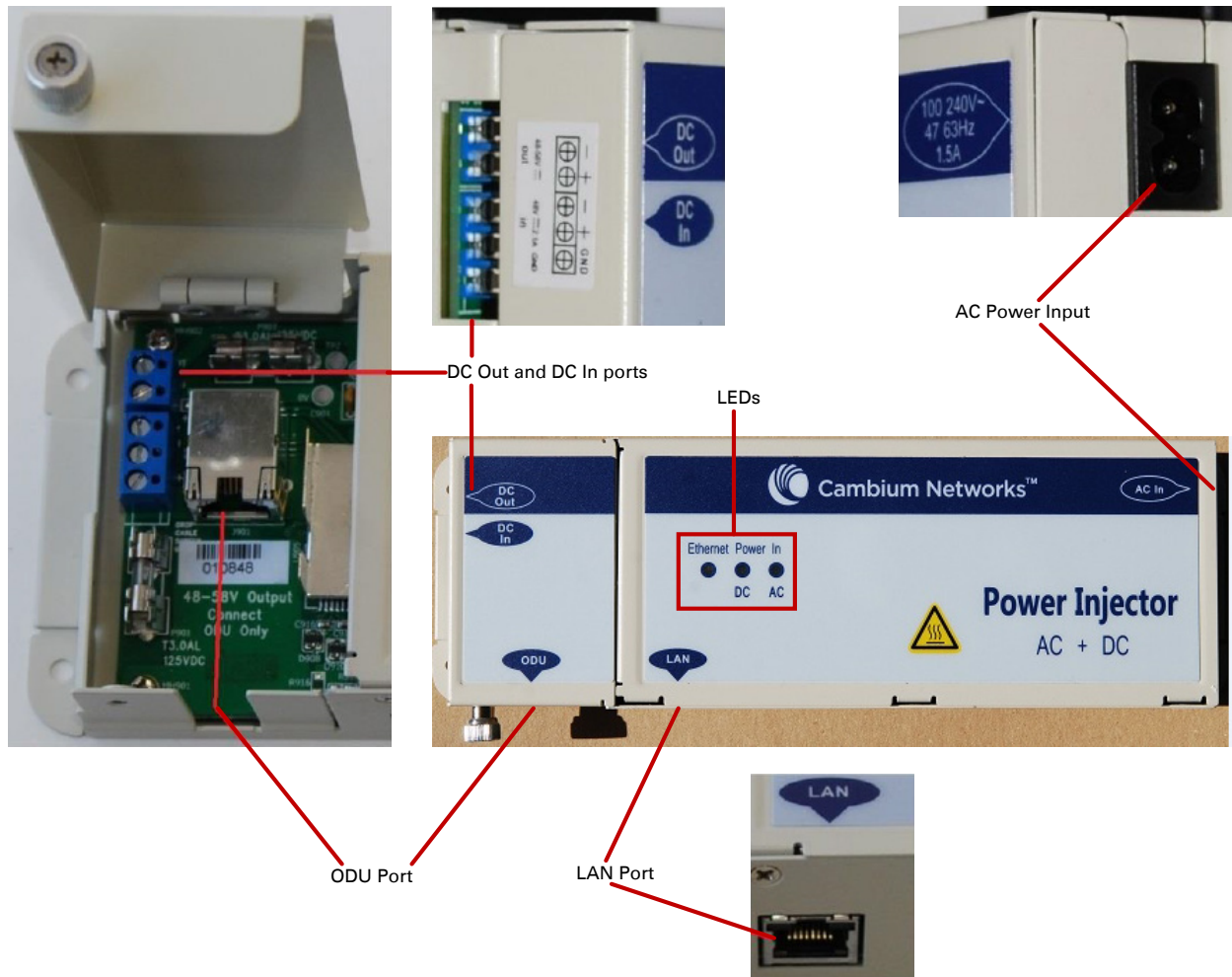

Table 27 AC+DC Enhanced Power Injector interface functions

Interface	Function
100-240V 47-63Hz 1.7A	AC power input (main supply)
DC In	Alternative DC power supply input
DC Out	DC power output to a second PSU (for power supply redundancy) or to a NIDU
ODU	RJ45 socket for connecting Cat5e cable to ODU
LAN	RJ45 socket for connecting Cat5e cable to network
Power - AC (green) LED	Indicates power is applied at the AC power input
Power - DC (green) LED	Indicates power is applied at the DC In port
Ethernet (yellow) LED	Detects Ethernet traffic and it is used with PTP650 and PTP700 families only. It does not operate with the 450 platform products.

**Note**

The earlier power injector models only had a single power LED that combined the AC+DC indications.

- **-48 VDC Power Injector N000000L036A**

The DC Power Injector interfaces are shown in [Figure 16](#) and described in [Table 28](#).

Figure 16 -48 V DC Power Injector interfaces

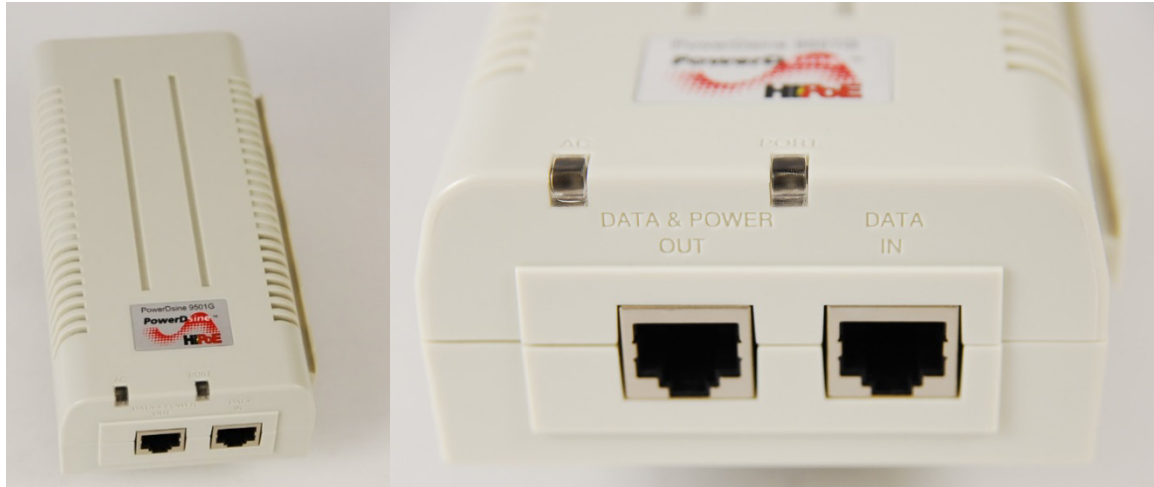

Table 28 -48V DC Power Injector interfaces

Interface	Function
DC input	36 to 60V, 2A
RJ 45 Sockets	Two (Data In and Data & Power Out)
LEDs	Two (AC and Port)

Power supply – PMP 450b Series

The PMP 450b Series support powering from the following powering sources:

- Gigabit Enet Capable Power Supply – 20 to 32 V DC, 15W
- CMM4 with external 29 V power supply

Figure 17 -20 to 32 VDC Power Injector interfaces



Table 29 -Power Injector interfaces

Interface	Function
PSU/Ethernet	20 to 32 VDC, 2A

- PSU part numbers

Table 30 PSU part numbers for PMP 450b SM

Cambium description	Cambium part number
Gigabit Enet Capable Power Supply - 20 - 32VDC, 15W	N000900L001C

Power supply – PMP/PTP 450 Series

The PMP/PTP 450 Series support powering from the following powering sources:

- Gigabit Enet Capable Power Supply – 30 VDC, 15W
- CMM4 with external 29 V power supply



Warning

The PMP 450 Ruggedized High Gain Integrated Subscriber Module (Cambium part numbers C035045C014A and C036045C014A), while encapsulated in a 450i-type enclosure, contains 450 circuitry which must be powered via 30VDC. Powering these SMs with a 56 VDC will damage the device.

○ PSU part numbers

Table 31 PSU part numbers for PMP/PTP 450 Series

Cambium description	Cambium part number
Gigabit Enet Capable Power Supply - 30VDC, 15W	N000900L001C
Cable, UL Power Supply Cord Set, US	N000900L007A
Cable, UL Power Supply Cord Set, EU	N000900L008A
Cable, UL Power Supply Cord Set, UK	N000900L009A
Cable, UL Power Supply Cord Set, Brazil	N000900L010A

○ Gigabit Enet Capable Power Supply

The Gigabit Enet Capable power supply interfaces are described in [Table 32](#). This power supply requires procurement of an AC line cord that connects the outlet of the same (using IEC-60320 Type 5 connector). A list of available power supply cord options from Cambium Networks are given in [Table 31](#).

Table 32 –Gigabit Enet Capable power supply

Interface	Function
AC Input	90-264 VAC, 0.5A rms @120VAC/ 0.25A rms @240VAC, 47 to 63 Hz
DC Output	30.0 Vdc +/-5%, 15W, 500 mA max
RJ 45 Sockets	Two (Data In and Data & Power Out)
LEDs	Green, :LED Intensity determined by Level 5 efficiency

Figure 18 Gigabit Enet Capable power supply



ODU mounting brackets & accessories

The list of supported brackets is provided in [Table 33](#).

- The "Tilt bracket assembly" is the recommended bracket for the AP, SM or BH integrated units.
- The "Mounting Bracket (Connectorized)" can be used where a low profile and ease of assembly of Connectorized AP, SM or BH is required.
- The "Mounting Bracket (Integrated)" provide a wider range of adjustment for AP, SM and BH integrated devices.

Table 33 Accessories part numbers

Cambium description	Cambium part number
Mounting brackets	
Tilt Bracket Assembly	N000045L002A
Mounting Bracket (Integrated)	N000065L031A
Mounting Bracket (Connectorized)	N000065L032A
Miscellaneous	
Ethernet cable adapter for CMM4 (Dongle)	N000045L001A
RJ-45 Gland Spare – PG16 style (QTY 10)	N000065L033A
Blanking Plug Pack (Qty 10)	N000065L036A

Lightning protection

The 450 Platform Family supports the lightning protection units listed in [Table 34](#).

The LPU offers the highest level of protection and is the recommended device. Where low cost deployment is essential, for example for SM in residential application, the Gigabit Surge Suppressor may be used instead.

Table 34 Lightning protection part numbers

Cambium description	Cambium part number
450 Series (Including 450b and 450d)	
Surge Suppressor (30 VDC)	600SSH
450i and 450m Series	
LPU and Grounding Kit (1 kit per ODU)	C000065L007B
Gigabit Surge Suppressor (56 VDC)	C000000L033A

ODU interfaces

PMP 450m Series AP

These interfaces are described in [Table 36](#).

Figure 19 PMP 450m Series - AP rear interfaces

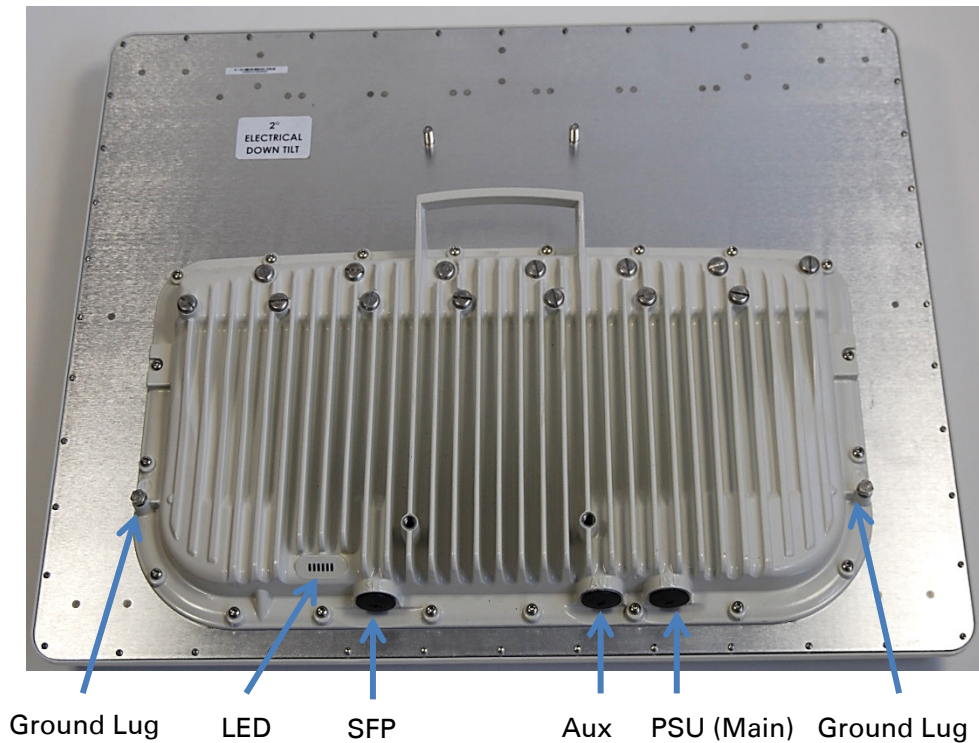

Table 35 PMP 450m Series – AP rear interfaces

Port name	Connector	Interface	Description
PSU (Main)	RJ45	PoE input	Power over Ethernet (PoE).
		10/100/1000 BaseT Ethernet	Data
Aux	RJ45	10/100 BaseT Ethernet	Data
		PoE output	Standard IEEE802.3at PoE.
		Sync input/output	Connection and powering of UGPS Sync input
SFP	SFP	2.5 Gbps Copper and 1 Gbps Fiber Ethernet	Data and Management Services. Plug-in SFP module must be purchased separately.

Ground Lugs	10 AWG copper wire	For grounding the unit
-------------	--------------------	------------------------

PMP/PTP 450i

The Ethernet and Sync/AUX ports are on the rear of the integrated and connectorized ODUs (Figure 20). These interfaces are described in Table 36.

Figure 20 PMP/PTP 450i Series - ODU rear interfaces



Table 36 PMP/PTP 450i Series – ODU rear interfaces

Port name	Connector	Interface	Description
Main PSU	RJ45	PoE input	Power over Ethernet (PoE).
		10/100/1000BASE-T Ethernet	Data
Sync/AUX	RJ45	10/100/1000BASE-T Ethernet	Data (see Note below)
		PoE output	Standard IEEE802.3at PoE.
		Sync input/output	Connection and powering of UGPS Sync input

The front of the connectorized ODU ([Figure 21 PMP/PTP 450i Series – Connectorized ODU antenna interfaces](#)) provides N type female connectors for RF cable interfaces to antennas with ports A and B for vertical and horizontal polarization respectively.

Figure 21 PMP/PTP 450i Series – Connectorized ODU antenna interfaces



PMP 450b

The Ethernet and AUX ports are on the rear of the integrated and connectorized ODUs (Figure 22). These interfaces are described in Table 37.

Figure 22 PMP 450b Series - ODU rear interfaces



Table 37 PMP 450b Series – ODU rear interfaces

Port name	Connector	Interface	Description
PSU/Ethernet Port	RJ45	PoE input	Power over Ethernet (PoE).
		10/100/1000BASE-T Ethernet	Data
Audio AUX Port	Standard 3.5 mm headphones	Alignment tone input	3.5 mm audio jack for alignment tone

Cabling

Ethernet standards and cable lengths

All configurations require a copper Ethernet connection from the ODU (Main PSU port) to the Power supply.

Table 38 PSU drop cable length restrictions

System configuration		Maximum cable length (m/ft)	
		From power supply to ODU	From ODU to PoE device on AUX/SYNC port
Power supply (30W)	None	100 m	N/A
	IEEE 802.3at Type 2	Not supported	
AC Power Injector (60W)	None	100 m	N/A
	IEEE 802.3at Type 2	100 m in total	
AC+DC enhanced Power Injector	None	100 m	N/A
	IEEE 802.3at Type 2	100 m in total	
-48 V DC power injector	None	100 m	N/A
	IEEE 802.3at Type 2	100 m in total	
CMM4 with 56 V supply	None	100 m	N/A
	IEEE 802.3at Type 2	Not supported	
IEEE802.3at compliant supply	None	100 m	N/A
	IEEE 802.3at Type 2	Not supported	



Note

The Ethernet connectivity for CMM4 requires the part "Ethernet cable adapter for CMM4 – N000045L001A".

Outdoor copper Cat5e Ethernet cable

Outdoor Cat5e cable is used for all connections that terminate outside the building. For example, connections between the ODU, surge suppressors (if installed), UGPS receivers (if installed) and the power supply injector. This is known as a “drop cable” (Figure 23).

The following practices are essential to the reliability and longevity of cabled connections:

- Use only shielded cables and connectors to resist interference and corrosion.
- For vertical runs, provide cable support and strain relief.
- Include a 2 ft (0.6 m) service loop on each end of the cable to allow for thermal expansion and contraction and to facilitate terminating the cable again when needed.
- Include a drip loop to shed water so that most of the water does not reach the connector at the device.
- Properly crimp all connectors.
- Use dielectric grease on all connectors to resist corrosion.

Order Superior Essex type BBDGe cable from Cambium Networks (Table 39). Other lengths of this cable are available from Superior Essex.

Figure 23 Outdoor drop cable

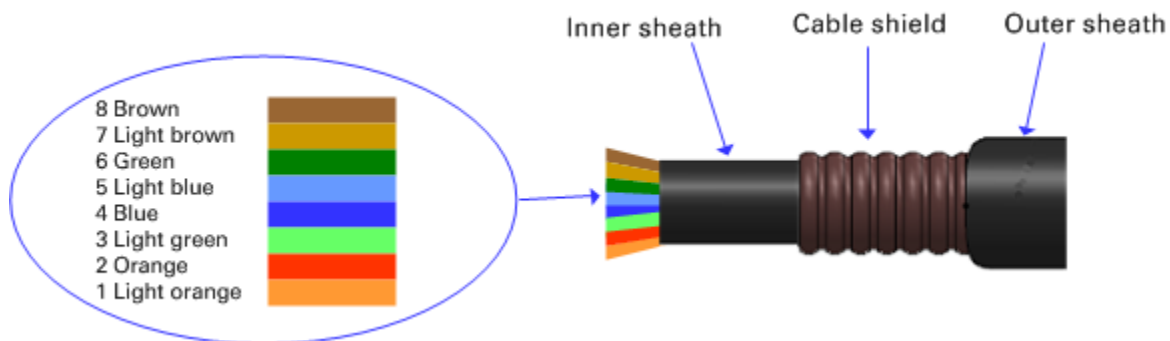

Table 39 Drop cable part numbers

Cambium description	Cambium part number
1000 ft Reel Outdoor Copper Clad CAT5E	WB3175
328 ft (100 m) Reel Outdoor Copper Clad CAT5E	WB3176

SFP module kits

SFP module kits allow connection of a PMP 450 Series ODU to a network over an Optical Gigabit Ethernet interface (1000BASE-LX or 1000BASE-SX) full-duplex mode.



Note

PMP 450m supports Fiber SFPs from system release 15.0.3.

Order SFP module kits from Cambium Networks ([Table 40](#)).

Table 40 SFP module kit part numbers

Cambium description	Cambium part number
Single Mode Optical SFP Interface per ODU	C000065L008A
Multi-mode Optical SFP Interface per ODU	C000065L009A
2.5GBASE-T Copper SFP Interface per ODU	C000065L011A

To compare the capabilities of the two optical SFP modules, refer to [Table 41](#) and [Table 42](#).

Table 41 Single Mode Optical SFP Interface per ODU (part number C000065L008)

Core/ cladding (microns)	Mode	Bandwidth at 1310 nm (MHz/km)	Maximum length of optical interface	Insertion loss (dB)
62.5/125	Multi	500	550 m (1800 ft)	1.67
50/125	Multi	400	550 m (1800 ft)	0.07
50/125	Multi	500	550 m (1800 ft)	1.19
10/125	Single	N/A	5000 m (16400 ft)	0.16

Table 42 Multi-mode Optical SFP Interface per ODU (part number C000065L009)

Core/ cladding (microns)	Mode	Bandwidth at 850 nm (MHz/km)	Maximum length of optical interface	Insertion loss (dB)
62.5/125	Multi	160	220 m (720 ft)	2.38
62.5/125	Multi	200	275 m (900 ft)	2.6
50/125	Multi	400	500 m (1640 ft)	3.37
50/125	Multi	500	550 m (1800 ft)	3.56

The upgrade kits contain the following components:

- Optical SFP transceiver module (Figure 24)
- Long EMC strain relief cable gland (Figure 25)
- The *Ethernet SFP Module Installation Guide*
- License key instructions and an entitlement key

Figure 24 Optical SFP transceiver module

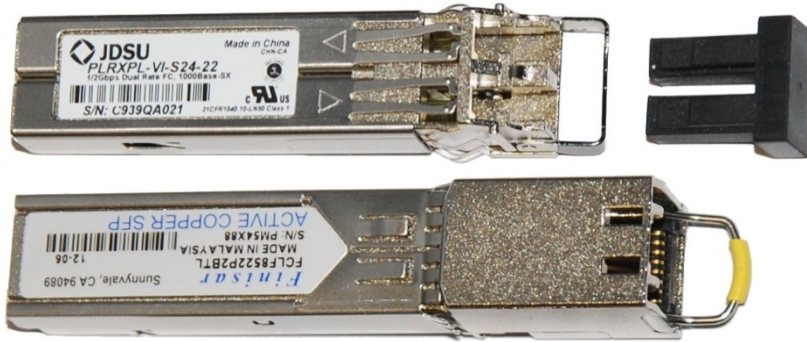

Figure 25 Long cable gland



Main Ethernet port

The PoE cable pinout diagram for Main port is given below.

Table 43 Main port PoE cable pinout

RJ45 pin	Interface	Ethernet description	PoE input description
1	1000 BaseT Ethernet with PoE In	+TxRx0	+Ve or -Ve
2		-TxRx0	
3		+TxRx1	+Ve or -Ve
6		-TxRx1	
4		+TxRx2	+Ve or -Ve
5		-TxRx2	
7		+TxRx3	+Ve or -Ve
8		-TxRx3	



Note

The PoE input on the Main port accepts any polarity.

Aux port

Table 44 Aux port PoE cable pinout

RJ45 pin	Interface	Signal description	PoE output description
1	100 BaseT Ethernet with PoE Out (see note below)	+TxRx0	-Ve
2		-TxRx0	
3		+TxRx1	+Ve
6		-TxRx1	
4	GPS and alignment tone	GPS power out, Alignment tone out, GPS data out	N/A
5		GPS data in	
7		GPS 0v	
8		GPS Sync in	

**Note**

PMP 450m Series - AP Aux port supports only alignment and sync functionalities in current 15.0/15.0.3 release.

**Note**

If the Aux port will be used, a second Ethernet gland will need to be ordered (Part Number: N000065L033A).

Aux port to alignment tone headset wiring

A standard 32 ohms stereo headset can be connected to the AUX port to use the audio alignment tool. The diagrams of the adapters for RJ45 and RJ12 are provided in [Figure 26](#) and [Figure 27](#) respectively. The recommended values for both resistors are 220 ohm, 0.25W. Different resistor values can be used to optimize the level of the audio signal depending on the headset characteristics and the level of ambient noise.

Figure 26 Alignment Tone Cable

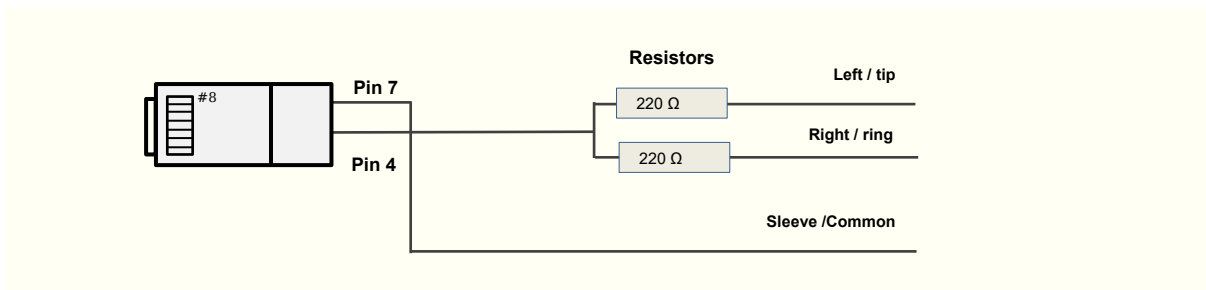
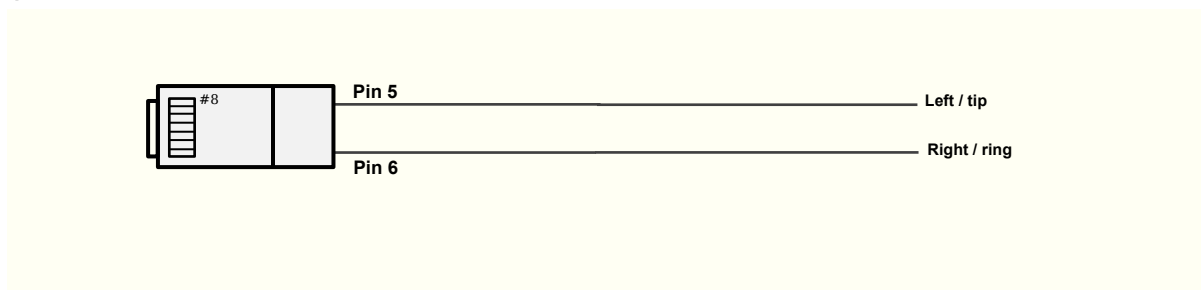

Table 45 Aux port PoE cable pinout

RJ45 pin (AUX port)	Signal description	Serial component	Jack socket (to jack plug of headset)
4	Alignment tone out	220 ohms resistor	Ring
		220 ohm resistor	Tip
7	GPS 0v	None	Sleeve

Figure 27 RJ12 Alignment Tone Cable**Table 46** RJ12 Aux port PoE cable pinout

RJ12 pin (AUX port)	Signal description	Jack socket (to jack plug of headset)
5	Alignment tone out	Tip
6	Alignment tone out	Ring

Alternatively, a readymade headset adapter can be ordered from Best-Tronics (<http://btpa.com/Cambium-Products/>) with the following part number:

Table 47 Alignment tone adapter third party product details

Reference	Product description
BT-1277	Headset alignment cable (RJ-45) for the PMP/PTP 450i Series products
BT-0674	Headset alignment cable (RJ-12) for the PMP/PTP 450 Series products.

RJ45 connectors and spare glands

RJ45 connectors are required for plugging Cat5e cables into ODUs, LPUs, PSUs and other devices. Order RJ45 connectors and crimp tool from Cambium Networks ([Table 48](#)).

The ODU is supplied with one environmental sealing gland for the drop cable. This gland is suitable for cable diameters from 5 mm to 9 mm.

Figure 28 Cable gland (part number #N000065L033)





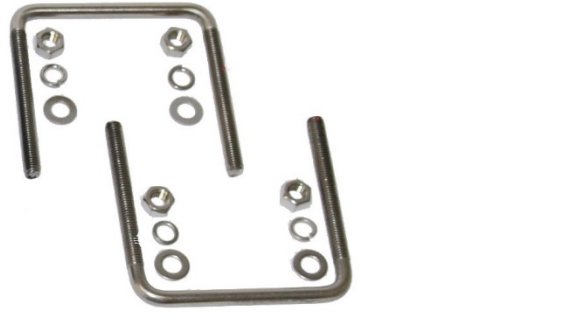



Table 48 RJ45 connector and spare gland part numbers

Cambium description	Cambium part number
Tyco/AMP, Mod Plug RJ45, 100 pack	WB3177
Tyco/AMP Crimp Tool	WB3211
RJ-45 Spare Grounding Gland - PG16 size (Qty. 10)	N000065L033

Lightning protection unit (LPU) and grounding kit

450i and 450m Series LPUs provide transient voltage surge suppression for ODU installations. Each cable requires two LPUs, one near the ODU and the other near the linked device, usually at the building entry point (Table 49).

Table 49 LPU and grounding kit contents

<p>Lightning protection units (LPUs) LPU grounding point nuts and washers</p> 	<p>ODU to top LPU drop cable (600 mm) EMC strain relief cable glands</p> 
<p>U-bolts, nuts and washers for mounting LPUs</p> 	<p>ODU to top LPU ground cable (M6-M6)</p> 
<p>Bottom LPU ground cable (M6-M10)</p> 	<p>ODU to ground cable (M6-M10)</p> 

One LPU and grounding kit (Table 49) is required for the PSU drop cable connection to the ODU. If the ODU is to be connected to an auxiliary device, one additional LPU and grounding kit is required for the Aux drop cable. Order the kits from Cambium Networks (Table 50).

Table 50 LPU and grounding kit part number

Cambium description	Cambium part number
Aux ports LPU and Grounding Kit (One Kit Per End)	C000065L007B

Cable grounding kit

Copper drop cable shields must be bonded to the grounding system in order to prevent lightning-strike arcing (resulting in fire risk and damage to equipment).

One grounding kit (Figure 29) is required for each grounding point on the cable. Order cable grounding kits from Cambium Networks (Table 51).



Caution

To provide adequate protection, all grounding cables must be a minimum size of 10 mm² csa (8AWG), preferably 16 mm² csa (6AWG), or 25 mm² csa (4AWG).

Figure 29 Cable grounding kit



Table 51 Cable grounding kit part numbers

Cambium description	Cambium part number
Cable Grounding Kits For 1/4" And 3/8" Cable	01010419001

Antennas and antenna cabling

Antenna requirements

Each connectorized ODU requires one external antenna (normally dual-polar).

For connectorized units operating in the USA or Canada 900 MHz, 4.9 GHz, 5.1 GHz, 5.2 GHz, 5.4 GHz or 5.8 GHz bands, choose external antennas which are recommended by Cambium Networks. Do not install any other antennas.

Supported external AP antennas

The recommended AP external antennas are listed in [Table 52](#).

Table 52 List of AP external antennas

Cambium description	Cambium part number
900 MHz 13 dBi 65 degree Sector Antenna (Dual Slant)	N009045D001A
5 GHz Horizontal and Vertical Polarization Antenna for 90 Degree Sector	85009324001
5 GHz Horizontal and Vertical Polarization Antenna for 90°/120° Degree Sector	A005365



Note

LINKPlanner, Cambium Networks, planning tool, contains an up-to-date, exhaustive list of antennas that can be used with Cambium Products.

Supported external BH/SM antenna

The recommended PTP 450i Series BH or PMP 450/450i Series SM external antenna is listed in [Table 53](#).

Table 53 PTP 450i Series BH or PMP 450/450i Series SM external antenna

Cambium description	Cambium part number
NH Microwave, 12dbi 900 MHz Dual Slant Yagi Antenna	N009045D003A
Cambium, 5GHz 38.4dBi 6FT 5GHz Single-Pol Parabolic PTP Antenna	N050067D019A
Cambium, 5GHz 37.9dBi 6FT 5GHz Dual-Pol Parabolic PTP Antenna	RDH4506B
Andrew, 5GHz 35.3dBi 4-foot Dual-Pol Parabolic, PX4F-52	RDG4453
Cambium, 5GHz 34.9dBi 4FT 5GHz Single-Pol Parabolic PTP Antenna	N050067D018A

Cambium, 5GHz 34.9dBi 4FT 5GHz Dual-Pol Parabolic PTP Antenna	RDH4505B
Cambium, 5GHz 32.5dBi 3FT 5GHz Single-Pol Parabolic PTP Antenna	RDH4513B
Cambium, 5GHz 32.3dBi 3FT 5GHz Dual-Pol Parabolic PTP Antenna	RDH4504B
Cambium, 5GHz 29dBi 2FT 5GHz Single-Pol Parabolic PTP Antenna	N050067D017A
Cambium, 5GHz 28.8dBi 2FT 5GHz Dual-Pol Parabolic PTP Antenna	RDH4503B

RF cable and connectors

RF cable of generic type LMR-400 is required for connecting the ODU to the antenna. N type male connectors are required for connecting the RF cables to the connectorized ODU. Two connectors are required per ODU. Use weatherproof connectors, preferably ones that are supplied with adhesive lined heat shrink sleeves that are fitted over the interface between the cable and connector. Order CNT-400 RF cable and N type male connectors from Cambium Networks ([Table 54](#)).

Table 54 RF cable and connector part numbers

Cambium description	Cambium part number
50 Ohm Braided Coaxial Cable - 75 meter	30010194001
50 Ohm Braided Coaxial Cable - 500 meter	30010195001
RF Connector, N, Male, Straight for CNT-400 Cable	09010091001

Antenna accessories

Connectorized ODUs require the following additional components:

- Cable grounding kits: Order one cable grounding kit for each grounding point on the antenna cables. Refer to [Lightning protection unit \(LPU\) and grounding kit on 2-41](#)
- Self-amalgamating and PVC tape: Order these items to weatherproof the RF connectors
- Lightning arrestors: When the connectorized ODU is mounted indoors, lightning arrestors (not LPUs) are required for protecting the antenna RF cables at building entry. One arrestor is required per antenna cable. One example of a compatible lightning arrestor is the Polyphaser LSXL-ME or LSXL (not supplied by Cambium Networks).

GPS synchronization

GPS synchronization description

Cambium offers GPS synchronization to limit the network's own self-interference. The Cluster Management CMM provides Global Positioning System (GPS) synchronization to the Access Point (AP) and all associated Subscriber Modules (SM). Network operators have a choice of UGPS and CMM solutions to select the option that works best for the environment.

Universal GPS (UGPS)

The UGPS provides network synchronization for smaller networks where a CMM may not be cost effective. The UGPS provides synchronization for one or two modules so that even remote areas at the edge of the network can operate with synchronization for improved performance. The UGPS works with all Cambium PMP radios. The UGPS has a small footprint and is easy to deploy.

Figure 30 UGPS

**Note**

PMP 450/450i/450m Series - APs can power up a UGPS via the Aux/Timing port.

**Note**

PMP 450i/450b/450m Series - If two units are to get sync from the UGPS, then an external power supply is required.

If the GPS position information is required to be visible on the web GUI, then the UGPS power must be enabled on the AP; and it is safe to use both AP power and external power for a single UGPS unit.

CMM5

The CMM5 (Cluster Management Module) is the latest generation of solutions for the distribution of TDD Sync signals and “Power-over-Ethernet (PoE)” in the field. The CMM5 is a modular design with individual 4-port power injectors and an optional controller used for remote management.

Key features of the CMM5 include:

- Support for Gigabit Ethernet (1000BaseT)
- Modular and scalable from 4 ports to 32 ports
- Direct +/- 48VDC input (optional AC/DC power supplies are available from Cambium Networks)
- Uses Cambium Networks UGPS for a synchronization source
- Dual resilient power inputs
- Rack mountable
- Secure remote management when used with the optional CMM5 Controller Module
- Support for PMP 450m (cnMedusa™)
- Future support for integration into (cnMedusa™) for cloud or NOC-based management

It consists of four subsystems, described in the following sections:

- CMM5 Controller Module
- CMM5 Injector (29 volt and 56 volt versions)
- Power supply(s) (240/600 watt)
- UGPS

Cluster Management: Scenario 1

The following is a CMM5 Cluster Management scenario using four PMP 450i Access Points.

Table 55 CMM5 Cluster Management Scenario 1

Scenario	Equipment Needed	Features
Four PMP 450i Access Points	56 Volt Injector	<ul style="list-style-type: none"> • Gigabit Ethernet • Local Management Interface • +/- 48VDC Input • Broad Device Support • Rack Mountable
<ul style="list-style-type: none"> • 48 VDC Available • No management or resilience required 	UGPS	-

Figure 31 Cluster Management: Scenario 1

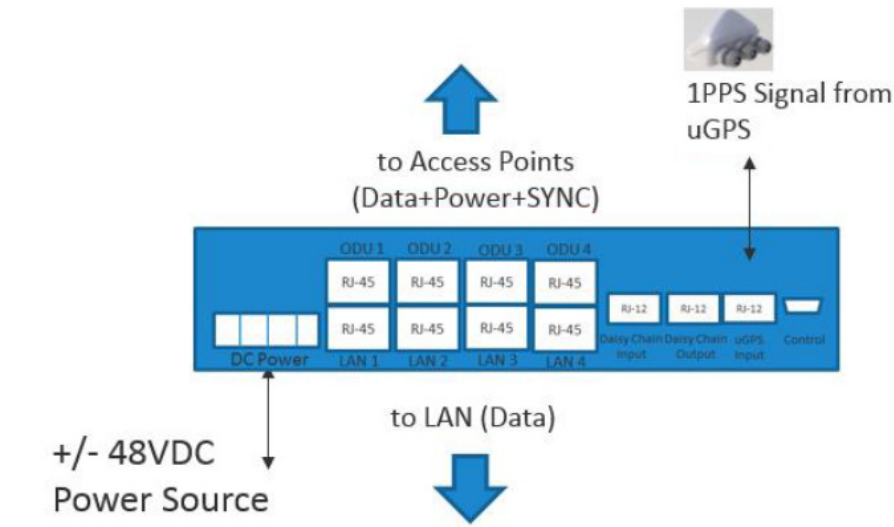

Cluster Management: Scenario 2

The following is a CMM5 Cluster Management scenario using four PMP 450i Access Points and four PMP 450 Access Points.

Table 56 CMM5 Cluster Management Scenario 2

Scenario	Equipment Needed	Features
Four PMP 450i Access Points Four PMP 450 Access Points	<ul style="list-style-type: none"> • 56 Volt Injector • 29 Volt Injector • 1 CMM5 Controller • One UGPS 	<ul style="list-style-type: none"> • Gigabit Ethernet support • Local Management Interface • +/- 48VDC Input • Broad Device Support • Rack Mountable
AC only environments	Two UGPS AC-to-48 VDC Power Supplies	Resilient power sources
Management required Resilience required	-	Secure, Remote Management (https) Scalable to 32 devices

Figure 32 Cluster Management: Scenario 2

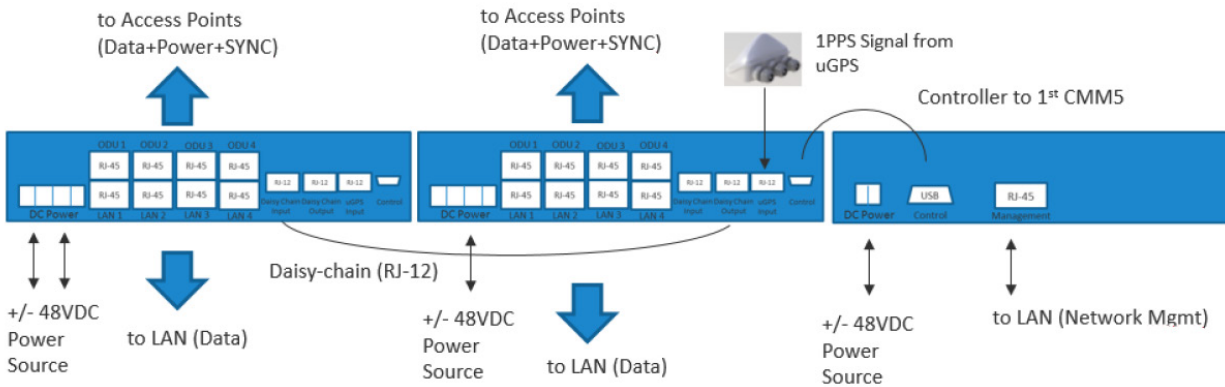

CMM5 Controller Module

The major features of the CMM5 Controller Module are:

- Auto-detect/control up to 8 Power Injectors
- Monitor SYNC/Power/GPS status
- Manage (up/down ports)
- Web (HTTPS) and SNMPv2/v3 management (SNMP on roadmap)
- 1U/ half-width rack-mount

Figure 33 Controller Module



CMM5 Injector Module

The CMM5 Injector Module has the following features:

- Stand-alone mode or used with controller for mgmt.
- +/- 48VDC input with green/amber LED's for status
- Injects SYNC pulse from UGPS
- 2U / half-width rack-mount



Note

There are two different versions of the injector module (56V and 29V). You must select the correct injector for the types of radios that you will be powering. In both cases, the injectors use the same input power supplies or can be powered with +/- 48VDC. The output power is different and the type of SYNC signal used is different between the two types of injectors. Systems can have 29V and 56V injectors deployed alongside each other.

Figure 34 Injector Module

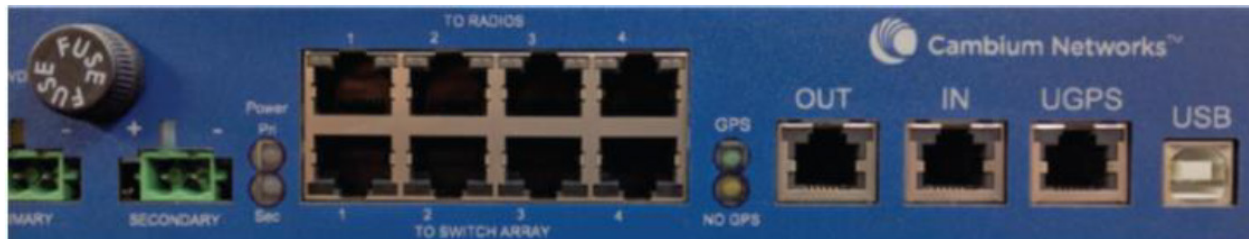

CMM5 Injector Compatibility Matrix

The following table provides the Injector compatibility matrix.

Table 57 Injector Compatibility Matrix

Product	Power/Injector Module	Sync
PMP 450m	Yes/56V	Yes
PMP/PTP 450i	Yes/56V	Yes
PMP 450b	Yes/29V	Yes
PMP 450/PTP 450	Yes/29V	Yes
PMP 100/PTP 100	Yes/29V	Yes

CMM5 Specifications

The following table provides specifications for the CMM5 Power & Sync Injector (56 Volts).

Table 58 CMM5 Specifications

CMM5 Power and Sync Injector 56 Volts	
Model Number	C000000L556A
Data Interface	4 each RJ45 Gigabit Powered output ports "To Radios" 4 each RJ45 Gigabit Data input ports "To Switch Array" 1 each GPS timing port (RJ-12) 1 each CMM5 USB Serial port for local administration 1 each RJ12 Daisy Chain port "IN" 1 each RJ12 Daisy Chain port "OUT"
Surge Suppression	Lightning Suppression for each "To Radios" RJ45 Port
Power	Input Voltage: + or - 48 VDC Input Power Consumption: 400 watts Output Voltage: + or - 55 VDC Output Current: 0 - 1.8A per channel Output Power: 0 - 90 Watts per channel
Cabinet Temperature	-40° C to +55°C (-40° F to +131° F), 90% humidity, condensing
Physical	Max Distance from Managed Radios: 328 cable feet (100m) Max Distance to GPS Antenna: 100 cable feet (30.5m)
Dimensions	8.85" W x 15.75" D x 1.65" H (225mm x 400mm x 42mm)
Unit Weight	6.6 pounds (3kg)
Power Interface Terminals	2 Power input ports for 48 VDC Power (Power supplies sold separately)

CMM4 (Rack Mount)

The Cluster Management Module (CMM) is the heart of the Cambium system's synchronization capability, which allows network operators to reuse frequencies and add capacity while ensuring consistency in the quality of service to customers.

For operators who prefer indoor CMM mounting, Cambium offers the Rack-Mounted Cluster Management Module 4. The unit is designed to be mounted onto a standard 19-inch telecommunications rack and to allow the Cambium CMM4 to be co-located with other telecommunications equipment.

Figure 35 CMM4 (Rack Mount)

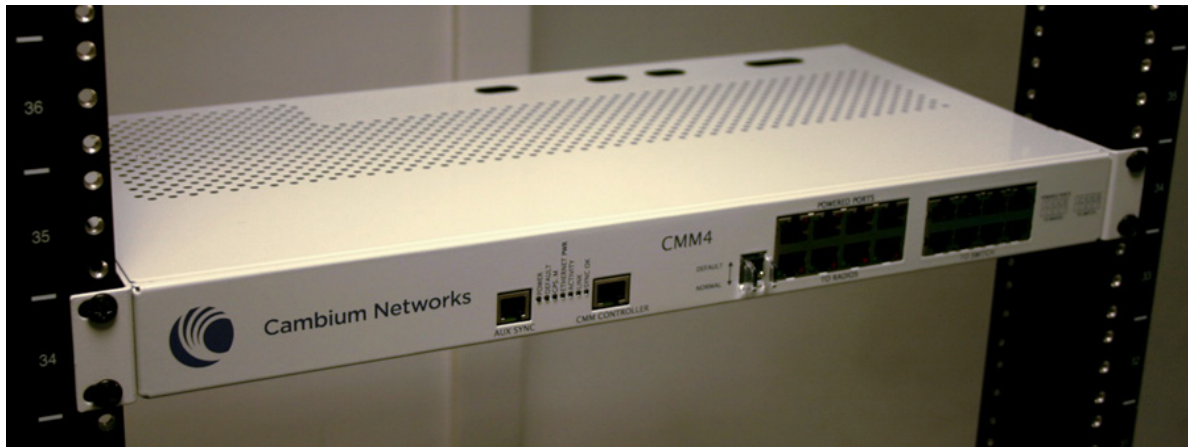

The CMM4 has two DC power inputs, one 29 V and one 56V. It can be used to power and synchronize both 29 V legacy products such as the PMP 450 Series and 56V products such as the PMP 450i Series simultaneously.

If the 29 V legacy products are connected to the CMM4, a 29 V power supply needs to be connected.

If the 450i Series is connected to the CMM4, a 56 V power supply needs to be connected. The CMM4 supports having two of the 56 V and two of the 29 V supplies for redundancy.



Warning

PMP 450i Series requires different wiring between the CMM4 and device. If a PMP450 Series ODU is replaced by a PMP 450i Series and the existing drop cable needs to be re-used, the Ethernet cable adapter for CMM4 - N000045L001A" must be used between the CMM4 and the existing drop cable.

Figure 36 CMM4 56 V power adapter (dongle)



CMM4 56 V power adapter cable pinout

Figure 37 CMM4 power adapter cabling diagram

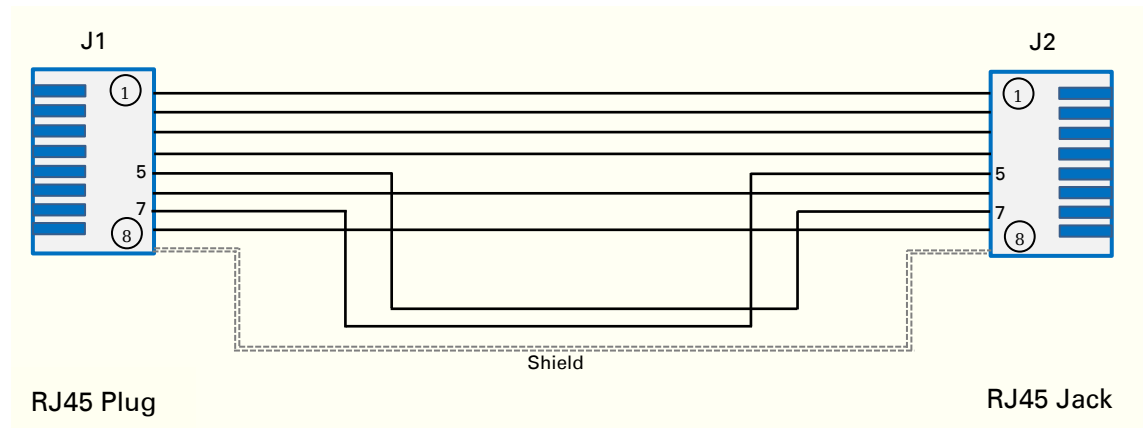

Table 59 CMM4 power adapter cable pinout

Plug J1 pin	Jack J2 pin
1	1
2	2
3	3
4	4
5	7
6	6
7	5
8	8
Screen	Screen



Note

Pins 5 and 7 are wired in a cross-over configuration.

CMM4 (Cabinet with switch)

Designed to deliver consistent and reliable wireless broadband service, the PMP/PTP system gracefully scales to support large deployments. The cluster management module is the heart of the system's synchronization capability which allows network operators to re-use frequencies and add capacity while ensuring consistency in the quality of service to customers. As a result, subscribers can experience carrier-grade service even at the outer edge of the network.

Figure 38 CMM4 (Cabinet with switch)



CMM4 (Cabinet without switch)

This CMM4 includes all the functionality listed above but there is no switch. This provides the network operator the flexibility to use the switch of their choice with the power and synchronization capabilities of the CMM4.

CMM3/CMMmicro

The CMM3 or CMMmicro (Cluster Management Module micro) provides power, GPS timing, and networking connections for an AP cluster. The CMM3 is configurable through a web interface.

The CMM3 contains an 8-port managed switch that supports Power over Ethernet (PoE – this is Cambium PoE, not the standard PoE) on each port and connects any combination of APs, BHMs, BHSs, or Ethernet feed. The Cambium fixed wireless broadband IP networks PoE *differs from* IEEE Standard 803.3af PoE, and the two should not be intermixed. The CMM3 can auto-negotiate speed to match inputs that are either 100Base-TX or 10Base-T, and either full duplex or half duplex, where the connected device is set to auto-negotiate. Alternatively, these parameters are settable.

A CMM3 requires only one cable, terminating in an RJ-45 connector, for each connected module to distribute

- Ethernet signaling.
- power to as many as 8 co-located modules—APs, BHMs, or BHSs. Through a browser interface to the managed switch, ports can be powered or not.
- sync to APs and BHMs. The CMM3 receives 1-pulse per second timing information from Global Positioning System (GPS) satellites through an antenna (included) and passes the timing pulse embedded in the 24-V power to the connected modules.

GPS status information is available at the CMM3, however

- CMM3 provides time and date information to BHMs and APs if both the CMMmicro is operating on CMMmicro Release 2.1 or later and the AP/BHM is operating on System Release 4.2 or later. See [Configuring time settings](#) on Page 7-18.
- CMM3 *does not* provide time and date information to BHMs and APs if either the CMM3 is operating on a release earlier than CMMmicro Release 2.1 or the AP/BHM is operating on a release earlier than System Release 4.2.

A CMM3/CMMMicro is shown in [Figure 39](#) and [Figure 40](#).

Figure 39 CMM3



Figure 40 Pole mounted CMM3



Note

A CMM3 cannot be used to power up a 450i or 450m Series ODUs.

Installing a GPS receiver

To install a GPS receiver as the timing reference source, use the following procedures:

- [Mounting the GPS receiver](#) on page 2-58
- [Cabling the GPS Antenna](#) on page 2-59
- [Installing and connecting the GPS LPU](#) on page 2-59

**Caution**

Prior to power-up of equipment, ensure that all cables are connected to the correct interfaces of the CMM4 unit and the UGPS receiver module. Failure to do so may result in damage to the equipment.

GPS receiver location

Mount the GPS receiver at a location that meets the following requirements:

- It must be possible to protect the installation as described in [Grounding and lightning protection](#) on page 3-8.
- It must have an un-interrupted view of at least half of the southern (resp. northern) sky in the northern (resp. southern) hemisphere. For a receiver mounted on a wall there must be no other significant obstructions in the view of the sky.
- It must be mounted at least 1 m (3 ft), preferably 2 m (6 ft), away from other GPS receiving equipment.
- It must not be sited in the field of radiation of co-located radio communications equipment and should be positioned at a distance of at least 3 m (10 ft) away.

Mount the UGPS receiver on the wall of the equipment building if there is a suitable location on the wall that can meet these requirements.

**Caution**

The GPS receiver is not approved for operation in locations where gas hazards exist, as defined by HAZLOC (USA) and ATEX (Europe).

Mounting the GPS receiver module on the equipment building

If mounting the GPS receiver on the equipment building ([Figure 45](#)), select a position on the wall that meets the following requirements:

- It must be below the roof height of the equipment building or below the height of any roof-mounted equipment (such as air conditioning plant).
- It must be below the lightning air terminals.
- It must not project more than 600mm (24 inches) from the wall of the building.

If these requirements cannot all be met, then the module must be mounted on a metal tower or mast.

Mounting the GPS receiver module on a metal tower or mast

If mounting the GPS receiver module on a metal tower or mast (Figure 46), select a position that meets the following requirements:

- It must not be mounted any higher than is necessary to receive an adequate signal from four GPS satellites.
- It must be protected by a nearby lightning air terminal that projects farther out from the tower than the GPS receiver module.

Mounting the GPS receiver

Mount the UGPS receiver (following manufacturer's instructions) upon either an external wall (Figure 45) or a metal tower or mast (Figure 46).

Figure 41 GPS antenna mounting

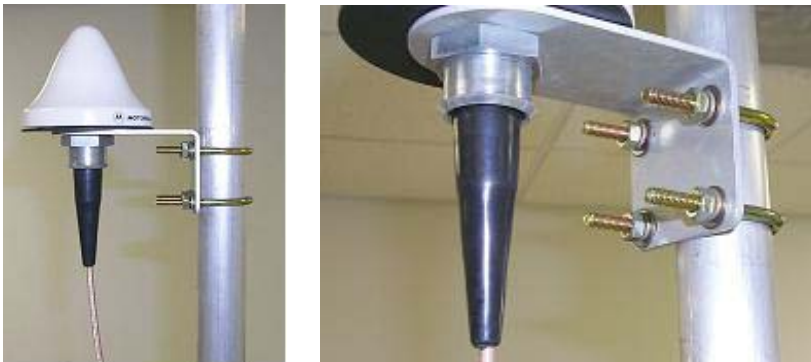

Procedure 1 Mounting the GPS receiver

- 1 Ensure that the mounting position
 - has an unobstructed view of the sky to 20° above the horizon.
 - is not the highest object at the site. (The GPS antenna does not need to be particularly high on a site, which would give it more exposure to lightning. It just needs to have an unobstructed view of the sky.)
 - is not further than 100 feet (30.4 meters) of cable from the CMM.
- 2 Select a pole that has an outside diameter of 1.25 to 1.5 inches (3 to 4 cm) to which the GPS antenna bracket can be mounted.
- 3 Place the U-bolts (provided) around the pole as shown in [Figure 43](#).
- 4 Slide the GPS antenna bracket onto the U-bolts.
- 5 Slide the ring washers (provided) onto the U-bolts.
- 6 Slide the lock washers (provided) onto the U-bolts.
- 7 Use the nuts (provided) to securely fasten the bracket to the U-bolts.

Please refer to the *PMP Synchronization Solutions User Guide* located on the Cambium website (<http://www.cambiumnetworks.com/resources/pmp-synchronization-solutions>).

Cabling the GPS Antenna

Connect the GPS coax cable to the female N-connector on the GPS antenna. Please refer to the *PMP Synchronization Solutions User Guide* located on the Cambium website (<http://www.cambiumnetworks.com/resources/pmp-synchronization-solutions>).

Installing and connecting the GPS LPU

Install and ground the GPS drop cable LPU at the building (or cabinet) entry point, as described in [Install the bottom LPU](#) on page 6-21.

Ordering the components

This section describes how to select components for 450m Series, 450i Series and 450 Series Greenfield network or 450m/450i Series network migration. It specifies Cambium part numbers for 450 Platform Family components.

Order PMP 450m Series, PMP/PTP 450i Series and PMP/PTP 450 Series ODUs from Cambium Networks.

PMP 450m

Table 60 PMP 450m Series ODU part numbers

Cambium description	Cambium part number
PMP 450m AP (Access Point)	
5 GHz PMP 450m Integrated Access Point, 90 Degree (ROW)	C050045A101A
5 GHz PMP 450m Integrated Access Point, 90 Degree (FCC)	C050045A102A
5 GHz PMP 450m Integrated Access Point, 90 Degree (EU)	C050045A103A
5 GHz PMP 450m Integrated Access Point, 90 Degree (DES Only)	C050045A104A
5 GHz PMP 450m Integrated Access Point, 90 Degree (IC)	C050045A105A

PMP 450i

Table 61 PMP 450i Series ODU part numbers

Cambium description	Cambium part number
PMP 450i AP (Access Point)	
900 MHz PMP 450i Connectorized Access Point	C009045A001A
3 GHz PMP 450i Connectorized Access Point	C030045A001A
3 GHz PMP 450i Integrated Access Point, 90 Degree	C030045A002A
3 GHz PMP 450i Connectorized Access Point, DES Only	C030045A003A
3 GHz PMP 450i Integrated Access Point, 90 Degree, DES Only	C030045A004A
5 GHz PMP 450i Connectorized Access Point (RoW)	C050045A001A
5 GHz PMP 450i Connectorized Access Point (FCC)	C050045A002A
5 GHz PMP 450i Connectorized Access Point (EU)	C050045A003A

Cambium description	Cambium part number
5 GHz PMP 450i Connectorized Access Point (DES Only)	C050045A004A
5 GHz PMP 450i Connectorized Access Point (IC)	C050045A015A
5 GHz PMP 450i AP, Integrated 90°/120° sector antenna (RoW)	C050045A005B
5 GHz PMP 450i AP, Integrated 90°/120° sector antenna (FCC)	C050045A006B
5 GHz PMP 450i AP, Integrated 90°/120° sector antenna (EU)	C050045A007B
5 GHz PMP 450i AP, Integrated 90°/120° sector antenna (DES only)	C050045A008B
5 GHz PMP 450i AP, Integrated 90°/120° sector antenna (IC)	C050045A016B
PMP 450i SM (Subscriber Module)	
3 GHz PMP 450i Connectorized Subscriber Module	C030045C001A
3 GHz PMP 450i SM, Integrated High Gain Antenna	C030045C002A
5 GHz PMP 450i Connectorized Subscriber Module	C050045C001A
5 GHz PMP 450i SM, Integrated High Gain Antenna	C050045C002A

**Note**

The 450i SM does not have license keys.

Table 62 PMP 450i ATEX/HAZLOC ODU models/part numbers

ODU model / part number	Description
ODU model	
5085CHH	450i Connectorized ATEX/HAZLOC
5085HH	450i Integrated 90°/120° Deg Sector ATEX/HAZLOC
5095HH	450i Integrated High Gain Directional ATEX/HAZLOC
Part Number	
C050045A009A	5 GHz PMP 450i Conn Access Point (ROW), ATEX/HAZLOC
C050045A010A	5 GHz PMP 450i Conn Access Point (FCC), ATEX/HAZLOC
C050045A011A	5 GHz PMP 450i Conn Access Point (EU), ATEX/HAZLOC
C050045A012A	5 GHz PMP 450i Integrated Access Point, 90 degree (ROW), ATEX/HAZLOC
C050045A013A	5 GHz PMP 450i Integrated Access Point, 90 degree (FCC), ATEX/HAZLOC
C050045A014A	5 GHz PMP 450i Integrated Access Point, 90 degree (EU), ATEX/HAZLOC

C050045A017A	5 GHz PMP 450i Conn Access Point (IC), ATEX/HAZLOC
C050045A018A	5 GHz PMP 450i Integrated Access Point, 90 degree (IC), ATEX/HAZLOC
C050045A019A	5 GHz PMP 450i Conn Access Point (DES Only), ATEX/HAZLOC
C050045A020A	5 GHz PMP 450i Integrated Access Point, 90 degree (DES Only), ATEX/HAZLOC
C050045C003A	5 GHz PMP 450i Conn Subscriber Module, ATEX/HAZLOC
C050045C004A	5 GHz PMP 450i Integrated High Gain Antenna, ATEX/HAZLOC

PTP 450i

Table 63 PTP 450i Series ODU part numbers

Cambium description	Cambium part number
3 GHz PTP 450i END, Connectorized	C030045B001A
3 GHz PTP 450i END, Integrated High Gain Antenna	C030045B002A
3 GHz PTP 450i END, Connectorized (DES only)	C030045B003A
5 GHz PTP 450i END, Connectorized (RoW)	C050045B001A
5 GHz PTP 450i END, Connectorized (FCC)	C050045B003A
5 GHz PTP 450i END, Connectorized (EU)	C050045B005A
5 GHz PTP 450i END, Connectorized (DES only)	C050045B007A
5 GHz PTP 450i END, Connectorized (IC)	C050045B015A
5 GHz PTP 450i END, Integrated High Gain Antenna (RoW)	C050045B002A
5 GHz PTP 450i END, Integrated High Gain Antenna (FCC)	C050045B004A
5 GHz PTP 450i END, Integrated High Gain Antenna (EU)	C050045B006A
5 GHz PTP 450i END, Integrated High Gain Antenna (DES only)	C050045B008A
5 GHz PTP 450i END, Integrated High Gain Antenna (IC)	C050045B016A
Ethernet cable adapter for CMM4	N000045L001A

Table 64 PTP 450i ATEX/HAZLOC ODU models/part numbers

ODU model / part number	Description
ODU model	
5085CHH	450i Connectorized ATEX/HAZLOC
5095HH	450i Integrated High Gain Directional ATEX/HAZLOC
C050045B009A	5 GHz PTP 450i END, Connectorized (ROW), ATEX/HAZLOC
C050045B010A	5 GHz PTP 450i END, Integrated High Gain Antenna (ROW), ATEX/HAZLOC
C050045B011A	5 GHz PTP 450i END, Connectorized (FCC), ATEX/HAZLOC
C050045B012A	5 GHz PTP 450i END, Integrated High Gain Antenna (FCC), ATEX/HAZLOC
C050045B013A	5 GHz PTP 450i END, Connectorized (EU), ATEX/HAZLOC
C050045B014A	5 GHz PTP 450i END, Integrated High Gain Antenna (EU), ATEX/HAZLOC
C050045B017A	5 GHz PTP 450i END, Connectorized (IC), ATEX/HAZLOC
C050045B018A	5 GHz PTP 450i END, Integrated High Gain Antenna (IC), ATEX/HAZLOC
C050045B019A	5 GHz PTP 450i END, Connectorized (DES Only), ATEX/HAZLOC
C050045B020A	5 GHz PTP 450i END, Integrated High Gain Antenna (DES Only), ATEX/HAZLOC

PMP 450b

Table 65 PMP 450b Series ODU part numbers

Cambium description	Cambium part number
PMP 450b SM (Subscriber Module)	
5 GHz 450b Mid Gain WB SM	C050045C011A

PMP 450

Table 66 PMP 450 Series ODU part numbers

Cambium description	Cambium part number
PMP 450 AP (Access Point)	
2.4 GHz PMP 450 Connectorized Access Point	C024045A001A
2.4 GHz PMP 450 Connectorized Access Point (DES)	C024045A003A
3.5 GHz PMP 450 Connectorized Access Point	C035045A001A
3.5 GHz PMP 450 Connectorized Access Point (DES)	C035045A003A
3.6 GHz PMP 450 Connectorized Access Point	C036045A001A
3.6 GHz PMP 450 Connectorized Access Point (DES)	C036045A003A
5 GHz PMP 450 Connectorized Access Point	C054045A001A
5 GHz PMP 450 Connectorized Access Point (US only)	C054045A002A
5 GHz PMP 450 Connectorized Access Point (DES)	C054045A003A
PMP 450 AP Lite	
2.4 GHz PMP 450 Connectorized Access Point - Lite	C024045A011A
3.3-3.6 GHz PMP 450 Connectorized Access Point - Lite	C035045A011A
3.55-3.8 GHz PMP 450 Connectorized Access Point - Lite	C036045A011A
5 GHz PMP 450 Connectorized Access Point - Lite	C054045A011A
5 GHz PMP 450 Connectorized Access Point (FCC) - Lite	C054045A012A
PMP 450 SM (Subscriber Module)	
900 MHz PMP 450 Connectorized Subscriber Module	C009045C001A
2.4 GHz PMP 450 Subscriber Module, 4 Mbps	C024045C001A
2.4 GHz PMP 450 Subscriber Module, 10 Mbps	C024045C002A
2.4 GHz PMP 450 Subscriber Module, 20 Mbps	C024045C003A
2.4 GHz PMP 450 Subscriber Module, Uncapped	C024045C004A
2.4 GHz PMP 450 Connectorized Subscriber Module, 4 Mbps	C024045C005A
2.4 GHz PMP 450 Connectorized Subscriber Module, 10 Mbps	C024045C006A
2.4 GHz PMP 450 Connectorized Subscriber Module, 20 Mbps	C024045C007A
2.4 GHz PMP 450 Connectorized Subscriber Module, Uncapped	C024045C008A
3.5 GHz PMP 450 High Gain Directional Integrated Subscriber	C035045C014A
3.5 GHz PMP 450 Subscriber Module, 4 Mbps	C035045C001A

Cambium description	Cambium part number
3.5 GHz PMP 450 Subscriber Module, 10 Mbps	C035045C002A
3.5 GHz PMP 450 Subscriber Module, 20 Mbps	C035045C003A
3.5 GHz PMP 450 Subscriber Module, Uncapped	C035045C004A
3.5 GHz PMP 450 Connectorized Subscriber Module, 4 Mbps	C035045C005A
3.5 GHz PMP 450 Connectorized Subscriber Module, 10 Mbps	C035045C006A
3.5 GHz PMP 450 Connectorized Subscriber Module, 20 Mbps	C035045C007A
3.5 GHz PMP 450 Connectorized Subscriber Module, Uncapped	C035045C008A
3.6 GHz PMP 450 High Gain Directional Integrated Subscriber	C036045C014A
3.6 GHz PMP 450 Subscriber Module, 4 Mbps	C036045C001A
3.6 GHz PMP 450 Subscriber Module, 10 Mbps	C036045C002A
3.6 GHz PMP 450 Subscriber Module, 20 Mbps	C036045C003A
3.6 GHz PMP 450 Subscriber Module, Uncapped	C036045C004A
3.6 GHz PMP 450 Connectorized Subscriber Module, 4 Mbps	C036045C005A
3.6 GHz PMP 450 Connectorized Subscriber Module, 10 Mbps	C036045C006A
3.6 GHz PMP 450 Connectorized Subscriber Module, 20 Mbps	C036045C007A
3.6 GHz PMP 450 Connectorized Subscriber Module, Uncapped	C036045C008A
5 GHz PMP 450 Connectorized Subscriber Module, 4 Mbps	C054045C005A
5 GHz PMP 450 Connectorized Subscriber Module, 10 Mbps	C054045C006A
5 GHz PMP 450 Connectorized Subscriber Module, 20 Mbps	C054045C007A
5 GHz PMP 450 Connectorized Subscriber Module, Uncapped	C054045C008A
5 GHz PMP 450 Integrated Subscriber Module, 4 Mbps	C054045C001B
5 GHz PMP 450 Integrated Subscriber Module, 10 Mbps	C054045C002B
5 GHz PMP 450 Integrated Subscriber Module, 20 Mbps	C054045C003B
5 GHz PMP 450 Integrated Subscriber Module, Uncapped	C054045C004B
5 GHz PMP 450 Connectorized Subscriber Module, 4 Mbps	C054045C005B
5 GHz PMP 450 Connectorized Subscriber Module, 10 Mbps	C054045C006B
5 GHz PMP 450 Connectorized Subscriber Module, 20 Mbps	C054045C007B
5 GHz PMP 450 Connectorized Subscriber Module, Uncapped	C054045C008B
5 GHz PMP 450d Subscriber Module, 20 Mbps – 4-pack	C054045H013B
5 GHz PMP 450d Subscriber Module, Uncapped – 4-pack	C054045H014B

PTP 450

Table 67 PTP 450 Series ODU part numbers

Cambium description	Cambium part number
PTP 450 900 MHz END – Connectorized	C009045B001A
PTP 450 3.5 GHz END – Integrated	C035045B001A
PTP 450 3.5 GHz END – Connectorized	C035045B002A
PTP 450 3.5 GHz END – Integrated – DES Only	C035045B003A
PTP 450 3.5 GHz END – Connectorized – DES Only	C035045B004A
PTP 450 3.65 GHz END – Integrated	C036045B001A
PTP 450 3.65 GHz END – Connectorized	C036045B002A
PTP 450 3.65 GHz END – Integrated – DES Only	C036045B003A
PTP 450 3.65 GHz END – Connectorized – DES Only	C036045B004A
PTP 450 5 GHz END – Integrated (ROW)	C054045B001A
PTP 450 5 GHz END – Connectorized (ROW)	C054045B002A
PTP 450 5 GHz END – Integrated (ROW) – DES Only	C054045B003A
PTP 450 5 GHz END – Connectorized (ROW) – DES Only	C054045B004A
PTP 450 5 GHz END – Integrated (FCC)	C054045B005A
PTP 450 5 GHz END – Connectorized (FCC)	C054045B006A

PMP/PTP 450/450i Series Accessories

Table 68 PMP/PTP 450/450i Series Accessories

Cambium description	Cambium part number
PMP 450 AP Antenna Options	
900 MHz 65 degree Sector Antenna (Dual Slant)	N009045D001A
900 MHz 12 dBi gain directional antenna (Dual Slant)	N009045D003A
2.4 GHz Dual Slant Antenna for 60 Degree Sector	C024045D601A
3.5 GHz and 3.6 GHz Dual Slant Antenna for 90 Degree Sector	C030045D901A
5 GHz Antenna for 90°/120° Degree Sector	85009324001
N-type to N-type cable (16 inch length)	30009406002
Power supplies	

Cambium description	Cambium part number
Power supply, 60 W, 56 V with Gbps support	N000065L001C
AC+DC Enhanced Power Injector	C000065L002C
Line Cord, Fig 8 – US	N000065L003A
Line Cord, Fig 8 – UK	N000065L004A
Line Cord, Fig 8 – EU	N000065L005A
Power over Ethernet midspan, 60 W, -48 VDC Input	N000000L036A
Power Supply, 30 W, 56 V – Gbps support	N000000L034A
Gigabit Enet Capable Power Supply - 30VDC, 15W	N000900L001A
Cable, UL Power Supply Cord Set, US	N000900L007A
Cable, UL Power Supply Cord Set, EU	N000900L008A
Cable, UL Power Supply Cord Set, UK	N000900L009A
AP Optional Equipment	
CMM MICRO (Outdoor Enclosure) (450 only)	1070CKHH
CMM5 Controller	C000000L500A
CMM5 Power and Sync Injector 56V	C000000L556A
UGPS	1096H
CMM5 Power Supply, AC, 56V 240W	N000000L054B
CMM5 Power Supply AC, 48V, 640W	N000000L101A
CMM5 Spare Controller Cable – 1m	N000000L102A
CMM5 to UGPS Shielded Cable (20 meter)	N000000L103A
CMM5 Spare DC Power Connector (10 pack)	N000000L104A
CMM4 W/RUGGEDIZED Switch and GPS	1090CKHH
CMM4 NO Switch	1091HH
CMM4 Rack Mount Assembly	1092HH
Ethernet cable adapter for CMM4	N000045L001A
Universal GPS Module	1096H
RJ-45 Gland Spare – PG16 style (QTY 10)	N000065L033A
Blanking Plug Pack (Qty 10)	N000065L036A
SM Optional Equipment	
Power Supply, 30 W, 56 V – Gbps support	N000000L034A

Cambium description	Cambium part number
Gigabit Enet Capable Power Supply – 30 VDC, 15 W	N000900L001A
Cable, UL Power Supply Cord Set, US	N000900L007A
Cable, UL Power Supply Cord Set, EU	N000900L008A
Cable, UL Power Supply Cord Set, UK	N000900L009A
53CM Offset, Reflector Dish Kit, 4PK	HK2022A
Alignment Tool Headset	ACATHS-01A
Accessories	
Surge Suppressor (30 VDC)	600SSH
Gigabit Surge Suppressor (56 VDC)	C000000L033A
LPU and Grounding Kit (1 kit per ODU)	C000065L007B
Single Mode Optical SFP Interface per ODU	C000065L008A
Multimode Kit	C000065L009A
50 Ohm Braided Coaxial Cable - 75 meter	30010194001
50 Ohm Braided Coaxial Cable - 500 meter	30010195001
RF Connector, N, Male, Straight for CNT-400 Cable	09010091001
Tyco/AMP, Mod Plug RJ45, 100 pack	WB3177
Tyco/AMP Crimp Tool	WB3211
RJ-45 Spare Grounding Gland - PG16 size (Qty. 10)	N000065L033
Mounting brackets	
Tilt Bracket Assembly	N000045L002A
Mounting Bracket (Integrated)	N000065L031A
Mounting Bracket (Connectorized)	N000065L032A
Upgrade Keys	
PMP 450 4 To 10 Mbps Upgrade Key	C000045K002A
PMP 450 4 To 20 Mbps Upgrade Key	C000045K003A
PMP 450 4 To Uncapped Upgrade Key	C000045K004A
PMP 450 10 To 20 Mbps Upgrade Key	C000045K005A
PMP 450 10 To Uncapped MBPS Upgrade Key	C000045K006A
PMP 450 20 To Uncapped MBPS Upgrade Key	C000045K007A
PMP 450 Lite AP to Full AP Upgrade Key	C000045K008A

Cambium description	Cambium part number
Extended Warranty	
PMP 450 Platform AP Extended Warranty, 1 Additional Year	SG00TS4009A
PMP 450 Platform AP Extended Warranty, 2 Additional Years	SG00TS4017A
PMP 450 Platform AP Extended Warranty, 4 Additional Years	SG00TS4025A
PMP 450 Platform SM Extended Warranty, 1 Additional Year	SG00TS4010A
PMP 450 Platform SM Extended Warranty, 2 Additional Years	SG00TS4018A
PMP 450 Platform SM Extended Warranty, 4 Additional Years	SG00TS4026A

Chapter 3: System planning

This chapter provides information to help the user to plan a PMP/PTP 450 Platform link.

The following topics are described in this chapter:

- [Typical deployment](#) on page [3-2](#) contains diagrams illustrating typical PMP/PTP 450 Platform site deployments.
- [Site planning](#) on page [3-7](#) describes factors to be considered when planning the proposed link end sites, including grounding, lightning protection and equipment location.
- [Radio Frequency planning](#) on page [3-17](#) describes how to plan PMP/PTP 450 Platform links to conform to the regulatory restrictions that apply in the country of operation.
- [Link planning](#) on page [3-27](#) describes factors to be taken into account when planning links, such as range, path loss and throughput.
- [Planning for connectorized units](#) on page [3-30](#) describes factors to be taken into account when planning to use connectorized ODUs with external antennas in PMP/PTP 450 Platform links.
- [Data network planning](#) on page [3-32](#) describes factors to be considered when planning PMP/PTP 450 Platform data networks.
- [Network management planning](#) on page [3-40](#) describes how to plan for PMP/PTP 450 Platform links to be managed remotely using SNMP.
- [Security planning](#) on page [3-41](#) describes how to plan for PMP/PTP 450 Platform links to operate in secure mode.
- Remote AP Deployment on page [3-51](#) describes how to deploy Remote AP.

Typical deployment

This section contains diagrams illustrating typical PMP/PTP 450 Platform site deployments.

ODU with PoE interface to PSU

In the basic configuration, there is only one Ethernet interface, a copper cable for Power over Ethernet (PoE) from the PSU to the ODU (PSU port), as shown in the following diagrams: mast or tower installation (Figure 42), wall installation (Figure 43) and roof installation (Figure 44).

Figure 42 Mast or tower installation

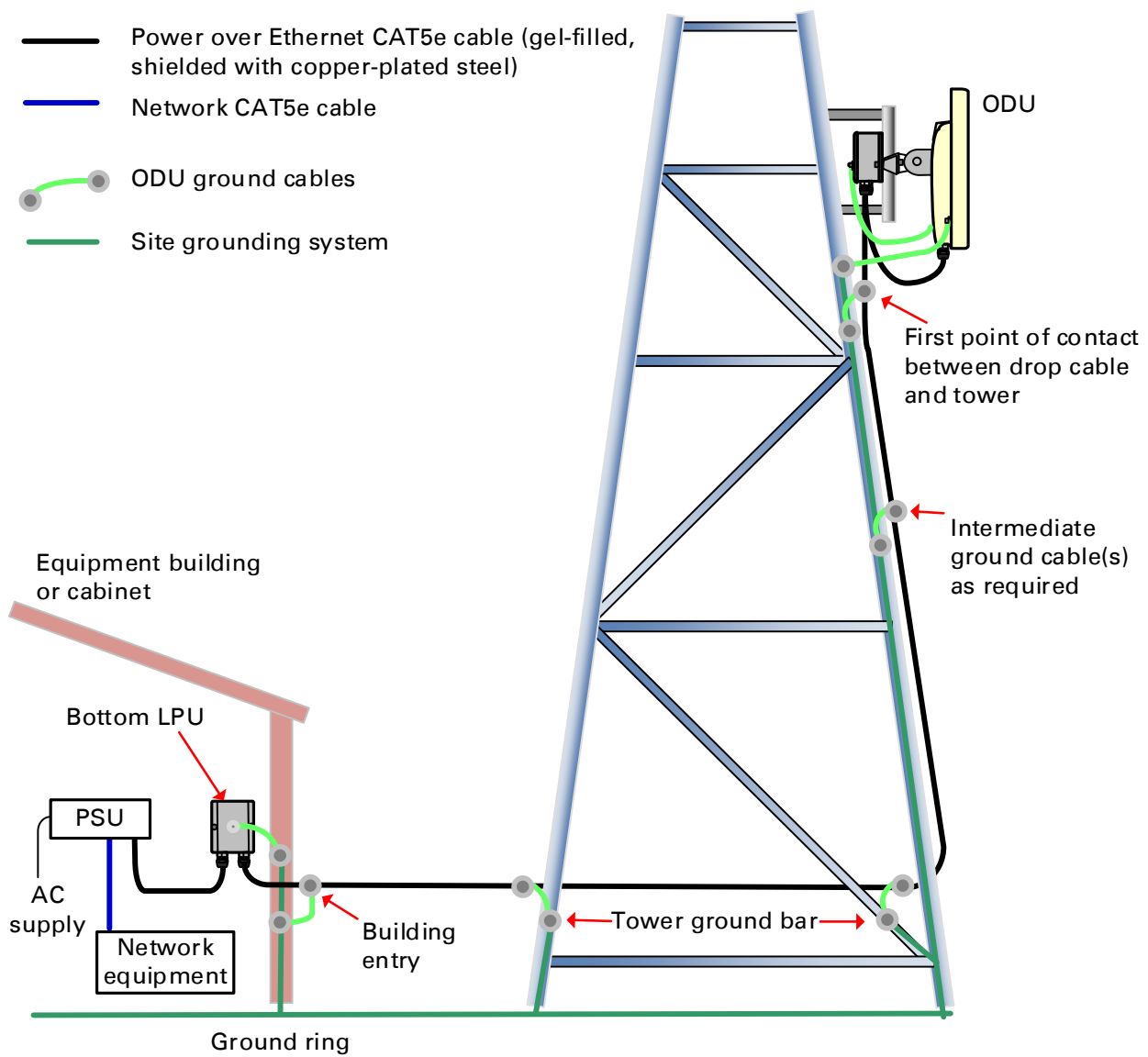

Figure 43 Wall installation

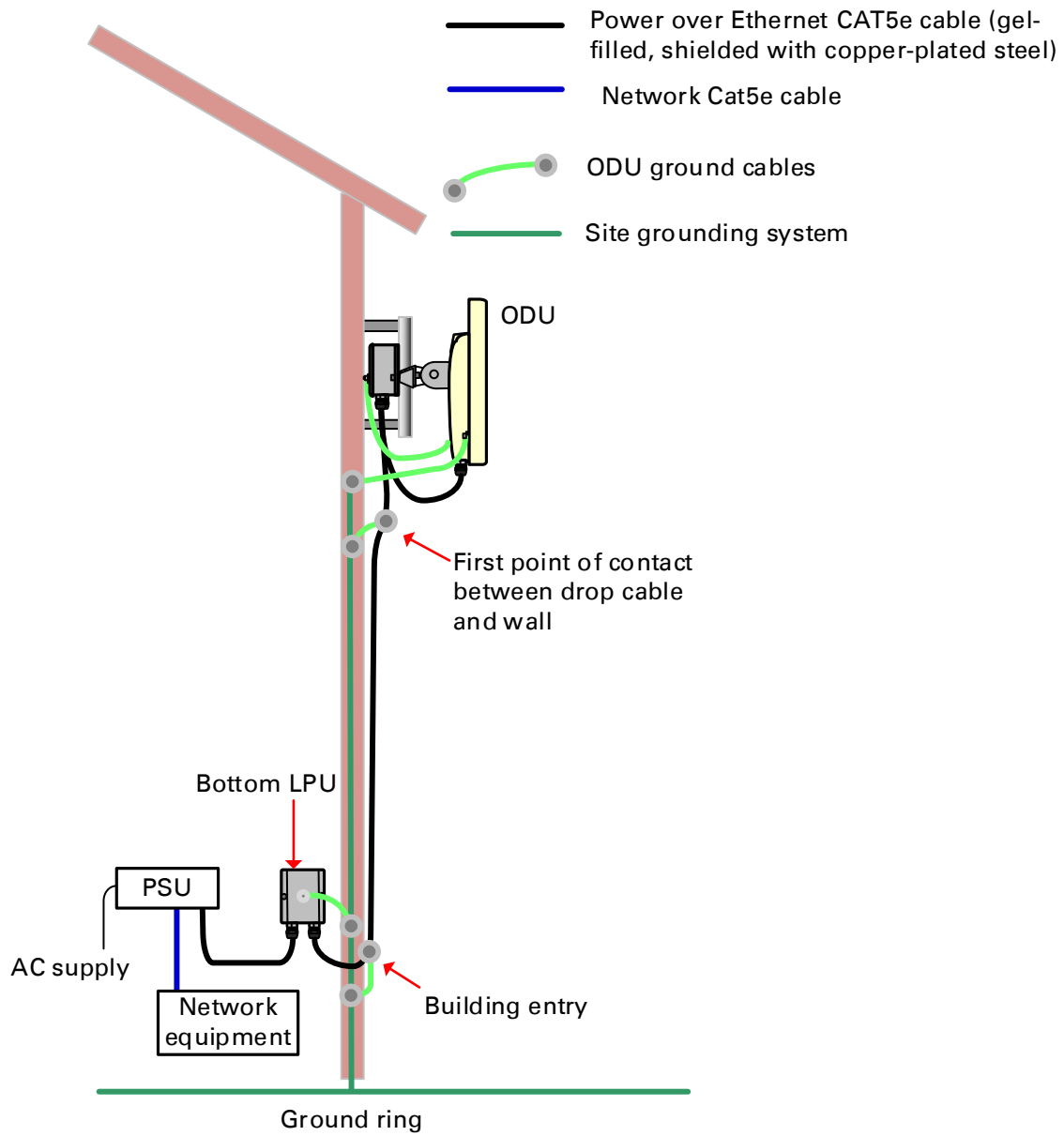

Figure 44 Roof installation

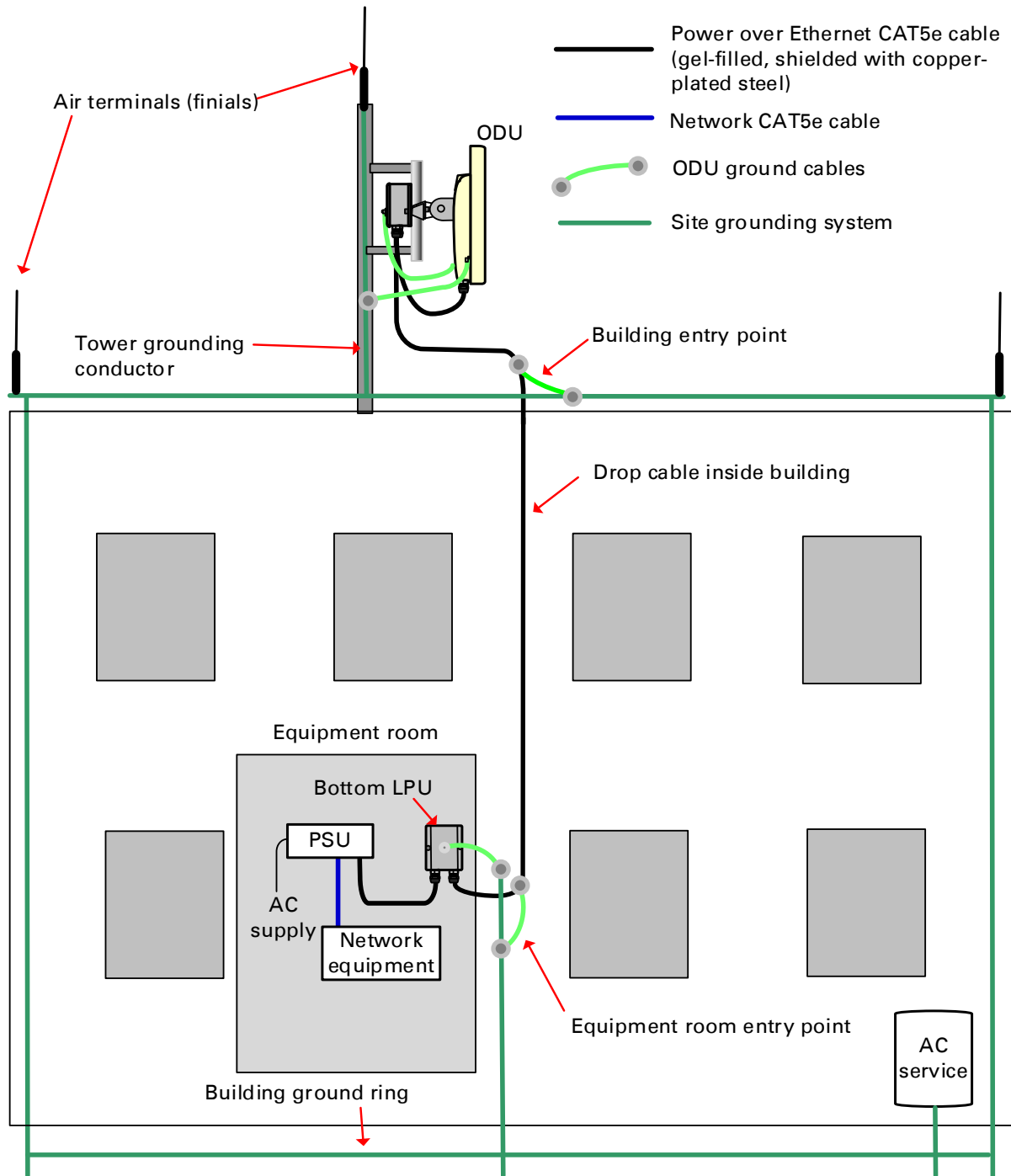

Figure 45 GPS receiver wall installation

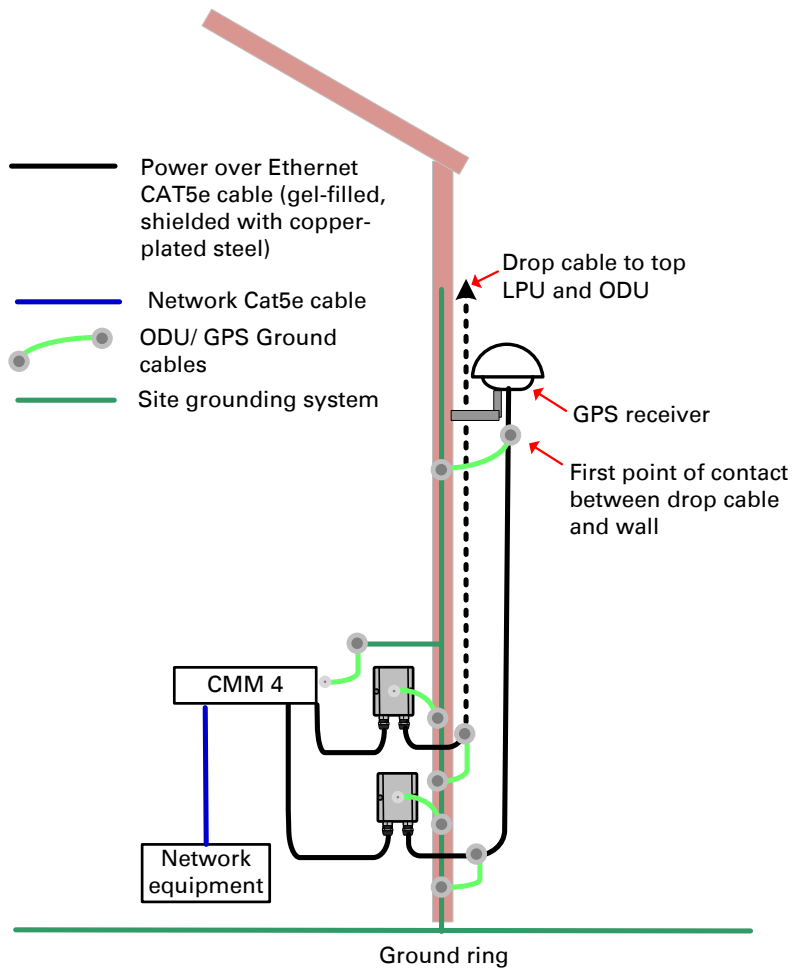
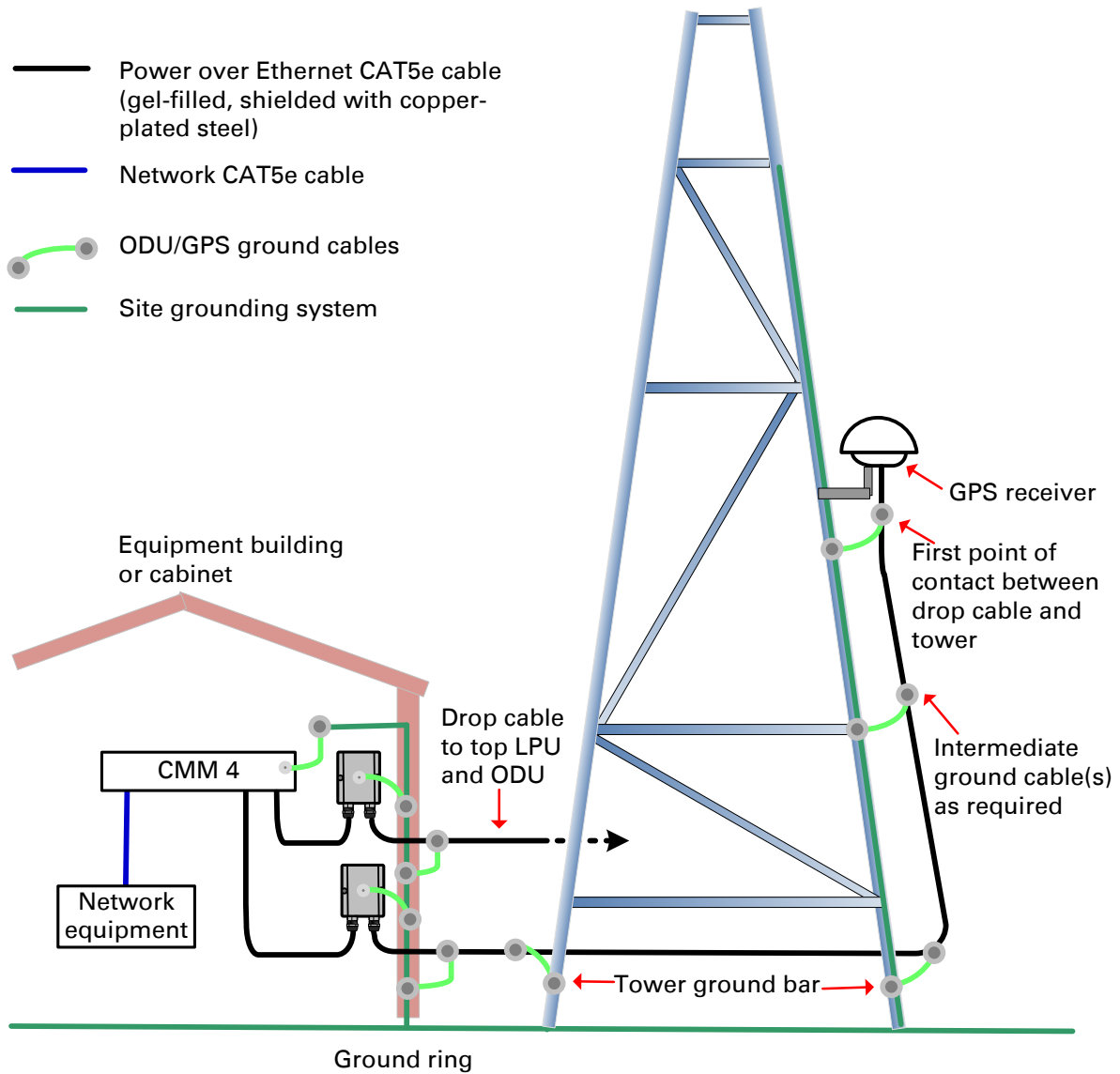

Figure 46 GPS receiver tower or mast installation



Site planning

This section describes factors to be considered when choosing sites for PMP or PTP radios, power supplies, CMM4 (if applicable) and UGPS (if applicable).

Site selection for PMP/PTP radios

When selecting a site for the ODU, consider the following factors:

- Height and location to ensure that people are kept away from the antenna; see [Calculated distances and power compliance margins](#) on page 4-24.
- Height and location to achieve the best radio path.
- Indoor location where the power supply LED indicators will be visible, so the drop cable length will not exceed the maximum recommended length; see [Power supply site selection](#) on page 3-8.
- Ability to meet the requirements specified in [Grounding and lightning protection](#) on page 3-8.
- Aesthetics and planning permission issues.
- Cable lengths; see [Ethernet standards and cable lengths](#) on page 2-33.
- The effect of strong winds on the installation; see [ODU wind loading](#) on page 3-11.

Power supply site selection

When selecting a site for the ODU power supply, consider the following factors:

- Indoor location with no possibility of condensation, flooding or high humidity.
- Availability of a mains electricity supply.
- Located in an environment where it is not likely to exceed its operational temperature rating, allowing for natural convection cooling.
- Accessibility for viewing status indicator LED and connecting Ethernet cables.
- Cable lengths; see [Ethernet standards and cable lengths](#) on page 2-33.

Maximum cable lengths

When installing PMP/PTP 450i Series ODU, the maximum permitted length of the shielded copper Ethernet interface cable is 330 feet (100m) from AP/BHM/SM/BHS to their associated power supplies or CMM4.

When installing PMP 450m Series ODU, the maximum permitted length of the shielded copper Ethernet interface cable is 330 feet (100m) from ODU to the network interface equipment.

Grounding and lightning protection



Warning

Electro-magnetic discharge (lightning) damage is not covered under warranty. The recommendations in this guide, when followed correctly, give the user the best protection from the harmful effects of EMD. However, 100% protection is neither implied nor possible.

Structures, equipment and people must be protected against power surges (typically caused by lightning) by conducting the surge current to ground via a separate preferential solid path. The actual degree of protection required depends on local conditions and applicable local regulations. To adequately protect a PMP/PTP 450 Platform installation, both ground bonding and transient voltage surge suppression are required.

Full details of lightning protection methods and requirements can be found in the international standards IEC 61024-1 and IEC 61312-1, the U.S. National Electric Code ANSI/NFPA No. 70-1984 or section 54 of the Canadian Electric Code.



Warning

International and national standards take precedence over the requirements in this guide.

Lightning protection zones

Use the rolling sphere method (Figure 47) to determine where it is safe to mount equipment. An imaginary sphere, typically 50 meters in radius, is rolled over the structure. Where the sphere rests against the ground and a strike termination device (such as a finial or ground bar), all the space under the sphere is considered to be in the zone of protection (Zone B). Similarly, where the sphere rests on two finials, the space under the sphere is considered to be in the zone of protection.

Figure 47 Rolling sphere method to determine the lightning protection zones

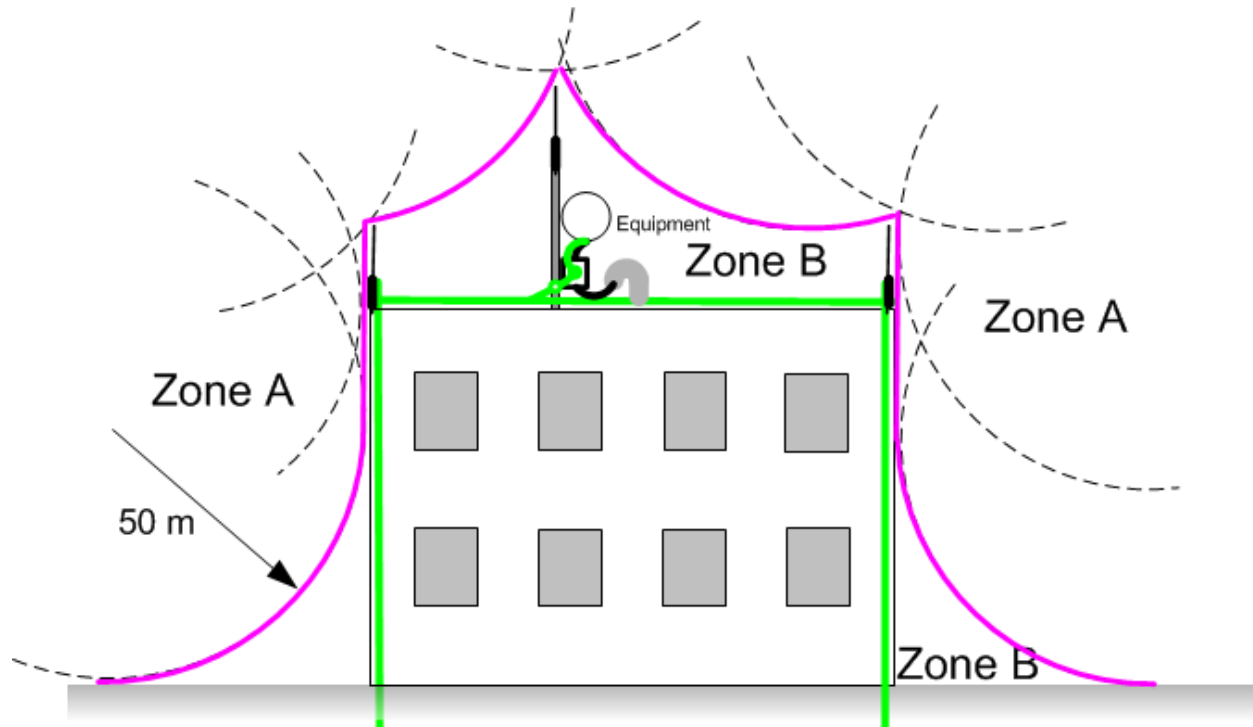

Zone A: In this zone a direct lightning strike is possible. Do not mount equipment in this zone.

Zone B: In this zone, direct EMD (lightning) effects are still possible, but mounting in this zone significantly reduces the possibility of a direct strike. Mount equipment in this zone.



Warning

Never mount equipment in Zone A. Mounting in Zone A may put equipment, structures and life at risk.

Site grounding system

Confirm that the site has a correctly installed grounding system on a common ground ring with access points for grounding the 450 Platform Family ODU.

If the outdoor equipment is to be installed on the roof of a high building ([Figure 44](#)), confirm that the following additional requirements are met:

- A grounding conductor is installed around the roof perimeter to form the main roof perimeter lightning protection ring.
- Air terminals are installed along the length of the main roof perimeter lightning protection ring, typically every 6.1m (20ft).
- The main roof perimeter lightning protection ring contains at least two down conductors connected to the grounding electrode system. The down conductors should be physically separated from one another, as far as practical.

ODU and external antenna location

Find a location for the ODU (and external antenna for connectorized units) that meets the following requirements:

- The equipment is high enough to achieve the best radio path.
- People can be kept a safe distance away from the equipment when it is radiating. The safe separation distances are defined in [Calculated distances and power compliance margins](#) on page 4-24.
- The equipment is lower than the top of the supporting structure (tower, mast or building) or its lightning air terminal.
- If the ODU is connectorized, select a mounting position that gives it maximum protection from the elements, but still allows easy access for connecting and weatherproofing the cables. To minimize cable losses, select a position where the antenna cable lengths can be minimized. If diverse or two external antennas are being deployed, it is not necessary to mount the ODU at the midpoint of the antennas.

ODU ambient temperature limits

Select a location where the ODU can operate within safe ambient temperature limits. The following points need to be considered while selecting a location for the ODU:

- The ODU must be mounted in a Restricted Access Location (as defined in EN 60950-1) if the operating ambient temperature may exceed 40°C, including solar radiation.
- If the ambient temperature never exceeds 40°C, the temperature of the external metal case parts of the ODU will not exceed the touch temperature limit of 70°C.
- If the ambient temperature never exceeds 60°C, the temperature of the external metal case parts of the ODU will not exceed the touch temperature limit of 90°C.

**Note**

A restricted access location is defined (in EN 60950-1) as one where access may only be gained by use of a tool or lock and key, or other means of security, and access is controlled by the authority responsible for the location. Access must only be gained by persons who have been instructed about the reasons for the restrictions applied to the location and about any precautions that must be taken. Examples of permissible restricted access locations are a lockable equipment room or a lockable cabinet.

ODU wind loading

Ensure that the ODU and the structure on which it is mounted are capable of withstanding the prevalent wind speeds at a proposed 450 Platform site. Wind speed statistics are available from national meteorological offices.

The ODU and its mounting bracket are capable of withstanding wind speeds of:

- Up to 200 mph (322 kph) for PMP 450m Series – AP 5 GHz
- Up to 124 mph (Integrated) for PMP/PTP 450i – all models 3 GHz and 5 GHz
- Up to 200 mph (Connectorized) for PMP/PTP 450i – all models 3 GHz and 5 GHz
- Up to 200 mph (322 kph) for PMP/PTP 450 – all models
- Up to 200 mph (322 kph) for PMP 450 – Ruggedized
- Up to 200 mph (322 kph) for PMP 450i – all models 900 MHz
- Up to 118 mph (191 kph) for PMP 450b
- Up to 90 mph (145 kph) for PMP 450d
- Up to 100 mph (161 kph) for 900 MHz antennas

Wind blowing on the ODU will subject the mounting structure to significant lateral force. The magnitude of the force depends on both wind strength and surface area of the ODU. Wind loading is estimated using the following formulae:

- Force (in kilograms) = $0.1045aV^2$
where:
 - “a” is the surface area in square meters, and
 - “V” is the wind speed in meters per second.
- Force (in pounds) = $0.0042Av^2$
where:
 - “A” is the surface area in square feet, and
 - “v” is the wind speed in miles per hour.

Applying these formulae to the 450 platform at different wind speeds, the resulting wind loadings are shown in below tables.

Table 69 PMP 450m Series wind loading (Newton)

Type of ODU	Max surface area (square meters)	Wind speed (kilometer per hour)				
		160	170	180	190	200
Integrated 90° sector antenna	0.331	671	757	849	946	1048

Table 70 PMP/PTP 450i Series wind loading (Newton)

Type of ODU	Max surface area (square meters)	Wind speed (kilometer per hour)				
		160	170	180	190	200
Connectorized	0.035	94	106	119	132	146
Directional Yagi antenna - 900 MHz	0.025	67	76	85	94	105
External 65° sector antenna – 900 MHz	0.253	677	764	857	954	1058
Directional antenna – 3.x GHz	0.1	142	160	180	200	222
Integrated 90° sector antenna -3.x GHz	0.18	83	94	105	117	130
Directional antenna – 5 GHz	0.093	249	281	315	351	389
Integrated 90°/120° sector antenna - 5 GHz	0.126	337	381	427	475	527

Table 71 PMP 450m Series wind loading (lb force)

Type of ODU	Max surface area (square feet)	Wind speed (miles per hour)				
		100	105	110	115	120
Integrated 90° sector antenna	3.565	150	165	181	198	216

Table 72 PMP/PTP 450i Series wind loading (lb force)

Type of ODU	Max surface area (square feet)	Wind speed (miles per hour)				
		100	105	110	115	120
Connectorized	0.377	16	17	19	21	23
Directional antenna – 5 GHz	1.001	42	46	51	56	61
Integrated 90°/120° sector antenna - 5 GHz	1.356	57	63	69	75	82
Directional Yagi antenna - 900 MHz	0.27	11	13	14	15	16
External 65° sector antenna – 900 MHz	2.72	114	126	138	151	165

For a connectorized ODU, add the wind loading of the external antenna to that of the ODU. The antenna manufacturer should be able to quote wind loading.

Table 73 PMP/PTP 450 Series wind loading (Newton)

Type of ODU	Max surface area (square meters)	Wind speed (kilometer per hour)				
		160	170	180	190	200
External 60° sector antenna – 2.4 GHz AP	0.27	722	815	914	1019	1129
External 60° sector antenna – 5 GHz AP	0.066	177	199	223	249	276
External 90° sector antenna – 5 GHz AP	0.083	222	251	281	313	347
SM	0.027	72	82	91	102	113
Integrated High-Gain, Ruggedized	0.093	249	281	315	351	389
Integrated Dish	0.14	375	423	474	528	585

Table 74 PMP/PTP 450 Series wind loading (lb force)

Type of ODU	Max surface area (square feet)	Wind speed (miles per hour)				
		100	105	110	115	120
External 60° sector antenna – 2.4 GHz AP	2.9	122	134	147	161	175
External 60° sector antenna – 5 GHz AP	0.71	29.8	33	37	39	43
External 90° sector antenna – 5 GHz AP	0.89	37	41	45	49	54
SM	0.29	12	13	15	16	18
Integrated High- Gain, Ruggedized	1	42	46	51	56	60
Integrated Dish	1.49	63	69	76	83	90

Hazardous locations

Check that the ODUs will not be exposed to hazardous gases, as defined by HAZLOC (USA) and ATEX (Europe) regulations. If there is a risk of such exposure, then order the PTP/PMP 450i ATEX/Hazloc product variants, as these are intended for operation in locations with gas hazards. The ATEX and HAZLOC standards limit the EIRP as shown in [Table 75](#).

Table 75 EIRP limits from ATEX and HAZLOC standards

ATEX gas group	HAZLOC gas group	Typical gas type	Maximum EIRP (Watt)
IIA	D	Propane	6
IIB	C	Ethylene	3.5
IIC	B	Hydrogen	2
IIC	A	Acetylene	2

Further reading

For information about...	Refer to...
Ordering Connectorized/ Integrated ATEX/HAZLOC ODUs	Table 62 and Table 63 on pages 2-61 and 2-62
ATEX/HAZLOC standards and type approval	Hazardous location compliance on page 4-31
Deployment of ATEX/HAZLOC ODUs	PMP/PTP 450i Hazardous Location Safety Guidance (pmp-1712)

Drop cable grounding points

To estimate how many grounding kits are required for each drop cable, refer to the site installation diagrams ([Figure 42](#), [Figure 43](#), and [Figure 44](#)) and use the following criteria:

- The drop cable shield must be grounded near the ODU at the first point of contact between the drop cable and the mast, tower or building.
- The drop cable shield must be grounded at the building entry point.

For mast or tower installations ([Figure 42](#)), use the following additional criteria:

- The drop cable shield must be grounded at the bottom of the tower, near the vertical to horizontal transition point. This ground cable must be bonded to the tower or tower ground bus bar (TGB), if installed.

- If the tower is greater than 61 m (200 ft) in height, the drop cable shield must be grounded at the tower midpoint, and at additional points as necessary to reduce the distance between ground cables to 61 m (200 ft) or less.
- In high lightning-prone geographical areas, the drop cable shield must be grounded at spacing between 15 to 22 m (50 to 75 ft). This is especially important on towers taller than 45 m (150 ft).

For roof installations (Figure 44), use the following additional criteria:

- The drop cable shield must be bonded to the building grounding system at its top entry point (usually on the roof).
- The drop cable shield must be bonded to the building grounding system at the entry point to the equipment room.

Lightning Protection Unit (LPU) location

Find a location for the bottom LPU that meets the following requirements:

- The bottom LPU can be connected to the drop cable from the ODU.
- The bottom LPU is within 600 mm (24 in) of the point at which the drop cable enters the building, enclosure or equipment room within a larger building.
- The bottom LPU can be bonded to the grounding system.

Radio Frequency planning

This section describes how to plan 450 Platform Family links to conform to analysis of spectrum and the regulatory restrictions that apply in the country of operation.

Regulatory limits

Many countries impose EIRP limits (Allowed EIRP) on products operating in the bands used by the 450 Platform Family.

Refer to [Equipment Disposal \(Chapter 10: Reference information\)](#) on page 10-50 to determine what the maximum transmitted power and EIRP for PMP/PTP 450 Platform that can be used in each of countries and frequency band.



Caution

It is the responsibility of the user to ensure that the PMP/PTP ODU is operated in accordance with local regulatory limits.



Note

Contact the applicable radio regulator to find out if registration of the PMP/PTP 450 Platform link is required.

Conforming to the limits

Ensure the link is configured to conform to local regulatory requirements by configuring the PMP 450/450i Series AP or PTP 450/450i Series BHM for the correct country. In the following situations, this does not prevent operation outside the regulations:

- When using connectorized ODUs with external antennas, the regulations may require the maximum transmit power to be reduced.

Available spectrum

The available spectrum for operation depends on the regulatory band. When configured appropriately, the unit will only allow operation on those channels which are permitted by the regulations.

Certain regulations have allocated certain channels as unavailable for use:

- FCC has allocated part of the 5.1 & 5.2 GHz
- ETSI has allocated part of the 5.4 GHz band to weather radar.
- UK and some other European countries have allocated part of the 5.8 GHz band to Road Transport and Traffic Telematics (RTTT) systems.

The number and identity of channels barred in a given regulatory band is dependent on the channel bandwidth and channel raster selected.

Analyzing the RF Environment

An essential element in RF network planning is the analysis of spectrum usage and the strength of the signals that occupy the spectrum. Regardless of how these parameters are measured and log or chart the results (through the Spectrum Analyzer feature or by using a spectrum analyzer), ensure measurements are performed:

- At various times of day.
- On various days of the week.
- Periodically into the future.

As new RF neighbors move in or consumer devices proliferate in currently used spectrum, this keeps the user aware of the dynamic possibilities for interference within the network.

Channel bandwidth

Select the required channel bandwidth for the link. The selection depends upon the regulatory band selected.

The wider the channel bandwidth, the greater the capacity. As narrower channel bandwidths take up less spectrum, selecting a narrow channel bandwidth may be a better choice when operating in locations where the spectrum is very busy.

Both ends of the link must be configured to operate on the same channel bandwidth.

Anticipating Reflection of Radio Waves

In the signal path, any object that is larger than the wavelength of the signal can reflect the signal. Such an object can even be the surface of the earth or of a river, bay or lake. The wavelength of the signal is approximately

- 2 inches (or 5 cm) for 5.4 GHz and 5.8 GHz signals.
- 12 inches for 900 MHz signals

A reflected signal can arrive at the antenna of the receiver later than the non-reflected signal arrives. These two or more signals cause the condition known as multipath. Multipath may increase or decrease the signal level, resulting in overall attenuation that may be higher or lower than that caused by the link distance. This is problematic at the margin of the link budget, where the standard operating margin (fade margin) may be compromised.

Obstructions in the Fresnel Zone

The Fresnel (pronounced fre-NEL) Zone is a three-dimensional volume around the line of sight of an antenna transmission. Objects that penetrate this area can cause the received strength of the transmitted signal to fade. Out-of-phase reflections and absorption of the signal result in signal cancellation.

The foliage of trees and plants in the Fresnel Zone can cause signal loss. Seasonal density, moisture content of the foliage, and other factors such as wind may change the amount of loss. Plan to perform frequent and regular link tests if you must transmit through foliage.

Planning for co-location

The first step to avoid interference in wireless systems is to set all AP/BHMs to receive timing from a synchronization source (Cluster Management Module, or Universal Global Positioning System). This ensures that the modules are in sync and start transmitting at the same time each frame.

The second step to avoid interference is to configure parameters on all AP/BHMs of the same frequency band in proximity such that they have compatible transmit/receive ratios (all stop transmitting each frame before any start receiving). This avoids the problem of one AP/BHM attempting to receive the signal from a distant SM/BHS while a nearby AP/BHM transmits, which could overpower that signal.



Note

Refer to Frame Alignment Legacy Mode parameter of Configuration > Radio > Advance tab for legacy product settings (See [Table 142 PMP 450i AP Radio attributes - 5 GHz](#) on page 7-135).

The following parameters on the AP/BHM determine the transmit/receive ratio:

- Downlink Data percentage
- Frame Period
- Max Range
- (reserved) Contention slots

If OFDM (450 Platform Family, PMP/PTP 230) and FSK (PMP/PTP 1x0) APs/BHMs of the same frequency band and channel bandwidth are in proximity, or if you want BHMs set to different parameters then you must use the Frame Calculator to identify compatible settings for APs/BHMs.

The co-location is also supported for 900 MHz PMP 450i Series APs (OFDM) and PMP 100 Series APs (FSK).

The Frame Calculator is available on the web management interface **Tools > Frame Calculator**. To use the Frame Calculator, type into the calculator various configurable parameter values for each proximal AP/BHM and then record the resulting AP/BHM Receive Start value. Next vary the Downlink Data percentage in each calculation and iterate until a calculated AP/BHM Receive Start for all co-located AP/BHMs where the transmit end does not come before the receive start.

Cambium also provides co-location tool which helps in co-location planning:

<https://support.cambiumnetworks.com/files/colocationtool>

For more information on 450 Platform Family co-location, see

<http://www.cambiumnetworks.com/solution-papers>

Multiple OFDM Access Point Clusters

When deploying multiple AP clusters in a dense area, consider aligning the clusters as shown below. However, this is only a recommendation. An installation may dictate a different pattern of channel assignments.

Figure 48 Example layout of 16 Access Point sectors (ABCD), 90-degree sectors

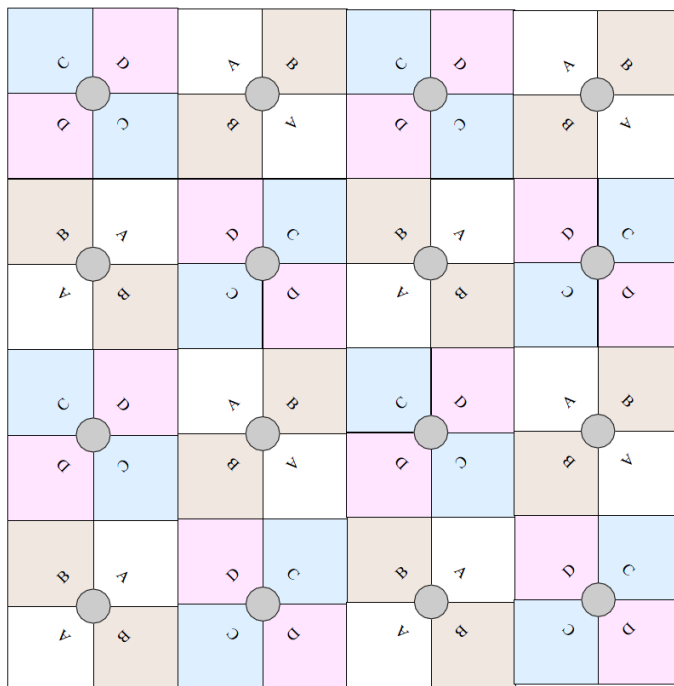

An example for assignment of frequency channels is provided in the following table.

Table 76 Example 5.8 GHz 4-channel assignment by access site

Symbol	Frequency
A	5.740 GHz
B	5.780 GHz
C	5.760 GHz
D	5.800 GHz