

Report on the Radio Testing
For
Cambium Networks Ltd
on
3GHz PMP 450m
Report no. TRA-041375-47-04B
8 November 2018

Report Number: TRA-041375-47-04B
Issue: B

REPORT ON THE RADIO TESTING OF A
Cambium Networks Ltd
3GHz PMP 450m
WITH RESPECT TO SPECIFICATION
FCC Part 90 Subpart Z

TEST DATE: 2018-08-06 to 2018-08-20

Written by:

D Moncayola
D Winstanley
S Garwell
Radio Test Engineer

Approved by:

J Charters
Department Manager-Radio

Date: 8 November 2018

Disclaimers:

[1] THIS DOCUMENT MAY BE REPRODUCED ONLY IN ITS ENTIRETY AND WITHOUT CHANGE
[2] THE RESULTS CONTAINED IN THIS DOCUMENT RELATE ONLY TO THE ITEM(S) TESTED

1 Revision Record

<i>Issue Number</i>	<i>Issue Date</i>	<i>Revision History</i>
A	20 September 2018	Original
B	8 November 2018	Additional standby mode RSE

2 Summary

TEST REPORT NUMBER: TRA-041375-47-04B

WORKS ORDER NUMBER: TRA-041375-02

PURPOSE OF TEST: Testing of radio frequency equipment per the relevant authorization procedure of chapter 47 of CFR (code of federal regulations) Part 2, subpart J.

TEST SPECIFICATION(S): Part 90 Subpart Z

EQUIPMENT UNDER TEST (EUT): 3GHz PMP 450m

FCC IDENTIFIER: QWP-30450M

MAC ADDRESS: 0a-00-3e-60-47-a0

MANUFACTURER/AGENT: Cambium Networks Ltd

ADDRESS: Unit B2
Linhay Business Park
Eastern Road
Ashburton
Devon
TQ13 7UP
United Kingdom

CLIENT CONTACT: Don Reid
☎ 01364 655667
✉ Don.Reid@Cambiumnetworks.com

ORDER NUMBER: NP82695747

TEST DATE: 2018-08-06 to 2018-08-20

TESTED BY: D Moncayola
D Winstanley
S Garwell
Element

2.1 Test Summary

<i>Test Method and Description</i>	<i>Requirement Clause Part 90</i>	<i>Applicable to this equipment</i>	<i>Result / Note</i>
Transmitter Unwanted Emissions	90.1323	☒	<i>Pass</i>
Occupied bandwidth	90.209	☒	<i>Pass</i>
Emission Mask	90.210	☒	<i>Pass</i>
Frequency Stability	90.213	☒	<i>Pass</i>
Peak EIRP Density and Equivalent Isotropically Radiated Power (e.i.r.p)	90.1321	☒	<i>Pass</i>

Notes:

The results contained in this report relate only to the items tested, in the condition at time of test, and were obtained in the period between the date of initial receipt of samples and the date of issue of the report.

The apparatus was set up and exercised using the configurations, modes of operation and arrangements defined in this report only. Any modifications made are identified in Section 8 of this report.

Particular operating modes, apparatus monitoring methods and performance criteria required by the standards tested to have been performed except where identified in Section 5.2 of this test report (Deviations from Test Standards).

3 Contents

1	Revision Record	3
2	Summary	4
2.1	Test Summary	5
3	Contents	6
4	Introduction	7
5	Test Specifications	8
5.1	Normative References	8
5.2	Deviations from Test Standards	8
5.3	Minimisation of reflections	8
5.4	Open area test site information	9
6	Glossary of Terms	10
7	Equipment Under Test	11
7.1	EUT Identification	11
7.2	System Equipment	11
7.3	EUT Mode of Operation	11
7.3.1	Transmission	11
7.4	EUT Radio Parameters	12
7.4.1	General	12
7.4.2	Antennas	12
7.4.3	Product specific declarations	12
7.5	EUT Description	12
8	Modifications	13
9	EUT Test Setup	13
9.1	Block Diagram	13
9.2	General Set-up Photograph	14
10	General Technical Parameters	15
10.1	Normal Conditions	15
10.2	Varying Test Conditions	15
11	Transmitter Unwanted Emissions	16
11.1	Definitions	16
11.2	Test Parameters	16
11.3	Test Limit	16
11.4	Test Method	17
11.5	Test Set-up Photograph	18
11.6	Test Equipment	18
11.7	Test Results	19
12	Occupied Bandwidth	23
12.1	Definition	23
12.2	Test Parameters	23
12.3	Test Limit	23
12.4	Test Method	24
12.5	Test Equipment	24
12.6	Test Results	25
13	<i>Emission Mask</i>	79
13.1	Definition	79
13.2	Test Parameters	79
13.3	Test Limit	79
13.4	Test Method	80
13.5	Test Equipment	80
13.6	Test Results	81
14	Frequency stability	90
14.1	Definition	90
14.2	Test Parameters	90
14.3	Test Limit	90
14.4	Test Method	91
14.5	Test Equipment	91
14.6	Test Results	92
15	Peak EIRP Density and Equivalent Isotropically Radiated Power (EIRP)	94
15.1	Definition	94
15.2	Test Parameters	94
15.3	Test Limit	94
15.4	Test Method	95
15.5	Test Equipment	95
15.6	Test Results – Peak EIRP Density	96
15.7	Test Results – Equivalent Isotropic Radiated Power (EIRP)	99
16	Measurement Uncertainty	103

4 Introduction

This report TRA-041375-47-04B presents the results of the Radio testing on a Cambium Networks Ltd, 3GHz PMP 450m to specification RSS-197 Wireless Broadband Access Equipment Operating in the Band 3650-3700 MHz.

The testing was carried out for Cambium Networks Ltd by Element, at the address(es) detailed below.

<input checked="" type="checkbox"/> 30 Meter Open Area Test Site Pershore Airfield, Long Lane, Throckmorton, Worcs, WR10 2JH UK	<input checked="" type="checkbox"/> Element Skelmersdale Unit 1 Pendle Place Skelmersdale West Lancashire WN8 9PN UK
---	--

This report details the configuration of the equipment, the test methods used and any relevant modifications where appropriate.

All test and measurement equipment under the control of the laboratory and requiring calibration is subject to an established programme and procedures to control and maintain measurement standards. The quality management system meets the principles of ISO 9001, and has quality control procedures for monitoring the validity of tests undertaken. Records and sufficient detail are retained to establish an audit trail of calibration records relating to its test results for a defined period. Under control of the established calibration programme, key quantities or values of the test & measurement instrumentation are within specification and comply with the relevant traceable internationally recognised and appropriate standard specifications, which are UKAS calibrated as such where these properties have a significant effect on results. Participation in inter-laboratory comparisons and proficiency testing ensures satisfactory correlation of results conform to Elements own procedures, as well as statistical techniques for analysis of test data providing the appropriate confidence in measurements.

Throughout this report EUT denotes equipment under test.

FCC Site Listing:

Element is accredited for the above sites under the US-EU MRA, Designation number UK0009.

IC Registration Number(s):

Element Hull	3483A
Element North West	3930B

The test site requirements of ANSI C63.4-2014 are met up to 1GHz.

The test site SVSWR requirements of CISPR 16-1-4:2010 are met over the frequency range 1 GHz to 18 GHz.

5 Test Specifications

5.1 Normative References

- FCC 47 CFR Ch. I – Part 90 – Private Land Mobile Radio Services
- ANSI C63.26-2015 – American National Standard for Compliance Testing of Transmitters Used in Licensed Radio Services.
- ANSI C63.4-2014 – American National Standard for Methods of Measurement of Radio-Noise Emissions from Low-Voltage Electrical and Electronic Equipment in the Range of 9 kHz to 40 GHz.

5.2 Deviations from Test Standards

Maximum conducted output power

Due to the nature of the equipment it is not possible to measure the power conducted so a radiated measurement was performed. This measurement was performed at 30m to ensure the measurement was made in the antenna far field.

Spectral Power Density

Due to the nature of the equipment it is not possible to measure the power conducted so a radiated measurement was performed. This measurement was performed at 30m to ensure the measurement was made in the antenna far field.

5.3 Minimisation of reflections

Due to the use of a 30 meter open area test site with no RF absorbing material for the measurement of the fundamental attempts were made to minimise the influence of reflections.

To minimise the reflections the following precautions were taken.

Test performed over a grassed area to try and ensure no sub surface artefacts produce reflections.

The EUT was raised to a height of 4 meters above the ground plane to help reduce the effects of any reflected paths at 30 meters

The EUTs antennas are set with a 2 degree down tilt, and an 8 degree beam width, to negate this down tilt the EUT was rotated 180 degrees through the vertical plane (ie turned upside down to normal operation) and the EUT was angled so the bore sight was parallel to the grassed area.

Due to the increased height of the EUT the measurement antenna was varied between 1 and 6 meters to encompass the height of the EUT and its potential bandwidth

5.4 Open area test site information

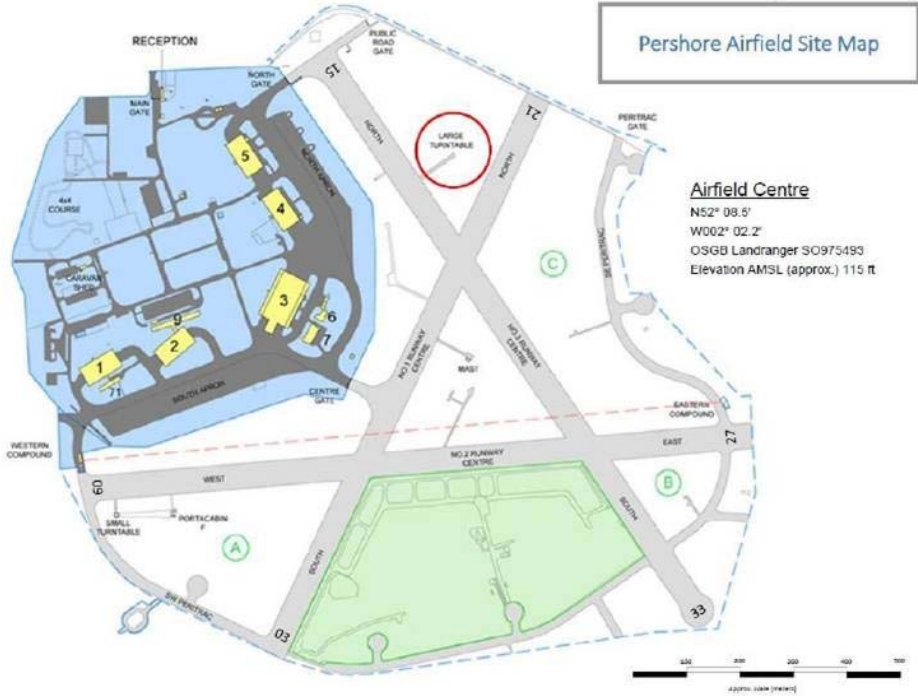

6 Glossary of Terms

§	denotes a section reference from the standard, not this document
AC	Alternating Current
ANSI	American National Standards Institute
BW	bandwidth
C	Celsius
CFR	Code of Federal Regulations
CW	Continuous Wave
dB	decibel
dBm	dB relative to 1 milliwatt
DC	Direct Current
DSSS	Direct Sequence Spread Spectrum
EIRP	Equivalent Isotropically Radiated Power
ERP	Effective Radiated Power
EUT	Equipment Under Test
FCC	Federal Communications Commission
FHSS	Frequency Hopping Spread Spectrum
Hz	hertz
IC	Industry Canada
ITU	International Telecommunication Union
LBT	Listen Before Talk
m	metre
max	maximum
MIMO	Multiple Input and Multiple Output
min	minimum
MRA	Mutual Recognition Agreement
N/A	Not Applicable
PCB	Printed Circuit Board
PDF	Portable Document Format
Pt-mpt	Point-to-multipoint
Pt-pt	Point-to-point
RF	Radio Frequency
RH	Relative Humidity
RMS	Root Mean Square
Rx	receiver
s	second
SVSWR	Site Voltage Standing Wave Ratio
Tx	transmitter
UKAS	United Kingdom Accreditation Service
V	volt
W	watt
Ω	ohm

7 Equipment Under Test

7.1 EUT Identification

- Name: 3GHz PMP 450m
- MAC Address: 0a-00-3e-60-47-a0
- Model Number: 3083HH
- Software Revision: CANOPY 15.2.100 (W)
- Build Level / Revision Number: R4.2

7.2 System Equipment

Equipment listed below forms part of the overall test setup and is required for equipment functionality and/or monitoring during testing. The compliance levels achieved in this report relate only to the EUT and not items given in the following list.

- Name: Netgear 5 port 10/100/1000M switch
- Serial Number: 2N211B3D00F3C
- Model Number: GS605 v4

- Name: Dell Latitude Laptop PC
- Serial Number:
- Model Number: E6440

7.3 EUT Mode of Operation

7.3.1 Transmission

The mode of operation for Transmit tests was as follows:

The unit was transmitting modulated or unmodulated signals with 100 % duty cycle.

Operating Frequencies

Operating frequency band tested 3650-3700 MHz.

Operating modes

There are three unique operating modes. These only affect the antenna radiation pattern.

Sector Mode

This mode produces a broad antenna radiation beam.

Beamforming Mode

This produces a narrow, focused antenna beam.

MU-MIMO mode

This produces several narrow, focused antenna beams.

Modulation Modes

Supported modulation modes are QPSK, 16QAM, 64QAM and 256QAM. Each of these four modulation mode can be configured to be MIMO A or MIMO B. The differences between these MIMO modes are described below.

MIMO A

The data streams transmitted in both horizontal and vertical antenna polarisations are identical.

MIMO B

The data streams transmitted in the horizontal and vertical polarisations are independent.

7.4 EUT Radio Parameters

7.4.1 General

Frequency of operation:	3.65 GHz – 3.70 GHz band
Modulation type(s):	QPSK; 16QAM; 64QAM and 256QAM
Occupied channel bandwidth(s):	5 MHz; 20 MHz and 40 MHz
Channel spacing:	5 MHz; 20 MHz and 40 MHz
Declared output power(s):	40W/40MHz (e.i.r.p)
Nominal Supply Voltage:	48 V dc
Location of notice for license exempt use:	Not applicable, license device
Method of prevention of use on non-US / non-Canadian frequencies:	Not stated
Duty cycle:	100 % for testing only

7.4.2 Antennas

Type:	Integral antenna
Frequency range:	3.65 GHz – 3.70 GHz
Impedance:	50 Ω
Gain:	16 dBi
Connector type:	Not applicable, integral antenna
Length:	500 × 650 × 120
Weight:	20 kg
Mounting:	Professionally installed

7.4.3 Product specific declarations

Multiple antenna configuration(s), e.g. MIMO:	Sector, Beamforming and MU-MIMO
Fixed pt-pt operations (yes/no):	Yes
Installation manual advice on pt-pt operational restrictions (yes/no):	N/A Professionally installed
Fixed pt-mpt operations (yes/no):	Yes
Simultaneous tx (yes/no):	Yes

7.5 EUT Description

The EUT is a point-to-multipoint (PMP) wireless broadband platform working in the band 3.65 GHz – 3.70 GHz.

8 Modifications

No modifications were performed during this assessment.

9 EUT Test Setup

9.1 Block Diagram

The following diagram shows basic EUT interconnections with cable type and cable lengths identified:

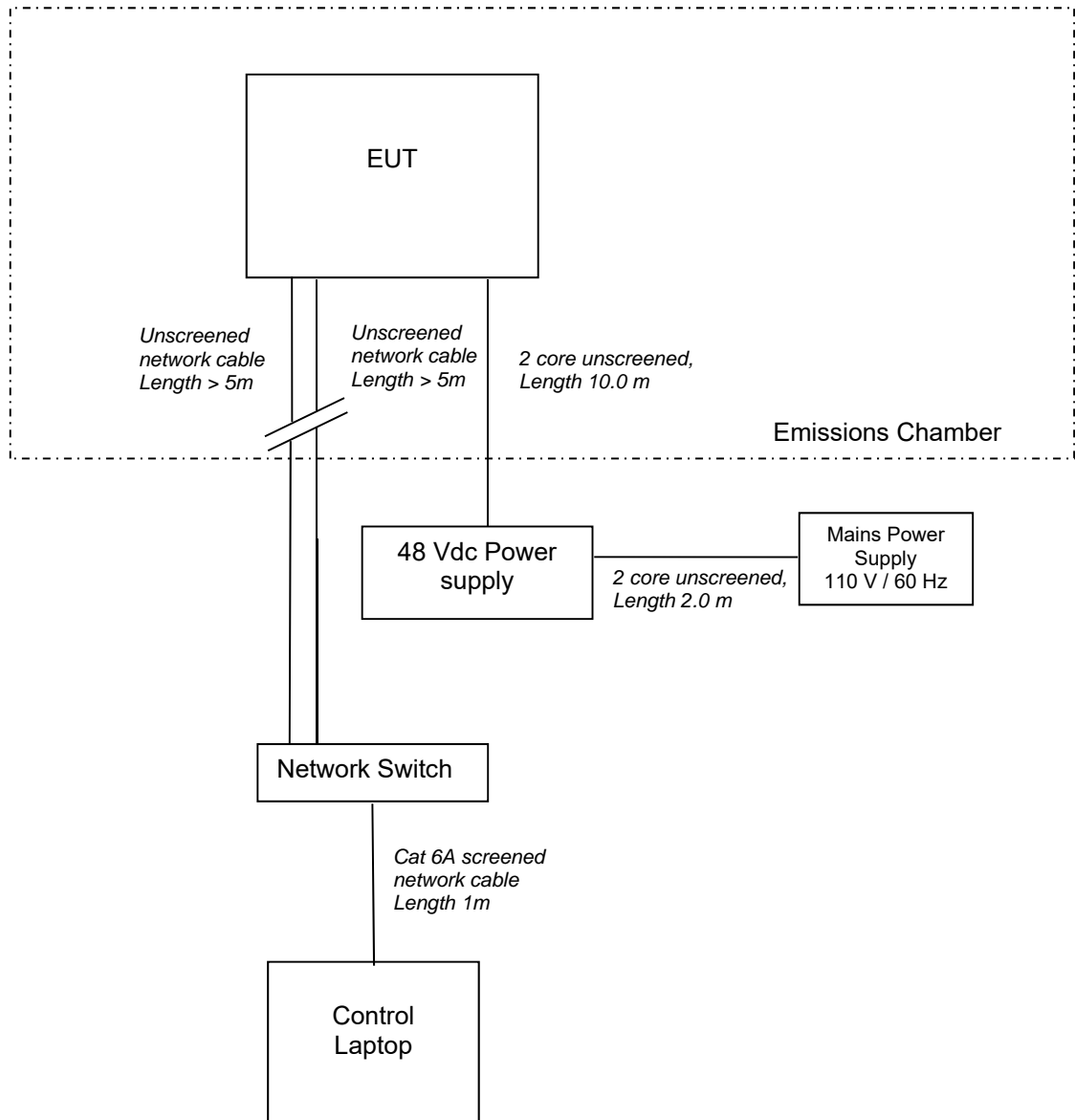

9.2 General Set-up Photograph

The following photograph shows basic EUT set-up:



10 General Technical Parameters

10.1 Normal Conditions

The E U T was tested under the normal environmental conditions of the test laboratory, except where otherwise stated. The normal power source applied was 48 V dc from the adaptor.

10.2 Varying Test Conditions

There are no specific frequency stability requirements for the type of device. The results contained in this report demonstrate that the occupied bandwidth is contained within the authorised band and the manufacturer has declared sufficient frequency stability (refer to section 7.4).

Variation of supply voltage is required to ensure stability of the declared output power. During carrier power testing the following variations were made:

	Category	Nominal	Variation
<input type="checkbox"/>	Mains	110 V ac +/-2 %	85 % and 115 %
<input type="checkbox"/>	Battery	New battery	N/A
<input checked="" type="checkbox"/>	Power supply	48 V dc	85 % and 115 %

11 Transmitter Unwanted Emissions

11.1 Definitions

Spurious emissions

Emissions on a frequency or frequencies, which are outside the necessary bandwidth and the level of which may be reduced without affecting the corresponding transmission of information. Spurious emissions include harmonic emissions, parasitic emissions, intermodulation products and frequency conversion products, but exclude out-of-band emissions.

11.2 Test Parameters

Test Location:	Element Skelmersdale
Test Chamber:	Radio Chamber
Test Standard and Clause:	Part 90.1323
EUT Frequencies Measured:	3652.5 MHz, 3675 MHz and 3697.5 MHz
EUT Channel Bandwidths:	5 MHz
Deviations From Standard:	None
Measurement BW:	30 MHz to 1 GHz: 120 kHz Above 1 GHz: 1 MHz
Measurement Detector:	Up to 1 GHz: Peak Above 1 GHz: Peak

Environmental Conditions (Normal Environment)

Temperature: 24 °C	+15 °C to +35 °C (as declared)
Humidity: 60 % RH	20 % RH to 75 % RH (as declared)
Supply: 48 V dc	48 V dc (as declared)

11.3 Test Limit

Frequency (MHz)	Field Strength ($\mu\text{V/m}$ at 3 m)
30 to 40000	12968

11.4 Test Method

With the EUT setup as per section 9 of this report and connected as per Figure i, the emissions from the EUT were measured on a spectrum analyzer / EMI receiver.

Radiated electromagnetic emissions from the EUT are checked first by preview scans. Preview scans for all spectrum and modulation characteristics are checked, using a peak detector and where applicable worst-case determined for function, operation, orientation, etc. for both vertical and horizontal polarisations. Pre-scan plots are shown with a peak detector and 100 kHz RBW.

If the EUT connects to auxiliary equipment and is table or floor standing, the configurations prescribed in ANSI C63.26 are followed. Alternatively, a layout closest to normal use (as declared by the provider) is employed, (see EUT setup photographs for more detail).

Emissions between 30 MHz and 1 GHz are measured using calibrated broadband antennas. Emissions above 1 GHz are characterized using standard gain horn antennas. Pre-amplifiers and filters are used where required. Care is taken to ensure that test receiver resolution bandwidth, video bandwidth and detector type(s) meet the regulatory requirements.

For both horizontal and vertical polarizations, the EUT is then rotated through 360 degrees in azimuth until the highest emission is detected. At the previously determined azimuth the test antenna is raised and lowered from 1 to 4 m in height until a maximum emission level is detected, this maximum value is recorded.

Power values measured on the test receiver / analyzer are converted to field strength, FS, in dB μ V/m at the regulatory distance, using:

$$FS = PR + CL + AF - PA + DC - CF$$

Where,

PR is the power recorded on the receiver / spectrum analyzer in dB μ V;

CL is the cable loss in dB;

AF is the test antenna factor in dB/m;

PA is the pre-amplifier gain in dB (where used);

DC is the duty correction factor in dB (where used, e.g. harmonics of pulsed fundamental);

CF is the distance factor in dB (where measurement distance different to limit distance);

This field strength value is then compared with the regulatory limit.

Figure i Test Setup

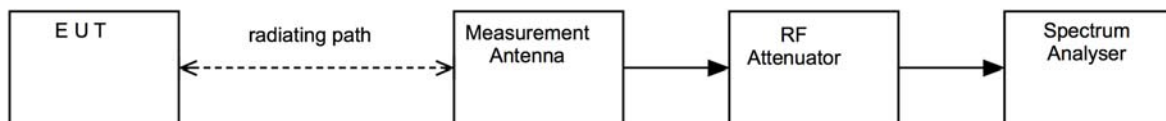

11.5 Test Set-up Photograph

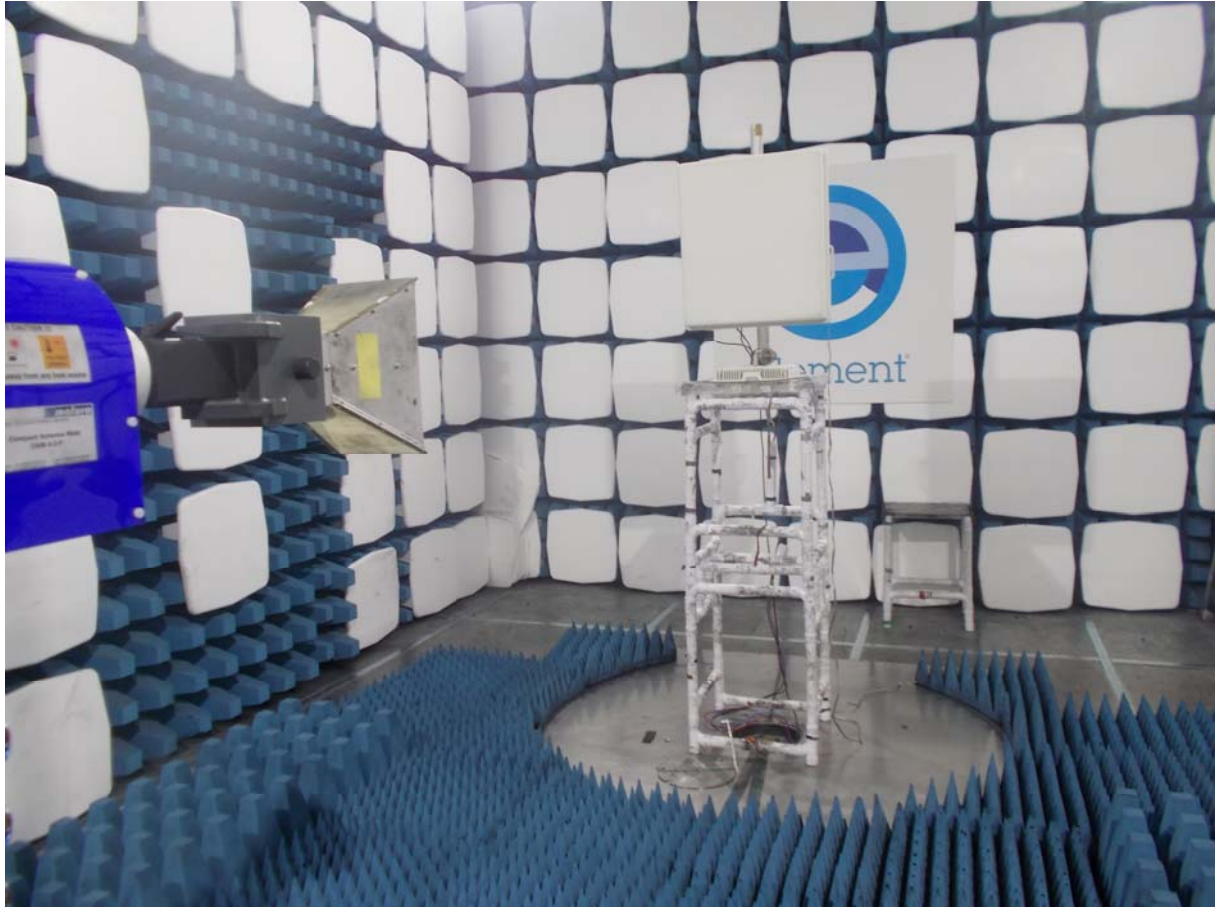

11.6 Test Equipment

Equipment Type	Manufacturer	Equipment Description	Element No	Due For Calibration
CBL611/A	Chase	Bilog	U573	2019-08-02
ESR7	R&S	EMI Receiver	U456	2018-09-12
3115	EMCO	1-18GHz Horn	L139	2019-09-25
FSU50	R&S	Spectrum Analyser	U544	2019-05-22
20240-20	Flann	Horn 18-26GHz (&U330)	L300	2020-04-24
22240-20	Flann	Standard Gain Horn 26-40	L301	2019-08-10

11.7 Test Results

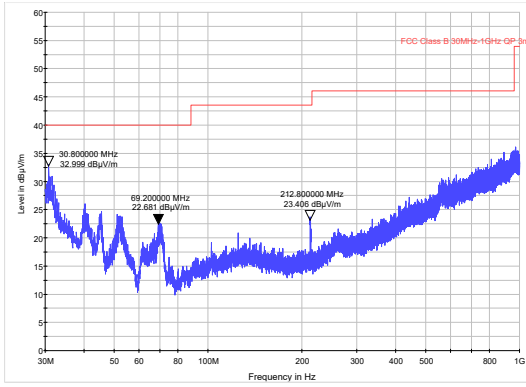

30 MHz to 1 GHz

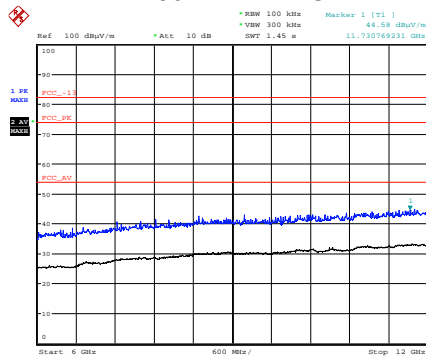

Date: 10.JUL.2018 01:26:07

6 GHz to 12 GHz

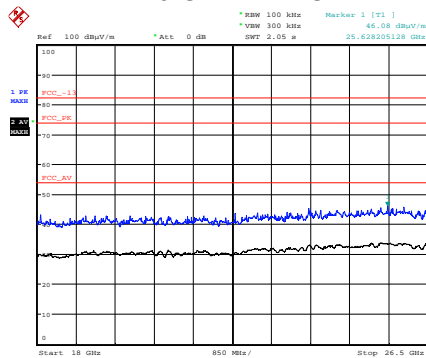

Date: 10.JUL.2018 22:34:08

18 GHz to 26.5 GHz

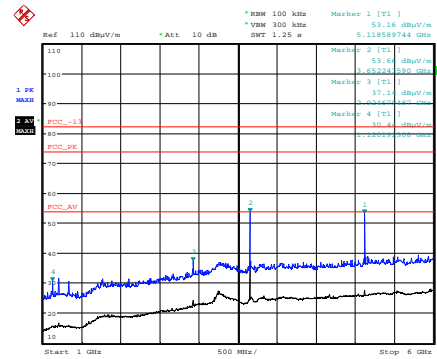

Date: 10.JUL.2018 01:19:28

1 GHz to 6 GHz

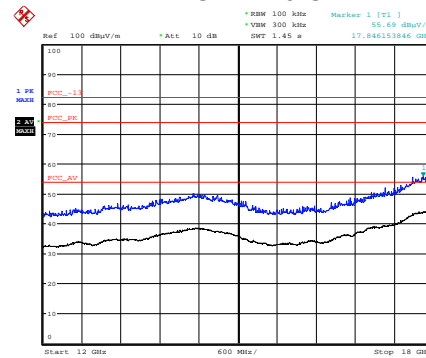

Date: 10.JUL.2018 01:23:39

12 GHz to 18 GHz

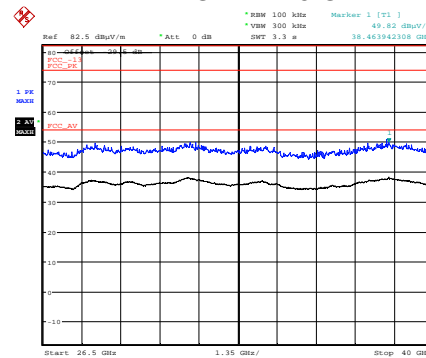

Date: 11.JUL.2018 01:22:17

26.5 GHz to 40 GHz

Beamforming; Power setting: 34.5; QPSK MIMO; Channel: 3652.5 MHz										
Detector	Freq. (MHz)	Meas'd Emission (dBµV)	Cable Loss (dB)	Antenna Factor (dB/m)	Pre-amp Gain (dB)	Duty Cycle Corr'n (dB)	Distance Extrap'n Factor (dB)	Field Strength (dBµV/m)	Field Strength (µV/m)	Limit (µV/m)
No emissions within 20 dB of the limit										

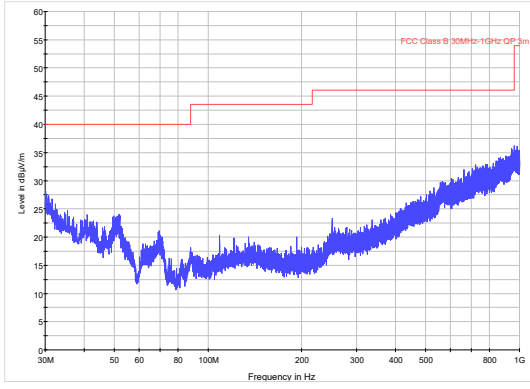

30 MHz to 1 GHz

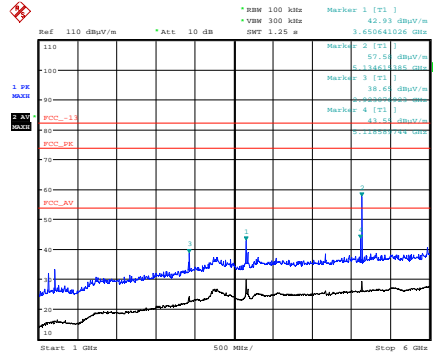

1 GHz to 6 GHz

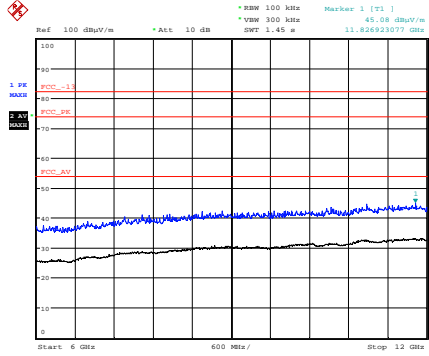

6 GHz to 12 GHz

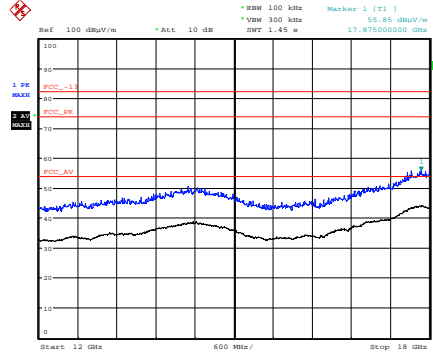

12 GHz to 18 GHz

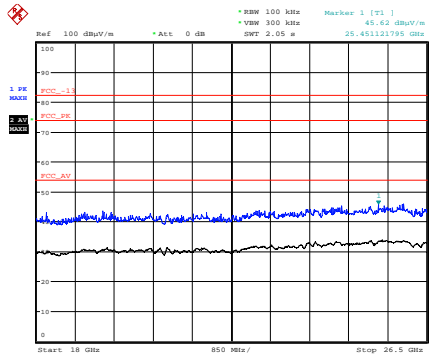

18 GHz to 26.5 GHz

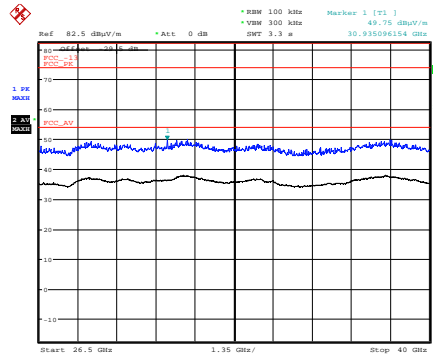

26.5 GHz to 40 GHz

Beamforming; Power setting: 34.5; QPSK MIMO; Channel: 3675 MHz										
Detector	Freq. (MHz)	Meas'd Emission (dBµV)	Cable Loss (dB)	Antenna Factor (dB/m)	Pre-amp Gain (dB)	Duty Cycle Corr'n (dB)	Distance Extrap'n Factor (dB)	Field Strength (dBµV/m)	Field Strength (µV/m)	Limit (µV/m)
No emissions within 20 dB of the limit										

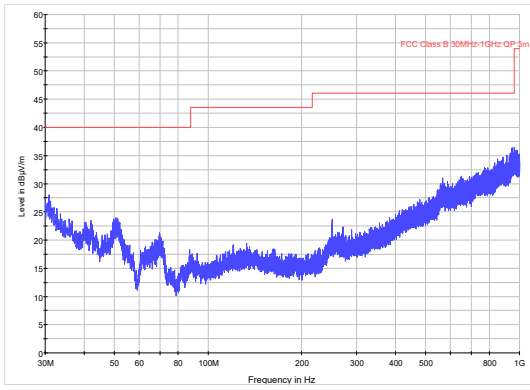

30 MHz to 1 GHz

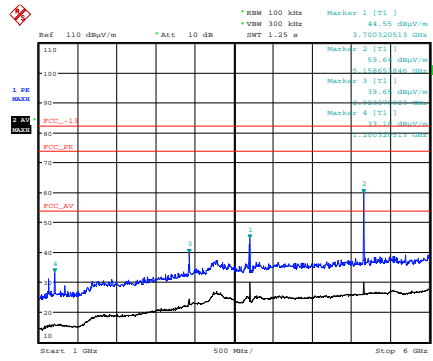

Date: 10.JUL.2018 01:37:48

1 GHz to 6 GHz

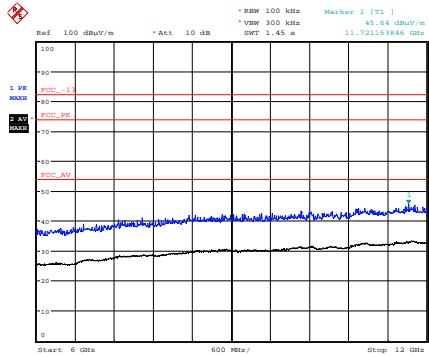

Date: 10.JUL.2018 01:35:13

6 GHz to 12 GHz

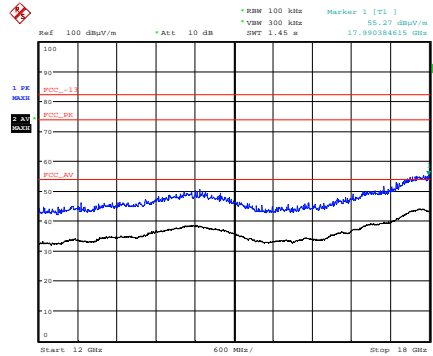

Date: 10.JUL.2018 01:34:19

12 GHz to 18 GHz

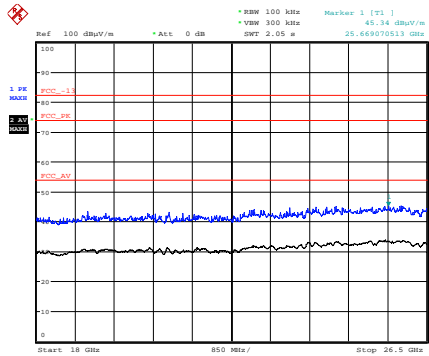

Date: 10.JUL.2018 22:49:49

18 GHz to 26.5 GHz

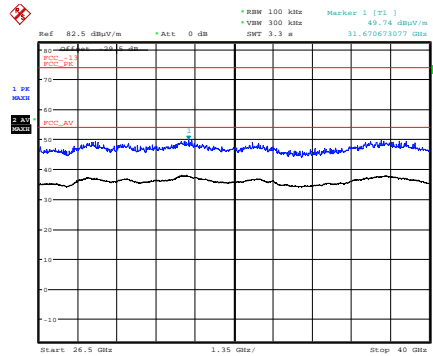

Date: 11.JUL.2018 01:36:48

26.5 GHz to 40 GHz

Beamforming; Power setting: 34.5; QPSK MIMO; Channel: 3697.5 MHz										
Detector	Freq. (MHz)	Meas'd Emission (dBµV)	Cable Loss (dB)	Antenna Factor (dB/m)	Pre-amp Gain (dB)	Duty Cycle Corr'n (dB)	Distance Extrap'n Factor (dB)	Field Strength (dBµV/m)	Field Strength (µV/m)	Limit (µV/m)
No emissions within 20 dB of the limit										

Standby mode

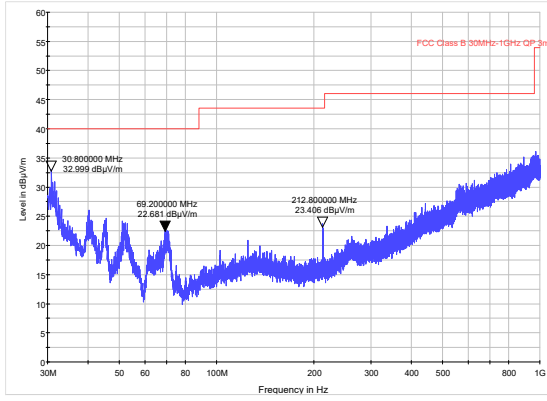

30 MHz to 1 GHz

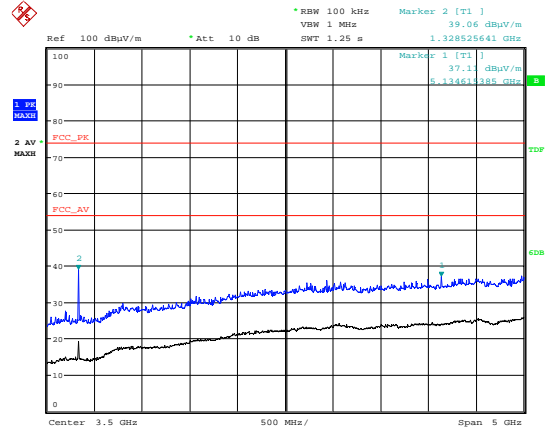

Date: 4.AUG.2018 16:13:55

1 GHz to 6 GHz

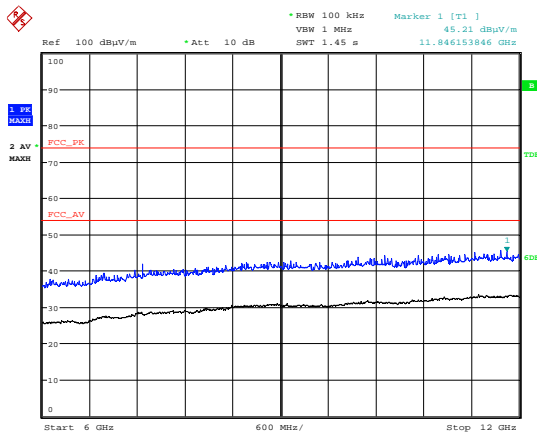

Date: 4.AUG.2018 14:40:31

6 GHz to 12 GHz

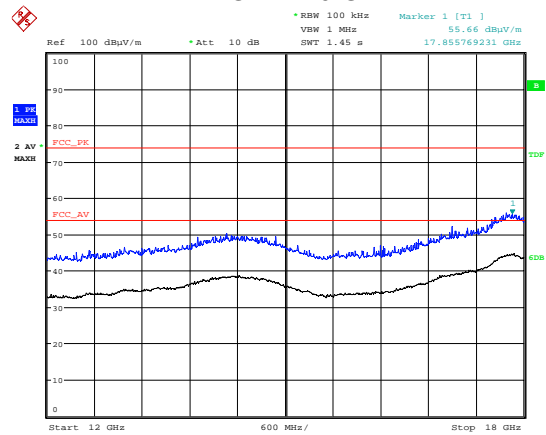

Date: 4.AUG.2018 14:38:34

12 GHz to 18 GHz

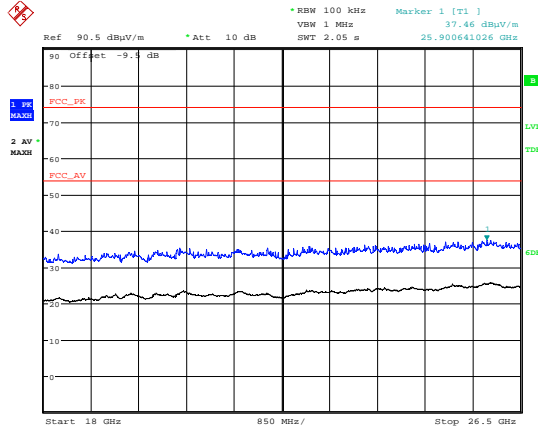

Date: 4.AUG.2018 16:01:41

18 GHz to 26.5 GHz

Part 15 B unit in standby mode all the electronics exercised										
Detector	Freq. (MHz)	Meas'd Emission (dBµV)	Cable Loss (dB)	Antenna Factor (dB/m)	Pre-amp Gain (dB)	Duty Cycle Corr'n (dB)	Distance Extrap'n Factor (dB)	Field Strength (dBµV/m)	Field Strength (µV/m)	Limit (µV/m)
No emissions within 20 dB of the limit										

12 Occupied Bandwidth

12.1 Definition

The OBW is the frequency bandwidth such that, below its lower and above its upper frequency limits, the mean powers are each equal to 0.5% of the total mean power of the given emission.

12.2 Test Parameters

Test Location:	Element Skelmersdale
Test Chamber:	Radio Chamber
Test Standard and Clause:	Part 90.209
EUT Channels / Frequencies Measured:	Low / Mid / High
EUT Channel Bandwidths:	5 MHz, 20 MHz and 40 MHz
EUT Test Modulations:	QPSK MIMO A & B, 16QAM MIMO A & B, 64QAM MIMO A & B and 256QAM MIMO A & B
Deviations From Standard:	None
Measurement BW: (Requirement: 1% to 5% OBW)	200 kHz and 500 kHz
Spectrum Analyzer Video BW: (requirement at least 3x RBW)	500 kHz and 2 MHz
Measurement Span: (requirement 2 to 5 times OBW)	7.5 MHz, 30 MHz and 60 MHz
Measurement Detector:	Peak

Environmental Conditions (Normal Environment)

Temperature: 24 °C	+15 °C to +35 °C (as declared)
Humidity: 60 % RH	20 % RH to 75 % RH (as declared)
Supply: 48 V dc	48 V dc (as declared)

12.3 Test Limit

Bandwidths for radiolocation stations in the 420-450 MHz band and for stations operating in bands subject to this footnote will be reviewed and authorized on a case-by-case basis.

12.4 Test Method

With the EUT setup as per section 9 of this report and connected as per Figure iii, the bandwidth of the EUT was measured on a spectrum analyser.

The measurements were performed with EUT set at its maximum duty. All modulation schemes, data rates and power settings were used to observe the worst-case configuration in each bandwidth.

Figure iii Test Setup



12.5 Test Equipment

Equipment Type	Manufacturer	Equipment Description	Element No	Due For Calibration
3115	EMCO	1-18GHz Horn	L139	2019-09-25
FSU50	R&S	Spectrum Analyser	U544	2019-05-22

12.6 Test Results

5 MHz Bandwidth Beamforming

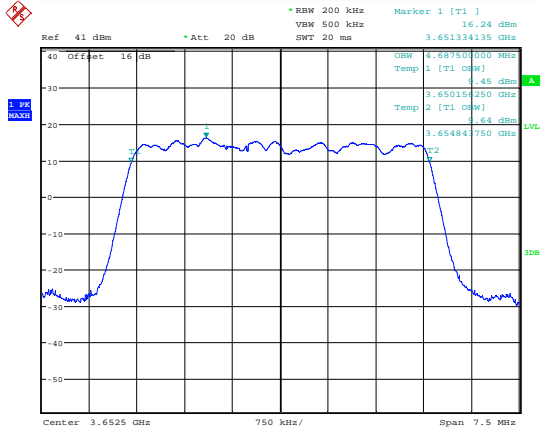

Date: 7.JUL.2018 18:33:48

99 % Bandwidth; QPSK; 3652.5 MHz; MIMO A.

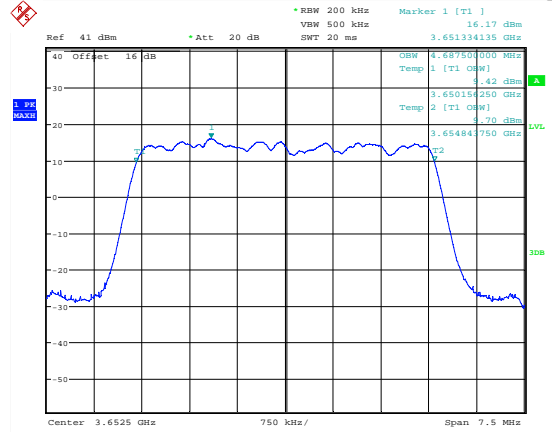

Date: 7.JUL.2018 18:31:01

99 % Bandwidth; QPSK; 3652.5 MHz; MIMO B.

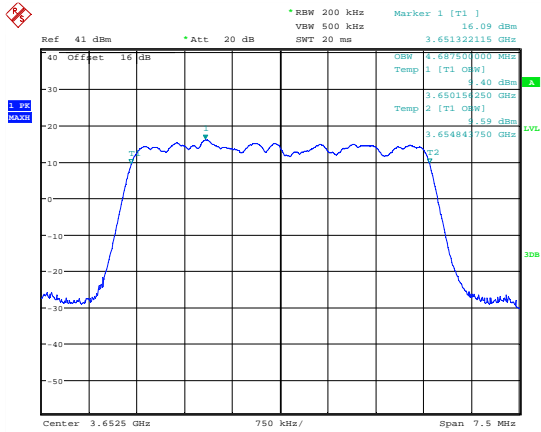

Date: 7.JUL.2018 18:33:10

99 % Bandwidth; 16QAM; 3652.5 MHz; MIMO A.

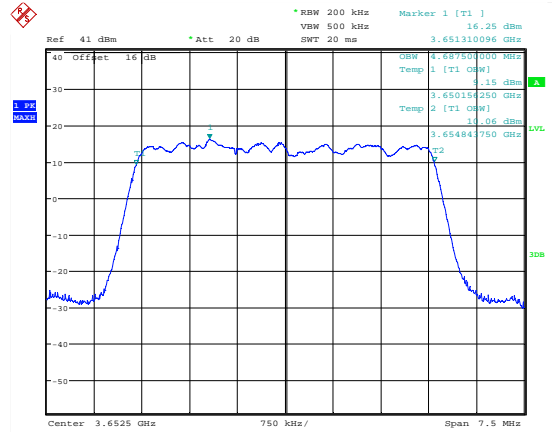

Date: 7.JUL.2018 18:29:56

99 % Bandwidth; 16QAM; 3652.5 MHz; MIMO B.

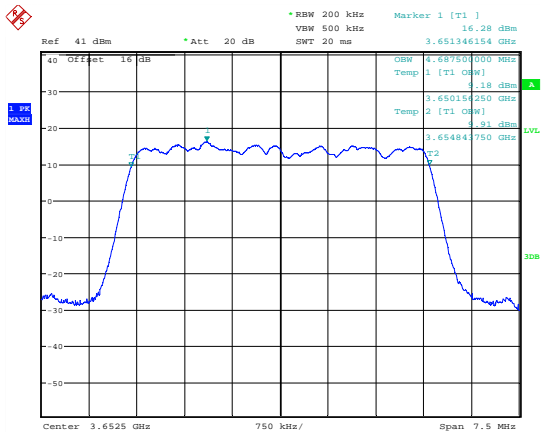

Date: 7.JUL.2018 18:32:23

99 % Bandwidth; 64QAM; 3652.5 MHz; MIMO A.

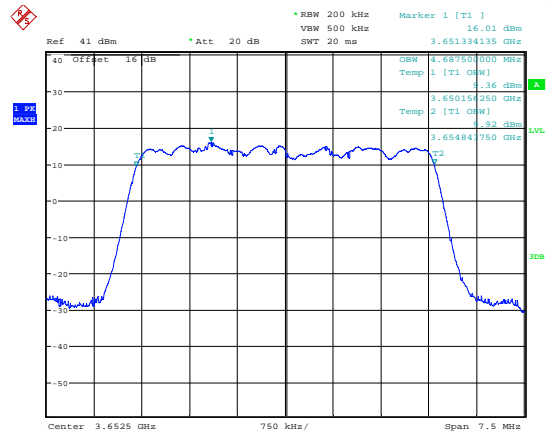

Date: 7.JUL.2018 18:29:16

99 % Bandwidth; 64QAM; 3652.5 MHz; MIMO B.

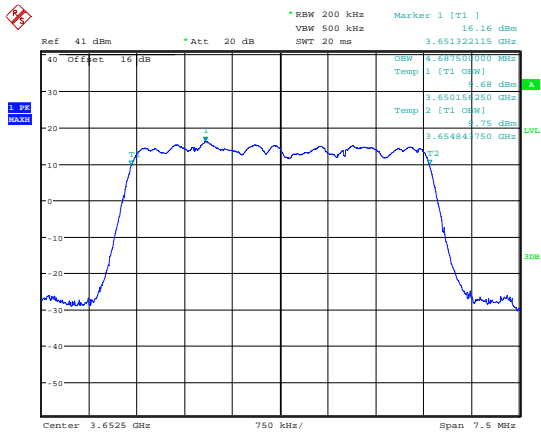

Date: 7 JUL 2018 18:31:39

99 % Bandwidth; 256QAM; 3652.5 MHz; MIMO A.

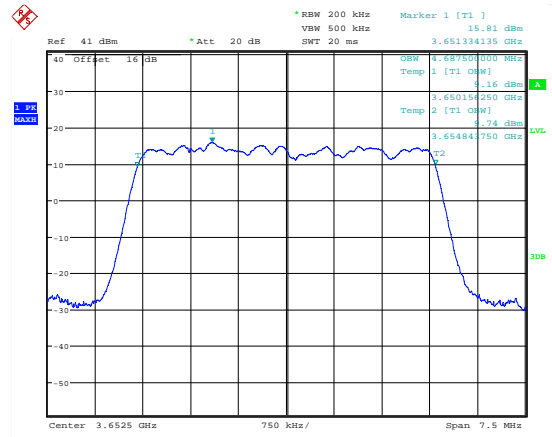

Date: 7 JUL 2018 18:28:38

99 % Bandwidth; 256QAM; 3652.5 MHz; MIMO B.

Bottom Channel 5 MHz bandwidth						
Frequency (MHz)	Modulation Mode	MIMO	FL (MHz)	FH (MHz)	99 % Bandwidth (kHz)	Result
3652.5	QPSK	A	3650.156	3654.843	4687	Pass
3652.5	QPSK	B	3650.156	3654.843	4687	Pass
3652.5	16QAM	A	3650.156	3654.843	4687	Pass
3652.5	16QAM	B	3650.156	3654.843	4687	Pass
3652.5	64QAM	A	3650.156	3654.843	4687	Pass
3652.5	64QAM	B	3650.156	3654.843	4687	Pass
3652.5	256QAM	A	3650.156	3654.843	4687	Pass
3652.5	256QAM	B	3650.156	3654.843	4687	Pass

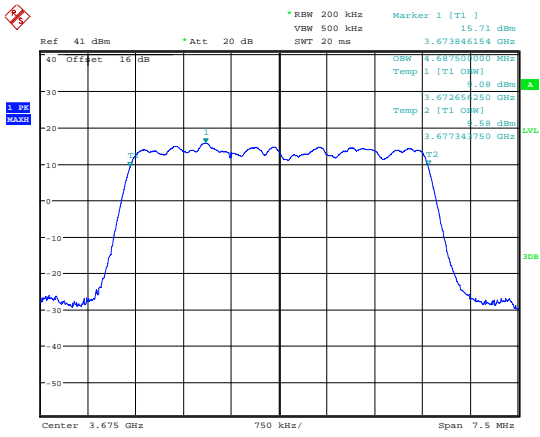

Date: 7.JUL.2018 18:50:33

99 % Bandwidth; QPSK; 3675 MHz; MIMO A.

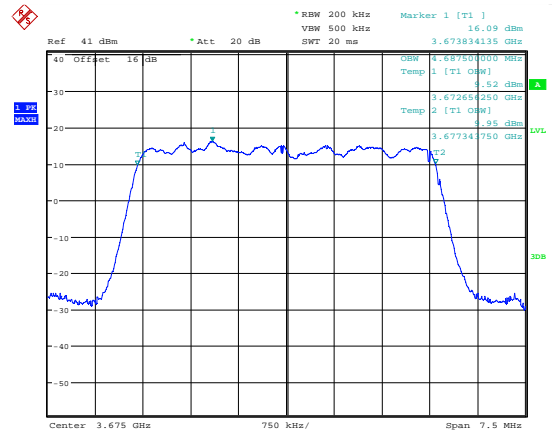

Date: 7.JUL.2018 18:53:21

99 % Bandwidth; QPSK; 3675 MHz; MIMO B.

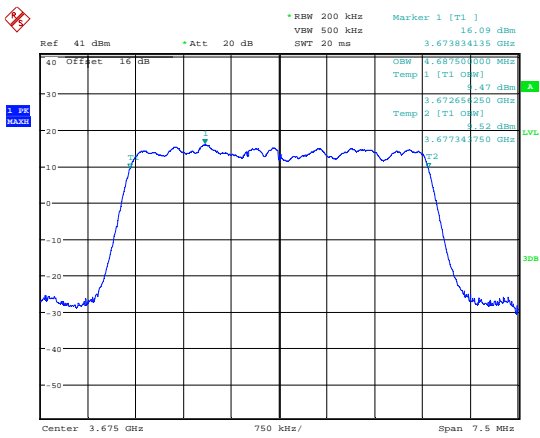

Date: 7.JUL.2018 18:51:14

99 % Bandwidth; 16QAM; 3675 MHz; MIMO A.

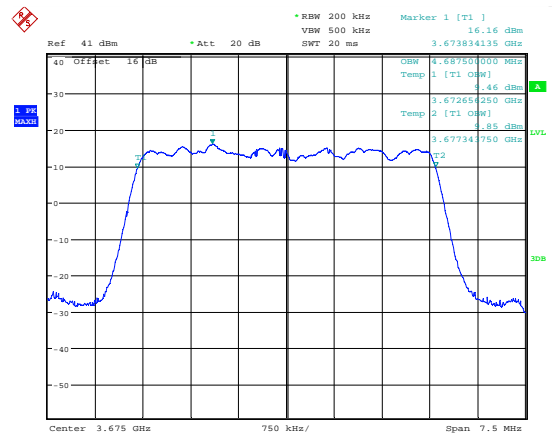

Date: 7.JUL.2018 18:54:06

99 % Bandwidth; 16QAM; 3675 MHz; MIMO B.

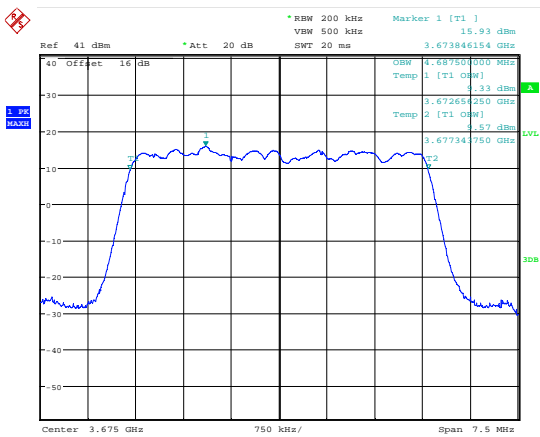

Date: 7.JUL.2018 18:52:08

99 % Bandwidth; 64QAM; 3675 MHz; MIMO A.

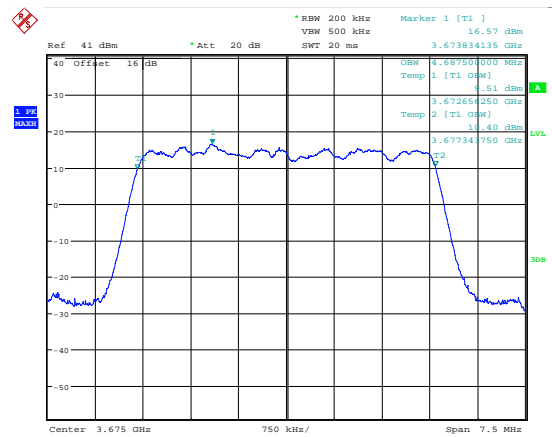

Date: 7.JUL.2018 18:54:51

99 % Bandwidth; 64QAM; 3675 MHz; MIMO B.

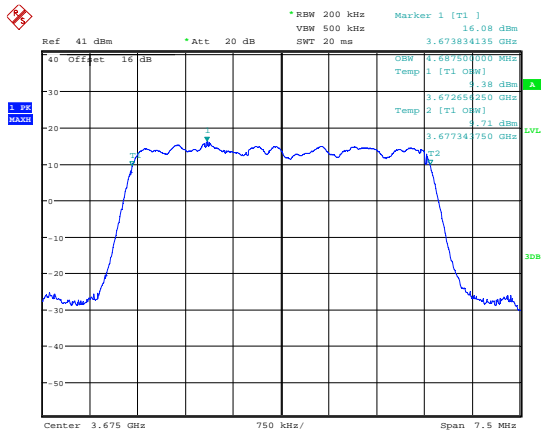

Date: 7.JUL.2018 18:52:46

99 % Bandwidth; 256QAM; 3675 MHz; MIMO A.

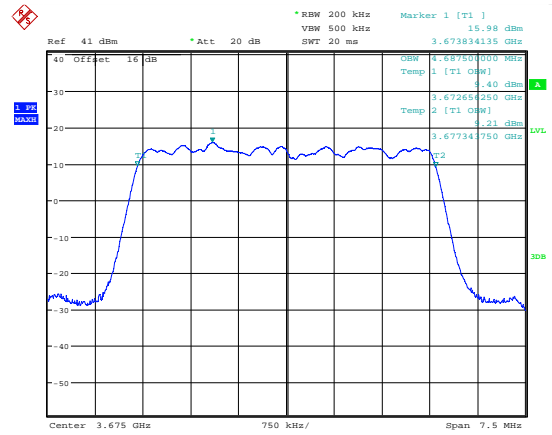

Date: 7.JUL.2018 18:55:48

99 % Bandwidth; 256QAM; 3675 MHz; MIMO B.

Middle Channel 5 MHz bandwidth						
Frequency (MHz)	Modulation Mode	MIMO	FL (MHz)	FH (MHz)	99 % Bandwidth (kHz)	Result
3675	QPSK	A	3672.656	3677.343	4687	Pass
3675	QPSK	B	3672.656	3677.343	4687	Pass
3675	16QAM	A	3672.656	3677.343	4687	Pass
3675	16QAM	B	3672.656	3677.343	4687	Pass
3675	64QAM	A	3672.656	3677.343	4687	Pass
3675	64QAM	B	3672.656	3677.343	4687	Pass
3675	256QAM	A	3672.656	3677.343	4687	Pass
3675	256QAM	B	3672.656	3677.343	4687	Pass

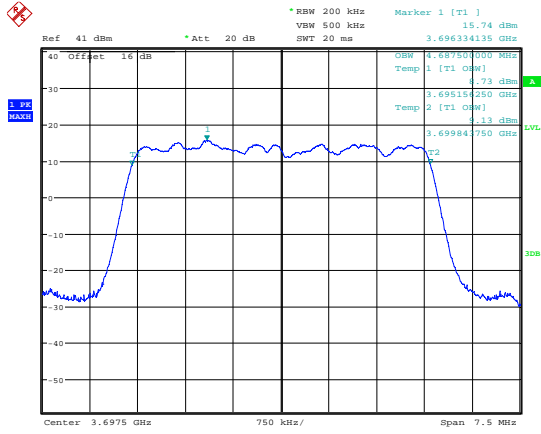

Date: 7.JUL.2018 19:14:39
99 % Bandwidth; QPSK; 3697.5 MHz; MIMO A.

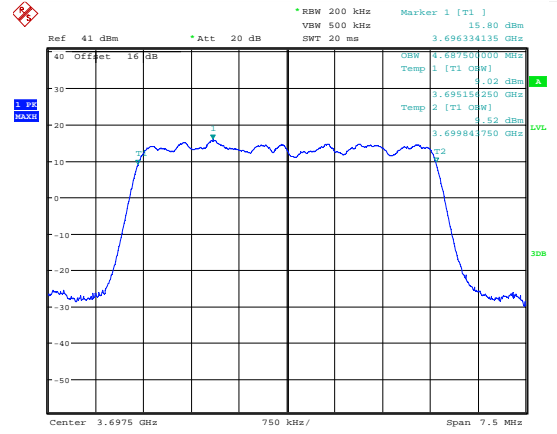

Date: 7.JUL.2018 19:12:07
99 % Bandwidth; QPSK; 3697.5 MHz; MIMO B.

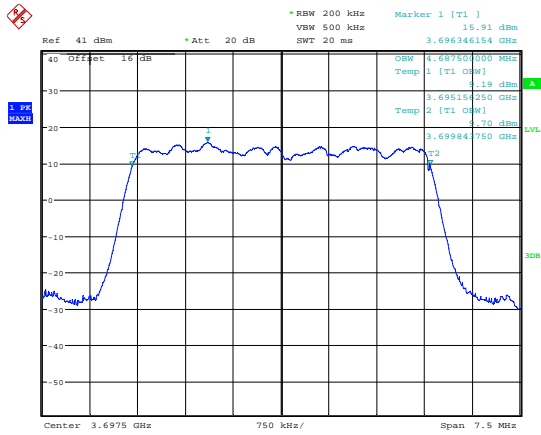

Date: 7.JUL.2018 19:13:58
99 % Bandwidth; 16QAM; 3697.5 MHz; MIMO A.

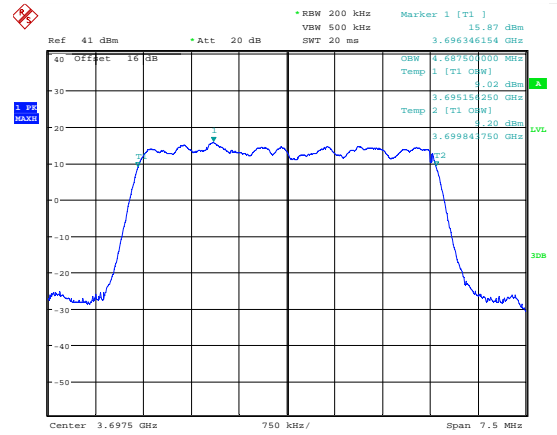

Date: 7.JUL.2018 19:11:09
99 % Bandwidth; 16QAM; 3697.5 MHz; MIMO B.

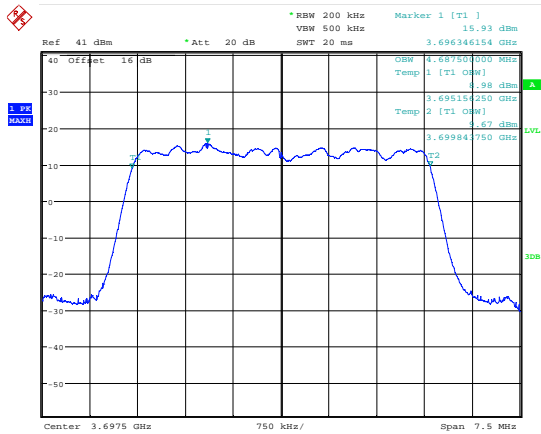

Date: 7.JUL.2018 19:13:25
99 % Bandwidth; 64QAM; 3697.5 MHz; MIMO A.

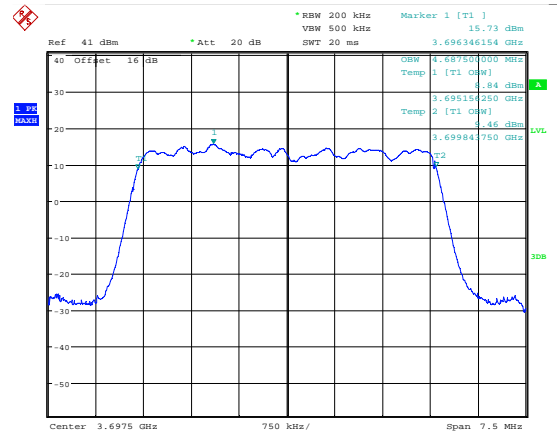

Date: 7.JUL.2018 19:10:36
99 % Bandwidth; 64QAM; 3697.5 MHz; MIMO B.

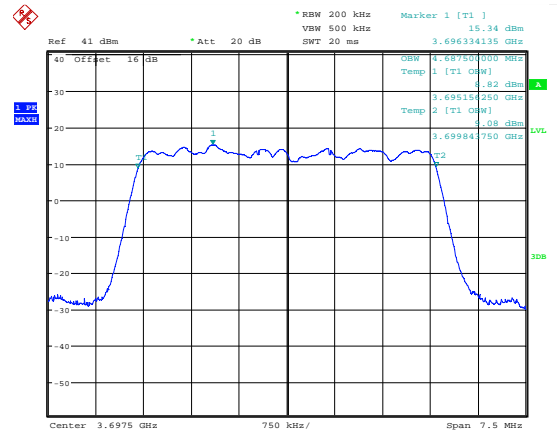
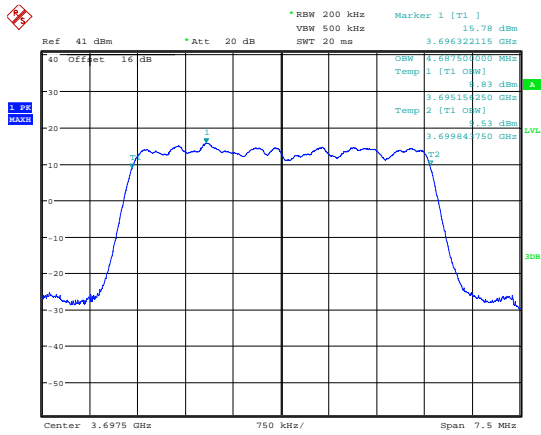

Date: 7.JUL.2018 19:12:47

Date: 7.JUL.2018 19:10:00

99 % Bandwidth; 256QAM; 3697.5 MHz; MIMO A.

99 % Bandwidth; 256QAM; 3697.5 MHz; MIMO B.

Top Channel 5 MHz bandwidth						
Frequency (MHz)	Modulation Mode	MIMO	FL (MHz)	FH (MHz)	99 % Bandwidth (kHz)	Result
3697.5	QPSK	A	3695.156	3699.843	4687	Pass
3697.5	QPSK	B	3695.156	3699.843	4687	Pass
3697.5	16QAM	A	3695.156	3699.843	4687	Pass
3697.5	16QAM	B	3695.156	3699.843	4687	Pass
3697.5	64QAM	A	3695.156	3699.843	4687	Pass
3697.5	64QAM	B	3695.156	3699.843	4687	Pass
3697.5	256QAM	A	3695.156	3699.843	4687	Pass
3697.5	256QAM	B	3695.156	3699.843	4687	Pass

5 MHz Bandwidth Sector

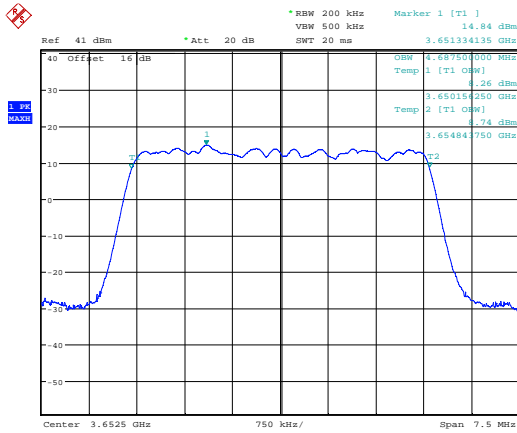

Date: 7.JUL.2018 18:12:34

99 % Bandwidth; QPSK; 3652.5 MHz; MIMO A.

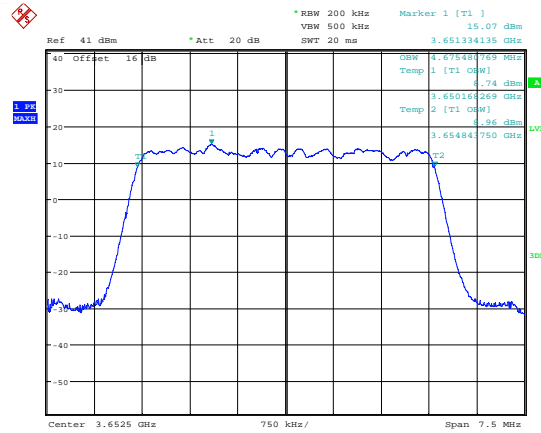

Date: 7.JUL.2018 18:19:07

99 % Bandwidth; QPSK; 3652.5 MHz; MIMO B.

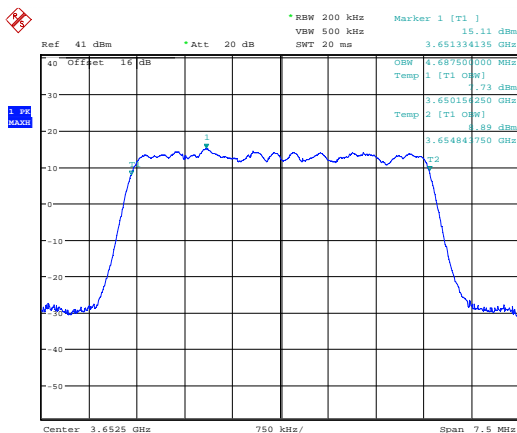

Date: 7.JUL.2018 18:15:34

99 % Bandwidth; 16QAM; 3652.5 MHz; MIMO A.

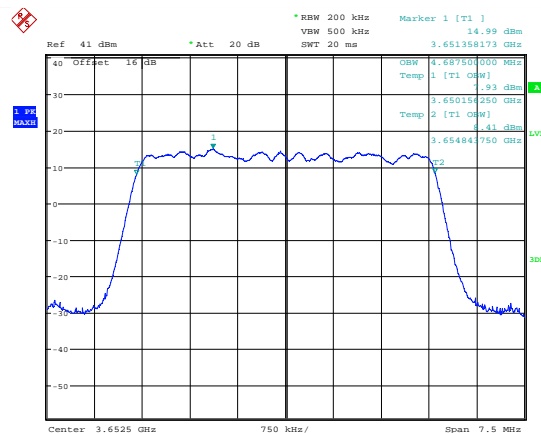

Date: 7.JUL.2018 18:19:43

99 % Bandwidth; 16QAM; 3652.5 MHz; MIMO B.

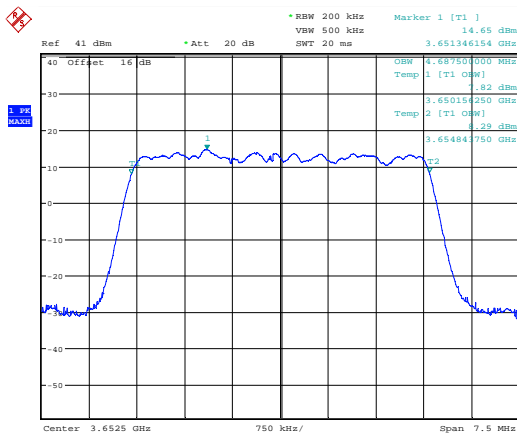

Date: 7.JUL.2018 18:17:34

99 % Bandwidth; 64QAM; 3652.5 MHz; MIMO A.

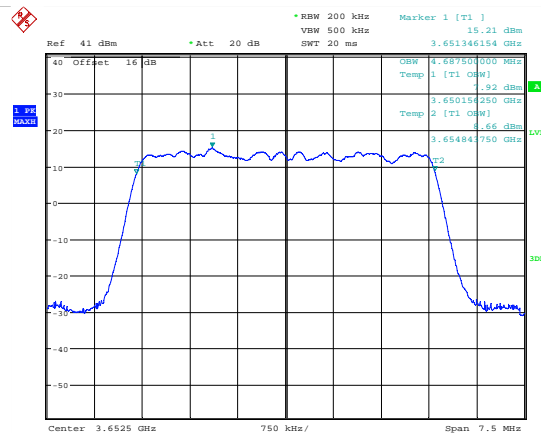

Date: 7.JUL.2018 18:20:34

99 % Bandwidth; 64QAM; 3652.5 MHz; MIMO B.

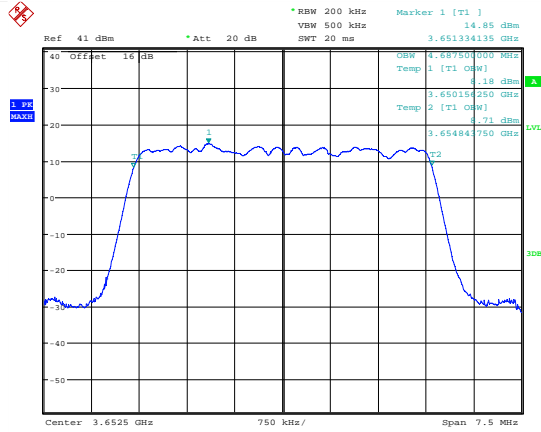
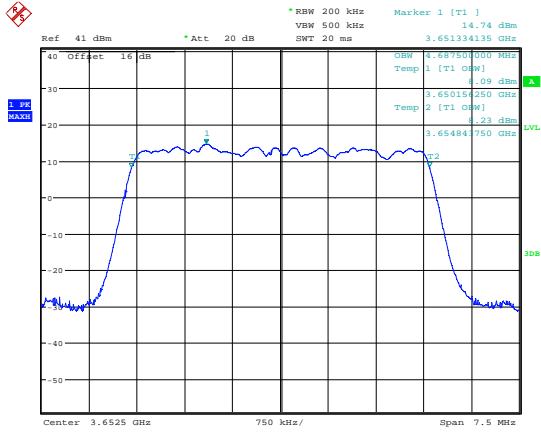

Date: 7.JUL.2018 18:18:37

Date: 7.JUL.2018 18:21:33

99 % Bandwidth; 256QAM; 3652.5 MHz; MIMO A.

99 % Bandwidth; 256QAM; 3652.5 MHz; MIMO B.

Bottom Channel 5 MHz bandwidth						
Frequency (MHz)	Modulation Mode	MIMO	FL (MHz)	FH (MHz)	99 % Bandwidth (kHz)	Result
3652.5	QPSK	A	3650.156	3654.843	4687	Pass
3652.5	QPSK	B	3650.168	3654.843	4675	Pass
3652.5	16QAM	A	3650.156	3654.843	4687	Pass
3652.5	16QAM	B	3650.156	3654.843	4687	Pass
3652.5	64QAM	A	3650.156	3654.843	4687	Pass
3652.5	64QAM	B	3650.156	3654.843	4687	Pass
3652.5	256QAM	A	3650.156	3654.843	4687	Pass
3652.5	256QAM	B	3650.156	3654.843	4687	Pass

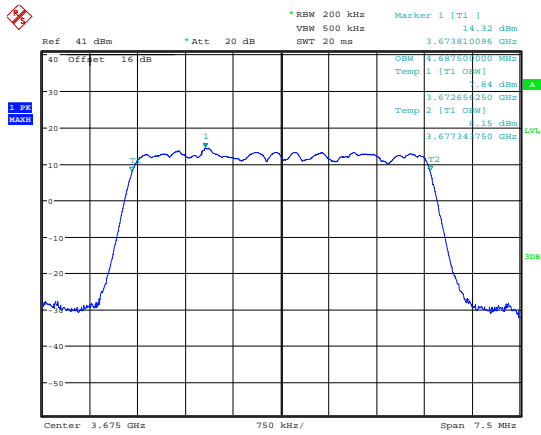

Date: 7.JUL.2018 18:47:27

99 % Bandwidth QPSK; 3675 MHz; MIMO A.

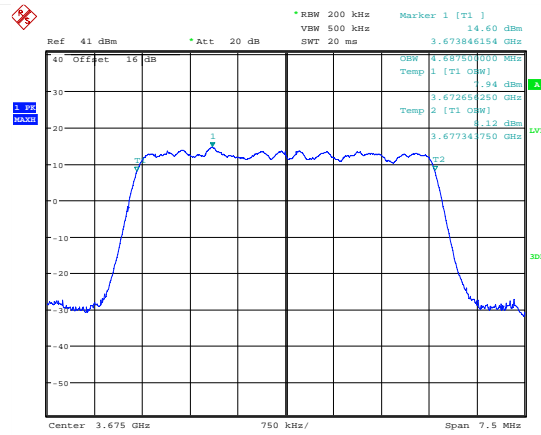

Date: 7.JUL.2018 18:44:43

99 % Bandwidth QPSK; 3675 MHz; MIMO B.

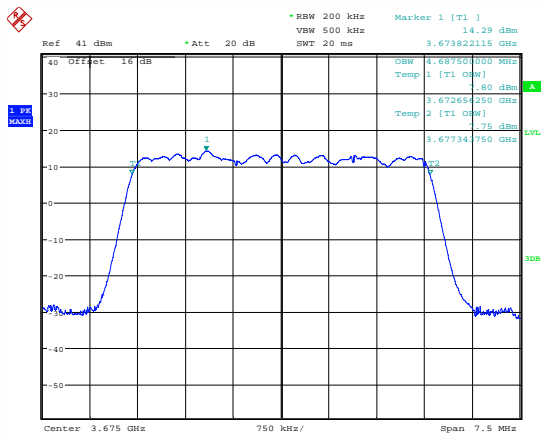

Date: 7.JUL.2018 18:46:39

99 % Bandwidth; 16QAM; 3675 MHz; MIMO A.

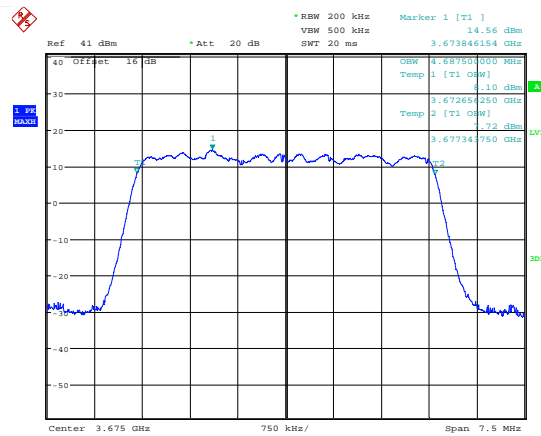

Date: 7.JUL.2018 18:43:55

99 % Bandwidth; 16QAM; 3675 MHz; MIMO B.

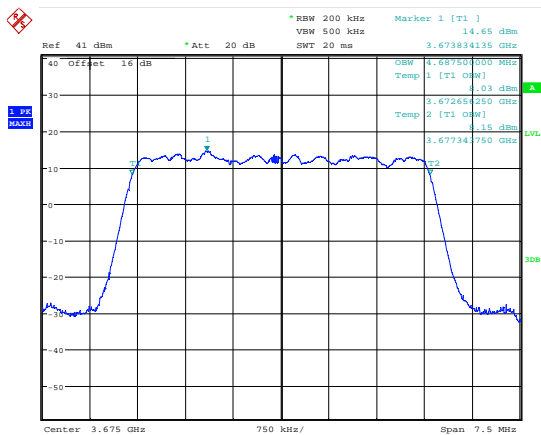

Date: 7.JUL.2018 18:45:57

99 % Bandwidth; 64QAM; 3675 MHz; MIMO A.

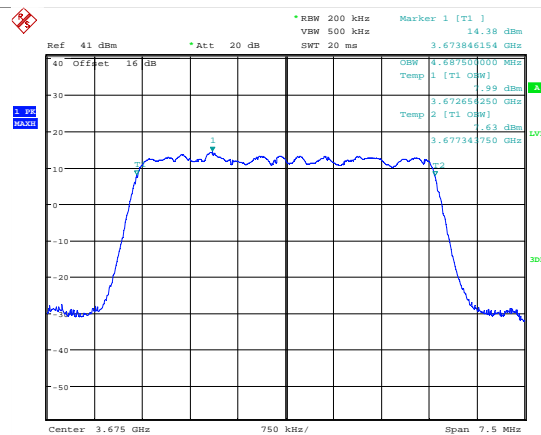

Date: 7.JUL.2018 18:43:20

99 % Bandwidth; 64QAM; 3675 MHz; MIMO B.

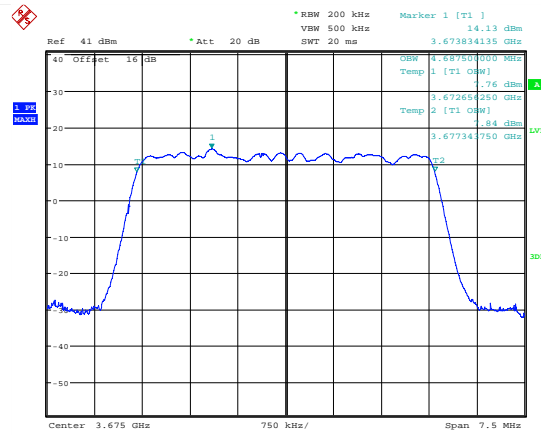
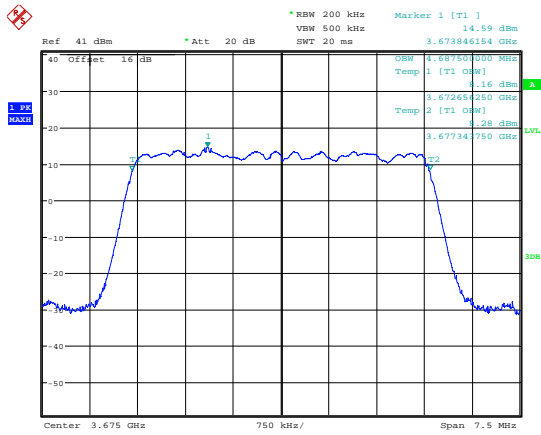

Date: 7.JUL.2018 18:45:18

Date: 7.JUL.2018 18:42:50

99 % Bandwidth; 256QAM; 3675 MHz; MIMO A.

99 % Bandwidth; 256QAM; 3675 MHz; MIMO B.

Middle Channel 5 MHz bandwidth						
Frequency (MHz)	Modulation Mode	MIMO	FL (MHz)	FH (MHz)	99 % Bandwidth (kHz)	Result
3675	QPSK	A	3672.656	3677.343	4687	Pass
3675	QPSK	B	3672.656	3677.343	4687	Pass
3675	16QAM	A	3672.656	3677.343	4687	Pass
3675	16QAM	B	3672.656	3677.343	4687	Pass
3675	64QAM	A	3672.656	3677.343	4687	Pass
3675	64QAM	B	3672.656	3677.343	4687	Pass
3675	256QAM	A	3672.656	3677.343	4687	Pass
3675	256QAM	B	3672.656	3677.343	4687	Pass

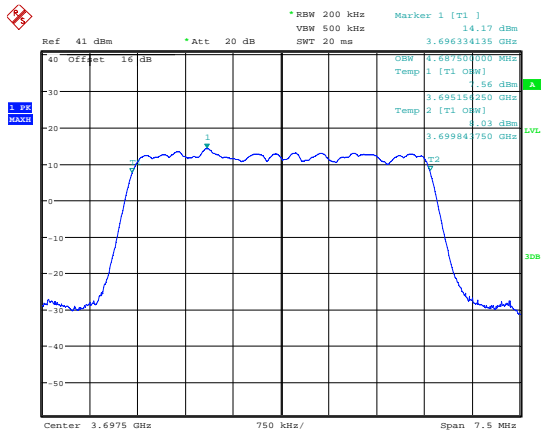

Date: 7.JUL.2018 19:16:23
 99 % Bandwidth; QPSK; 3697.5 MHz; MIMO A.

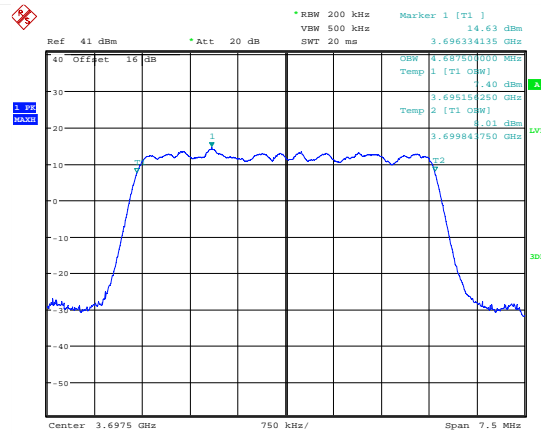

Date: 7.JUL.2018 19:19:11
 99 % Bandwidth; QPSK; 3697.5 MHz; MIMO B.

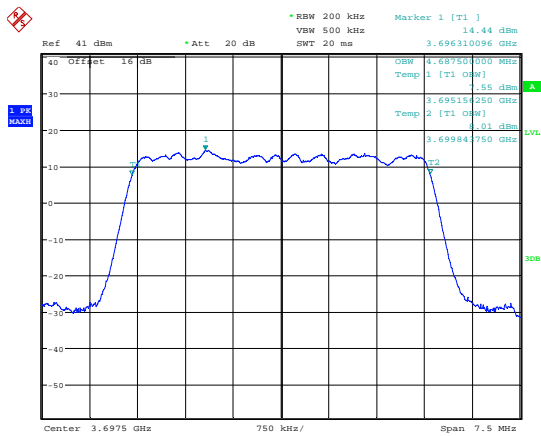

Date: 7.JUL.2018 19:17:14
 99 % Bandwidth; 16QAM; 3697.5 MHz; MIMO A.

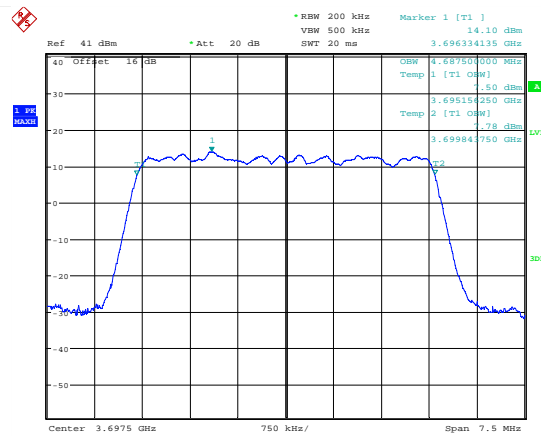

Date: 7.JUL.2018 19:19:49
 99 % Bandwidth; 16QAM; 3697.5 MHz; MIMO B.

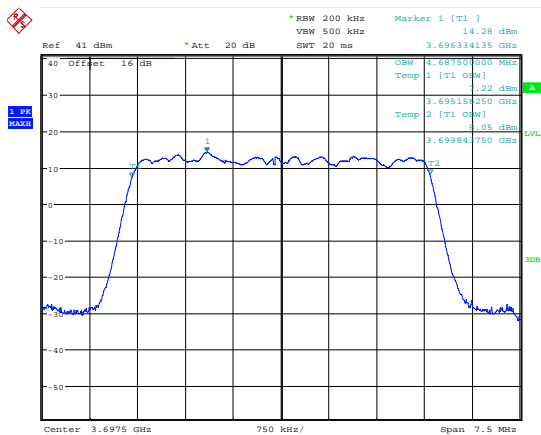

Date: 7.JUL.2018 19:17:52
 99 % Bandwidth; 64QAM; 3697.5 MHz; MIMO A.

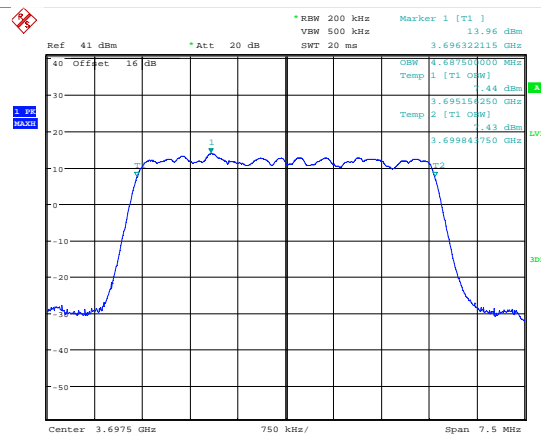

Date: 7.JUL.2018 19:20:33
 99 % Bandwidth; 64QAM; 3697.5 MHz; MIMO B.

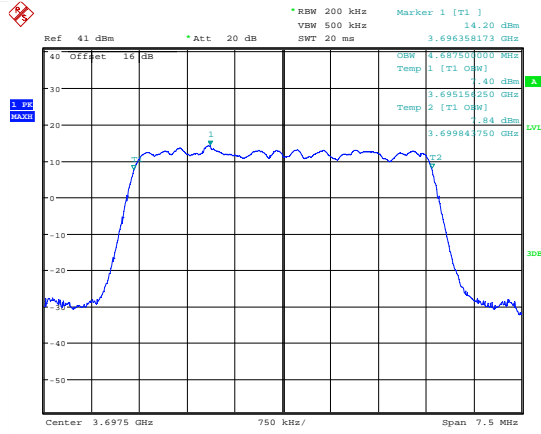
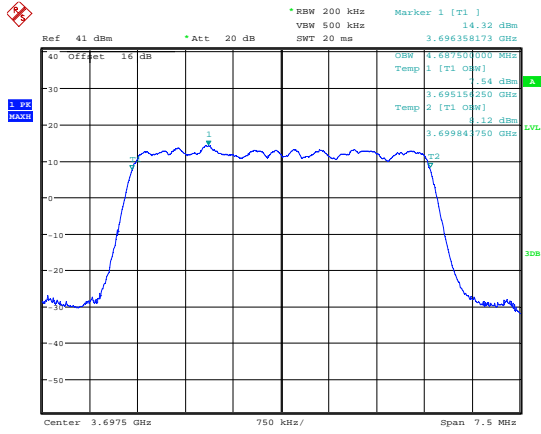

Date: 7.JUL.2018 19:18:34

Date: 7.JUL.2018 19:21:05

99 % Bandwidth; 256QAM; 3697.5 MHz; MIMO A.

99 % Bandwidth; 256QAM; 3697.5 MHz; MIMO B.

Top Channel 5 MHz bandwidth						
Frequency (MHz)	Modulation Mode	MIMO	FL (MHz)	FH (MHz)	99 % Bandwidth (kHz)	Result
3697.5	QPSK	A	3695.156	3699.843	4687	Pass
3697.5	QPSK	B	3695.156	3699.843	4687	Pass
3697.5	16QAM	A	3695.156	3699.843	4687	Pass
3697.5	16QAM	B	3695.156	3699.843	4687	Pass
3697.5	64QAM	A	3695.156	3699.843	4687	Pass
3697.5	64QAM	B	3695.156	3699.843	4687	Pass
3697.5	256QAM	A	3695.156	3699.843	4687	Pass
3697.5	256QAM	B	3695.156	3699.843	4687	Pass

5 MHz Bandwidth MU-MIMO

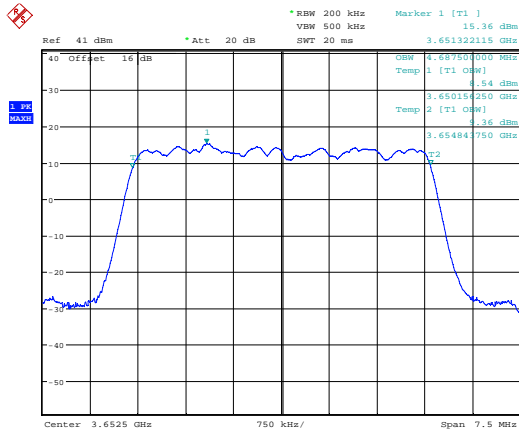

Date: 7.JUL.2018 18:35:47

99 % Bandwidth QPSK; 3652.5 MHz; MIMO A.

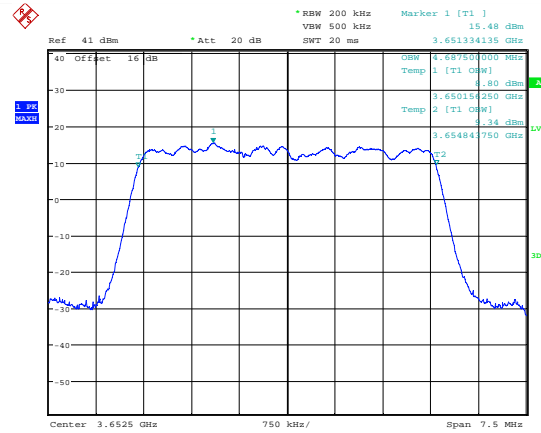

Date: 7.JUL.2018 18:38:19

99 % Bandwidth QPSK; 3652.5 MHz; MIMO B.

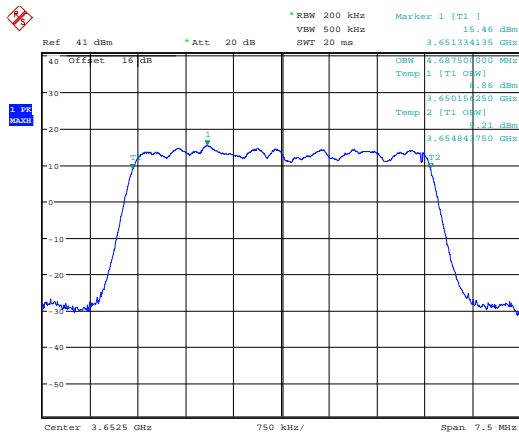

Date: 7.JUL.2018 18:36:22

99 % Bandwidth; 16QAM; 3652.5 MHz; MIMO A.

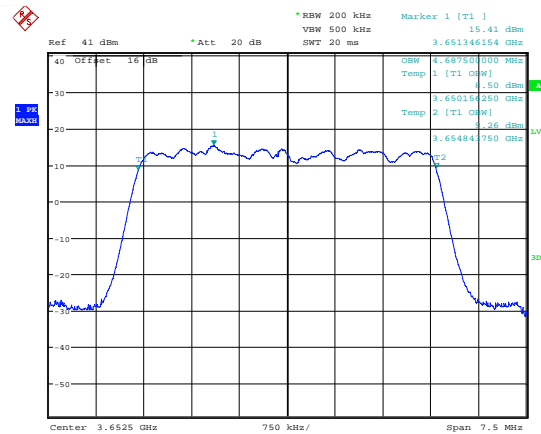

Date: 7.JUL.2018 18:39:12

99 % Bandwidth; 16QAM; 3652.5 MHz; MIMO B.

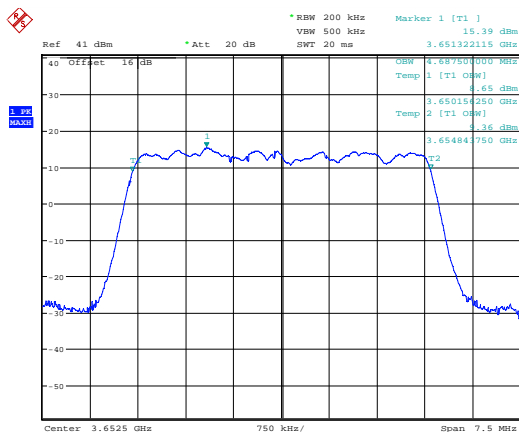

Date: 7.JUL.2018 18:37:10

99 % Bandwidth; 64QAM; 3652.5 MHz; MIMO A.

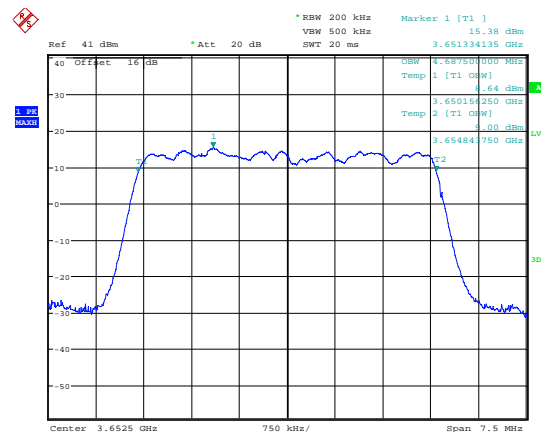

Date: 7.JUL.2018 18:39:49

99 % Bandwidth; 64QAM; 3652.5 MHz; MIMO B.

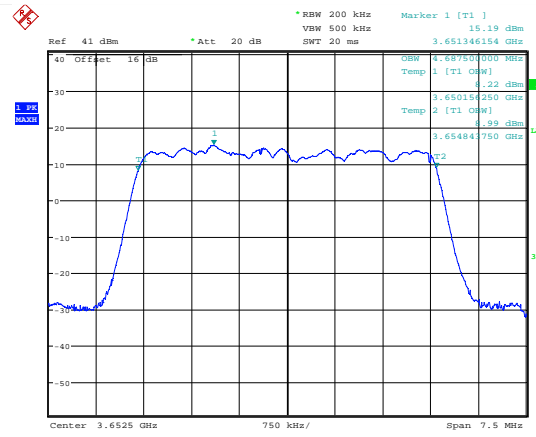
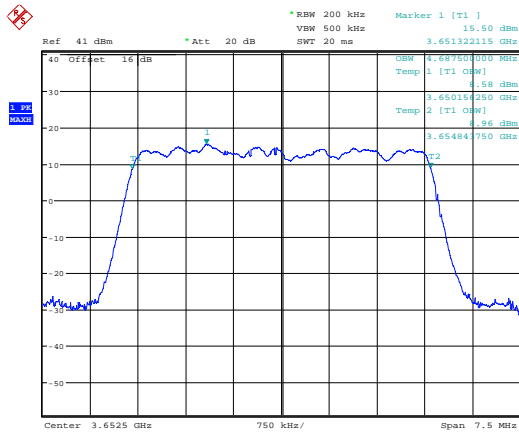

Date: 7.JUL.2018 18:37:45

Date: 7.JUL.2018 18:40:32

99 % Bandwidth; 256QAM; 3652.5 MHz;
MIMO A.

99 % Bandwidth; 256QAM; 3652.5 MHz;
MIMO B.

Bottom Channel 5 MHz bandwidth						
Frequency (MHz)	Modulation Mode	MIMO	FL (MHz)	FH (MHz)	99 % Bandwidth (kHz)	Result
3652.5	QPSK	A	3650.156	3654.843	4687	Pass
3652.5	QPSK	B	3650.156	3654.843	4687	Pass
3652.5	16QAM	A	3650.156	3654.843	4687	Pass
3652.5	16QAM	B	3650.156	3654.843	4687	Pass
3652.5	64QAM	A	3650.156	3654.843	4687	Pass
3652.5	64QAM	B	3650.156	3654.843	4687	Pass
3652.5	256QAM	A	3650.156	3654.843	4687	Pass
3652.5	256QAM	B	3650.156	3654.843	4687	Pass

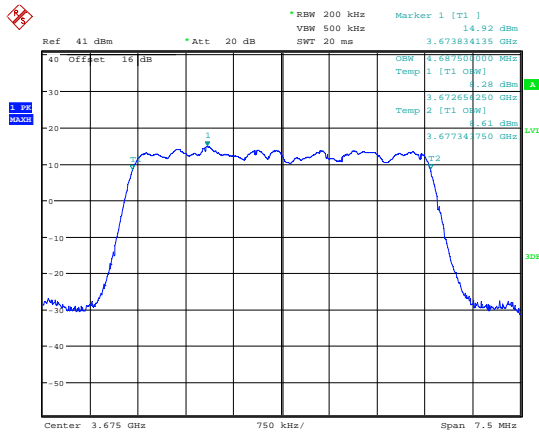

Date: 7.JUL.2018 19:02:14
99 % Bandwidth QPSK; 3675 MHz; MIMO A.

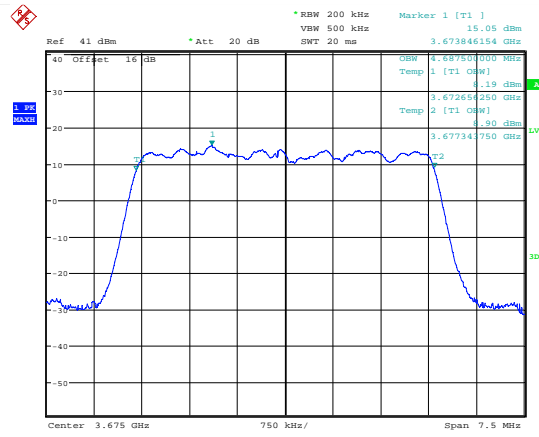

Date: 7.JUL.2018 18:59:37
99 % Bandwidth QPSK; 3675 MHz; MIMO B.

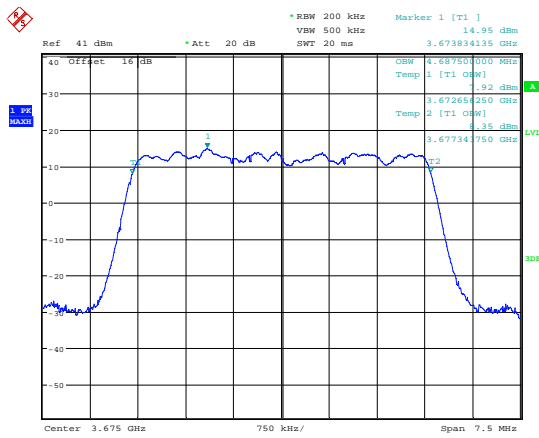

Date: 7.JUL.2018 19:01:42
99 % Bandwidth; 16QAM; 3675 MHz; MIMO A.

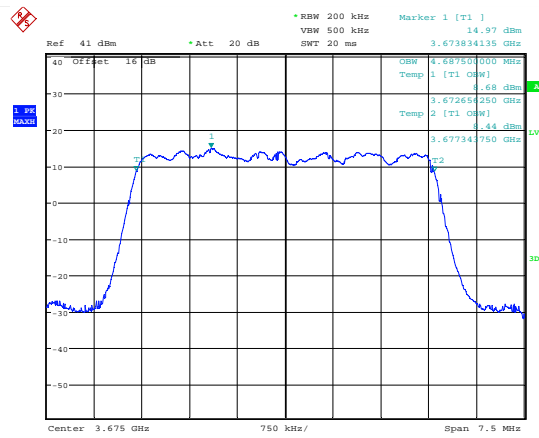

Date: 7.JUL.2018 18:58:47
99 % Bandwidth; 16QAM; 3675 MHz; MIMO B.

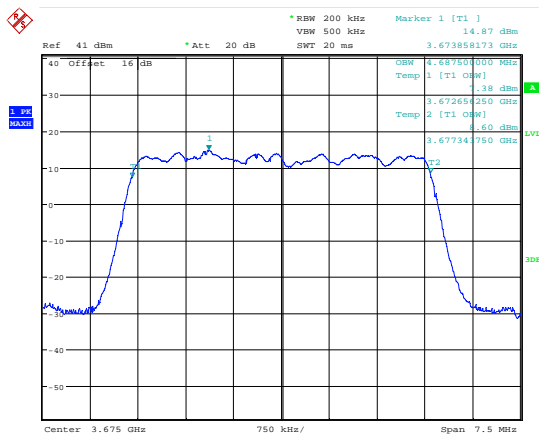

Date: 7.JUL.2018 19:01:02
99 % Bandwidth; 64QAM; 3675 MHz; MIMO A.

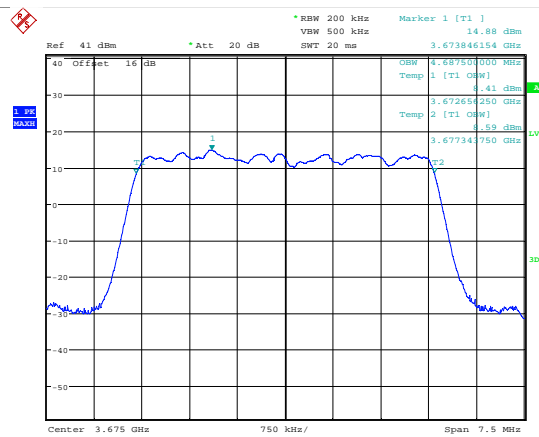

Date: 7.JUL.2018 18:58:11
99 % Bandwidth; 64QAM; 3675 MHz; MIMO B.

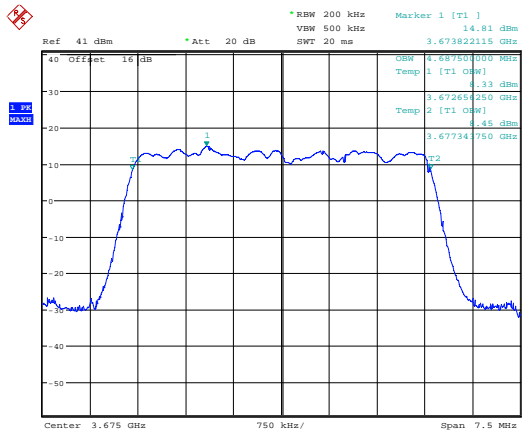

Date: 7 JUL 2018 19:00:20

99 % Bandwidth; 256QAM; 3675 MHz;
MIMO A.

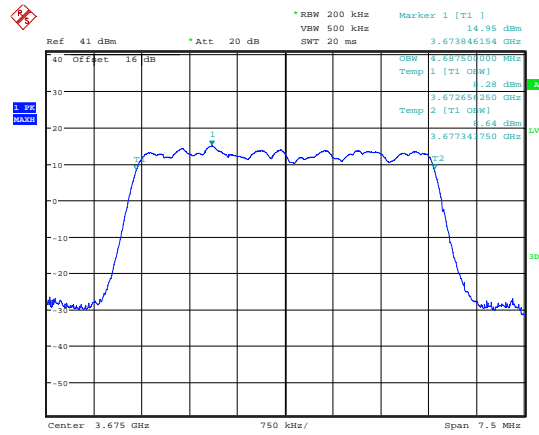

Date: 7 JUL 2018 18:57:14

99 % Bandwidth; 256QAM; 3675 MHz;
MIMO B.

Middle Channel 5 MHz bandwidth						
Frequency (MHz)	Modulation Mode	MIMO	FL (MHz)	FH (MHz)	99 % Bandwidth (kHz)	Result
3675	QPSK	A	3672.656	3677.343	4687	Pass
3675	QPSK	B	3672.656	3677.343	4687	Pass
3675	16QAM	A	3672.656	3677.343	4687	Pass
3675	16QAM	B	3672.656	3677.343	4687	Pass
3675	64QAM	A	3672.656	3677.343	4687	Pass
3675	64QAM	B	3672.656	3677.343	4687	Pass
3675	256QAM	A	3672.656	3677.343	4687	Pass
3675	256QAM	B	3672.656	3677.343	4687	Pass

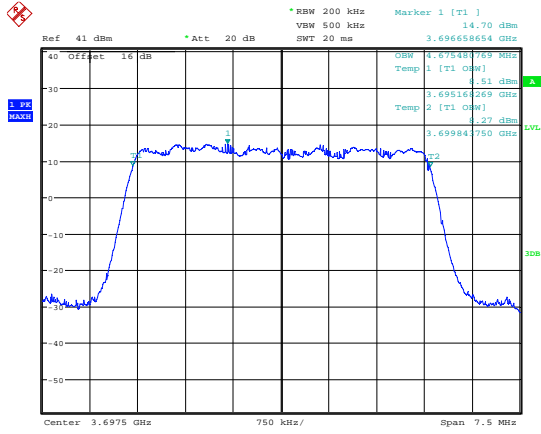

Date: 7.JUL.2018 19:03:40
99 % Bandwidth QPSK; 3697.5 MHz; MIMO A.

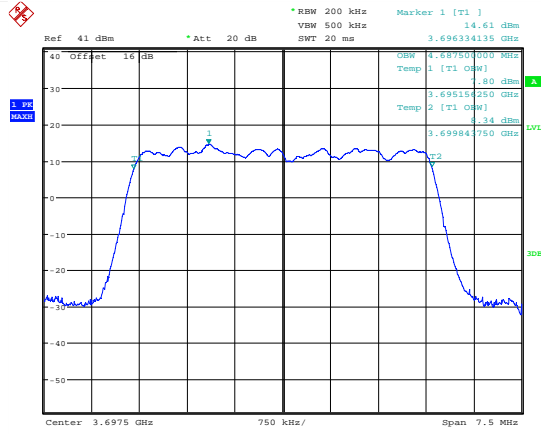

Date: 7.JUL.2018 19:06:15
99 % Bandwidth QPSK; 3697.5 MHz; MIMO B.

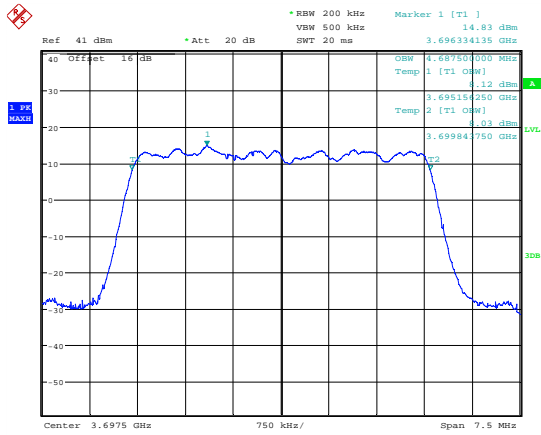

Date: 7.JUL.2018 19:04:11
99 % Bandwidth; 16QAM; 3697.5 MHz; MIMO A.

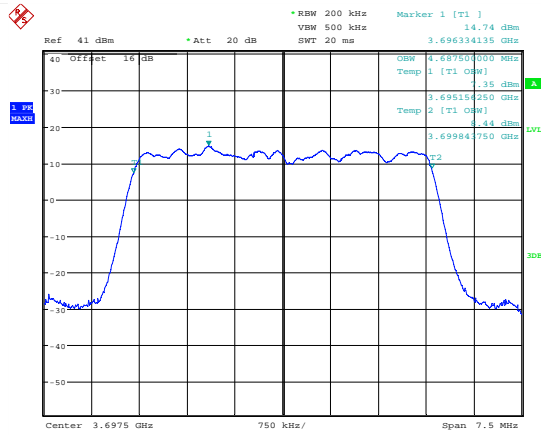

Date: 7.JUL.2018 19:06:55
99 % Bandwidth; 16QAM; 3697.5 MHz; MIMO B.

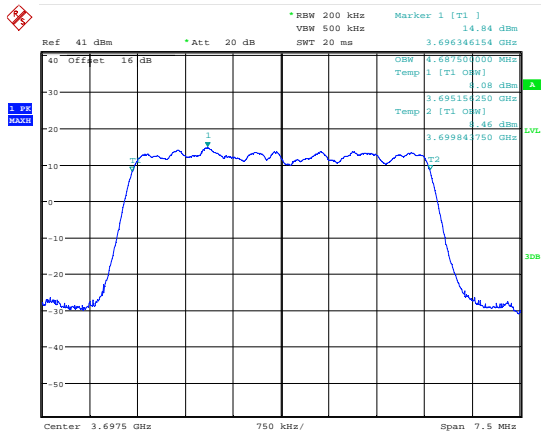

Date: 7.JUL.2018 19:04:49
99 % Bandwidth; 64QAM; 3697.5 MHz; MIMO A.

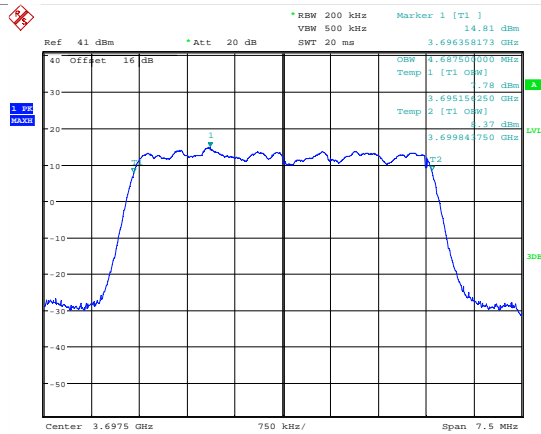

Date: 7.JUL.2018 19:07:31
99 % Bandwidth; 64QAM; 3697.5 MHz; MIMO B.

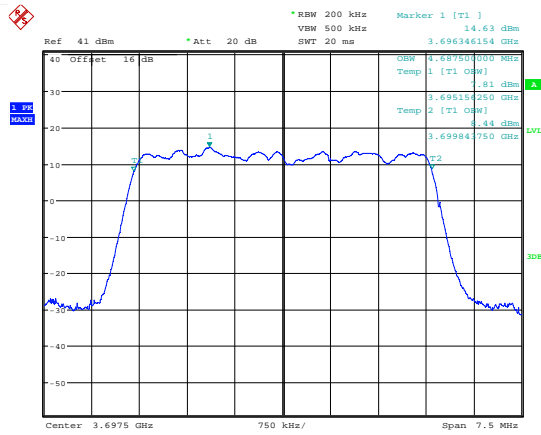
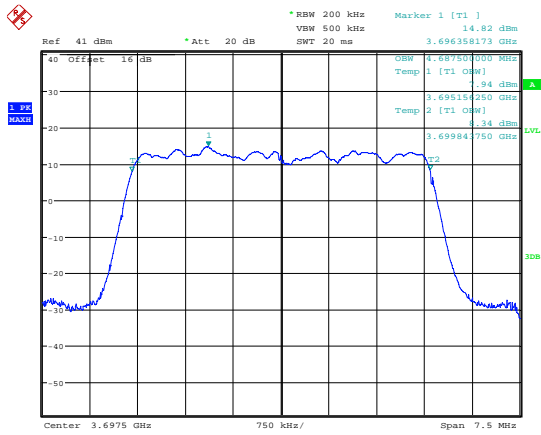

Date: 7.JUL.2018 19:05:27

Date: 7.JUL.2018 19:08:17

99 % Bandwidth; 256QAM; 3697.5 MHz; MIMO A.

99 % Bandwidth; 256QAM; 3697.5 MHz; MIMO B.

Top Channel 5 MHz bandwidth						
Frequency (MHz)	Modulation Mode	MIMO	FL (MHz)	FH (MHz)	99 % Bandwidth (kHz)	Result
3697.5	QPSK	A	3695.168	3699.843	4675	Pass
3697.5	QPSK	B	3695.156	3699.843	4687	Pass
3697.5	16QAM	A	3695.156	3699.843	4687	Pass
3697.5	16QAM	B	3695.156	3699.843	4687	Pass
3697.5	64QAM	A	3695.156	3699.843	4687	Pass
3697.5	64QAM	B	3695.156	3699.843	4687	Pass
3697.5	256QAM	A	3695.156	3699.843	4687	Pass
3697.5	256QAM	B	3695.156	3699.843	4687	Pass

20 MHz Bandwidth Beamforming

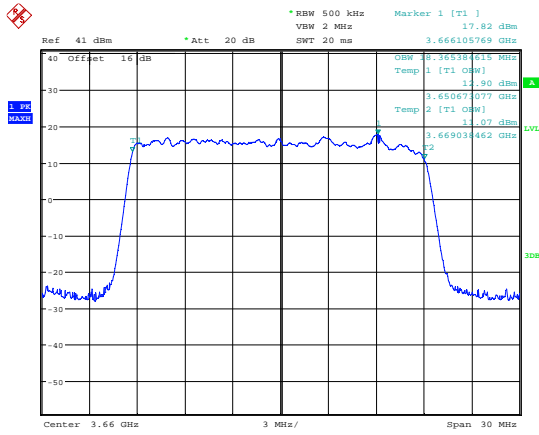

Date: 7.JUL.2018 16:31:55

99 % Bandwidth QPSK; 3660 MHz; MIMO A.

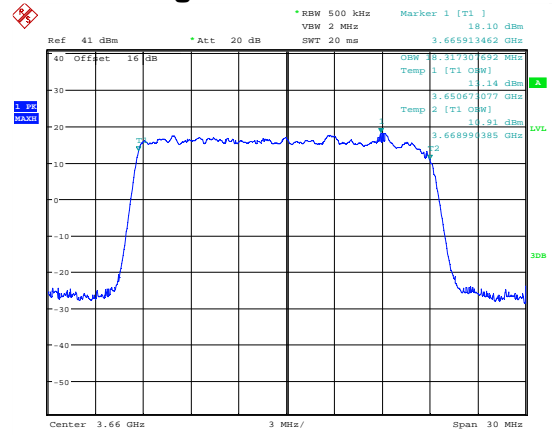

Date: 7.JUL.2018 16:34:38

99 % Bandwidth QPSK; 3660 MHz; MIMO B.

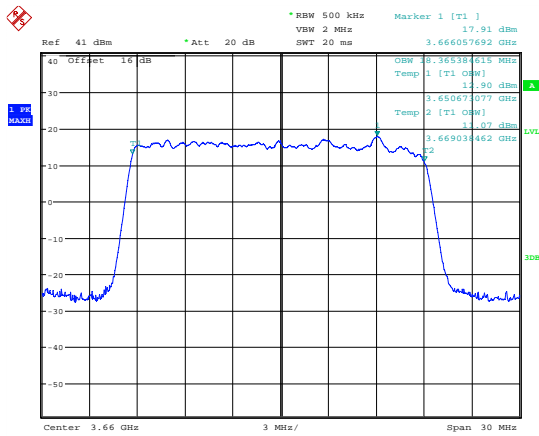

Date: 7.JUL.2018 16:32:37

99 % Bandwidth; 16QAM; 3660 MHz; MIMO A.

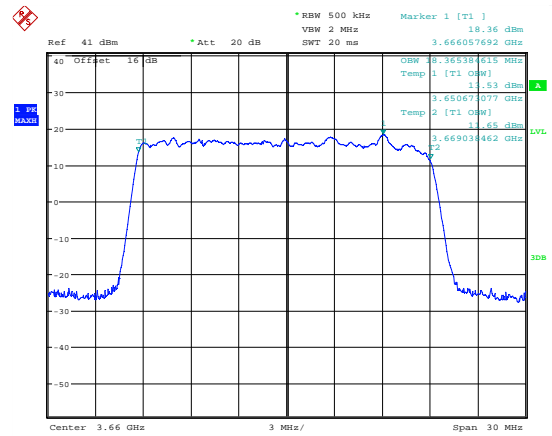

Date: 7.JUL.2018 16:35:20

99 % Bandwidth; 16QAM; 3660 MHz; MIMO B.

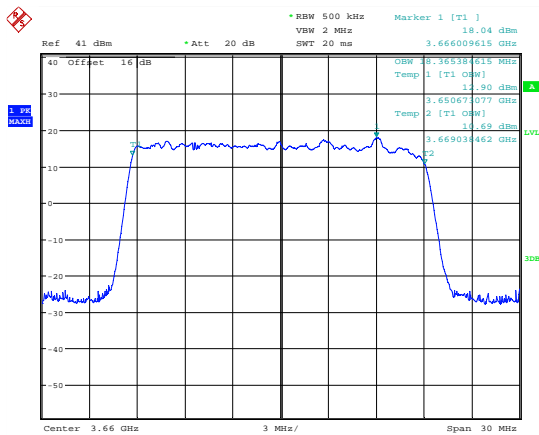

Date: 7.JUL.2018 16:33:19

99 % Bandwidth; 64QAM; 3660 MHz; MIMO A.

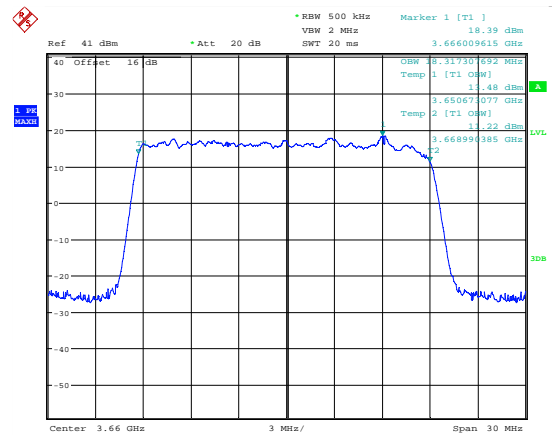

Date: 7.JUL.2018 16:35:57

99 % Bandwidth; 64QAM; 3660 MHz; MIMO B.

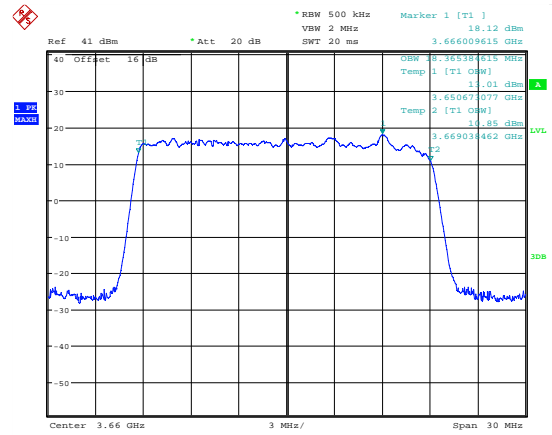
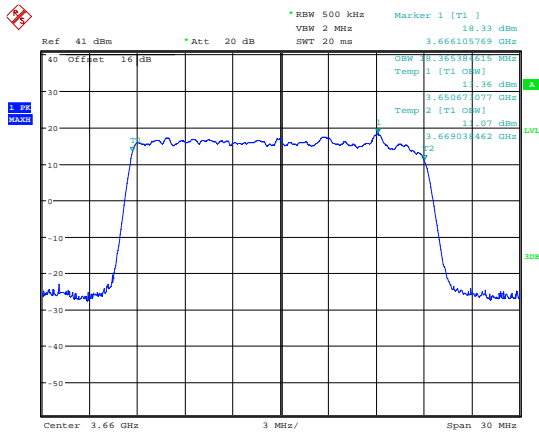

Date: 7_JUL_2018 16:34:14

99 % Bandwidth; 256QAM; 3660 MHz; MIMO A.

Date: 7_JUL_2018 16:36:40

99 % Bandwidth; 256QAM; 3660 MHz; MIMO B.

Bottom Channel 20 MHz bandwidth						
Frequency (MHz)	Modulation Mode	MIMO	FL (MHz)	FH (MHz)	99 % Bandwidth (kHz)	Result
3660	QPSK	A	3650.673	3669.038	18365	Pass
3660	QPSK	B	3650.673	3668.990	18317	Pass
3660	16QAM	A	3650.673	3669.038	18365	Pass
3660	16QAM	B	3650.673	3669.038	18365	Pass
3660	64QAM	A	3650.673	3669.038	18365	Pass
3660	64QAM	B	3650.673	3668.990	18317	Pass
3660	256QAM	A	3650.673	3669.038	18365	Pass
3660	256QAM	B	3650.673	3669.038	18365	Pass

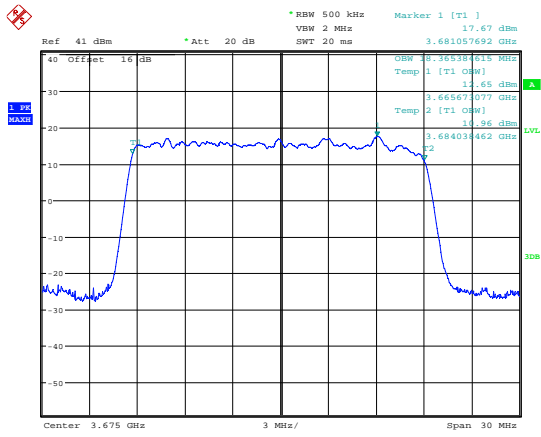

Date: 7.JUL.2018 17:18:05

99 % Bandwidth; QPSK; 3675 MHz; MIMO A.

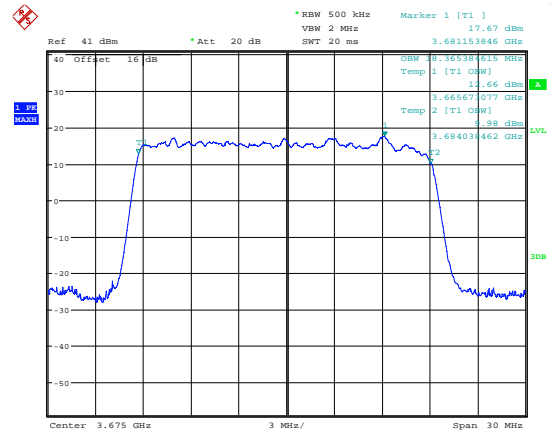

Date: 7.JUL.2018 17:11:45

99 % Bandwidth; QPSK; 3675 MHz; MIMO B.

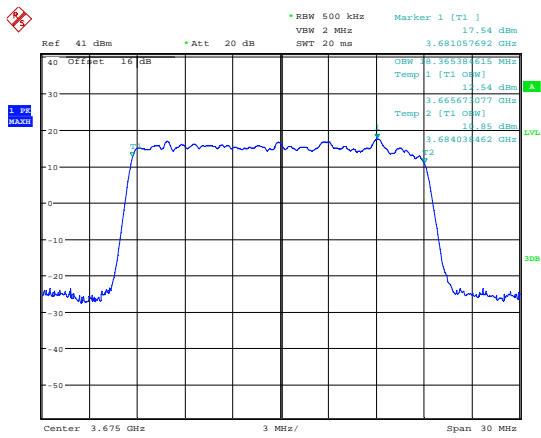

Date: 7.JUL.2018 17:16:24

99 % Bandwidth; 16QAM; 3675 MHz; MIMO A.

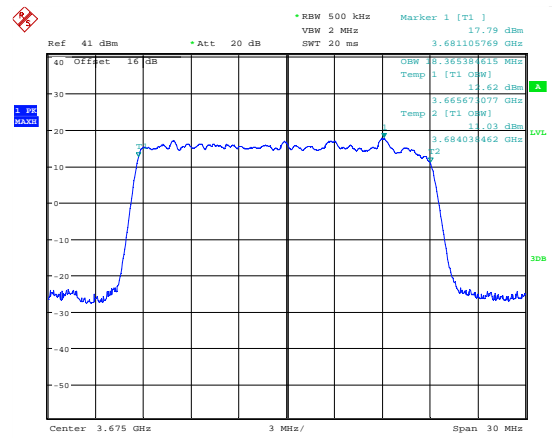

Date: 7.JUL.2018 17:10:23

99 % Bandwidth; 16QAM; 3675 MHz; MIMO B.

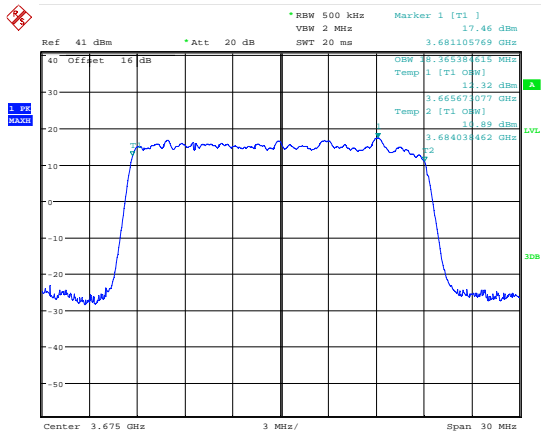

Date: 7.JUL.2018 17:14:29

99 % Bandwidth; 64QAM; 3675 MHz; MIMO A.

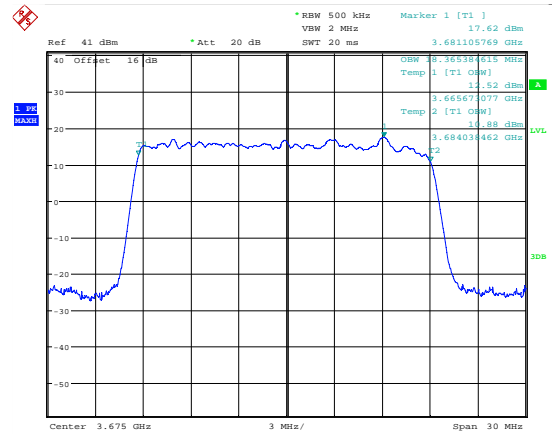

Date: 7.JUL.2018 17:09:08

99 % Bandwidth; 64QAM; 3675 MHz; MIMO B.

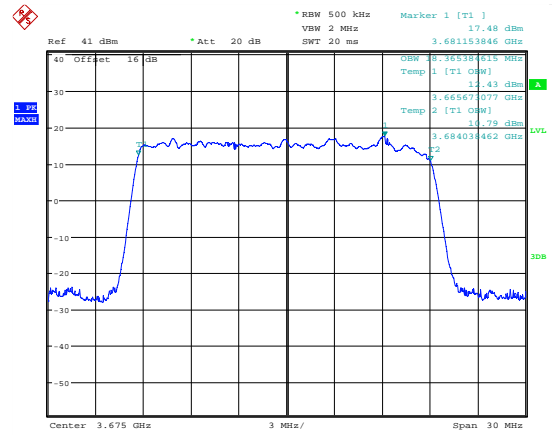
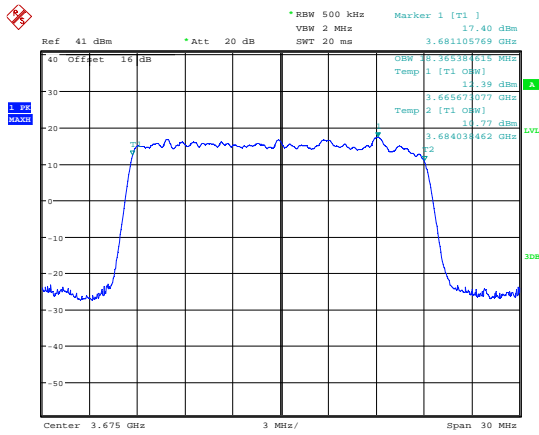

Date: 7.JUL.2018 17:13:30

99 % Bandwidth; 256QAM; 3675 MHz; MIMO A.

Date: 7.JUL.2018 17:04:55

99 % Bandwidth; 256QAM; 3675 MHz; MIMO B.

Middle Channel 20 MHz bandwidth						
Frequency (MHz)	Modulation Mode	MIMO	FL (MHz)	FH (MHz)	99 % Bandwidth (kHz)	Result
3675	QPSK	A	3665.673	3684.038	18365	Pass
3675	QPSK	B	3665.673	3684.038	18365	Pass
3675	16QAM	A	3665.673	3684.038	18365	Pass
3675	16QAM	B	3665.673	3684.038	18365	Pass
3675	64QAM	A	3665.673	3684.038	18365	Pass
3675	64QAM	B	3665.673	3684.038	18365	Pass
3675	256QAM	A	3665.673	3684.038	18365	Pass
3675	256QAM	B	3665.673	3684.038	18365	Pass

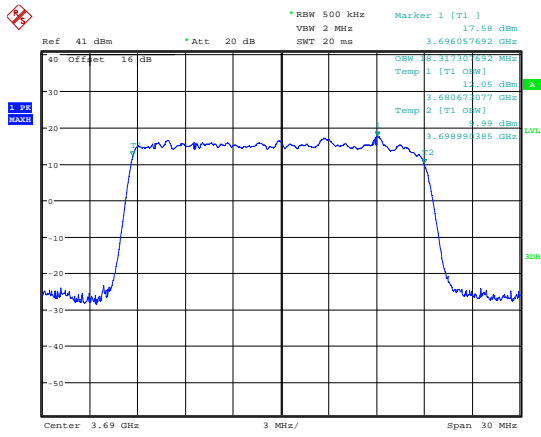

Date: 7.JUL.2018 17:34:24
99 % Bandwidth; QPSK; 3690 MHz; MIMO A.

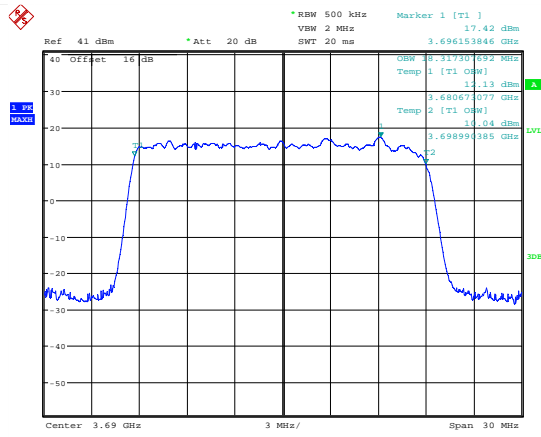

Date: 7.JUL.2018 17:38:29
99 % Bandwidth; QPSK; 3690 MHz; MIMO B.

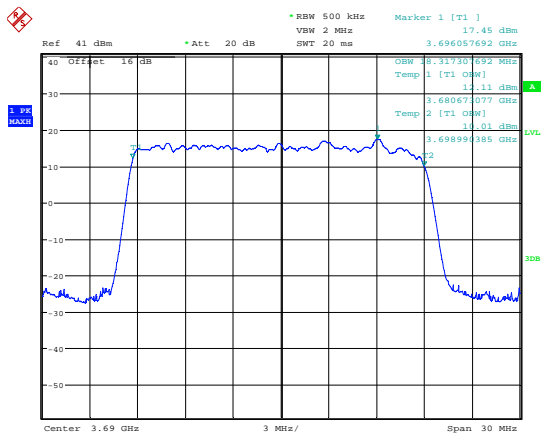

Date: 7.JUL.2018 17:36:23
99 % Bandwidth; 16QAM; 3690 MHz; MIMO A.

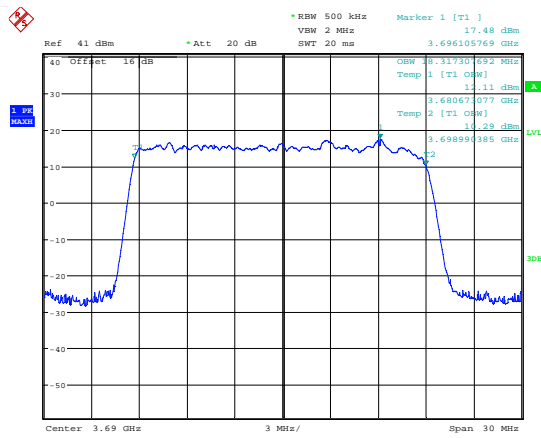

Date: 7.JUL.2018 17:39:11
99 % Bandwidth; 16QAM; 3690 MHz; MIMO B.

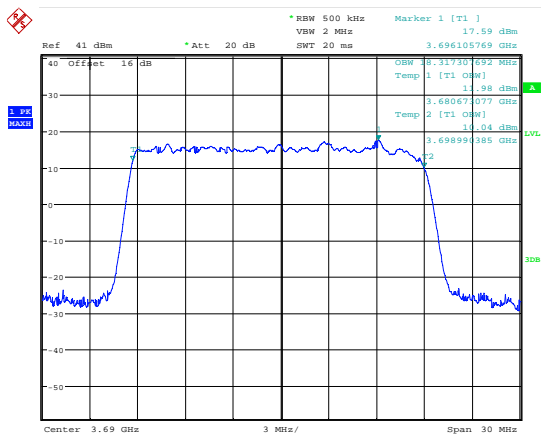

Date: 7.JUL.2018 17:36:55
99 % Bandwidth; 64QAM; 3690 MHz; MIMO A.

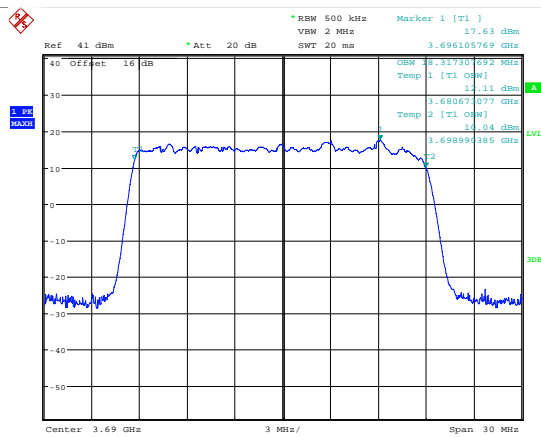

Date: 7.JUL.2018 17:39:54
99 % Bandwidth; 64QAM; 3690 MHz; MIMO B.

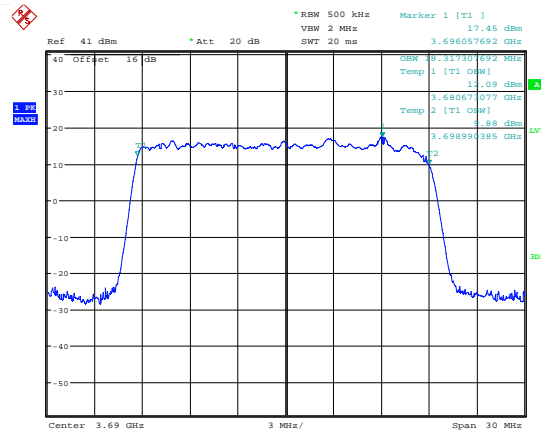
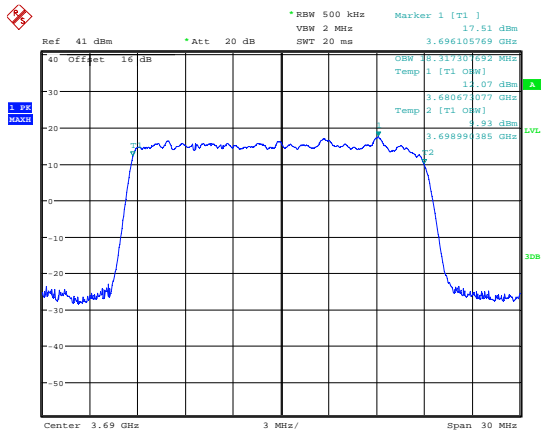

Date: 7.JUL.2018 17:37:37

Date: 7.JUL.2018 17:40:38

99 % Bandwidth; 256QAM; 3690 MHz; MIMO A.

99 % Bandwidth; 256QAM; 3690 MHz; MIMO B.

Top Channel 20 MHz bandwidth						
Frequency (MHz)	Modulation Mode	MIMO	FL (MHz)	FH (MHz)	99 % Bandwidth (kHz)	Result
3690	QPSK	A	3680.673	3698.99	18317	Pass
3690	QPSK	B	3680.673	3698.99	18317	Pass
3690	16QAM	A	3680.673	3698.99	18317	Pass
3690	16QAM	B	3680.673	3698.99	18317	Pass
3690	64QAM	A	3680.673	3698.99	18317	Pass
3690	64QAM	B	3680.673	3698.99	18317	Pass
3690	256QAM	A	3680.673	3698.99	18317	Pass
3690	256QAM	B	3680.673	3698.99	18317	Pass

20 MHz Bandwidth Sector

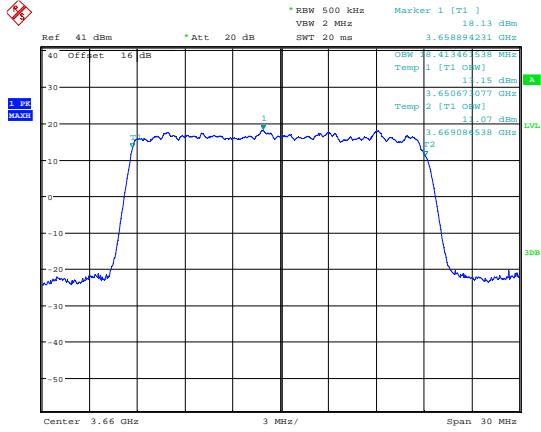

Date: 7.JUL.2018 16:26:04

99 % Bandwidth; QPSK; 3660 MHz; MIMO A.

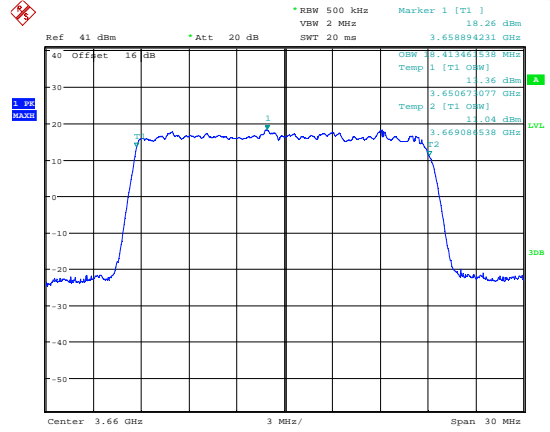

Date: 7.JUL.2018 16:28:37

99 % Bandwidth; QPSK; 3660 MHz; MIMO B.

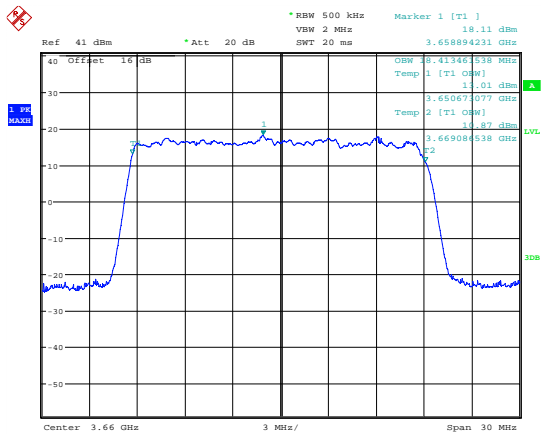

Date: 7.JUL.2018 16:26:31

99 % Bandwidth; 16QAM; 3660 MHz; MIMO A.

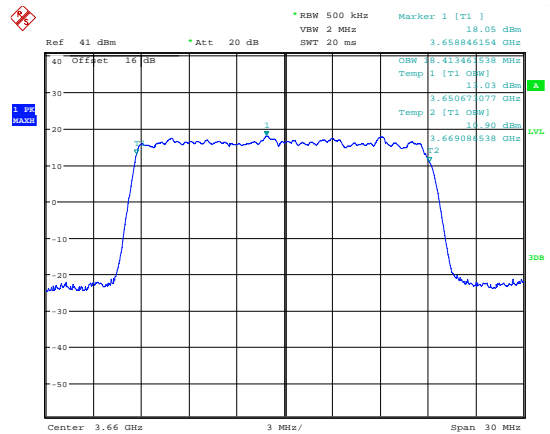

Date: 7.JUL.2018 16:29:19

99 % Bandwidth; 16QAM; 3660 MHz; MIMO B.

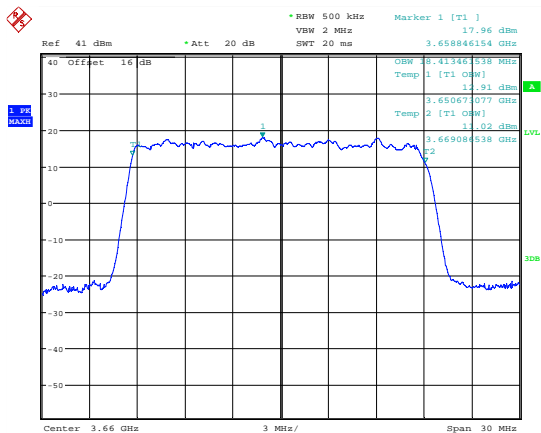

Date: 7.JUL.2018 16:27:08

99 % Bandwidth; 64QAM; 3660 MHz; MIMO A.

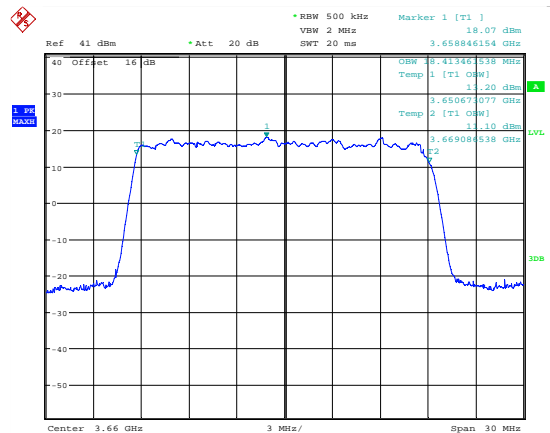

Date: 7.JUL.2018 16:29:54

99 % Bandwidth; 64QAM; 3660 MHz; MIMO B.

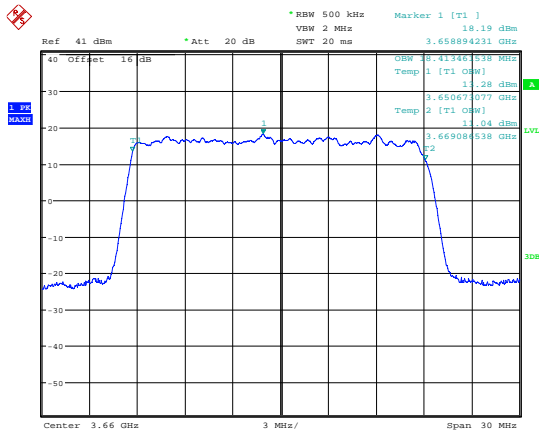

Date: 7.JUL.2018 16:27:58

99 % Bandwidth; 256QAM; 3660 MHz; MIMO A.

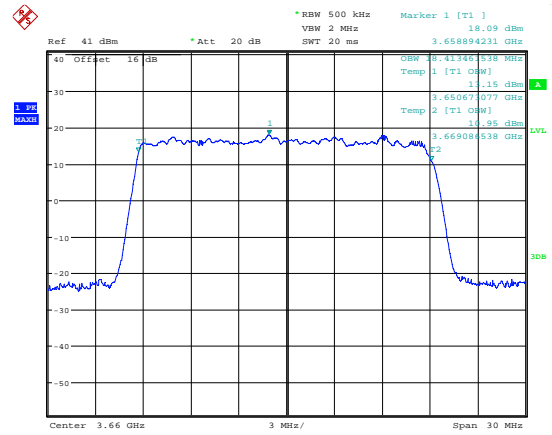

Date: 7.JUL.2018 16:30:20

99 % Bandwidth; 256QAM; 3660 MHz; MIMO B.

Bottom Channel 20 MHz bandwidth						
Frequency (MHz)	Modulation Mode	MIMO	FL (MHz)	FH (MHz)	99 % Bandwidth (kHz)	Result
3660	QPSK	A	3650.673	3669.086	18413	Pass
3660	QPSK	B	3650.673	3669.086	18413	Pass
3660	16QAM	A	3650.673	3669.086	18413	Pass
3660	16QAM	B	3650.673	3669.086	18413	Pass
3660	64QAM	A	3650.673	3669.086	18413	Pass
3660	64QAM	B	3650.673	3669.086	18413	Pass
3660	256QAM	A	3650.673	3669.086	18413	Pass
3660	256QAM	B	3650.673	3669.086	18413	Pass

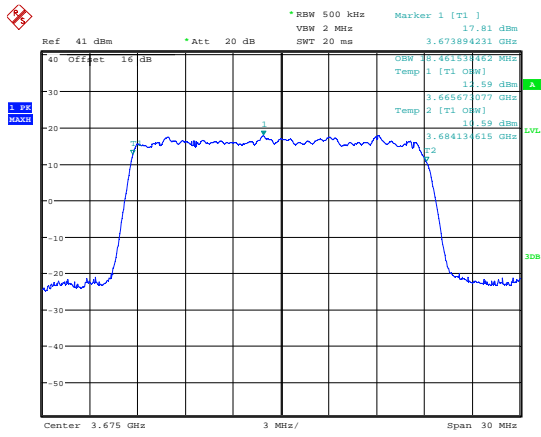

Date: 7.JUL.2018 16:58:22
99 % Bandwidth; QPSK; 3675 MHz; MIMO A.

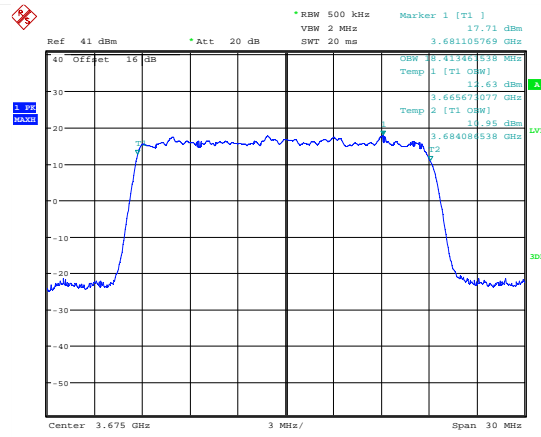

Date: 7.JUL.2018 17:01:49
99 % Bandwidth; QPSK; 3675 MHz; MIMO B.

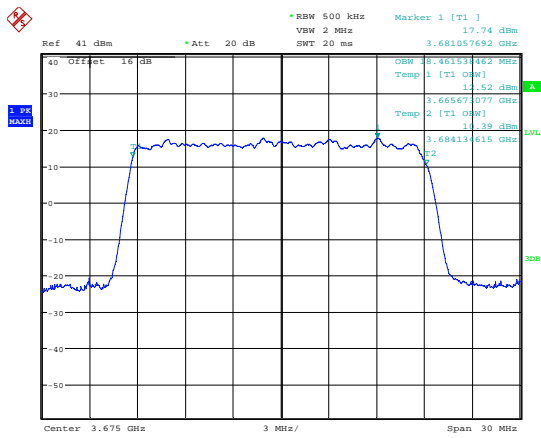

Date: 7.JUL.2018 16:59:48
99 % Bandwidth; 16QAM; 3675 MHz; MIMO A.

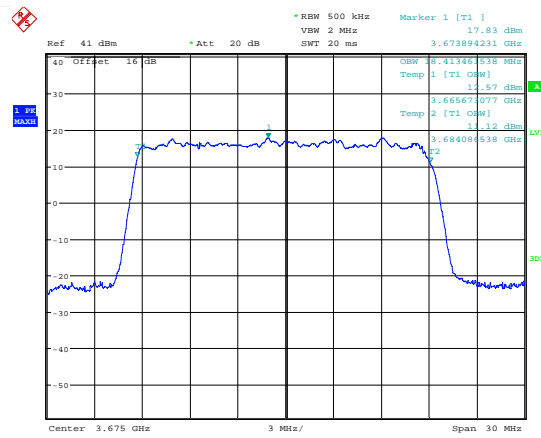

Date: 7.JUL.2018 17:02:29
99 % Bandwidth; 16QAM; 3675 MHz; MIMO B.

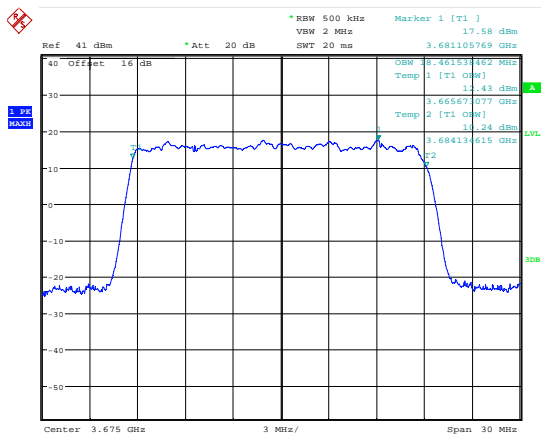

Date: 7.JUL.2018 17:00:28
99 % Bandwidth; 64QAM; 3675 MHz; MIMO A.

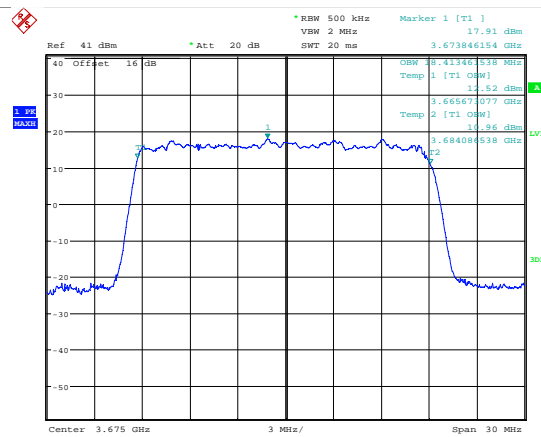

Date: 7.JUL.2018 17:03:05
99 % Bandwidth; 64QAM; 3675 MHz; MIMO B.

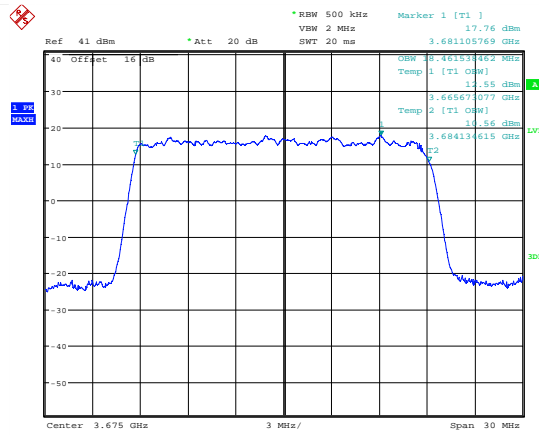
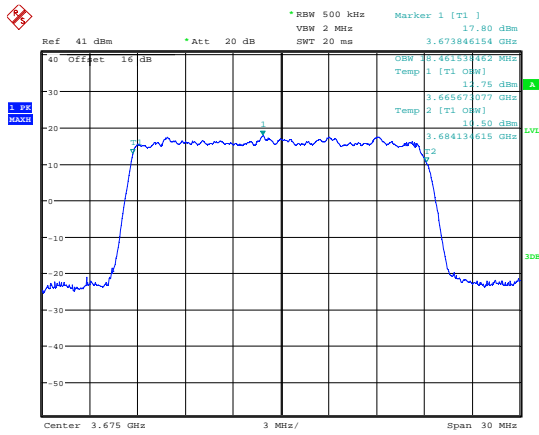

Date: 7.JUL.2018 17:01:09

Date: 7.JUL.2018 17:03:41

99 % Bandwidth; 256QAM; 3675 MHz; MIMO A.

99 % Bandwidth; 256QAM; 3675 MHz; MIMO B.

Middle Channel 20 MHz bandwidth						
Frequency (MHz)	Modulation Mode	MIMO	FL (MHz)	FH (MHz)	99 % Bandwidth (kHz)	Result
3675	QPSK	A	3665.673	3684.134	18461	Pass
3675	QPSK	B	3665.673	3684.086	18413	Pass
3675	16QAM	A	3665.673	3684.134	18461	Pass
3675	16QAM	B	3665.673	3684.086	18413	Pass
3675	64QAM	A	3665.673	3684.134	18461	Pass
3675	64QAM	B	3665.673	3684.086	18413	Pass
3675	256QAM	A	3665.673	3684.134	18461	Pass
3675	256QAM	B	3665.673	3684.134	18461	Pass

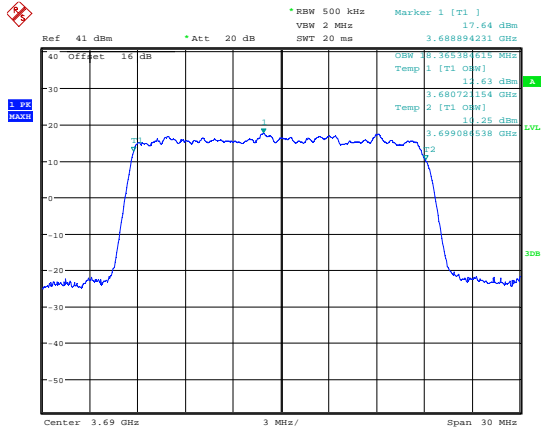

Date: 7.JUL.2018 17:27:18
99 % Bandwidth; QPSK; 3690 MHz; MIMO A.

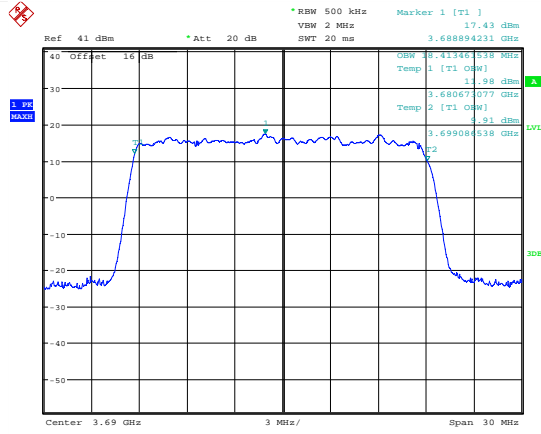

Date: 7.JUL.2018 17:29:53
99 % Bandwidth; QPSK; 3690 MHz; MIMO B.

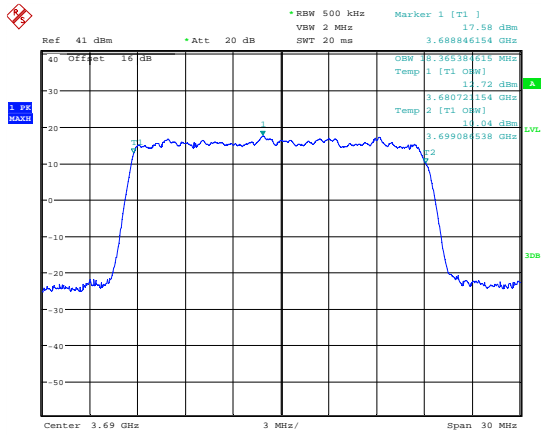

Date: 7.JUL.2018 17:27:56
99 % Bandwidth; 16QAM; 3690 MHz; MIMO A.

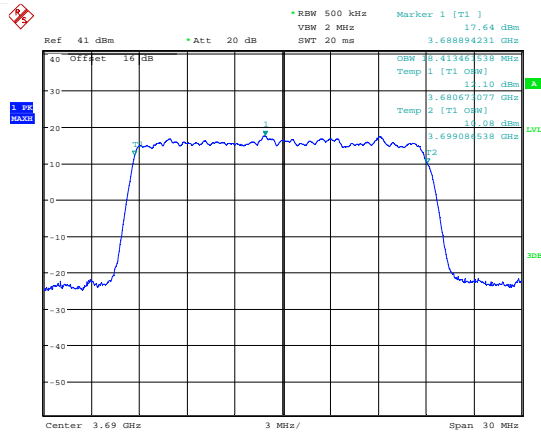

Date: 7.JUL.2018 17:31:00
99 % Bandwidth; 16QAM; 3690 MHz; MIMO B.

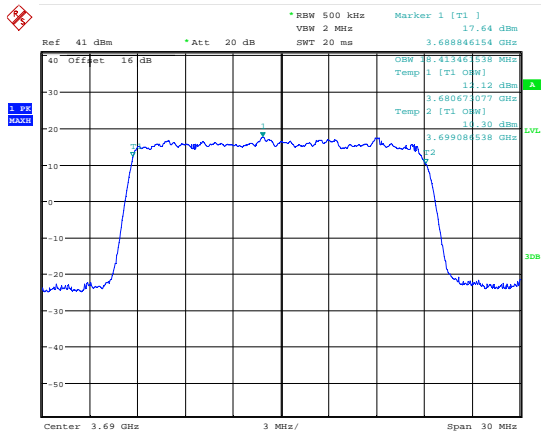

Date: 7.JUL.2018 17:28:29
99 % Bandwidth; 64QAM; 3690 MHz; MIMO A.

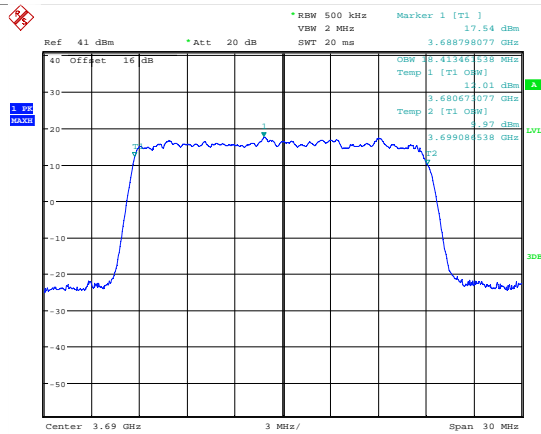

Date: 7.JUL.2018 17:31:52
99 % Bandwidth; 64QAM; 3690 MHz; MIMO B.

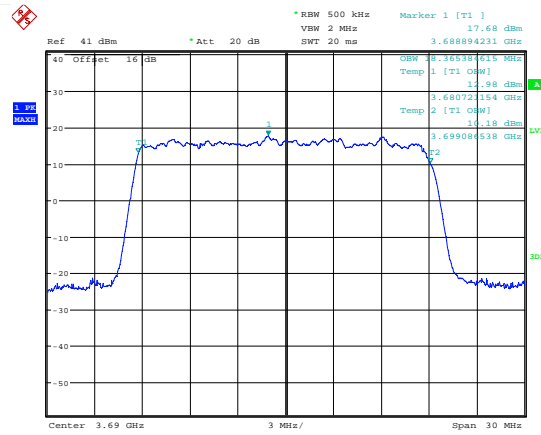
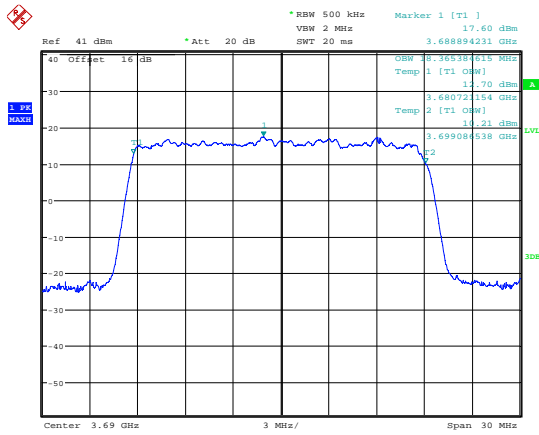

Date: 7.JUL.2018 17:29:11

Date: 7.JUL.2018 17:32:34

99 % Bandwidth; 256QAM; 3690 MHz; MIMO A.

99 % Bandwidth; 256QAM; 3690 MHz; MIMO B.

Top Channel 20 MHz bandwidth						
Frequency (MHz)	Modulation Mode	MIMO	FL (MHz)	FH (MHz)	99 % Bandwidth (kHz)	Result
3690	QPSK	A	3680.721	3699.086	18365	Pass
3690	QPSK	B	3680.673	3699.086	18413	Pass
3690	16QAM	A	3680.721	3699.086	18365	Pass
3690	16QAM	B	3680.673	3699.086	18413	Pass
3690	64QAM	A	3680.673	3699.086	18413	Pass
3690	64QAM	B	3680.673	3699.086	18413	Pass
3690	256QAM	A	3680.721	3699.086	18365	Pass
3690	256QAM	B	3680.721	3699.086	18365	Pass

20 MHz Bandwidth MU-MIMO

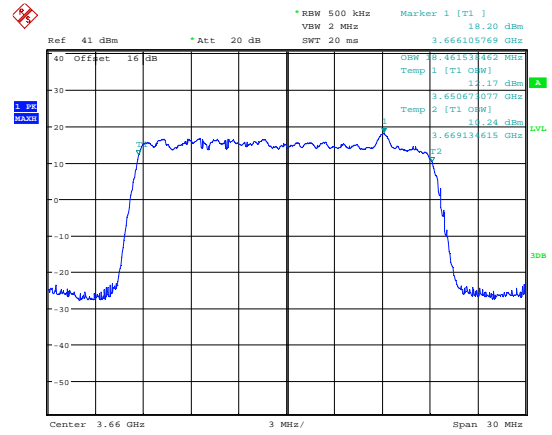
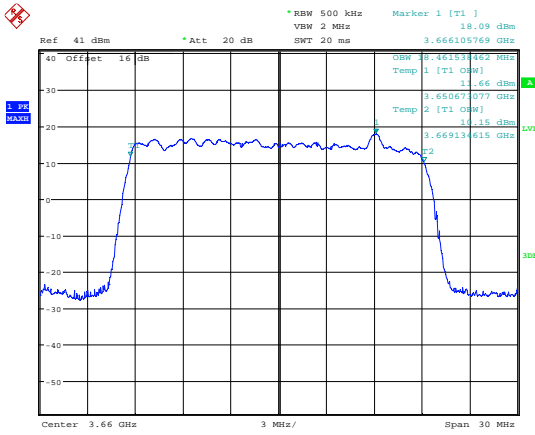

Date: 7.JUL.2018 16:38:24

99 % Bandwidth; QPSK; 3660 MHz; MIMO A.

Date: 7.JUL.2018 16:53:44

99 % Bandwidth; QPSK; 3660 MHz; MIMO B.

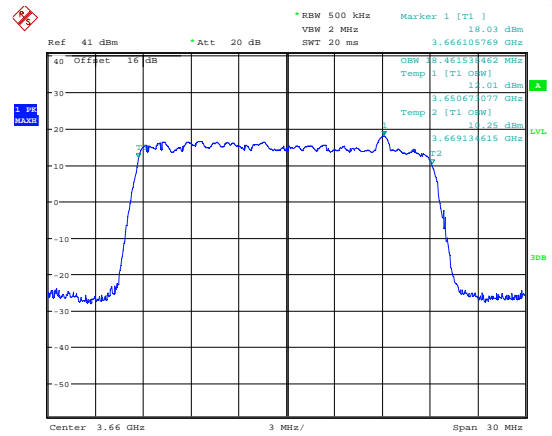
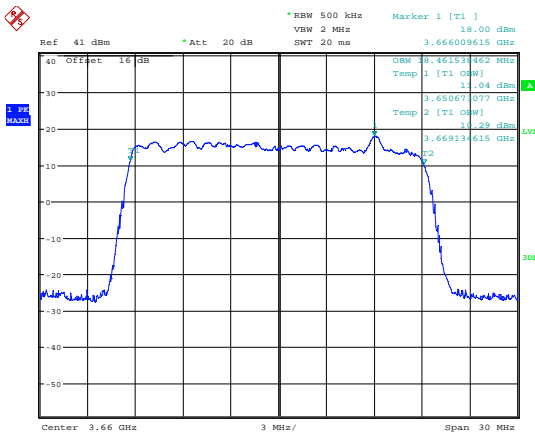

Date: 7.JUL.2018 16:39:13

99 % Bandwidth; 16QAM; 3660 MHz; MIMO A.

Date: 7.JUL.2018 16:54:31

99 % Bandwidth; 16QAM; 3660 MHz; MIMO B.

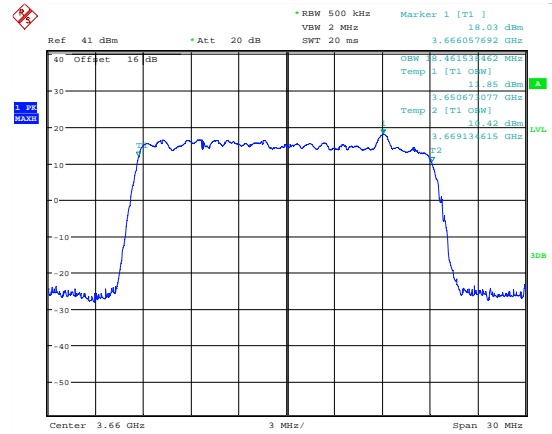
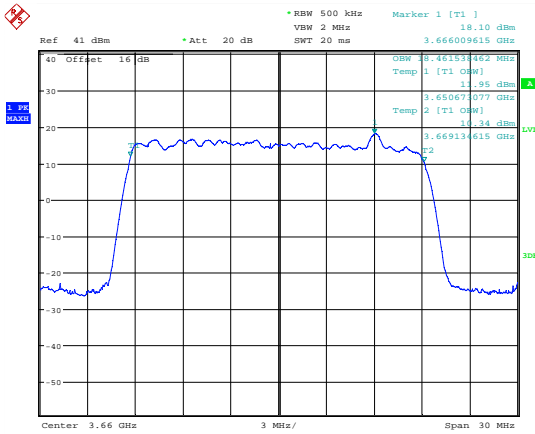

Date: 7.JUL.2018 16:52:24

99 % Bandwidth; 64QAM; 3660 MHz; MIMO A.

Date: 7.JUL.2018 16:55:25

99 % Bandwidth; 64QAM; 3660 MHz; MIMO B.

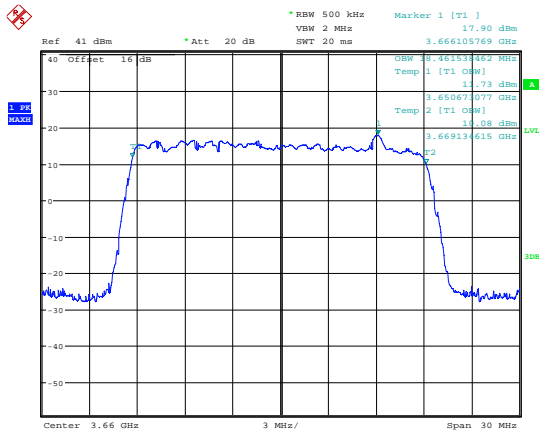

Date: 7.JUL.2018 16:53:07

99 % Bandwidth; 256QAM; 3660 MHz; MIMO A.

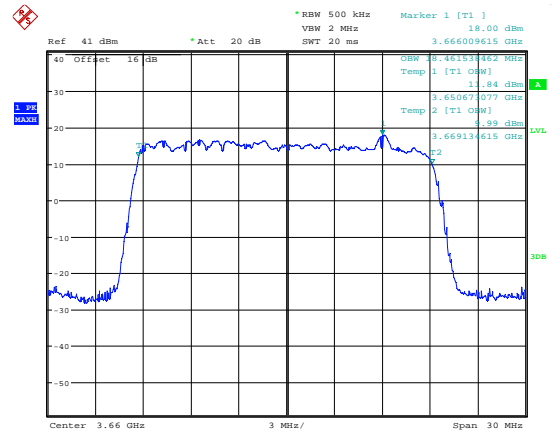

Date: 7.JUL.2018 16:55:59

99 % Bandwidth; 256QAM; 3660 MHz; MIMO B.

Bottom Channel 20 MHz bandwidth						
Frequency (MHz)	Modulation Mode	MIMO	FL (MHz)	FH (MHz)	99 % Bandwidth (kHz)	Result
3660	QPSK	A	3650.673	3669.134	18461	Pass
3660	QPSK	B	3650.673	3669.134	18461	Pass
3660	16QAM	A	3650.673	3669.134	18461	Pass
3660	16QAM	B	3650.673	3669.134	18461	Pass
3660	64QAM	A	3650.673	3669.134	18461	Pass
3660	64QAM	B	3650.673	3669.134	18461	Pass
3660	256QAM	A	3650.673	3669.134	18461	Pass
3660	256QAM	B	3650.673	3669.134	18461	Pass

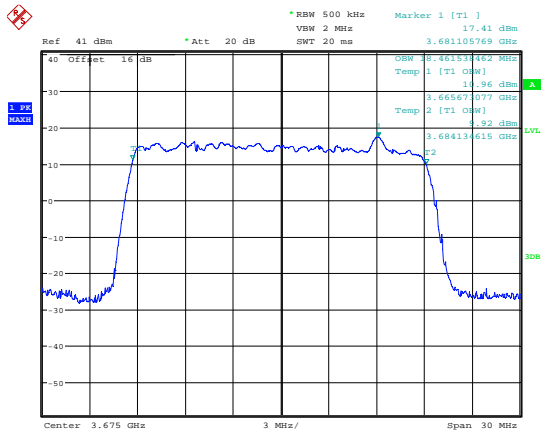

Date: 7.JUL.2018 17:19:24
 99 % Bandwidth; QPSK; 3675 MHz; MIMO A.

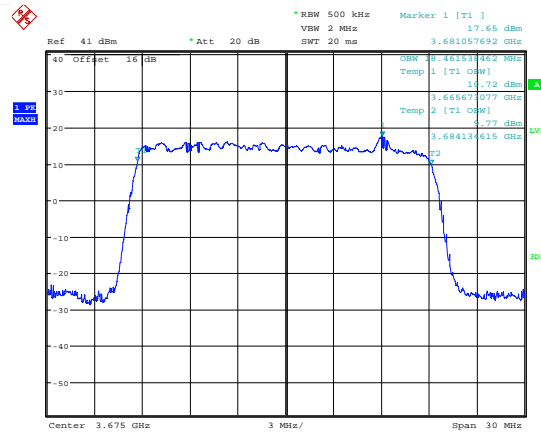

Date: 7.JUL.2018 17:22:21
 99 % Bandwidth; QPSK; 3675 MHz; MIMO B.

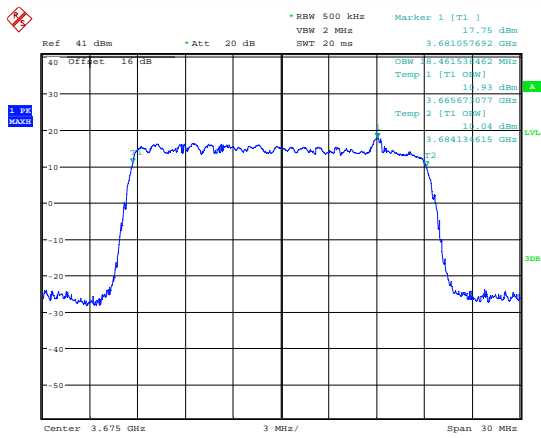

Date: 7.JUL.2018 17:20:00
 99 % Bandwidth; 16QAM; 3675 MHz; MIMO A.

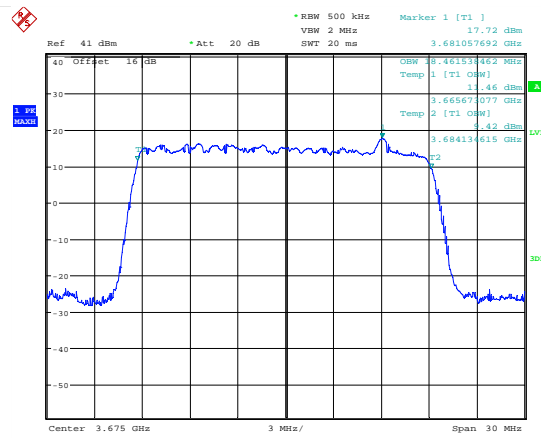

Date: 7.JUL.2018 17:23:13
 99 % Bandwidth; 16QAM; 3675 MHz; MIMO B.

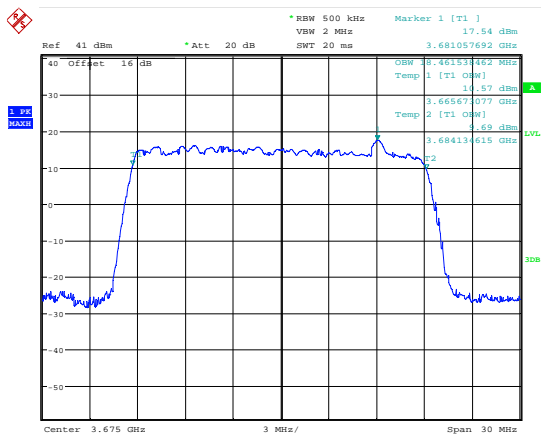

Date: 7.JUL.2018 17:20:46
 99 % Bandwidth; 64QAM; 3675 MHz; MIMO A.

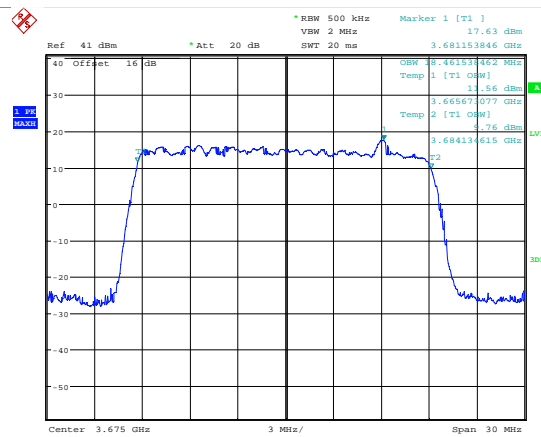

Date: 7.JUL.2018 17:23:57
 99 % Bandwidth; 64QAM; 3675 MHz; MIMO B.

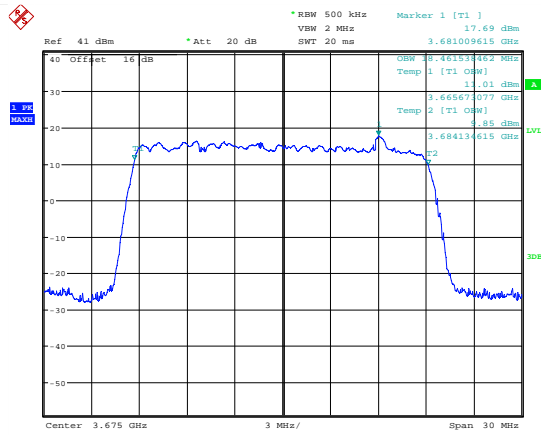
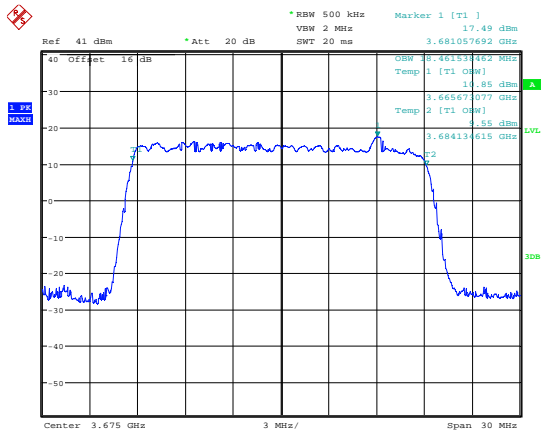

Date: 7.JUL.2018 17:21:32

Date: 7.JUL.2018 17:24:44

99 % Bandwidth; 256QAM; 3675 MHz; MIMO A.

99 % Bandwidth; 256QAM; 3675 MHz; MIMO B.

Middle Channel 20 MHz bandwidth						
Frequency (MHz)	Modulation Mode	MIMO	FL (MHz)	FH (MHz)	99 % Bandwidth (kHz)	Result
3675	QPSK	A	3665.673	3684.134	18461	Pass
3675	QPSK	B	3665.673	3684.134	18461	Pass
3675	16QAM	A	3665.673	3684.134	18461	Pass
3675	16QAM	B	3665.673	3684.134	18461	Pass
3675	64QAM	A	3665.673	3684.134	18461	Pass
3675	64QAM	B	3665.673	3684.134	18461	Pass
3675	256QAM	A	3665.673	3684.134	18461	Pass
3675	256QAM	B	3665.673	3684.134	18461	Pass

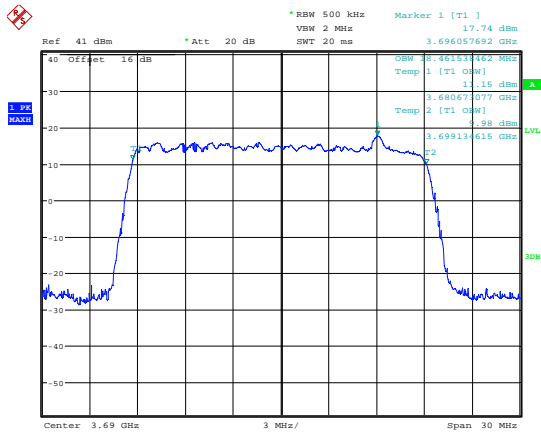

Date: 7.JUL.2018 17:47:52
99 % Bandwidth; QPSK; 3690 MHz; MIMO A.

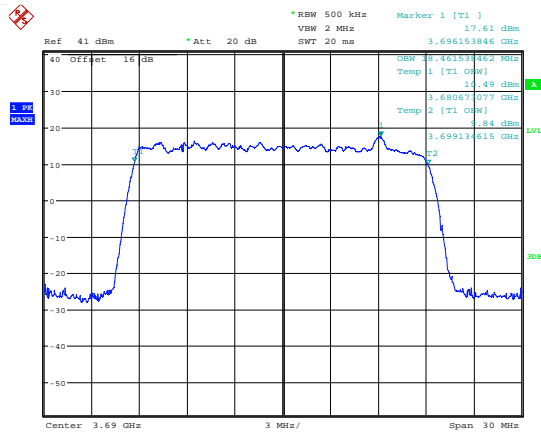

Date: 7.JUL.2018 17:44:46
99 % Bandwidth; QPSK; 3690 MHz; MIMO B.

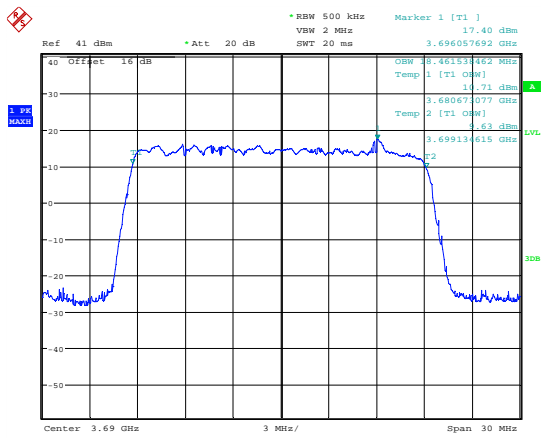

Date: 7.JUL.2018 17:47:10
99 % Bandwidth; 16QAM; 3690 MHz; MIMO A.

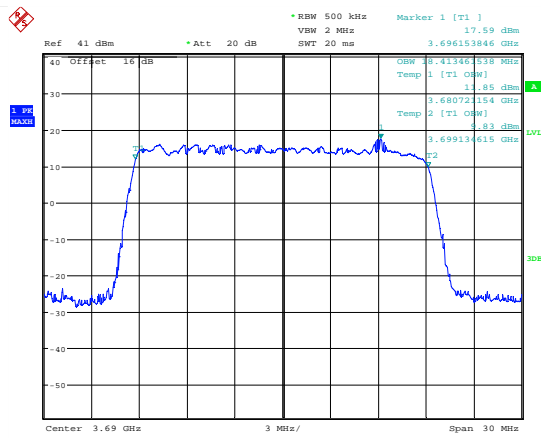

Date: 7.JUL.2018 17:43:42
99 % Bandwidth; 16QAM; 3690 MHz; MIMO B.

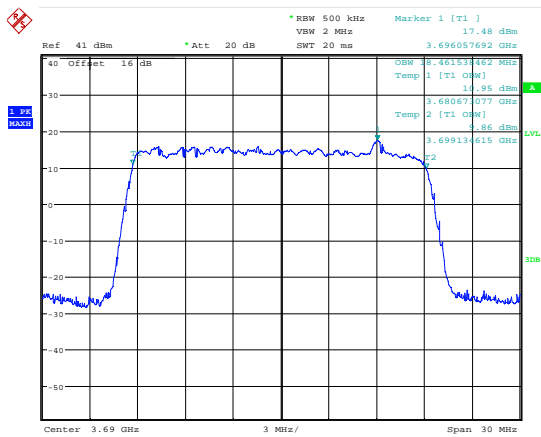

Date: 7.JUL.2018 17:46:20
99 % Bandwidth; 64QAM; 3690 MHz; MIMO A.

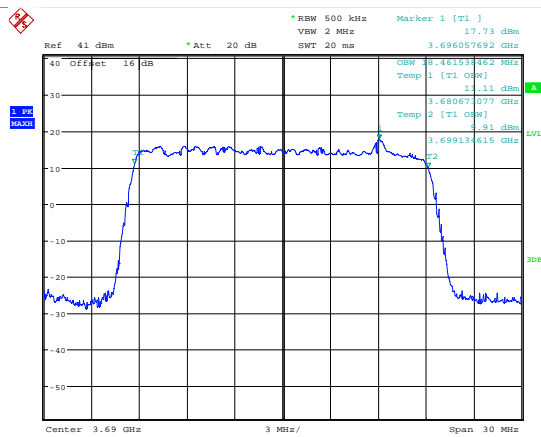

Date: 7.JUL.2018 17:43:08
99 % Bandwidth; 64QAM; 3690 MHz; MIMO B.

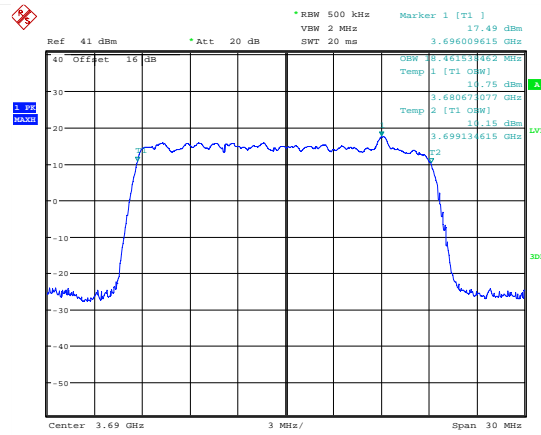
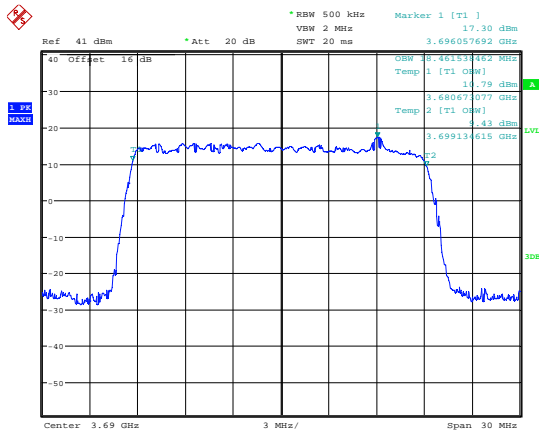

Date: 7.JUL.2018 17:45:28

Date: 7.JUL.2018 17:42:32

99 % Bandwidth; 256QAM; 3690 MHz; MIMO A.

99 % Bandwidth; 256QAM; 3690 MHz; MIMO B.

Top Channel 20 MHz bandwidth						
Frequency (MHz)	Modulation Mode	MIMO	FL (MHz)	FH (MHz)	99 % Bandwidth (kHz)	Result
3690	QPSK	A	3680.673	3699.134	18461	Pass
3690	QPSK	B	3680.673	3699.134	18461	Pass
3690	16QAM	A	3680.673	3699.134	18461	Pass
3690	16QAM	B	3680.721	3699.134	18413	Pass
3690	64QAM	A	3680.673	3699.134	18461	Pass
3690	64QAM	B	3680.673	3699.134	18461	Pass
3690	256QAM	A	3680.673	3699.134	18461	Pass
3690	256QAM	B	3680.673	3699.134	18461	Pass

40 MHz Bandwidth Beamforming

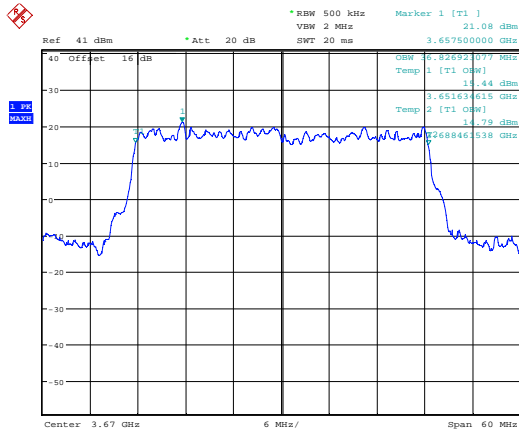

Date: 7.JUL.2018 19:40:59

99 % Bandwidth; QPSK; 3670 MHz; MIMO A.

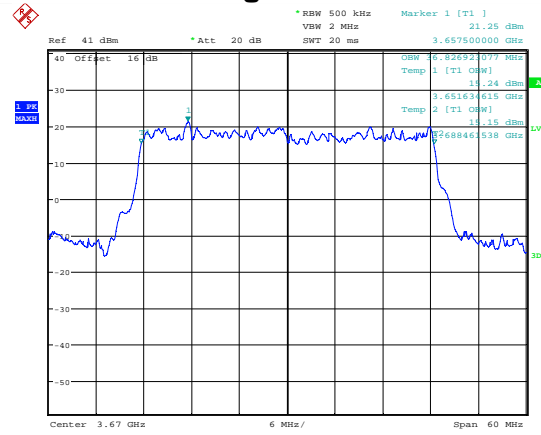

Date: 7.JUL.2018 19:38:26

99 % Bandwidth; QPSK; 3670 MHz; MIMO B.

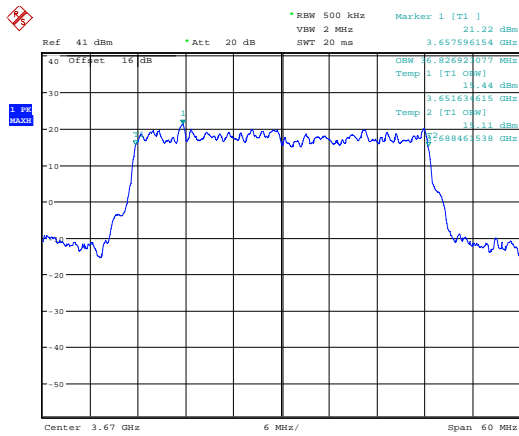

Date: 7.JUL.2018 19:40:23

99 % Bandwidth; 16QAM; 3670 MHz; MIMO A.

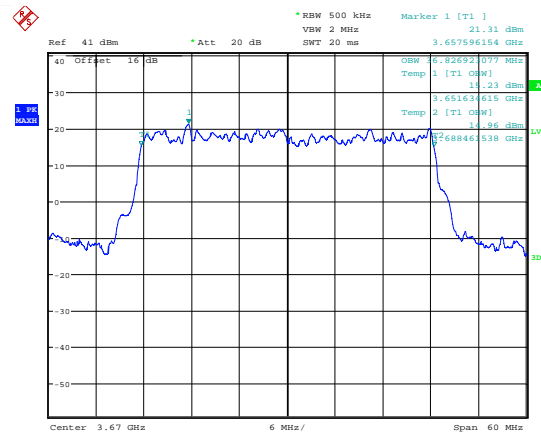

Date: 7.JUL.2018 19:37:50

99 % Bandwidth; 16QAM; 3670 MHz; MIMO B.

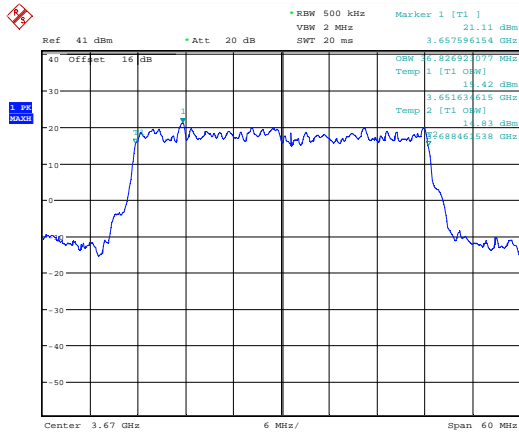

Date: 7.JUL.2018 19:39:53

99 % Bandwidth; 64QAM; 3670 MHz; MIMO A.

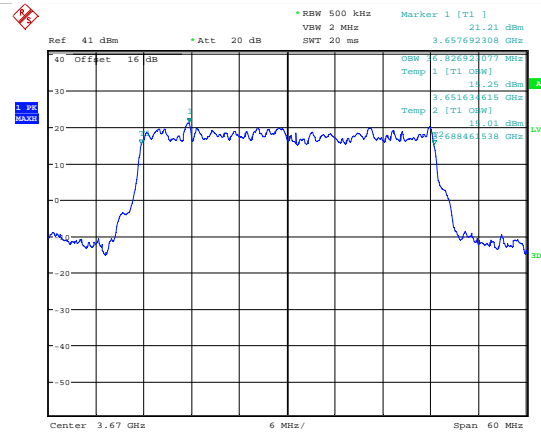

Date: 7.JUL.2018 19:37:14

99 % Bandwidth; 64QAM; 3670 MHz; MIMO B.

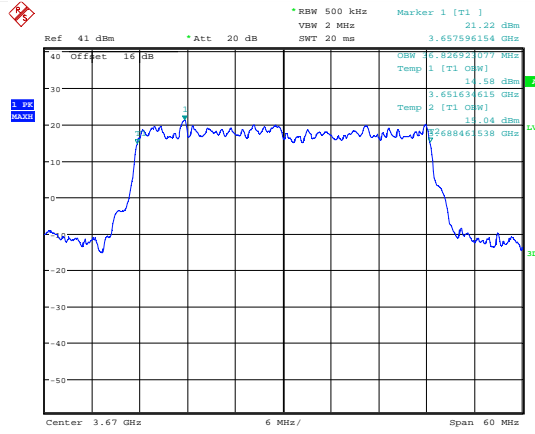
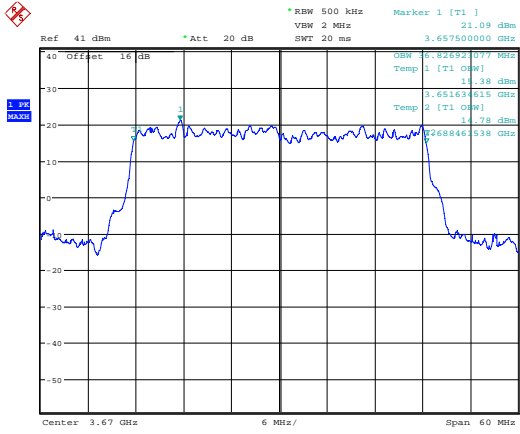

Date: 7.JUL.2018 19:39:11

Date: 7.JUL.2018 19:36:33

99 % Bandwidth; 256QAM; 3670 MHz; MIMO A.

99 % Bandwidth; 256QAM; 3670 MHz; MIMO B.

Bottom Channel 40 MHz bandwidth						
Frequency (MHz)	Modulation Mode	MIMO	FL (MHz)	FH (MHz)	99 % Bandwidth (kHz)	Result
3670	QPSK	A	3651.635	3688.462	36827	Pass
3670	QPSK	B	3651.635	3688.462	36827	Pass
3670	16QAM	A	3651.635	3688.462	36827	Pass
3670	16QAM	B	3651.635	3688.462	36827	Pass
3670	64QAM	A	3651.635	3688.462	36827	Pass
3670	64QAM	B	3651.635	3688.462	36827	Pass
3670	256QAM	A	3651.635	3688.462	36827	Pass
3670	256QAM	B	3651.635	3688.462	36827	Pass

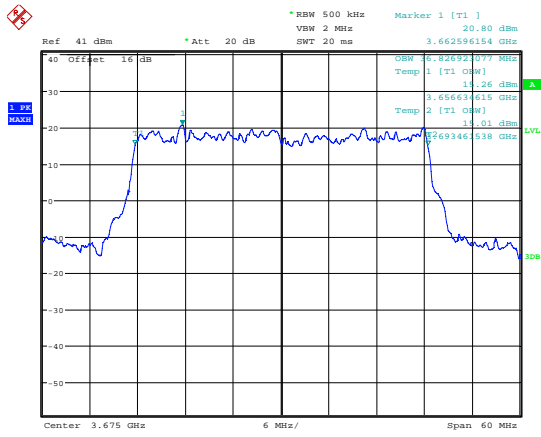

Date: 7.JUL.2018 19:54:20
99 % Bandwidth; QPSK; 3675 MHz; MIMO A.

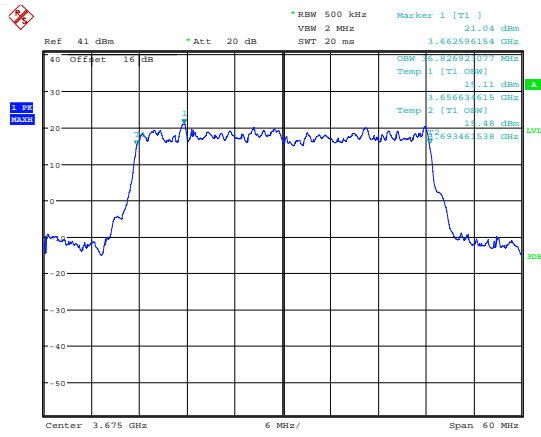

Date: 7.JUL.2018 19:57:55
99 % Bandwidth; QPSK; 3675 MHz; MIMO B.

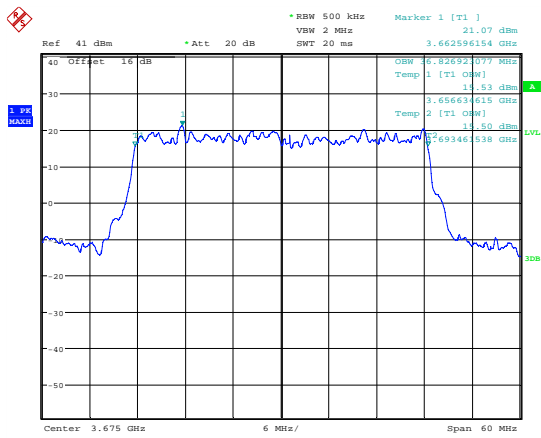

Date: 7.JUL.2018 19:56:00
99 % Bandwidth; 16QAM; 3675 MHz; MIMO A.

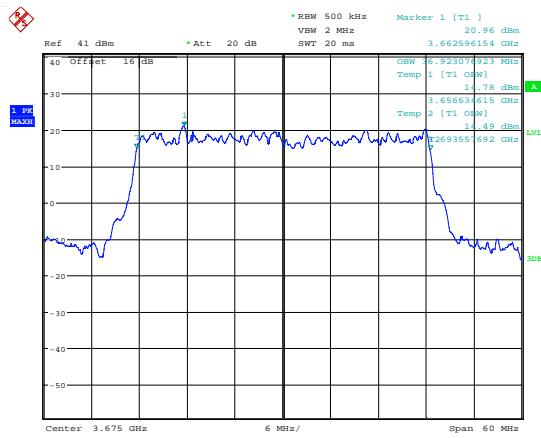

Date: 7.JUL.2018 19:58:26
99 % Bandwidth; 16QAM; 3675 MHz; MIMO B.

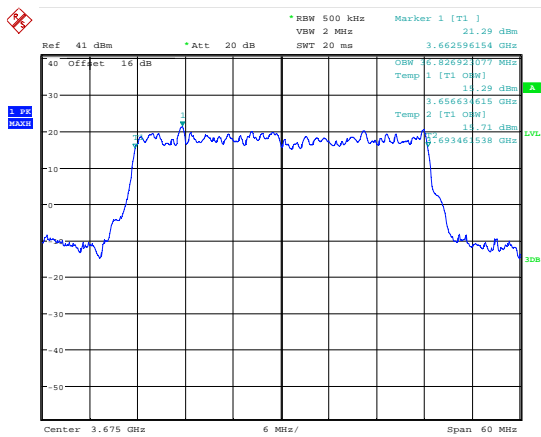

Date: 7.JUL.2018 19:56:43
99 % Bandwidth; 64QAM; 3675 MHz; MIMO A.

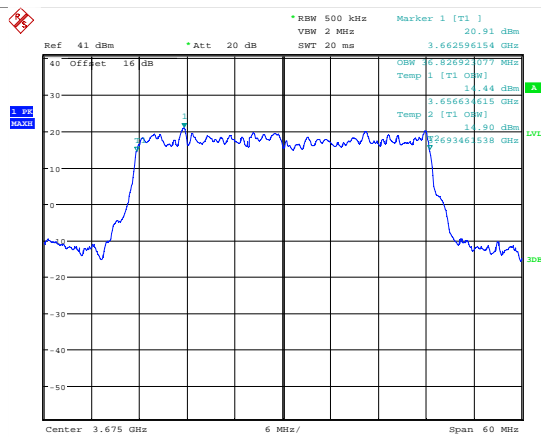

Date: 7.JUL.2018 19:59:03
99 % Bandwidth; 64QAM; 3675 MHz; MIMO B.

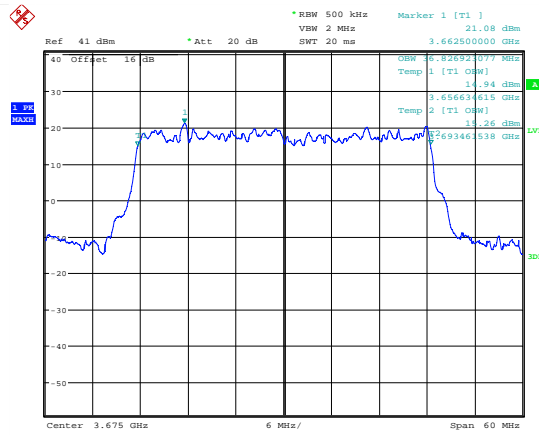
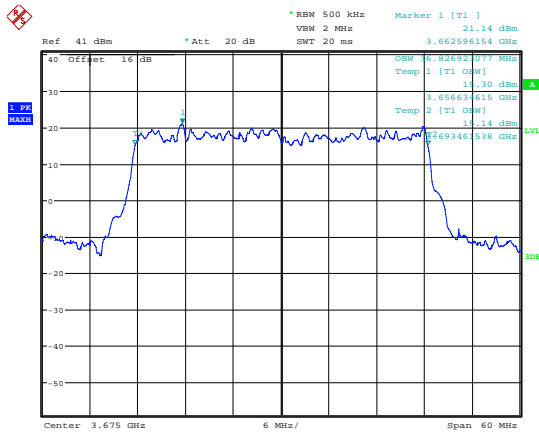

Date: 7.JUL.2018 19:57:23

Date: 7.JUL.2018 19:59:38

99 % Bandwidth; 256QAM; 3675 MHz; MIMO A.

99 % Bandwidth; 256QAM; 3675 MHz; MIMO B.

Middle Channel 40 MHz bandwidth						
Frequency (MHz)	Modulation Mode	MIMO	FL (MHz)	FH (MHz)	99 % Bandwidth (kHz)	Result
3675	QPSK	A	3656.635	3693.462	36827	Pass
3675	QPSK	B	3656.635	3693.462	36827	Pass
3675	16QAM	A	3656.635	3693.462	36827	Pass
3675	16QAM	B	3656.635	3693.557	36922	Pass
3675	64QAM	A	3656.635	3693.462	36827	Pass
3675	64QAM	B	3656.635	3693.462	36827	Pass
3675	256QAM	A	3656.635	3693.462	36827	Pass
3675	256QAM	B	3656.635	3693.462	36827	Pass

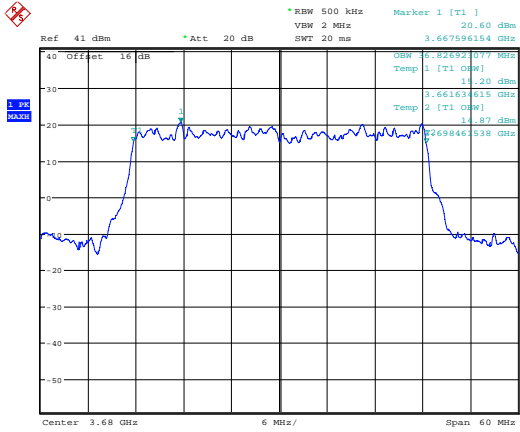

Date: 7.JUL.2018 20:22:33
99 % Bandwidth; QPSK; 3680 MHz; MIMO A.

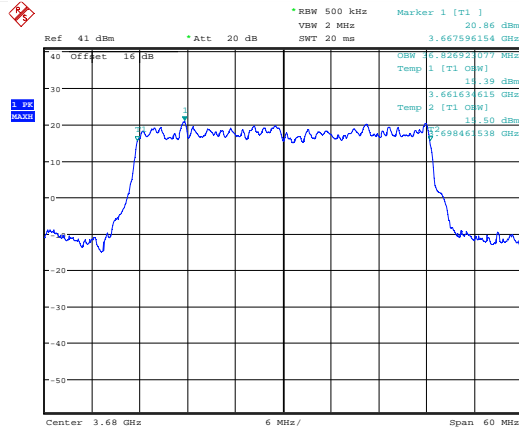

Date: 7.JUL.2018 20:19:55
99 % Bandwidth; QPSK; 3680 MHz; MIMO B.

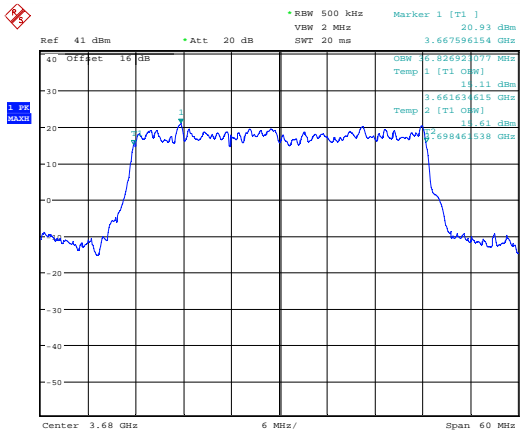

Date: 7.JUL.2018 20:21:47
99 % Bandwidth; 16QAM; 3680 MHz; MIMO A.

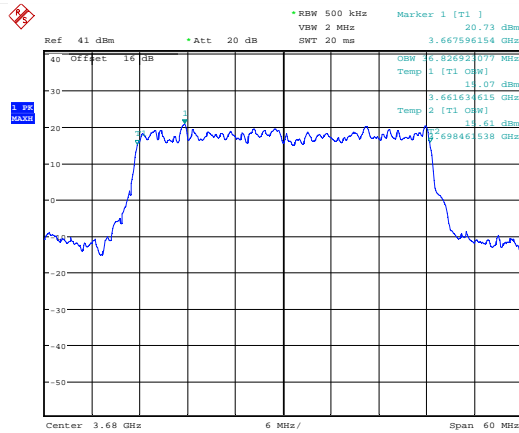

Date: 7.JUL.2018 20:19:12
99 % Bandwidth; 16QAM; 3680 MHz; MIMO B.

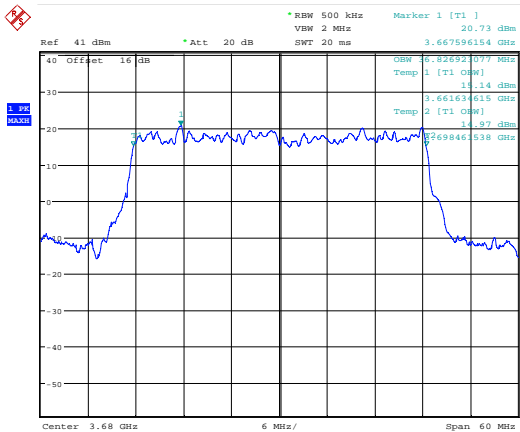

Date: 7.JUL.2018 20:21:15
99 % Bandwidth; 64QAM; 3680 MHz; MIMO A.

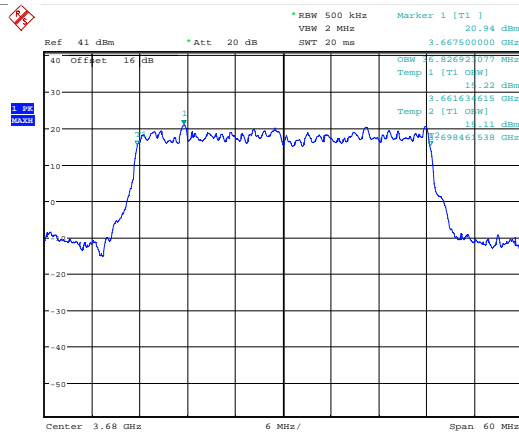

Date: 7.JUL.2018 20:18:38
99 % Bandwidth; 64QAM; 3680 MHz; MIMO B.

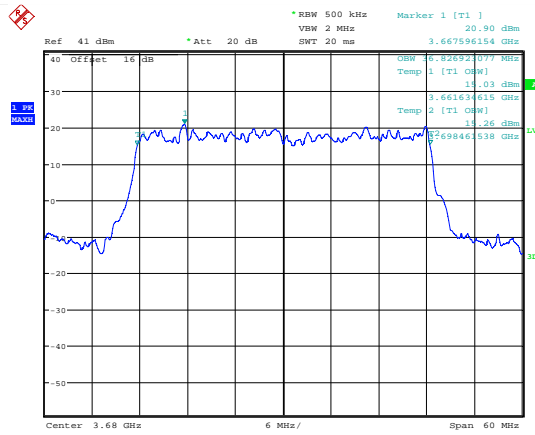
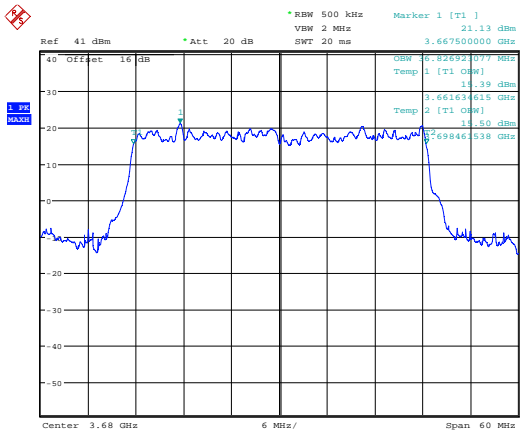

Date: 7.JUL.2018 20:20:39

Date: 7.JUL.2018 20:18:06

99 % Bandwidth; 256QAM; 3680 MHz;
MIMO A.

99 % Bandwidth; 256QAM; 3680 MHz;
MIMO B.

Top Channel 40 MHz bandwidth						
Frequency (MHz)	Modulation Mode	MIMO	FL (MHz)	FH (MHz)	99 % Bandwidth (kHz)	Result
3680	QPSK	A	3661.635	3698.462	36827	Pass
3680	QPSK	B	3661.635	3698.462	36827	Pass
3680	16QAM	A	3661.635	3698.462	36827	Pass
3680	16QAM	B	3661.635	3698.462	36827	Pass
3680	64QAM	A	3661.635	3698.462	36827	Pass
3680	64QAM	B	3661.635	3698.462	36827	Pass
3680	256QAM	A	3661.635	3698.462	36827	Pass
3680	256QAM	B	3661.635	3698.462	36827	Pass

40 MHz Bandwidth Sector

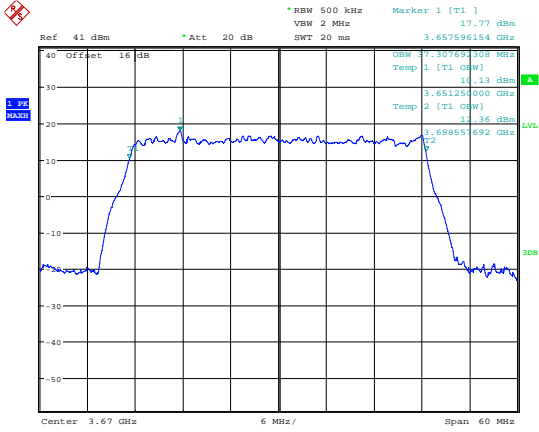

Date: 7.JUL.2018 19:29:51

99 % Bandwidth; QPSK; 3670 MHz; MIMO A.

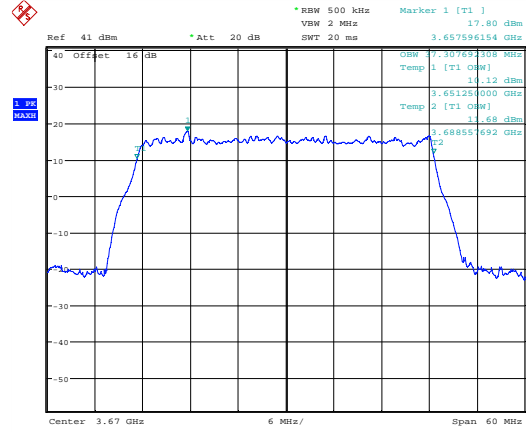

Date: 7.JUL.2018 19:32:46

99 % Bandwidth; QPSK; 3670 MHz; MIMO B.

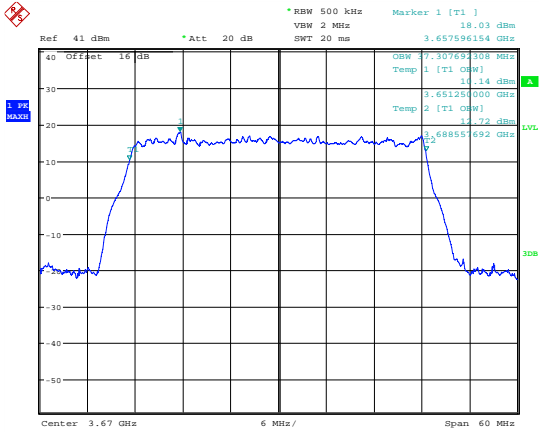

Date: 7.JUL.2018 19:30:45

99 % Bandwidth; 16QAM; 3670 MHz; MIMO A.

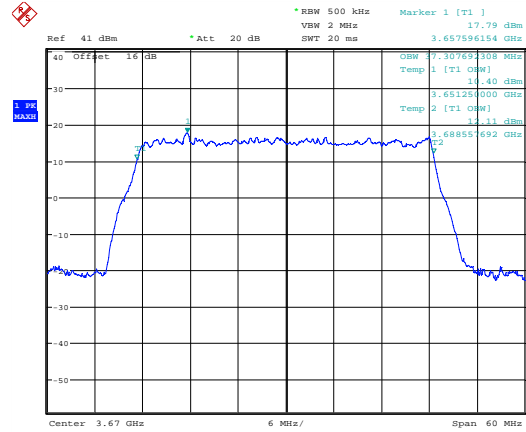

Date: 7.JUL.2018 19:33:24

99 % Bandwidth; 16QAM; 3670 MHz; MIMO B.

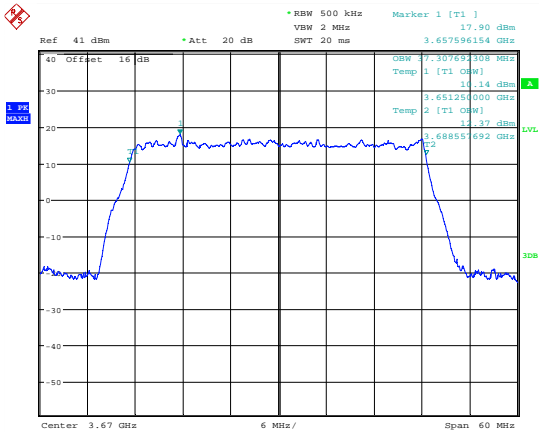

Date: 7.JUL.2018 19:31:24

99 % Bandwidth; 64QAM; 3670 MHz; MIMO A.

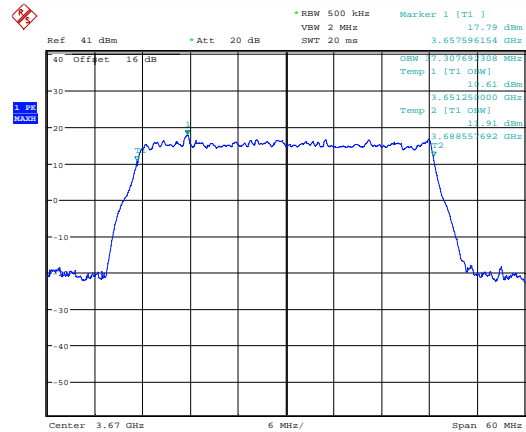

Date: 7.JUL.2018 19:34:04

99 % Bandwidth; 64QAM; 3670 MHz; MIMO B.

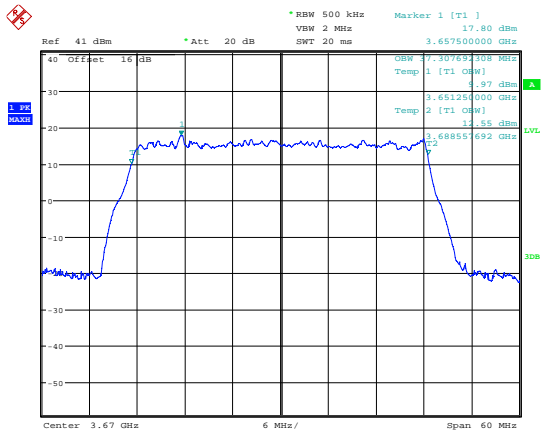

Date: 7 JUL 2018 19:32:05

99 % Bandwidth; 256QAM; 3670 MHz; MIMO A.

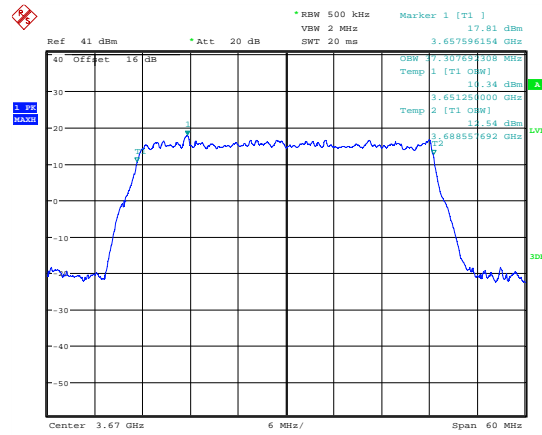

Date: 7 JUL 2018 19:34:54

99 % Bandwidth; 256QAM; 3670 MHz; MIMO B.

Bottom Channel 40 MHz bandwidth						
Frequency (MHz)	Modulation Mode	MIMO	FL (MHz)	FH (MHz)	99 % Bandwidth (kHz)	Result
3670	QPSK	A	3651.25	3688.558	37308	Pass
3670	QPSK	B	3651.25	3688.558	37308	Pass
3670	16QAM	A	3651.25	3688.558	37308	Pass
3670	16QAM	B	3651.25	3688.558	37308	Pass
3670	64QAM	A	3651.25	3688.558	37308	Pass
3670	64QAM	B	3651.25	3688.558	37308	Pass
3670	256QAM	A	3651.25	3688.558	37308	Pass
3670	256QAM	B	3651.25	3688.558	37308	Pass

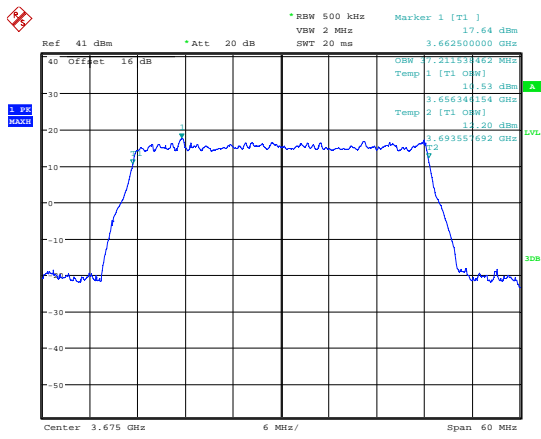

Date: 7.JUL.2018 20:07:39
99 % Bandwidth; QPSK; 3675 MHz; MIMO A.

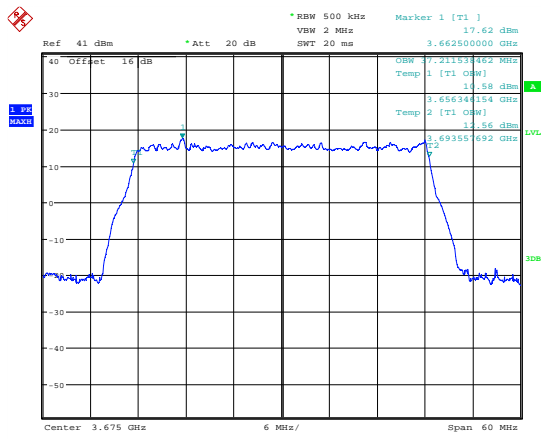

Date: 7.JUL.2018 20:05:47
99 % Bandwidth; QPSK; 3675 MHz; MIMO B.

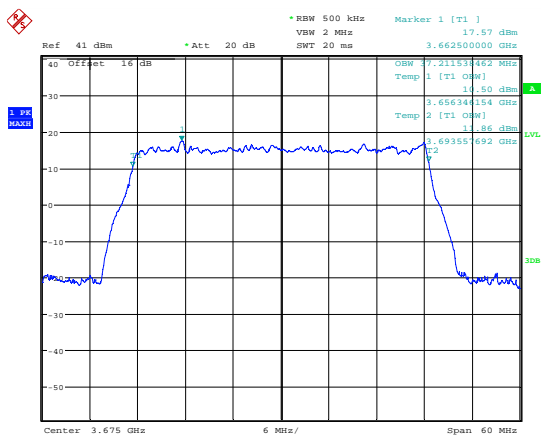

Date: 7.JUL.2018 20:07:09
99 % Bandwidth; 16QAM; 3675 MHz; MIMO A.

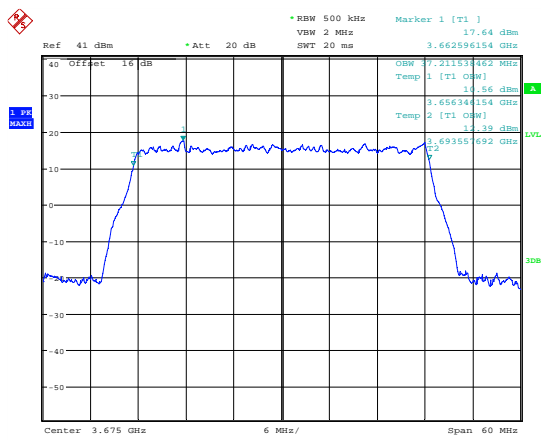

Date: 7.JUL.2018 20:05:11
99 % Bandwidth; 16QAM; 3675 MHz; MIMO B.

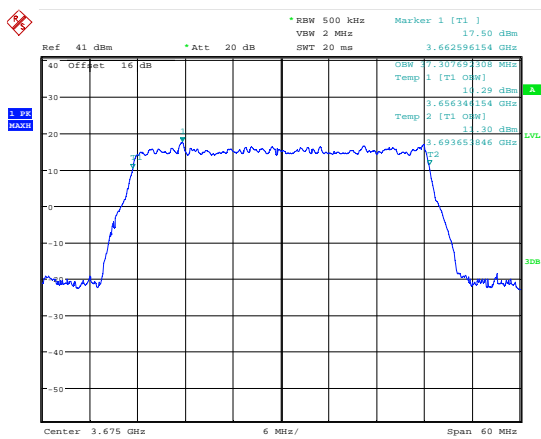

Date: 7.JUL.2018 20:06:43
99 % Bandwidth; 64QAM; 3675 MHz; MIMO A.

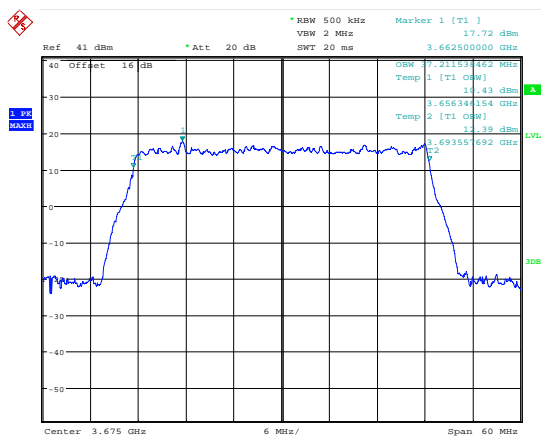

Date: 7.JUL.2018 20:04:43
99 % Bandwidth; 64QAM; 3675 MHz; MIMO B.

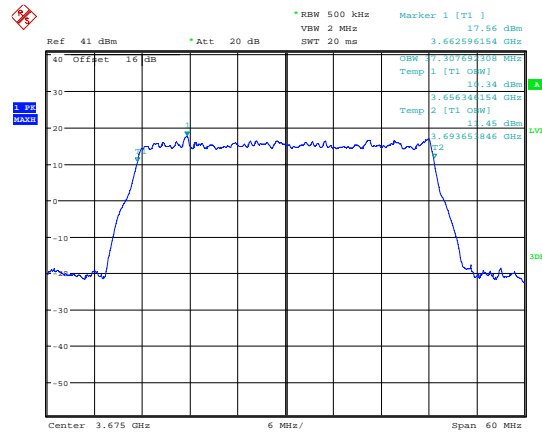
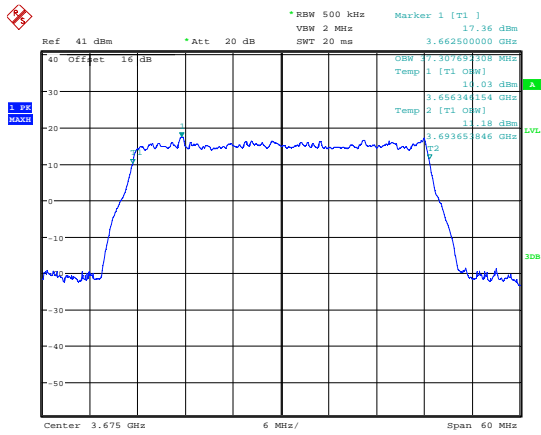

Date: 7.JUL.2018 20:06:20

Date: 7.JUL.2018 20:04:17

99 % Bandwidth; 256QAM; 3675 MHz; MIMO A.

99 % Bandwidth; 256QAM; 3675 MHz; MIMO B.

Middle Channel 40 MHz bandwidth						
Frequency (MHz)	Modulation Mode	MIMO	FL (MHz)	FH (MHz)	99 % Bandwidth (kHz)	Result
3675	QPSK	A	3656.346	3693.558	37212	Pass
3675	QPSK	B	3656.346	3693.558	37212	Pass
3675	16QAM	A	3656.346	3693.558	37212	Pass
3675	16QAM	B	3656.346	3693.558	37212	Pass
3675	64QAM	A	3656.346	3693.654	37308	Pass
3675	64QAM	B	3656.346	3693.558	37212	Pass
3675	256QAM	A	3656.346	3693.654	37308	Pass
3675	256QAM	B	3656.346	3693.654	37308	Pass

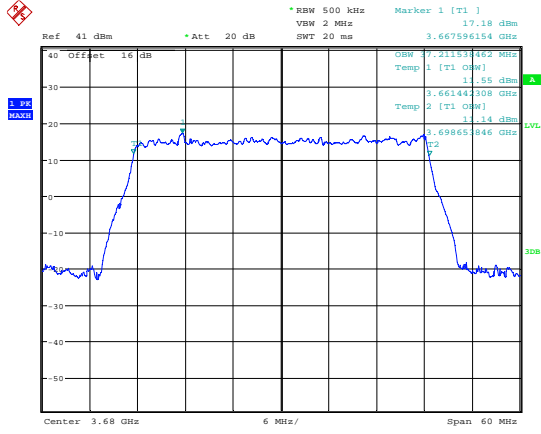

Date: 7.JUL.2018 20:08:51

99 % Bandwidth; QPSK; 3680 MHz; MIMO A.

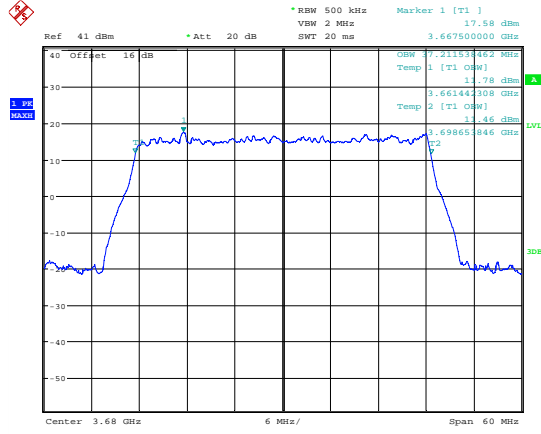

Date: 7.JUL.2018 20:12:43

99 % Bandwidth; QPSK; 3680 MHz; MIMO B.

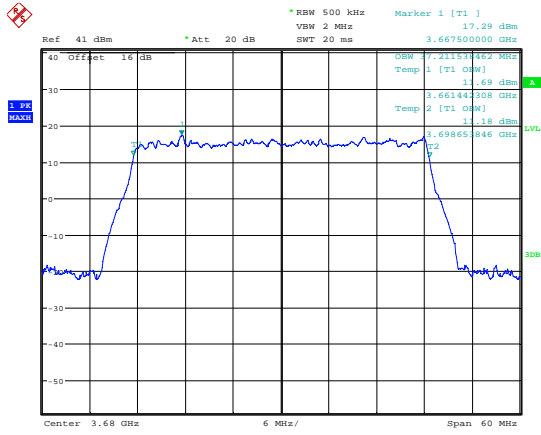

Date: 7.JUL.2018 20:09:30

99 % Bandwidth; 16QAM; 3680 MHz; MIMO A.

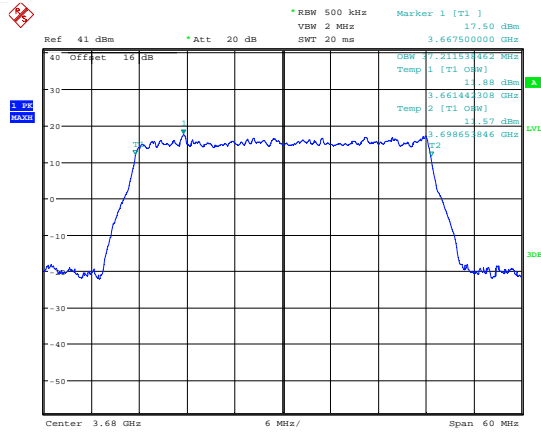

Date: 7.JUL.2018 20:13:40

99 % Bandwidth; 16QAM; 3680 MHz; MIMO B.

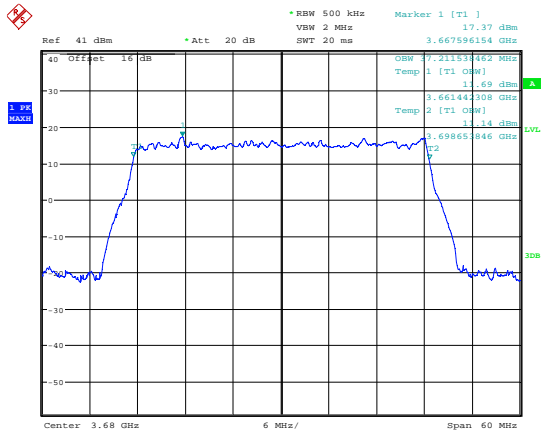

Date: 7.JUL.2018 20:10:07

99 % Bandwidth; 64QAM; 3680 MHz; MIMO A.

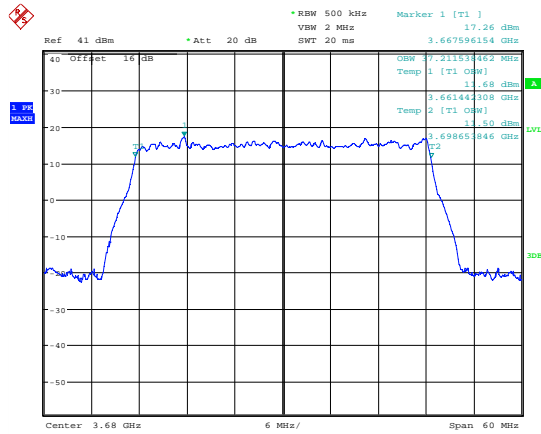

Date: 7.JUL.2018 20:14:40

99 % Bandwidth; 64QAM; 3680 MHz; MIMO B.

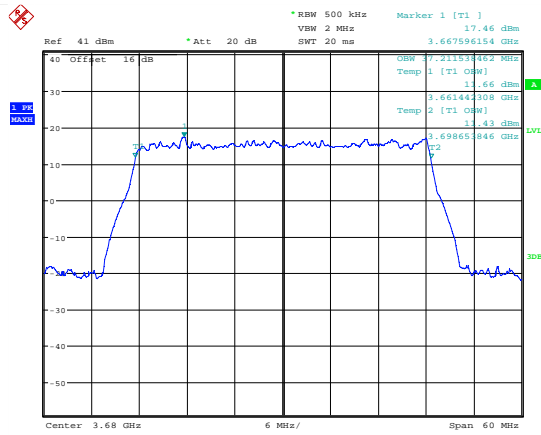
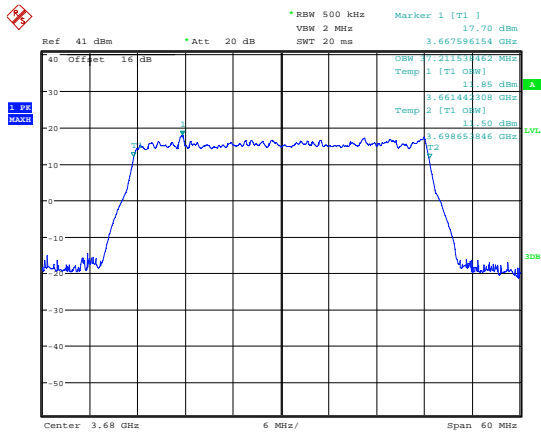

Date: 7.JUL.2018 20:10:55

Date: 7.JUL.2018 20:16:17

99 % Bandwidth; 256QAM; 3680 MHz; MIMO A.

99 % Bandwidth; 256QAM; 3680 MHz; MIMO B.

Top Channel 40 MHz bandwidth						
Frequency (MHz)	Modulation Mode	MIMO	FL (MHz)	FH (MHz)	99 % Bandwidth (kHz)	Result
3680	QPSK	A	3661.442	3698.654	37212	Pass
3680	QPSK	B	3661.442	3698.654	37212	Pass
3680	16QAM	A	3661.442	3698.654	37212	Pass
3680	16QAM	B	3661.442	3698.654	37212	Pass
3680	64QAM	A	3661.442	3698.654	37212	Pass
3680	64QAM	B	3661.442	3698.654	37212	Pass
3680	256QAM	A	3661.442	3698.654	37212	Pass
3680	256QAM	B	3661.442	3698.654	37212	Pass

40 MHz Bandwidth MU-MIMO

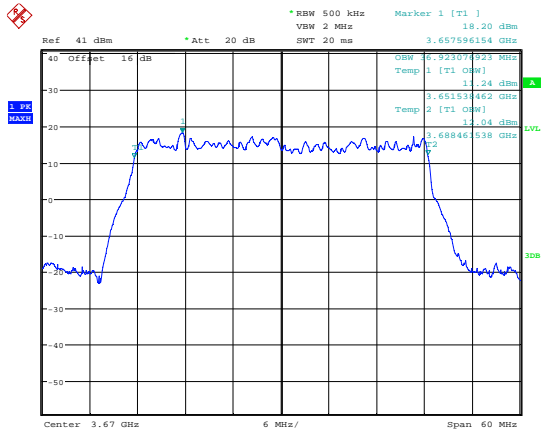

Date: 7.JUL.2018 19:42:37

99 % Bandwidth; QPSK; 3670 MHz; MIMO A.

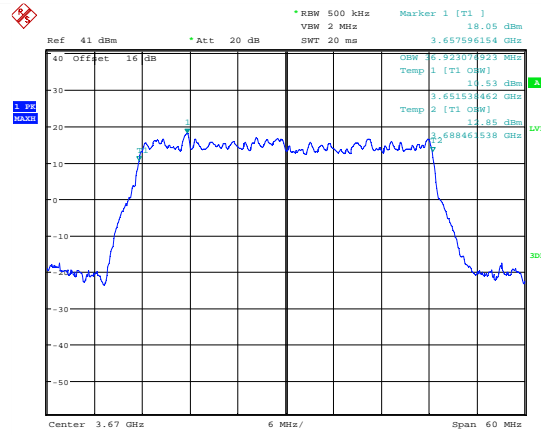

Date: 7.JUL.2018 19:45:10

99 % Bandwidth; QPSK; 3670 MHz; MIMO B.

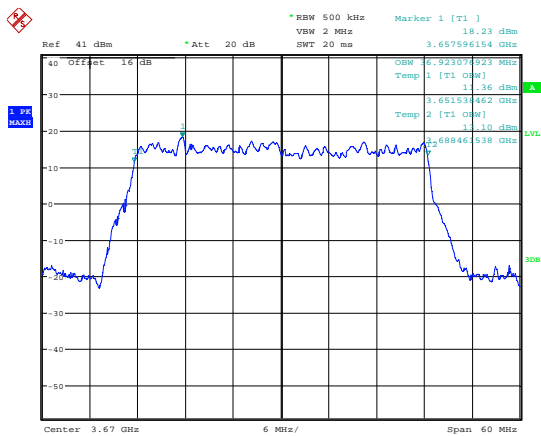

Date: 7.JUL.2018 19:43:13

99 % Bandwidth; 16QAM; 3670 MHz; MIMO A.

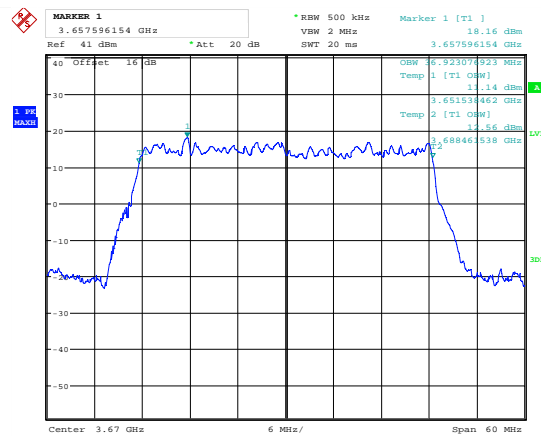

Date: 7.JUL.2018 19:45:46

99 % Bandwidth; 16QAM; 3670 MHz; MIMO B.

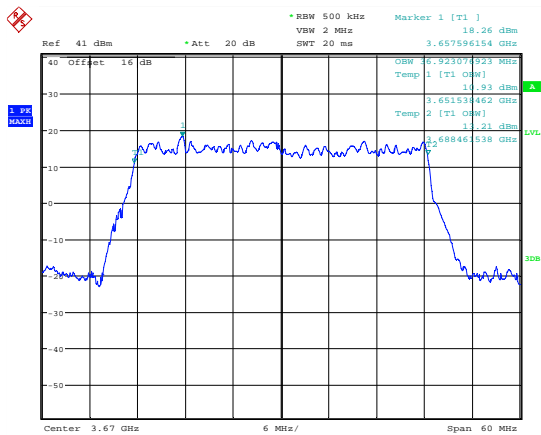

Date: 7.JUL.2018 19:43:46

99 % Bandwidth; 64QAM; 3670 MHz; MIMO A.

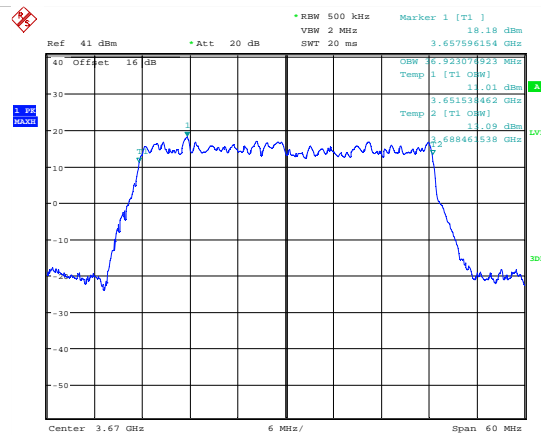

Date: 7.JUL.2018 19:46:18

99 % Bandwidth; 64QAM; 3670 MHz; MIMO B.

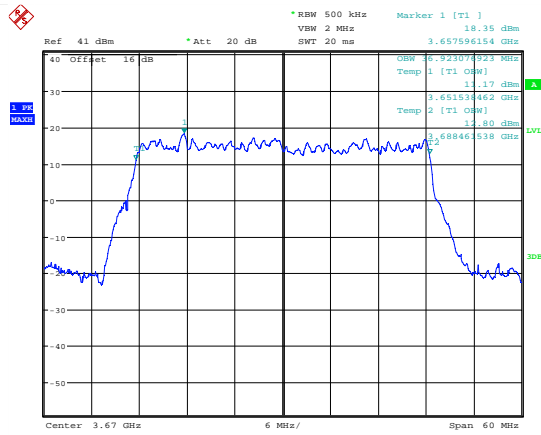
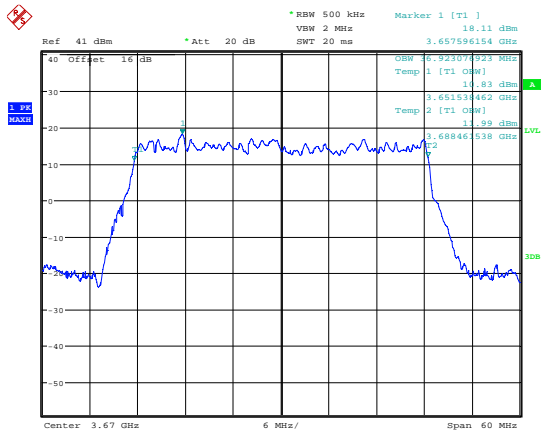

Date: 7.JUL.2018 19:44:22

Date: 7.JUL.2018 19:46:48

99 % Bandwidth; 256QAM; 3670 MHz; MIMO A.

99 % Bandwidth; 256QAM; 3670 MHz; MIMO B.

Bottom Channel 40 MHz bandwidth						
Frequency (MHz)	Modulation Mode	MIMO	FL (MHz)	FH (MHz)	99 % Bandwidth (kHz)	Result
3670	QPSK	A	3651.538	3688.461	36923	Pass
3670	QPSK	B	3651.538	3688.461	36923	Pass
3670	16QAM	A	3651.538	3688.461	36923	Pass
3670	16QAM	B	3651.538	3688.461	36923	Pass
3670	64QAM	A	3651.538	3688.461	36923	Pass
3670	64QAM	B	3651.538	3688.461	36923	Pass
3670	256QAM	A	3651.538	3688.461	36923	Pass
3670	256QAM	B	3651.538	3688.461	36923	Pass

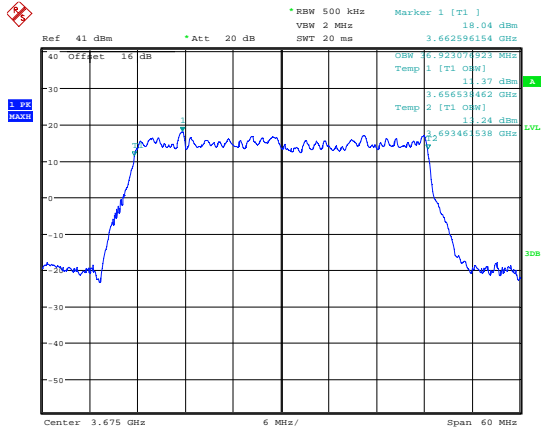

Date: 7.JUL.2018 19:52:56
99 % Bandwidth; QPSK; 3675 MHz; MIMO A.

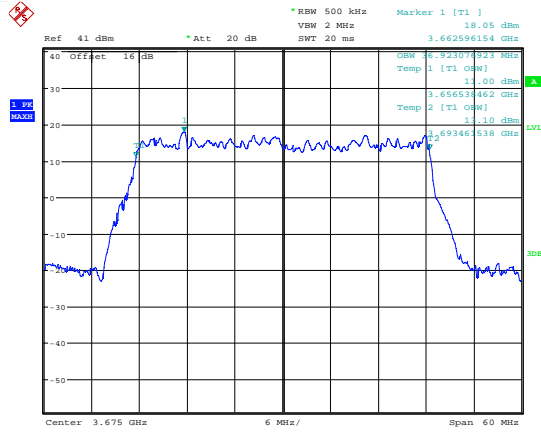

Date: 7.JUL.2018 19:50:09
99 % Bandwidth; QPSK; 3675 MHz; MIMO B.

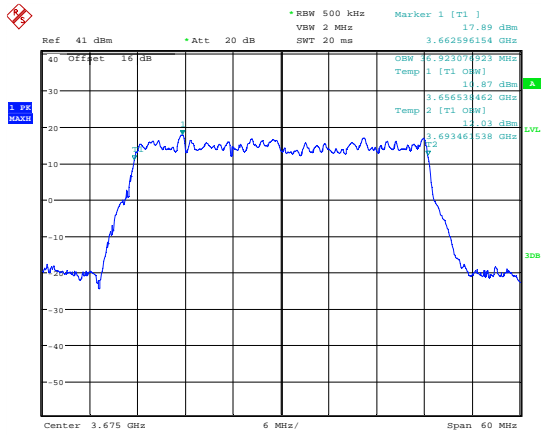

Date: 7.JUL.2018 19:52:18
99 % Bandwidth; 16QAM; 3675 MHz; MIMO A.

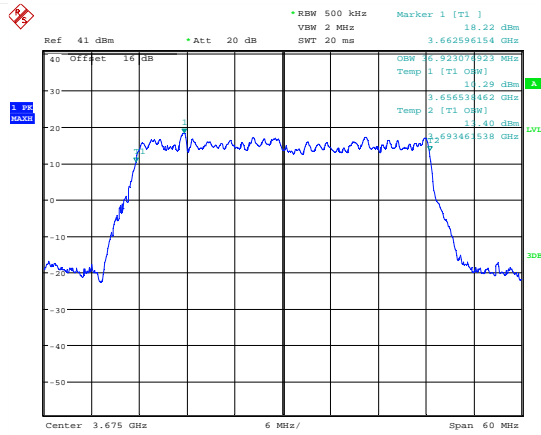

Date: 7.JUL.2018 19:49:34
99 % Bandwidth; 16QAM; 3675 MHz; MIMO B.

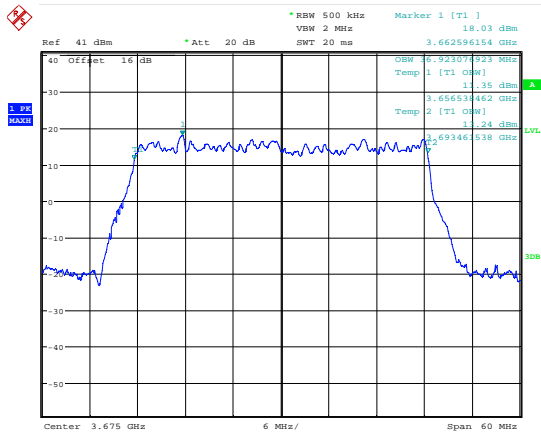

Date: 7.JUL.2018 19:51:32
99 % Bandwidth; 64QAM; 3675 MHz; MIMO A.

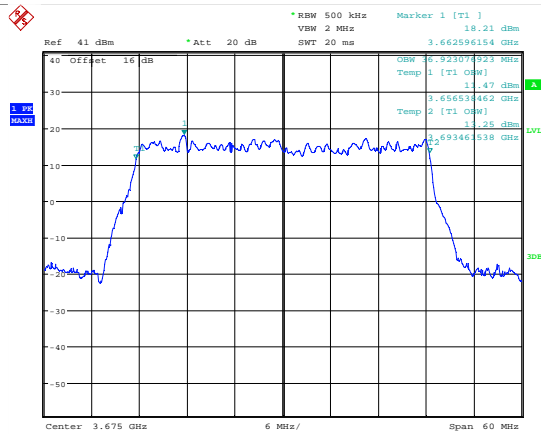

Date: 7.JUL.2018 19:49:06
99 % Bandwidth; 64QAM; 3675 MHz; MIMO B.

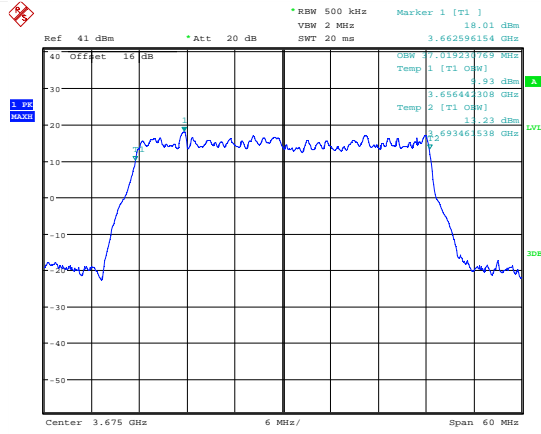
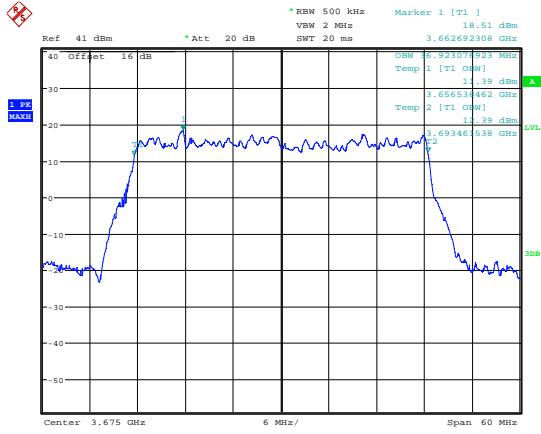

Date: 7.JUL.2018 19:50:42

Date: 7.JUL.2018 19:48:25

99 % Bandwidth; 256QAM; 3675 MHz; MIMO A.

99 % Bandwidth; 256QAM; 3675 MHz; MIMO B.

Middle Channel 40 MHz bandwidth						
Frequency (MHz)	Modulation Mode	MIMO	FL (MHz)	FH (MHz)	99 % Bandwidth (kHz)	Result
3675	QPSK	A	3656.538	3693.462	36924	Pass
3675	QPSK	B	3656.538	3693.462	36924	Pass
3675	16QAM	A	3656.538	3693.462	36924	Pass
3675	16QAM	B	3656.538	3693.462	36924	Pass
3675	64QAM	A	3656.538	3693.462	36924	Pass
3675	64QAM	B	3656.538	3693.462	36924	Pass
3675	256QAM	A	3656.538	3693.462	36924	Pass
3675	256QAM	B	3656.538	3693.442	37020	Pass

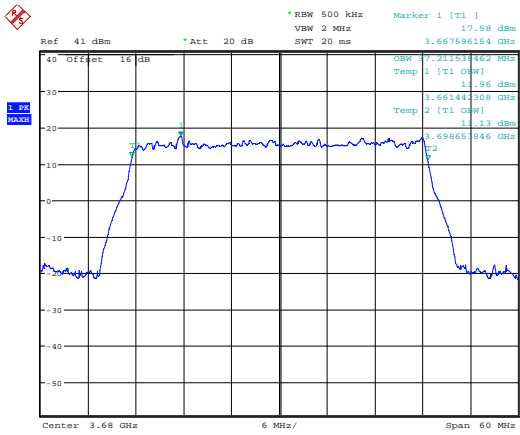

Date: 7.JUL.2018 20:24:09

99 % Bandwidth; QPSK; 3680 MHz; MIMO A.

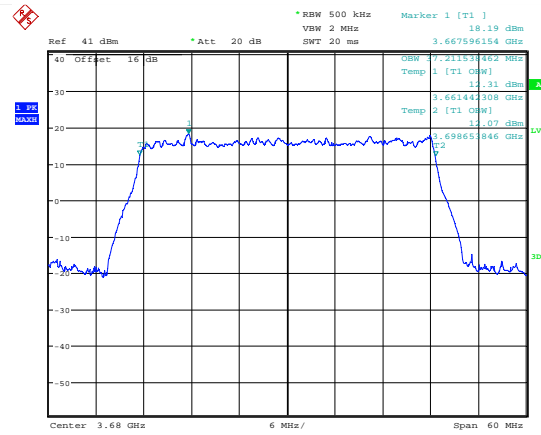

Date: 7.JUL.2018 20:26:19

99 % Bandwidth; QPSK; 3680 MHz; MIMO B.

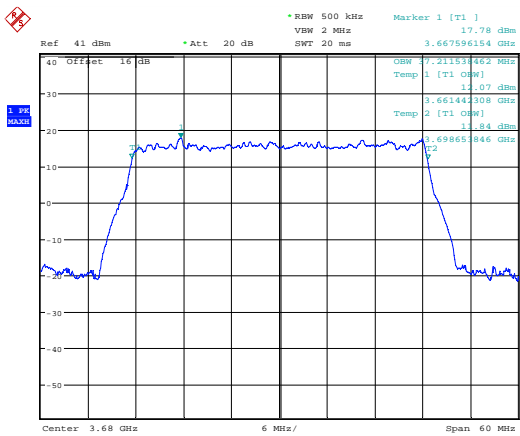

Date: 7.JUL.2018 20:24:51

99 % Bandwidth; 16QAM; 3680 MHz; MIMO A.

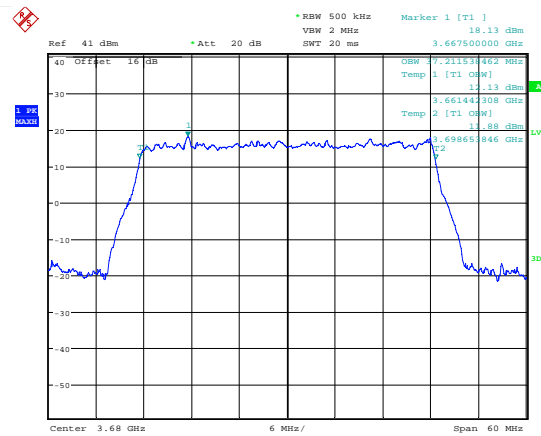

Date: 7.JUL.2018 20:26:44

99 % Bandwidth; 16QAM; 3680 MHz; MIMO B.

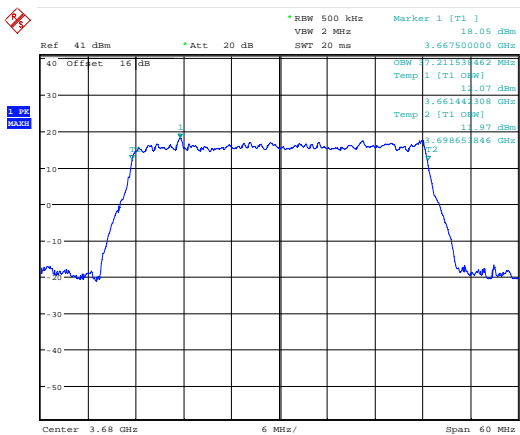

Date: 7.JUL.2018 20:25:19

99 % Bandwidth; 64QAM; 3680 MHz; MIMO A.

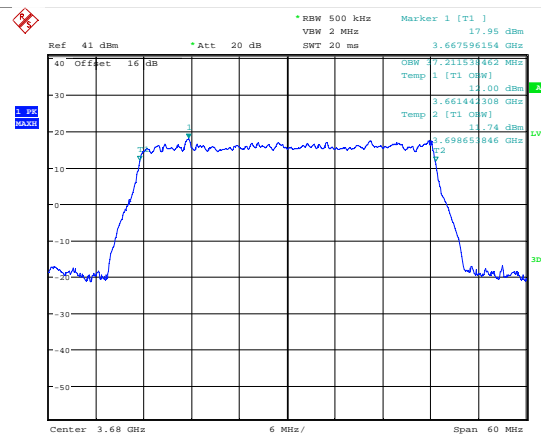

Date: 7.JUL.2018 20:27:14

99 % Bandwidth; 64QAM; 3680 MHz; MIMO B.

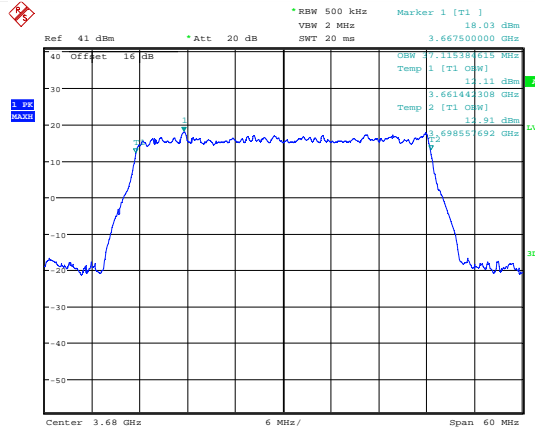
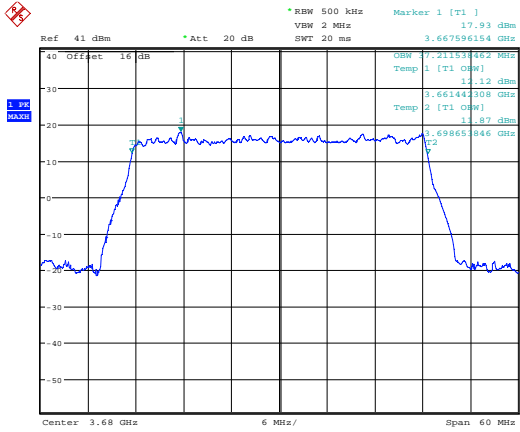

Date: 7.JUL.2018 20:25:55

Date: 7.JUL.2018 20:27:47

99 % Bandwidth; 256QAM; 3680 MHz; MIMO A.

99 % Bandwidth; 256QAM; 3680 MHz; MIMO B.

Top Channel 40 MHz bandwidth						
Frequency (MHz)	Modulation Mode	MIMO	FL (MHz)	FH (MHz)	99 % Bandwidth (kHz)	Result
3680	QPSK	A	3661.442	3698.654	37212	Pass
3680	QPSK	B	3661.442	3698.654	37212	Pass
3680	16QAM	A	3661.442	3698.654	37212	Pass
3680	16QAM	B	3661.442	3698.654	37212	Pass
3680	64QAM	A	3661.442	3698.654	37212	Pass
3680	64QAM	B	3661.442	3698.654	37212	Pass
3680	256QAM	A	3661.442	3698.654	37212	Pass
3680	256QAM	B	3661.442	3698.557	37115	Pass

13 Emission Mask

13.1 Definition

Out-of-band emission.

Emission on a frequency or frequencies immediately outside the necessary bandwidth that results from the modulation process but excluding spurious emissions.

Spurious emission.

Emission on a frequency or frequencies that are outside the necessary bandwidth and the level of which may be reduced without affecting the corresponding transmission of information. Spurious emissions include harmonic emissions, parasitic emissions, intermodulation products, and frequency conversion products, but exclude out-of-band emissions.

13.2 Test Parameters

Test Location:	Element Skelmersdale
Test Chamber:	Radio Chamber
Test Standard and Clause:	Part 90.210
EUT Channels:	Low / Mid / High
EUT Channel Bandwidths:	5 MHz, 20 MHz and 40 MHz
Deviations From Standard:	None
Measurement BW:	100 kHz
Spectrum Analyzer Video BW: (requirement at least 3x RBW)	1 MHz
Measurement Detector:	RMS

Environmental Conditions (Normal Environment)

Temperature: 24 °C	+15 °C to +35 °C (as declared)
Humidity: 60 % RH	20 % RH to 75 % RH (as declared)
Supply: 48 V dc	48 V dc (as declared)

13.3 Test Limit

Emission Mask B. For transmitters that are equipped with an audio low-pass filter, the power of any emission must be attenuated below the unmodulated carrier power (P) as follows:

(1) On any frequency removed from the assigned frequency by more than 50 percent, but not more than 100 percent of the authorized bandwidth: At least 25 dB.

(2) On any frequency removed from the assigned frequency by more than 100 percent, but not more than 250 percent of the authorized bandwidth: At least 35 dB.

(3) On any frequency removed from the assigned frequency by more than 250 percent of the authorized bandwidth: At least $43 + 10 \log (P)$ dB.

13.4 Test Method

With the EUT setup as per section 9 of this report and connected as per Figure v, the emissions from the EUT were measured on a spectrum analyser.

The measurements were performed with EUT set at its maximum duty. All modulation schemes, data rates and power settings were used to observe the worst case configuration in each bandwidth.

Figure v Test Setup

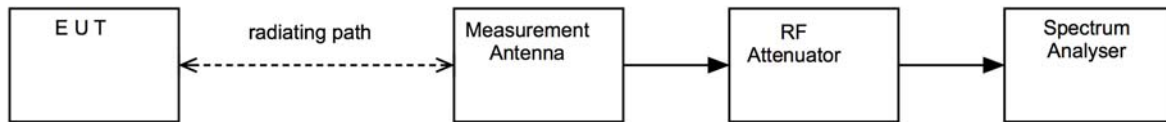

13.5 Test Equipment

Equipment Type	Manufacturer	Equipment Description	Element No	Due For Calibration
3115	EMCO	1-18GHz Horn	L139	2019-09-25
FSU50	R&S	Spectrum Analyser	U544	2019-05-22

13.6 Test Results

GUI Power settings 5 MHz Bandwidth			
Transmission Mode	Bottom Channel	Middle Channel	Top Channel
Beamforming	34.5	34.5	34.5
Sector	33	33	33
MU-MIMO	33	33	33

Beamforming 5 MHz Emission Mask

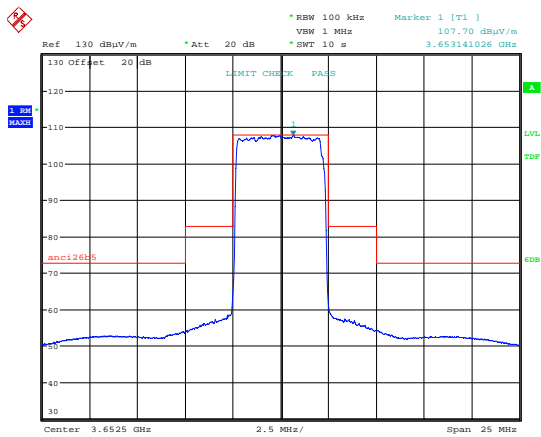

Date: 8.JUL.2018 21:11:05

Emission Mask; QPSK; 3652.5 MHz; MIMO A.

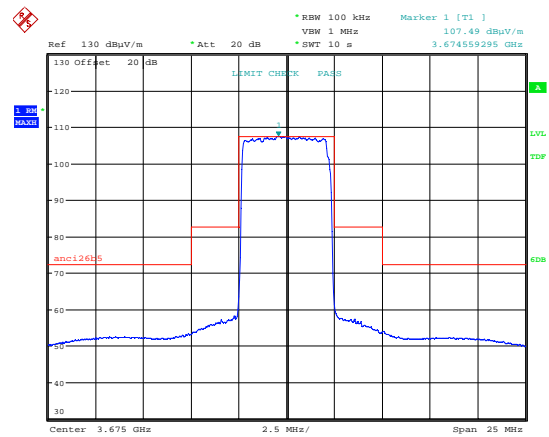

Date: 8.JUL.2018 21:03:13

Emission Mask; QPSK; 3675 MHz; MIMO A.

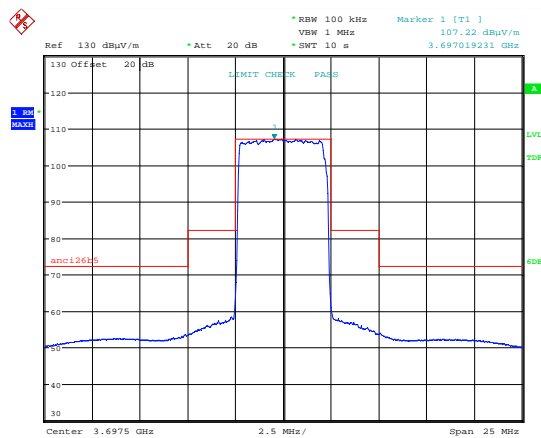

Date: 8.JUL.2018 21:12:22

Emission Mask; QPSK; 3697.5 MHz; MIMO A.

Sector 5 MHz Emission Mask

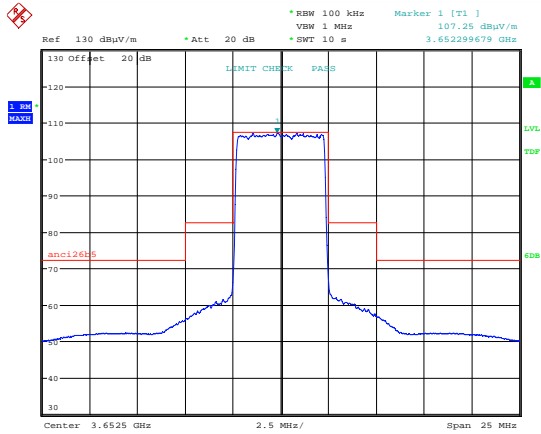

Date: 8.JUL.2018 20:54:36

Emission Mask; QPSK; 3652.5 MHz; MIMO A.

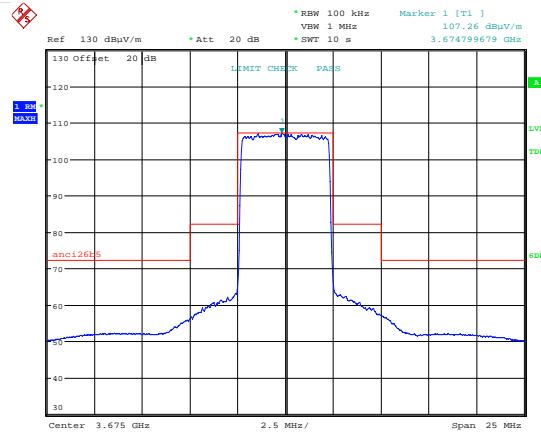

Date: 8.JUL.2018 22:33:08

Emission Mask; QPSK; 3675 MHz; MIMO A.

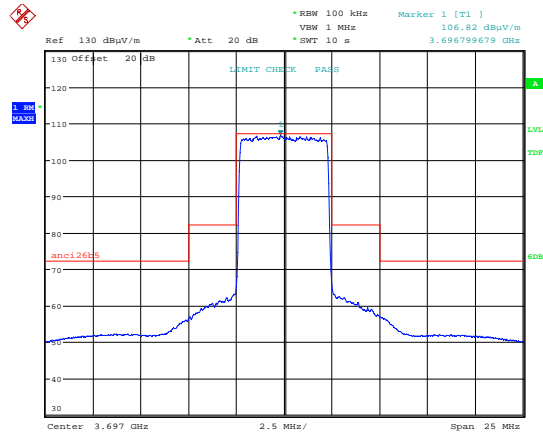

Date: 8.JUL.2018 22:34:06

Emission Mask; QPSK; 3697.5 MHz; MIMO A.

MU-MIMO 5 MHz Emission Mask

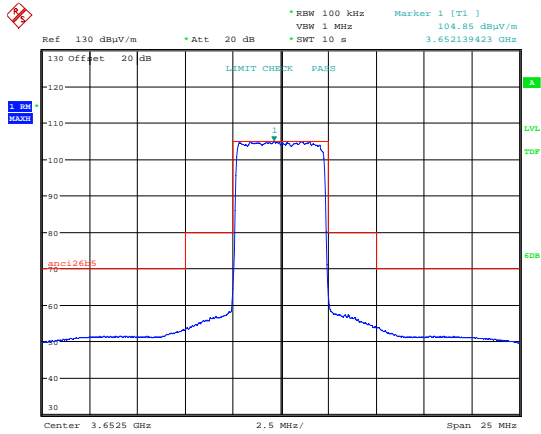

Date: 8.JUL.2018 21:26:09

Emission Mask; QPSK; 3652.5 MHz; MIMO A.

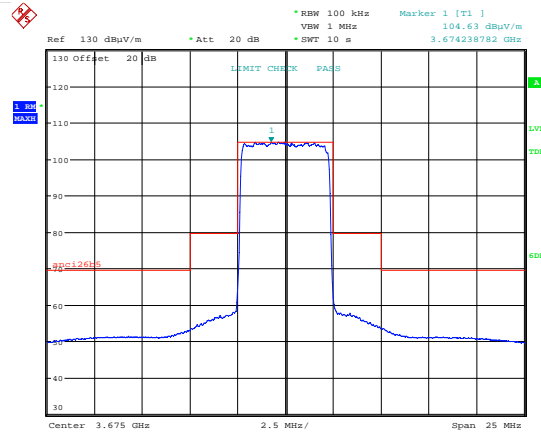

Date: 8.JUL.2018 21:22:22

Emission Mask; QPSK; 3675 MHz; MIMO A.

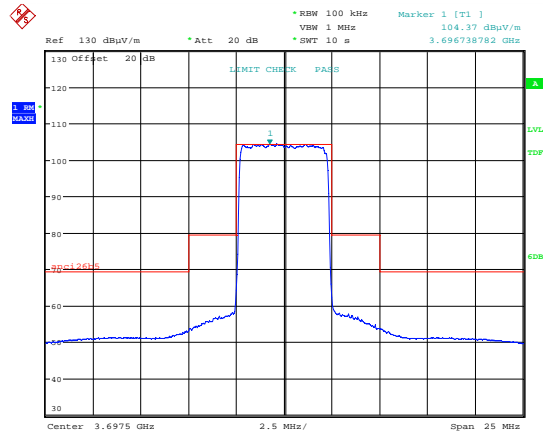

Date: 8.JUL.2018 21:20:41

Emission Mask; QPSK; 3697.5 MHz; MIMO A.

GUI Power settings 20 MHz Bandwidth			
Transmission Mode	Bottom Channel	Middle Channel	Top Channel
Beamforming	38.5	38.5	38.5
Sector	38.5	38.5	38.5
MU-MIMO	38.5	38.5	38.5

Beamforming 20 MHz Emission Mask

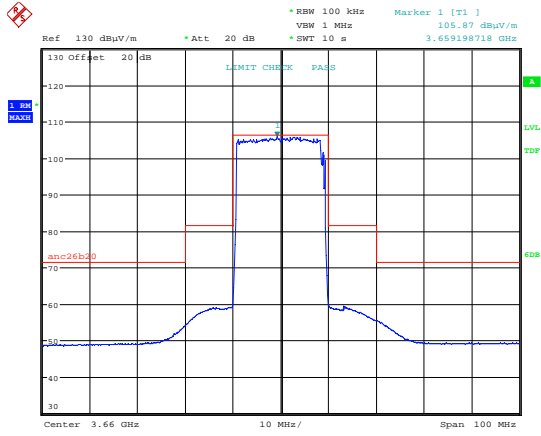

Date: 8.JUL.2018 20:24:50

Emission Mask; QPSK; 3660 MHz; MIMO A.

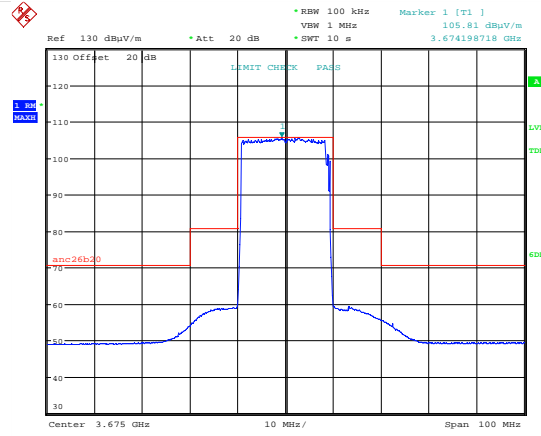

Date: 8.JUL.2018 20:18:24

Emission Mask; QPSK; 3675 MHz; MIMO A.

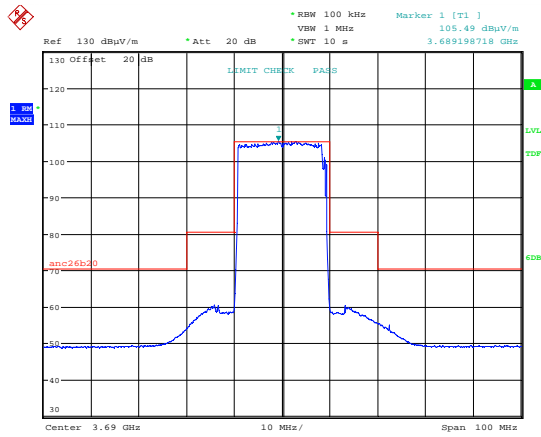

Date: 8.JUL.2018 22:27:01

Emission Mask; QPSK; 3690 MHz; MIMO A.

Sector 20 MHz Emission Mask

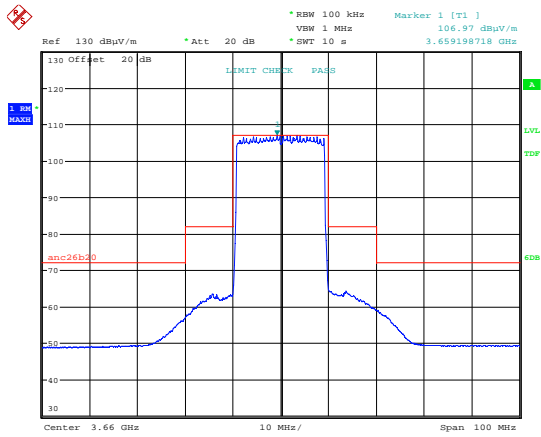

Date: 8.JUL.2018 20:06:05

Emission Mask; QPSK; 3660 MHz; MIMO A.

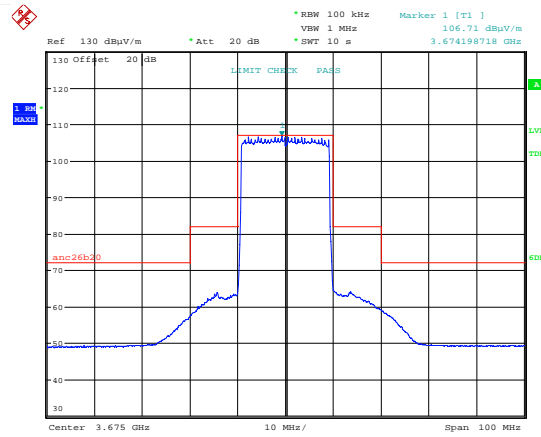

Date: 8.JUL.2018 20:08:37

Emission Mask; QPSK; 3675 MHz; MIMO A.

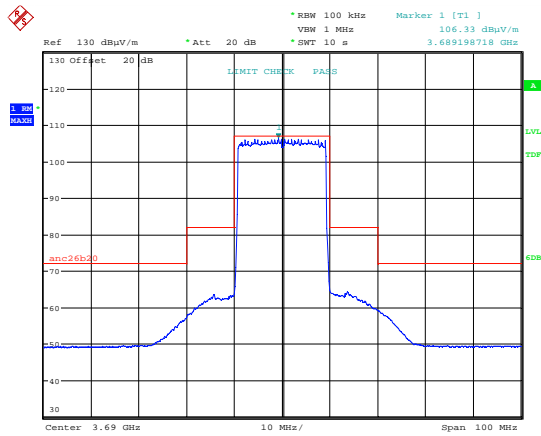

Date: 8.JUL.2018 20:09:59

Emission Mask; QPSK; 3690 MHz; MIMO A.

MU-MIMO 20 MHz Emission Mask

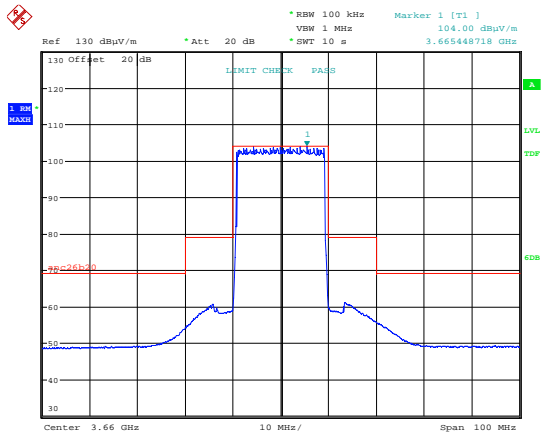

Date: 8.JUL.2018 22:17:46

Emission Mask; QPSK; 3660 MHz; MIMO A.

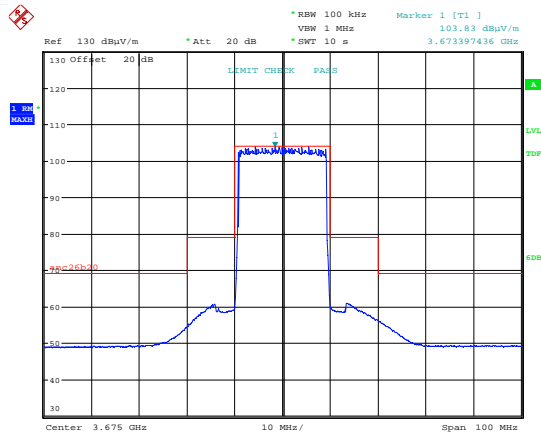

Date: 8.JUL.2018 22:20:04

Emission Mask; QPSK; 3675 MHz; MIMO A.

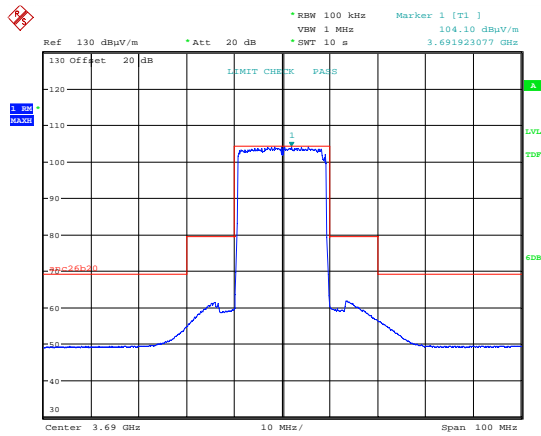

Date: 8.JUL.2018 20:39:39

Emission Mask; QPSK; 3690 MHz; MIMO A.

GUI Power settings 40 MHz Bandwidth			
Transmission Mode	Bottom Channel	Middle Channel	Top Channel
Beamforming	46	45	45
Sector	43.6	41.5	40.5
MU-MIMO	42	42	41.5

Beamforming 40 MHz Emission Mask

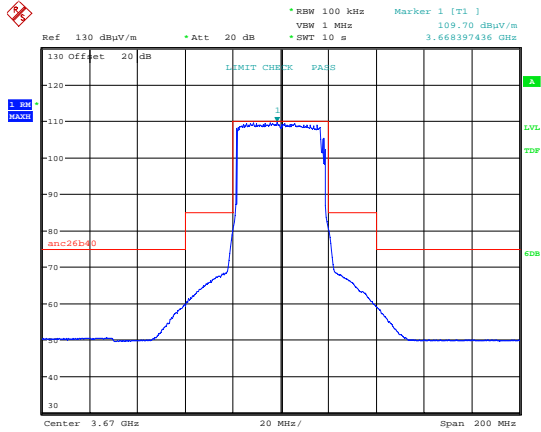

Date: 8.JUL.2018 21:48:32

Emission Mask; QPSK; 3670 MHz; MIMO A.

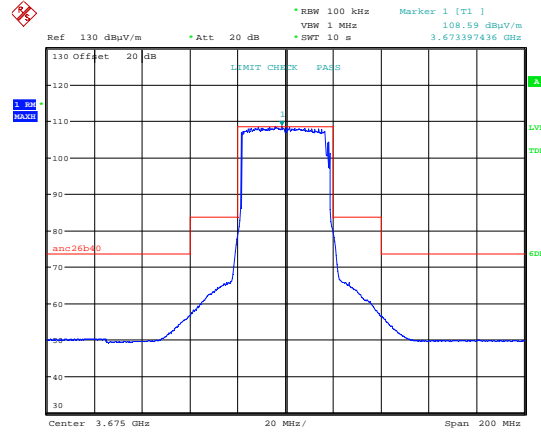

Date: 8.JUL.2018 21:46:01

Emission Mask; QPSK; 3675 MHz; MIMO A.

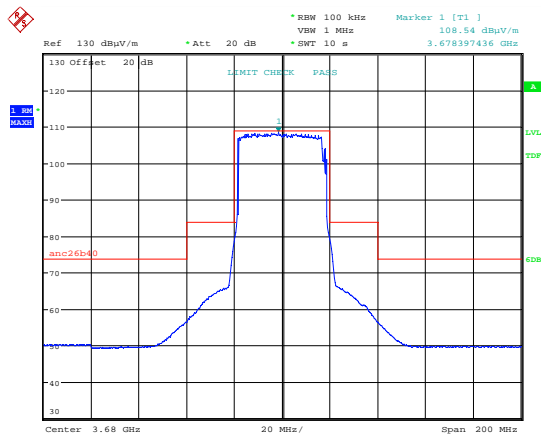

Date: 8.JUL.2018 21:44:30

Emission Mask; QPSK; 3680 MHz; MIMO A.

Sector 40 MHz Emission Mask

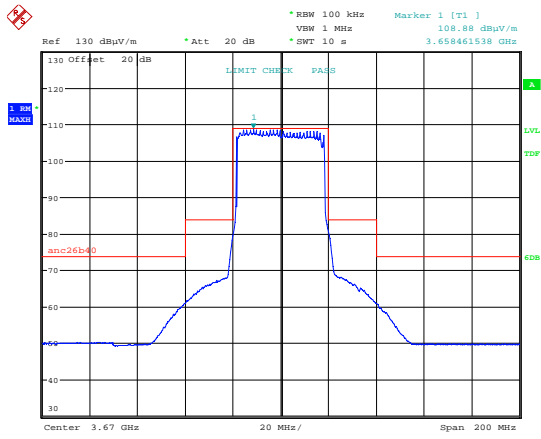

Date: 8.JUL.2018 21:33:58

Emission Mask; QPSK; 3670 MHz; MIMO A.

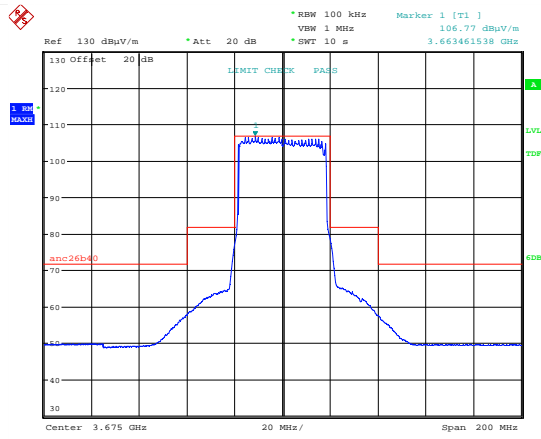

Date: 8.JUL.2018 21:36:20

Emission Mask; QPSK; 3675 MHz; MIMO A.

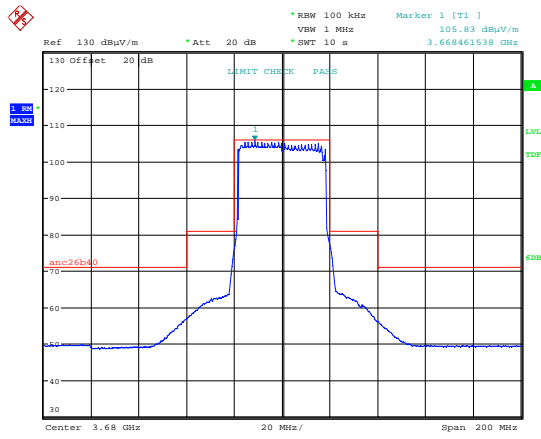

Date: 8.JUL.2018 21:38:53

Emission Mask; QPSK; 3680 MHz; MIMO A.

MU-MIMO 40 MHz Emission Mask

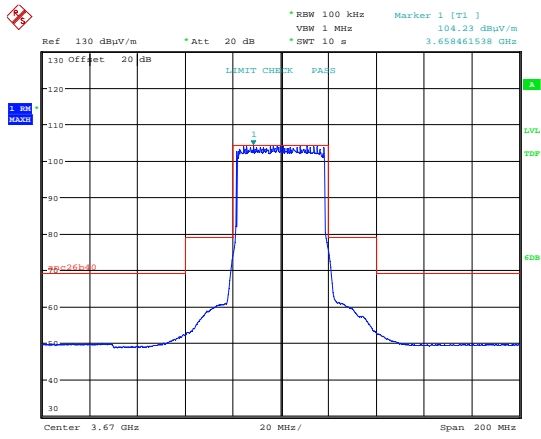

Date: 8.JUL.2018 21:53:33

Emission Mask; QPSK; 3670 MHz; MIMO A.

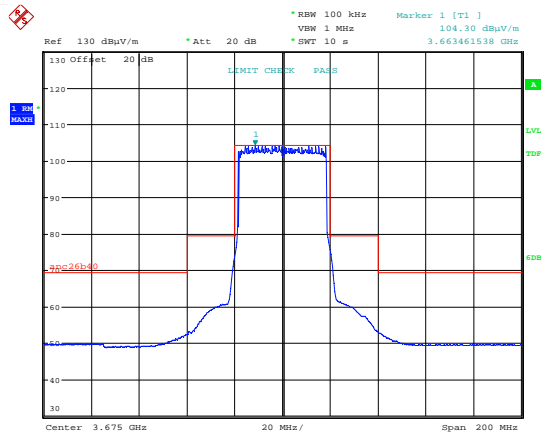

Date: 8.JUL.2018 21:59:20

Emission Mask; QPSK; 3675 MHz; MIMO A.

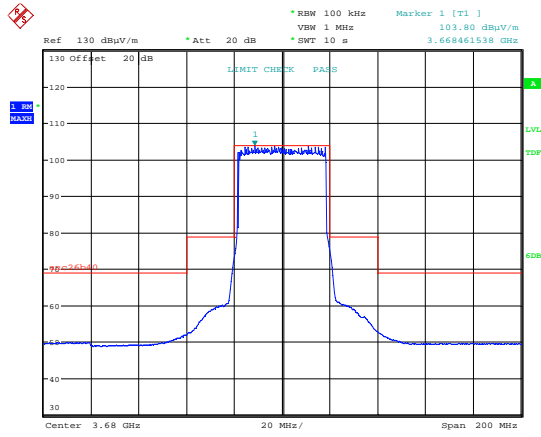

Date: 8.JUL.2018 21:56:32

Emission Mask; QPSK; 3680 MHz; MIMO A.

14 Frequency stability

14.1 Definition

Frequency stability is a measure of frequency drift due to temperature and supply voltage variations, with reference to the frequency measured at an appropriate reference temperature and the rated supply voltage.

14.2 Test Parameters

Test Location:	Element Skelmersdale
Test Chamber:	Blocking Laboratory
Test Standard and Clause:	90.213
Channels / Frequencies Measured:	3652.5 MHz, 3675 MHz and 3697.5 MHz
Resolution Bandwidth: (Requirement 1 % of the Occupied Channel Bandwidth):	50 kHz; 200 kHz and 400 kHz
Modulation:	Off
Deviations From Standard:	None
Temperature Extreme Environment Test Range:	-30 to +50 C
Voltage Extreme Environment Test Range:	Power = $\pm 15\%$ of Nominal;

Environmental Conditions (Normal Environment)

Temperature: 24 °C	Standard Requirement: +20 °C
Humidity: 60 %RH	20 % RH to 75 % RH (as declared)

14.3 Test Limit

The applicant shall ensure frequency stability by showing that f_L minus the frequency offset and f_H plus the frequency offset shall be within the 3650-3700 MHz band.

14.4 Test Method

With the EUT setup as per section 9 of this report and connected as per Figure v, the frequency was measured under varying conditions of temperature and supply voltage.

The measurements were performed with EUT set in a CW mode of operation.

Figure v Test Setup

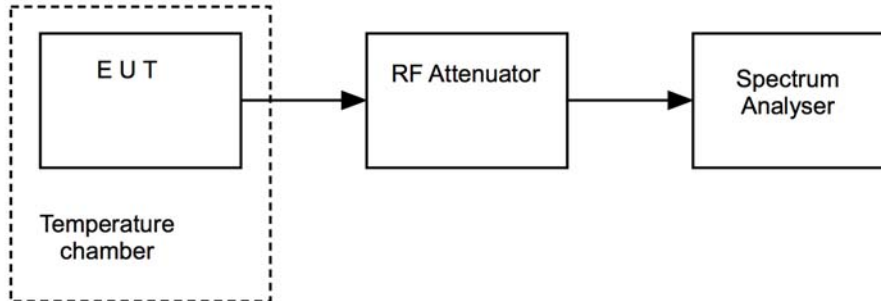

14.5 Test Equipment

Equipment Type	Manufacturer	Equipment Description	Element No	Due For Calibration
FSU50	R&S	Spectrum Analyser	U544	2019-05-22
34405a	Agilent	Multimeter	REF976	2019-01-17
52 Series II	Fluke	Temperature Indicator	L426	2019-06-18

14.6 Test Results

EUT Frequency: 3652.5 MHz					
Test Environment		Measured Frequency (MHz)	Frequency error (kHz)	Drift (ppm)	Result
-30 C	V _{nominal}	3652.151923	7.21	1.97	PASS
-20 C	V _{nominal}	3652.150160	5.45	1.49	PASS
-10 C	V _{nominal}	3652.150000	5.29	1.45	PASS
0 C	V _{nominal}	3652.151603	6.89	1.89	PASS
+10 C	V _{nominal}	3652.148397	3.69	1.01	PASS
+20 C	V _{minimum}	3652.144872	0.16	0.04	PASS
	V _{nominal}	3652.144710	N/A	N/A	N/A
	V _{maximum}	3652.144872	0.16	0.04	PASS
+30 C	V _{nominal}	3652.145673	0.96	0.26	PASS
+40 C	V _{nominal}	3652.145032	0.32	0.09	PASS
+50 C	V _{nominal}	3652.143750	-0.96	-0.26	PASS

EUT Frequency: 3675 MHz					
Test Environment		Measured Frequency (MHz)	Frequency error (kHz)	Drift (ppm)	Result
-30 C	V _{nominal}	3674.652083	7.21	1.96	PASS
-20 C	V _{nominal}	3674.650321	5.45	1.48	PASS
-10 C	V _{nominal}	3674.64984	4.97	1.35	PASS
0 C	V _{nominal}	3674.651923	7.05	1.92	PASS
+10 C	V _{nominal}	3674.648397	3.53	0.96	PASS
+20 C	V _{minimum}	3674.644551	-0.32	-0.09	PASS
	V _{nominal}	3674.644870	N/A	N/A	N/A
	V _{maximum}	3674.644551	-0.32	-0.09	PASS
+30 C	V _{nominal}	3674.646314	1.44	0.39	PASS
+40 C	V _{nominal}	3674.644551	-0.32	-0.09	PASS
+50 C	V _{nominal}	3674.644231	-0.64	-0.17	PASS

EUT Frequency: 3697.5					
Test Environment		Measured Frequency (MHz)	Frequency error (kHz)	Drift (ppm)	Result
-30 C	V _{nominal}	3697.151923	7.21	1.95	PASS
-20 C	V _{nominal}	3697.150321	5.61	1.52	PASS
-10 C	V _{nominal}	3697.149679	4.97	1.34	PASS
0 C	V _{nominal}	3697.153365	8.65	2.34	PASS
+10 C	V _{nominal}	3697.148077	3.37	0.91	PASS
+20 C	V _{minimum}	3697.144712	0.00	0.00	PASS
	V _{nominal}	3697.144712	N/A	N/A	N/A
	V _{maximum}	3697.145032	0.32	0.09	PASS
+30 C	V _{nominal}	3697.147436	2.72	0.74	PASS
+40 C	V _{nominal}	3697.144551	-0.16	-0.04	PASS
+50 C	V _{nominal}	3697.144551	-0.16	-0.04	PASS

In band checking			
F _L total 5 MHz	3650.156	3699.843	F _H total 5 MHz
F _L total 20 MHz	3650.673	3699.134	F _H total 20 MHz
F _L total 40 MHz	3651.25	3698.654	F _H total 40 MHz
F _L total all bandwidths (MHz)	3650.156	3699.843	F _H total all bandwidths (MHz)
F Low including drift (MHz)	3650.16	3699.851653	F High including drift (MHz)
Verdict	PASS	PASS	Verdict

15 Peak EIRP Density and Equivalent Isotropically Radiated Power (EIRP)

15.1 Definition

The power per unit bandwidth.

15.2 Test Parameters

Test Location:	Pershore Airfield
Test Chamber:	Air field
Test Standard and Clause:	Part 90.1321
EUT Channels / Frequencies Measured:	Low / Mid / High
EUT Channel Bandwidths:	5 MHz, 20 MHz and 40 MHz
Deviations From Standard:	None
Measurement BW:	1 MHz
Spectrum Analyzer Video BW: (requirement at least 3x RBW)	3 MHz
Measurement Detector:	Peak

Environmental Conditions (Normal Environment)

Temperature: 20 °C	+15 °C to +35 °C (as declared)
Humidity: 50 % RH	20 % RH to 75 % RH (as declared)
Supply: 48 V dc	48 V dc (as declared)

15.3 Test Limit

Base and fixed stations are limited to 25 watts/25 MHz equivalent isotropically radiated power (EIRP). In any event, the peak EIRP power density shall not exceed 1 Watt in any one-megahertz slice of spectrum.

15.4 Test Method

With the EUT setup as per section 9 of this report and connected as per Figure vi, the peak emission of the EUT was measured on a spectrum analyser, with path losses taken into account.

The measurements were performed with EUT set at its maximum duty. All modulation schemes, data rates and power settings were used to observe the worst case configuration in each bandwidth.

Figure vi Test Setup

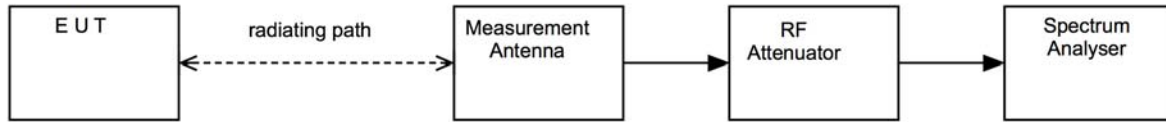

15.5 Test Equipment

Equipment Type	Manufacturer	Equipment Description	Element No	Due For Calibration
3115	EMCO	1-18GHz Horn	U223	2019-10-25
FSU50	R&S	Spectrum Analyser	U544	2019-05-22
3161	EMCO	2- 4 GHz Horn	9910-1058	2019-02-18

15.6 Test Results – Peak EIRP Density

Bottom channel; Bandwidth: 5 MHz;						
Channel Frequency (MHz)	Transition Mode	Modulation	MIMO	Peak EIRP Density (W/MHz)	Limit (W/MHz)	Result
3652.5	Sector	QPSK	A	1	1	PASS
3652.5	MU-MIMO		A	1	1	PASS
3652.5	Beamforming		A	0.9	1	PASS

Middle channel; Bandwidth: 5 MHz						
Channel Frequency (MHz)	Transition Mode	Modulation	MIMO	Peak EIRP Density (W/MHz)	Limit (W/MHz)	Result
3675	Sector	QPSK	A	0.8	1	PASS
3675			B	0.9	1	PASS
3675	MU-MIMO		A	1	1	PASS
3675	Beamforming		A	0.9	1	PASS
3675	Sector	16QAM	A	0.8	1	PASS
3675			B	0.8	1	PASS
3675	MU-MIMO		A	1	1	PASS
3675	Beamforming		A	0.9	1	PASS
3675	Sector	64QAM	A	0.8	1	PASS
3675			B	0.8	1	PASS
3675	MU-MIMO		A	1	1	PASS
3675	Beamforming		A	0.9	1	PASS
3675	Sector	256QAM	A	0.8	1	PASS
3675			B	0.8	1	PASS
3675	MU-MIMO		A	1	1	PASS
3675	Beamforming		A	0.9	1	PASS

Top channel; Bandwidth: 5 MHz						
Channel Frequency (MHz)	Transition Mode	Modulation	MIMO	Peak EIRP Density (W/MHz)	Limit (W/MHz)	Result
3697.5	Sector	QPSK	A	1	1	PASS
3697.5	MU-MIMO		A	0.9	1	PASS
3697.5	Beamforming		A	1	1	PASS

Bottom channel; Bandwidth: 20 MHz						
Channel Frequency (MHz)	Transition Mode	Modulation	MIMO	Peak EIRP Density (W/MHz)	Limit (W/MHz)	Result
3660	Sector	QPSK	A	1	1	PASS
3660	MU-MIMO		A	0.9	1	PASS
3660	Beamforming		A	0.9	1	PASS

Middle channel; Bandwidth: 20 MHz						
Channel Frequency (MHz)	Transition Mode	Modulation	MIMO	Peak EIRP Density (W/MHz)	Limit (W/MHz)	Result
3675	Sector	QPSK	A	1	1	PASS
3675			B	1	1	PASS
3675	MU-MIMO		A	1	1	PASS
3675	Beamforming		A	0.9	1	PASS
3675	Sector	16QAM	A	1	1	PASS
3675			B	1	1	PASS
3675	MU-MIMO		A	1	1	PASS
3675	Beamforming		A	0.9	1	PASS
3675	Sector	64QAM	A	1	1	PASS
3675			B	1	1	PASS
3675	MU-MIMO		A	0.9	1	PASS
3675	Beamforming		A	0.9	1	PASS
3675	Sector	256QAM	A	1	1	PASS
3675			B	1	1	PASS
3675	MU-MIMO		A	1	1	PASS
3675	Beamforming		A	0.9	1	PASS

Top channel; Bandwidth: 20 MHz						
Channel Frequency (MHz)	Transition Mode	Modulation	MIMO	Peak EIRP Density (W/MHz)	Limit (W/MHz)	Result
3690	Sector	QPSK	A	1	1	PASS
3690	MU-MIMO		A	1	1	PASS
3690	Beamforming		A	0.9	1	PASS

Bottom channel; Bandwidth: 40 MHz						
Channel Frequency (MHz)	Transition Mode	Modulation	MIMO	Peak EIRP Density (W/MHz)	Limit (W/MHz)	Result
3670	Sector	QPSK	A	1	1	PASS
3670	MU-MIMO		A	0.9	1	PASS
3670	Beamforming		A	1	1	PASS

Middle channel; Bandwidth: 40 MHz						
Channel Frequency (MHz)	Transition Mode	Modulation	MIMO	Peak EIRP Density (W/MHz)	Limit (W/MHz)	Result
3675	Sector	QPSK	A	1	1	PASS
3675			B	0.9	1	PASS
3675	MU-MIMO		A	0.9	1	PASS
3675	Beamforming		A	1	1	PASS
3675	Sector	16QAM	A	1	1	PASS
3675			B	1	1	PASS
3675	MU-MIMO		A	1	1	PASS
3675	Beamforming		A	1	1	PASS
3675	Sector	64QAM	A	1	1	PASS
3675			B	0.9	1	PASS
3675	MU-MIMO		A	0.9	1	PASS
3675	Beamforming		A	1	1	PASS
3675	Sector	256QAM	A	1	1	PASS
3675			B	0.9	1	PASS
3675	MU-MIMO		A	0.9	1	PASS
3675	Beamforming		A	1	1	PASS

Top channel; Bandwidth: 40 MHz						
Channel Frequency (MHz)	Transition Mode	Modulation	MIMO	Peak EIRP Density (W/MHz)	Limit (W/MHz)	Result
3680	Sector	QPSK	A	0.9	1	PASS
3680	MU-MIMO		A	1	1	PASS
3680	Beamforming		A	0.8	1	PASS

15.7 Test Results – Equivalent Isotropic Radiated Power (EIRP)

Bottom channel; Bandwidth: 5 MHz								
Channel Frequency (MHz)	Transition Mode	Modulation	MIMO	Peak EIRP Density (W/MHz)	1 MHz to 5 MHz Correction (dB)	EIRP (W/25MHz)	Limit (W/25MHz)	Result
3652.5	Sector	QPSK	A	1	7.0	5.0	25	PASS
3652.5	MU-MIMO		A	1	7.0	5.0	25	PASS
3652.5	Beamforming		A	0.9	7.0	4.5	25	PASS

Middle channel; Bandwidth: 5 MHz								
Channel Frequency (MHz)	Transition Mode	Modulation	MIMO	Peak EIRP Density (W/MHz)	1 MHz to 5 MHz Correction (dB)	EIRP (W/25MHz)	Limit (W/25MHz)	Result
3675	Sector	QPSK	A	0.8	7.0	4.0	25	PASS
3675			B	0.9	7.0	4.5	25	PASS
3675	MU-MIMO		A	1	7.0	5.0	25	PASS
3675	Beamforming		A	0.9	7.0	4.5	25	PASS
3675	Sector	16QAM	A	0.8	7.0	4.0	25	PASS
3675			B	0.8	7.0	4.0	25	PASS
3675	MU-MIMO		A	1	7.0	5.0	25	PASS
3675	Beamforming		A	0.9	7.0	4.5	25	PASS
3675	Sector	64QAM	A	0.8	7.0	4.0	25	PASS
3675			B	0.8	7.0	4.0	25	PASS
3675	MU-MIMO		A	1	7.0	5.0	25	PASS
3675	Beamforming		A	0.9	7.0	4.5	25	PASS
3675	Sector	256QAM	A	0.8	7.0	4.0	25	PASS
3675			B	0.8	7.0	4.0	25	PASS
3675	MU-MIMO		A	1	7.0	5.0	25	PASS
3675	Beamforming		A	0.9	7.0	4.5	25	PASS

Bottom channel; Bandwidth: 5 MHz								
Channel Frequency (MHz)	Transition Mode	Modulation	MIMO	Peak EIRP Density (W/MHz)	1 MHz to 5 MHz Correction (dB)	EIRP (W/25MHz)	Limit (W/25MHz)	Result
3697.5	Sector	QPSK	A	1	7.0	5.0	25	PASS
3697.5	MU-MIMO		A	0.9	7.0	4.5	25	PASS
3697.5	Beamforming		A	1	7.0	5.0	25	PASS

Bottom channel; Bandwidth: 20 MHz								
Channel Frequency (MHz)	Transition Mode	Modulation	MIMO	Peak EIRP Density (W/MHz)	1 MHz to 20 MHz Correction (dB)	EIRP (W/25MHz)	Limit (W/25MHz)	Result
3660	Sector	QPSK	A	1	13.0	20.0	25	PASS
3660	MU-MIMO		A	0.9	13.0	18.0	25	PASS
3660	Beamforming		A	0.9	13.0	18.0	25	PASS

Middle channel; Bandwidth: 20 MHz								
Channel Frequency (MHz)	Transition Mode	Modulation	MIMO	Peak EIRP Density (W/MHz)	1 MHz to 20 MHz Correction (dB)	EIRP (W/25MHz)	Limit (W/25MHz)	Result
3675	Sector	QPSK	A	1	13.0	20.0	25	PASS
3675			B	1	13.0	20.0	25	PASS
3675	MU-MIMO		A	1	13.0	20.0	25	PASS
3675	Beamforming		A	0.9	13.0	18.0	25	PASS
3675	Sector	16QAM	A	1	13.0	20.0	25	PASS
3675			B	1	13.0	20.0	25	PASS
3675	MU-MIMO		A	1	13.0	20.0	25	PASS
3675	Beamforming		A	0.9	13.0	18.0	25	PASS
3675	Sector	64QAM	A	1	13.0	20.0	25	PASS
3675			B	1	13.0	20.0	25	PASS
3675	MU-MIMO		A	0.9	13.0	18.0	25	PASS
3675	Beamforming		A	0.9	13.0	18.0	25	PASS
3675	Sector	256QAM	A	1	13.0	20.0	25	PASS
3675			B	1	13.0	20.0	25	PASS
3675	MU-MIMO		A	1	13.0	20.0	25	PASS
3675	Beamforming		A	0.9	13.0	18.0	25	PASS

Top channel; Bandwidth: 20 MHz								
Channel Frequency (MHz)	Transition Mode	Modulation	MIMO	Peak EIRP Density (W/MHz)	1 MHz to 20 MHz Correction (dB)	EIRP (W/25MHz)	Limit (W/25MHz)	Result
3690	Sector	QPSK	A	1	13.0	20.0	25	PASS
3690	MU-MIMO		A	1	13.0	20.0	25	PASS
3690	Beamforming		A	0.9	13.0	18.0	25	PASS

Bottom channel; Bandwidth: 40 MHz								
Channel Frequency (MHz)	Transition Mode	Modulation	MIMO	Peak EIRP Density (W/MHz)	1 MHz to 25 MHz Correction (dB)	EIRP (W/25MHz)	Limit (W/25MHz)	Result
3670	Sector	QPSK	A	1	14.0	25	25	PASS
3670	MU-MIMO		A	0.9	14.0	22.5	25	PASS
3670	Beamforming		A	1	14.0	25	25	PASS

Middle channel; Bandwidth: 40 MHz								
Channel Frequency (MHz)	Transition Mode	Modulation	MIMO	Peak EIRP Density (W/MHz)	1 MHz to 25 MHz Correction (dB)	EIRP (W/25MHz)	Limit (W/25MHz)	Result
3675	Sector	QPSK	A	1	14.0	25	25	PASS
3675			B	0.9	14.0	22.5	25	PASS
3675	MU-MIMO		A	0.9	14.0	22.5	25	PASS
3675	Beamforming		A	1	14.0	25	25	PASS
3675	Sector	16QAM	A	1	14.0	25	25	PASS
3675			B	1	14.0	25	25	PASS
3675	MU-MIMO		A	1	14.0	25	25	PASS
3675	Beamforming		A	1	14.0	25	25	PASS
3675	Sector	64QAM	A	1	14.0	25	25	PASS
3675			B	0.9	14.0	22.5	25	PASS
3675	MU-MIMO		A	0.9	14.0	22.5	25	PASS
3675	Beamforming		A	1	14.0	25	25	PASS
3675	Sector	256QAM	A	1	14.0	25	25	PASS
3675			B	0.9	14.0	22.5	25	PASS
3675	MU-MIMO		A	0.9	14.0	22.5	25	PASS
3675	Beamforming		A	1	14.0	25	25	PASS

Top channel; Bandwidth: 40 MHz								
Channel Frequency (MHz)	Transition Mode	Modulation	MIMO	Peak EIRP Density (W/MHz)	1 MHz to 25 MHz Correction (dB)	EIRP (W/25MHz)	Limit (W/25MHz)	Result
3680	Sector	QPSK	A	0.9	14.0	22.5	25	PASS
3680	MU-MIMO		A	1	14.0	25	25	PASS
3680	Beamforming		A	0.8	14.0	20	25	PASS

Bottom channel; Bandwidth: 40 MHz						
Channel Frequency (MHz)	Transition Mode	Modulation	MIMO	Peak EIRP Density (W/MHz)	1 MHz to 40 MHz Correction (dB)	EIRP (W/40MHz)
3670	Sector	QPSK	A	1	16.0	40
3670	MU-MIMO		A	0.9	16.0	36
3670	Beamforming		A	1	16.0	40

Middle channel; Bandwidth: 40 MHz						
Channel Frequency (MHz)	Transition Mode	Modulation	MIMO	Peak EIRP Density (W/MHz)	1 MHz to 40 MHz Correction (dB)	EIRP (W/40MHz)
3675	Sector	QPSK	A	1	16.0	40
3675			B	0.9	16.0	36
3675	MU-MIMO		A	0.9	16.0	36
3675	Beamforming		A	1	16.0	40
3675	Sector	16QAM	A	1	16.0	40
3675			B	1	16.0	40
3675	MU-MIMO		A	1	16.0	40
3675	Beamforming		A	1	16.0	40
3675	Sector	64QAM	A	1	16.0	40
3675			B	0.9	16.0	36
3675	MU-MIMO		A	0.9	16.0	36
3675	Beamforming		A	1	16.0	40
3675	Sector	256QAM	A	1	16.0	40
3675			B	0.9	16.0	36
3675	MU-MIMO		A	0.9	16.0	36
3675	Beamforming		A	1	16.0	40

Top channel; Bandwidth: 40 MHz						
Channel Frequency (MHz)	Transition Mode	Modulation	MIMO	Peak EIRP Density (W/MHz)	1 MHz to 40 MHz Correction (dB)	EIRP (W/40MHz)
3680	Sector	QPSK	A	0.9	16.0	36
3680	MU-MIMO		A	1	16.0	40
3680	Beamforming		A	0.8	16.0	32

16 Measurement Uncertainty

Calculated Measurement Uncertainties

All statements of uncertainty are expanded standard uncertainty using a coverage factor of 1.96 to give a 95 % confidence:

[1] Radiated spurious emissions

Uncertainty in test result (30 MHz to 1 GHz) = **4.75 dB**

Uncertainty in test result (1 GHz to 18 GHz) = **4.46 dB**

[2] AC power line conducted emissions

Uncertainty in test result = **3.2 dB**

[3] Occupied bandwidth

Uncertainty in test result = **15.58 %**

[4] Conducted carrier power

Uncertainty in test result (Power Meter) = **0.93 dB**

[5] Conducted RF power out-of-band

Uncertainty in test result – up to 8.1 GHz = **3.31 dB**

Uncertainty in test result – 8.1 GHz to 15.3 GHz = **4.43 dB**

[6] Radiated RF power out-of-band

Uncertainty in test result (30 MHz to 1 GHz) = **4.75 dB**

Uncertainty in test result (1 GHz to 18 GHz) = **4.46 dB**

[7] Power spectral density

Uncertainty in test result (Spectrum Analyser) = **3.11 dB**

[8] ERP / EIRP

Uncertainty in test result (Laboratory) = **4.71 dB**

Uncertainty in test result (Pershore OATS) = **4.26 dB**