



# MEASUREMENT REPORT

## FCC PART 15.247 WLAN 802.11b/g/n

---

**FCC ID:** QWOWFM210

**APPLICANT:** Rayson Technology Co., Ltd.

**Application Type:** Certification

**Product:** iCOM Smart WiFi Module

**Model No.:** WFM21X, WFM210, WFM211, WFM212, WFM213,  
WFM214, WFM215, WFM216, WFM217, WFM218,  
WFM219

**FCC Classification:** Digital Transmission System (DTS)

**FCC Rule Part(s):** Part 15.247

**Test Procedure(s):** ANSI C63.10-2009, KDB 558074 D01v03r02

**Test Date:** Nov. 15 ~ 20, 2014

Reviewed By : Robin Wu  
( Robin Wu )

Approved By : Marlin Chen  
( Marlin Chen )

The test results relate only to the samples tested.

This equipment has been shown to be capable of compliance with the applicable technical standards as indicated in the measurement report and was tested in accordance with the measurement procedures specified in KDB 558074 D01v03r02. Test results reported herein relate only to the item(s) tested.

The test report shall not be reproduced except in full without the written approval of MRT Technology (Suzhou) Co., Ltd.

## Revision History

Report No.	Version	Description	Issue Date
1411RSU01501	Rev. 01	Initial report	11-21-2014
1411RSU01501	Rev. 02	Add some test descriptions and recalculate some measured levels	11-27-2014

## CONTENTS

Description	Page
<b>1. INTRODUCTION .....</b>	<b>6</b>
1.1. Scope .....	6
1.2. MRT Test Location .....	6
<b>2. PRODUCT INFORMATION .....</b>	<b>7</b>
2.1. Equipment Description.....	7
2.2. Device Capabilities .....	9
2.3. Test Configuration .....	9
2.4. EMI Suppression Device(s)/Modifications.....	9
2.5. Labeling Requirements.....	9
2.6. Test Software .....	9
2.7. Description of Support Units .....	10
<b>3. DESCRIPTION OF TEST .....</b>	<b>11</b>
3.1. Evaluation Procedure .....	11
3.2. AC Line Conducted Emissions .....	11
3.3. Radiated Emissions .....	12
<b>4. ANTENNA REQUIREMENTS.....</b>	<b>13</b>
<b>5. TEST EQUIPMENT CALIBRATION DATE.....</b>	<b>14</b>
<b>6. MEASUREMENT UNCERTAINTY.....</b>	<b>15</b>
<b>7. TEST RESULT .....</b>	<b>16</b>
7.1. Summary .....	16
7.2. 6dB Bandwidth Measurement.....	17
7.2.1. Test Limit .....	17
7.2.2. Test Procedure used.....	17
7.2.3. Test Setting.....	17
7.2.4. Test Setup.....	17
7.2.5. Test Result.....	18
7.3. Output Power Measurement.....	22
7.3.1. Test Limit .....	22
7.3.2. Test Procedure Used .....	22
7.3.3. Test Setting.....	22
7.3.4. Test Setup.....	22
7.3.5. Test Result of Output Power .....	23
7.4. Power Spectral Density Measurement.....	25

---

7.4.1.	Test Limit .....	25
7.4.2.	Test Procedure Used .....	25
7.4.3.	Test Setting.....	25
7.4.4.	Test Setup.....	25
7.4.5.	Test Result.....	26
7.5.	Conducted Band Edge and Out-of-Band Emissions.....	30
7.5.1.	Test Limit .....	30
7.5.2.	Test Procedure Used .....	30
7.5.3.	Test Setting.....	30
7.5.4.	Test Setup.....	31
7.5.5.	Test Result.....	32
7.6.	Radiated Spurious Emission Measurement .....	41
7.6.1.	Test Limit .....	41
7.6.2.	Test Procedure Used .....	41
7.6.3.	Test Setting.....	41
7.6.4.	Test Setup.....	43
7.6.5.	Test Result.....	45
7.7.	Radiated Restricted Band Edge Measurement .....	52
7.7.1.	Test Result.....	52
7.8.	AC Conducted Emissions Measurement.....	60
7.8.1.	Test Limit .....	60
7.8.2.	Test Setup.....	60
7.8.3.	Test Result.....	61
<b>8.</b>	<b>CONCLUSION.....</b>	<b>63</b>

## §2.1033 General Information

<b>Applicant:</b>	Rayson Technology Co., Ltd.
<b>Applicant Address:</b>	1F, No.9, R&D Road II, Science-Based Industrial Park, Hsin-Chu 300, Taiwan
<b>Manufacturer:</b>	Rayson (Shenzhen) Technology Co., Ltd.
<b>Manufacturer Address:</b>	No.1, Tongfu 1st Road, The 2nd Industrial Zone, Loucun, Gongming, Guangming New District, Shenzhen, China.
<b>Test Site:</b>	MRT Technology (Suzhou) Co., Ltd
<b>Test Site Address:</b>	D8 Building, No.2 Tian'edang Rd., Wuzhong Economic Development Zone, Suzhou, China
<b>MRT Registration No.:</b>	809388
<b>FCC Rule Part(s):</b>	Part 15.247
<b>Model No.:</b>	WFM21X, WFM210, WFM211, WFM212, WFM213, WFM214, WFM215, WFM216, WFM217, WFM218, WFM219
<b>FCC ID:</b>	QWOWFM210
<b>Test Device Serial No.:</b>	N/A <input type="checkbox"/> Production <input checked="" type="checkbox"/> Pre-Production <input type="checkbox"/> Engineering
<b>FCC Classification:</b>	Digital Transmission System (DTS)
<b>Date(s) of Test:</b>	Nov. 15~ 20, 2014
<b>Test Report S/N:</b>	1411RSU01501

### Test Facility / Accreditations

Measurements were performed at MRT Laboratory located in Tian'edang Rd., Suzhou, China.

- MRT facility is a FCC registered (MRT Reg. No. 809388) test facility with the site description report on file and has met all the requirements specified in Section 2.948 of the FCC Rules.
- MRT facility is an IC registered (MRT Reg. No. 11384A-1) test laboratory with the site description on file at Industry Canada.
- MRT facility is a VCCI registered (R-4179, G-814, C-4664, T-2206) test laboratory with the site description on file at VCCI Council.
- MRT Lab is accredited to ISO 17025 by the American Association for Laboratory Accreditation (A2LA) under the American Association for Laboratory Accreditation Program (A2LA Cert. No. 3628.01) in EMC, Telecommunications and Radio testing for FCC, Industry Canada, EU and TELEC Rules.

## 1. INTRODUCTION

### 1.1. Scope

Measurement and determination of electromagnetic emissions (EMC) of radio frequency devices including intentional and/or unintentional radiators for compliance with the technical rules and regulations of the Federal Communications Commission and the Industry Canada Certification and Engineering Bureau.

### 1.2. MRT Test Location

The map below shows the location of the MRT LABORATORY, its proximity to the Taihu Lake. These measurement tests were conducted at the MRT Technology (Suzhou) Co., Ltd. Facility located at D8 Building, No.2 Tian'edang Rd., Wuzhong Economic Development Zone, Suzhou, China. The detailed description of the measurement facility was found to be in compliance with the requirements of § 2.948 according to ANSI C63.4-2009 on September 30, 2013.



## 2. PRODUCT INFORMATION

### 2.1. Equipment Description

Product Name	iCOM Smart WiFi Module
Model No.	WFM21X, WFM210, WFM211, WFM212, WFM213, WFM214, WFM215, WFM216, WFM217, WFM218, WFM219
<b>Wi-Fi</b>	
Frequency Range	802.11b/g/n-HT20: 2412 ~ 2462 MHz 802.11n-HT40: 2422 ~ 2452 MHz
Maximum Output Power	802.11b: 20.286dBm 802.11g: 25.337dBm; 802.11n-HT20: 24.082dBm 802.11n-HT40: 24.824dBm
Type of Modulation	802.11b: DSSS 802.11g/n: OFDM
Data Rate	802.11b: 1/2/5.5/11 Mbps 802.11g: 6/9/12/18/24/36/48/54 Mbps 802.11n: up to 150 Mbps
Antenna Type	PCB Antenna
Antenna Gain	3.3dBi

**Channel List for 802.11b/g/n-HT20**

Channel	Frequency	Channel	Frequency	Channel	Frequency
01	2412 MHz	02	2417 MHz	03	2422 MHz
04	2427 MHz	05	2432 MHz	06	2437 MHz
07	2442 MHz	08	2447 MHz	09	2452 MHz
10	2457 MHz	11	2462 MHz	N/A	N/A

**Channel List for 802.11n-HT40**

Channel	Frequency	Channel	Frequency	Channel	Frequency
03	2422 MHz	04	2427 MHz	05	2432 MHz
06	2437 MHz	07	2442 MHz	08	2447 MHz
09	2452 MHz	N/A	N/A	N/A	N/A



## 2.2. Device Capabilities

This device contains the following capabilities:

802.11b/g/n WLAN (DTS)

**Note:** 2.4GHz WLAN (DTS) operation is possible in 20MHz, and 40MHz channel bandwidths. The maximum achievable duty cycles for all modes were determined based on measurements performed on a spectrum analyzer in zero-span mode with RBW = 8MHz, VBW = 50MHz, and detector = peak per the guidance of Section 6.0 b) of KDB 558074 D01v03r02. The RBW and VBW were both greater than  $50/T$ , where T is the minimum transmission duration, and the number of sweep points across T was greater than 100. The duty cycles are as follows:

- 802.11b - 100.0%
- 802.11g/n-HT20 - 100.0%
- 802.11n-HT40 - 100.0%
- 

## 2.3. Test Configuration

The **iCOM Smart WiFi Module FCC ID: QWOWFM210** was tested per the guidance of KDB 558074 D01v03r02. ANSI C63.10-2009 was used to reference the appropriate EUT setup for radiated spurious emissions testing and AC line conducted testing.

## 2.4. EMI Suppression Device(s)/Modifications

No EMI suppression device(s) were added and/or no modifications were made during testing.

## 2.5. Labeling Requirements

Per 2.1074 & 15.19; Docket 95-19

The label shall be permanently affixed at a conspicuous location on the device; instruction manual or pamphlet supplied to the user and be readily visible to the purchaser at the time of purchase.

However, when the device is so small wherein placement of the label with specified statement is not practical, only the trade name and FCC ID must be displayed on the device per Section 15.19(a)(5). Please see attachment for FCC ID label and label location.

## 2.6. Test Software

The test utility software used during testing was "MP\_TEST.exe".

## 2.7. Description of Support Units

The EUT has been tested with associated equipment below:

Description	Manufacturer	Model No.
Notebook	Lenovo	E430c

### 3. DESCRIPTION OF TEST

#### 3.1. Evaluation Procedure

The measurement procedures described in the American National Standard for Testing Unlicensed Wireless Devices (ANSI C63.10-2009), and the guidance provided in KDB 558074 D01v03r02 were used in the measurement of the **iCOM Smart WiFi Module FCC ID: QWOWFM210**.

**Deviation from measurement procedure.....None**

#### 3.2. AC Line Conducted Emissions

The line-conducted facility is located inside an 8'x4'x4' shielded enclosure. A 1m x 2m wooden table 80cm high is placed 40cm away from the vertical wall and 80cm away from the sidewall of the shielded room. Two 10kHz-30MHz, 50Ω/50uH Line-Impedance Stabilization Networks (LISNs) are bonded to the shielded room floor. Power to the LISNs is filtered by external high-current high-insertion loss power line filters. These filters attenuate ambient signal noise from entering the measurement lines. These filters are also bonded to the shielded enclosure.

The EUT is powered from one LISN and the support equipment is powered from the second LISN. All interconnecting cables more than 1 meter were shortened to a 1 meter length by non-inductive bundling (serpentine fashion) and draped over the back edge of the test table. All cables were at least 40cm above the horizontal reference ground-plane. Power cables for support equipment were routed down to the second LISN while ensuring that that cables were not draped over the second LISN.

Sufficient time for the EUT, support equipment, and test equipment was allowed in order for them to warm up to their normal operating condition. The RF output of the LISN was connected to the receiver and exploratory measurements were made to determine the frequencies producing the maximum emission from the EUT. The receiver was scanned from 150kHz to 30MHz. The detector function was set to peak mode for exploratory measurements while the bandwidth of the analyzer was set to 9kHz. The EUT, support equipment, and interconnecting cables were arranged and manipulated to maximize each emission. Each emission was also maximized by varying: power lines, the mode of operation or data exchange speed, or support equipment whichever determined the worst-case emission. Once the worst case emissions have been identified, the one EUT cable configuration/arrangement and mode of operation that produced these emissions were used for final measurements on the same test site. The analyzer is set to CISPR quasi-peak and average detectors with a 9kHz resolution bandwidth for final measurements.

An extension cord was used to connect to a single LISN which powered by EUT. The extension cord was calibrated with LISN, the impedance and insertion loss are compliance with the requirements as stated in ANSI C63.10-2009 at Clause 4.3.

Line conducted emissions test results are shown in Section 7.8.

### 3.3. Radiated Emissions

The radiated test facilities consisted of an indoor 3 meter semi-anechoic chamber used for final measurements and exploratory measurements, when necessary. The measurement area is contained within the semi-anechoic chamber which is shielded from any ambient interference. For measurements above 1GHz absorbers are arranged on the floor between the turn table and the antenna mast in such a way so as to maximize the reduction of reflections. For measurements below 1GHz, the absorbers are removed. A MF Model 210SS turntable is used for radiated measurement. It is a continuously rotatable, remote controlled, metallic turntable and 2 meters (6.56 ft.) in diameter. The turn table is flush with the raised floor of the chamber in order to maintain its function as a ground plane. An 80cm high PVC support structure is placed on top of the turntable.

For all measurements, the spectrum was scanned through all EUT azimuths and from 1 to 4 meter receive antenna height using a broadband antenna from 30MHz up to the upper frequency shown in 15.33(b)(1) depending on the highest frequency generated or used in the device or on which the device operates or tunes. For frequencies above 1GHz, linearly polarized double ridge horn antennas were used. For frequencies below 30MHz, a calibrated loop antenna was used. When exploratory measurements were necessary, they were performed at 1 meter test distance inside the semi-anechoic chamber using broadband antennas, broadband amplifiers, and spectrum analyzers to determine the frequencies and modes producing the maximum emissions. Sufficient time for the EUT, support equipment, and test equipment was allowed in order for them to warm up to their normal operating condition. The test set-up was placed on top of the 0.8 meter high, 1 x 1.5 meter table. The EUT, support equipment, and interconnecting cables were arranged and manipulated to maximize each emission. Appropriate precaution was taken to ensure that all emissions from the EUT were maximized and investigated. The system configuration, clock speed, mode of operation or video resolution, if applicable, turntable azimuth, and receive antenna height was noted for each frequency found.

Final measurements were made in the semi-anechoic chamber using calibrated, linearly polarized broadband and horn antennas. The test setup was configured to the setup that produced the worst case emissions. The spectrum analyzer was set to investigate all frequencies required for testing to compare the highest radiated disturbances with respect to the specified limits. The turntable containing the EUT was rotated through 360 degrees and the height of the receive antenna was varied 1 to 4 meters and stopped at the azimuth and height producing the maximum emission. Each emission was maximized by changing the orientation of the EUT through three orthogonal planes and changing the polarity of the receive antenna, whichever produced the worst-case emissions. According to 3dB BeamWidth of horn antenna, the horn antenna should be always directed to the EUT when rising height.

#### 4. ANTENNA REQUIREMENTS

**Excerpt from §15.203 of the FCC Rules/Regulations:**

“An intentional radiator antenna shall be designed to ensure that no antenna other than that furnished by the responsible party can be used with the device. The use of a permanently attached antenna or of an antenna that uses a unique coupling to the intentional radiator shall be considered sufficient to comply with the provisions of this section.”

- The antenna of the **iCOM Smart WiFi Module** uses a unique connector.

Antenna Type	Antenna Connector Type
PCB Antenna	IPEX connector

**Conclusion:**

The **iCOM Smart WiFi Module FCC ID: QWOWFM210** unit complies with the requirement of §15.203.

## 5. TEST EQUIPMENT CALIBRATION DATE

### Conducted Emissions

Instrument	Manufacturer	Type No.	Serial No.	Cali. Interval	Cali. Due Date
EMI Test Receiver	R&S	ESR7	101209	1 year	2015/11/07
Two-Line V-Network	R&S	ENV216	101683	1 year	2015/11/07
Two-Line V-Network	R&S	ENV216	101684	1 year	2015/11/07
Temperature/ Meter Humidity	Anymetre	TH101B	SR2-01	1 year	2015/11/14

### Radiated Emission

Instrument	Manufacturer	Type No.	Serial No.	Cali. Interval	Cali. Due Date
Spectrum Analyzer	Agilent	N9010A	MY5144016A	1 year	2015/01/04
Preamplifier	MRT	AP01G18	1310002	1 year	2015/10/06
Loop Antenna	Schwarzbeck	FMZB1519	1519-041	1 year	2015/11/08
TRILOG Antenna	Schwarzbeck	VULB9162	9162-047	1 year	2015/11/08
Broad-Band Horn Antenna	Schwarzbeck	BBHA9120D	9120D-1167	1 year	2015/11/08
Broadband Horn Antenna	Schwarzbeck	BBHA9170	9170-549	1 year	2014/12/11
Temperature/Humidity Meter	Anymetre	TH101B	AC1-01	1 year	2015/11/14

### Conducted Test Equipment

Instrument	Manufacturer	Type No.	Serial No.	Cali. Interval	Cali. Due Date
Spectrum Analyzer	Agilent	N9010A	MY5144016A	1 year	2015/01/04
Power Sensor	Agilent	U2021XA	MY52450003	1 year	2014/12/14
Temperature/Humidity Meter	Anymetre	TH101B	TR3-01	1 year	2015/11/14

## 6. MEASUREMENT UNCERTAINTY

Where relevant, the following test uncertainty levels have been estimated for tests performed on the EUT as specified in CISPR 16-4-2. This uncertainty represents an expanded uncertainty expressed at approximately the 95% confidence level using a coverage factor of  $k = 2$ .

<b>AC Conducted Emission Measurement</b>
Measuring Uncertainty for a Level of Confidence of 95% ( $U=2Uc(y)$ ): 150kHz~30MHz: $\pm 3.46\text{dB}$
<b>Radiated Emission Measurement</b>
Measuring Uncertainty for a Level of Confidence of 95% ( $U=2Uc(y)$ ): 9kHz ~ 1GHz: $\pm 4.18\text{dB}$ 1GHz ~ 25GHz: $\pm 4.76\text{dB}$

## 7. TEST RESULT

### 7.1. Summary

**Company Name:** Rayson Technology Co., Ltd.  
**FCC ID:** QWOWFM210  
**FCC Classification:** Digital Transmission System (DTS)  
**Data Rate(s)** 1Mbps ~ 11Mbps (b); 6Mbps ~ 54Mbps (g);  
**Tested:** 6.5/7.2Mbps ~ 65/72.2Mbps (n - HT20);  
13.5/15Mbps ~ 135/150Mbps (n - HT40);

FCC Part Section(s)	Test Description	Test Limit	Test Condition	Test Result	Reference
15.247(a)(2)	6dB Bandwidth	$\geq 500\text{kHz}$	Conducted	Pass	Section 7.2
15.247(b)(3)	Output Power	$\leq 1\text{Watt}$		Pass	Section 7.3
15.247(e)	Power Spectral Density	$\leq 8\text{dBm} / 3\text{kHz Band}$		Pass	Section 7.4
15.247(d)	Band Edge / Out-of-Band Emissions	$\geq 20\text{dBc(Peak)}$		Pass	Section 7.5
15.205 15.209	General Field Strength Limits (Restricted Bands and Radiated Emission Limits)	Emissions in restricted bands must meet the radiated limits detailed in 15.209	Radiated	Pass	Section 7.6 & 7.7
15.207	AC Conducted Emissions 150kHz - 30MHz	< FCC 15.207 limits	Line Conducted	Pass	Section 7.8

#### Notes:

- 1) All modes of operation and data rates were investigated. For radiated emission test, every axis (X, Y, Z) was also verified. The test results shown in the following sections represent the worst case emissions.
- 2) The analyzer plots shown in this section were all taken with a correction table loaded into the analyzer. The correction table was used to account for the losses of the cables and attenuators used as part of the system to connect the EUT to the analyzer at all frequencies of interest.
- 3) All antenna port conducted emissions testing was performed on a test bench with the antenna port of the EUT connected to the spectrum analyzer through calibrated cables and attenuators.



## 7.2. 6dB Bandwidth Measurement

### 7.2.1. Test Limit

The minimum 6dB bandwidth shall be at least 500 kHz.

### 7.2.2. Test Procedure used

KDB 558074 D01v03r02 - Section 8.2 Option 2

### 7.2.3. Test Setting

1. The Spectrum's automatic bandwidth measurement capability was used to perform the 6dB bandwidth measurement. The "X" dB bandwidth parameter was set to  $X = 6$ . The bandwidth measurement was not influenced by any intermediate power nulls in the fundamental emission.
2. Set RBW = 100 kHz
3. VBW  $\geq 3 \times$  RBW
4. Detector = Peak
5. Trace mode = max hold
6. Sweep = auto couple
7. Allow the trace was allowed to stabilize

### 7.2.4. Test Setup

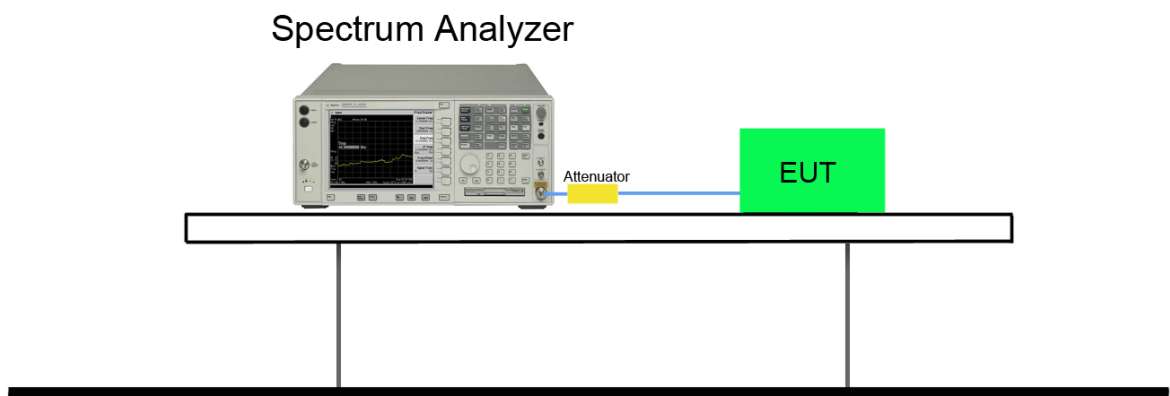

### 7.2.5. Test Result

Test Mode	Data Rate (Mbps)	Channel No.	Frequency (MHz)	6dB Bandwidth (MHz)	Limit (MHz)	Result
802.11b	1	01	2412	10.10	≥ 0.5	Pass
802.11b	1	06	2437	10.09	≥ 0.5	Pass
802.11b	1	11	2462	10.09	≥ 0.5	Pass
802.11g	6	01	2412	16.60	≥ 0.5	Pass
802.11g	6	06	2437	16.60	≥ 0.5	Pass
802.11g	6	11	2462	16.60	≥ 0.5	Pass
802.11n-HT20	6.5/7.2	01	2412	17.80	≥ 0.5	Pass
802.11n-HT20	6.5/7.2	06	2437	17.80	≥ 0.5	Pass
802.11n-HT20	6.5/7.2	11	2462	17.80	≥ 0.5	Pass
802.11n-HT40	13.5/15	03	2422	36.37	≥ 0.5	Pass
802.11n-HT40	13.5/15	06	2437	36.37	≥ 0.5	Pass
802.11n-HT40	13.5/15	09	2452	36.37	≥ 0.5	Pass

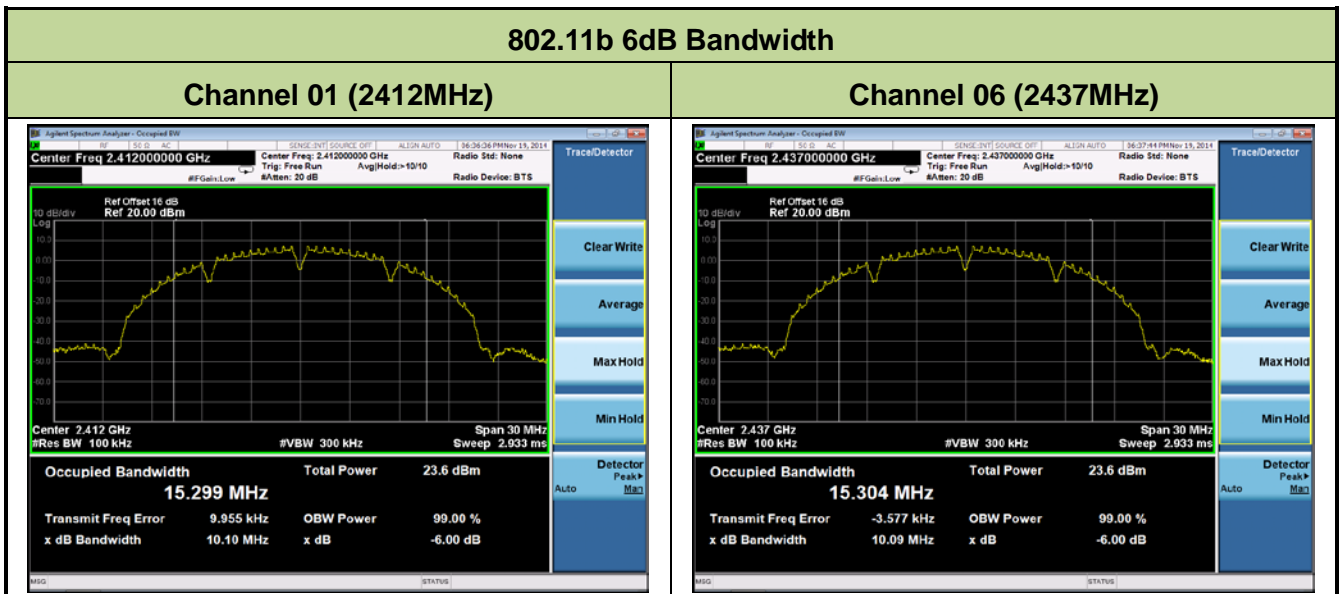

### Channel 11 (2462MHz)

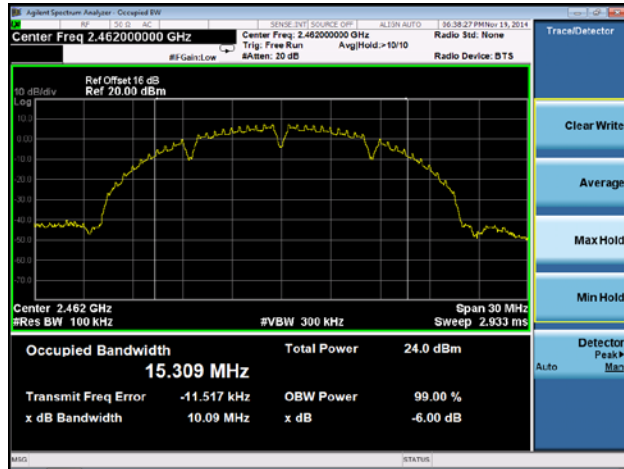

### 802.11g 6dB Bandwidth

### Channel 01 (2412MHz)

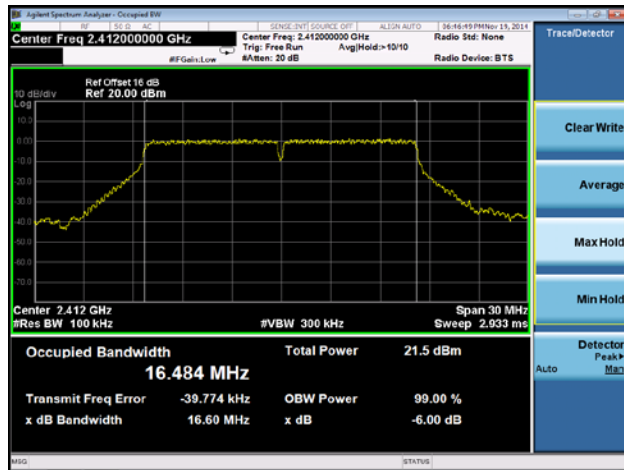

### Channel 06 (2437MHz)

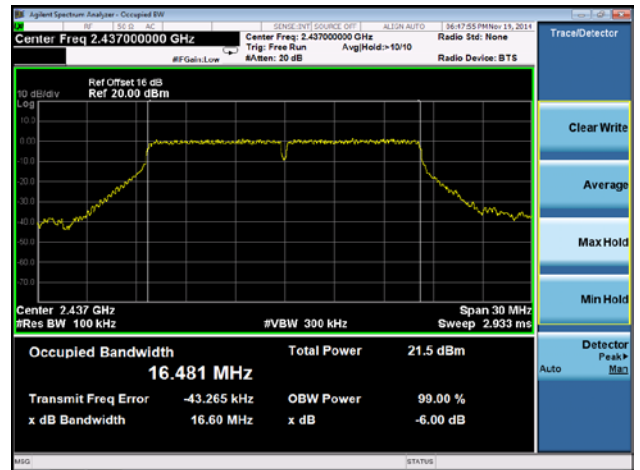

### Channel 11 (2462MHz)

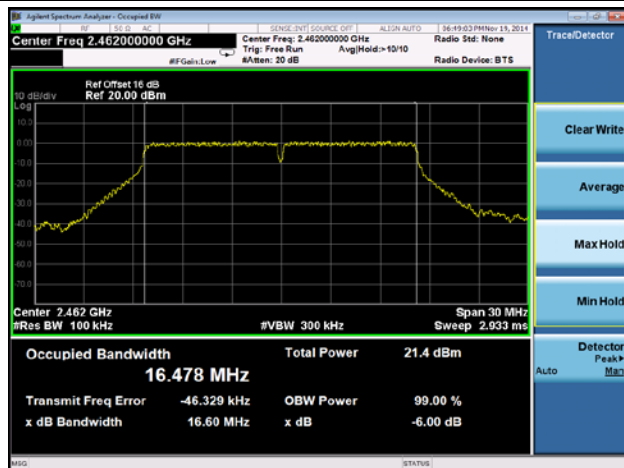

### 802.11n-HT20 6dB Bandwidth

#### Channel 01 (2412MHz)

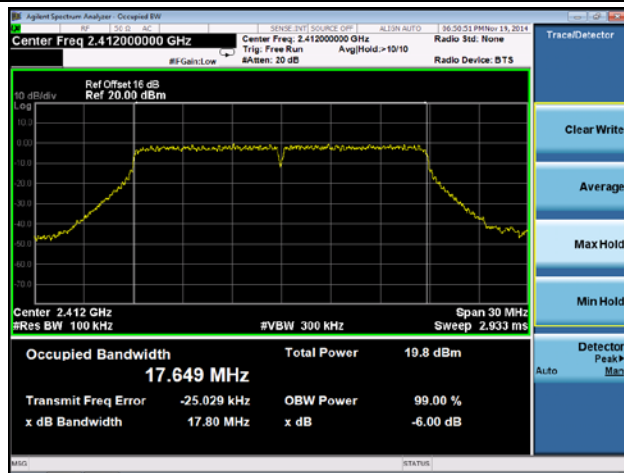

#### Channel 06 (2437MHz)

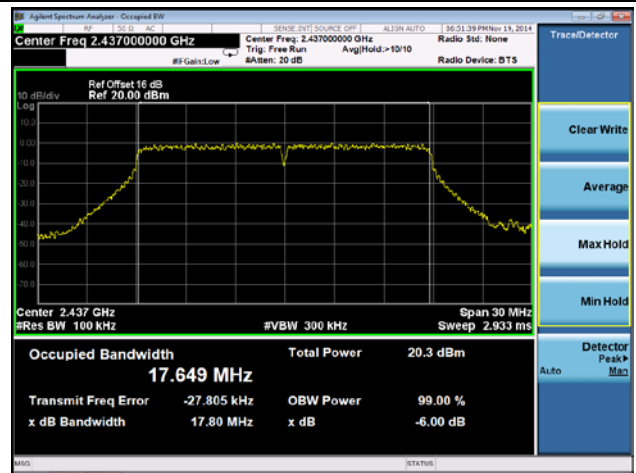

#### Channel 11 (2462MHz)

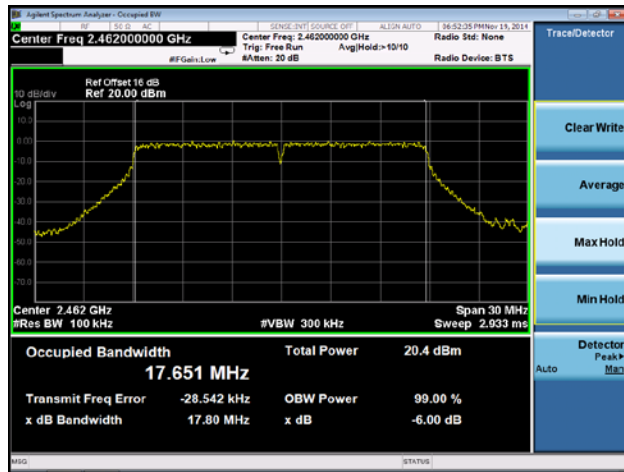

### 802.11n-HT40 6dB Bandwidth

#### Channel 03 (2422MHz)

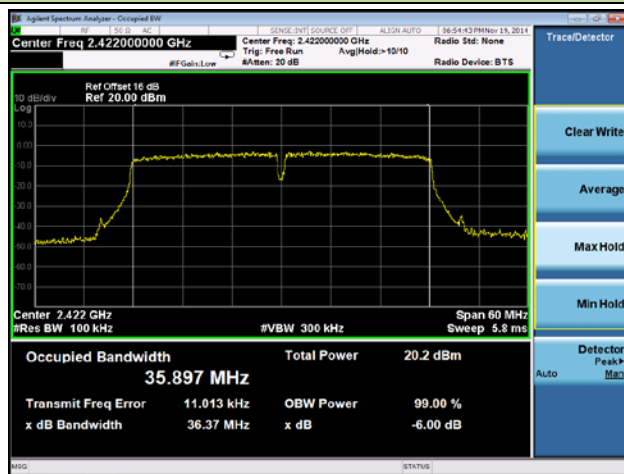

#### Channel 06 (2437MHz)

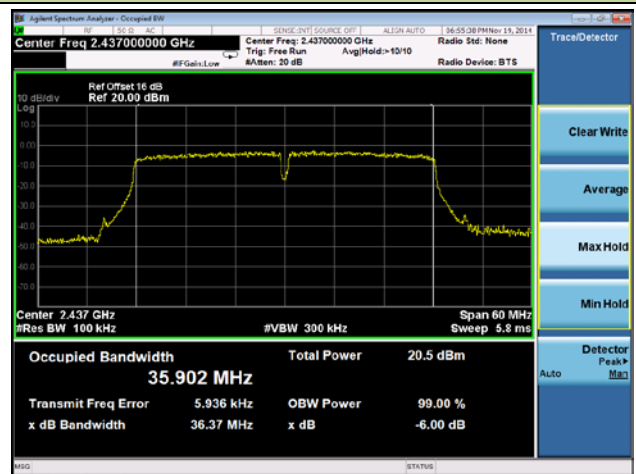

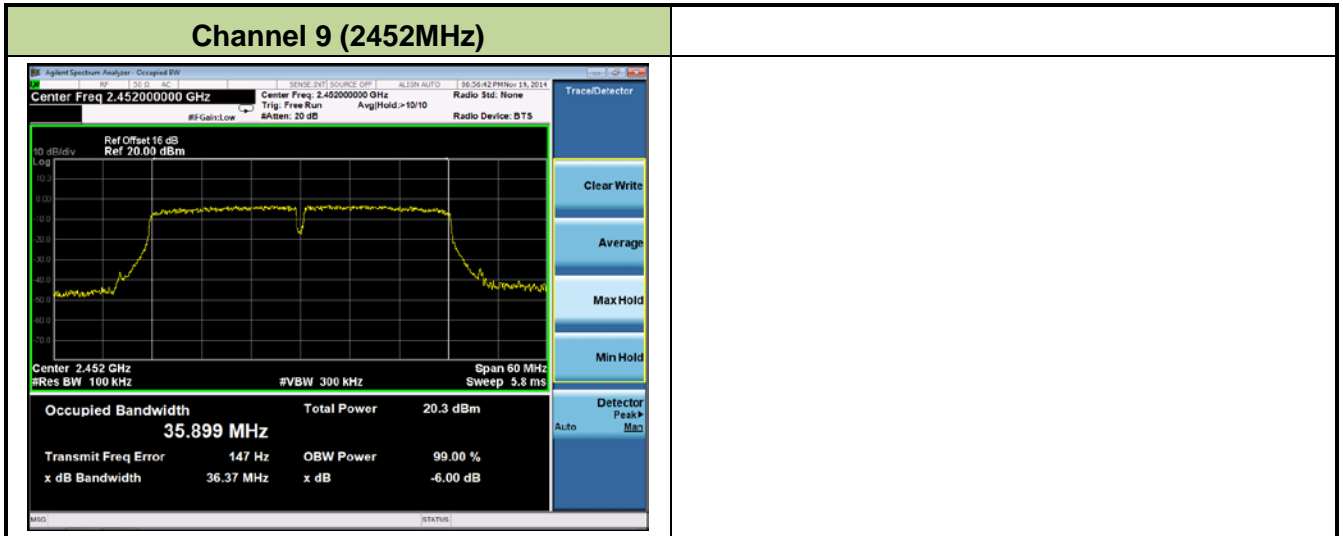

## 7.3. Output Power Measurement

### 7.3.1. Test Limit

The maximum out power shall be less 1 Watt (30dBm).

### 7.3.2. Test Procedure Used

KDB 558074 D01v03r02 - Section 9.1.2 PKPM1 Peak Power Method (for signals with BW  $\leq$  50MHz)

### 7.3.3. Test Setting

#### **Method PKPM1 (Peak Power Measurement of Signals with DTS BW $\leq$ 50MHz)**

Peak power measurements were performed only when the EUT was transmitting at its maximum power control level using a broadband power meter with a pulse sensor. The pulse sensor employs a VBW = 50MHz so this method was only used for signals whose DTS bandwidth was less than or equal to 50MHz.

### 7.3.4. Test Setup

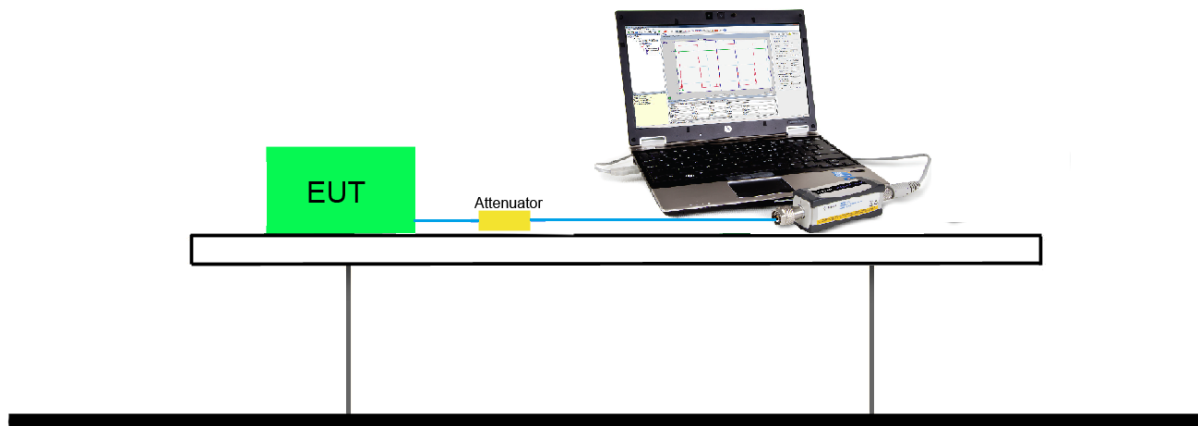

### 7.3.5. Test Result of Output Power

Output power at various data rates:

Test Mode	Bandwidth (MHz)	Channel No.	Frequency (MHz)	Data Rate (Mbps)	Peak Power (dBm)
802.11b	20	6	2437	1	19.935
				5.5	19.717
				11	19.691
802.11g	20	6	2437	6	25.334
				24	25.242
				54	25.267
802.11n	20	6	2437	6.5/7.2(MCS0)	24.031
				39/43.3(MCS4)	24.027
				65/72.2(MCS7)	23.912
802.11n	40	6	2437	13.5/15(MCS0)	24.824
				81/90(MCS4)	24.162
				135/150(MCS7)	23.839

### Test Result of Peak Output Power

Test Mode	Data Rate (Mbps)	Channel No.	Frequency (MHz)	Peak Power (dBm)	Limit (dBm)	Result
11b	1	1	2412	19.827	≤ 30	Pass
11b	1	6	2437	19.935	≤ 30	Pass
11b	1	11	2462	20.286	≤ 30	Pass
11g	6	1	2412	25.148	≤ 30	Pass
11g	6	6	2437	25.334	≤ 30	Pass
11g	6	11	2462	25.337	≤ 30	Pass
11n-HT20	6.5/7.2	1	2412	23.257	≤ 30	Pass
11n-HT20	6.5/7.2	6	2437	24.031	≤ 30	Pass
11n-HT20	6.5/7.2	11	2462	24.082	≤ 30	Pass
11n-HT40	13.5/15	3	2422	23.873	≤ 30	Pass
11n-HT40	13.5/15	6	2437	24.824	≤ 30	Pass
11n-HT40	13.5/15	9	2452	24.014	≤ 30	Pass

**Test Result of Average Output Power (Reporting Only)**

Test Mode	Data Rate (Mbps)	Channel No.	Frequency (MHz)	Average Power (dBm)	Limit (dBm)	Result
11b	1	1	2412	17.247	≤30	Pass
11b	1	6	2437	17.357	≤30	Pass
11b	1	11	2462	17.692	≤30	Pass
11g	6	1	2412	15.472	≤30	Pass
11g	6	6	2437	15.721	≤30	Pass
11g	6	11	2462	15.738	≤30	Pass
11n-HT20	6.5/7.2	1	2412	14.083	≤30	Pass
11n-HT20	6.5/7.2	6	2437	14.670	≤30	Pass
11n-HT20	6.5/7.2	11	2462	14.674	≤30	Pass
11n-HT40	13.5/15	3	2422	14.239	≤30	Pass
11n-HT40	13.5/15	6	2437	14.562	≤30	Pass
11n-HT40	13.5/15	9	2452	14.407	≤30	Pass



## 7.4. Power Spectral Density Measurement

### 7.4.1. Test Limit

The maximum permissible power spectral density is 8dBm in any 3 kHz band.

### 7.4.2. Test Procedure Used

KDB 558074 D01v03r02 - Section 10.2 Method PKPSD

### 7.4.3. Test Setting

1. Analyzer was set to the center frequency of the DTS channel under investigation
2. Span = 1.5 times the DTS channel bandwidth
3. RBW = 3kHz
4. VBW = 10kHz
5. Detector = peak
6. Sweep time = auto couple
7. Trace mode = max hold
8. Trace was allowed to stabilize

### 7.4.4. Test Setup

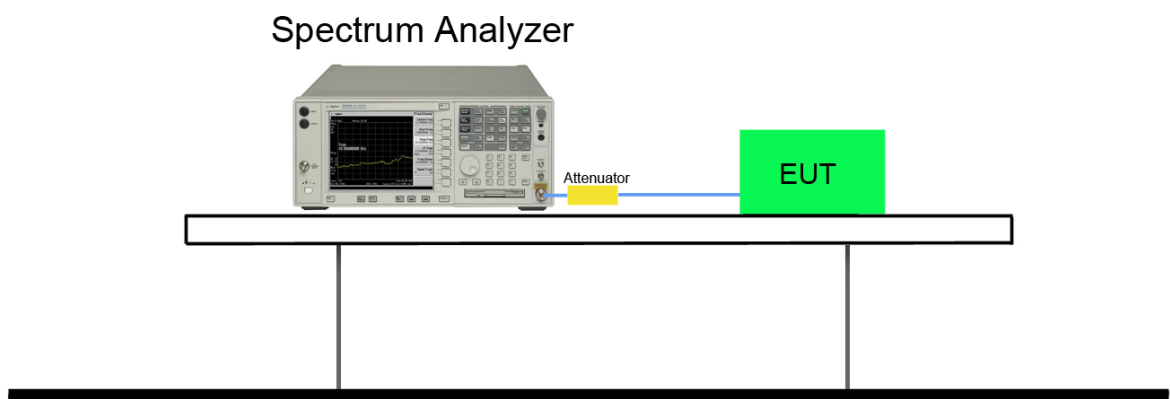

**7.4.5. Test Result**

Test Mode	Data Rate (Mbps)	Channel No.	Frequency (MHz)	PSD Result (dBm / 3kHz)	Limit (dBm / 3kHz)	Result
11b	1	1	2412	-13.366	≤ 8	Pass
11b	1	6	2437	-13.366	≤ 8	Pass
11b	1	11	2462	-12.854	≤ 8	Pass
11g	6	1	2412	-13.475	≤ 8	Pass
11g	6	6	2437	-13.298	≤ 8	Pass
11g	6	11	2462	-13.065	≤ 8	Pass
11n-HT20	6.5/7.2	1	2412	-14.163	≤ 8	Pass
11n-HT20	6.5/7.2	6	2437	-13.660	≤ 8	Pass
11n-HT20	6.5/7.2	11	2462	-13.603	≤ 8	Pass
11n-HT40	13.5/15	3	2422	-14.088	≤ 8	Pass
11n-HT40	13.5/15	6	2437	-13.852	≤ 8	Pass
11n-HT40	13.5/15	9	2452	-14.077	≤ 8	Pass

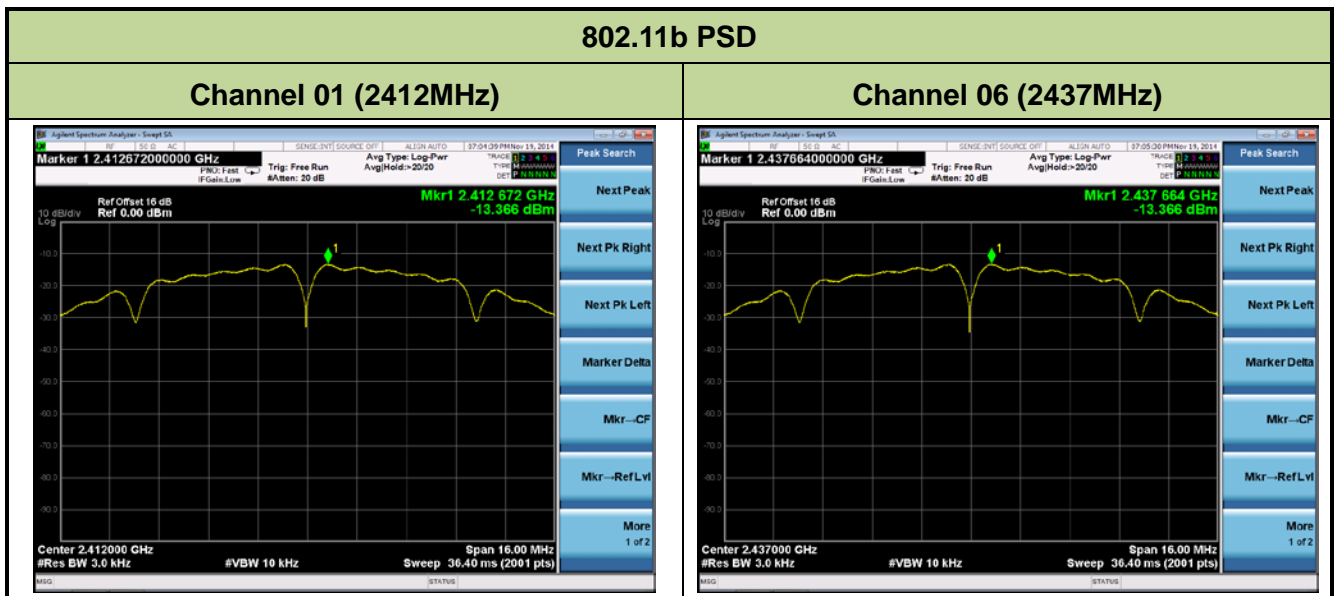

### Channel 11 (2462MHz)

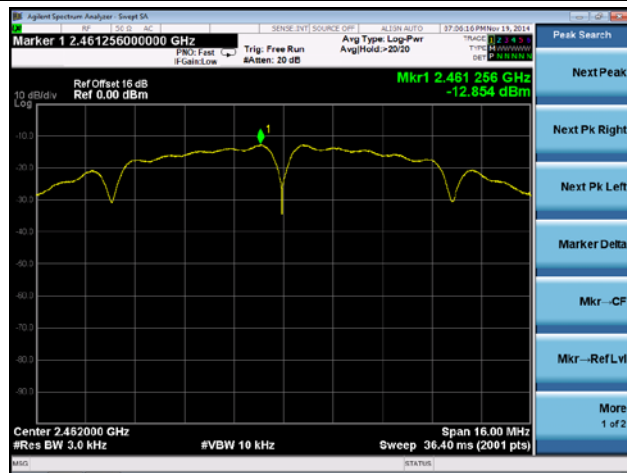

### 802.11g PSD

### Channel 01 (2412MHz)

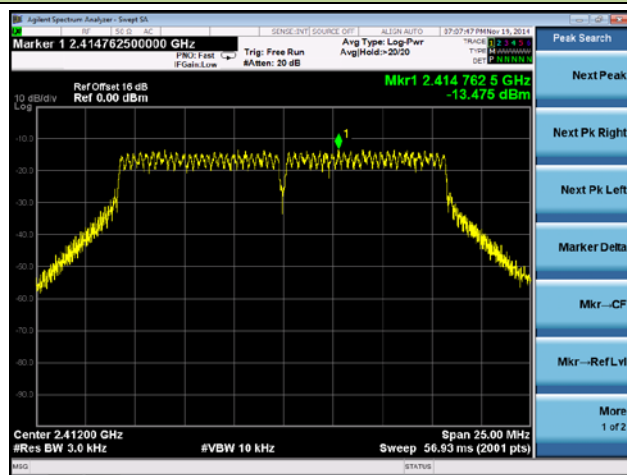

### Channel 06 (2437MHz)

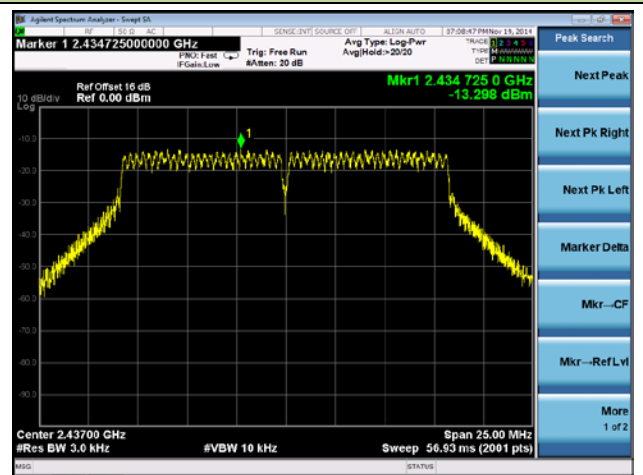

### Channel 11 (2462MHz)

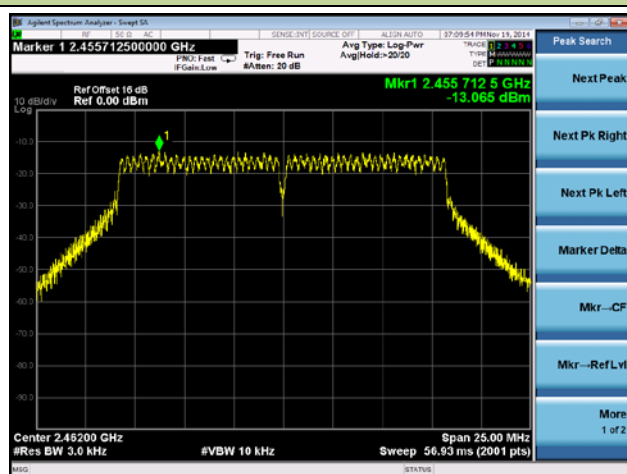

### 802.11n-HT20 PSD

Channel 01 (2412MHz)

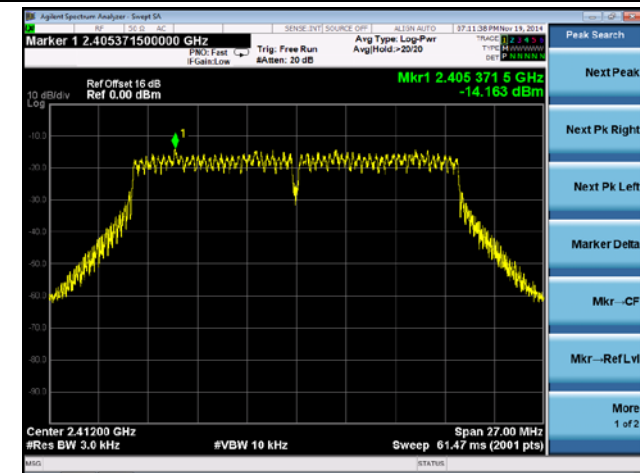

Channel 06 (2437MHz)

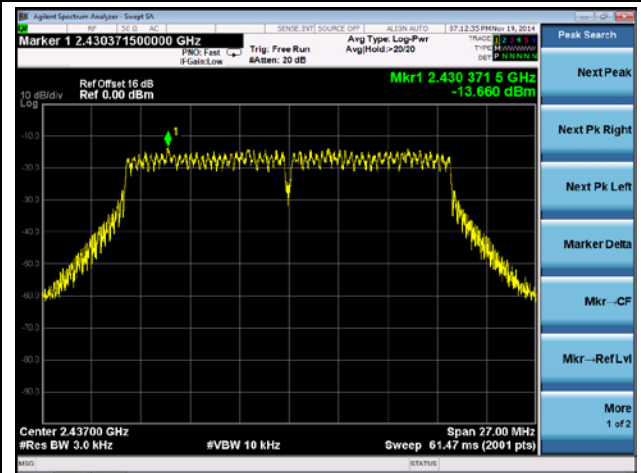

Channel 11 (2462MHz)

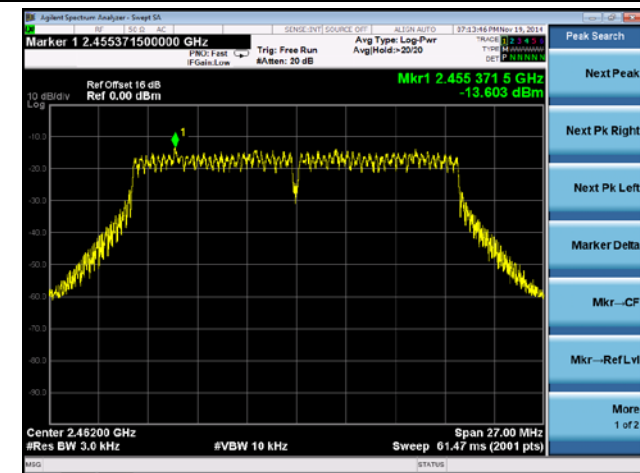

### 802.11n-HT40 PSD

Channel 03 (2422MHz)

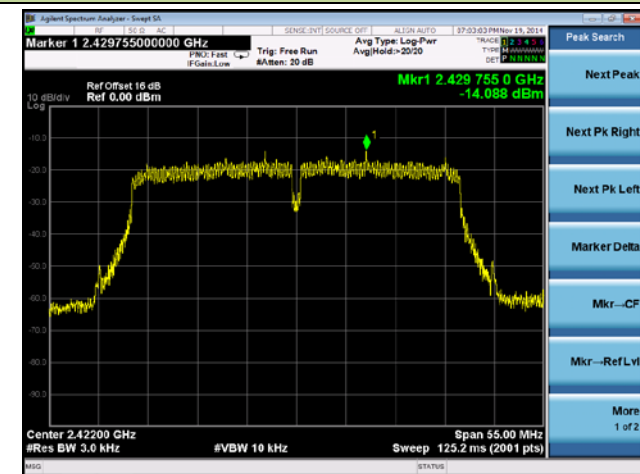

Channel 06 (2437MHz)

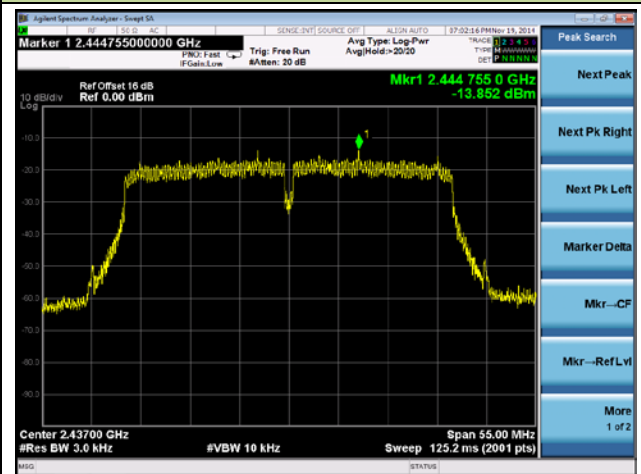

### Channel 09 (2452MHz)

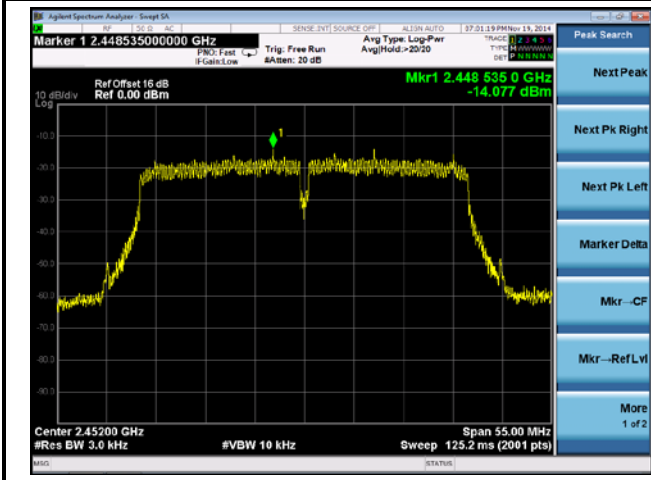

## **7.5. Conducted Band Edge and Out-of-Band Emissions**

### **7.5.1. Test Limit**

The limit for out-of-band spurious emissions at the band edge is 20dB below the fundamental emission level, as determined from the in-band power measurement of the DTS channel performed in a 100kHz bandwidth per the PSD procedure (Section 9.1).

### **7.5.2. Test Procedure Used**

KDB 558074 D01v03r02 - Section 11.2 & Section 11.3

### **7.5.3. Test Setting**

#### **1. Reference level measurement**

- (a) Set instrument center frequency to DTS channel center frequency
- (b) Set the span to  $\geq 1.5$  times the DTS bandwidth
- (c) Set the RBW = 100 kHz
- (d) Set the VBW  $\geq 3 \times$  RBW
- (e) Detector = peak
- (f) Sweep time = auto couple
- (g) Trace mode = max hold
- (h) Allow trace to fully stabilize

#### **2. Emission level measurement**

- (a) Set the center frequency and span to encompass frequency range to be measured
- (b) RBW = 100kHz
- (c) VBW = 300kHz
- (d) Detector = Peak
- (e) Number of sweep points  $\geq 2 \times$  Span/RBW
- (f) Trace mode = max hold
- (g) Sweep time = auto couple

(h) The trace was allowed to stabilize

#### 7.5.4. Test Setup

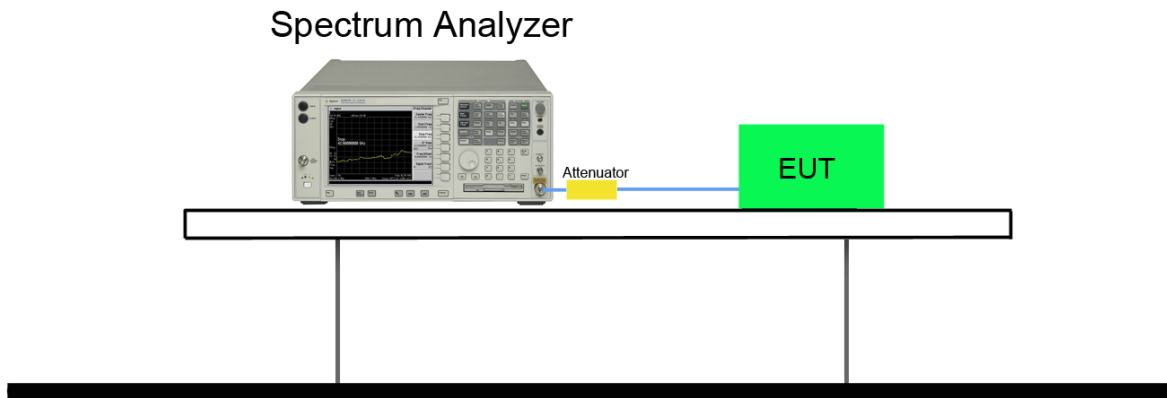

**7.5.5. Test Result**

Test Mode	Data Rate (Mbps)	Channel No.	Frequency (MHz)	Limit	Result
802.11b	1	01	2412	20dBc	Pass
802.11b	1	06	2437	20dBc	Pass
802.11b	1	11	2462	20dBc	Pass
802.11g	6	01	2412	20dBc	Pass
802.11g	6	06	2437	20dBc	Pass
802.11g	6	11	2462	20dBc	Pass
11n-HT20	6.5/7.2	1	2412	20dBc	Pass
11n-HT20	6.5/7.2	6	2437	20dBc	Pass
11n-HT20	6.5/7.2	11	2462	20dBc	Pass
11n-HT40	13.5/15	3	2422	20dBc	Pass
11n-HT40	13.5/15	6	2437	20dBc	Pass
11n-HT40	13.5/15	9	2452	20dBc	Pass



### 802.11b Out-of-Band Emissions

#### Channel 01 (2412MHz)

##### 100kHz PSD reference Level

##### Low Band Edge

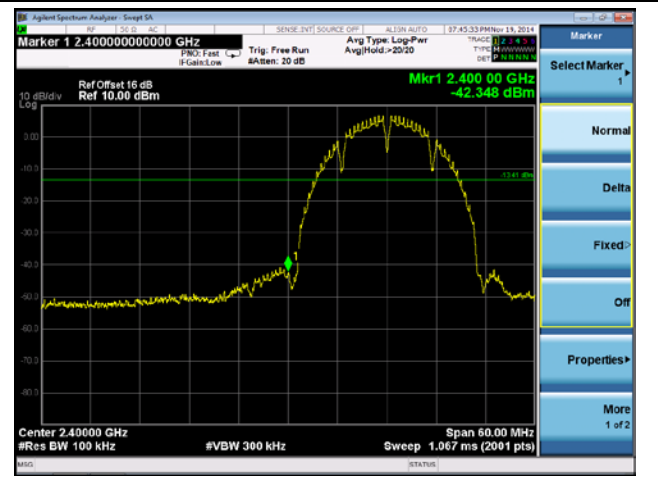
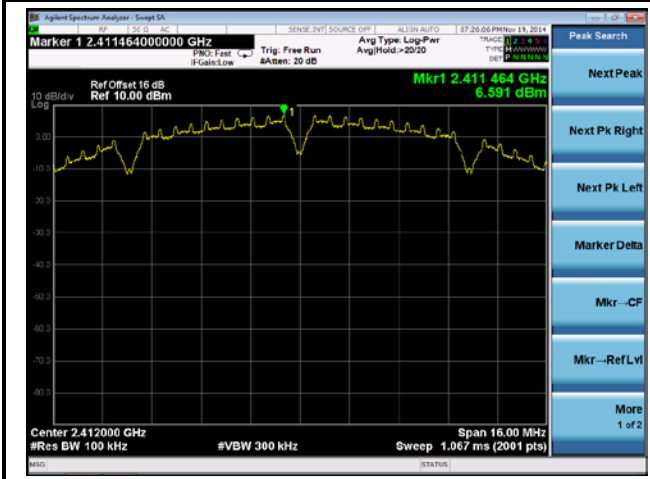

### Spurious Emission 30MHz ~ 25GHz



### Channel 06 (2437MHz)

#### 100kHz PSD reference Level

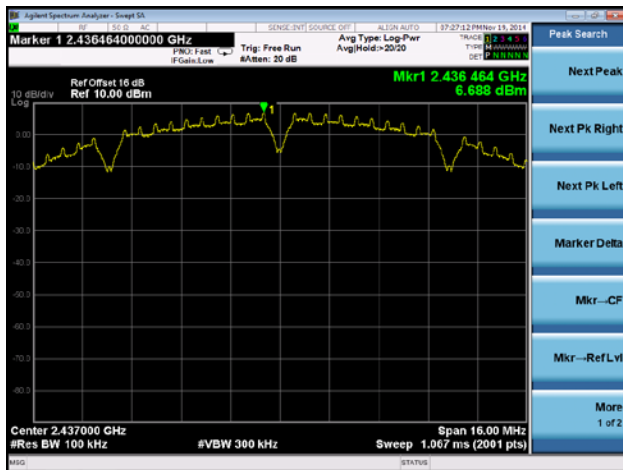

#### Spurious Emission 30MHz ~ 25GHz



### Channel 11 (2462MHz)

#### 100kHz PSD reference Level

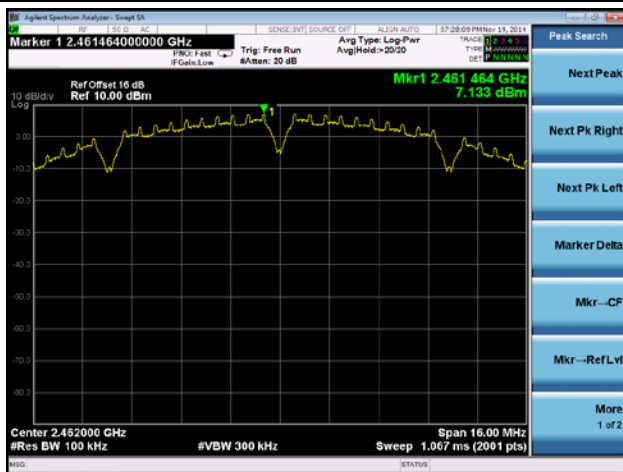

#### High Band Edge

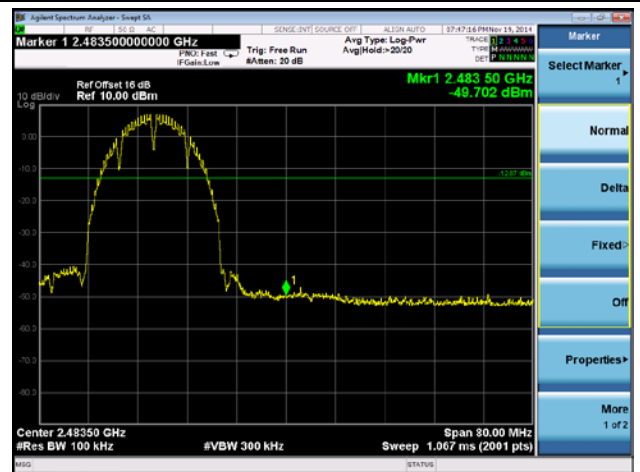

### Spurious Emission 30MHz ~ 25GHz



### 802.11g Out-of-Band Emissions

#### Channel 01 (2412MHz)

#### 100kHz PSD reference Level



#### Low Band Edge

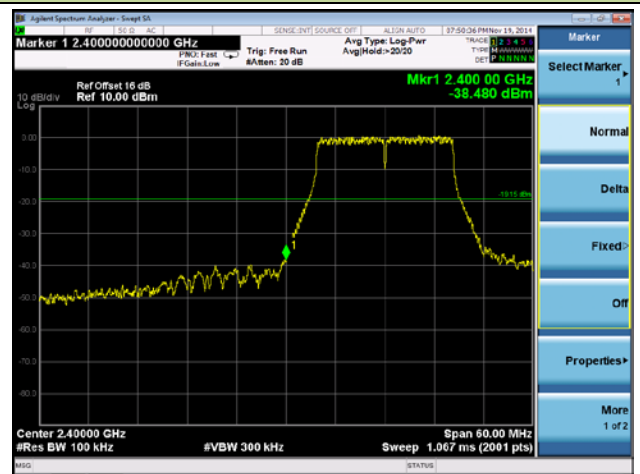

### Spurious Emission 30MHz ~ 25GHz



### Channel 06 (2437MHz)

#### 100kHz PSD reference Level

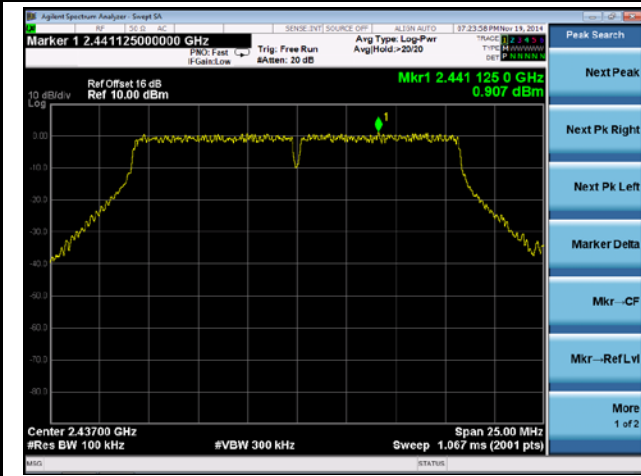

#### Spurious Emission 30MHz ~ 25GHz



### Channel 11 (2462MHz)

#### 100kHz PSD reference Level

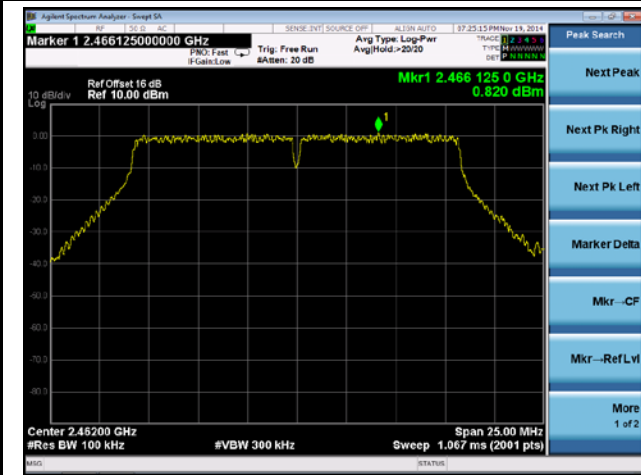

#### High Band Edge

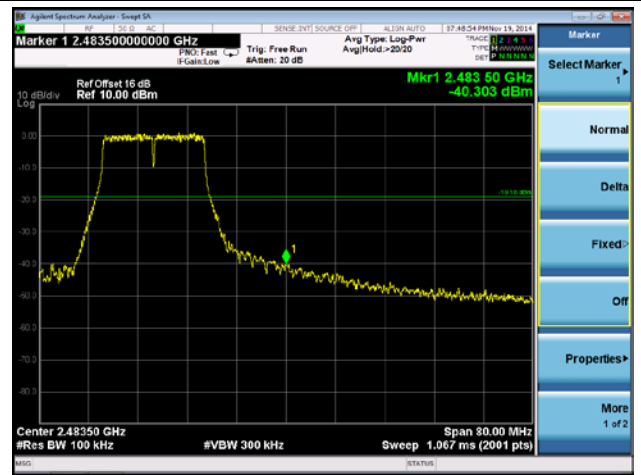

#### Spurious Emission 30MHz ~ 25GHz



### 802.11n-HT20 Out-of-Band Emissions

#### Channel 01 (2412MHz)

##### 100kHz PSD reference Level

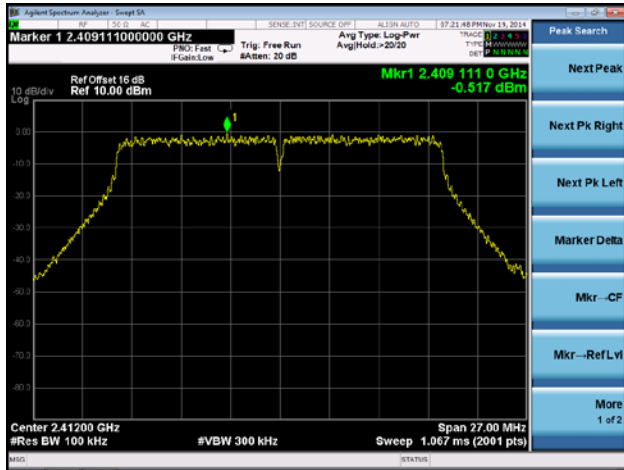

##### Low Band Edge

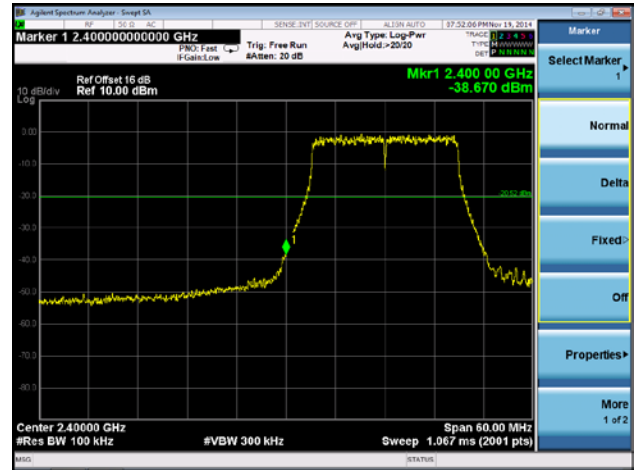

##### Spurious Emission 30MHz ~ 25GHz

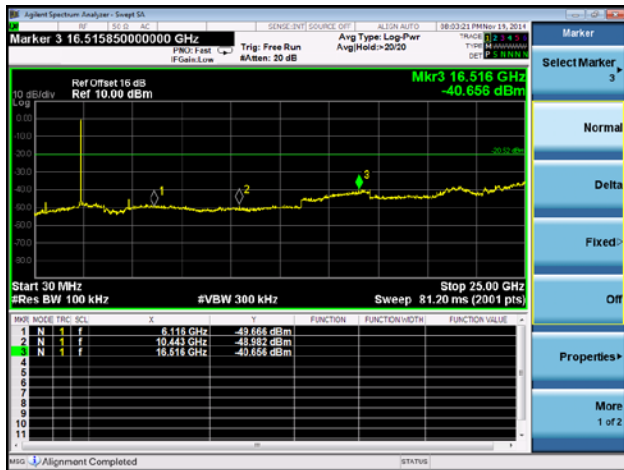

#### Channel 06 (2437MHz)

##### 100kHz PSD reference Level

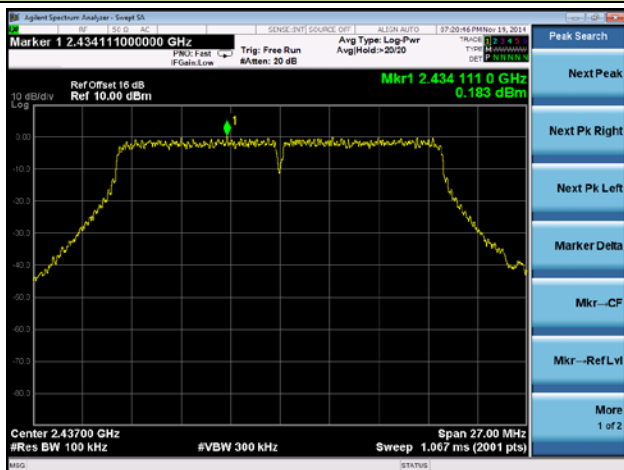

##### Spurious Emission 30MHz ~ 25GHz



### Channel 11 (2462MHz)

#### 100kHz PSD reference Level

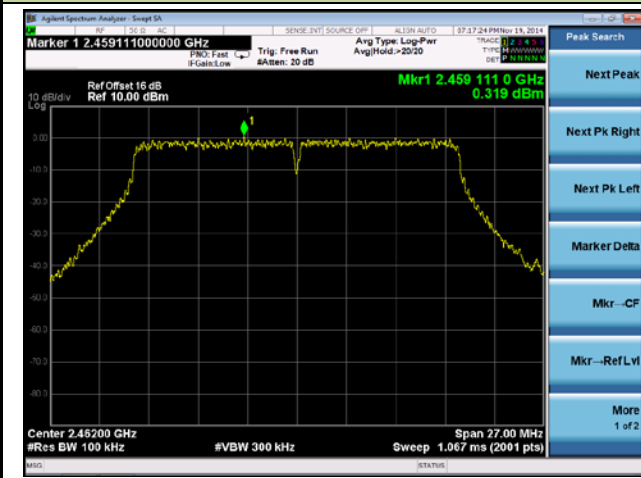

#### High Band Edge

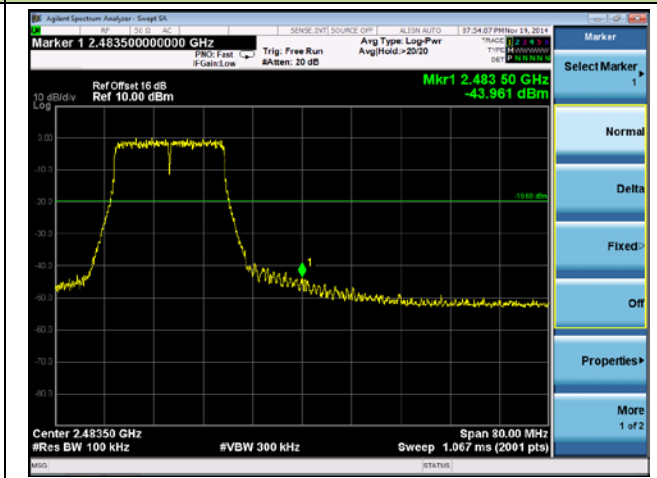

### Spurious Emission 30MHz ~ 25GHz



### 802.11n-HT40 Out-of-Band Emissions

### Channel 03 (2422MHz)

#### 100kHz PSD reference Level

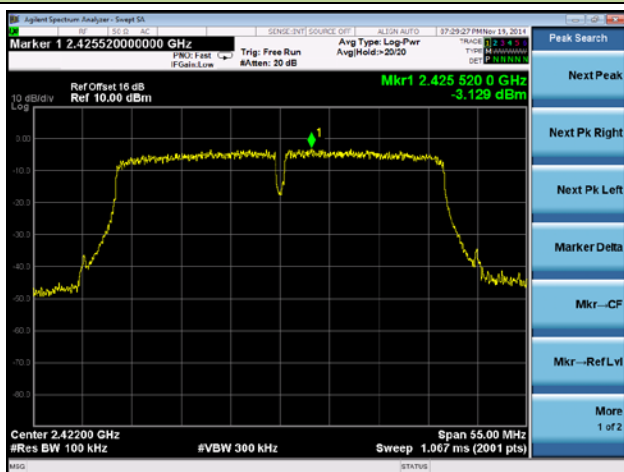

#### Low Band Edge

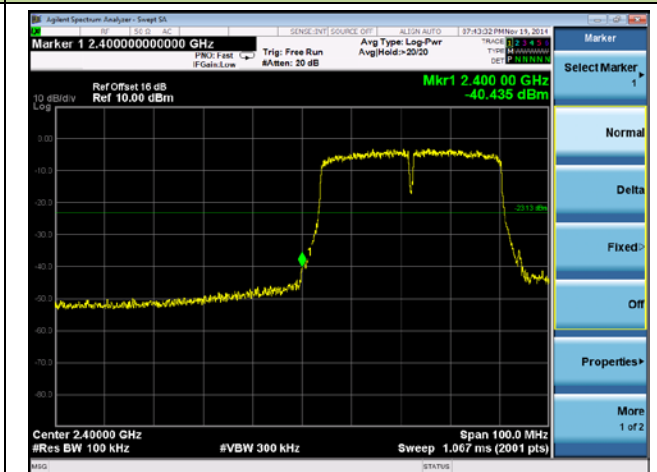

### Spurious Emission 30MHz ~ 25GHz



### Channel 06 (2437MHz)

#### 100kHz PSD reference Level

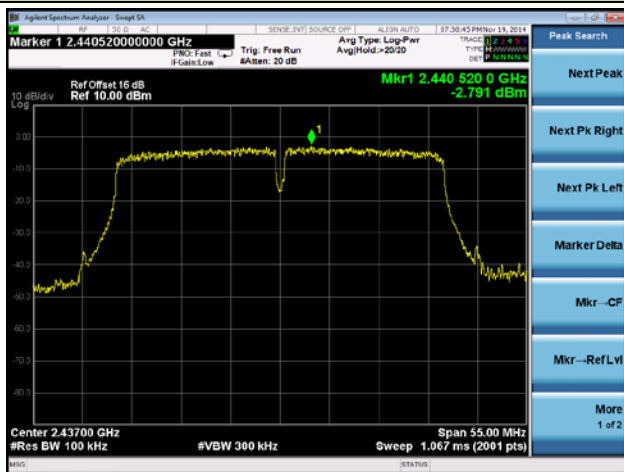

#### Spurious Emission 30MHz ~ 25GHz



### Channel 09 (2452MHz)

#### 100kHz PSD reference Level

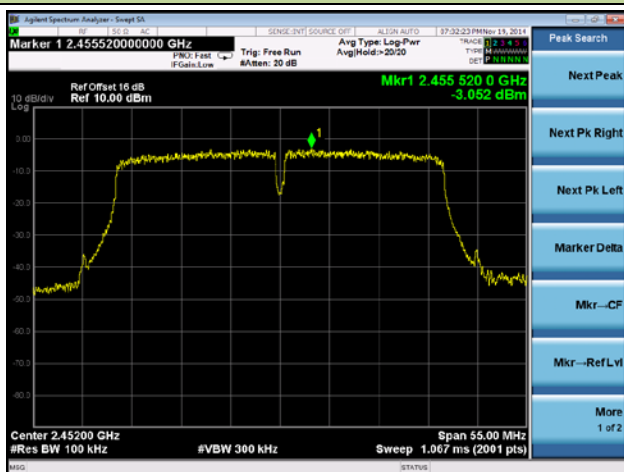

#### High Band Edge

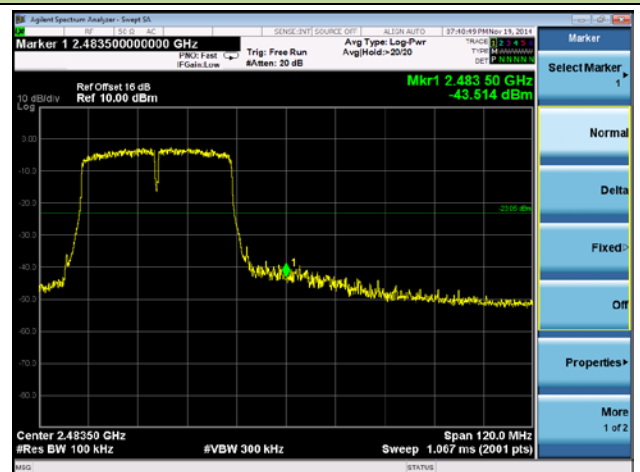

### Spurious Emission 30MHz ~ 25GHz





## 7.6. Radiated Spurious Emission Measurement

### 7.6.1. Test Limit

All out of band emissions appearing in a restricted band as specified in Section 15.205 of the Title 47 CFR must not exceed the limits shown in Table per Section 15.209.

FCC Part 15 Subpart C Paragraph 15.209		
Frequency [MHz]	Field Strength [V/m]	Measured Distance [Meters]
0.009 – 0.490	2400/F (kHz)	300
0.490 – 1.705	24000/F (kHz)	30
1.705 - 30	30	30
30 - 88	100	3
88 - 216	150	3
216 - 960	200	3
Above 960	500	3

### 7.6.2. Test Procedure Used

KDB 558074 D01v03r02 – Section 12.2.3 (quasi-peak measurements)

KDB 558074 D01v03r02 – Section 12.2.4 (peak power measurements)

KDB 558074 D01v03r02 – Section 12.2.5 (average power measurements)

### 7.6.3. Test Setting

#### Peak Field Strength Measurements per Section 12.2.4 of KDB 558074 D01v03r02

1. Analyzer center frequency was set to the frequency of the radiated spurious emission of interest
2. RBW = as specified in Table 1
3. VBW = 3MHz
4. Detector = peak
5. Sweep time = auto couple

6. Trace mode = max hold

7. Trace was allowed to stabilize

**Table 1—RBW as a function of frequency**

Frequency	RBW
9 ~ 150 kHz	200 ~ 300 Hz
0.15 ~ 30 MHz	9 ~ 10 kHz
30 ~ 1000 MHz	100 ~ 120 kHz
> 1000 MHz	1 MHz

**Average Field Strength Measurements per Section 12.2.5.1 of KDB 558074 D01v03r02**

1. RBW = 1MHz.
2. VBW  $\geq 3 \times$  RBW.
3. Detector = RMS, if span/(# of points in sweep)  $\leq$  (RBW/2). Satisfying this condition may require increasing the number of points in the sweep or reducing the span. If this condition cannot be satisfied, then the detector mode shall be set to peak.
4. Averaging type = power (*i.e.*, RMS).
  - As an alternative, the detector and averaging type may be set for linear voltage averaging.
  - Some instruments require linear display mode in order to use linear voltage averaging. Log or dB averaging shall not be used.
5. Sweep time = auto.
6. Perform a trace average of at least 100 traces.

### 7.6.4. Test Setup

#### 9kHz ~ 30MHz Test Setup:

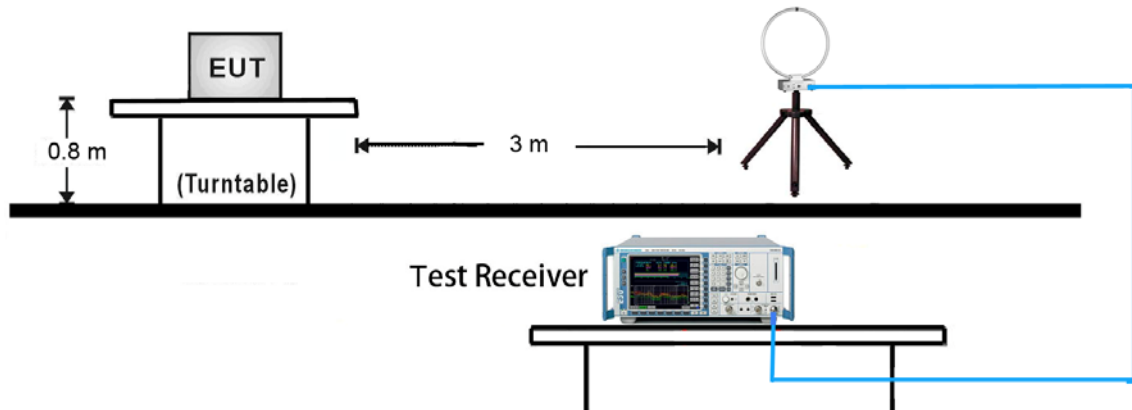

#### 30MHz ~ 1GHz Test Setup:

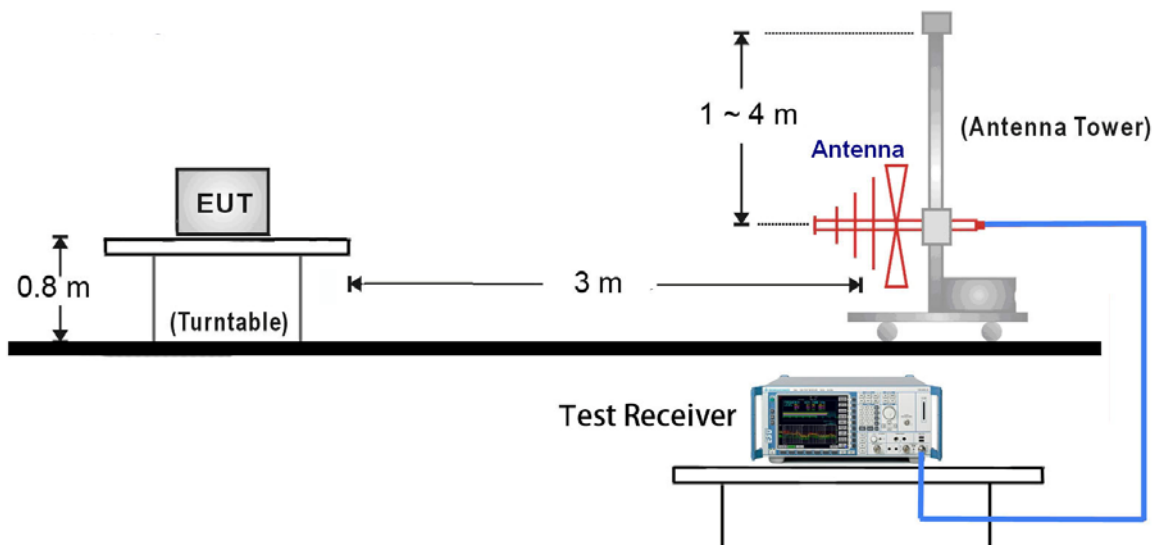

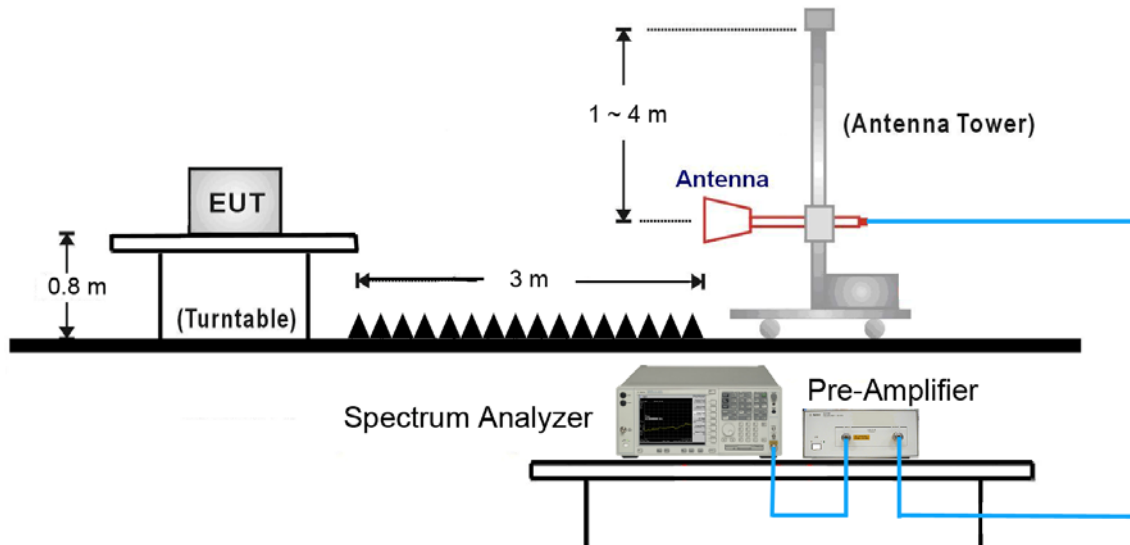
1GHz ~ 25GHz Test Setup:

REMARK: The test channel 1/6/11 of 802.11b/g/n-H20 mode and channel 3/6/9 of 11n-H40 mode have been tested, only worst case is reported.

For radiated emission testing within 30MHz-1GHz, 802.11b channel 11 is the worst case.

For radiated emission testing within 1GHz to 25GHz, 802.11b channel 1 is the worst case.

For radiated emission testing in restriction bands, 802.11g channel 1 and 802.11n-H40 channel 9 are worst case.

**7.6.5. Test Result**

Test Mode:	802.11b	Test Site:	AC1
Test Channel:	01	Test Engineer:	Milo Li
Remark:	1. Average measurement was not performed if peak level lower than average limit. 2. <b>The worst case of Radiated Spurious Emission.</b> 3. Other frequency was 20dB below limit line within 1-18GHz, there is not show in the report. 4.		

Mark	Frequency (MHz)	Reading Level (dBμV)	Factor (dB)	Measure Level (dBμV/m)	Limit (dBμV/m)	Margin (dB)	Detector	Polarization
*	4417.0	37.0	5.5	42.5	89.8	-47.3	Peak	Horizontal
	4824.0	37.8	6.4	44.2	74.0	-29.8	Peak	Horizontal
	5382.0	37.3	6.9	44.2	74.0	-29.8	Peak	Horizontal
*	7236.0	36.6	13.8	50.4	89.8	-39.4	Peak	Horizontal
*	4417.0	37.0	5.5	42.5	89.8	-47.3	Peak	Vertical
	4824.0	37.0	6.4	43.4	74.0	-30.6	Peak	Vertical
	5426.0	36.7	7.0	43.7	74.0	-30.3	Peak	Vertical
*	7236.0	35.5	13.8	49.3	89.8	-40.5	Peak	Vertical

Note 1: "\*" is not in restricted band, its limit is 20dBc of the fundamental emission level (109.8dBμV/m).

Note 2: Measure Level (dBμV/m) = Reading Level (dBμV) + Factor (dB)

Factor (dB) = Cable Loss (dB) + Antenna Factor (dB/m) - Pre\_Amplifier Gain (dB)

**The worst case of Radiated Emission below 1GHz:**

Site: AC1	Time: 2014/11/20 - 20:12
Limit: FCC_Part15.209_RE(3m)	Engineer: Milo Li
Probe: VULB9162_0.03-8GHz	Polarity: Horizontal
EUT: iCOM Smart WiFi Module	Power: AC 120V/60Hz
<b>Worse Case Mode : 802.11b at Channel 2462MHz</b>	

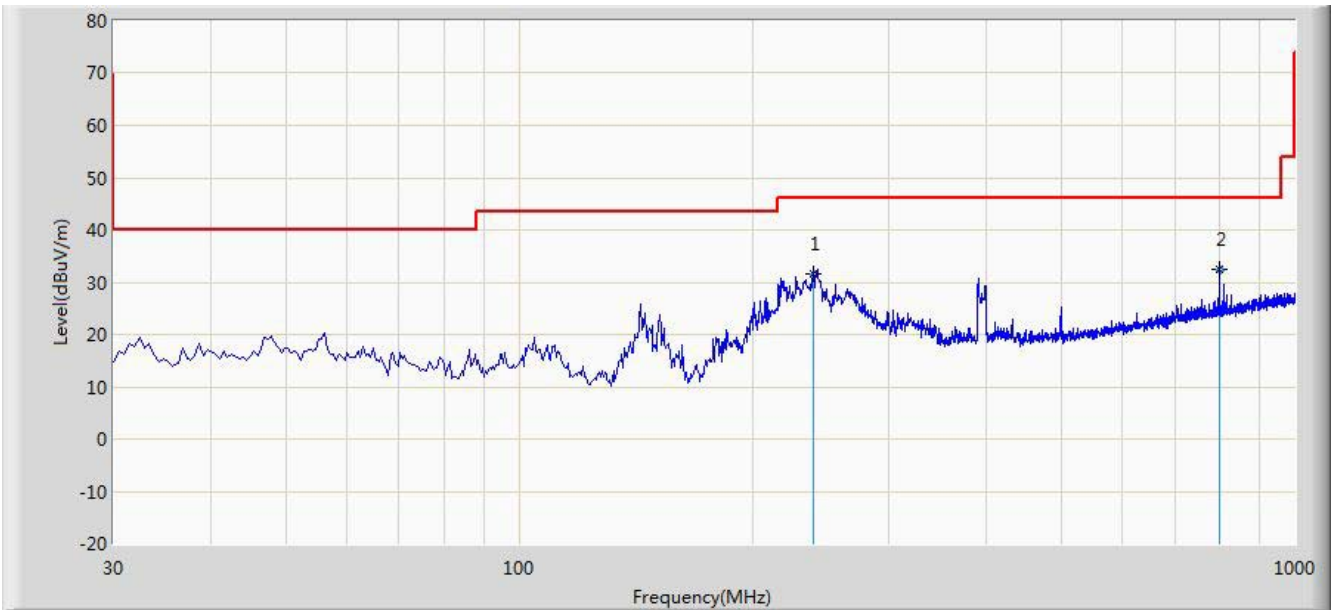

No	Frequency (MHz)	Measure Level (dBuV/m)	Reading Level (dBuV)	Over Limit (dB)	Limit (dBuV/m)	Factor (dB)	Type
1	240.011	31.666	18.640	-14.334	46.000	13.026	QP
2	799.814	32.348	10.241	-13.652	46.000	22.107	QP

Note: Measure Level (dB $\mu$ V/m) = Reading Level (dB $\mu$ V) + Factor (dB)

Factor (dB) = Cable Loss (dB) + Antenna Factor (dB/m)

Engineer: Milo Li	
Site: AC1	Time: 2014/11/20 - 20:14
Limit: FCC_Part15.209_RE(3m)	Margin: 0
Probe: VULB9162_0.03-8GHz	Polarity: Vertical
EUT: iCOM Smart WiFi Module	Power: AC 120V/60Hz
<b>Worse Case Mode : 802.11b at Channel 2462MHz</b>	

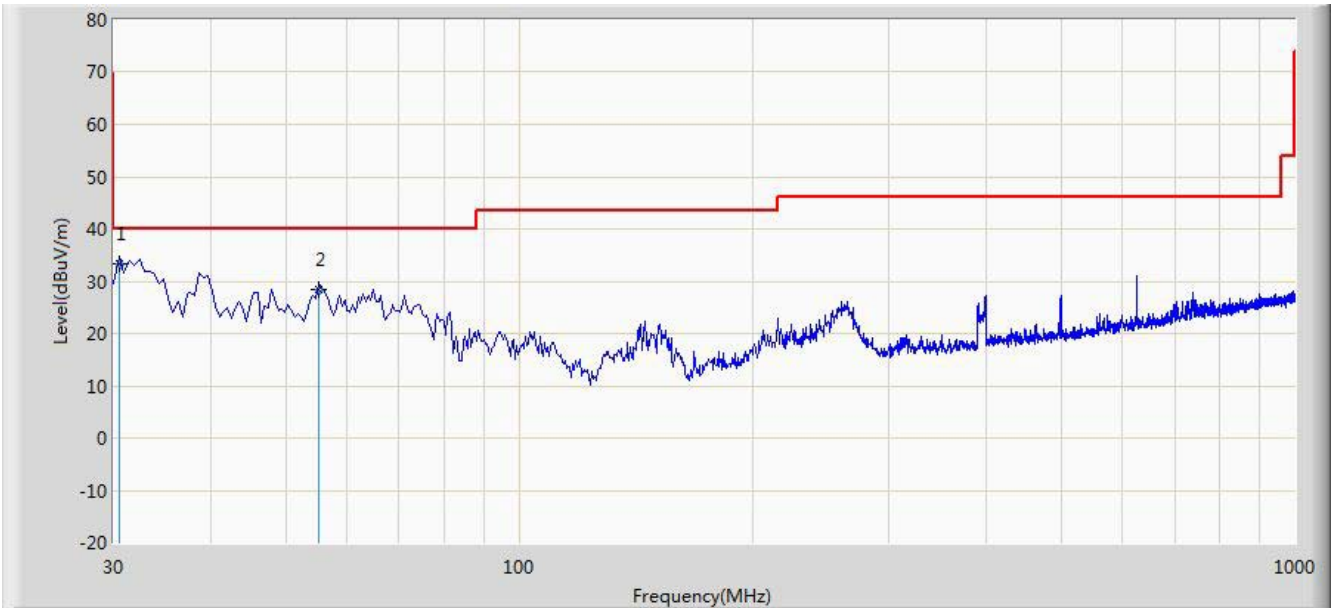

No	Frequency (MHz)	Measure Level (dBuV/m)	Reading Level (dBuV)	Over Limit (dB)	Limit (dBuV/m)	Factor (dB)	Type
1	30.501	33.202	21.210	-6.798	40.000	11.992	QP
2	55.231	28.406	13.941	-11.594	40.000	14.465	QP

Note: Measure Level (dBμV/m) = Reading Level (dBμV) + Factor (dB)

Factor (dB) = Cable Loss (dB) + Antenna Factor (dB/m)

Site: AC1	Time: 2014/11/20 - 15:32
Limit: FCC_Part15.209_RE(3m)	Engineer: Milo Li
Probe: FMZB1519_0.009-30MHz	Polarity: Face On
EUT: iCOM Smart WiFi Module	Power: AC 120V/60Hz

**Note: There is the ambient noise within frequency range 9kHz~30MHz.**

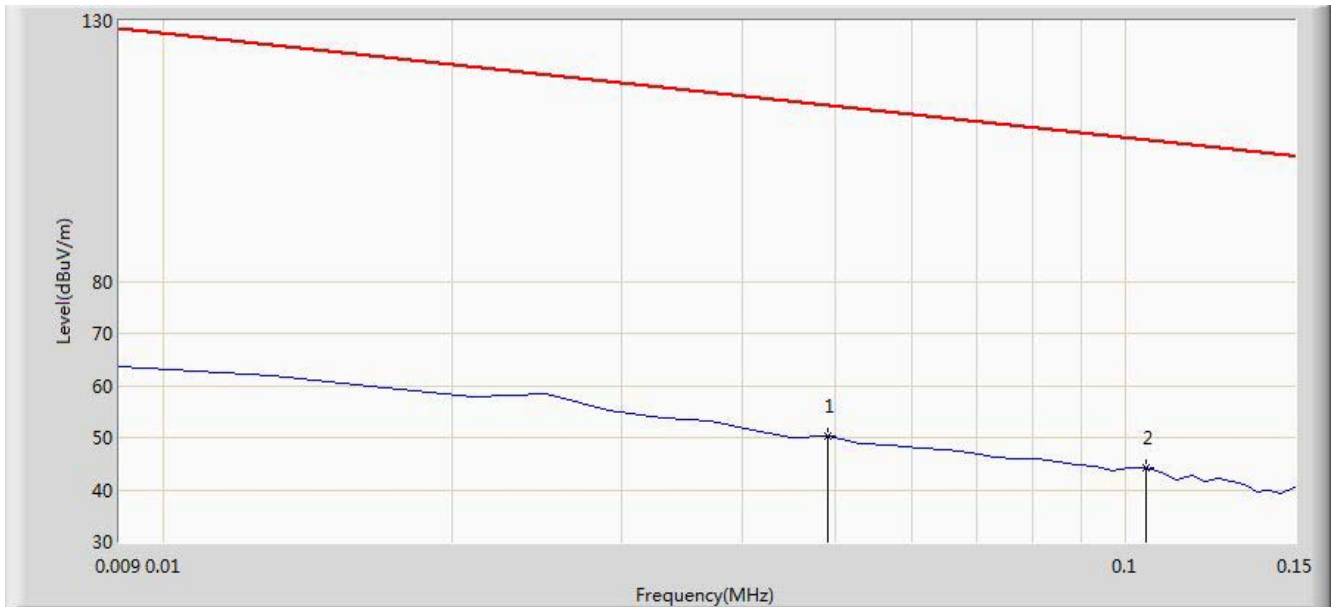

No	Frequency (MHz)	Measure Level (dBuV/m)	Reading Level (dBuV)	Over Limit (dB)	Limit (dBuV/m)	Factor (dB)	Type
1	0.049	50.367	29.861	-63.422	113.789	20.505	Peak
2	0.105	44.143	23.996	-63.029	107.173	20.147	QP

Note: Measure Level (dBμV/m) = Reading Level (dBμV) + Factor (dB)

Factor (dB) = Cable Loss (dB) + Antenna Factor (dB/m)



Site: AC1	Time: 2014/11/20 - 15:41
Limit: FCC_Part15.209_RE(3m)	Engineer: Milo Li
Probe: FMZB1519_0.009-30MHz	Polarity: Face On
EUT: iCOM Smart WiFi Module	Power: AC 120V/60Hz
<b>Note: There is the ambient noise within frequency range 9kHz~30MHz.</b>	

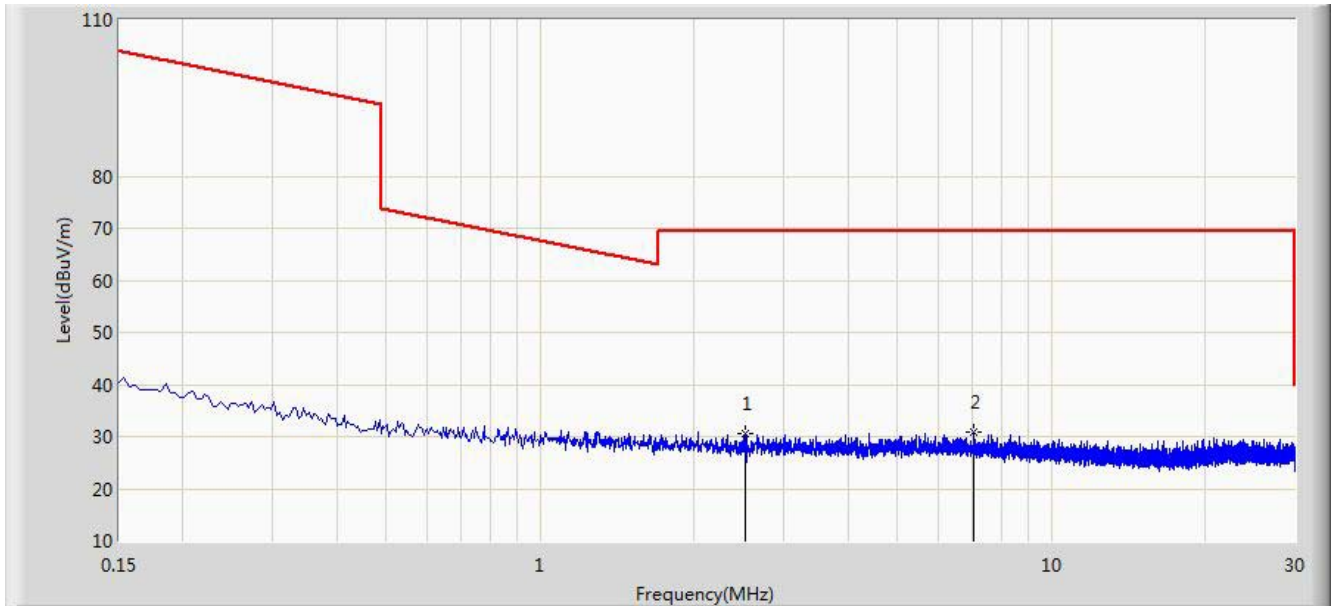

No	Frequency (MHz)	Measure Level (dBuV/m)	Reading Level (dBuV)	Over Limit (dB)	Limit (dBuV/m)	Factor (dB)	Type
1	2.513	30.495	10.336	-39.005	69.500	20.159	QP
2	7.041	30.974	10.579	-38.526	69.500	20.395	QP

Note: Measure Level (dBμV/m) = Reading Level (dBμV) + Factor (dB)

Factor (dB) = Cable Loss (dB) + Antenna Factor (dB/m)

Site: AC1	Time: 2014/11/20 - 15:45
Limit: FCC_Part15.209_RE(3m)	Engineer: Milo Li
Probe: BBHA9170_18-40GHz	Polarity: Horizontal
EUT: iCOM Smart WiFi Module	Power: AC 120V/60Hz
<b>Note: There is the ambient noise within frequency range 18 ~ 25GHz.</b>	

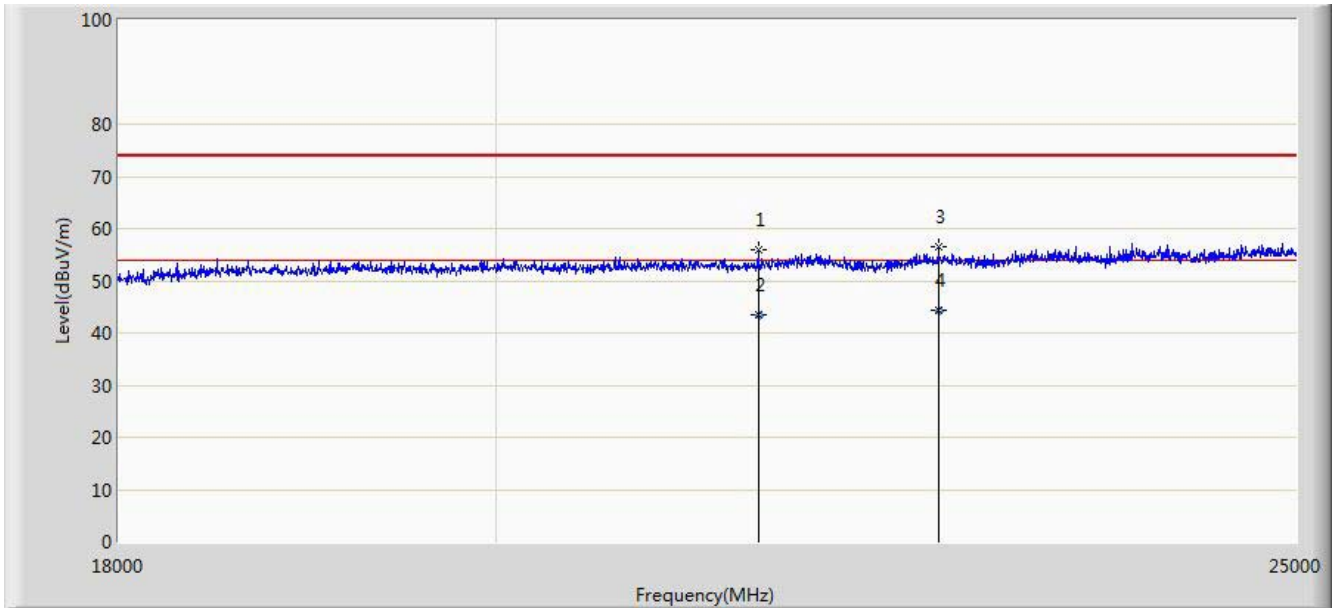

No	Frequency (MHz)	Measure Level (dBuV/m)	Reading Level (dBuV)	Over Limit (dB)	Limit (dBuV/m)	Factor (dB)	Type
1	21517.500	55.869	17.883	-18.131	74.000	37.986	PK
2	21517.650	43.351	5.365	-10.649	54.000	37.986	AV
3	22630.500	56.509	18.223	-17.491	74.000	38.286	PK
4	22630.540	44.310	6.024	-9.690	54.000	38.286	AV

Note: Measure Level (dBuV/m) = Reading Level (dBuV) + Factor (dB)

Factor (dB) = Cable Loss (dB) + Antenna Factor (dB/m)

Site: AC1	Time: 2014/11/20 - 15:59
Limit: FCC_Part15.209_RE(3m)	Engineer: Milo Li
Probe: BBHA9170_18-40GHz	Polarity: Vertical
EUT: iCOM Smart WiFi Module	Power: AC 120V/60Hz
<b>Note: There is the ambient noise within frequency range 18 ~ 25GHz.</b>	

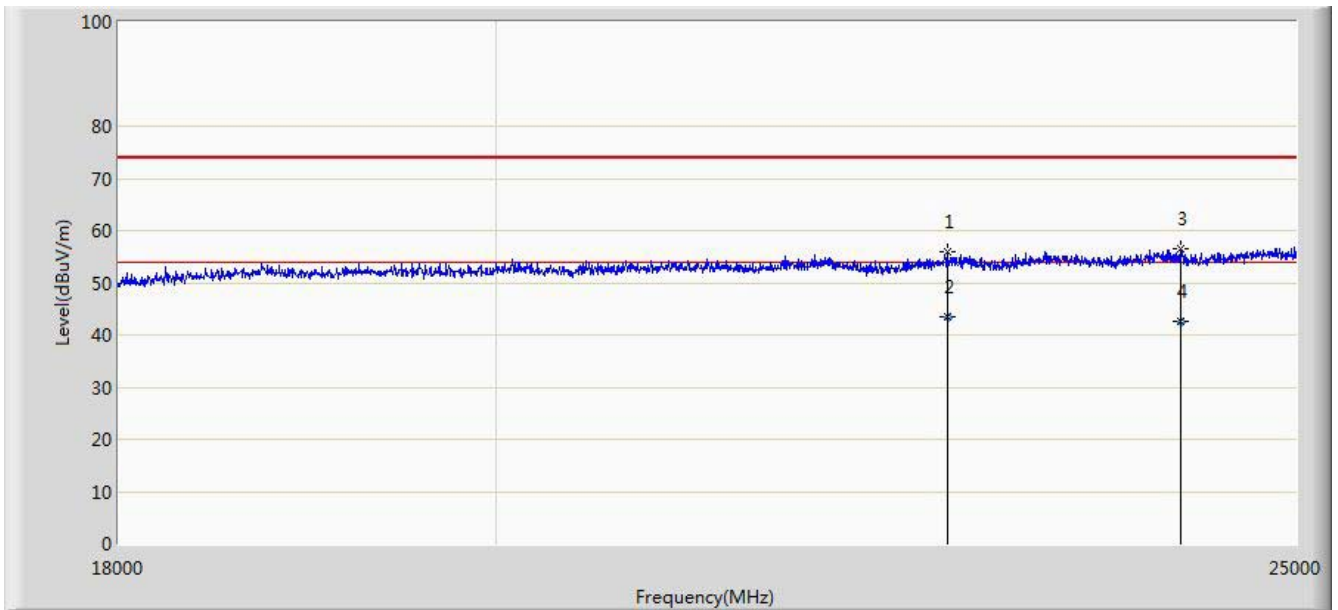

No	Frequency (MHz)	Measure Level (dBuV/m)	Reading Level (dBuV)	Over Limit (dB)	Limit (dBuV/m)	Factor (dB)	Type
1	22686.500	55.811	17.457	-18.189	74.000	38.354	PK
2	22686.540	43.598	5.244	-10.402	54.000	38.354	AV
3	24205.500	56.430	17.607	-17.570	74.000	38.823	PK
4	24205.658	42.518	3.695	-11.482	54.000	38.823	AV

Note: Measure Level (dBuV/m) = Reading Level (dBuV) + Factor (dB)

Factor (dB) = Cable Loss (dB) + Antenna Factor (dB/m)

## 7.7. Radiated Restricted Band Edge Measurement

### 7.7.1. Test Result

Site: AC1	Time: 2014/11/20 - 10:13
Limit: FCC_Part15.209_RE(3m)	Engineer: Milo Li
Probe: BBHA9120D_1-18GHz	Polarity: Horizontal
EUT: iCOM Smart WiFi Module	Power: AC 120V/60Hz
<b>Worse Case Mode : 802.11g at channel 2412MHz</b>	

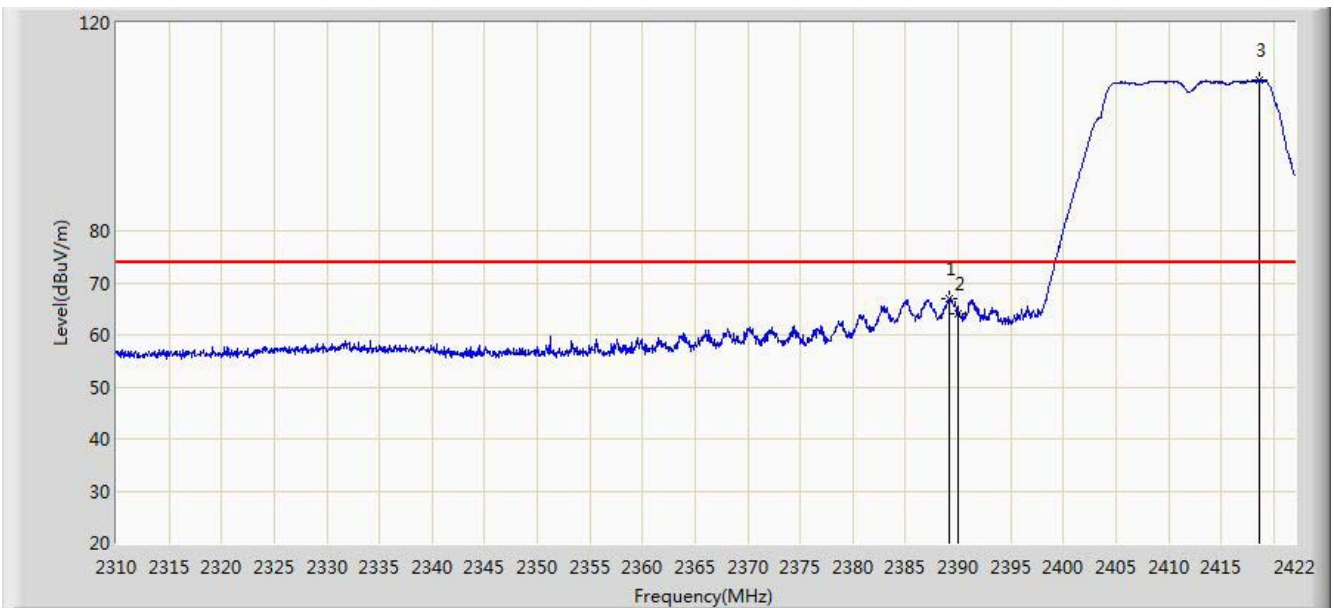

No	Frequency (MHz)	Measure Level (dBuV/m)	Reading Level (dBuV)	Over Limit (dB)	Limit (dBuV/m)	Factor (dB)	Type
1	2389.184	67.000	36.314	-7.000	74.000	30.686	PK
2	2390.000	64.044	33.360	-9.956	74.000	30.684	PK
3	2418.696	109.049	78.415	N/A	N/A	30.634	PK

Note: Measure Level (dBμV/m) = Reading Level (dBμV) + Factor (dB)

Factor (dB) = Cable Loss (dB) + Antenna Factor (dB/m)

Site: AC1	Time: 2014/11/20 - 10:16
Limit: FCC_Part15.209_RE(3m)	Engineer: Milo Li
Probe: BBHA9120D_1-18GHz	Polarity: Horizontal
EUT: iCOM Smart WiFi Module	Power: AC 120V/60Hz
<b>Worse Case Mode : 802.11g at channel 2412MHz</b>	

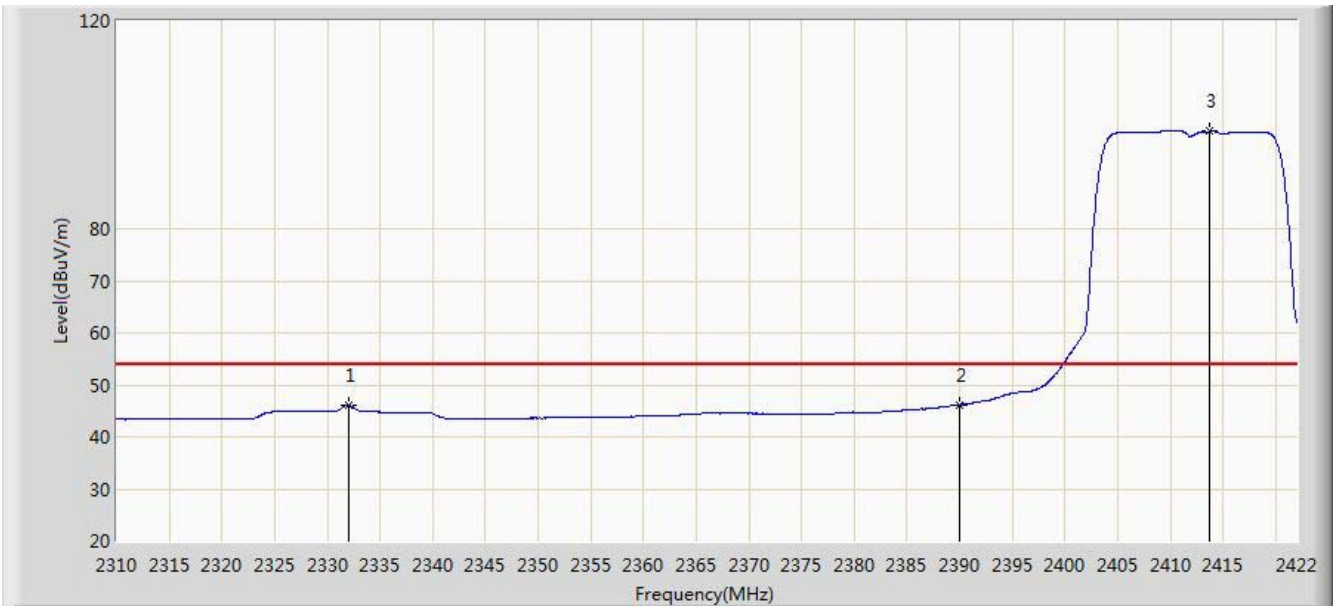

No	Frequency (MHz)	Measure Level (dBuV/m)	Reading Level (dBuV)	Over Limit (dB)	Limit (dBuV/m)	Factor (dB)	Type
1	2332.064	46.168	15.310	-7.832	54.000	30.858	AV
2	2390.000	46.169	15.485	-7.831	54.000	30.684	AV
3	2413.768	98.743	68.101	N/A	N/A	30.642	AV

Note: Measure Level (dBμV/m) = Reading Level (dBμV) + Factor (dB)

Factor (dB) = Cable Loss (dB) + Antenna Factor (dB/m)

Site: AC1	Time: 2014/11/20 - 10:17
Limit: FCC_Part15.209_RE(3m)	Engineer: Milo Li
Probe: BBHA9120D_1-18GHz	Polarity: Vertical
EUT: iCOM Smart WiFi Module	Power: AC 120V/60Hz
<b>Worse Case Mode : 802.11g at channel 2412MHz</b>	

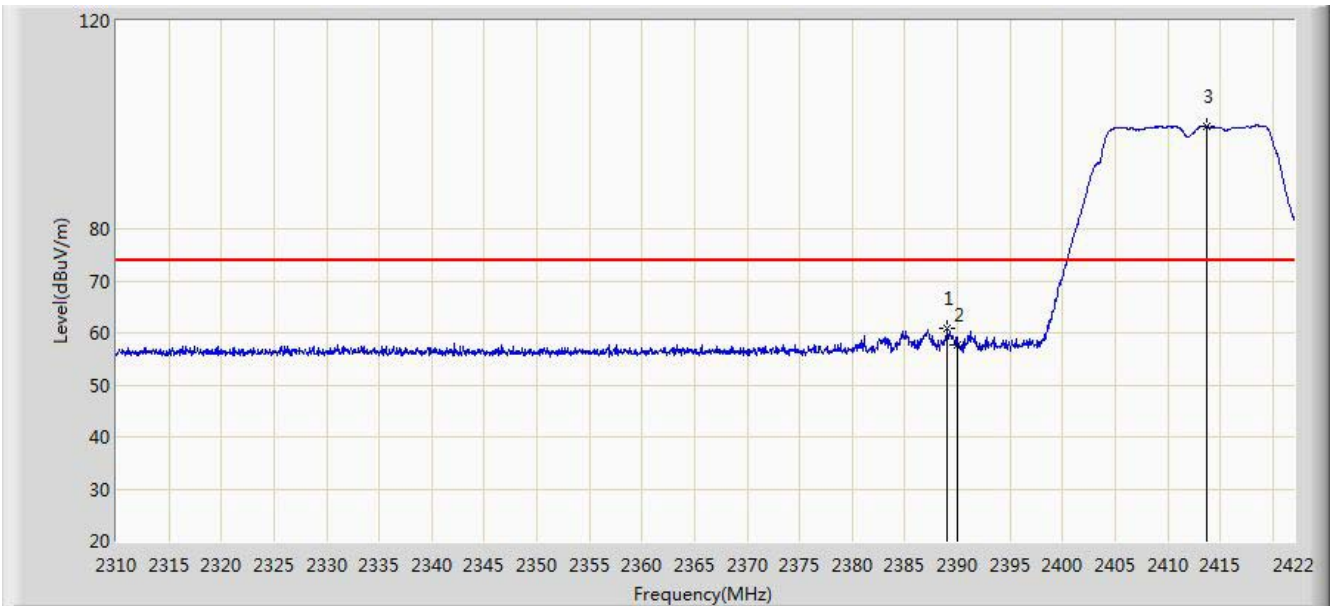

No	Frequency (MHz)	Measure Level (dBuV/m)	Reading Level (dBuV)	Over Limit (dB)	Limit (dBuV/m)	Factor (dB)	Type
1	2389.072	60.881	30.195	-13.119	74.000	30.686	PK
2	2390.000	57.695	27.011	-16.305	74.000	30.684	PK
3	2413.768	99.668	69.026	N/A	N/A	30.642	PK

Note: Measure Level (dBμV/m) = Reading Level (dBμV) + Factor (dB)

Factor (dB) = Cable Loss (dB) + Antenna Factor (dB/m)

Site: AC1	Time: 2014/11/20 - 10:20
Limit: FCC_Part15.209_RE(3m)	Engineer: Milo Li
Probe: BBHA9120D_1-18GHz	Polarity: Vertical
EUT: iCOM Smart WiFi Module	Power: AC 120V/60Hz
<b>Worse Case Mode : 802.11g at channel 2412MHz</b>	

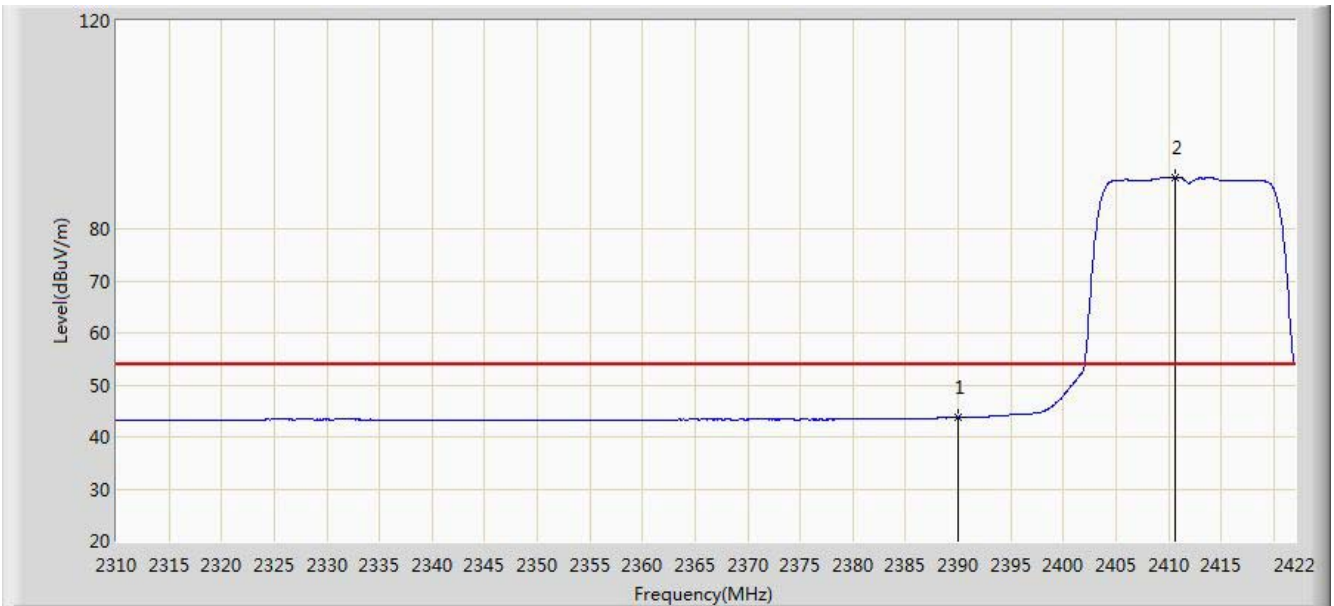

No	Frequency (MHz)	Measure Level (dBuV/m)	Reading Level (dBuV)	Over Limit (dB)	Limit (dBuV/m)	Factor (dB)	Type
1	2390.000	43.685	13.001	-10.315	54.000	30.684	AV
2	2410.632	89.889	59.242	N/A	N/A	30.647	AV

Note: Measure Level (dBμV/m) = Reading Level (dBμV) + Factor (dB)

Factor (dB) = Cable Loss (dB) + Antenna Factor (dB/m)

Site: AC1	Time: 2014/11/20 - 10:51
Limit: FCC_Part15.209_RE(3m)	Engineer: Milo Li
Probe: BBHA9120D_1-18GHz	Polarity: Horizontal
EUT: iCOM Smart WiFi Module	Power: AC 120V/60Hz
<b>Worse Case Mode : 802.11n-HT40 at channel 2452MHz</b>	

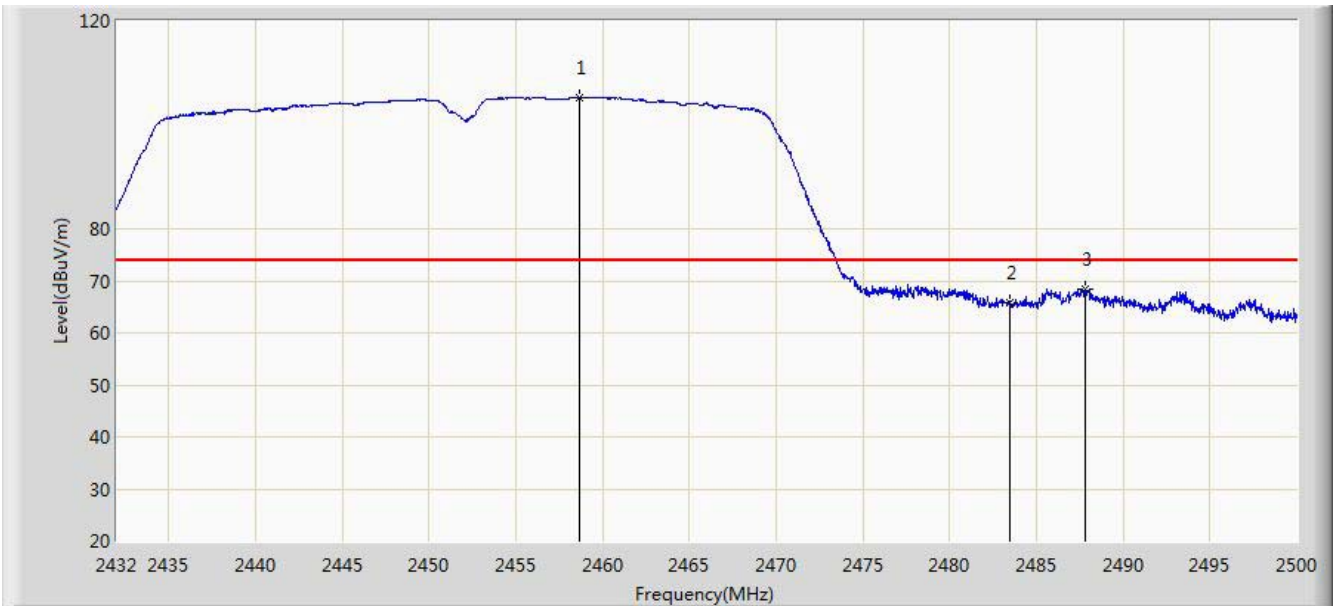

No	Frequency (MHz)	Measure Level (dBuV/m)	Reading Level (dBuV)	Over Limit (dB)	Limit (dBuV/m)	Factor (dB)	Type
1	2458.690	105.255	74.649	N/A	N/A	30.606	PK
2	2483.500	65.925	35.252	-8.075	74.000	30.673	PK
3	2487.828	68.508	37.823	-5.492	74.000	30.685	PK

Note: Measure Level (dBμV/m) = Reading Level (dBμV) + Factor (dB)

Factor (dB) = Cable Loss (dB) + Antenna Factor (dB/m)



Site: AC1	Time: 2014/11/20 - 10:54
Limit: FCC_Part15.209_RE(3m)	Engineer: Milo Li
Probe: BBHA9120D_1-18GHz	Polarity: Horizontal
EUT: iCOM Smart WiFi Module	Power: AC 120V/60Hz
<b>Worse Case Mode : 802.11n-HT40 at channel 2452MHz</b>	

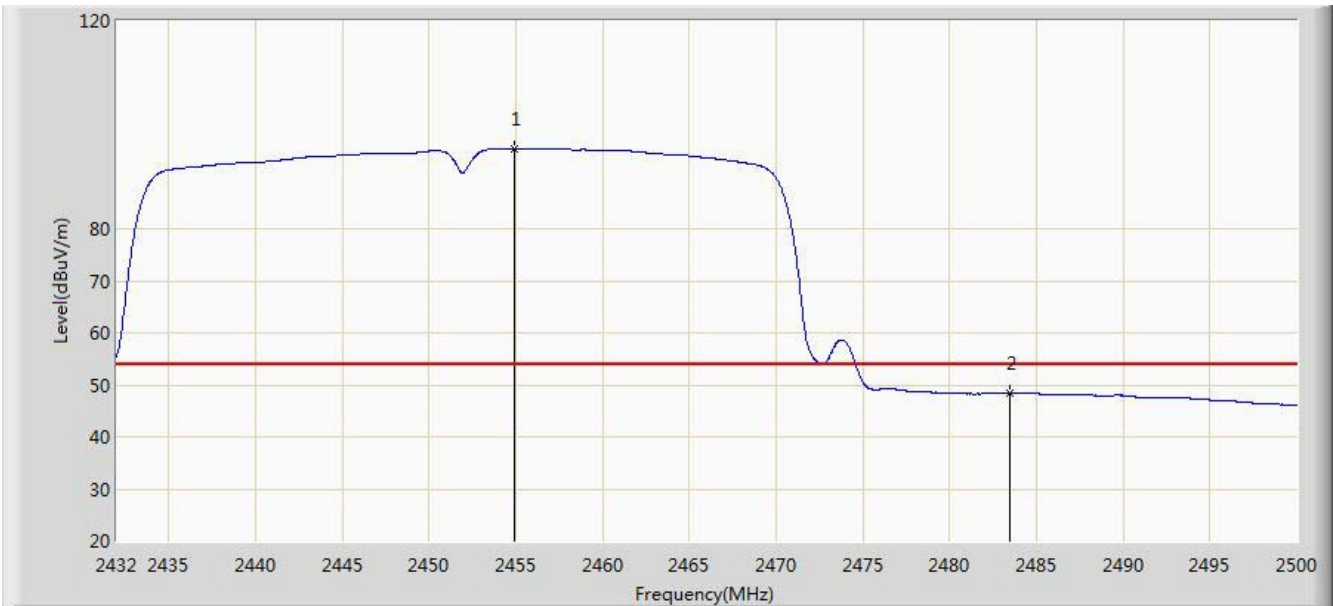

No	Frequency (MHz)	Measure Level (dBuV/m)	Reading Level (dBuV)	Over Limit (dB)	Limit (dBuV/m)	Factor (dB)	Type
1	2454.916	95.342	64.741	N/A	N/A	30.601	AV
2	2483.500	48.388	17.715	-5.612	54.000	30.673	AV

Note: Measure Level (dBμV/m) = Reading Level (dBμV) + Factor (dB)

Factor (dB) = Cable Loss (dB) + Antenna Factor (dB/m)

Site: AC1	Time: 2014/11/20 - 10:54
Limit: FCC_Part15.209_RE(3m)	Engineer: Milo Li
Probe: BBHA9120D_1-18GHz	Polarity: Vertical
EUT: iCOM Smart WiFi Module	Power: AC 120V/60Hz
<b>Worse Case Mode : 802.11n-HT40 at channel 2452MHz</b>	

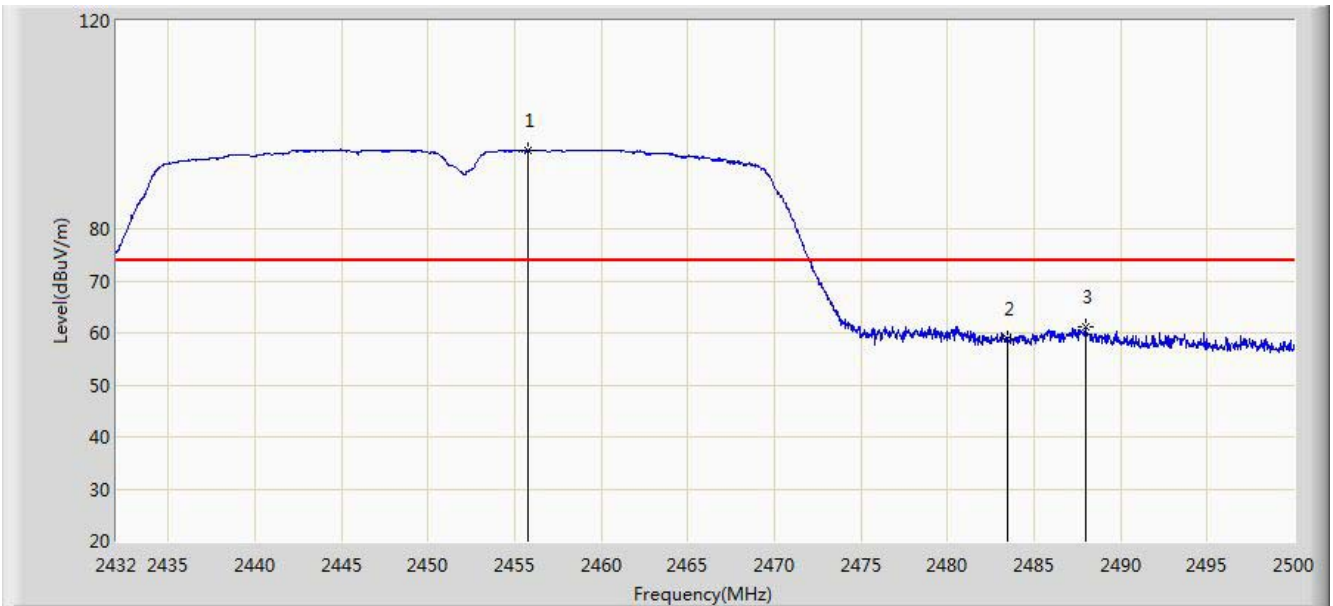

No	Frequency (MHz)	Measure Level (dBuV/m)	Reading Level (dBuV)	Over Limit (dB)	Limit (dBuV/m)	Factor (dB)	Type
1	2455.800	95.027	64.425	N/A	N/A	30.602	PK
2	2483.500	58.982	28.309	-15.018	74.000	30.673	PK
3	2487.964	61.032	30.346	-12.968	74.000	30.686	PK

Note: Measure Level (dBμV/m) = Reading Level (dBμV) + Factor (dB)

Factor (dB) = Cable Loss (dB) + Antenna Factor (dB/m)

Site: AC1	Time: 2014/11/20 - 10:58
Limit: FCC_Part15.209_RE(3m)	Engineer: Milo Li
Probe: BBHA9120D_1-18GHz	Polarity: Vertical
EUT: iCOM Smart WiFi Module	Power: AC 120V/60Hz
<b>Worse Case Mode : 802.11n-HT40 at channel 2452MHz</b>	

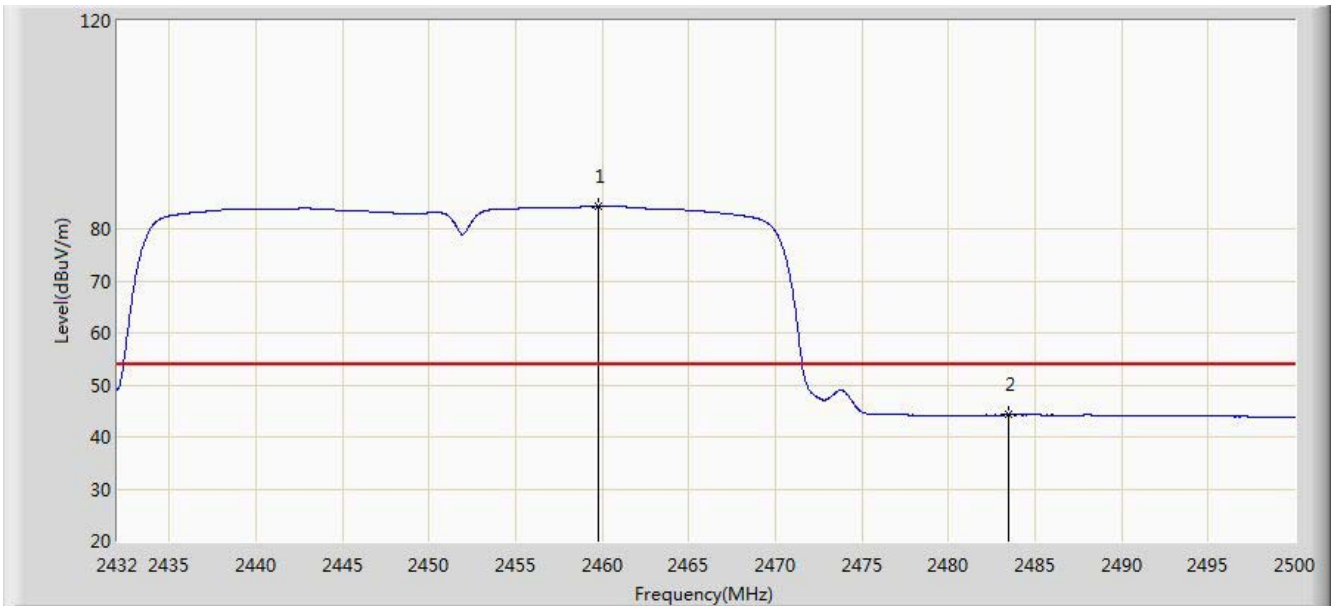

No	Frequency (MHz)	Measure Level (dBuV/m)	Reading Level (dBuV)	Over Limit (dB)	Limit (dBuV/m)	Factor (dB)	Type
1	2459.778	84.230	53.622	N/A	N/A	30.608	AV
2	2483.500	44.246	13.573	-9.754	54.000	30.673	AV

Note: Measure Level (dB $\mu$ V/m) = Reading Level (dB $\mu$ V) + Factor (dB)

Factor (dB) = Cable Loss (dB) + Antenna Factor (dB/m)

## 7.8. AC Conducted Emissions Measurement

### 7.8.1. Test Limit

FCC Part 15 Subpart C Paragraph 15.207 Limits		
Frequency (MHz)	QP (dBuV)	AV (dBuV)
0.15 - 0.50	66 - 56	56 - 46
0.50 - 5.0	56	46
5.0 - 30	60	50

Note 1: The lower limit shall apply at the transition frequencies.

Note 2: The limit decreases linearly with the logarithm of the frequency in the range 0.15MHz to 0.5MHz.

### 7.8.2. Test Setup

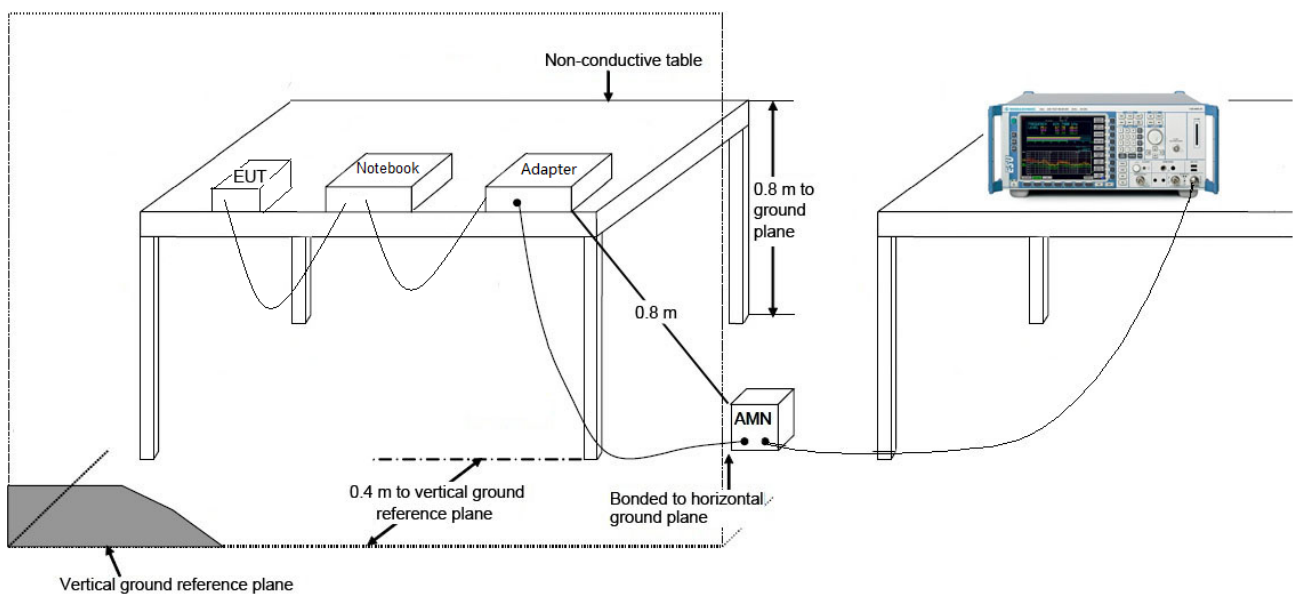

### 7.8.3. Test Result

Site: SR2	Time: 2014/11/20 - 22:25
Limit: FCC_Part15.207_CE_AC Power	Engineer: Knight Lu
Probe: ENV216_101683_Filter On	Polarity: Line
EUT: iCOM Smart WiFi Module	Power: AC 120V/60Hz
Note: Mode1	

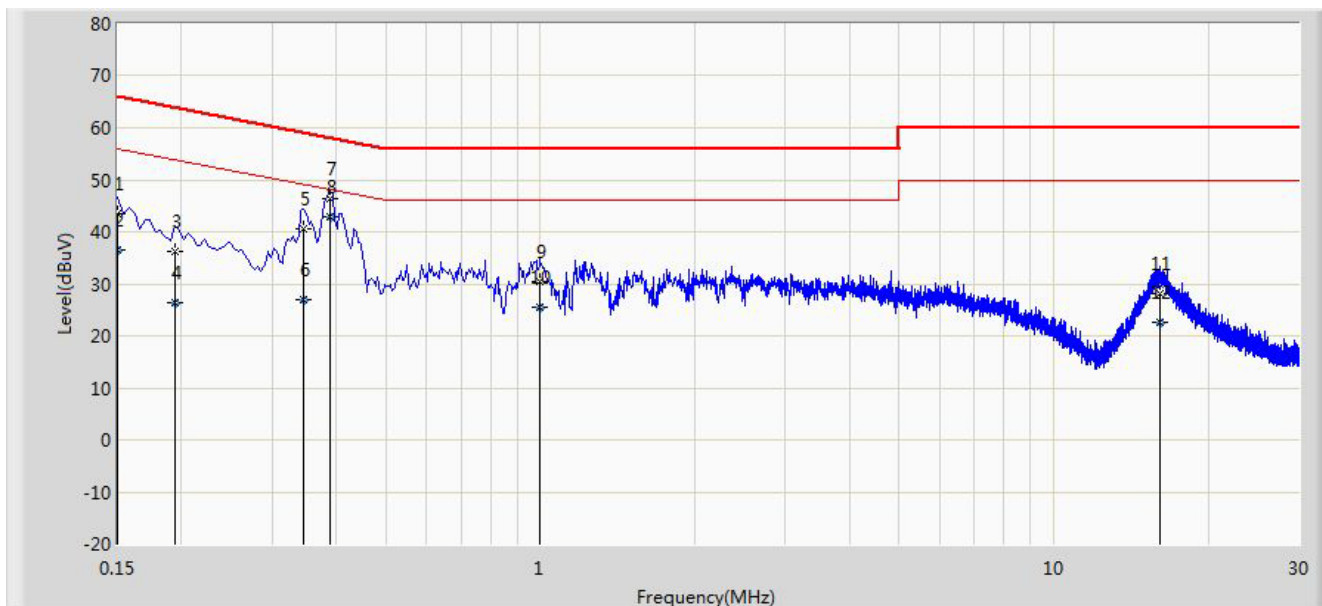

No	Frequency (MHz)	Measure Level (dBuV)	Reading Level (dBuV)	Over Limit (dB)	Limit (dBuV)	Factor (dB)	Type
1	0.150	43.528	32.360	-22.472	66.000	11.168	QP
2	0.150	36.473	25.305	-19.527	56.000	11.168	AV
3	0.194	36.229	26.212	-27.635	63.864	10.017	QP
4	0.194	26.436	16.419	-27.428	53.864	10.017	AV
5	0.346	40.514	30.473	-18.544	59.058	10.041	QP
6	0.346	26.859	16.818	-22.199	49.058	10.041	AV
7	0.390	46.416	36.339	-11.648	58.064	10.077	QP
8	0.390	42.771	32.694	-5.293	48.064	10.077	AV
9	0.998	30.469	20.559	-25.531	56.000	9.910	QP
10	0.998	25.535	15.625	-20.465	46.000	9.910	AV
11	16.098	28.090	18.017	-31.910	60.000	10.073	QP
12	16.098	22.704	12.631	-27.296	50.000	10.073	AV

Note: Measure Level (dBμV) = Reading Level (dBμV) + Factor (dB)

Factor (dB) = Cable Loss (dB) + LISN Factor (dB)

Site: SR2	Time: 2014/11/20 - 22:30
Limit: FCC_Part15.207_CE_AC Power	Engineer: Knight Lu
Probe: ENV216_101683_Filter On	Polarity: Neutral
EUT: iCOM Smart WiFi Module	Power: AC 120V/60Hz
Note: Mode1	

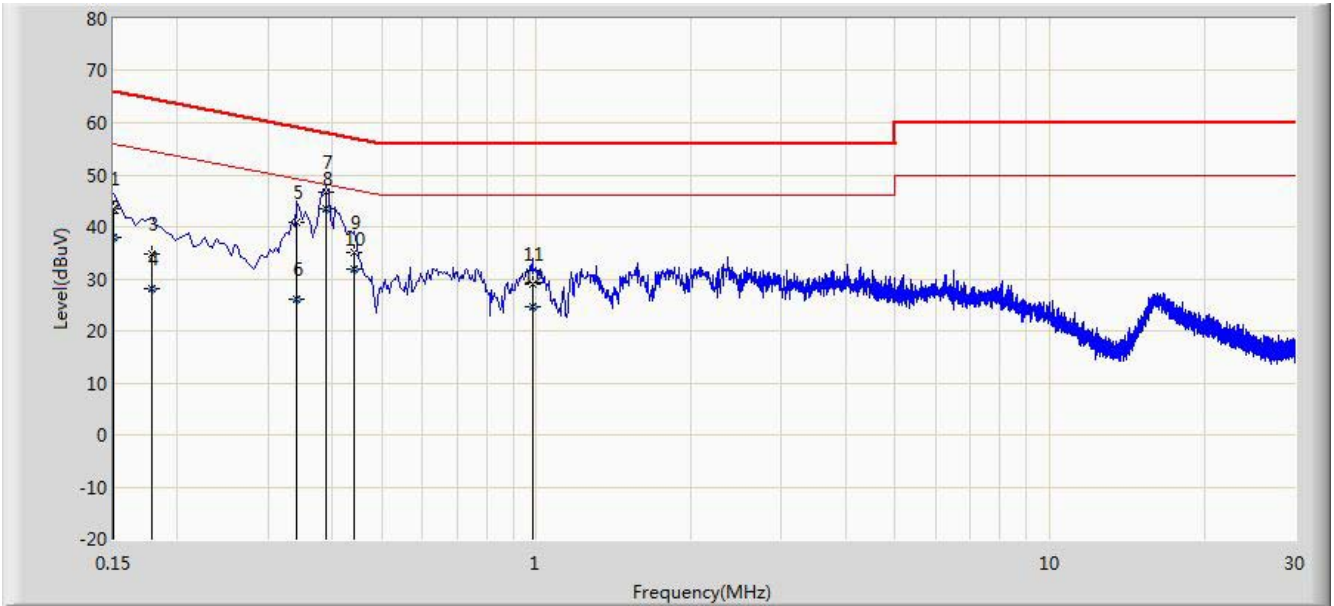

No	Frequency (MHz)	Measure Level (dBuV)	Reading Level (dBuV)	Over Limit (dB)	Limit (dBuV)	Factor (dB)	Type
1	0.150	43.495	32.353	-22.505	66.000	11.142	QP
2	0.150	37.877	26.735	-18.123	56.000	11.142	AV
3	0.178	34.843	24.794	-29.021	64.578	10.049	QP
4	0.178	28.151	18.102	-25.713	54.578	10.049	AV
5	0.342	40.950	30.881	-18.108	59.155	10.069	QP
6	0.342	26.195	16.126	-22.863	49.155	10.069	AV
7	0.390	46.617	36.512	-11.447	58.064	10.105	QP
8	0.390	43.525	33.420	-4.539	48.064	10.105	AV
9	0.442	35.047	24.903	-20.953	57.024	10.144	QP
10	0.442	31.788	21.644	-14.212	47.024	10.144	AV
11	0.982	28.957	19.039	-31.043	56.000	9.918	QP
12	0.982	24.529	14.611	-25.471	46.000	9.918	AV

Note: Measure Level (dBμV) = Reading Level (dBμV) + Factor (dB)

Factor (dB) = Cable Loss (dB) + LISN Factor (dB)

## 8. CONCLUSION

The data collected relate only the item(s) tested and show that the **iCOM Smart WiFi Module FCC ID: QWOWFM210** is in compliance with Part 15C of the FCC Rules.

————— The End —————