

---

# 1. Project specification

NC	Content	Page Number
1	Project specification	1
2	Electrical performance test report	2
3	Product graph	2
4	Network analyzer graph	3
5	Efficiency and Gain test results	4
6	Radiation pattern	5

## 2. Electrical performance test report

Frequency	2.402GHz-2.48GHz
Impedance	50 $\Omega$ hm
VSWR	2.0 MAX
Return Loss	-40dB Max
Radiation	Omni-directional
Gain(peak)	3.3 dBi
Polarization	Linear. Vertical
Type of antenna	PCB Antenna

## 3. Product graph

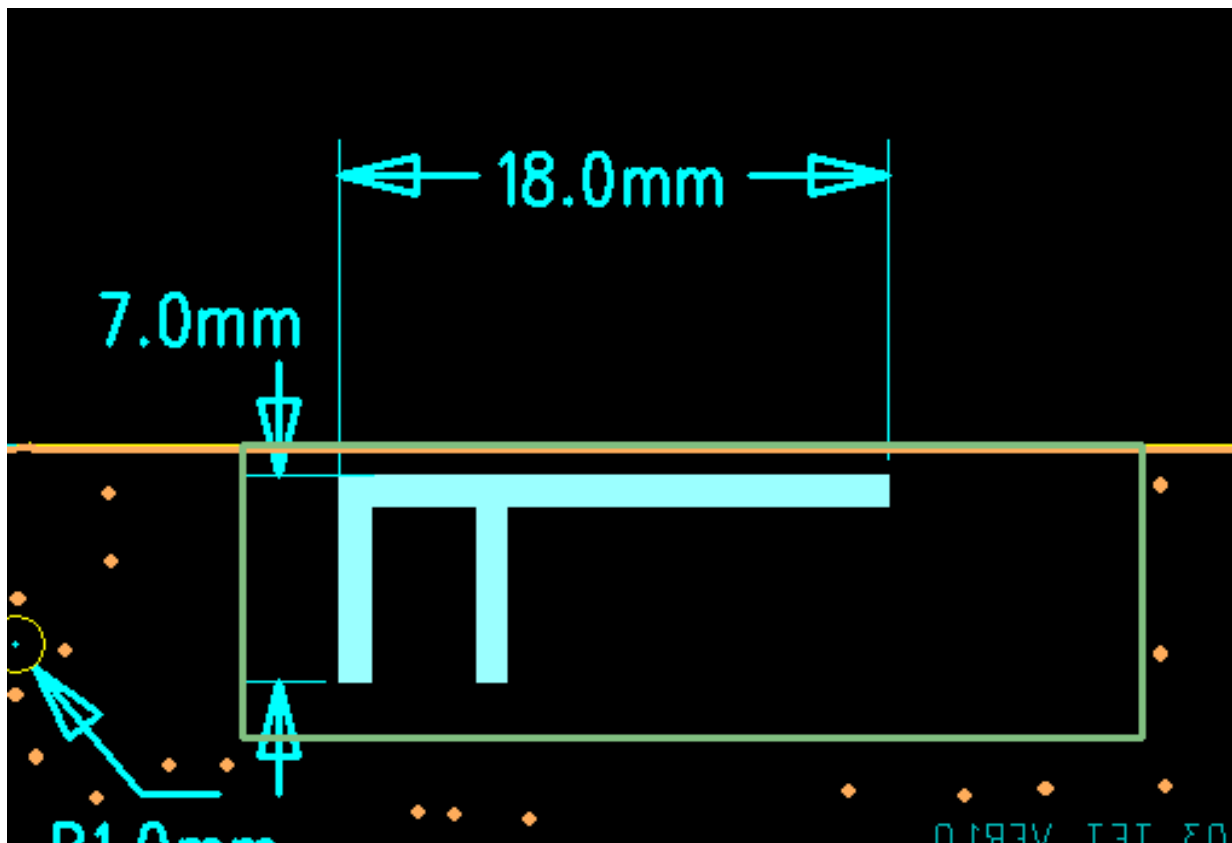

# 4. Network analyzer graph

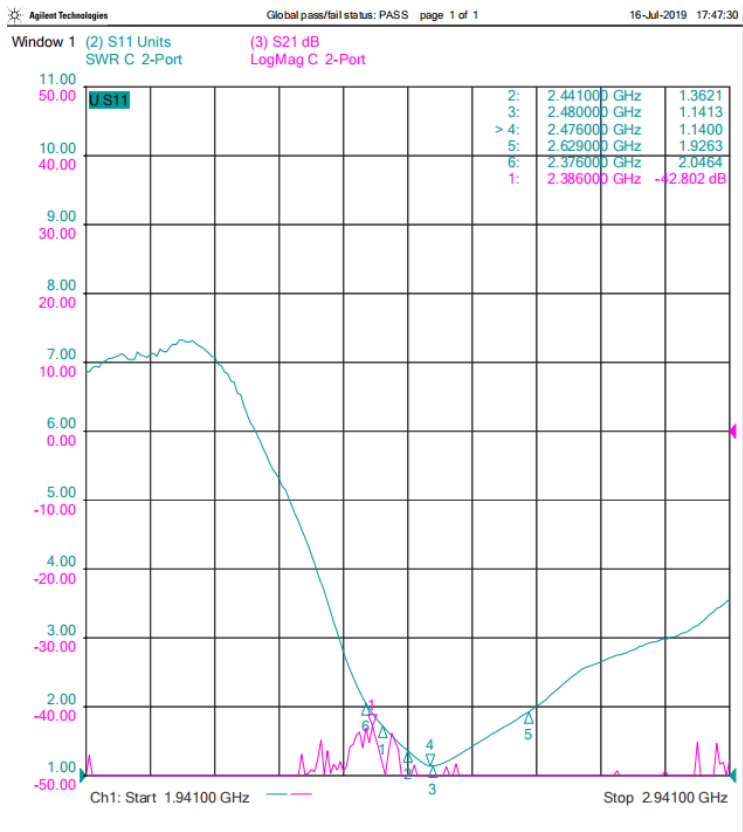
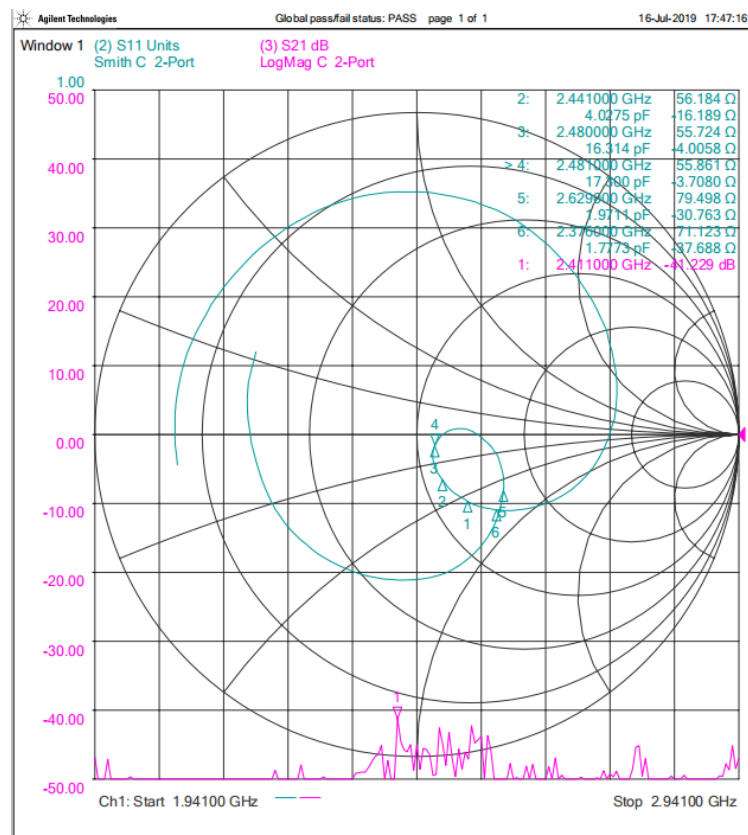
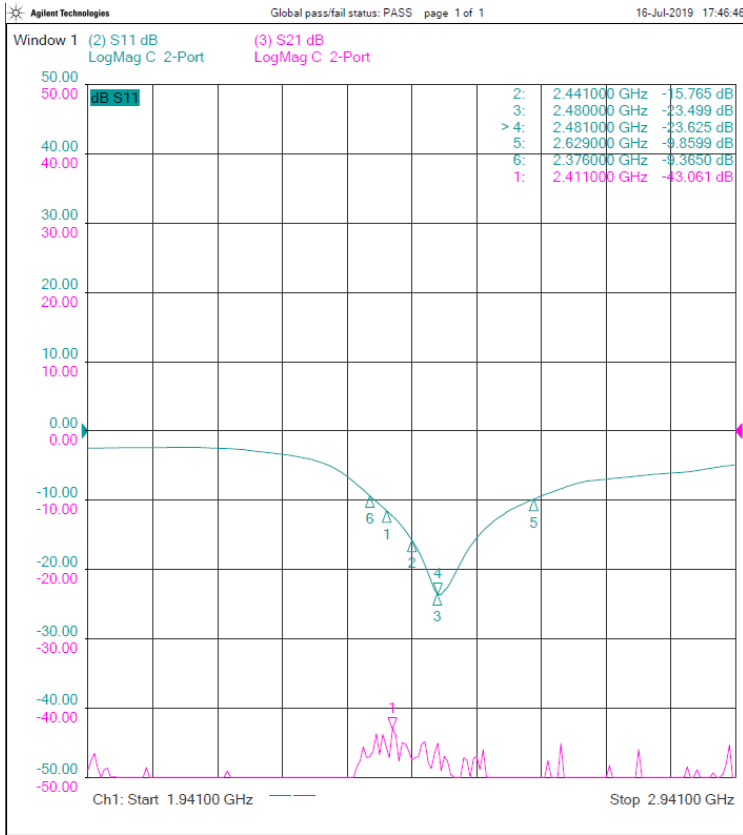

## 5. Efficiency and Gain test results

Frequency: 2.402-2.480GHz			
Frequency Point (MHz)	Efficiency (%)	Efficiency (dB )	Gain (dBi)
2400	60.56%	-2.2	3.1
2410	61.20%	-2.1	3.1
2420	65.76%	-1.8	3.3
2430	65.29%	-1.9	3.2
2440	61.95%	-2.1	2.8
2450	63.69%	-2.0	2.8
2460	63.38%	-2.0	2.6
2470	69.39%	-1.6	2.9
2480	73.52%	-1.3	3.1
Mean value	64.97%	-1.88	2.98

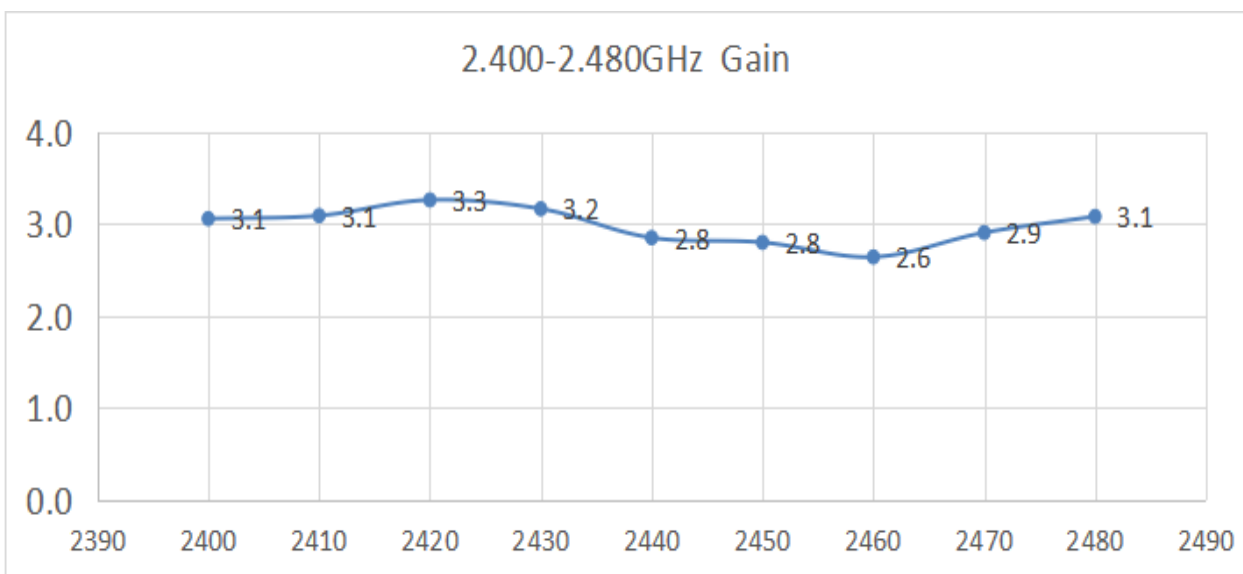
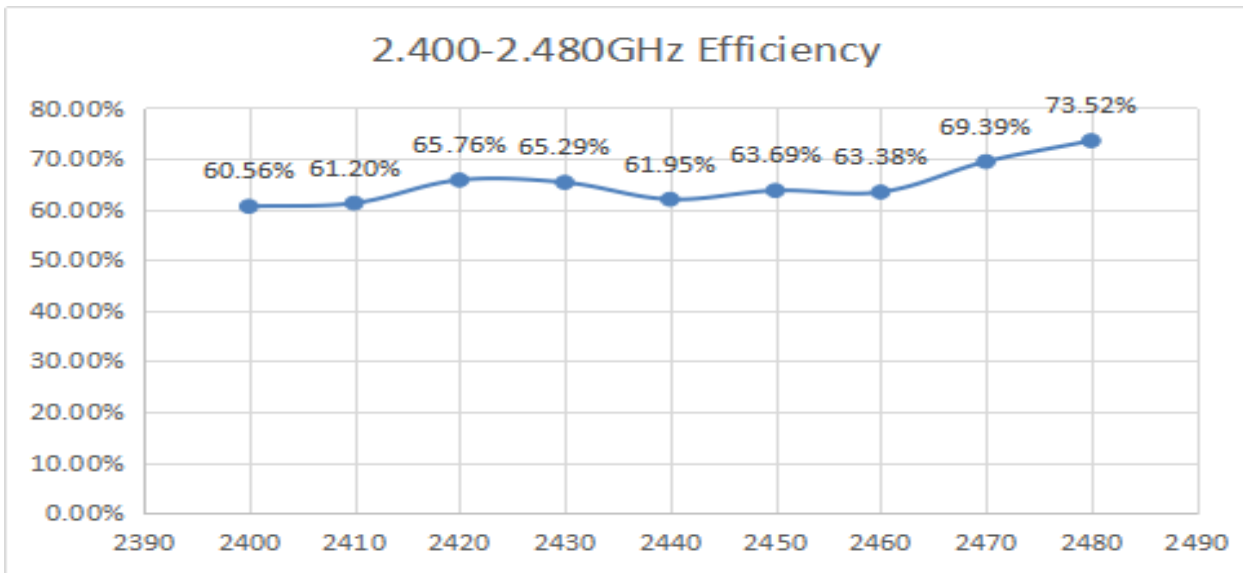

# 6. Radiation pattern

3D Diagram:

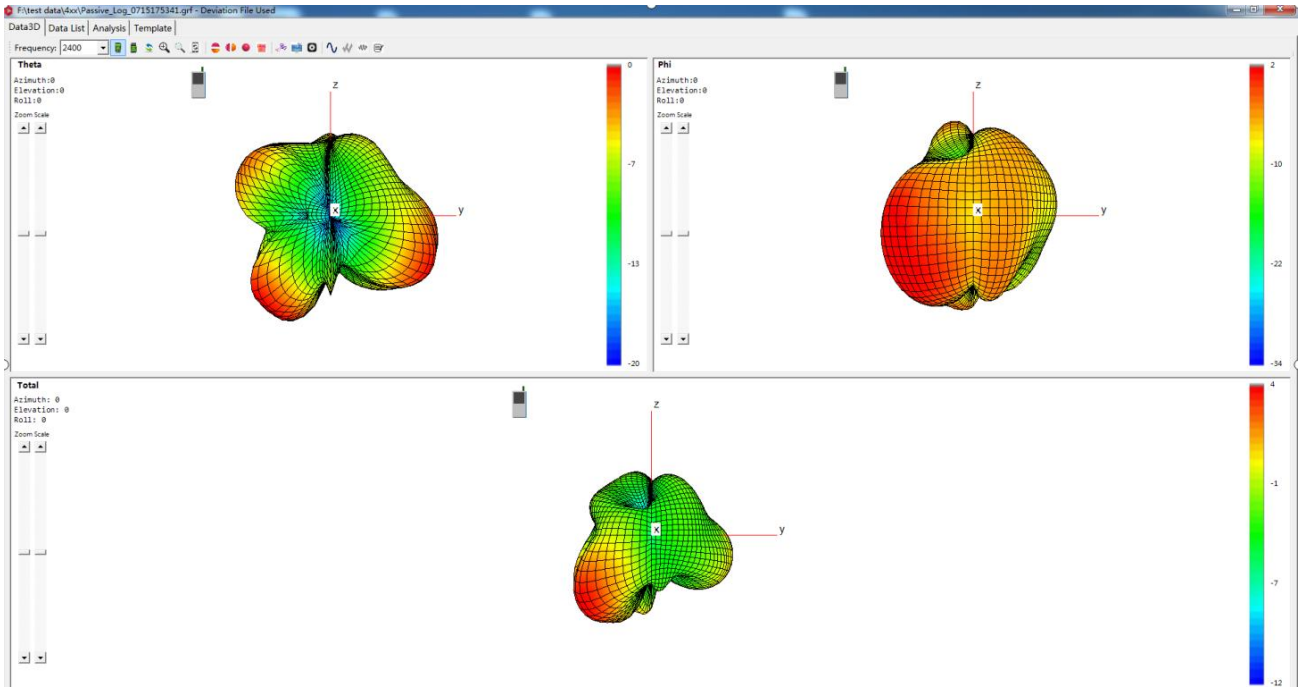

2. 400GHZ Diagram:

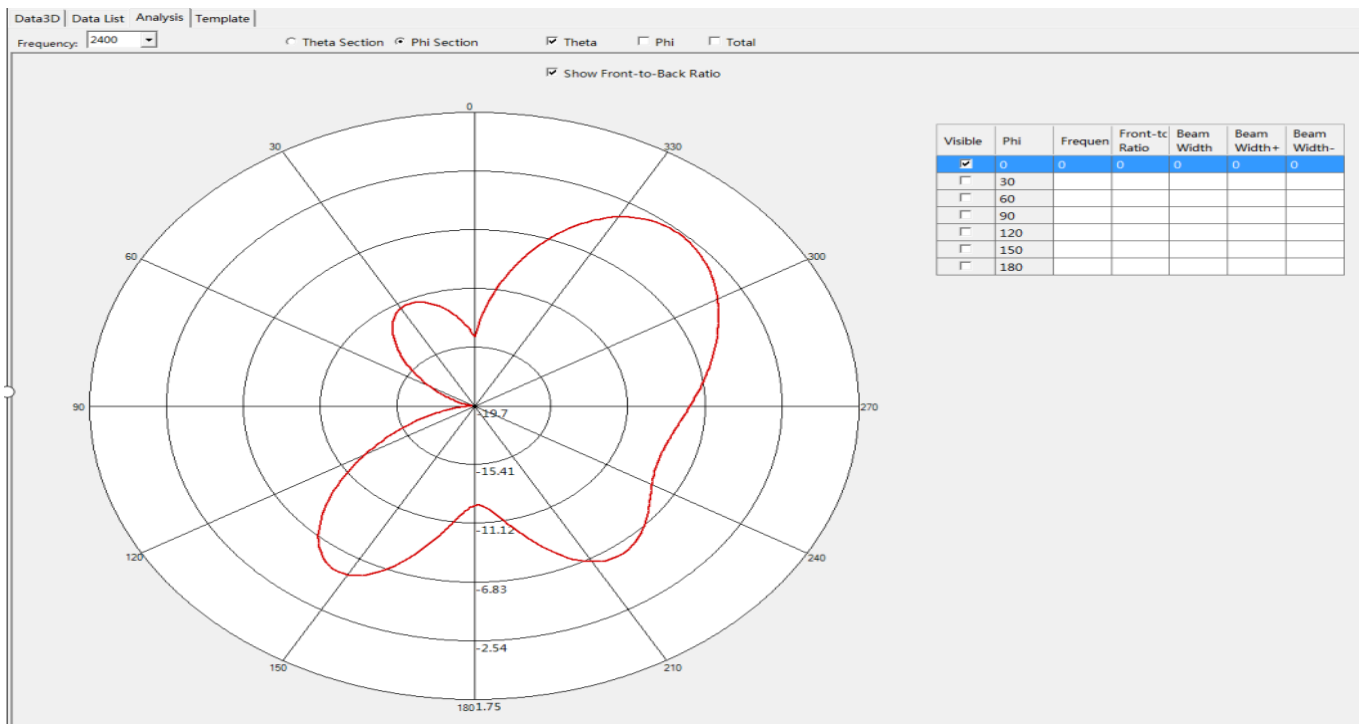

(Theta 0)

(Phi 0)

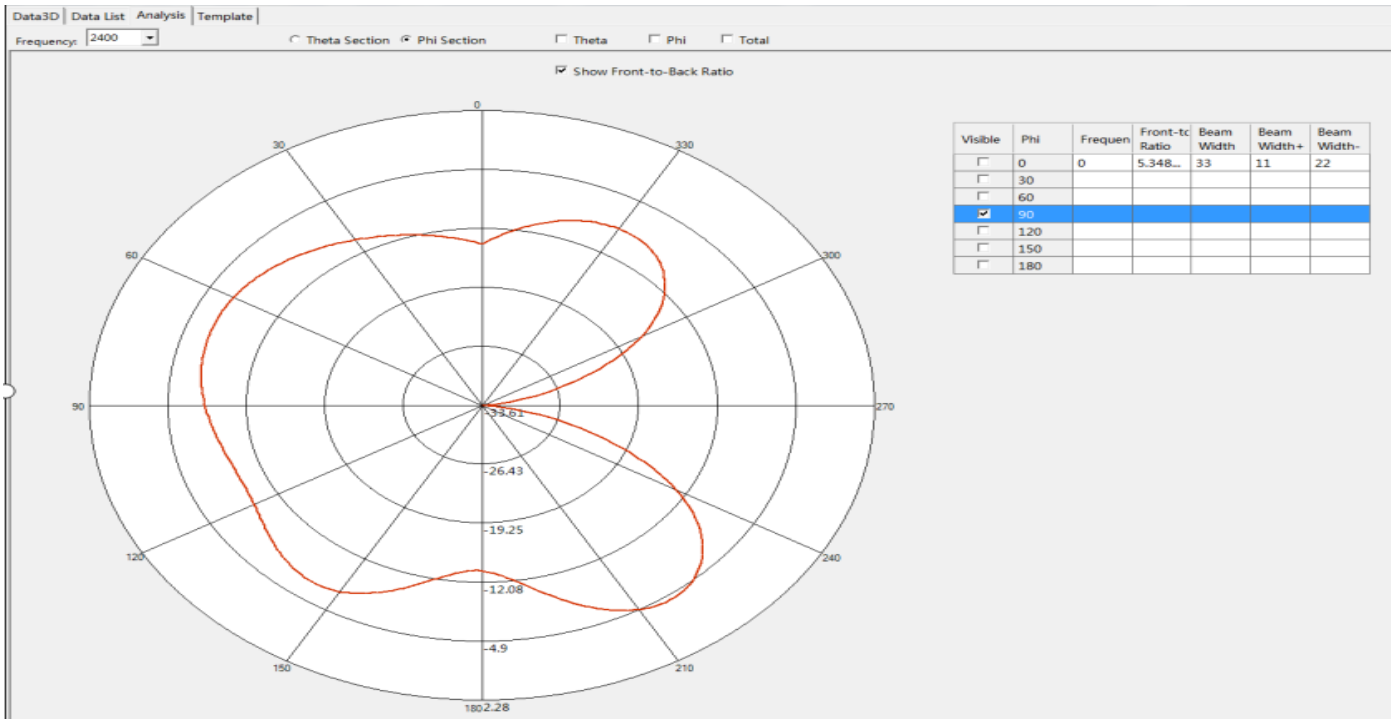
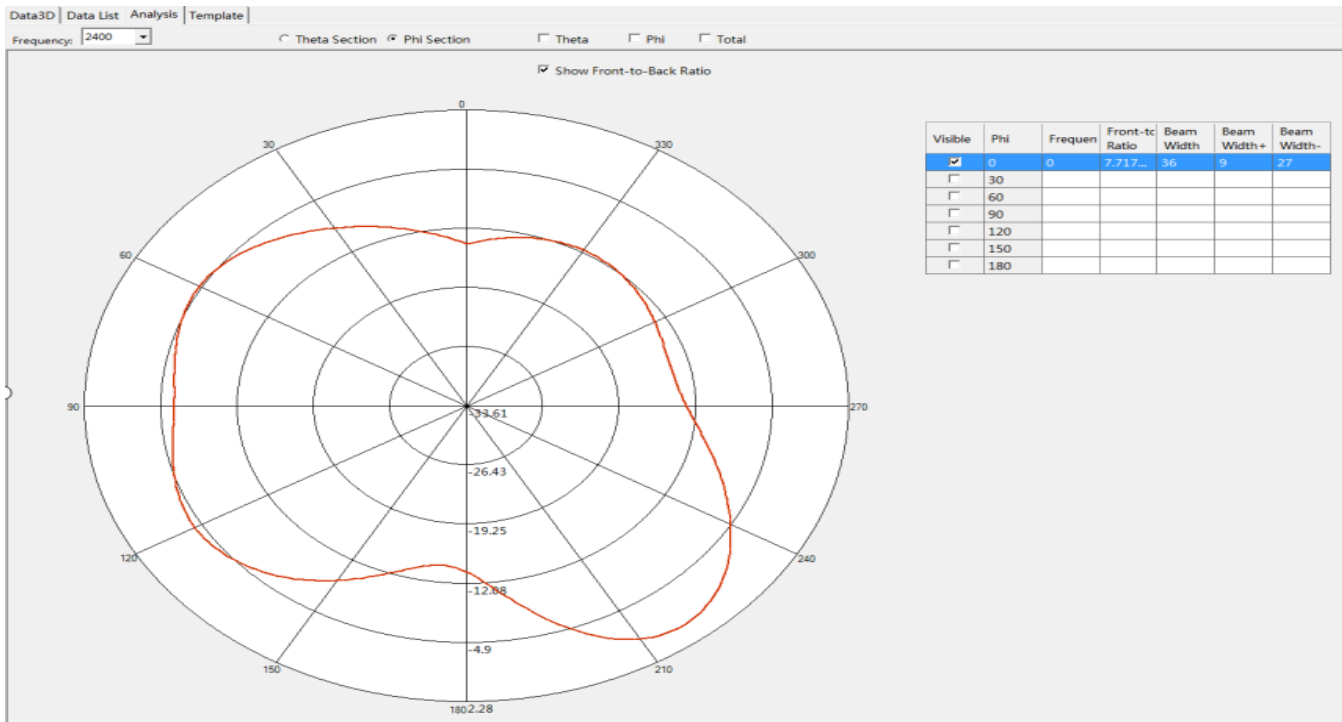

(Phi 90)

## 2. 440GHz Diagram:

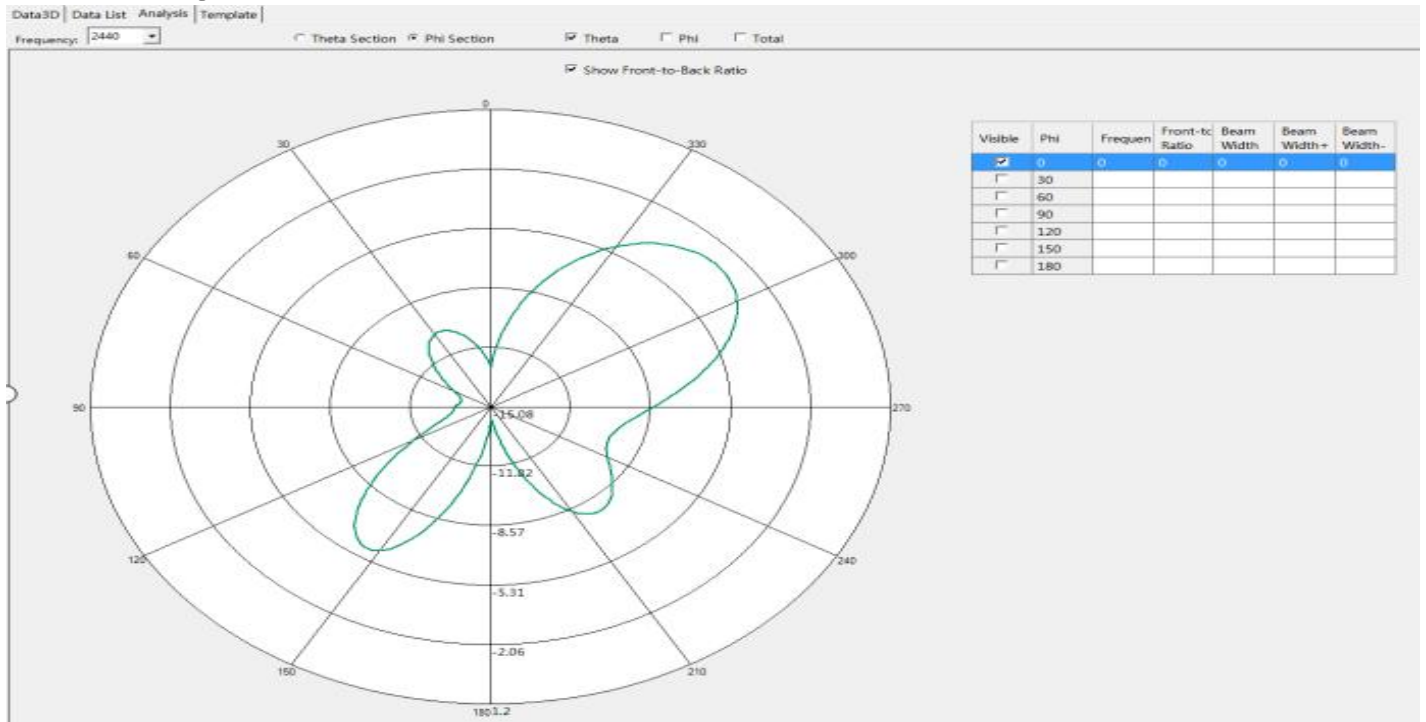

(Theta 0)

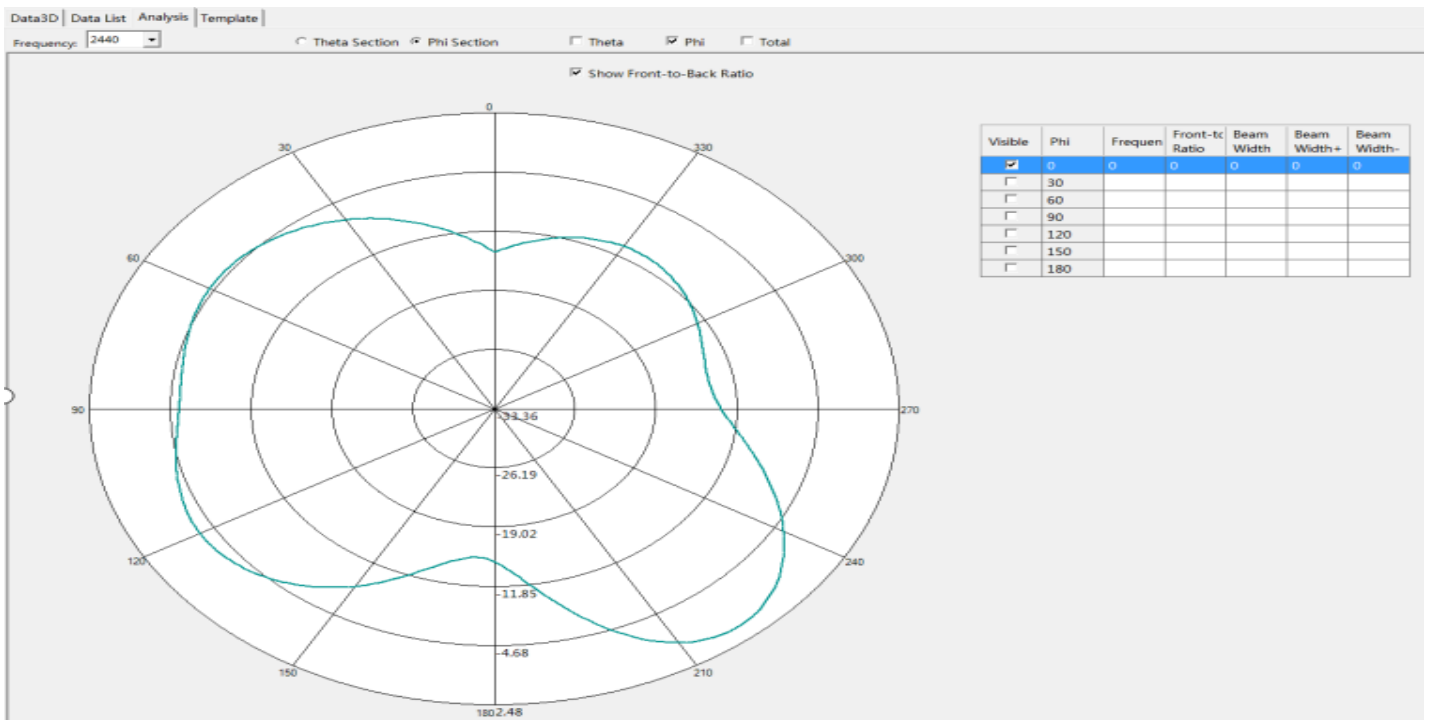

(Phi 0)

(Phi 90) 2.480GHz Diagram

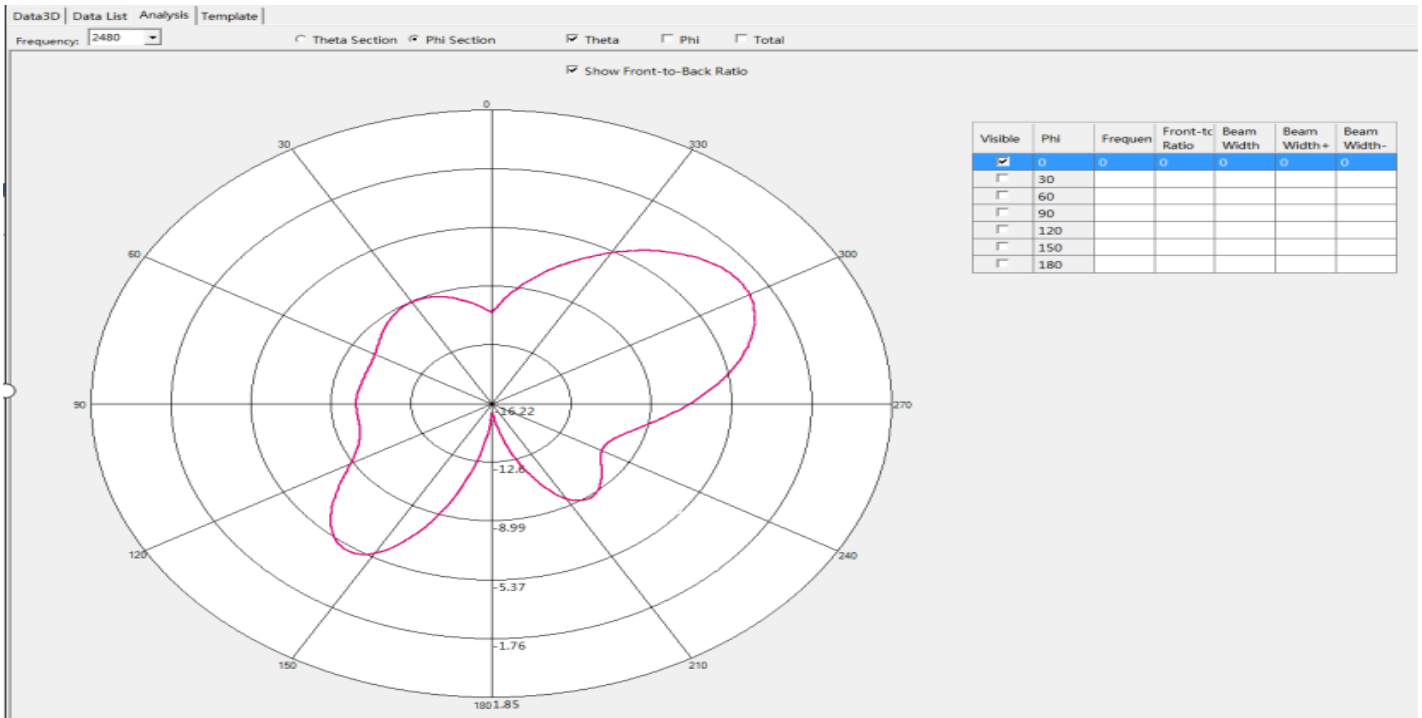
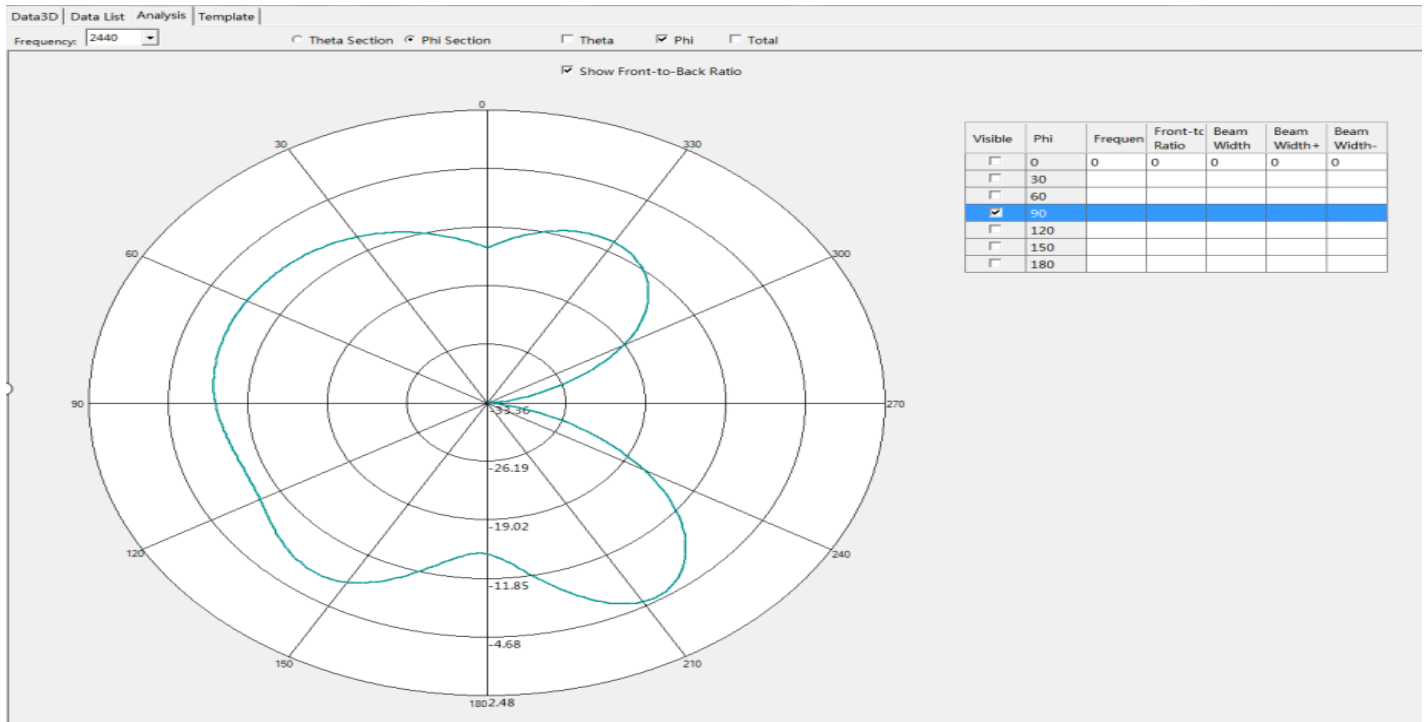

(Theta 0)



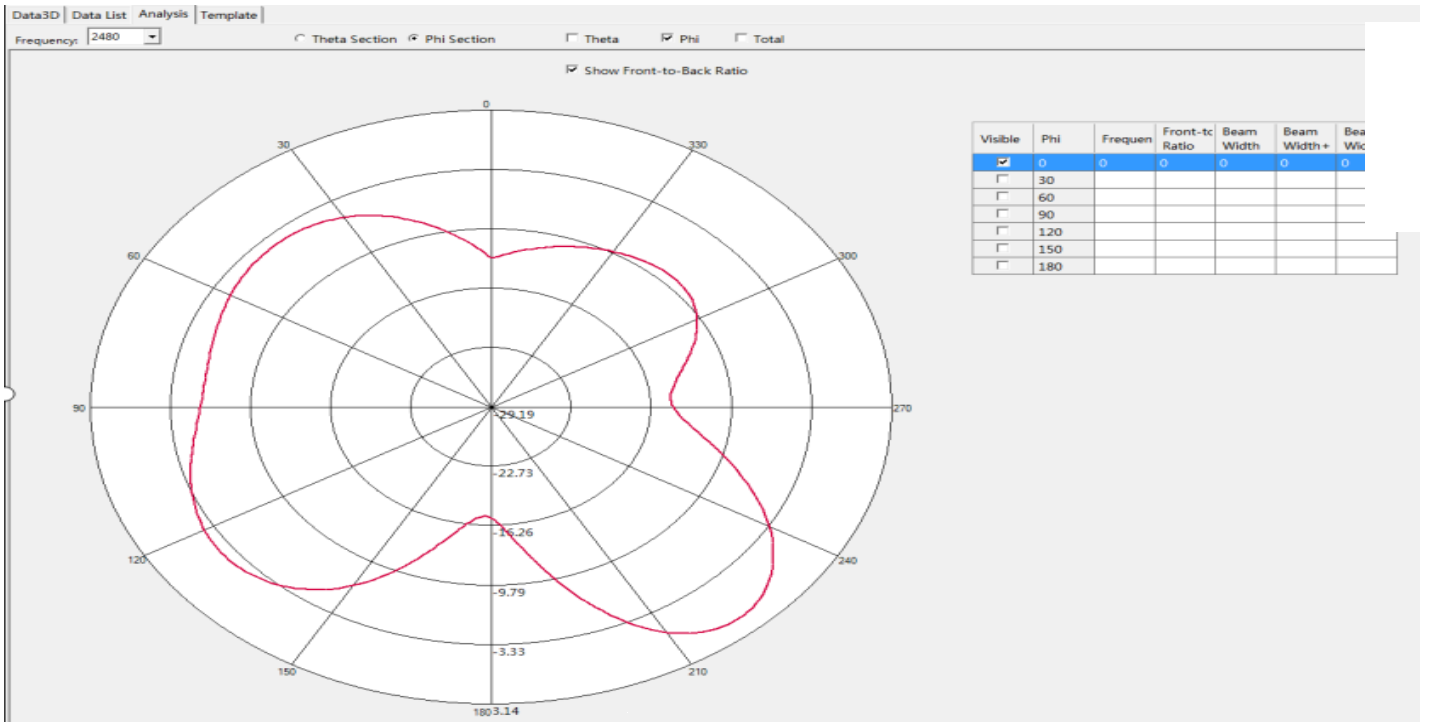

(Phi 90)

