

TEST REPORT

Product Name : Powered Column Loudspeaker with Battery
Model Number : C210B
FCC ID : QWHC210B

Prepared for : MUSIC Tribe Manufacturing PH Ltd.
Address : 17A Brunswick Street, HA HM 10 Bermuda

Prepared by : EMTEK (SHENZHEN) CO., LTD.
Address : Building 69, Majialong Industry Zone, Nanshan District,
Shenzhen, Guangdong, China

Tel: (0755) 26954280
Fax: (0755) 26954282

Report Number : ES191209029W
Date(s) of Tests : December 09, 2020 to May 13, 2020
Date of issue : June 10, 2020

Table of Contents

1	TEST RESULT CERTIFICATION	3
2	EUT TECHNICAL DESCRIPTION	4
3	SUMMARY OF TEST RESULT	5
4	TEST METHODOLOGY	6
4.1	GENERAL DESCRIPTION OF APPLIED STANDARDS	6
4.2	MEASUREMENT EQUIPMENT USED	6
4.3	DESCRIPTION OF TEST MODES	7
5	FACILITIES AND ACCREDITATIONS.....	8
5.1	FACILITIES.....	8
5.2	LABORATORY ACCREDITATIONS AND LISTINGS	8
6	TEST SYSTEM UNCERTAINTY	8
7	SETUP OF EQUIPMENT UNDER TEST	9
7.1	RADIO FREQUENCY TEST SETUP 1	9
7.2	RADIO FREQUENCY TEST SETUP 2	9
7.3	CONDUCTED EMISSION TEST SETUP	10
7.4	SUPPORT EQUIPMENT	11
8	FREQUENCY HOPPING SYSTEM REQUIREMENTS	12
8.1	STANDARD APPLICABLE.....	12
8.2	EUT PSEUDORANDOM FREQUENCY HOPPING SEQUENCE.....	12
8.3	EQUAL HOPPING FREQUENCY USE	13
8.4	FREQUENCY HOPPING SYSTEM	13
9	TEST REQUIREMENTS	14
9.1	20DB BANDWIDTH	14
9.2	CARRIER FREQUENCY SEPARATION	20
9.3	NUMBER OF HOPPING FREQUENCIES	26
9.4	AVERAGE TIME OF OCCUPANCY (DWELL TIME)	28
9.5	MAXIMUM PEAK CONDUCTED OUTPUT POWER.....	31
9.6	CONDUCTED SUPRIOUS EMISSION	37
9.7	RADIATED SPURIOUS EMISSION.....	44
9.8	CONDUCTED EMISSION TEST	57
9.9	ANTENNA APPLICATION	60

1 TEST RESULT CERTIFICATION

Applicant:	MUSIC Tribe Manufacturing PH Ltd. 17A Brunswick Street, HA HM 10 Bermuda
Manufacture:	MUSIC Tribe Manufacturing PH Ltd. 17A Brunswick Street, HA HM 10 Bermuda
Product Description:	Powered Column Loudspeaker with Battery
Model Number:	C210B
Trade Mark:	behringer

Measurement Procedure Used:

APPLICABLE STANDARDS	
STANDARD	TEST RESULT
FCC 47 CFR Part 2 2018, Subpart J FCC 47 CFR Part 15 2018, Subpart C	PASS

The above equipment was tested by EMTEK(SHENZHEN) CO., LTD. The test data, data evaluation, test procedures, and equipment configurations shown in this report were made in accordance with the procedures given in ANSI C63.10 (2013) and the energy emitted by the sample EUT tested as described in this report is in compliance with the requirements of FCC Rules Part 2 and Part 15.247.

The test results of this report relate only to the tested sample identified in this report.

Date of Test : December 09, 2020 to May 13, 2020

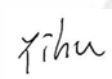
Prepared by: 
YihuXiong/Editor

Reviewer: 
Joe Xia/Supervisor

Approve & Authorized Signer : 
Lisa Wang/Manager



2 EUT TECHNICAL DESCRIPTION

Characteristics	Description
Product Name	Powered Column Loudspeaker with Battery
Model number	C210B
Device Type	4.2 BT Signal mode
Data Rate	1Mbps for GFSK modulation 2Mbps for pi/4-DQPSK modulation 3Mbps for 8DPSK modulation
Modulation	GFSK modulation (1Mbps) pi/4-DQPSK modulation (2Mbps) 8DPSK modulation (3Mbps)
Operating Frequency Range	2402-2480MHz
Number of Channels	79 channels
Max Transmit Power	-6.46 dBm
Antenna Type	PCB Antenna
Gain	-2.0 dBi
Power supply	AC 100-240V, 50/60Hz DC 28V (For battery)
Temperature Range	-5°C ~ +40°C

Note: for more details, please refer to the User's manual of the EUT.

3 SUMMARY OF TEST RESULT

FCC PartClause	Test Parameter	Verdict	Remark
15.247(a)(1)	20 dB Bandwidth	PASS	
15.247(a)(1)	Carrier Frequency Separation	PASS	
15.247(a)(1)	Number of Hopping Frequencies	PASS	
15.247(a)(1)	Average Time of Occupancy (Dwell Time)	PASS	
15.247(b)(1)	Maximum Peak Conducted Output Power	PASS	
15.247(c)	Conducted Spurious Emissions	PASS	
15.247(d) 15.209	Radiated Spurious Emissions	PASS	
15.207	Conducted Emission	PASS	
15.203	Antenna Application	PASS	
NOTE1:N/A (Not Applicable)			

RELATED SUBMITTAL(S) / GRANT(S):

This submittal(s) (test report) is intended for FCC ID: QWHC210B filing to comply with Section 15.247 of the FCC Part 15, Subpart C.

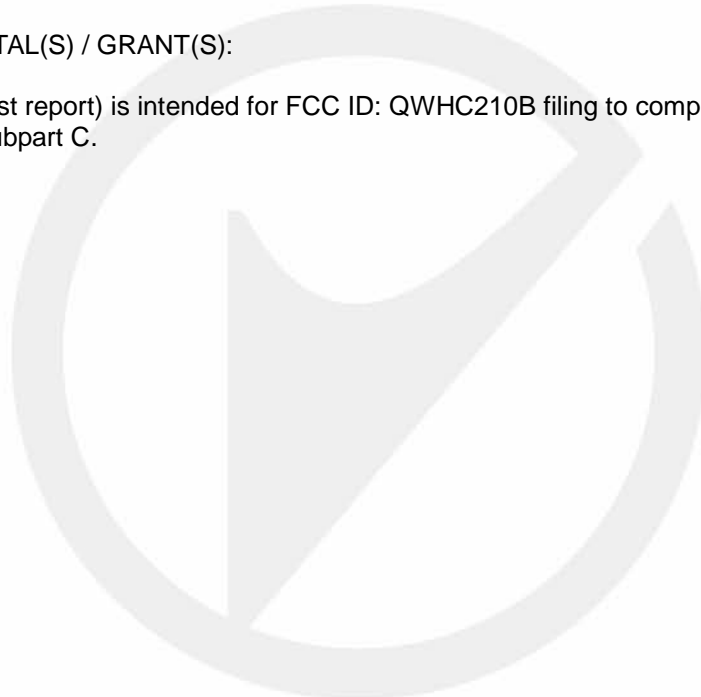

4 TEST METHODOLOGY

4.1 GENERAL DESCRIPTION OF APPLIED STANDARDS

According to its specifications, the EUT must comply with the requirements of the following standards:

FCC 47 CFR Part 2, Subpart J

FCC 47 CFR Part 15, Subpart C

558074 D01 15.247 Meas Guidance V05r02

4.2 MEASUREMENT EQUIPMENT USED

4.2.1 Radiated Emission Test Equipment

EQUIPMENT TYPE	MFR	MODEL NUMBER	SERIAL NUMBER	LAST CAL.	DUE CAL.
EMI Test Receiver	Rohde & Schwarz	ESU	1302.6005.26	May 19, 2019	May 18, 2020
Pre-Amplifier	HP	8447F	2944A07999	May 18, 2019	May 17, 2020
Bilog Antenna	Schwarzbeck	VULB9163	142	May 18, 2019	May 17, 2020
Loop Antenna	ARA	PLA-1030/B	1029	May 18, 2019	May 17, 2020
Horn Antenna	Schwarzbeck	BBHA 9170	BBHA9170399	May 19, 2019	May 17, 2020
Horn Antenna	Schwarzbeck	BBHA 9120	D143	May 18, 2019	May 17, 2020
Cable	Schwarzbeck	AK9513	ACRX1	May 19, 2019	May 18, 2020
Cable	Rosenberger	N/A	FP2RX2	May 19, 2019	May 18, 2020
Cable	Schwarzbeck	AK9513	CRPX1	May 19, 2019	May 18, 2020
Cable	Schwarzbeck	AK9513	CRRX2	May 19, 2019	May 18, 2020

4.2.2 Radio Frequency Test Equipment

EQUIPMENT TYPE	MFR	MODEL NUMBER	SERIAL NUMBER	LASTCAL.	DUE CAL.
Spectrum Analyzer	Agilent	E4407B	88156318	May 19, 2019	May 18, 2020

4.2.3 Conducted Emission Test Equipment

EQUIPMENT TYPE	MFR	MODEL NUMBER	SERIAL NUMBER	LAST CAL.	DUE CAL.
Test Receiver	Rohde & Schwarz	ESCS30	828985/018	May 19, 2019	May 18, 2020
L.I.S.N.	Schwarzbeck	NNLK8129	8129-203	May 19, 2019	May 18, 2020
50Ω Coaxial Switch	Anritsu	MP59B	M20531	May 19, 2019	May 18, 2020

Remark: Each piece of equipment is scheduled for calibration once a year.

4.3 DESCRIPTION OF TEST MODES

The EUT has been tested under its typical operating condition.

The EUT configuration for testing is installed on RF field strength measurement to meet the Commissions requirement and operating in a manner which intends to maximize its emission characteristics in a continuous normal application.

The Transmitter was operated in the normal operating mode. The TX frequency was fixed which was for the purpose of the measurements.

Test of channel included the lowest and middle and highest frequency to perform the test, then record on this report.

Those data rates (1Mbps for Bluetooth GFSK modulation; 2Mbps for Bluetooth pi/4-DQPSK modulation) were used for all test.

Pre-defined engineering program for regulatory testing used to control the EUT for staying in continuous transmitting and receiving mode is programmed.

Frequency and Channel list for Bluetooth V4.2 Signal mode

Channel	Frequency (MHz)	Channel	Frequency (MHz)	Channel	Frequency (MHz)
0	2402	39	2441
1	2403	40	2442	76	2478
2	2404	41	2443	77	2479
...	78	2480

Note: $f_c=2402\text{MHz}+(k-1)\times 1\text{MHz}$ $k=1$ to 79

Test Frequency and Channel for Bluetooth V4.2 Signal mode

Lowest Frequency		Middle Frequency		Highest Frequency	
Channel	Frequency (MHz)	Channel	Frequency (MHz)	Channel	Frequency (MHz)
0	2402	39	2441	78	2480

5 FACILITIES AND ACCREDITATIONS

5.1 FACILITIES

All measurement facilities used to collect the measurement data are located at

Building 69, Majialong Industry Zone District, Nanshan District, Shenzhen, China

The sites are constructed in conformance with the requirements of ANSI C63.7, ANSI C63.10 and CISPR Publication 22.

5.2 LABORATORY ACCREDITATIONS AND LISTINGS

Site Description

EMC Lab. : Accredited by CNAS, 2018.11.30
 The certificate is valid until 2022.10.28
 The Laboratory has been assessed and proved to be in compliance with
 CNAS-CL01:2018 (identical to ISO/IEC 17025:2017)
 The Certificate Registration Number is L2291.

Accredited by FCC, August 06, 2018
 The certificate is valid until August 07, 2020
 Designation Number: CN1204
 Test Firm Registration Number: 882943

Accredited by A2LA, August 08, 2018
 The certificate is valid until August 31, 2020
 The Certificate Number is 4321.01.

Name of Firm : EMTEK (SHENZHEN) CO., LTD.
 Site Location : Building 69, Majialong Industry Zone, Nanshan District, Shenzhen,
 Guangdong, China

6 TEST SYSTEM UNCERTAINTY

The following measurement uncertainty levels have been estimated for tests performed on the apparatus:

Parameter	Uncertainty
Radio Frequency	$\pm 1 \times 10^{-5}$
Maximum Peak Output Power Test	$\pm 1.0\text{dB}$
Conducted Emissions Test	$\pm 2.0\text{dB}$
Radiated Emission Test	$\pm 2.0\text{dB}$
Occupied Bandwidth Test	$\pm 1.0\text{dB}$
Band Edge Test	$\pm 3\text{dB}$
All emission, radiated	$\pm 3\text{dB}$
Antenna Port Emission	$\pm 3\text{dB}$
Temperature	$\pm 0.5^\circ\text{C}$
Humidity	$\pm 3\%$

Measurement Uncertainty for a level of Confidence of 95%

7 SETUP OF EQUIPMENT UNDER TEST

7.1 RADIO FREQUENCY TEST SETUP 1

The Bluetooth component's antenna ports(s) of the EUT are connected to the measurement instrument per an appropriate attenuator. The EUT is controlled by PC/software to emit the specified signals for the purpose of measurements.

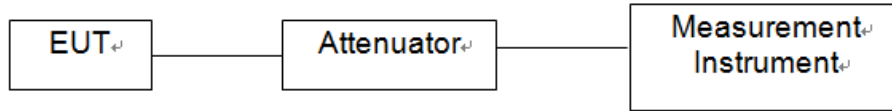

7.2 RADIO FREQUENCY TEST SETUP 2

The test site semi-anechoic chamber has met the requirement of NSA tolerance 4 dB according to the standards: ANSI C63.10. The test distance is 3m. The setup is according to the requirements in Section 13.1.4.1 of ANSI C63.10-2013 and CAN/CSA-CEI/IEC CISPR 22.

Below 30MHz:

The EUT is placed on a turntable 0.1 meters above the ground in the chamber, 3 meter away from the antenna (loop antenna). The Antenna should be positioned with its plane vertical at the specified distance from the EUT and rotated about its vertical axis for maximum response at each azimuth about the EUT. The center of the loop shall be 1 m above the ground. For certain applications, the loop antenna plane may also need to be positioned horizontally at the specified distance from the EUT.

30MHz-1GHz:

The EUT is placed on a turntable 0.1 meters above the ground in the chamber, 3 meter away from the antenna. The maximal emission value is acquired by adjusting the antenna height, polarisation and turntable azimuth. Normally, the height range of antenna is 1 m to 4 m, the azimuth range of turntable is 0° to 360°, and the receive antenna has two polarizations Vertical (V) and Horizontal (H).

Above 1GHz:

The EUT is placed on a turntable 1.5 meters above the ground in the chamber, 3 meter away from the antenna. The maximal emission value is acquired by adjusting the antenna height, polarisation and turntable azimuth. Normally, the height range of antenna is 1 m to 4 m, the azimuth range of turntable is 0° to 360°, and the receive antenna has two polarizations Vertical (V) and Horizontal (H).

(a) Radiated Emission Test Set-Up, Frequency Below 30MHz

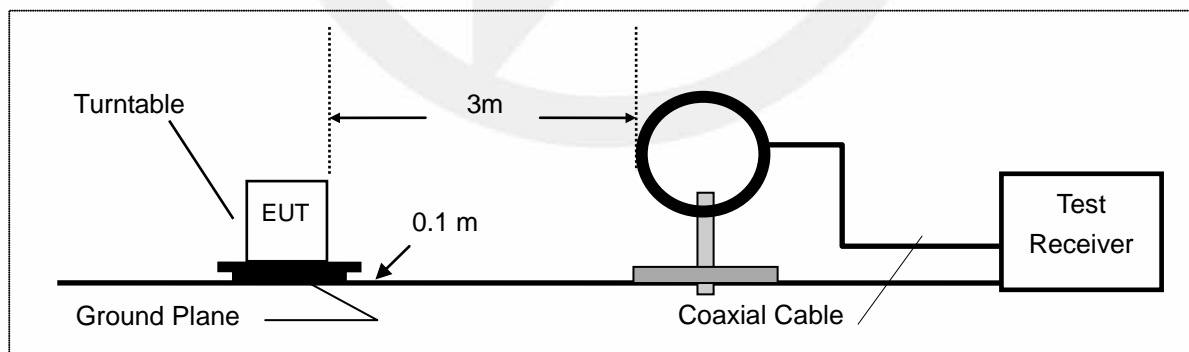

(b) Radiated Emission Test Set-Up, Frequency Below 1000MHz

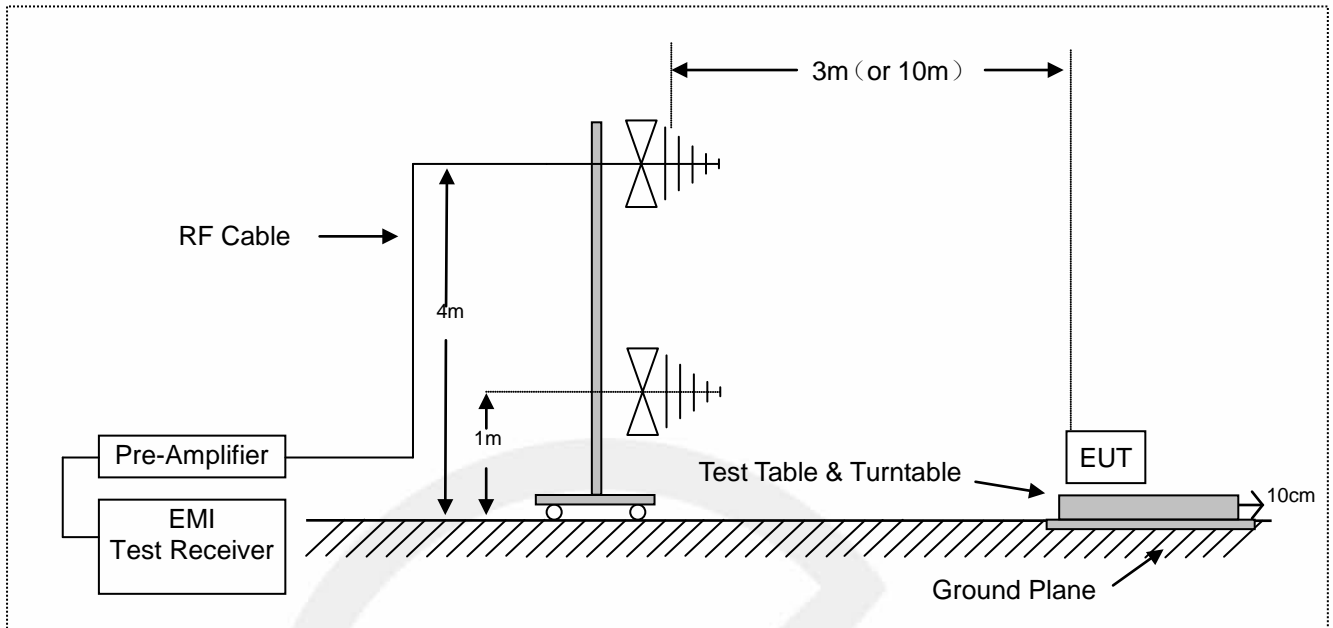

(c) Radiated Emission Test Set-Up, Frequency above 1000MHz

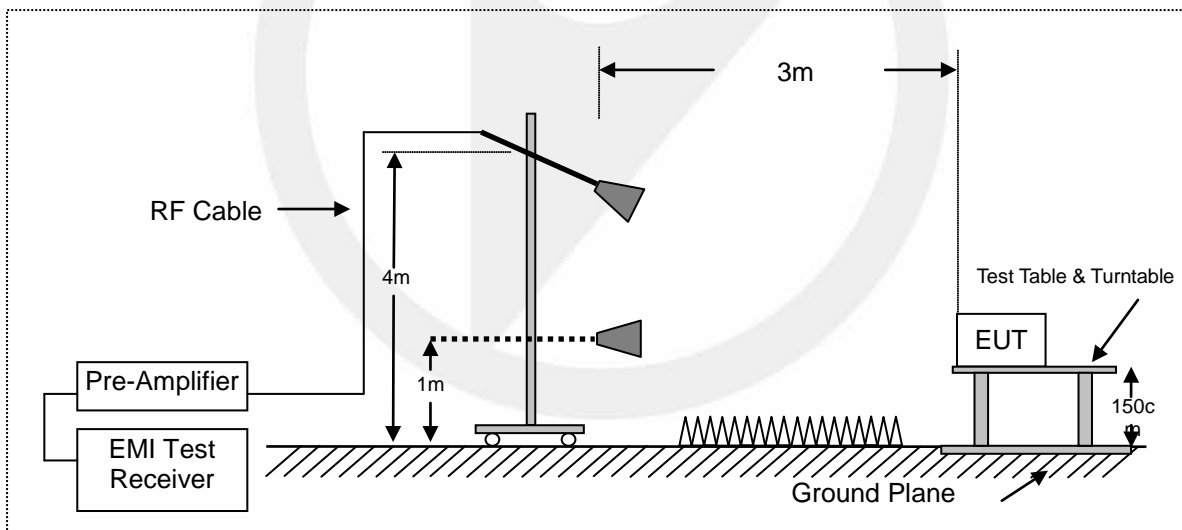

7.3 CONDUCTED EMISSION TEST SETUP

The mains cable of the EUT (Game fitness board) must be connected to LISN. The LISN shall be placed 0.8 m from the boundary of EUT and bonded to a ground reference plane for LISN mounted on top of the ground reference plane. This distance is between the closest points of the LISN and the EUT. All other units of the EUT and associated equipment shall be at least 0.8m from the LISN.

Ground connections, where required for safety purposes, shall be connected to the reference ground point of the LISN and, where not otherwise provided or specified by the manufacturer, shall be of same length as the mains cable and run parallel to the mains connection at a separation distance of not more than 0.1 m.

According to the requirements in Section 13.1.4.1 of ANSI C63.10-2013 Conducted emissions from the EUT measured in the frequency range between 0.15 MHz and 30 MHz using CISPR Quasi-Peak and average detector mode.

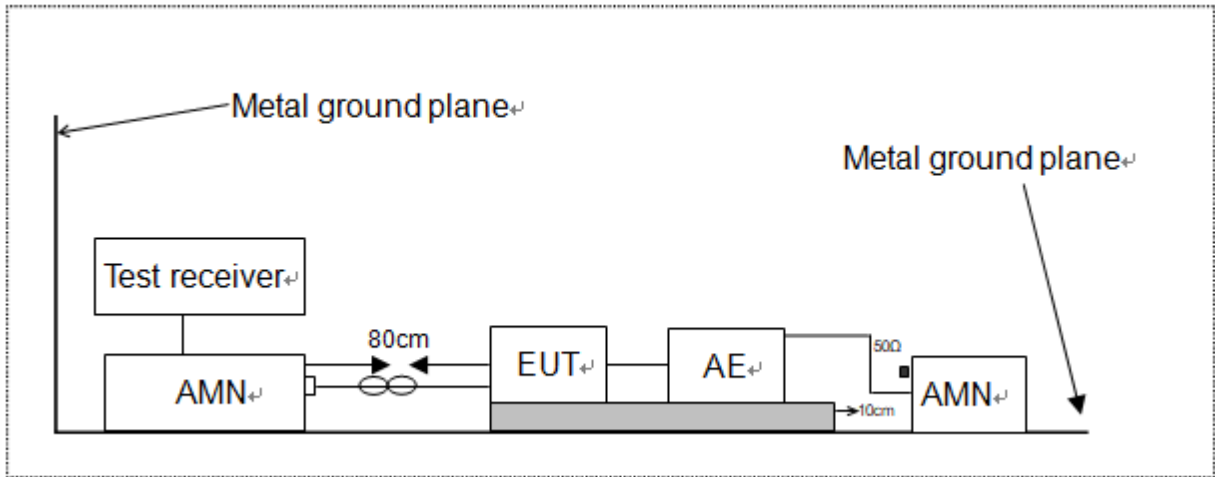

7.4 SUPPORT EQUIPMENT

EUT Cable List and Details			
Cable Description	Length (m)	Shielded/Unshielded	With / Without Ferrite
/	/	/	/

Auxiliary Cable List and Details			
Cable Description	Length (m)	Shielded/Unshielded	With / Without Ferrite
/	/	/	/

Auxiliary Equipment List and Details			
Description	Manufacturer	Model	Serial Number
/	/	/	/

Notes:

1. All the equipment/cables were placed in the worst-case configuration to maximize the emission during the test.
2. Grounding was established in accordance with the manufacturer's requirements and conditions for the intended use.

8 FREQUENCY HOPPING SYSTEM REQUIREMENTS

8.1 Standard Applicable

According to FCC Part 15.247(a)(1), The system shall hop to channel frequencies that are selected at the system hopping rate from a pseudo randomly ordered list of hopping frequencies. Each frequency must be used equally on the average by each transmitter. The system receivers shall have input bandwidths that match the hopping channel bandwidths of their corresponding transmitters and shall shift frequencies in synchronization with the transmitted signals.

(g) Frequency hopping spread spectrum systems are not required to employ all available hopping channels during each transmission. However, the system, consisting of both the transmitter and the receiver, must be designed to comply with all of the regulations in this section should the transmitter be presented with a continuous data (or information) stream. In addition, a system employing short transmission bursts must comply with the definition of a frequency hopping system and must distribute its transmissions over the minimum number of hopping channels specified in this section.

(h) The incorporation of intelligence within a frequency hopping spread spectrum system that permits the system to recognize other users within the spectrum band so that it individually and independently chooses and adapts its hopsets to avoid hopping on occupied channels is permitted. The coordination of frequency hopping systems in any other manner for the express purpose of avoiding the simultaneous occupancy of individual hopping frequencies by multiple transmitters is not permitted.

8.2 EUT Pseudorandom Frequency Hopping Sequence

The channel is represented by a pseudo-random hopping sequence hopping through the 79 RF channels.

The hopping sequence is unique for the piconet and is determined by the Bluetooth device address of the master; the phase in the hopping sequence is determined by the Bluetooth clock of the master. The channel is divided into time slots where each slot corresponds to an RF hop frequency. Consecutive hops correspond to different RF hop frequencies. The normal hop is 1 600 hops/s.

The pseudorandom sequence may be generated in a nine-stage shift register whose 5th and 9th stage outputs are added in a modulo-two addition stage, and the result is fed back to the input of the first stage. The sequence begins with the first ONE of 9 consecutive ONES; i.e. the shift register is initialized with nine ones. Number of shift register stages: 9
Length of pseudo-random sequence: $2^9 - 1 = 511$ bits
Longest sequence of zeros: 8 (non-inverted signal)

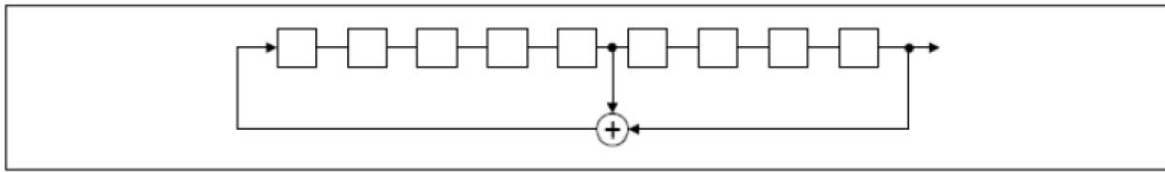

Linear Feedback Shift Register for Generation of the PRBS sequence

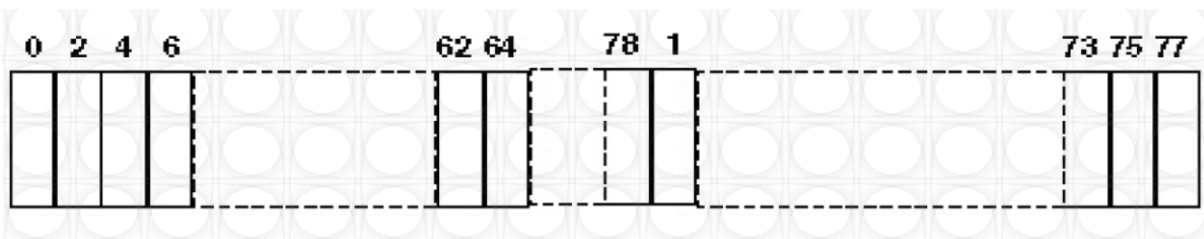

Each frequency used equally on the average by each transmitter.
The system receiver have input bandwidths that match the hopping channel bandwidths of their corresponding transmitters and shift frequencies in synchronization with the transmitted signals.

8.3 Equal Hopping Frequency Use

All Bluetooth units participating in the piconet are time and hop-synchronized to the channel.

Example of a 79 hopping sequence in data mode:

35, 27, 6, 44, 14, 61, 74, 32, 1, 11, 23, 2, 55, 65, 29, 3, 9, 52, 78, 58, 40, 25, 0, 7, 18, 26, 76, 60, 47, 50, 2, 5, 16, 37, 70, 63, 66, 54, 20, 13, 4, 8, 15, 21, 26, 10, 73, 77, 67, 69, 43, 24, 57, 39, 46, 72, 48, 33, 17, 31, 75, 19, 41, 62, 68, 28, 51, 66, 30, 56, 34, 59, 71, 22, 49, 64, 38, 45, 36, 42, 53

Each Frequency used equally on the average by each transmitter

8.4 Frequency Hopping System

This transmitter device is frequency hopping device, and complies with FCC part 15.247 rule.

This device uses Bluetooth radio which operates in 2400-2483.5 MHz band. Bluetooth uses a radio technology called frequency-hopping spread spectrum, which chops up the data being sent and transmits chunks of it on up to 79 bands (1 MHz each; centred from 2402 to 2480 MHz) in the range 2,400-2,483.5 MHz. The transmitter switches hop frequencies 1,600 times per second to assure a high degree of data security. All Bluetooth devices participating in a given piconet are synchronized to the frequency-hopping channel for the piconet. The frequency hopping sequence is determined by the master's device address and the phase of the hopping sequence (the frequency to hop at a specific time) is determined by the master's internal clock. Therefore, all slaves in a piconet must know the master's device address and must synchronize their clocks with the master's clock.

Adaptive Frequency Hopping (AFH) was introduced in the Bluetooth specification to provide an effective way for a Bluetooth radio to counteract normal interference. AFH identifies "bad" channels, where either other wireless devices are interfering with the Bluetooth signal or the Bluetooth signal is interfering with another device. The AFH-enabled Bluetooth device will then communicate with other devices within its piconet to share details of any identified bad channels. The devices will then switch to alternative available "good" channels, away from the areas of interference, thus having no impact on the bandwidth used.

9 TEST REQUIREMENTS

9.1 20DB BANDWIDTH

9.1.1 Applicable Standard

According to FCC Part 15.247(a)(1) and 558074 D01 15.247 Meas Guidance V05r02

9.1.2 Conformance Limit

No limit requirement.

9.1.3 Test Configuration

Test according to clause 7.1 radio frequency test setup 1

9.1.4 Test Procedure

The EUT was operating in Bluetooth 4.2 Signal mode and controlled its channel. Printed out the test result from the spectrum by hard copy function.

The RF output of EUT was connected to the spectrum analyzer by RF cable and attenuator. The path loss was compensated to the results for each measurement.

Set to the maximum power setting and enable the EUT transmit continuously

Set RBW = 30 kHz.

Set the video bandwidth (VBW) =100kHz.

Set Span= approximately 2 to 3 times the 20 dB bandwidth

Set Detector = Peak.

Set Trace mode = max hold.

Set Sweep = auto couple.

The EUT should be transmitting at its maximum data rate. Allow the trace to stabilize. Use the marker-to-peak function to set the marker to the peak of the emission. Use the marker-delta function to measure 20 dB down one side of the emission. Reset the marker-delta function, and move the marker to the other side of the emission, until it is (as close as possible to) even with the reference marker level. The marker-delta reading at this point is the 20 dB bandwidth of the emission.

If this value varies with different modes of operation (e.g., data rate, modulation format, etc.), repeat this test for each variation.

Measure and record the results in the test report.

Test Results

Temperature:	21°C	Test Date:	May 06, 2020
Humidity:	45%	Test By:	XW

Modulation Mode	Channel Number	Channel Frequency (MHz)	20dB Bandwidth (kHz)
GFSK	0	2402	1033.30
	39	2441	1037.60
	78	2480	1033.30
pi/4-DQPSK	0	2402	1133.10
	39	2441	1246.00
	78	2480	1124.50
8DPSK	0	2402	1167.90
	39	2441	1241.70
	78	2480	1180.90

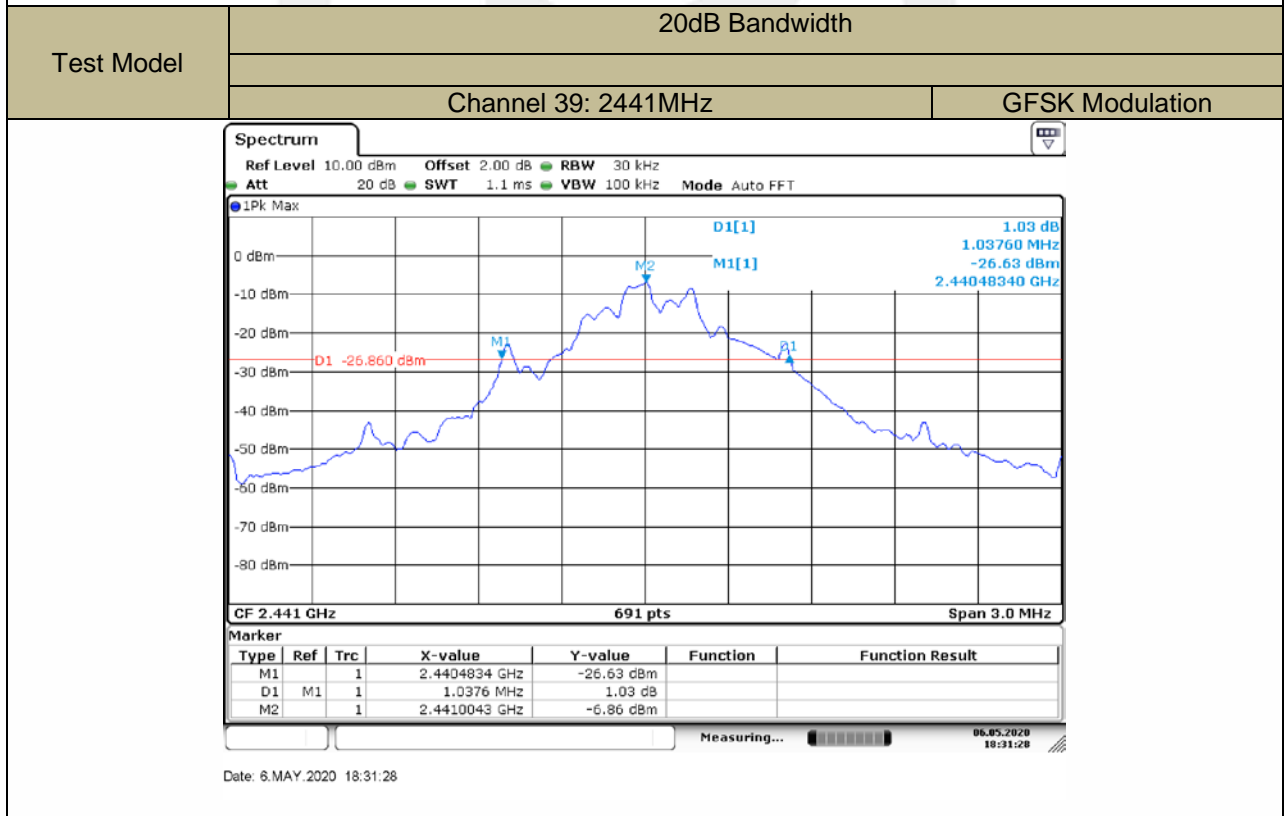
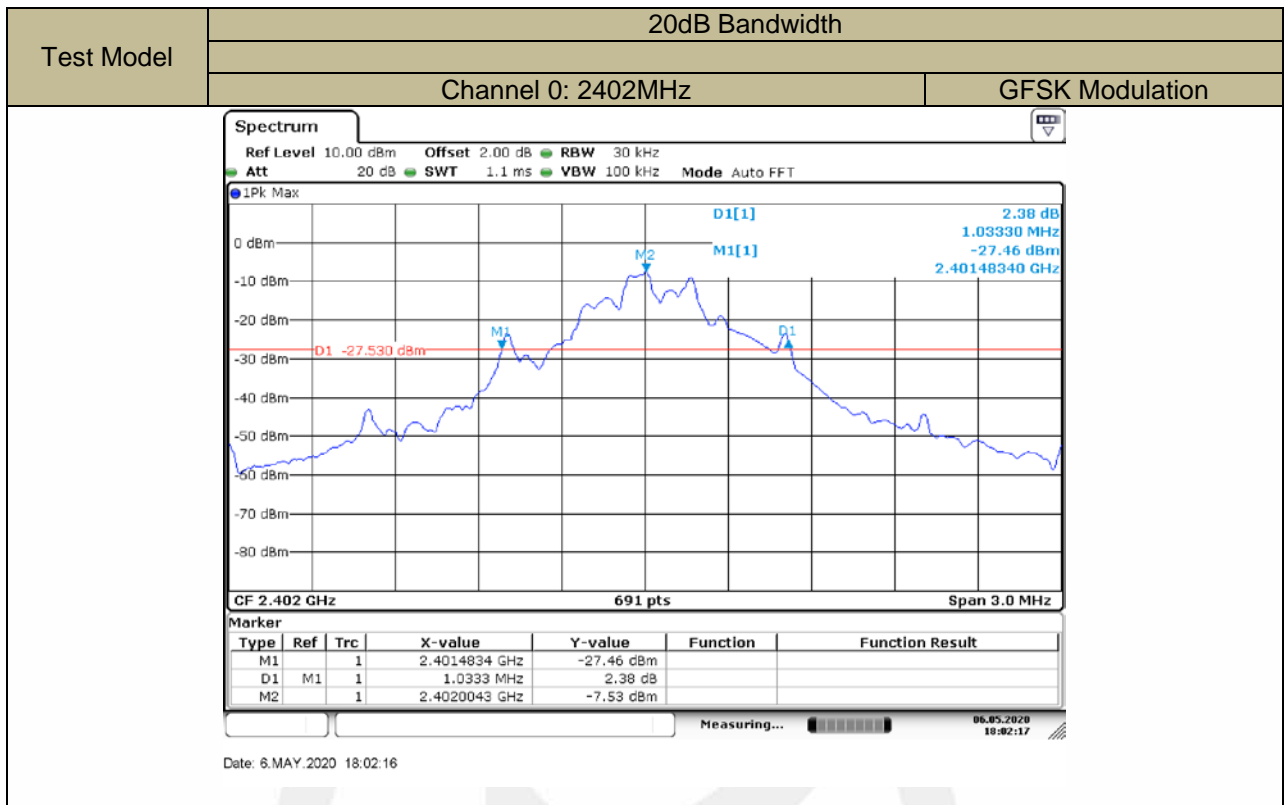

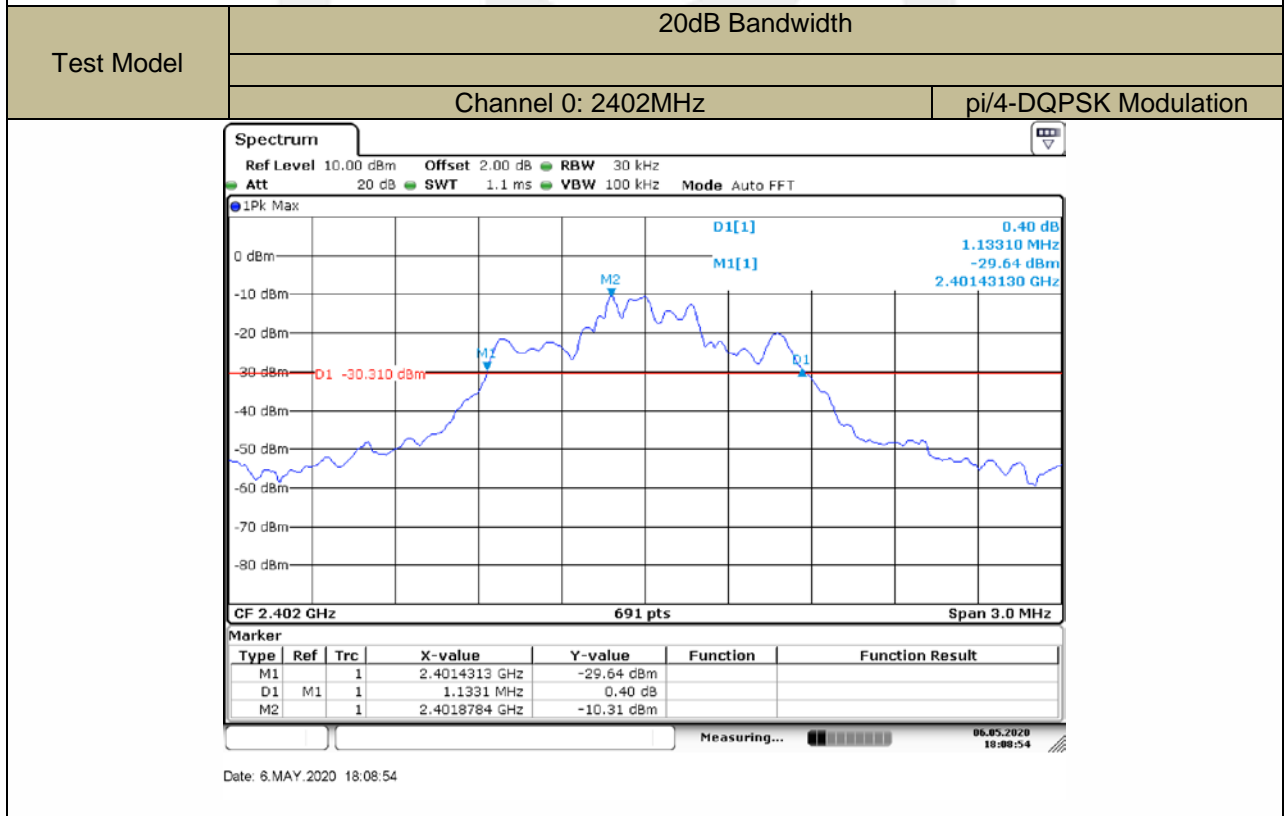
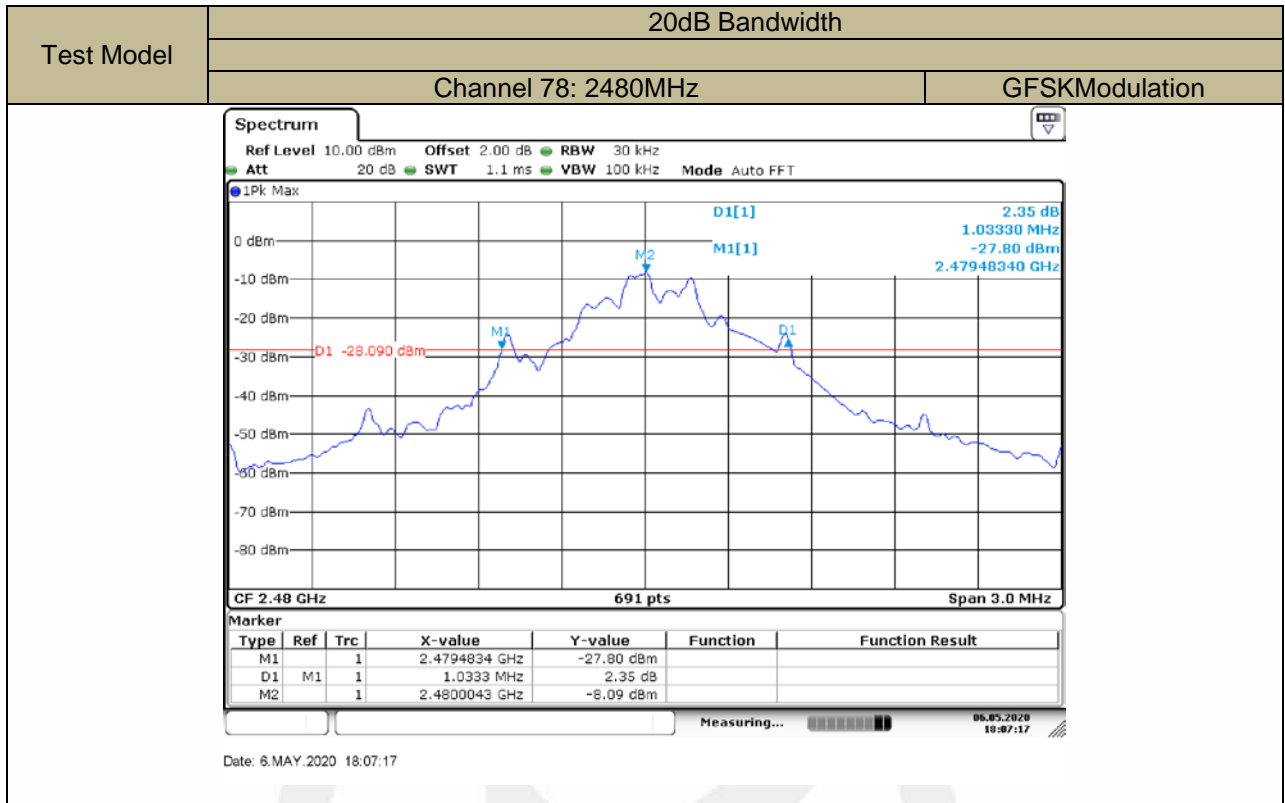

Test Model	20dB Bandwidth	
	Channel 39: 2441MHz	pi/4-DQPSK Modulation

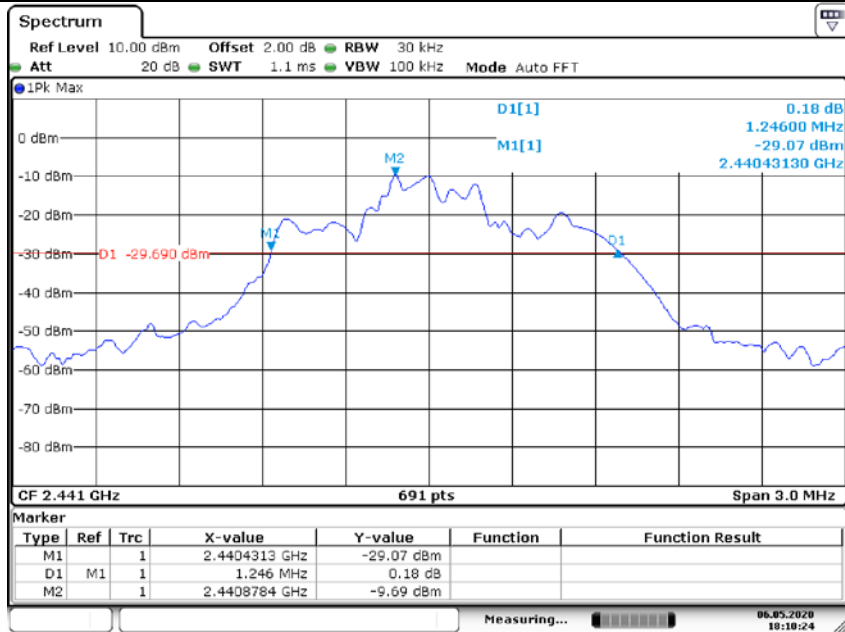

Date: 6.MAY.2020 18:10:24

Test Model	20dB Bandwidth	
	Channel 78: 2480MHz	pi/4-DQPSK Modulation

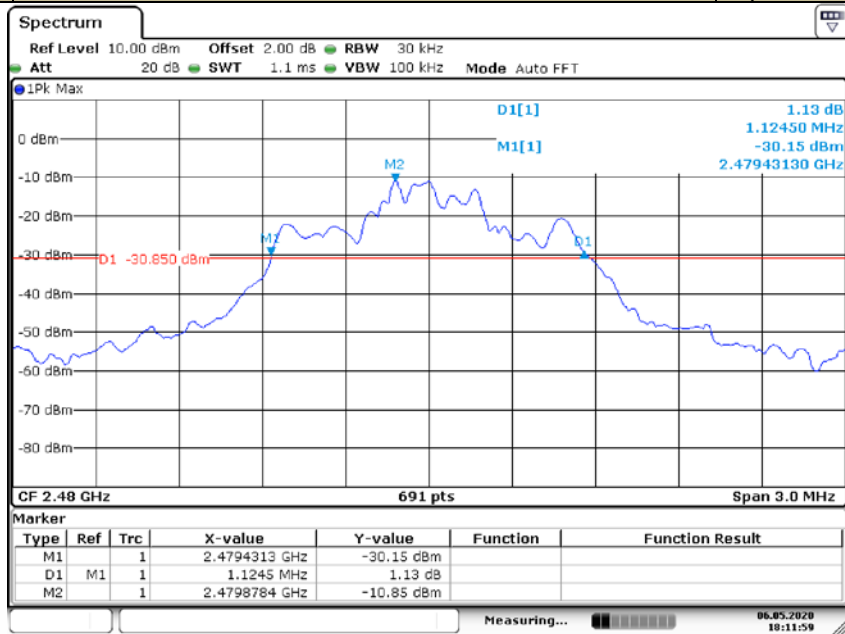

Date: 6.MAY.2020 18:11:59

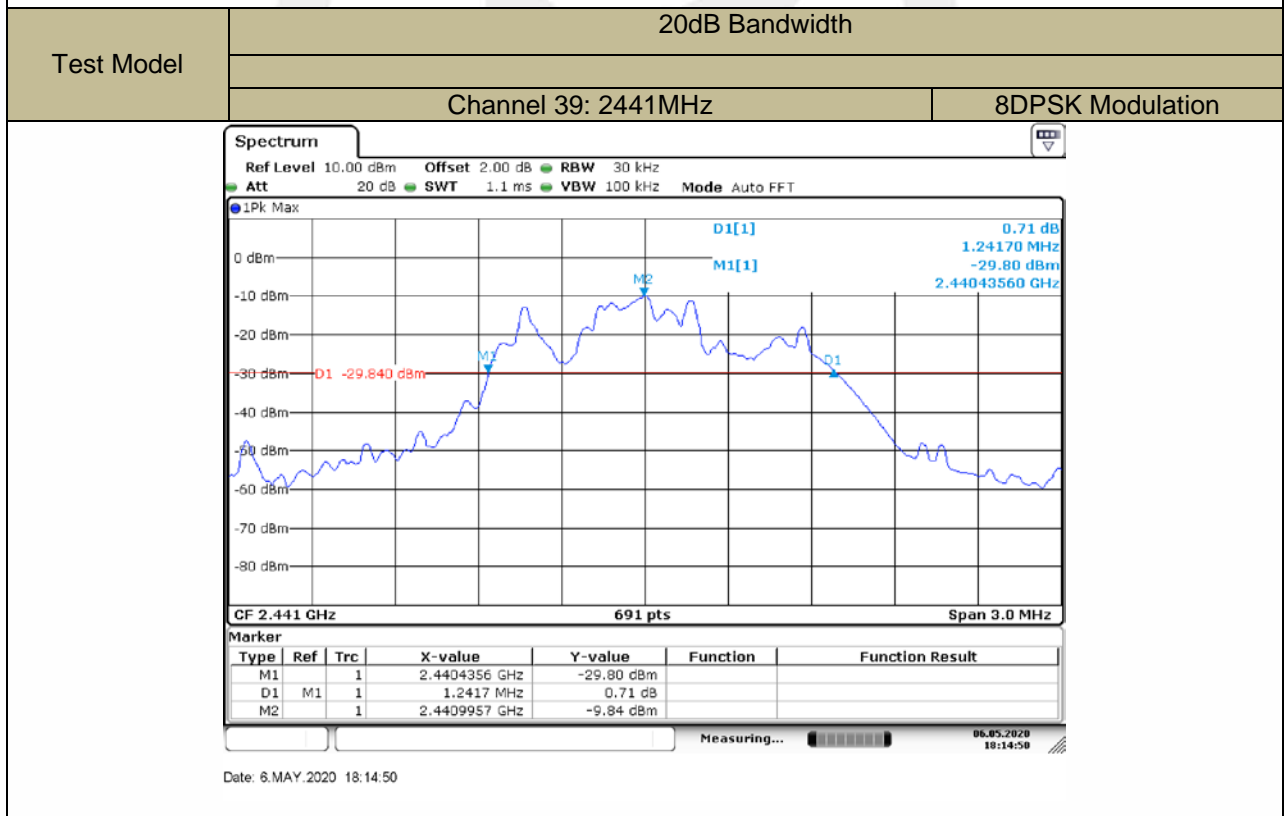
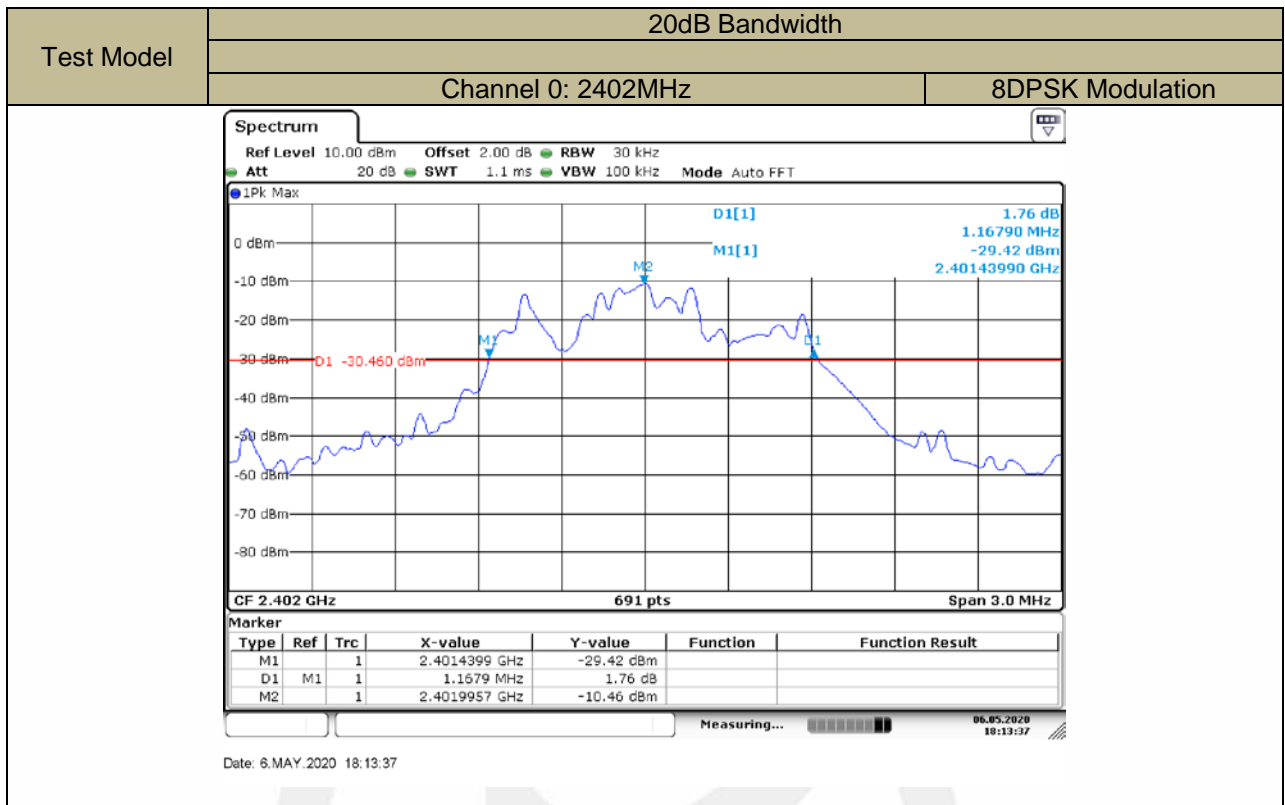

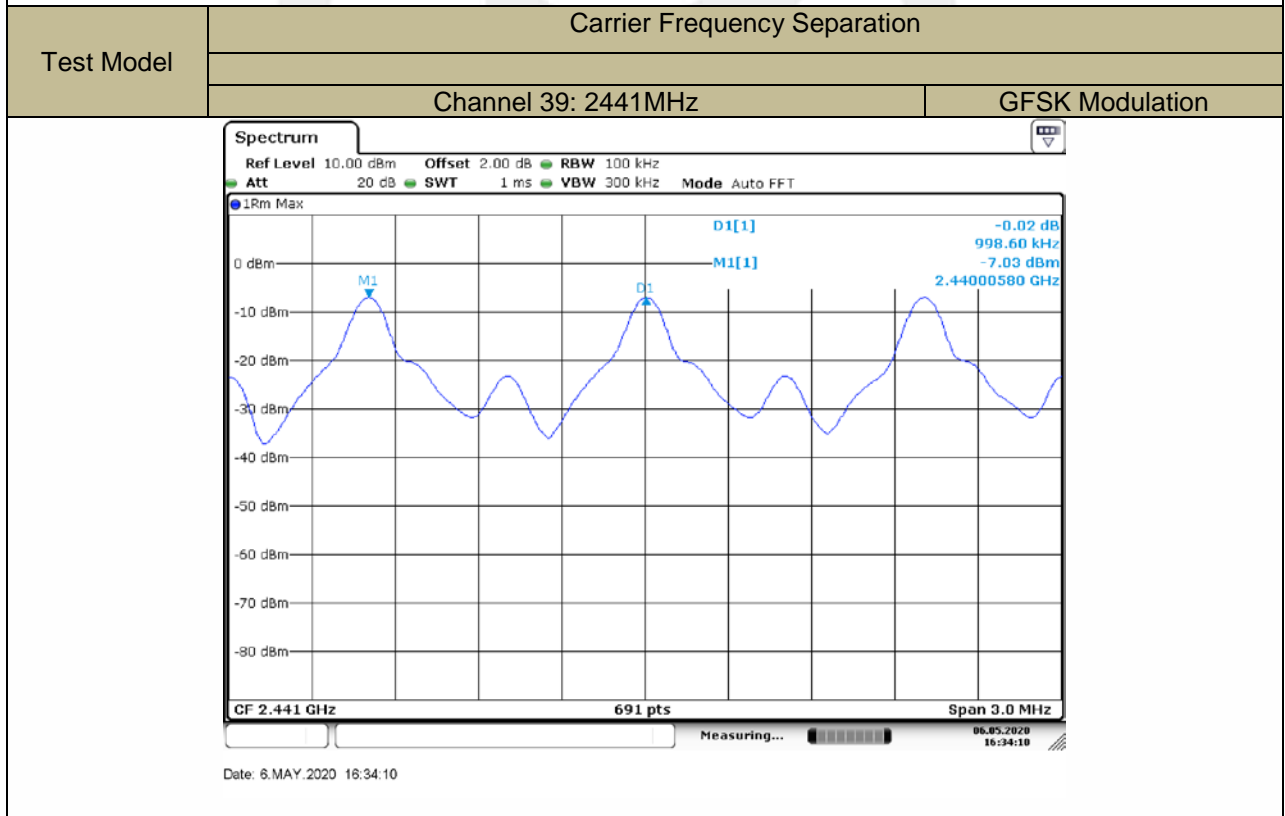
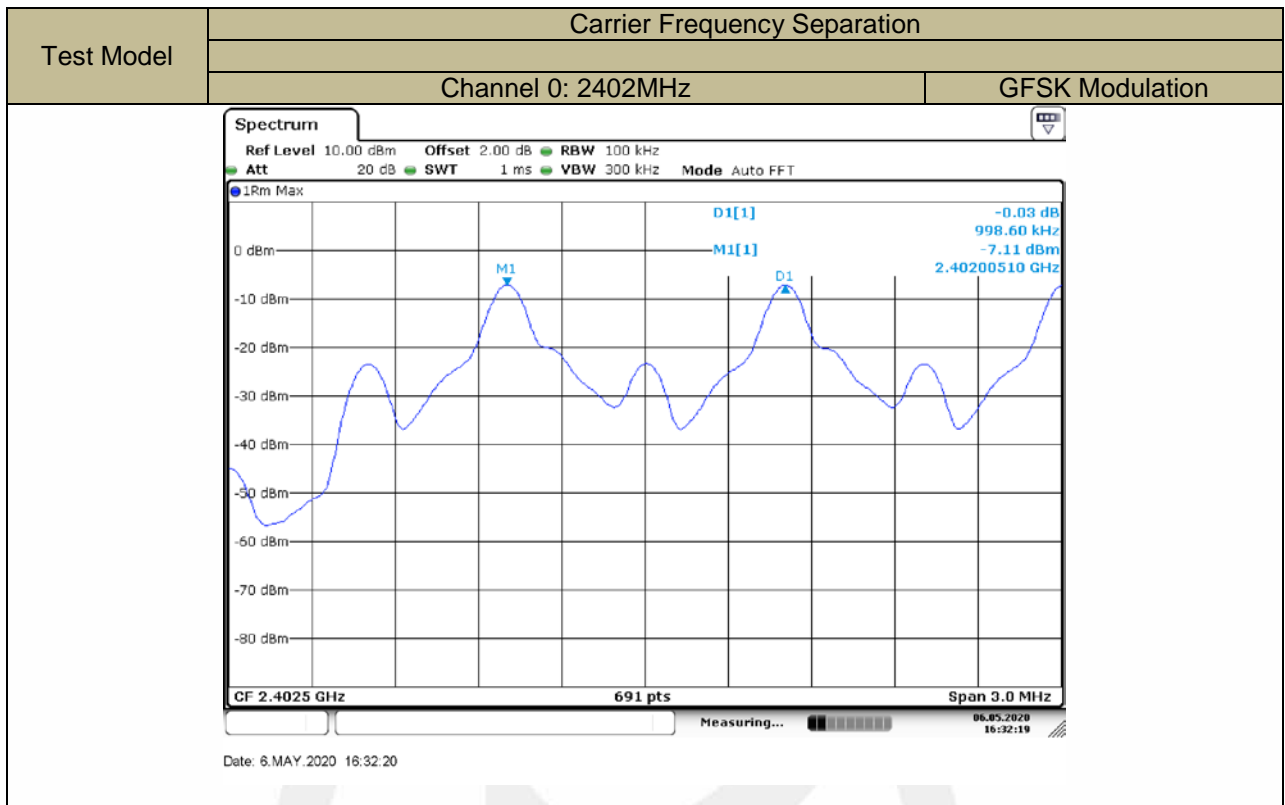

Test Model	Carrier Frequency Separation	
	Channel 78: 2480MHz	GFSK Modulation

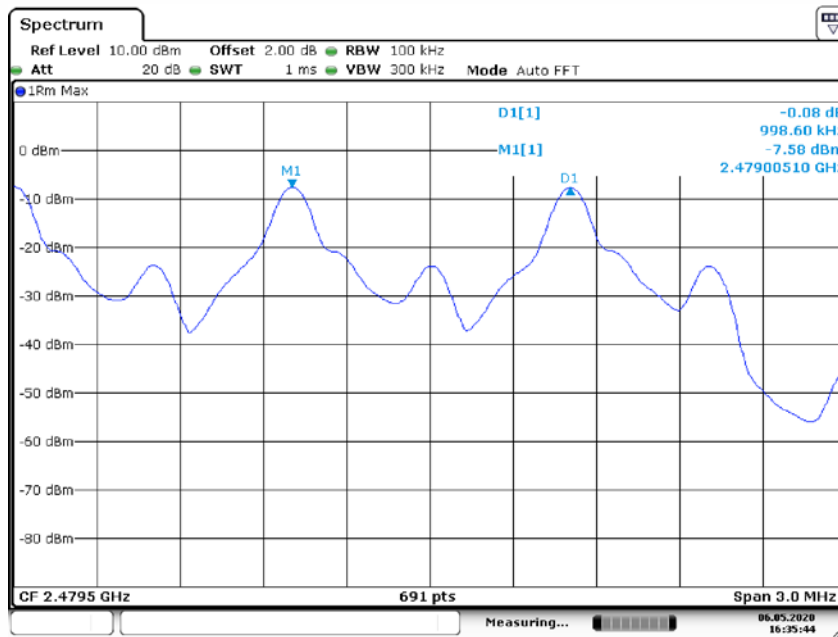

Date: 6.MAY.2020 16:35:44

Test Model	Carrier Frequency Separation	
	Channel 0: 2402MHz	pi/4-DQPSK Modulation

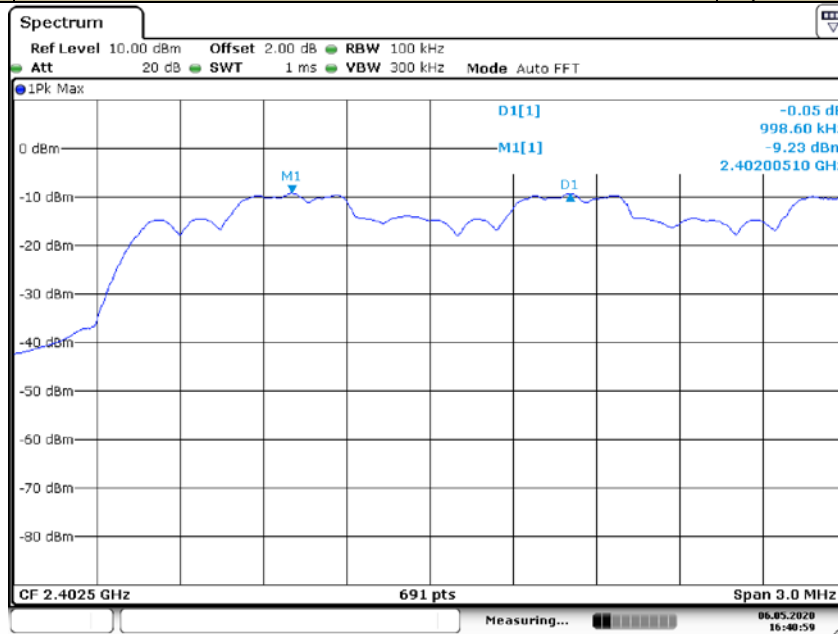

Date: 6.MAY.2020 16:41:00

Test Model	Carrier Frequency Separation	
	Channel 39: 2441MHz	pi/4-DQPSK Modulation

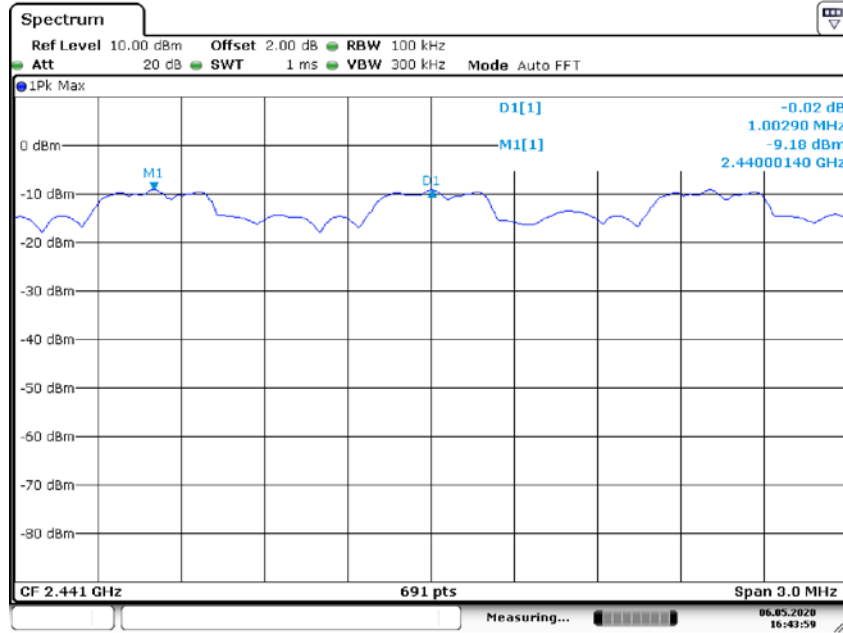

Date: 6.MAY.2020 16:43:59

Test Model	Carrier Frequency Separation	
	Channel 78: 2480MHz	pi/4-DQPSK Modulation

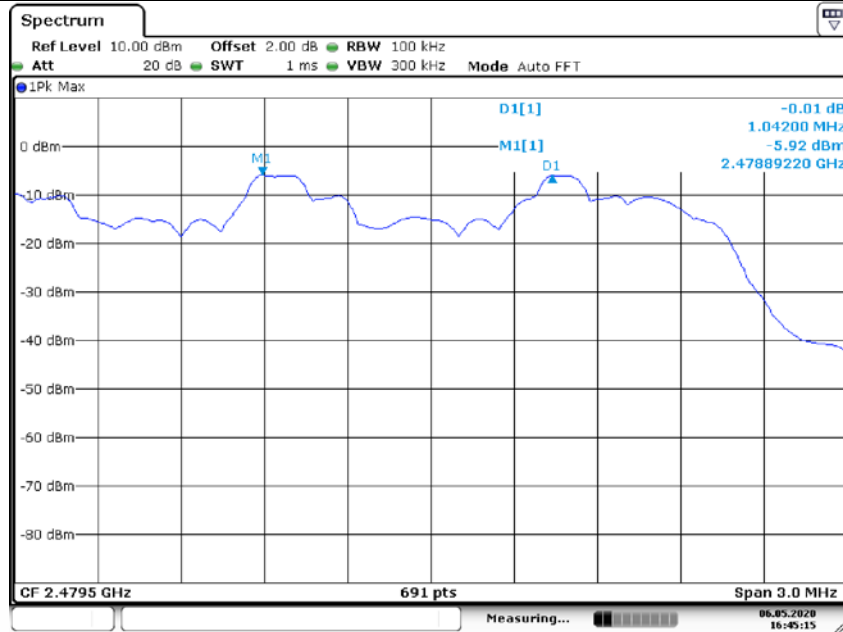

Date: 6.MAY.2020 16:45:15

Test Model	Carrier Frequency Separation	
	Channel 0: 2402MHz	8DPSK Modulation

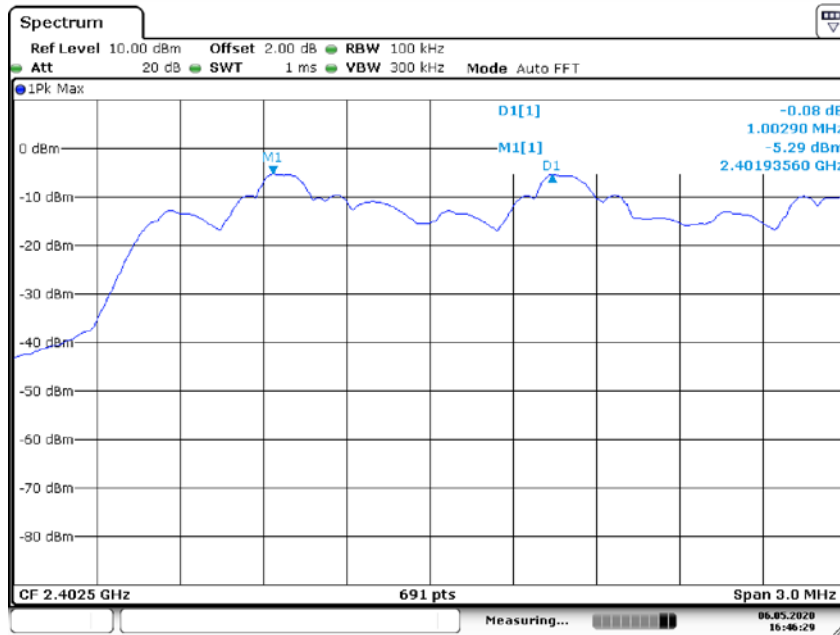

Date: 6.MAY.2020 16:46:29

Test Model	Carrier Frequency Separation	
	Channel 39: 2441MHz	8DPSK Modulation

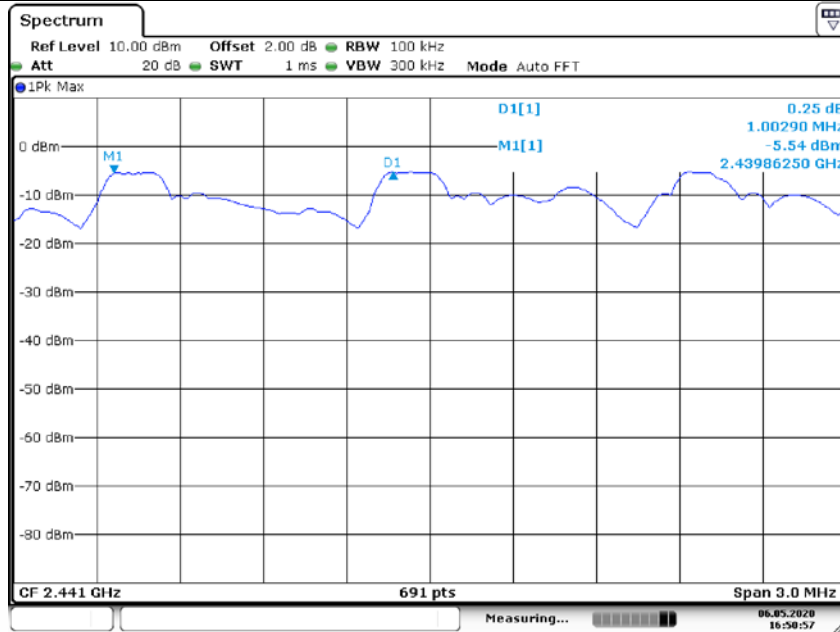

Date: 6.MAY.2020 16:50:56

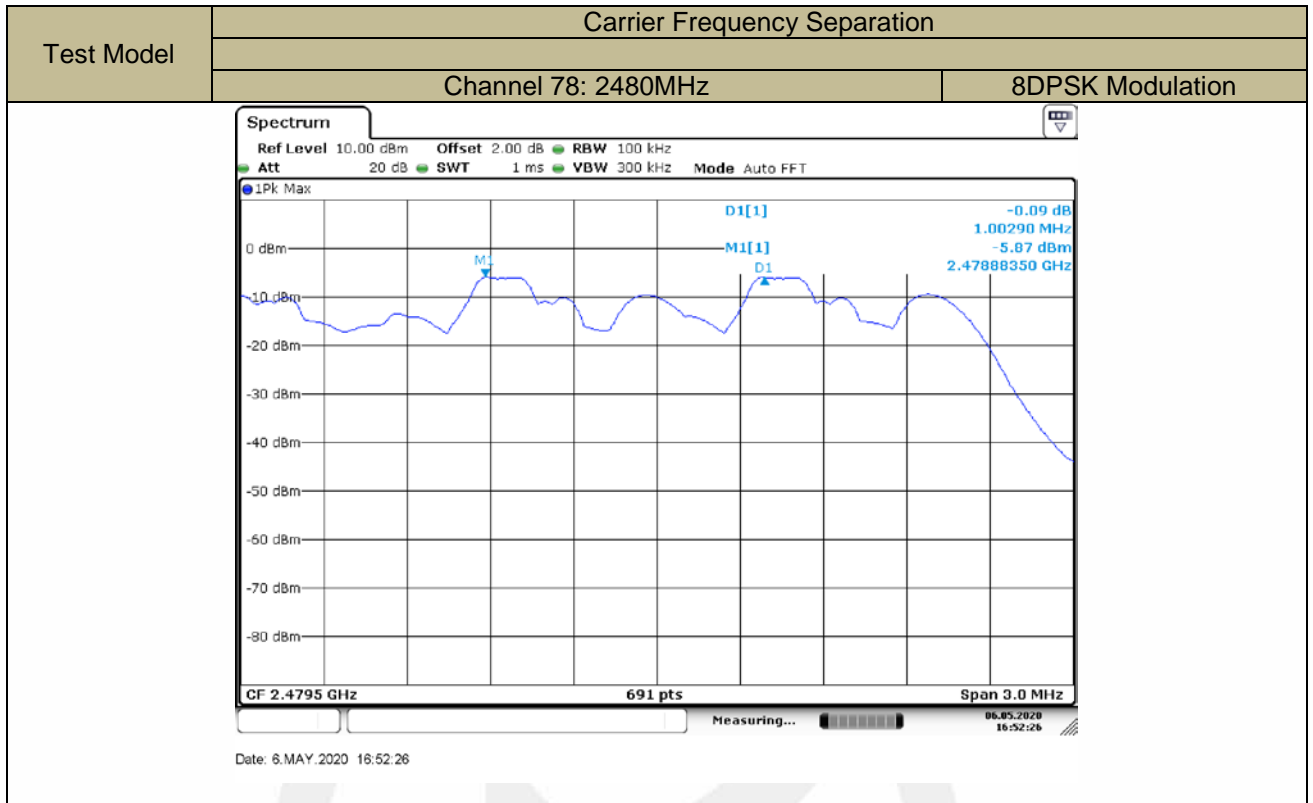

9.3 NUMBER OF HOPPING FREQUENCIES

9.3.1 Applicable Standard

According to FCC Part 15.247(a)(1) (iii) and 558074 D01 15.247 Meas Guidance V05r02

9.3.2 Conformance Limit

Frequency hopping systems operating in the 2400-2483.5MHz band shall use at least 15 channels.

9.3.3 Test Configuration

Test according to clause 7.1 radio frequency test setup 1

9.3.4 Test Procedure

- According to FCC Part 15.247(a)(1)(iii)

The EUT must have its hopping function enabled. Use the following spectrum analyzer settings:

Span = the frequency band of operation

RBW = 100kHz

VBW ≥ RBW

Sweep = auto

Detector function = peak

Trace = max hold

Allow the trace to stabilize. It may prove necessary to break the span up to sections, in order to clearly show all of the hopping frequencies.

Test Results

Temperature:	21°C	Test Date:	May 06, 2020
Humidity:	45 %	Test By:	XW

Hopping Channel Frequency Range	Quantity of Hopping Channel	Quantity of Hopping Channel limit
2402-2480 (GFSK)	79	> 15
Note: Note: Both BR & EDR mode has same result .		

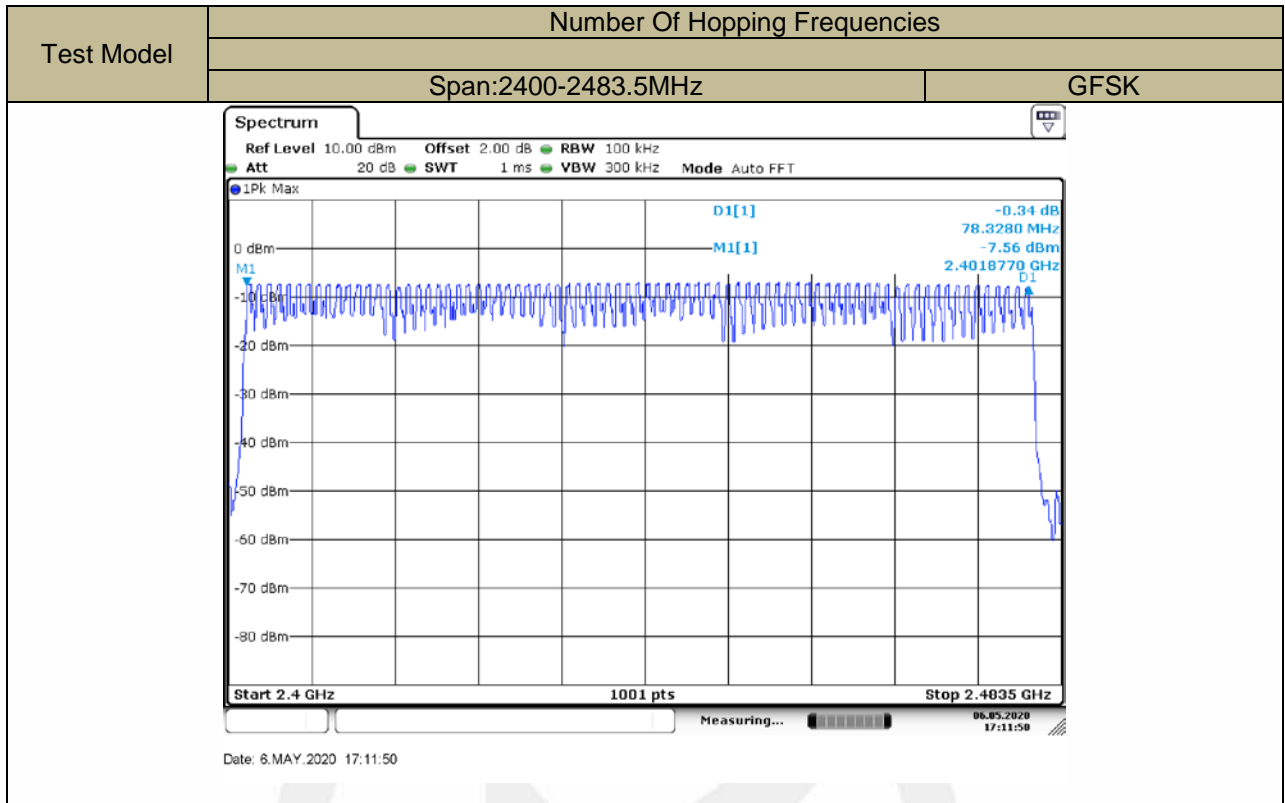

Test Model	Average Time Of Occupancy (Dwell Time)	
	CH 0: 2402MHz	GFSK DH1

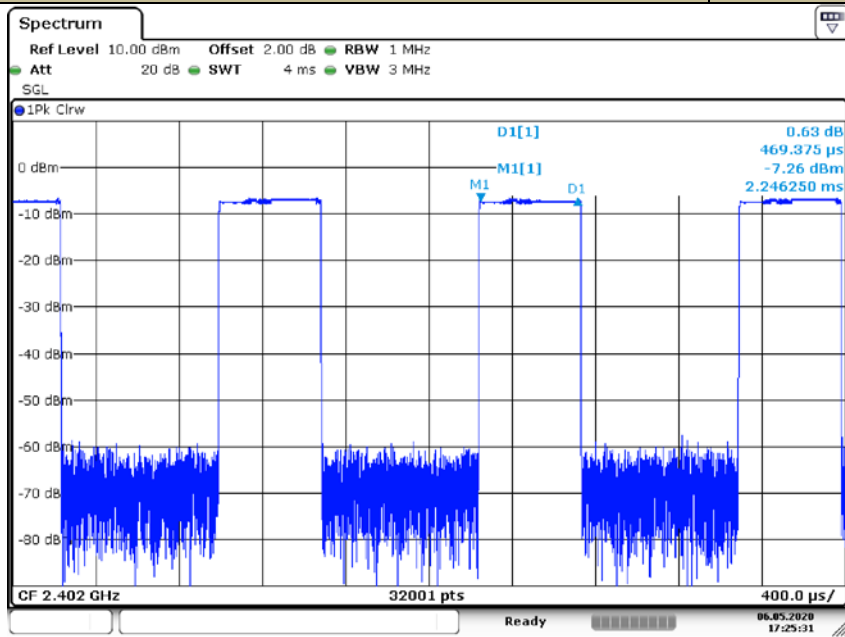

Date: 6.MAY.2020 17:25:31

Test Model	Average Time Of Occupancy (Dwell Time)	
	CH 0: 2402MHz	GFSK DH3

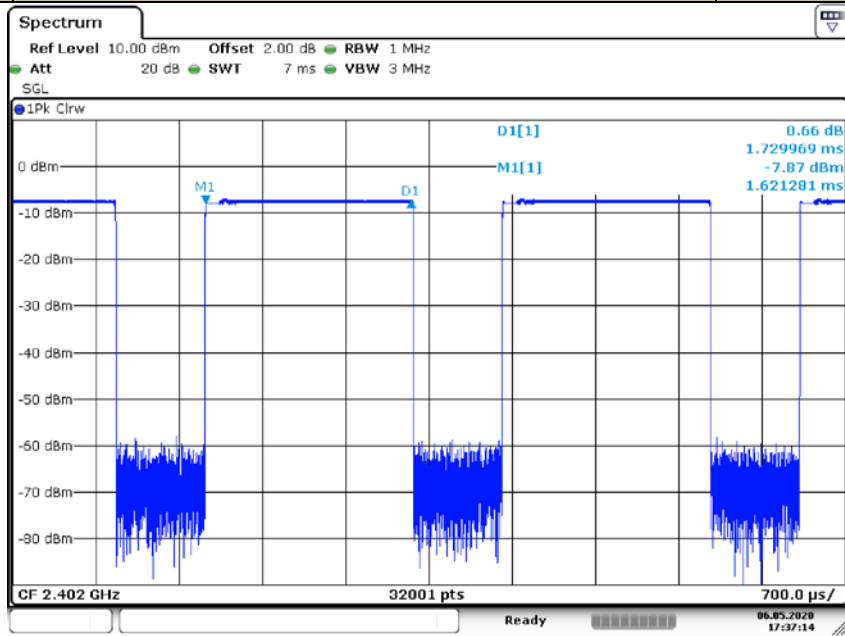

Date: 6.MAY.2020 17:37:14

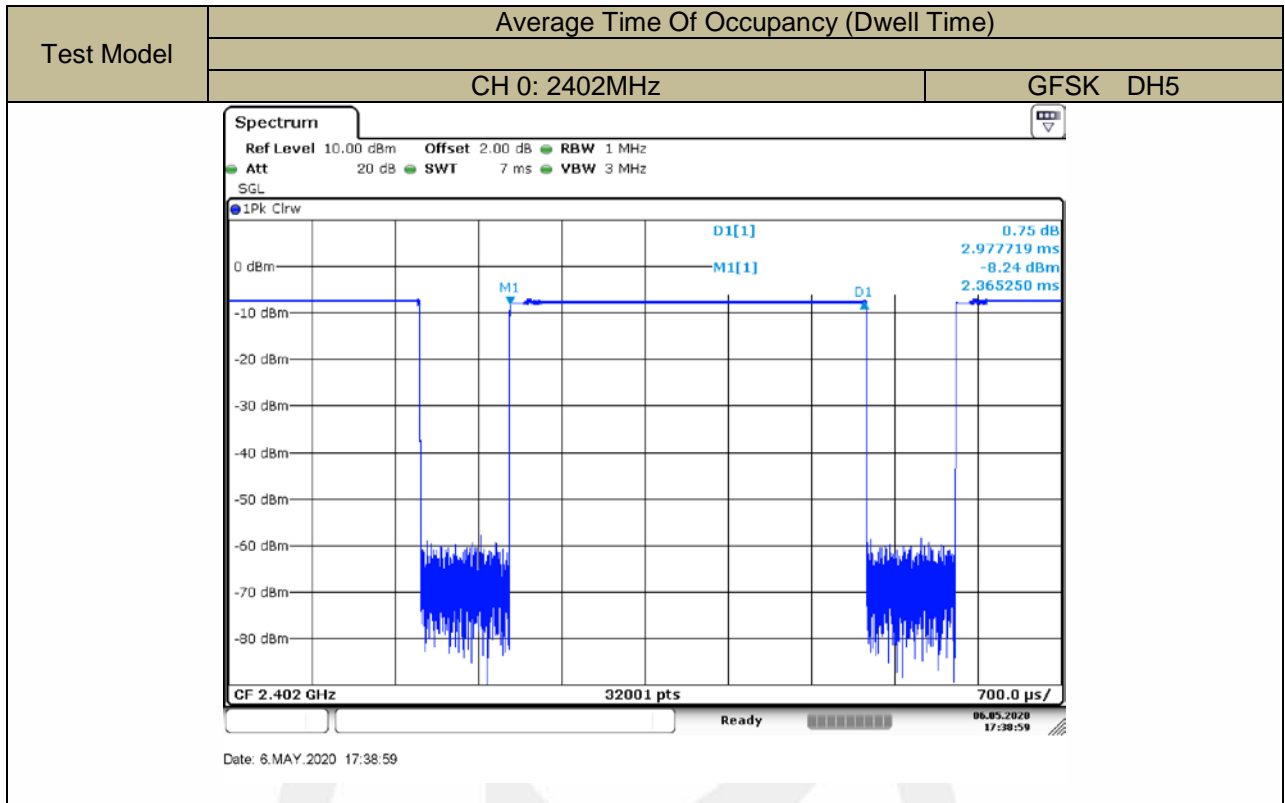

Test Model	Maximum Peak Conducted Output Power	
	Channel 0: 2402MHz	GFSK

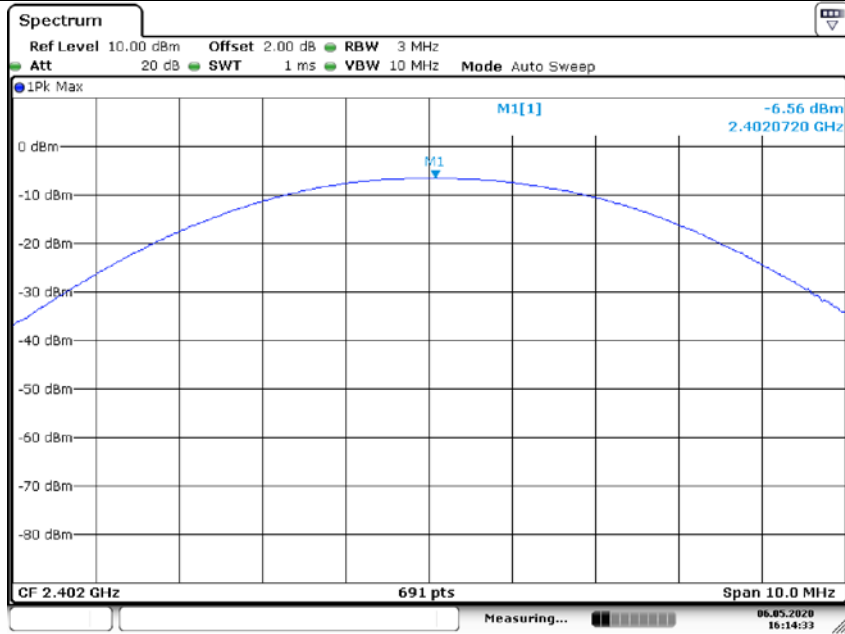

Date: 6.MAY.2020 16:14:34

Test Model	Maximum Peak Conducted Output Power	
	Channel 39: 2441MHz	GFSK

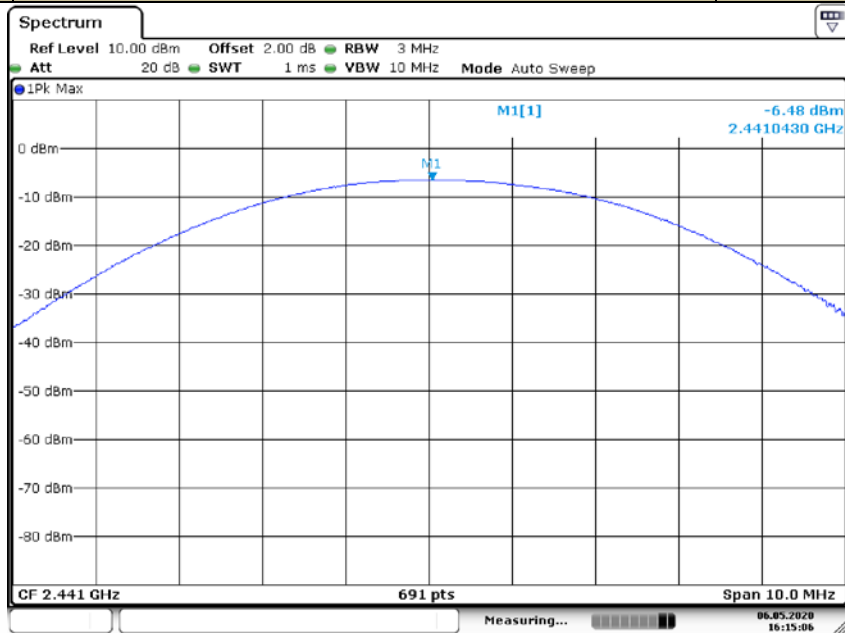

Date: 6.MAY.2020 16:15:06

Test Model	Maximum PeakConducted Output Power	
	Channel 78: 2480MHz	GFSK

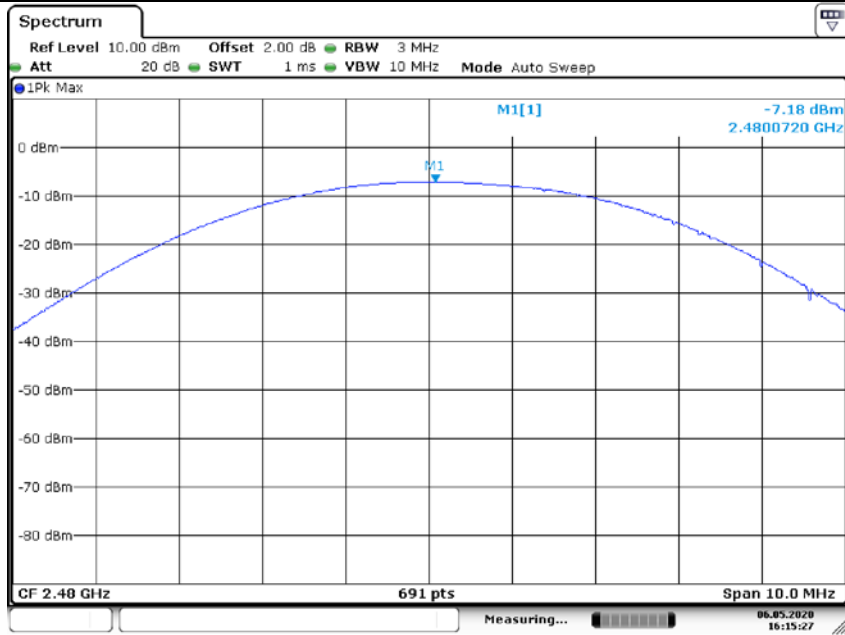

Date: 6.MAY.2020 16:15:28

Test Model	Maximum PeakConducted Output Power	
	Channel 0: 2402MHz	pi/4-DQPSK

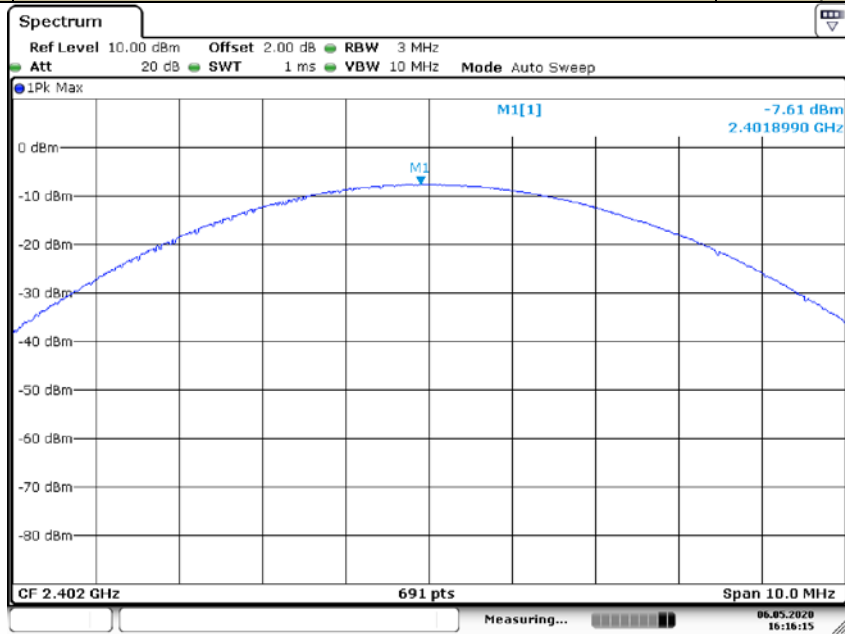

Date: 6.MAY.2020 16:16:15

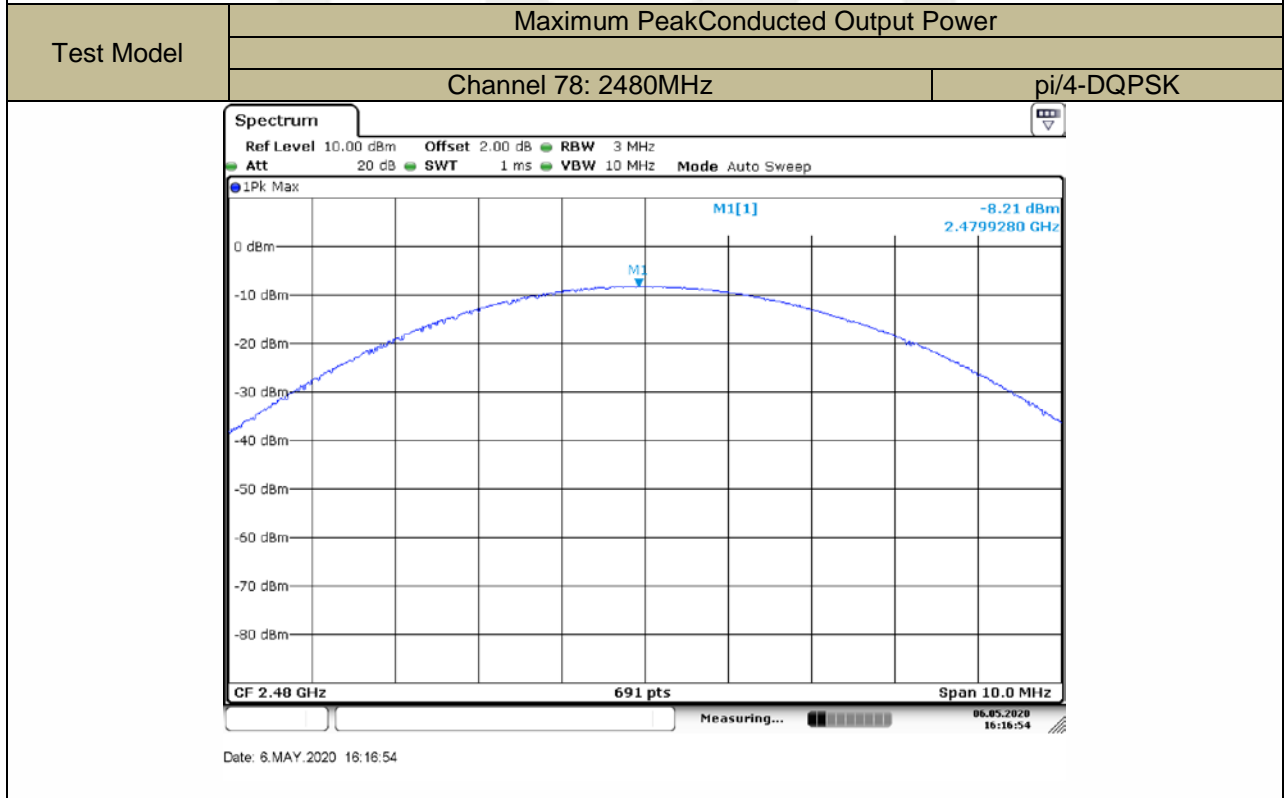
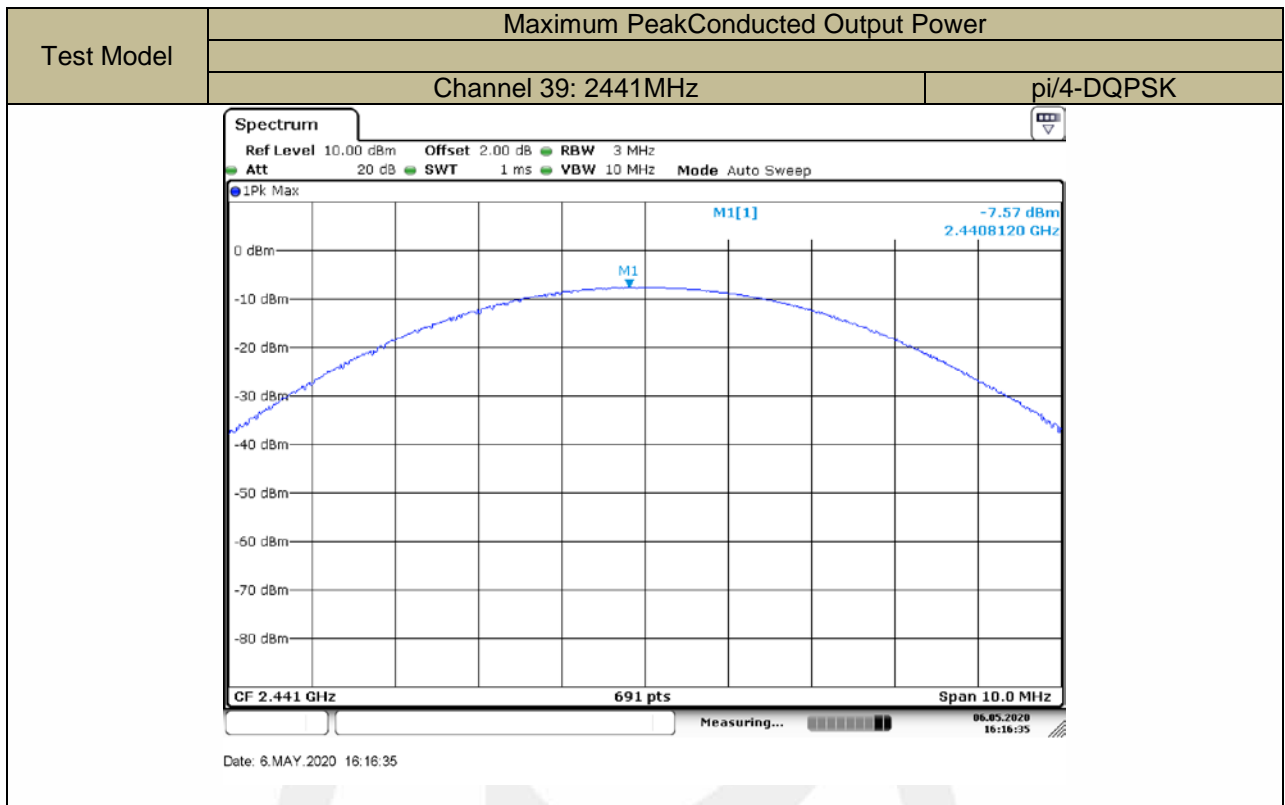

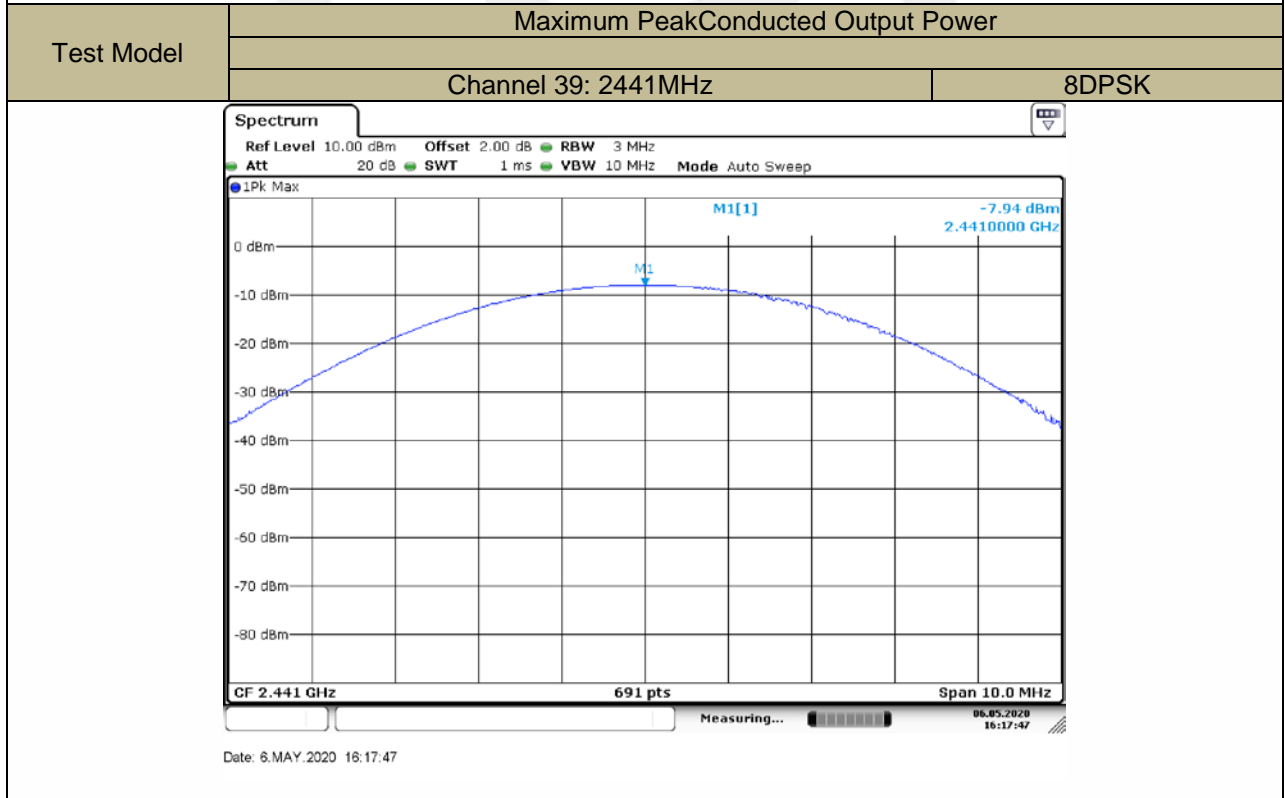
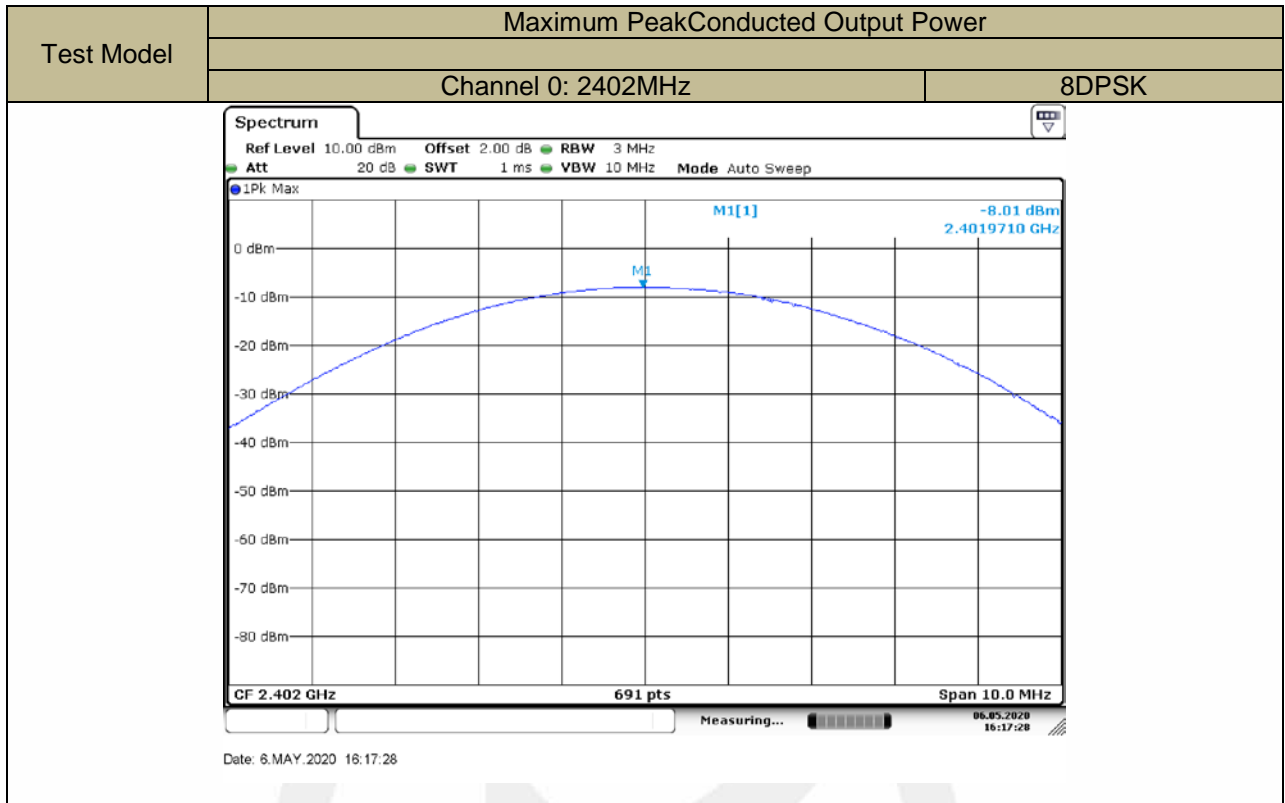

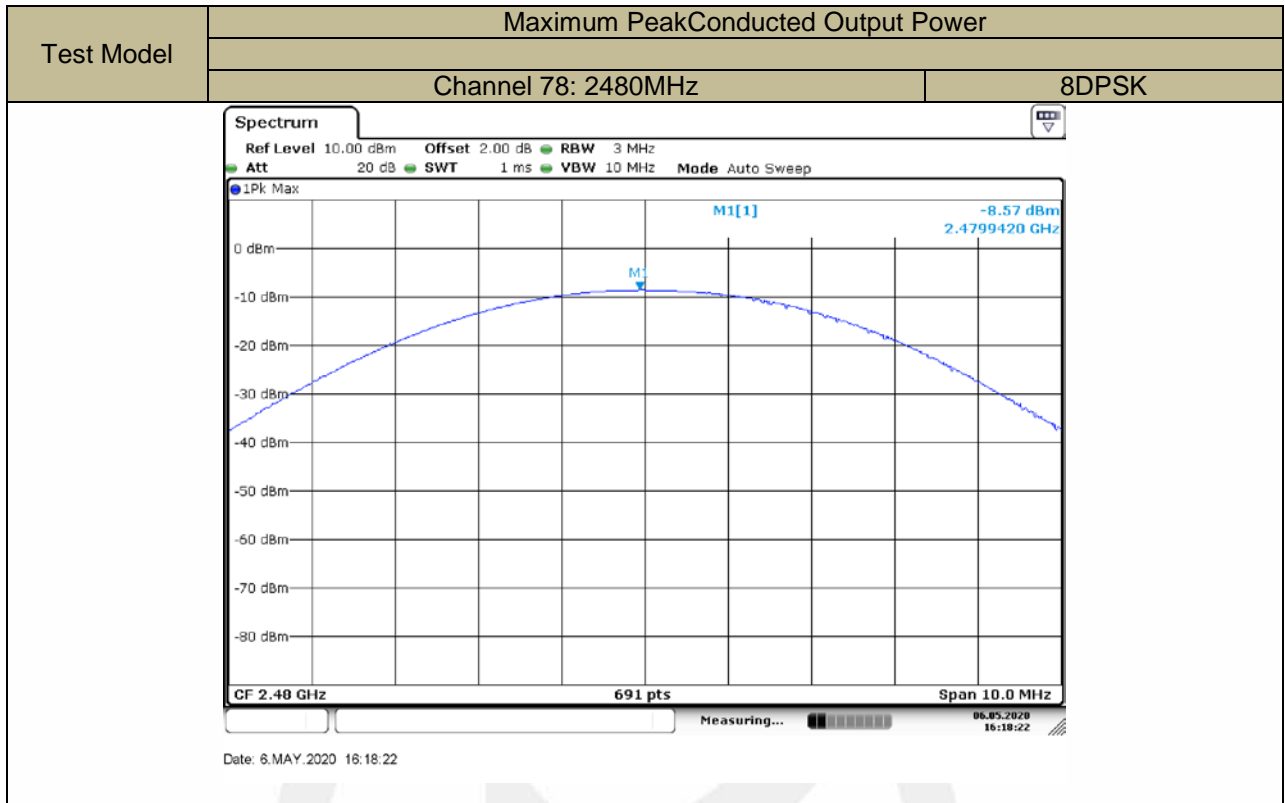

9.6 CONDUCTED SUPRIIOUS EMISSION

9.6.1 Applicable Standard

According to FCC Part 15.247(d) and 558074 D01 15.247 Meas Guidance V05r02

9.6.2 Conformance Limit

According to FCC Part 15.247(d):

In any 100 kHz bandwidth outside the frequency band in which the spread spectrum intentional radiator is operating, the radio frequency power that is produced by the intentional radiator shall be at least 20 dB below that in the 100 kHz bandwidth within the band that contains the highest level of the desired power, based on either an RF conducted, provided the transmitter demonstrates compliance with the peak conducted power limits.

9.6.3 Test Configuration

Test according to clause 7.1 radio frequency test setup 1

9.6.4 Test Procedure

The transmitter output (antenna port) was connected to the spectrum analyzer

■ Reference level measurement

Establish a reference level by using the following procedure:

Set instrument center frequency to DSS channel center frequency.

Set Span = approximately 5 times the 20 dB bandwidth, centered on a hopping channel.

Set the RBW = 100 kHz. Set the VBW $\geq 3 \times$ RBW.

Set Detector = peak. Set Sweep time = auto couple.

Set Trace mode = max hold. Allow trace to fully stabilize.

Use the peak marker function to determine the maximum Maximumconducetedlevel.

Note that the channel found to contain the maximum conduceted level can be used to establish the reference level.

■ Band-edge Compliance of RF Conducted Emissions

Use the following spectrum analyzer settings:

Span = wide enough to capture the peak level of the emission operating on the channel closest to the band-edge, as well as any modulation products which fall outside of the authorized band of operation

Set RBW $\geq 1\%$ of the span=100kHzSet VBW \geq RBW

Set Sweep = autoSetDetector function = peakSetTrace = max hold

Allow the trace to stabilize. Set the marker on the emission at the bandedge, or on the highest modulation product outside of the band, if this level is greater than that at the bandedge. Enable the marker-delta function, then use the marker-to-peak function to move the marker to the peak of the in-band emission. The marker-delta value now displayed must comply with the limit specified in this Section.

Now, using the same instrument settings, enable the hopping function of the EUT. Allow the trace to stabilize. Follow the same procedure listed above to determine if any spurious emissions caused by the hopping function also comply with the specified limit.

■ ConducetedSpurious RF Conducted Emission

Use the following spectrum analyzer settings:

Span = wide enough to capture the peak level of the in-band emission and all spurious emissions (e.g., harmonics) from the lowest frequency generated in the EUT up through the 10th harmonic.(30MHz to 25GHz).Set RBW = 100 kHzSetVBW \geq RBW

Set Sweep = autoSetDetector function = peakSetTrace = max hold

Allow the trace to stabilize. Set the marker on the peak of any spurious emission recorded. The level displayed must comply with the limit specified in this Section.

9.6.5 Test Results

Bluetooth (GFSK, pi/4-DQPSK, 8DPSK) mode have been tested, and the worst result(GFSK)was report as below:

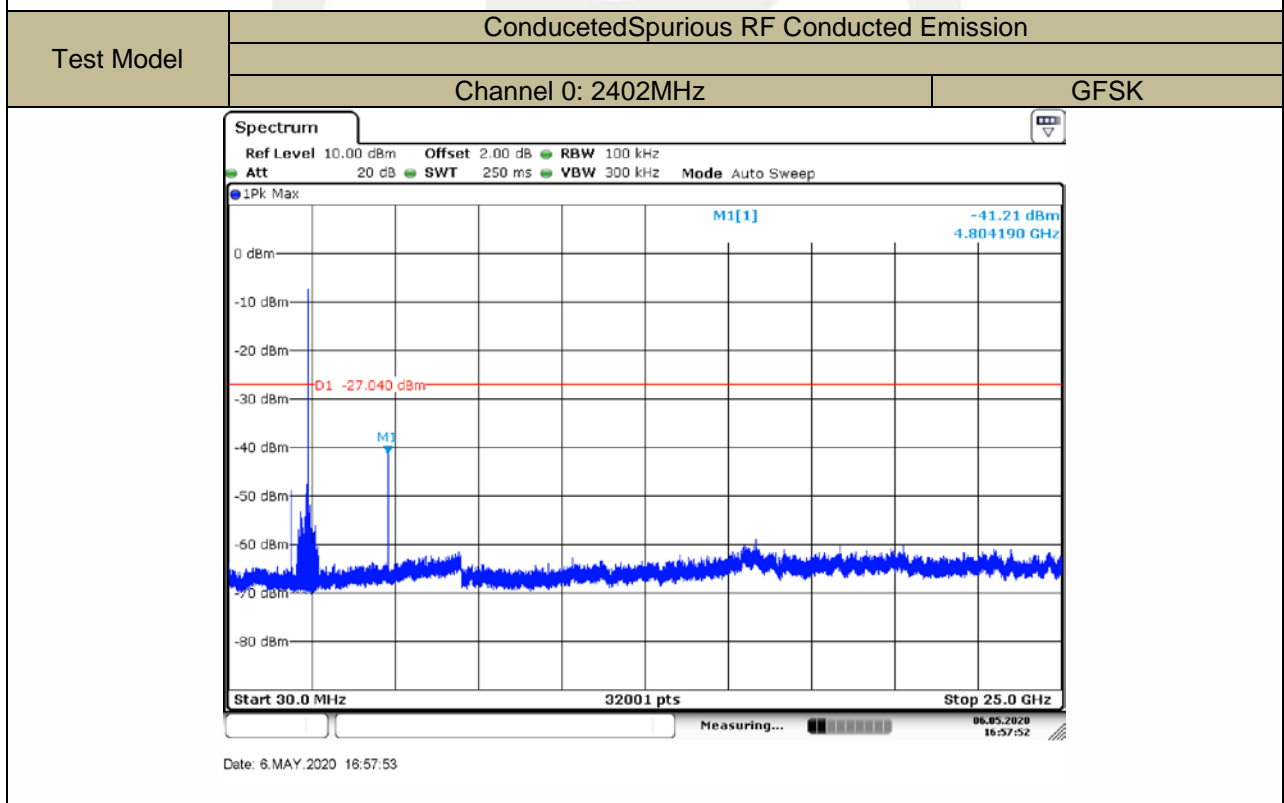
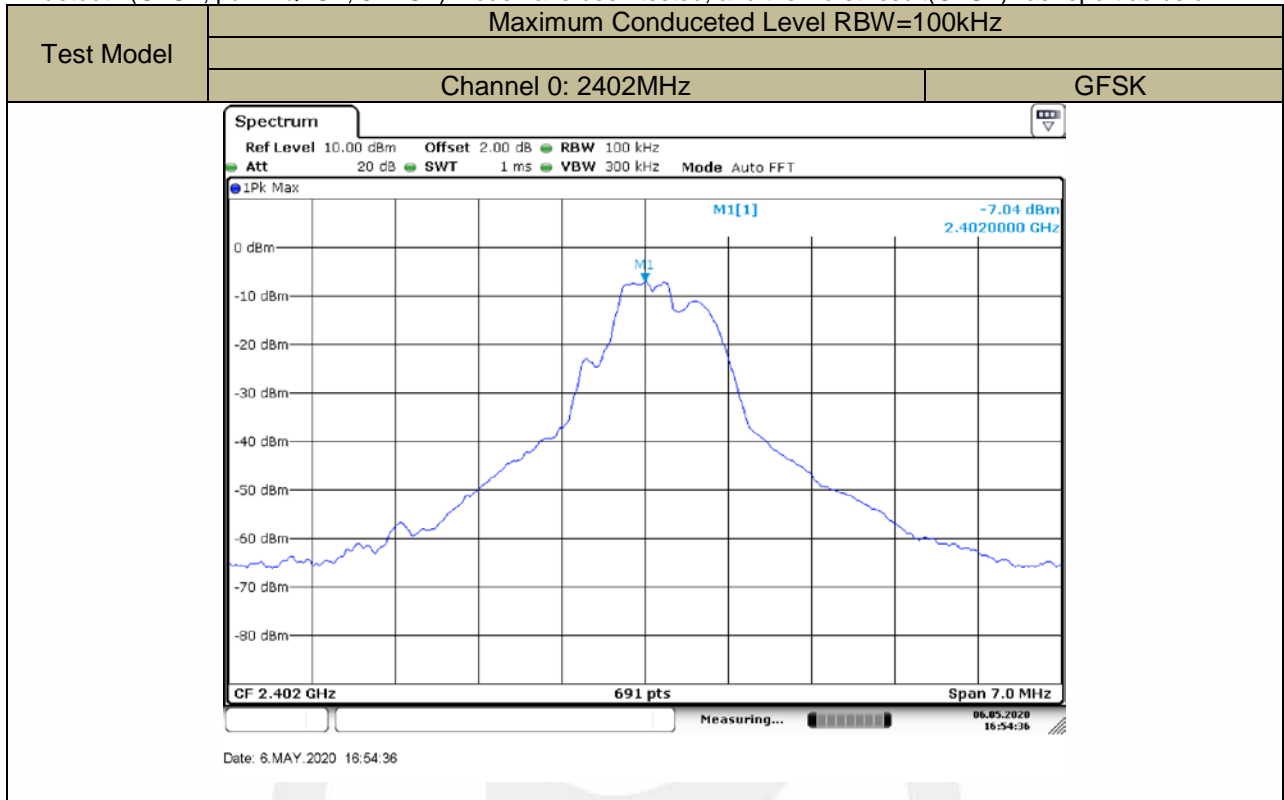

Test Model	Band-edge Conducted Emissions	
	Channel 0: 2402MHz	GFSK

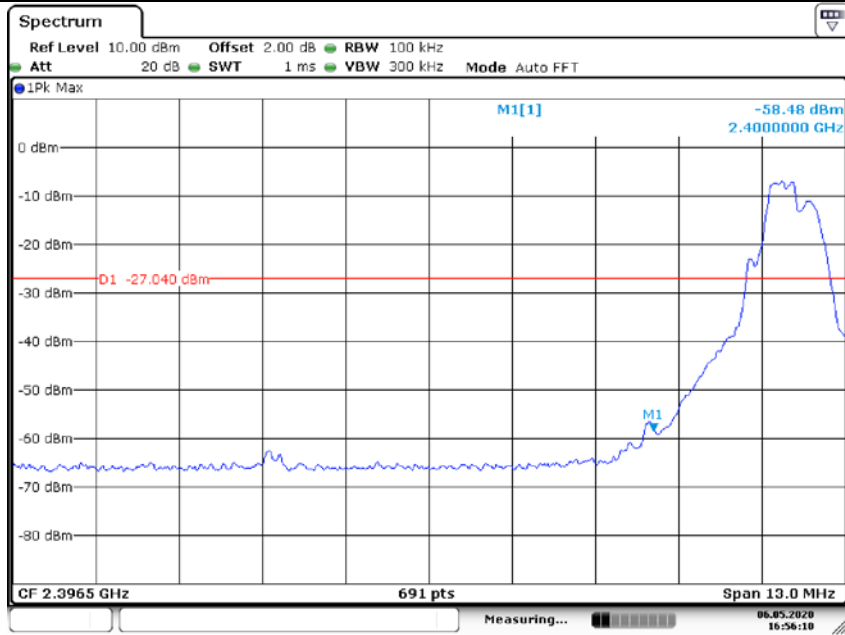

Date: 6.MAY.2020 16:56:11

Test Model	Maximum Conduceted Level RBW=100kHz	
	Channel 39: 2441MHz	GFSK

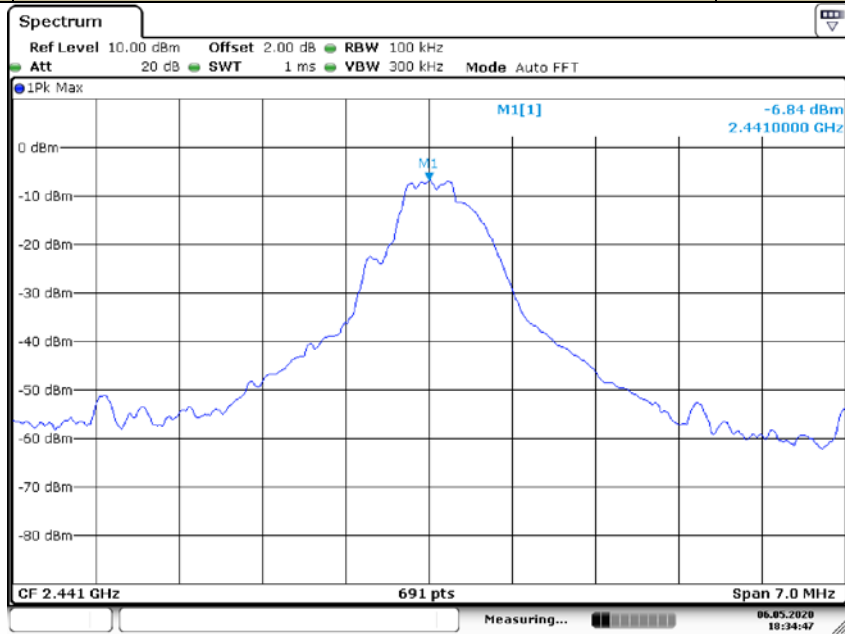

Date: 6.MAY.2020 18:34:46

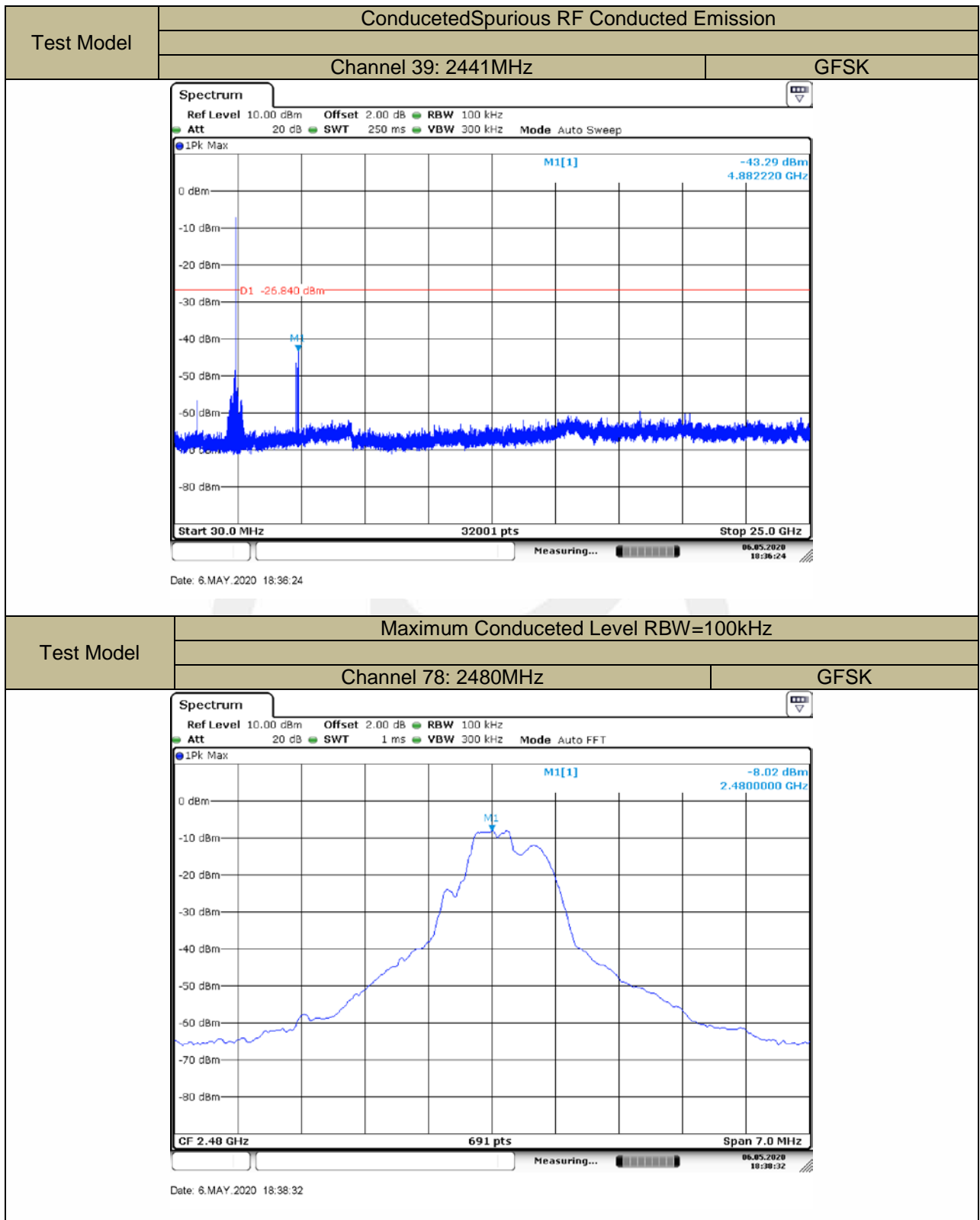

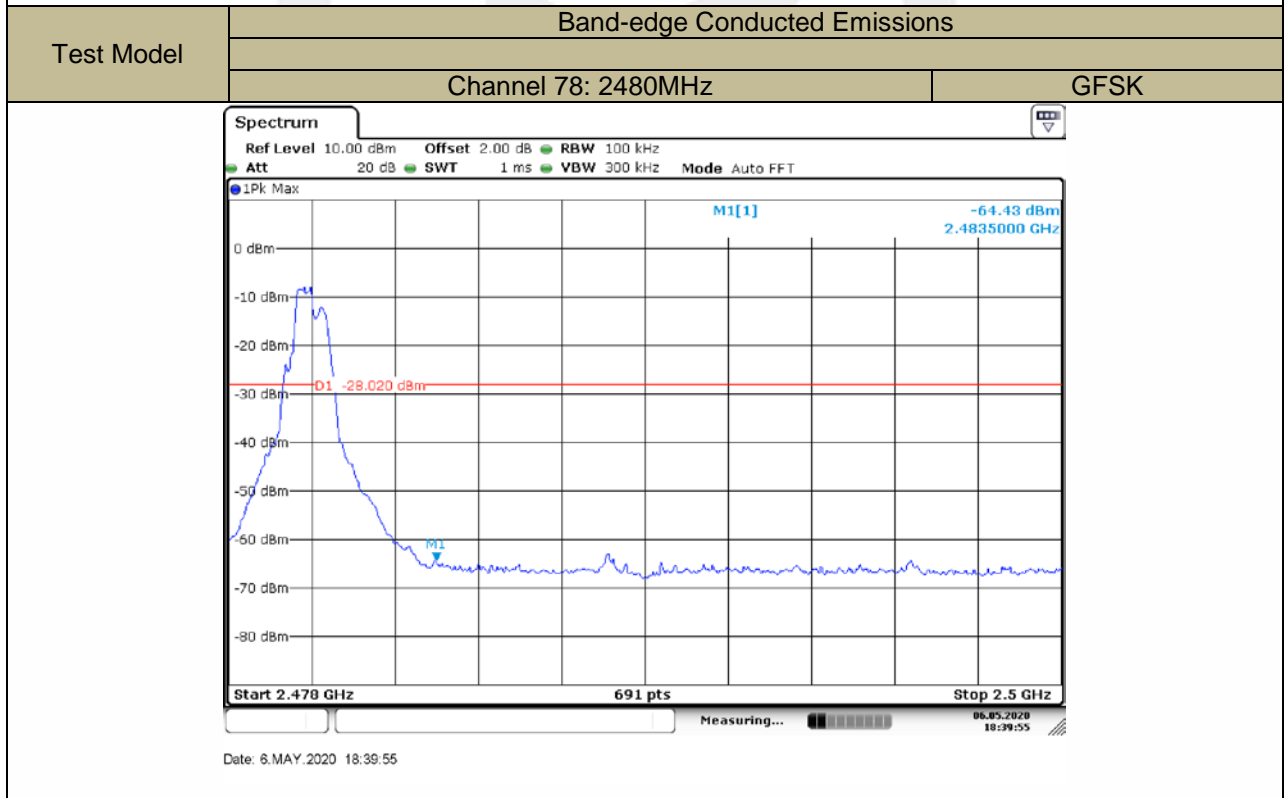
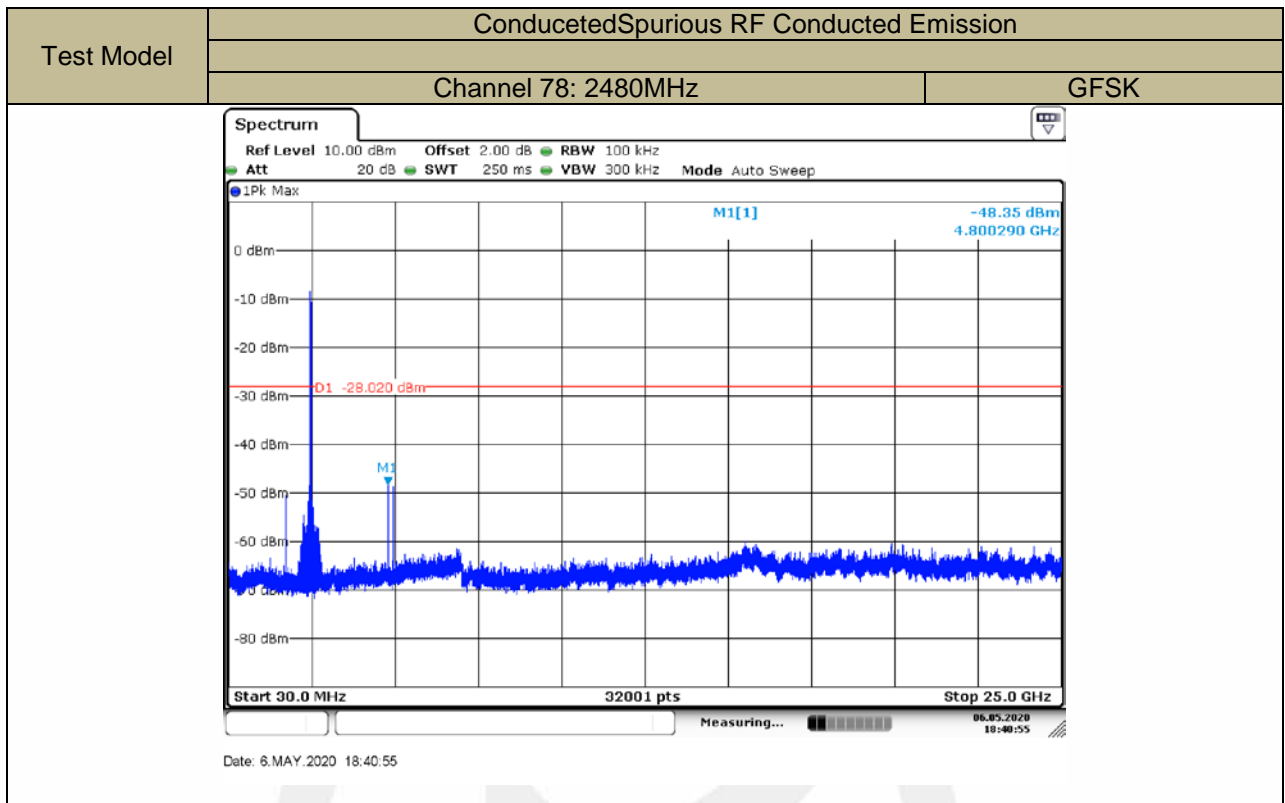

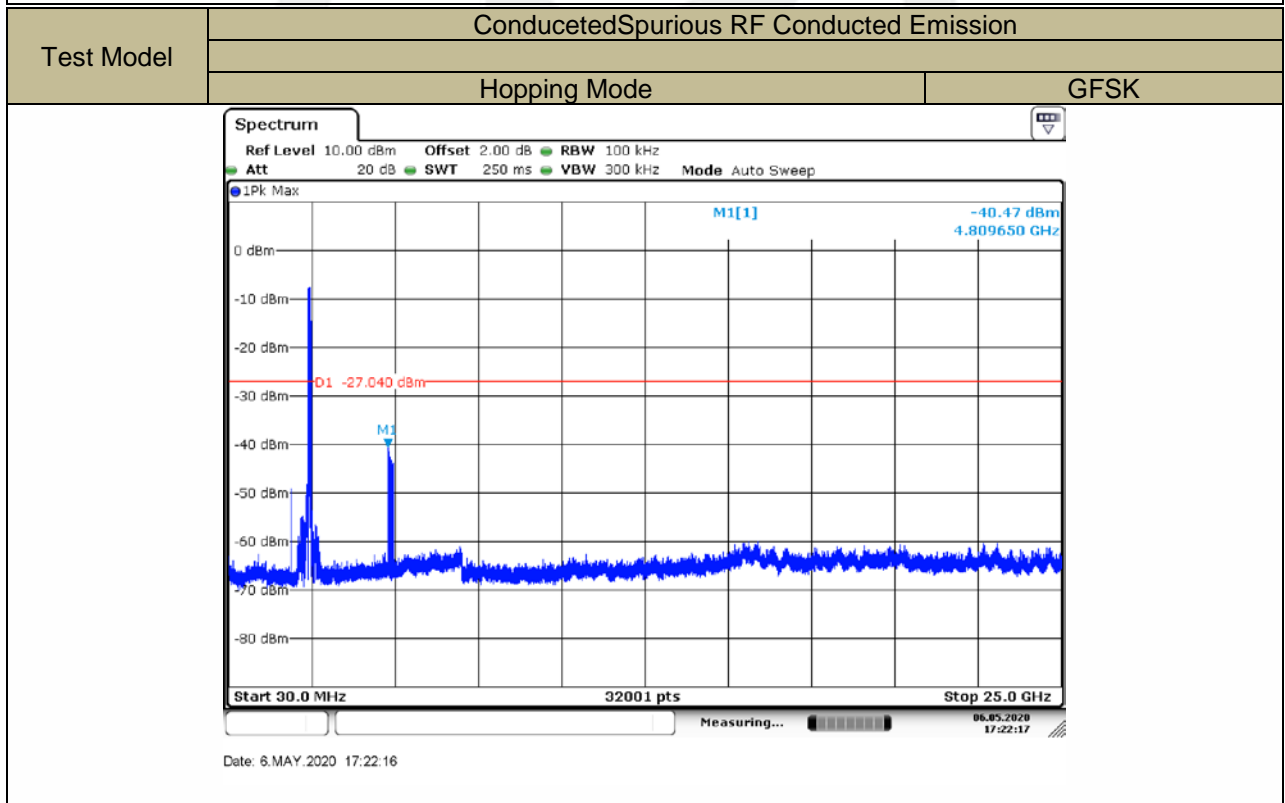
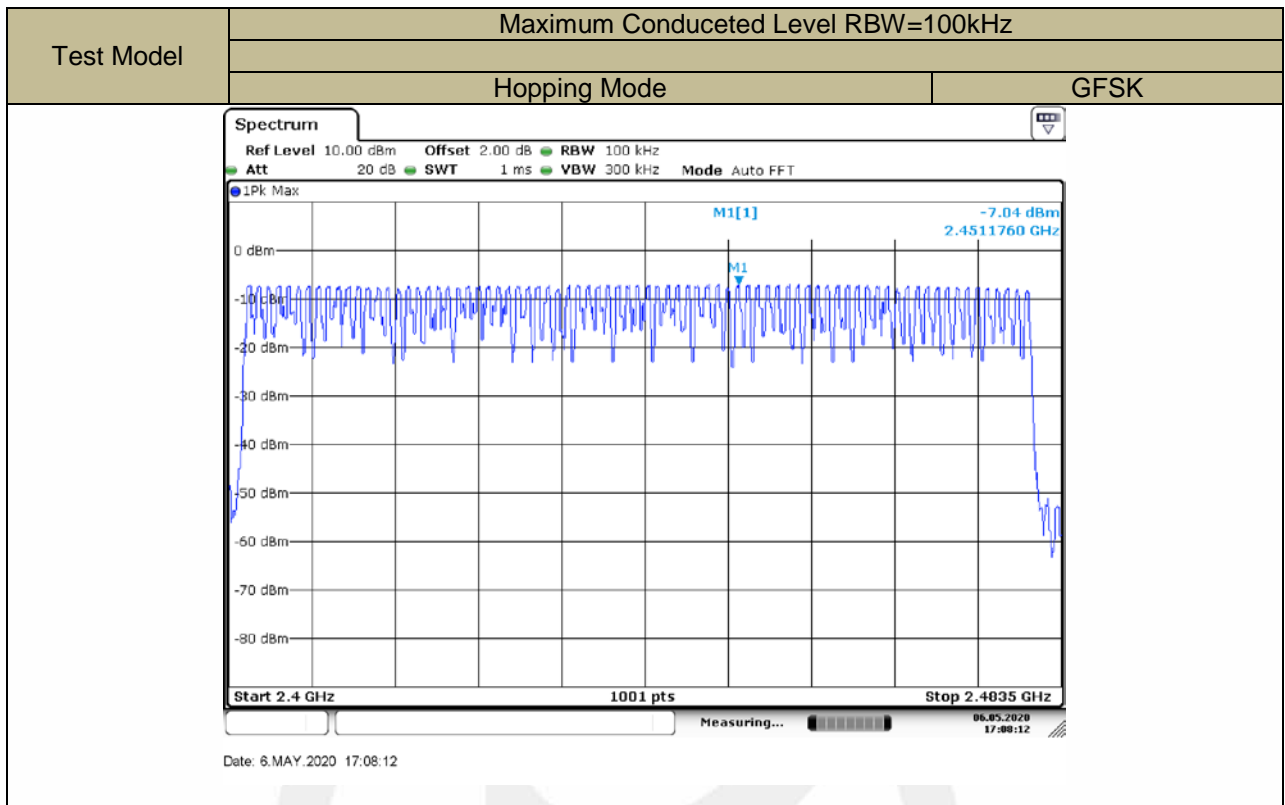

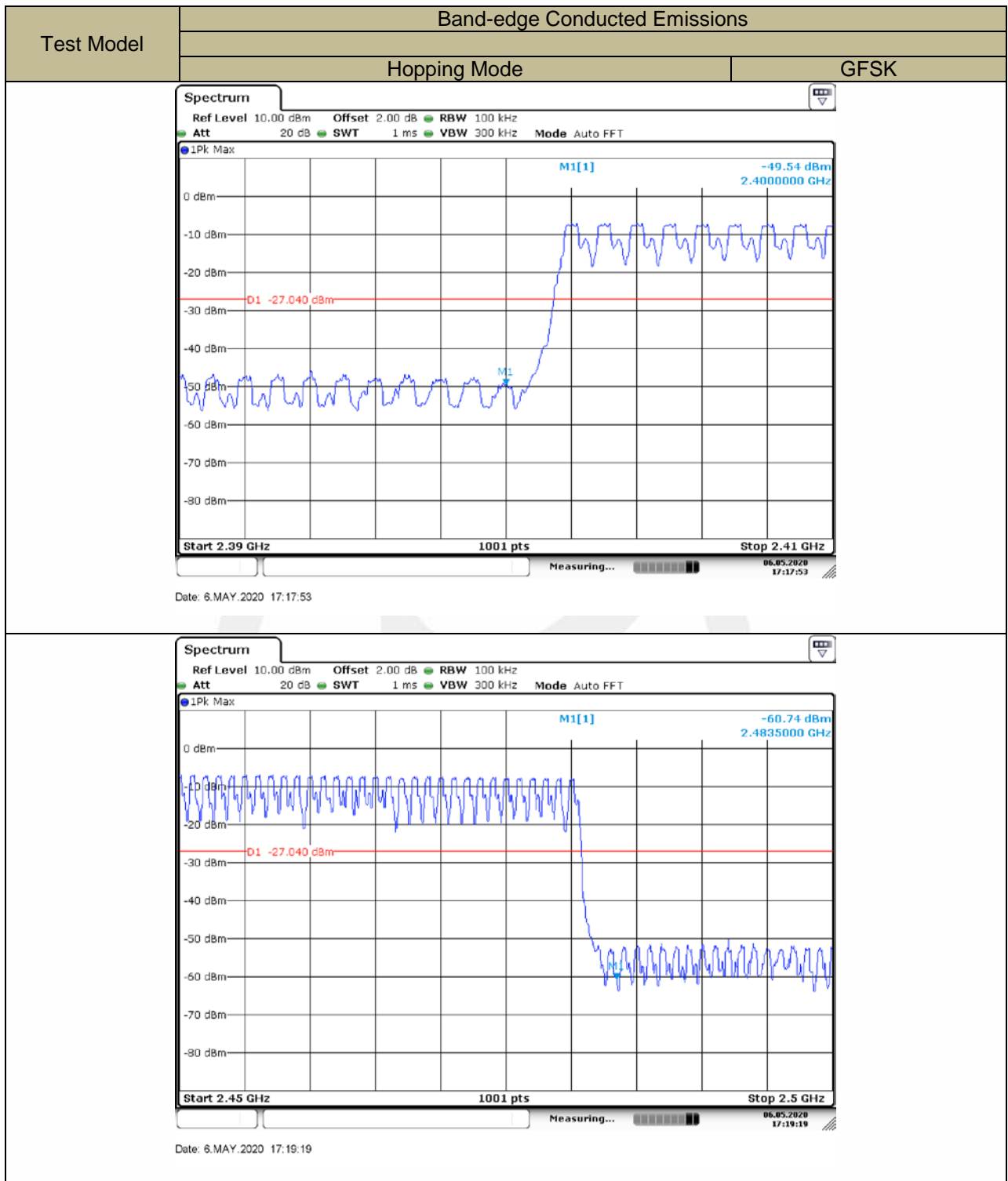

9.7 RADIATED SPURIOUS EMISSION

9.7.1 Applicable Standard

According to FCC Part 15.247(d) and 15.209 and 558074 D01 15.247 Meas Guidance V05r02

9.7.2 Conformance Limit

According to FCC Part 15.247(d): radiated emissions which fall in the restricted bands, as defined in §15.205(a), must also comply with the radiated emission limits specified in §15.209(a) (see §15.205(c)).
According to FCC Part 15.205, Restricted bands

MHz	MHz	MHz	GHz
0.090-0.110	16.42-16.423	399.9-410	4.5-5.15
10.495-0.505	16.69475-16.69525	608-614	5.35-5.46
2.1735-2.1905	16.80425-16.80475	960-1240	7.25-7.75
4.125-4.128	25.5-25.67	1300-1427	8.025-8.5
4.17725-4.17775	37.5-38.25	1435-1626.5	9.0-9.2
4.20725-4.20775	73-74.6	1645.5-1646.5	9.3-9.5
6.215-6.218	74.8-75.2	1660-1710	10.6-12.7
6.26775-6.26825	123-138	2200-2300	14.47-14.5
8.291-8.294	149.9-150.05	2310-2390	15.35-16.2
8.362-8.366	156.52475-156.52525	2483.5-2500	17.7-21.4
8.37625-8.38675	156.7-156.9	2690-2900	22.01-23.12
8.41425-8.41475	162.0125-167.17	3260-3267	23.6-24.0
12.29-12.293	167.72-173.2	3332-3339	31.2-31.8
12.51975-12.52025	240-285	3345.8-3358	36.43-36.5
12.57675-12.57725	322-335.4	3600-4400	(2)
13.36-13.41			

According to FCC Part 15.205, the level of any transmitter spurious emission in Restricted bands shall not exceed the level of the emission specified in the following table

Restricted Frequency(MHz)	Field Strength ($\mu\text{V}/\text{m}$)	Field Strength ($\text{dB}\mu\text{V}/\text{m}$)	Measurement Distance
0.009-0.490	2400/F(KHz)	20 log (uV/m)	300
0.490-1.705	24000/F(KHz)	20 log (uV/m)	30
1.705-30	30	29.5	30
30-88	100	40	3
88-216	150	43.5	3
216-960	200	46	3
Above 960	500	54	3

9.7.3 Test Configuration

Test according to clause 7.2 radio frequency test setup 2

9.7.4 Test Procedure

This test is required for any spurious emission that falls in a Restricted Band, as defined in Section 15.205. It must be performed with the highest gain of each type of antenna proposed for use with the EUT. Use the following spectrum analyzer settings:

The EUT was placed on a turn table which is 0.8m above ground plane.

Maximum procedure was performed on the highest emissions to ensure EUT compliance.

Span = wide enough to fully capture the emission being measured

RBW = 1 MHz for $f \geq 1$ GHz(1GHz to 25GHz), 100 kHz for $f < 1$ GHz(30MHz to 1GHz)

VBW \geq RBW

Sweep = auto

Detector function = peak

Trace = max hold

Temperature: 18°C
 Humidity: 42 %
 Test mode: GFSK

 Test Date: May 03, 2020
 Test By: KK
 Frequency: Channel 39: 2441MHz

Freq. (MHz)	Ant.Pol. H/V	Emission Level(dBuV/m)		Limit 3m(dBuV/m)		Over(dB)	
		PK	AV	PK	AV	PK	AV
4888.15	V	51.15	45.24	74.00	54.00	-22.85	-8.76
11335.19	V	54.10	38.45	74.00	54.00	-19.90	-15.55
18000.00	V	58.86	42.57	74.00	54.00	-15.14	-11.43
4888.15	H	51.51	46.02	74.00	54.00	-22.49	-7.98
10363.71	H	53.11	38.24	74.00	54.00	-20.89	-15.76
18000.00	H	59.92	43.14	74.00	54.00	-14.08	-10.86

 Temperature: 18°C
 Humidity: 42 %
 Test mode: GFSK

 Test Date: May 03, 2020
 Test By: KK
 Frequency: Channel 78: 2480MHz

Freq. (MHz)	Ant.Pol. H/V	Emission Level(dBuV/m)		Limit 3m(dBuV/m)		Over(dB)	
		PK	AV	PK	AV	PK	AV
4959.31	V	48.98	42.89	74.00	54.00	-25.02	-11.11
11076.09	V	54.19	38.26	74.00	54.00	-19.81	-15.74
13957.52	V	55.49	39.99	74.00	54.00	-18.51	-14.01
4959.31	H	49.31	43.25	74.00	54.00	-24.69	-10.75
10854.25	H	53.30	37.24	74.00	54.00	-20.70	-16.76
18000.00	H	59.39	42.75	74.00	54.00	-14.61	-11.25

- Note:**
- (1) All Readings are Peak Value (VBW=3MHz) and Average Value (VBW=10Hz).
 - (2) Emission Level= Reading Level+Probe Factor +Cable Loss.
 - (3) The reading of emissions are attenuated more than 20dB below the permissible limits or the field strength is too small to be measured.

■ Spurious Emission in Restricted Band 2310-2390MHz and 2483.5-2500MHz

Bluetooth (GFSK, pi/4-DQPSK, 8DPSK) mode have been tested, and the worst result(GFSK, Hopping) was report as below:

Temperature: 24°C Test Date: May 03, 2020
 Humidity: 55% Test By: XW
 Test mode: GFSK Frequency: Channel 0: 2402MHz

Frequency (MHz)	Polarity H/V	PK(dBuV/m) (VBW=3MHz)	Limit 3m (dBuV/m)	Over(dB)	AV(dBuV/m) (VBW=10Hz)	Limit 3m (dBuV/m)	Over (dB)
2389.520	H	49.95	74	-24.05	35.01	54	-18.99
2388.960	V	45.97	74	-28.03	30.25	54	-23.75

Temperature: 24°C Test Date: May 03, 2020
 Humidity: 55% Test By: XW
 Test mode: GFSK Frequency: Channel 78: 2480MHz

Frequency (MHz)	Polarity H/V	PK(dBuV/m) (VBW=3MHz)	Limit 3m (dBuV/m)	Over(dB)	AV(dBuV/m) (VBW=10Hz)	Limit 3m (dBuV/m)	Over (dB)
2483.615	H	46.58	74	-27.42	32.04	54	-21.96
2483.500	V	50.19	74	-23.81	35.69	54	-18.31

Temperature: 24°C Test Date: May 03, 2020
 Humidity: 55% Test By: XW
 Test mode: GFSK Frequency: Hopping

Frequency (MHz)	Polarity H/V	PK(dBuV/m) (VBW=3MHz)	Limit 3m (dBuV/m)	Over(dB)	AV(dBuV/m) (VBW=10Hz)	Limit 3m (dBuV/m)	Over (dB)
2390.000	H	44.65	74.00	-29.35	29.24	54.00	-24.76
2483.500	H	45.40	74.00	-28.40	30.54	54.00	-23.46
2390.000	V	51.95	74.00	-22.05	36.98	54.00	-17.02
2483.500	V	45.01	74.00	-28.99	31.56	54.00	-22.44

- Note:** (1) All Readings are Peak Value (VBW=3MHz) and Average Value (VBW=10Hz).
 (2) Emission Level= Reading Level+Probe Factor +Cable Loss.
 (3)The reading of emissions are attenuated more than 20dB below the permissible limits or the field strength is too small to be measured.

Test Model	Spurious Emission in Restricted Band 2310-2390MHz		
	Channel 0: 2402MHz	GFSK	H

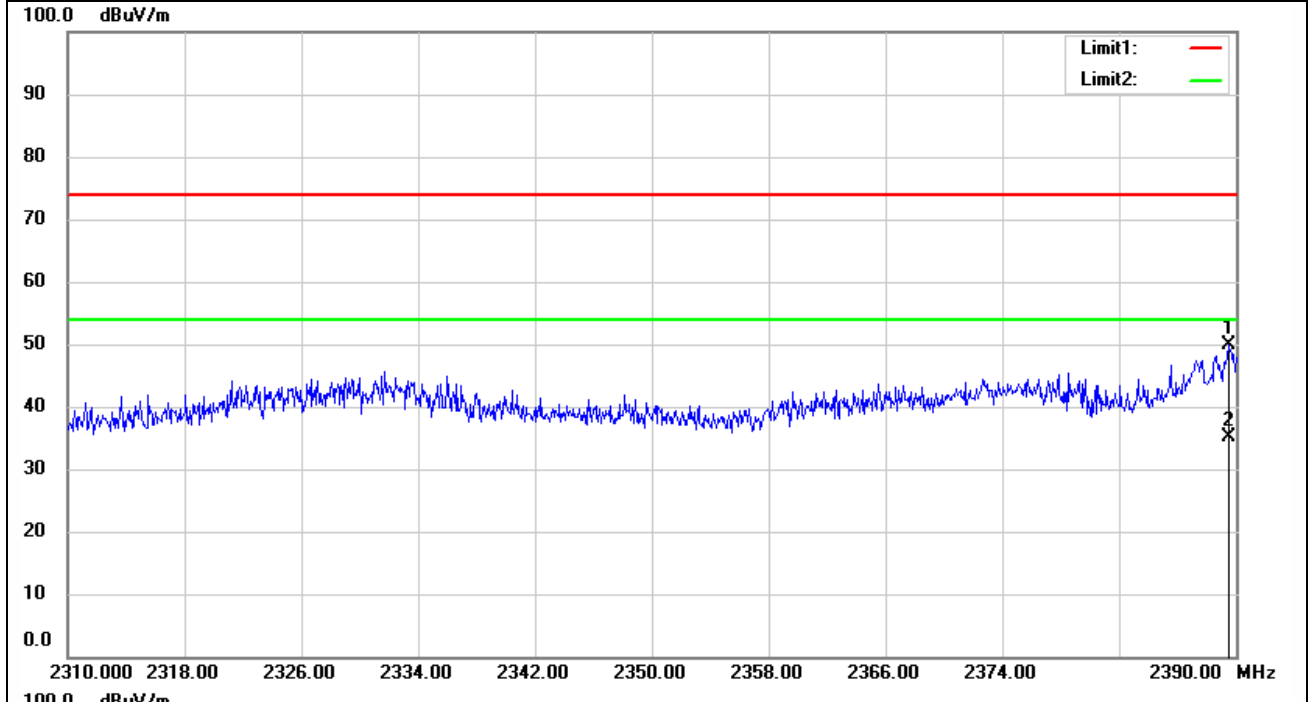

Test Model	Spurious Emission in Restricted Band 2310-2390MHz		
	Channel 0: 2402MHz	GFSK	V

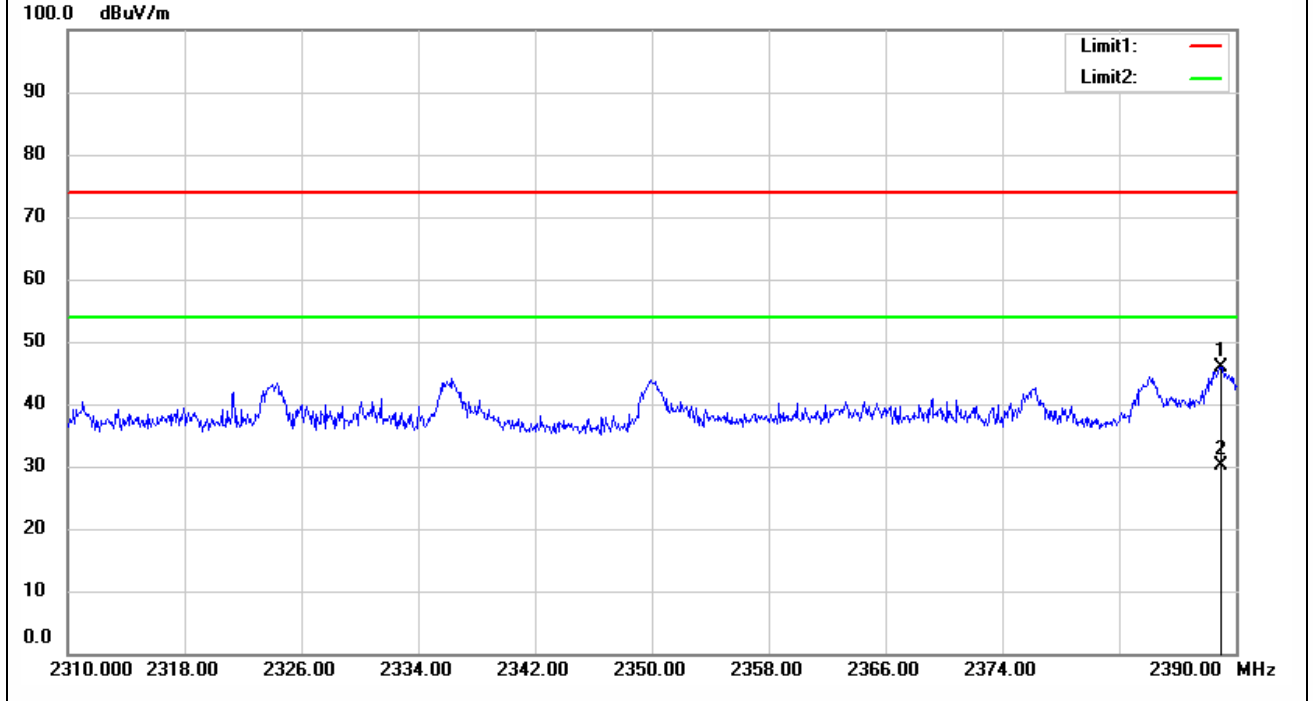

Test Model	Spurious Emission in Restricted Band 2483.5-2500MHz		
	Channel 78: 2480MHz	GFSK	H

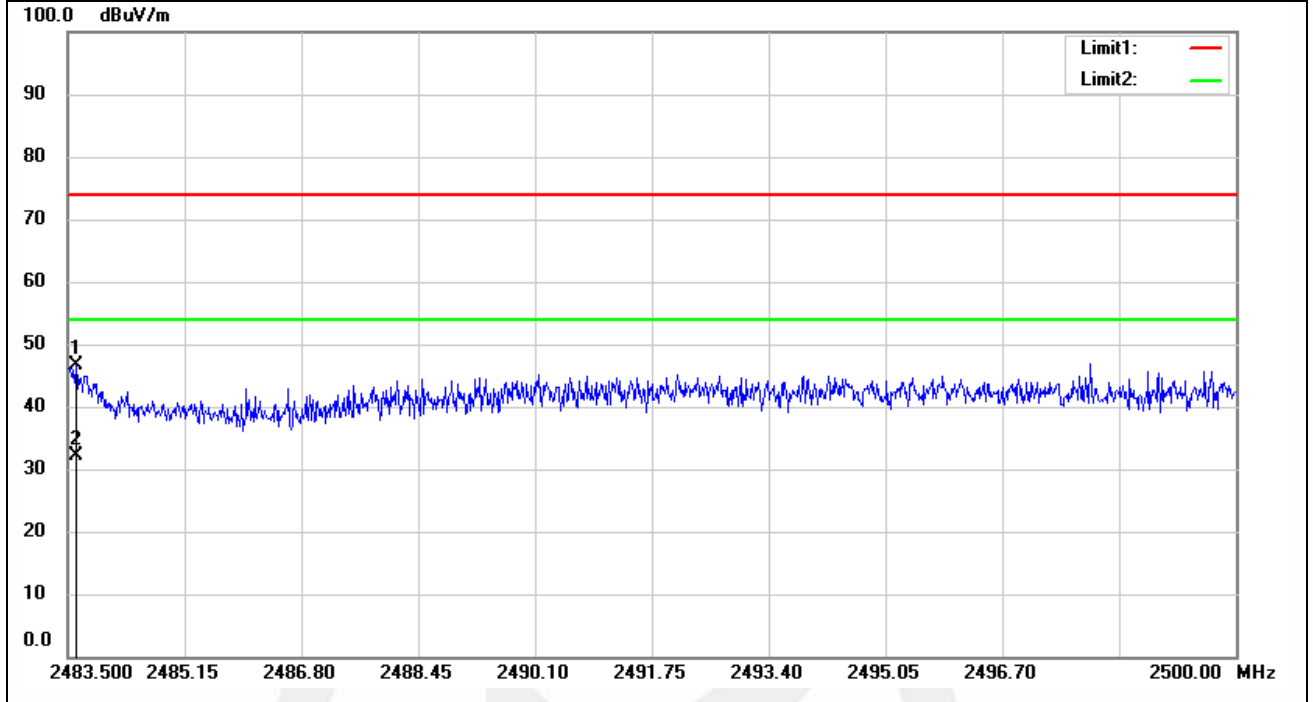

Test Model	Spurious Emission in Restricted Band 2483.5-2500MHz		
	Channel 78: 2480MHz	GFSK	V

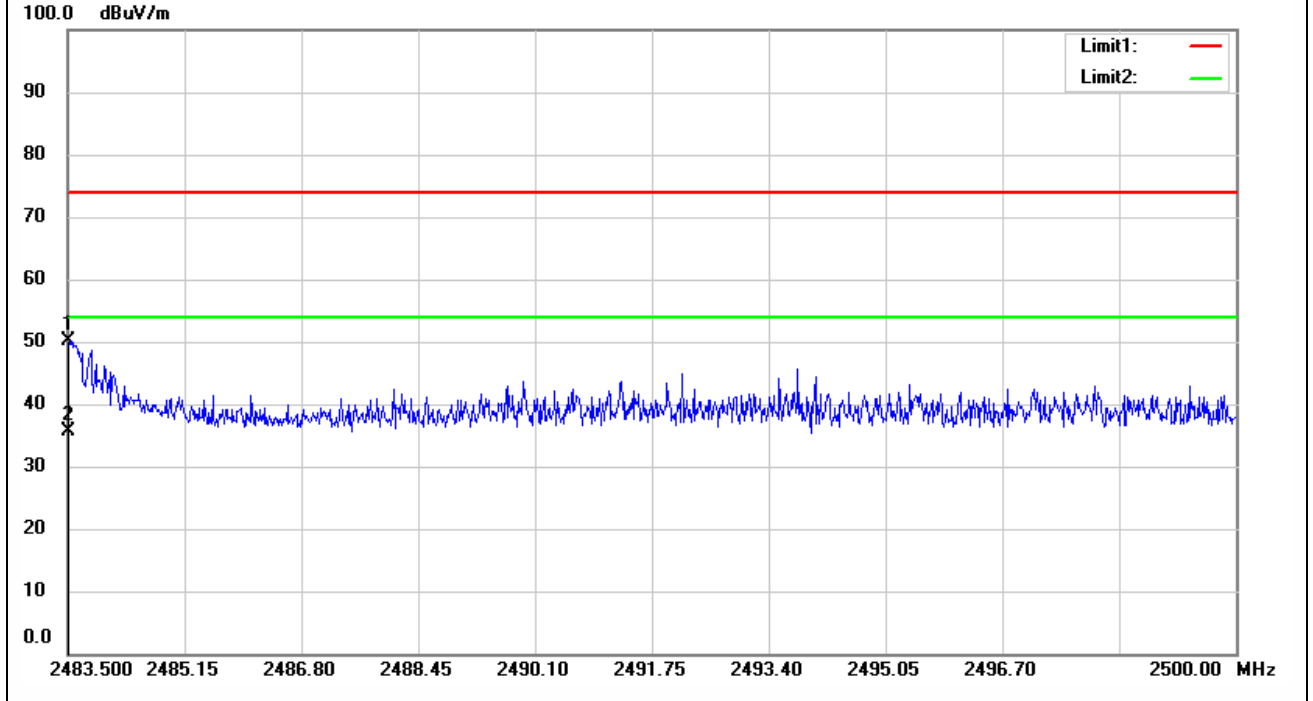

Test Model	Spurious Emission in Restricted Band 2310-2390&2483.5-2500MHz		
	Hopping	GFSK	H

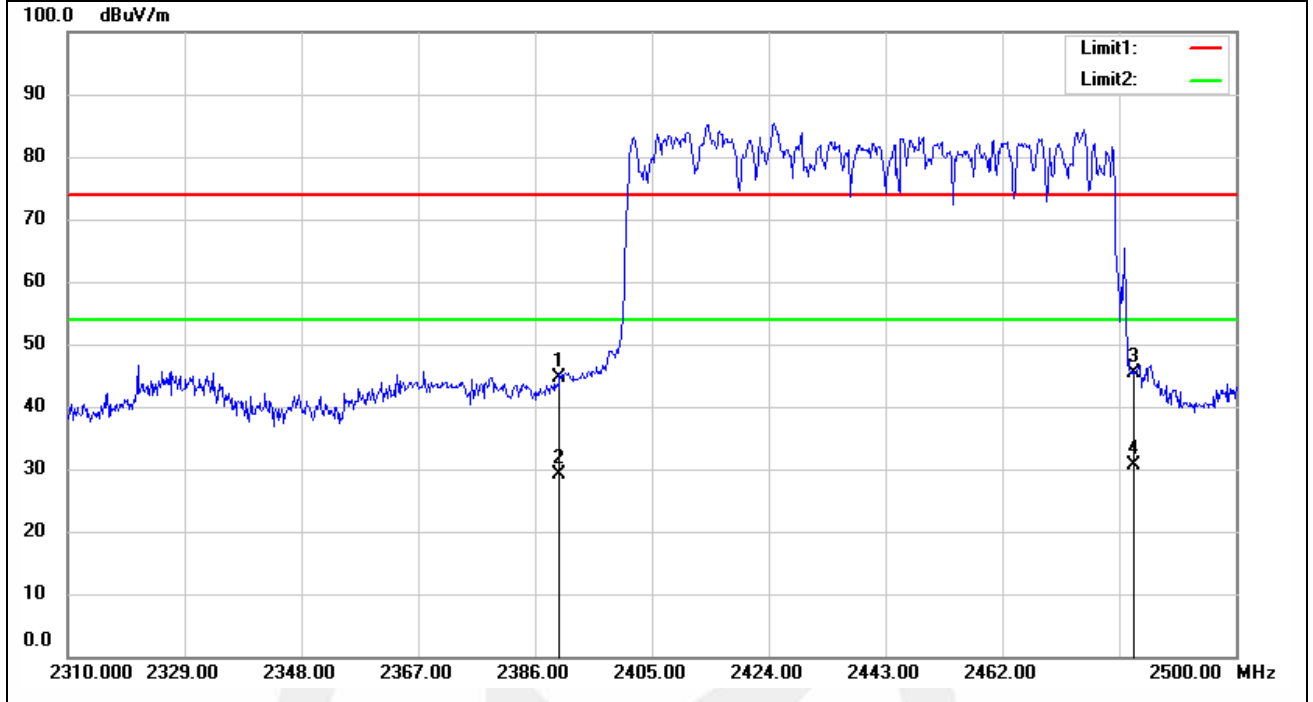

Test Model	Spurious Emission in Restricted Band 2310-2390&2483.5-2500MHz		
	Hopping	GFSK	V

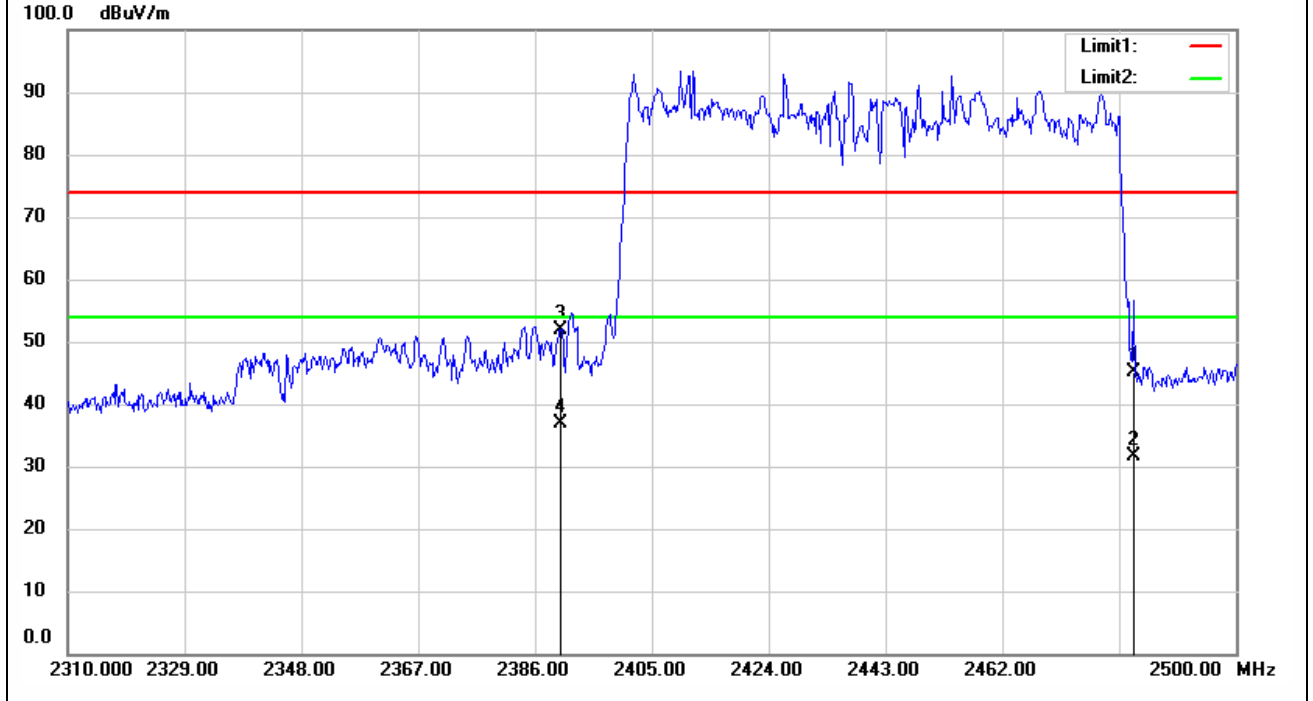

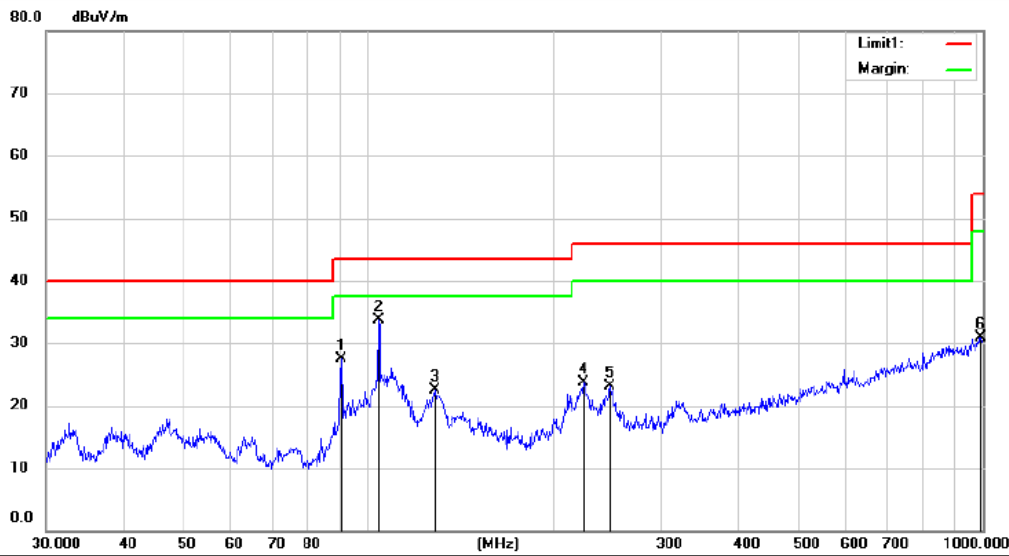

Site: 3m Chamber #3 Polarization: **Horizontal** Temperature: 22.5 C
 Limit: (RE)FCC PART 15.209 Power: AC 120V/60Hz Humidity: 45 %
 Mode: GFSK 2402MHz
 Note:

No.	Mk.	Freq. MHz	Reading Level dBuV	Correct Factor dB	Measure- ment dBuV/m	Limit dBuV/m	Over dB	Detector	Antenna Height cm	Table Degree degree	Comment
1		90.5374	44.14	-16.60	27.54	43.50	-15.96	QP			
2	*	104.1701	48.13	-14.42	33.71	43.50	-9.79	QP			
3		128.5630	38.61	-16.03	22.58	43.50	-20.92	QP			
4		224.5193	36.79	-13.05	23.74	46.00	-22.26	QP			
5		247.6820	35.86	-12.72	23.14	46.00	-22.86	QP			
6		993.0114	28.44	2.49	30.93	54.00	-23.07	QP			

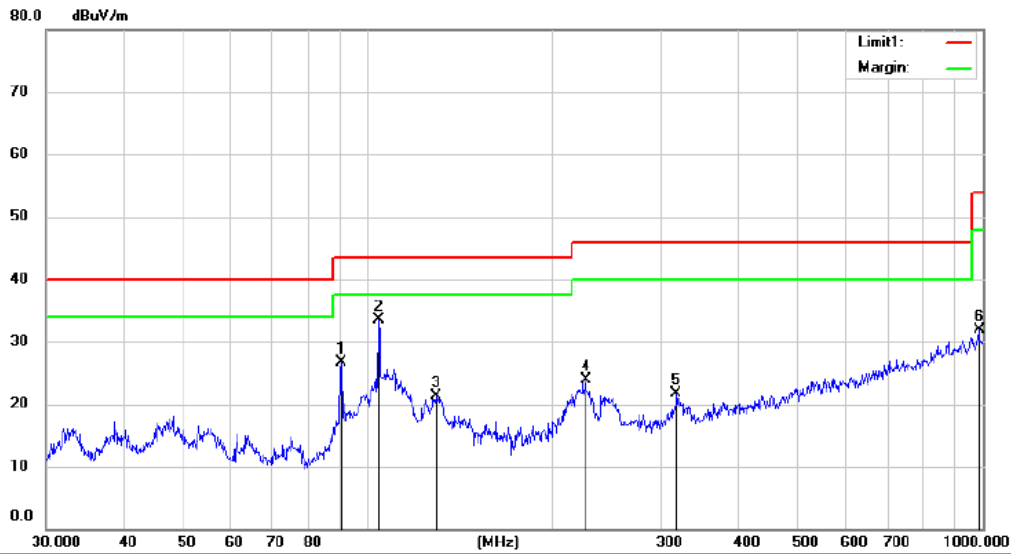

Site: 3m Chamber #3 Polarization: **Horizontal** Temperature: 22.5 C
 Limit: (RE)FCC PART 15.209 Power: AC 120V/60Hz Humidity: 45 %
 Mode: GFSK 2441MHz
 Note:

No.	Mk.	Freq. MHz	Reading Level dBuV	Correct Factor dB	Measure- ment dBuV/m	Limit dBuV/m	Over dB	Detector	Antenna Height cm	Table Degree degree	Comment
1		90.5374	43.21	-16.60	26.61	43.50	-16.89	QP			
2	*	104.1701	47.98	-14.42	33.56	43.50	-9.94	QP			
3		129.0146	37.47	-16.09	21.38	43.50	-22.12	QP			
4		226.0994	36.92	-13.05	23.87	46.00	-22.13	QP			
5		317.7011	32.27	-10.60	21.67	46.00	-24.33	QP			
6		986.0717	29.38	2.47	31.85	54.00	-22.15	QP			

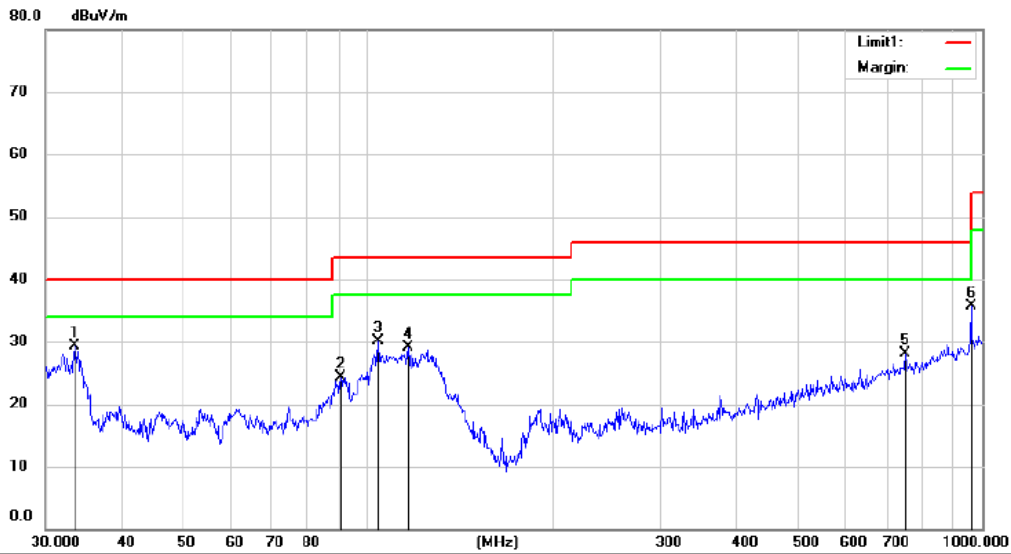

Site: 3m Chamber #3 Polarization: **Vertical** Temperature: 22.5 C
 Limit: (RE)FCC PART 15.209 Power: AC 120V/60Hz Humidity: 45 %
 Mode: GFSK 2441MHz
 Note:

No.	Mk.	Freq.	Reading Level	Correct Factor	Measurement	Limit	Over	Antenna Height	Table Degree
		MHz	dBuV	dB	dBuV/m	dBuV/m	dB	cm	degree
1		33.4450	45.15	-15.89	29.26	40.00	-10.74	QP	
2		90.5374	41.00	-16.60	24.40	43.50	-19.10	QP	
3		104.1701	44.45	-14.42	30.03	43.50	-13.47	QP	
4		116.5401	43.97	-14.87	29.10	43.50	-14.40	QP	
5		750.1083	29.41	-1.34	28.07	46.00	-17.93	QP	
6	*	958.7943	34.48	1.19	35.67	46.00	-10.33	QP	

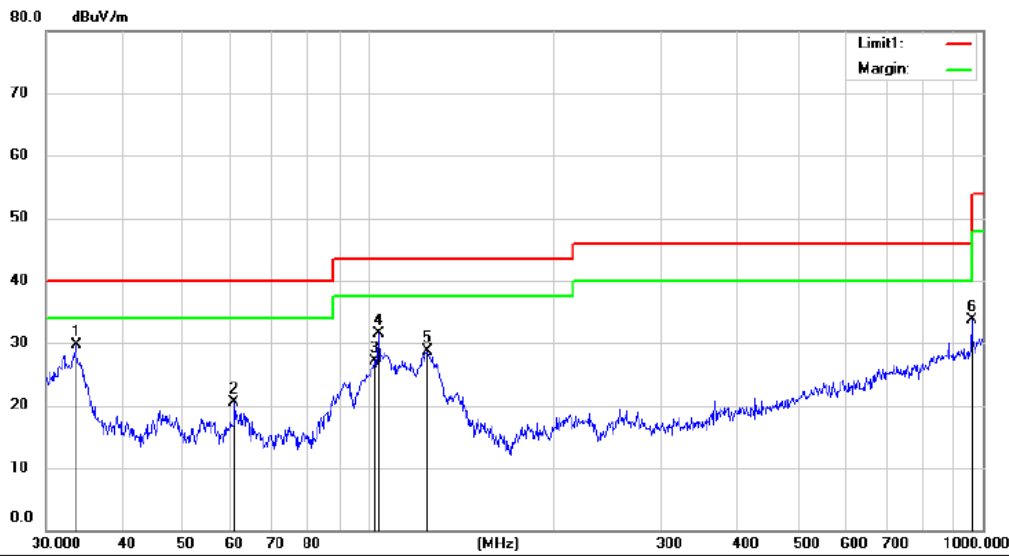

Site: 3m Chamber #3 Polarization: **Vertical** Temperature: 22.5 C
 Limit: (RE)FCC PART 15.209 Power: AC 120V/60Hz Humidity: 45 %
 Mode: GFSK 2480MHz
 Note:

No.	Mk.	Freq.	Reading Level	Correct Factor	Measurement	Limit	Over	Antenna Height	Table Degree
		MHz	dBuV	dB	dBuV/m	dBuV/m	dB	cm	degree
1	*	33.5624	45.48	-15.87	29.61	40.00	-10.39	QP	
2		60.7044	36.48	-15.96	20.52	40.00	-19.48	QP	
3		102.7192	41.63	-14.53	27.10	43.50	-16.40	QP	
4		104.1701	45.99	-14.42	31.57	43.50	-11.93	QP	
5		125.0066	44.22	-15.57	28.65	43.50	-14.85	QP	
6		958.7943	32.61	1.19	33.80	46.00	-12.20	QP	

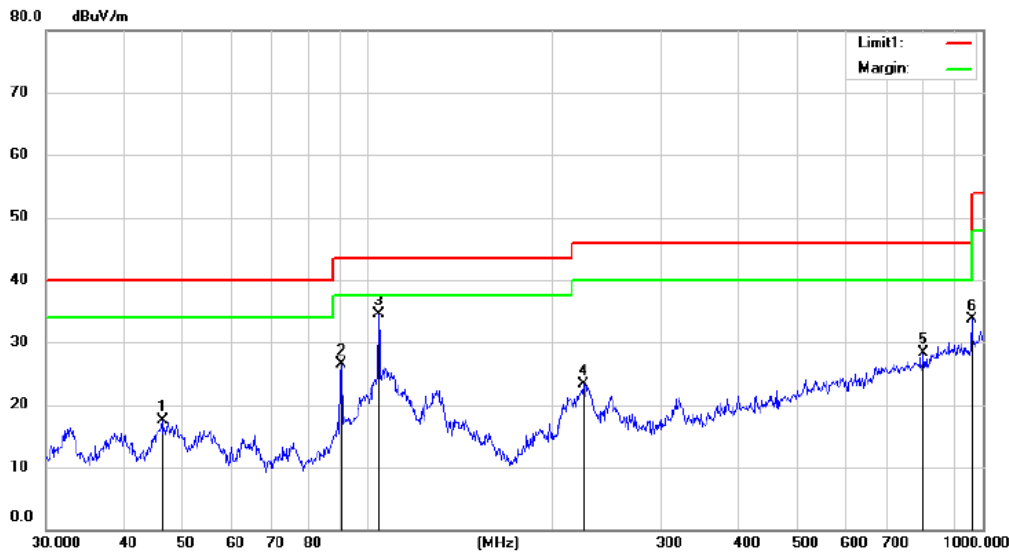

Site: 3m Chamber #3 Polarization: **Horizontal** Temperature: 22.5 C
 Limit: (RE)FCC PART 15.209 Power: AC 120V/60Hz Humidity: 45 %
 Mode: GFSK 2480MHz
 Note:

No.	Mk.	Freq.	Reading Level	Correct Factor	Measurement	Limit	Over	Antenna Height	Table Degree
		MHz	dBuV	dB	dBuV/m	dBuV/m	dB	cm	degree
1		46.3402	30.70	-13.25	17.45	40.00	-22.55	QP	
2		90.5374	43.18	-16.60	26.58	43.50	-16.92	QP	
3	*	104.1701	48.85	-14.42	34.43	43.50	-9.07	QP	
4		224.5193	36.26	-13.05	23.21	46.00	-22.79	QP	
5		801.7863	29.27	-0.98	28.29	46.00	-17.71	QP	
6		958.7943	32.61	1.19	33.80	46.00	-12.20	QP	

9.8 CONDUCTED EMISSION TEST

9.8.1 Applicable Standard

According to FCC Part 15.207(a)

9.8.2 Conformance Limit

Frequency(MHz)	Conducted Emission Limit	
	Quasi-peak	Average
0.15-0.5	66-56	56-46
0.5-5.0	56	46
5.0-30.0	60	50

Note: 1. The lower limit shall apply at the transition frequencies
2. The limit decreases in line with the logarithm of the frequency in the range of 0.15 to 0.50MHz.

9.8.3 Test Configuration

Test according to clause 7.3 conducted emission test setup

9.8.4 Test Procedure

The EUT was placed on a table which is 0.1m above ground plane.
Maximum procedure was performed on the highest emissions to ensure EUT compliance.
Repeat above procedures until all frequency measured were complete.

9.8.5 Test Results

Pass.

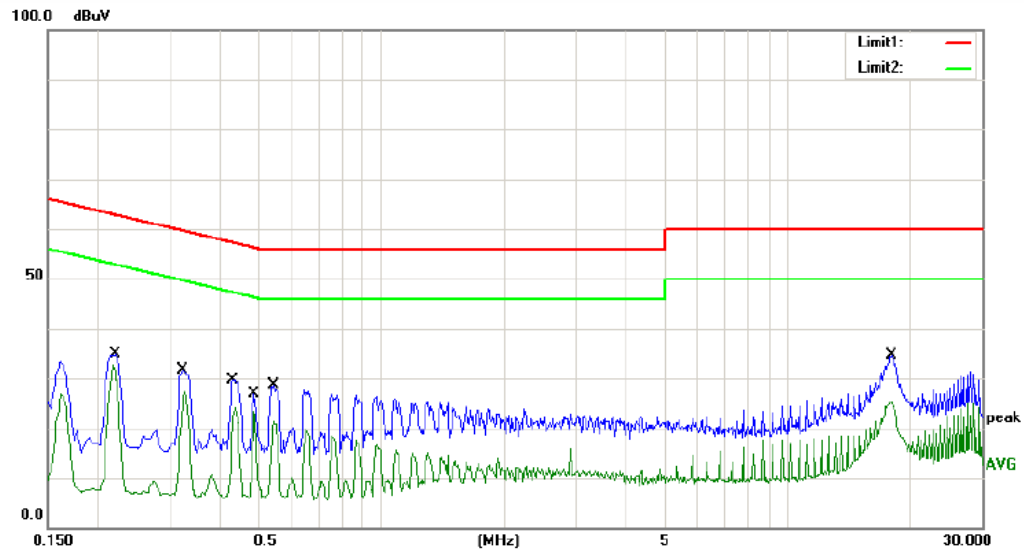

Site site #1 Phase: **L1** Temperature: 24
 Limit: (CE)FCC PART 15.207_QP Power: AC 120V/60Hz Humidity: 50 %
 Mode: Bluetooth Working
 Note:

No.	Mk.	Freq. MHz	Reading Level dBuV	Correct Factor dB	Measure- ment dBuV	Limit dBuV	Over dB	Detector	Comment
1		0.2180	24.40	10.09	34.49	62.89	-28.40	QP	
2	*	0.2180	22.40	10.09	32.49	52.89	-20.40	AVG	
3		0.3260	21.30	10.08	31.38	59.55	-28.17	QP	
4		0.3260	17.30	10.08	27.38	49.55	-22.17	AVG	
5		0.4340	19.30	10.07	29.37	57.18	-27.81	QP	
6		0.4340	14.10	10.07	24.17	47.18	-23.01	AVG	
7		0.4860	15.00	10.07	25.07	56.24	-31.17	QP	
8		0.4860	13.20	10.07	23.27	46.24	-22.97	AVG	
9		0.5420	18.50	10.06	28.56	56.00	-27.44	QP	
10		0.5420	11.30	10.06	21.36	46.00	-24.64	AVG	
11		17.9520	24.00	10.58	34.58	60.00	-25.42	QP	
12		17.9520	14.70	10.58	25.28	50.00	-24.72	AVG	

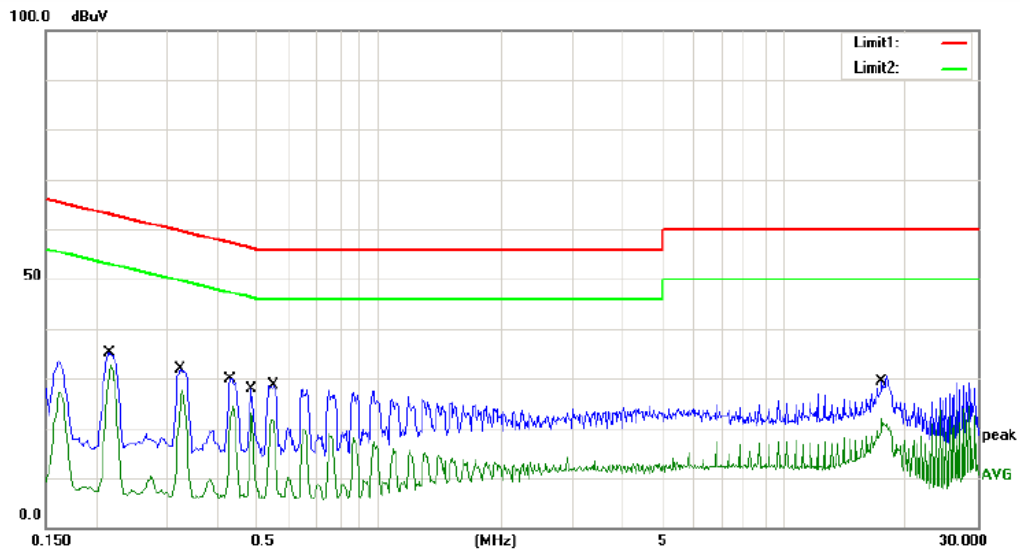

Site site #1 Phase: **N** Temperature: 24
 Limit: (CE)FCC PART 15.207_QP Power: AC 120V/60Hz Humidity: 50 %
 Mode: Bluetooth Working
 Note:

No.	Mk.	Freq. MHz	Reading Level dBuV	Correct Factor dB	Measure- ment dBuV	Limit dBuV	Over dB	Detector	Comment
1		0.2180	24.70	10.08	34.78	62.89	-28.11	QP	
2	*	0.2180	22.40	10.08	32.48	52.89	-20.41	AVG	
3		0.3260	21.40	10.09	31.49	59.55	-28.06	QP	
4		0.3260	17.60	10.09	27.69	49.55	-21.86	AVG	
5		0.4340	19.20	10.10	29.30	57.18	-27.88	QP	
6		0.4340	14.30	10.10	24.40	47.18	-22.78	AVG	
7		0.4860	17.80	10.11	27.91	56.24	-28.33	QP	
8		0.4860	13.10	10.11	23.21	46.24	-23.03	AVG	
9		0.5460	18.00	10.09	28.09	56.00	-27.91	QP	
10		0.5460	11.50	10.09	21.59	46.00	-24.41	AVG	
11		17.4280	18.80	10.63	29.43	60.00	-30.57	QP	
12		17.4280	11.10	10.63	21.73	50.00	-28.27	AVG	

9.9 ANTENNA APPLICATION

9.9.1 Antenna Requirement

Standard	Requirement
FCC CRF Part15.203	An intentional radiator shall be designed to ensure that no antenna other than that furnished by the responsible party shall be used with the device. The use of a permanently attached antenna or of an antenna that uses a unique coupling to the intentional radiator shall be considered sufficient to comply with the provisions of this section. The manufacturer may design the unit so that a broken antenna can be replaced by the user, but the use of a standard antenna jack or electrical connector is prohibited. This requirement does not apply to carrier current devices or to devices operated under the provisions of §15.211, §15.213, §15.217, §15.219, or §15.221. Further, this requirement does not apply to intentional radiators that must be professionally installed, such as perimeter protection systems and some field disturbance sensors, or to other intentional radiators which, in accordance with §15.31(d), must be measured at the installation site. However, the installer shall be responsible for ensuring that the proper antenna is employed so that the limits in this part are not exceeded.

For intentional device, according to FCC 47 CFR Section 15.203, an intentional radiator shall be designed to ensure that no antenna other than that furnished by the responsible party shall be used with the device. And according to FCC 47 CFR Section 15.247 (b), if transmitting antennas of directional gain greater than 6dBi are used, the power shall be reduced by the amount in dB that the directional gain of the antenna exceeds 6dBi.

9.9.2 Result

The EUT'S antenna is PCB antenna. The antenna's gain is -2.0dBi, and the antenna can't be replaced by the user which in accordance to section 15.203, please refer to the photos.

*** End of Report ***

声明

Statement

1. 本报告无授权批准人签字及“检验报告专用章”无效;
This report will be void without authorized signature or special seal for testing report.
2. 未经许可本报告不得部分复制;
This report shall not be copied partly without authorization.
3. 本报告的检测结果仅对送测样品有效, 委托方对样品的代表性和资料的真实性负责;
The test results or observations are applicable only to tested sample. Client shall be responsible for representativeness of the sample and authenticity of the material.
4. 本检测报告中检测项目标注有特殊符号则该项目不在资质认定范围内, 仅作为客户委托、科研、教学或内部质量控制等目的使用;
The observations or tests with special mark fall outside the scope of accreditation, and are only used for purpose of commission, research, training, internal quality control etc.
5. 本检测报告以实测值进行符合性判定, 未考虑不确定度所带来的风险, 本实验室不承担相关责任, 特别约定、标准或规范中有明确规定的除外;
The test results or observations are provided in accordance with measured value, without taking risks caused by uncertainty into account. Without explicit stipulation in special agreements, standards or regulations, EMTEK shall not assume any responsibility.
6. 对本检测报告若有异议, 请于收到报告之日起 20 日内提出;
Objections shall be raised within 20 days from the date receiving the report.