

VIDEO STREAMING DRONE

GETTING TO KNOW YOUR DRONE

PLEASE READ ALL WARNINGS AND INSTRUCTIONS PRIOR TO USE. KEEP THIS DOCUMENT AS IT CONTAINS IMPORTANT INFORMATION ABOUT YOUR DRONE.



1. CHARGING

- Drone must be charged before each use (USB Charge Cable included).
- Indicator light will turn off once fully charged.
- Install batteries in remote.

2. PAIRING

Before each flight pair the remote with the drone:

1. Turn your drone on and place on a flat, level surface.
2. Turn on the remote on and move the left joystick up, then down.
3. The beep will indicate successful pairing.
4. Repeat steps 1 and 2 if necessary.

3. DIRECTIONAL LIGHTS

- White lights indicate the front of the drone.
- Red lights indicate the back of the drone.
- Not applicable in auto-orientation mode.

4. REMOTE CONTROL OVERVIEW

Practice flying your drone below 10 feet and at low speeds until comfortable with all controls to avoid damage or injury.

- Left joystick:
 - Up/Down controls elevation
 - Left/Right controls spin
- Right joystick: controls flight direction
- Direction Trim: use to eliminate drift

To cut power to drone, move left joystick to down position.

QUESTIONS OR CONCERNS?
PLEASE GIVE US A CALL... WE'RE HERE TO HELP

CUSTOMER SUPPORT

(800) 374-2744

Before calling please locate the 10-digit code printed on the back of your remote



CHOKING HAZARD – SMALL PARTS. NOT FOR CHILDREN UNDER 3 YEARS OF AGE. ADULT ASSEMBLY REQUIRED.

VIDEO STREAMING DRONE

INTRODUCTION

Congratulations on your purchase of the Streaming 2.4 GHz Video Drone. Get ready to soar to new heights. Master the art of drone flying with remote control maneuverability. This lightweight drone will provide hours of fun.

SPECIFICATIONS

Drone Battery: 650 mAh Li-po
Remote Controller Battery: 6 x 1.5V AA
Charging Time: Approximately 100 minutes
Maximum Recommended Altitude 120 ft.

TABLE OF CONTENTS

General Warnings	Page 1
Contents and Remote Battery Installation	Page 2
Charging Battery and Replacing Propellers	Page 3
Remote Overview	Page 4
Operating Drone	Page 5
Modes	Page 6
Tips and FCC Warning	Page 7

Page i

VIDEO STREAMING DRONE

READ ALL WARNINGS AND PRECAUTIONS BEFORE USE.

SAFETY WARNINGS:

- Not recommended for children under 14 years of age. As with all electrical products, precaution should be observed during handling and use to reduce the risk of electrical shock.
 - Adult supervision is required at all times.
 - Before each use, an adult should review the product and battery to determine that no damage or hazards exist.
 - **DO NOT TOUCH SPINNING PROPELLERS.**
 - Do not allow anything to intentionally make contact in any way with spinning propellers.
 - Prevent contact with spinning blades by turning off remote prior to handling drone.
 - **Use caution and pay attention to your surroundings while operating drone.**
 - **Do not fly drone into animals, people, or inanimate objects.**
 - Keep drone away from power lines, buildings, trees, public areas, and any other potentially hazardous areas.
 - Do not operate in rain, heavy wind, and or any type of severe weather.
 - Do not land drone on wet surfaces.
 - Never touch or allow others to touch drone while it is flying.
 - Always turn drone off when it is not in use.
 - Always fly drone in large open areas.
 - Never fly drones above or near people, sudden changes in wind or other conditions could lead to unexpected crashes.
 - Always use caution when flying drone vehicles, obey relevant laws, respect the privacy and property rights of others.
 - The drone shall never be modified or used for anything except its intended purpose.
- Note: Wind above a surface is higher than at ground level.**



PLEASE RECYCLE OR
DISPOSE OF ELECTRONICS
PROPERLY RECYCLING
INFORMATION IS AVAILABLE AT
WWW.MERCHSOURCE.COM

Invasion of Privacy Warning

Always be mindful of others privacy and do not record video or take images of others without their consent. Check and comply with your federal, state and local laws regarding privacy.

Page 1

VIDEO STREAMING DRONE

CONTENTS

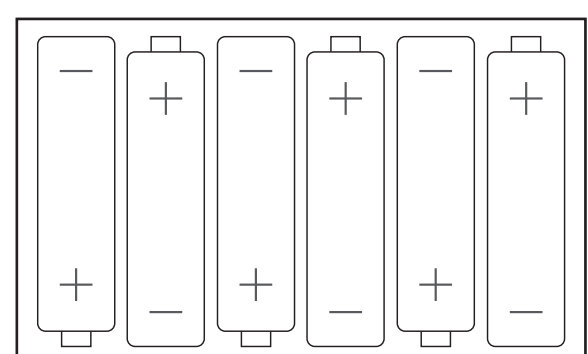
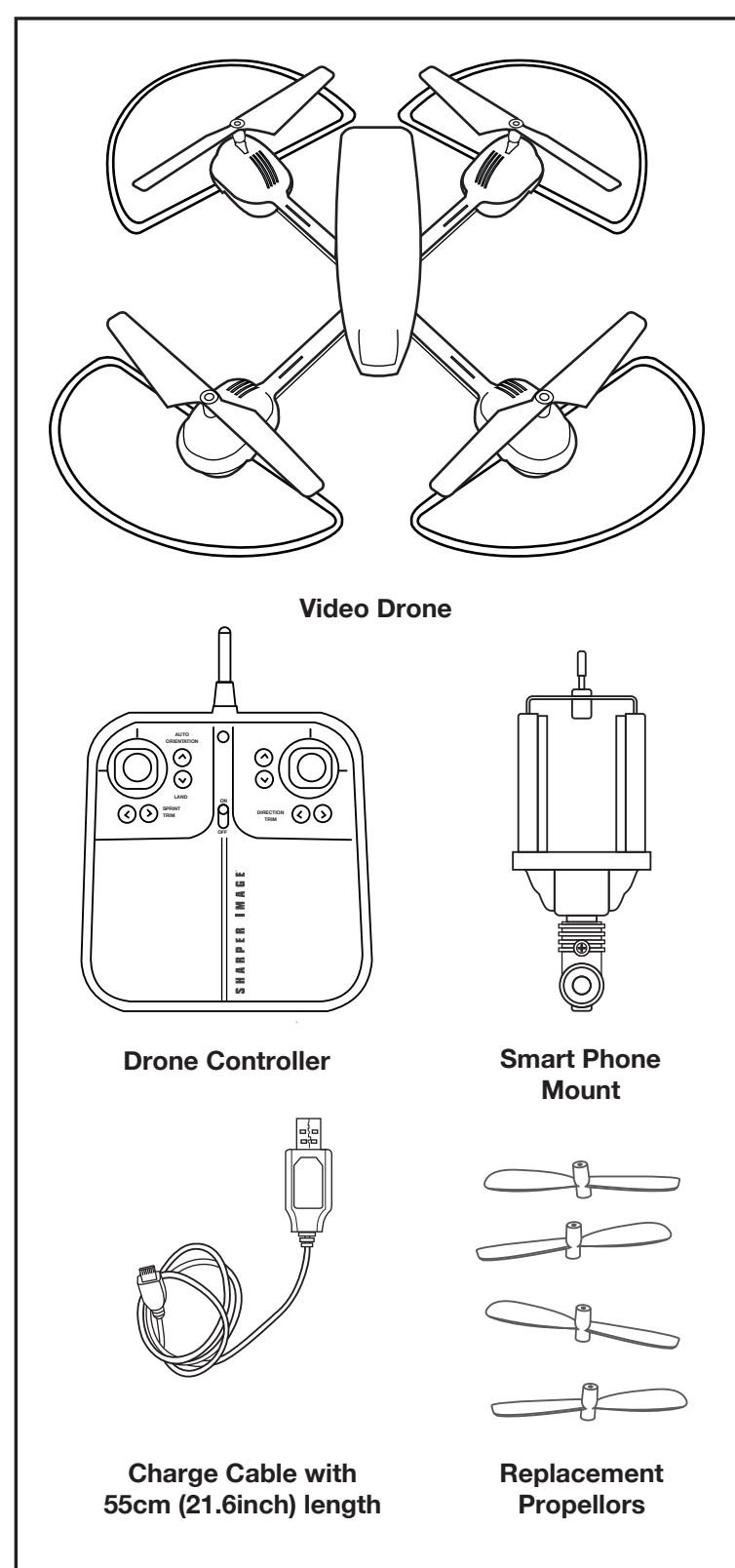

REMOTE BATTERY INFORMATION

1. Slide open battery compartment
2. Install 6 "AA" batteries as shown in diagram shown above
3. Replace and close battery compartment

LITHIUM-POLYMER BATTERY WARNING

There is a risk of fire and personal injury if Li-Po battery is punctured, damaged or misused

- Never expose battery to extreme temperatures or moisture.
- Do not subject battery to strong impacts
- Always keep battery away from flammable materials
- Only use manufacturer specified batter(ies), charger(s), and/or adapters, if applicable, specified by the manufacturer.
- Battery is not serviceable.
- Let battery cool to room temperature before charging.
- While charging, never leave battery unattended
- Recycle or dispose of battery according to federal, state and local laws.

KEEP THIS INSTRUCTION MANUAL FOR REFERENCE

BATTERY WARNING

- Do not mix old and new batteries.
- Do not mix alkaline, standard (carbon-zinc), or rechargeable batteries.
- Insert batteries using the correct polarity. Do not short-circuit the battery terminal
- Only use manufacturer specified batteries, charger(s), and/or adapters, if applicable, specified by the manufacturer.
- Always use, replace, and recharge (if applicable) batteries under adult supervision.

KEEP THE PACKAGE FOR REFERENCE AS IT CONTAINS IMPORTANT INFORMATION

Page 2

VIDEO STREAMING DRONE

CHARGING BATTERY

Note: The Battery Charge Cable will light up when it is charging the battery and turn off when the battery is fully charged. Charge time is approximately 100 minutes.

Turn off the drone before charging.

Connect the Battery Charge Cable to the charging port on the Drone.

Connect connector to power source.

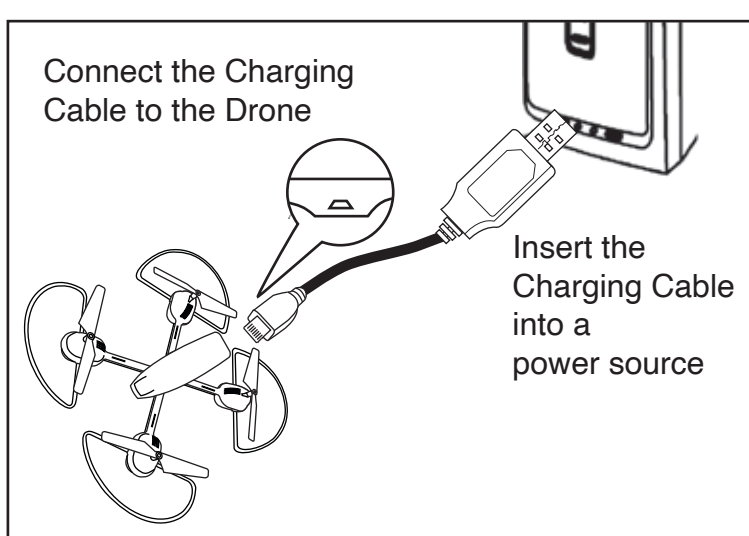

Replacing Propellers

1. Follow diagram.
2. Remove screw from top of Propeller.
3. Remove broken Propeller and replace with new Propeller.
4. Make sure you installed the correct blade. Each blade has a number written on it. Match the blades with the corresponding number on the drone.
5. Insert screw into top of Propeller.

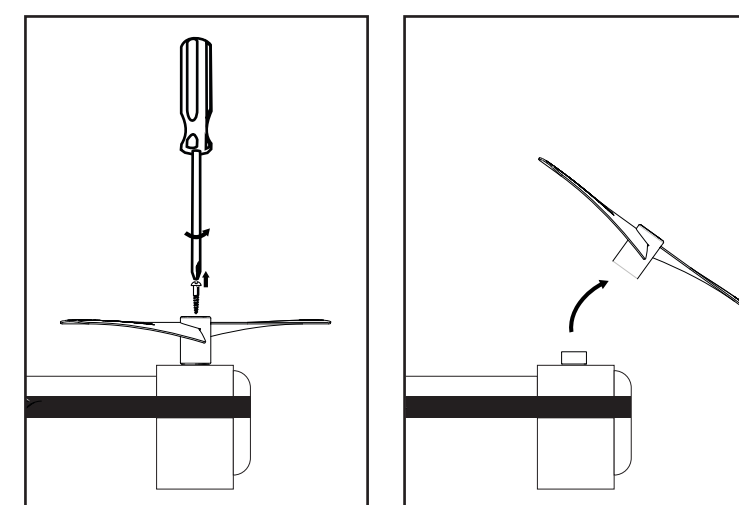

DRONE APP

Go to your app store on your smart phone and download the "360 Mach Flight" application.



Pairing Drone - First Time

1. Press the connect to Wi-Fi button.
2. Follow the on screen instructions.

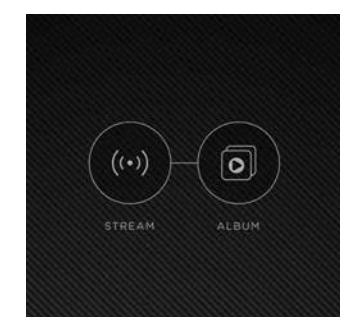

After Connecting Drone

1. Press the Stream Button to begin streaming.
2. Press the Album Button to review pictures and videos.

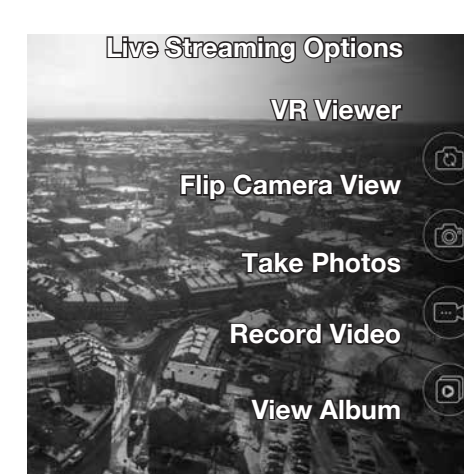

Page 3

VIDEO STREAMING DRONE

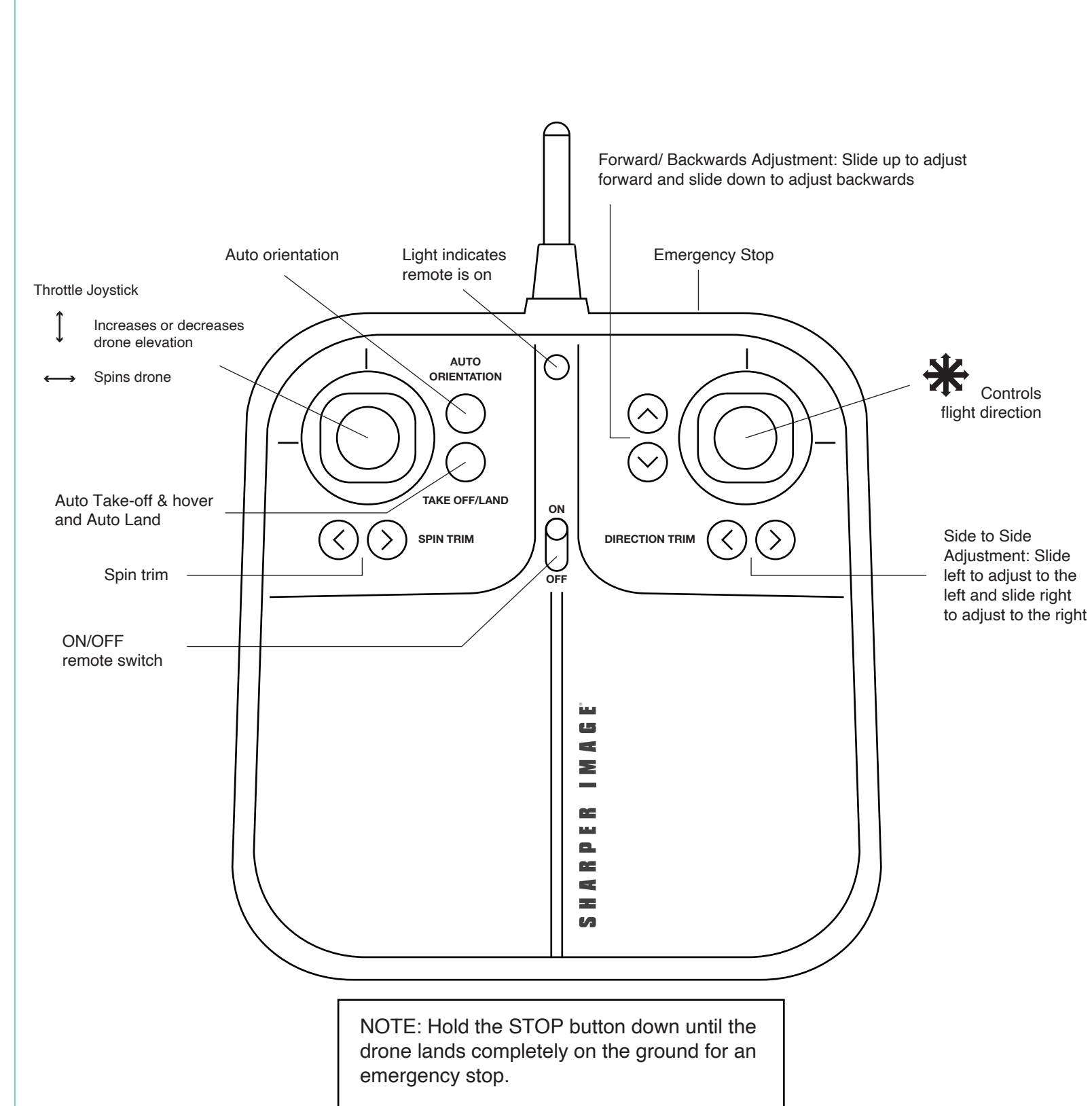

NOTE: Hold the STOP button down until the drone lands completely on the ground for an emergency stop.

Page 4

VIDEO STREAMING DRONE

INSTALLING PHONE HOLDER

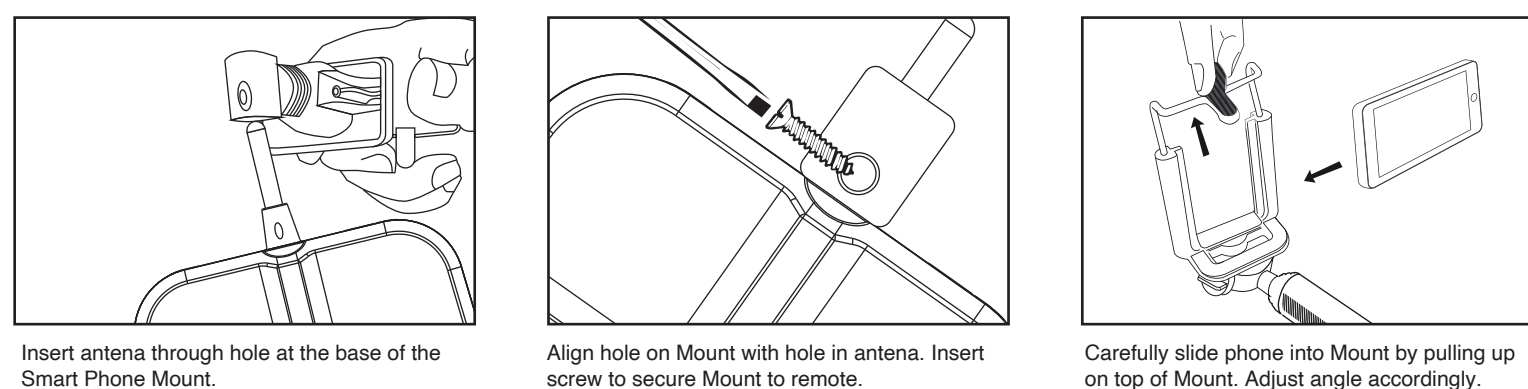

OPERATING DRONE

- Step 1 - Pre Flight Checklist**
1. Read all warnings and instructions.
 2. Install remote batteries, page 2.
 3. Make sure that drone and remote are powered off.
 4. Install drone holder.
 5. Charge batteries, page 3.

- Step 2 - Choosing a location**
- Drone is designed to be flown indoors and outdoors.
 - Always make sure you have enough space to fly drone.
 - Always follow warnings, page 1.

- Step 3 - Starting Drone**
1. Making sure your remote is off, slide drone switch to ON. Drone lights will begin to flicker.
 2. Place drone on a flat even surface with clearance according to diagram (Fig 1).
 3. Turn remote on. Make sure the left stick (throttle) is in a neutral position (stick is centered).
 4. Push the stick up and then down.
 5. A single tone indicates that the drone is paired.
 6. If pairing is unsuccessful, repeat steps 3-4.

- Step 4 - Lift Off**
- Press the TAKE OFF/LAND button on the front of the drone to lift off. Drone will elevate off the ground and level off into a hover. You can compensate for some of the drones drifting by using the Multi Directional Button or by following Step 5.

PRACTICE INDOORS BEFORE 1ST OUTDOOR FLIGHT.
MAKE SURE TO RESET DRONE AFTER HARD LANDING.

Page 5

VIDEO STREAMING DRONE

MODES

- Auto Orientation Button**
- Auto Orientation default setting is off. To enter this mode press Auto Orientation button. Remote will beep twice.
 - After drone is successfully paired, the 2 white LED lights toward orientation will be the original forward orientation, when drone is in auto orientation mode, the drone will orient to the user (remote), no matter what direction the drone is facing. Pushing the right stick up will send the drone away from the user, pushing it to the right will move the drone right, etc.
 - Remote will beep every 6 seconds to indicate the drone is in Auto Orientation mode.
 - To exit mode, press the Auto Orientation button. Remote will sound 1 long beep indicating that it has exited Auto Orientation mode.

Note: Auto Orientation mode is oriented to the user when pairing. If the remote is moved after pairing Auto Orientation, please follow directions above to reset Auto Orientation.

Camera - taking pictures and creating videos

- Taking a picture- press camera icon on app once to take a picture.
- Creating video- press video icon on app once to take a video. Press the video icon on app again to stop recording.

VIDEO STREAMING DRONE

CUSTOMER SERVICE
(800) 374-2744

TIPS

- Do not crash drone into sand or dirt. Drone gears may become clogged.
- When first learning to fly, practice lifting off and hovering.
- Stay several feet from walls and buildings.
- Always press throttle all the way down after crashing or when something gets stuck in propellers.
- Never fly drones above or near people, sudden changes in wind or other conditions could lead to unexpected crashes.
- Always use caution when flying drone vehicles, obey relevant laws, respect the privacy and property rights of others.
- The drone shall never be modified or used for anything except its intended purpose.

WARNING: Changes or modifications to this unit not expressly approved by the party responsible for compliance could void the user's authority to operate the equipment.

TROUBLESHOOTING:

When remote switch is turned on, the remote light does not illuminate:

- 1) Check that batteries in the remote are installed correctly OR
- 2) Replace with new batteries.

During drone flight, the remote LED is flashing:

- 1) Remote batteries are low, replace them with new batteries.

Drone and remote properly pair, but the drone will not lift-off:

- 1) Drone battery needs charging. Use the USB Charge Cable to connect the drone to power source.

After trimming the drone, the drone flight is very unstable and cannot fly properly:

- 1) One or more blades are most likely damaged.
- 2) Turn off the drone and remote.
- 3) Replace with the proper number replacement blade and try flying again.

After impact, the drone is unstable:

- 1) Put the left remote control lever to the left bottom and put the right remote control lever to the right bottom at the same time. This will reset the gyroscope (Fig. 1).
- 2) If the above does not resolve the issue, reboot the drone and controller and pair again.

Remote Controller and Drone can not be paired:

- 1) Check Point: Remote Controller must be closed to Drone, not exceed 12 feet.

Note: If there are 2 sets of Drones within 12 feet for Pairing, you must pair one successfully before pairing the second set.

This device complies with Part 15 of the FCC Rules. Operation is subject to the following two conditions: (1) this device may not cause harmful interference, and (2) this device must accept any interference received, including interference that may cause undesired operation.

NOTE: This equipment has been tested and found to comply with the limits for a Class B digital device, pursuant to Part 15 of the FCC Rules. These limits are designed to provide reasonable protection against harmful interference in a residential installation. This equipment generates, uses and can radiate radio frequency energy and, if not installed and used in accordance with the instructions, may cause harmful interference to radio communications. However, there is no guarantee that interference will not occur in a particular installation.

If this equipment does cause harmful interference to radio or television reception, which can be determined by turning the equipment off and on, the user is encouraged to try to correct the interference by one or more of the following measures:

- Reorient or relocate the receiving antenna.
- Increase the separation between the equipment and receiver.
- Connect the equipment into an outlet on a circuit different from that to which the receiver is connected.
- Consult the dealer or an experienced radio/TV technician for help.

FCC RF Radiation Exposure Statement Caution: To maintain compliance with the FCC's RF exposure guidelines, place the drone at least 20cm from nearby persons.

Sharper Image[®] name and logo are registered trademarks. Distributed by and © 2017 MerchSource, LLC, Irvine, CA 92618. All rights reserved.

The artwork and design of this package are protected by US copyright law and may not be reproduced, distributed, displayed, published or used for any purpose without prior written permission. Altering, removing or reproducing any of the trademark or copyright notices on this package is not permitted.

China Patent No. ZL201730072268.4
US Patent No. 9848-445
Printed in China

Page 7