

RFPartMatching

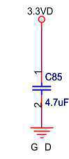
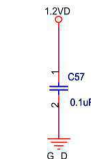
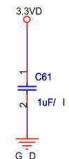
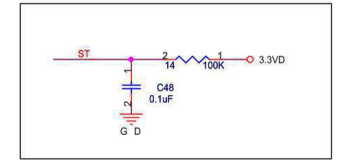
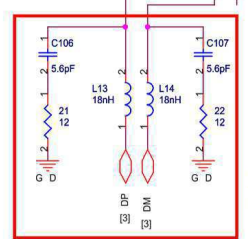
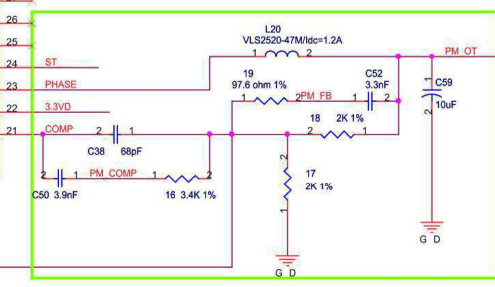
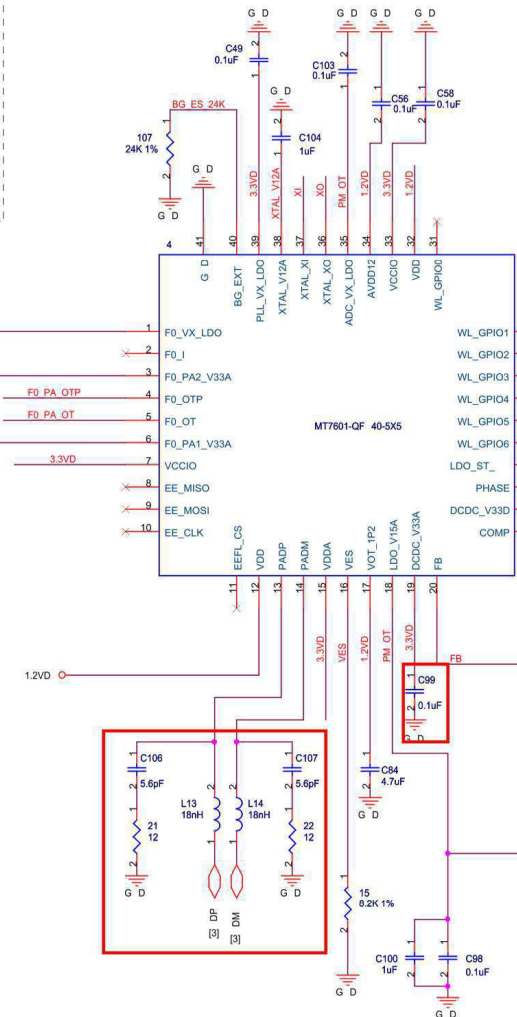
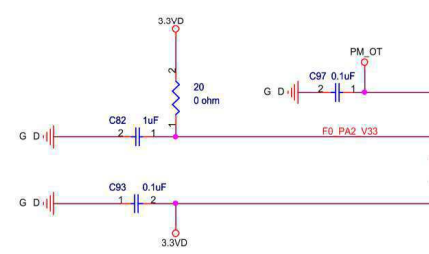
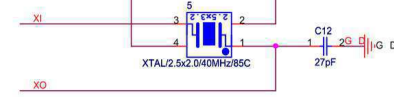
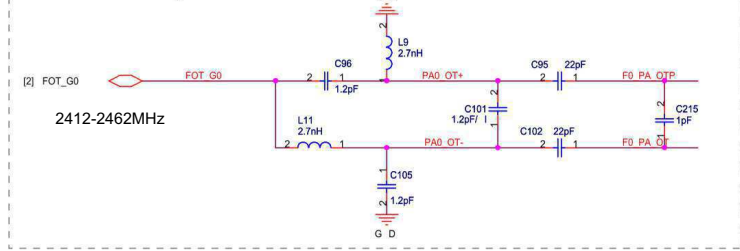

BootStrapping(Interna Pu High/Low)

EE_MISO	0:40MHzXta 1:20MHzXta
WL_GPIO4	0:Efuse 1:EEPROM
WL_GPIO6	USBMode
EE_CLK	010:Norma BootfromSeria F ash
EE_MOSI	011:Norma BootfromSeria EEPROM 100:SPImode BootfromRAM 101:Scanmode+bypassPLL 110:Testmode 111:Testmode+bypassPLL