



Ecom Sertech Corp.

Rm. 258, Bldg. 17, NO.195, Sec. 4 Chung Hsing Rd., ChuTung Chen, Hsinchu, Taiwan 310, R.O.C
TEL:886-3-5918012 FAX: 886-3-5825720

FCC ID : QVZ10350001
Report No. : ER04-04-068FRF
Page 1 of 45



TEST REPORT

Product Name : Bluetooth USB Button Dongle

Model Number : MBT-1203-01

Applicant : Microlink Communications Inc.

Address : 6F, No. 30, Raykuang Rd., Neihu, Taipei 114, Taiwan, R.O.C.

Received Date : May 21, 2004

Tested Date : April 27 ~ May 21, 2004

Notes :

1. This report will be invalid if duplicated or photocopied in part.
2. This report refers only to the specimen(s) submitted to testing, and be invalid as separately used.
3. This report is invalid without examination stamp and signature of this institute.
4. The tested specimen(s) will be preserved for thirty days from the data issued.
5. The report must not be used to claim product certification, approval, or endorsement by NVLAP, NIST, or any agency of the federal government.





Ecom Sertech Corp.

Rm. 258, Bldg. 17, NO.195, Sec. 4 Chung Hsing Rd., ChuTung Chen, Hsinchu, Taiwan 310, R.O.C
TEL:886-3-5918012 FAX: 886-3-5825720

FCC ID : QVZ10350001
Report No. : ER04-04-068FRF
Page 2 of 45

Test Report Certification

Product Name : Bluetooth USB Button Dongle
Model Number : MBT-1203-01
Applicant : Microlink Communications Inc.

Measurement Standard :

FCC 47 C.F.R. Part 15, Subpart B and Subpart C (2003),
ANSI C63.4 (2001)

Tested By :	<u>Stan Peng</u> (Stan Peng)	Date :	<u>May 22, 2004</u>
Reviewed By :	<u>Roger Sheng</u> (Roger Sheng)	Date :	<u>May 22, 2004</u>
Approved By :	<u>Chieh-De Tsai</u> (Chieh-De Tsai, Manager)	Date :	<u>May 22, 2004</u>

WE HEREBY CERTIFY THAT: The measurements shown in the attachment were made in accordance with the procedures indicated, and the energy emitted by the equipment was found to be within the limits applicable. We assume full responsibility for the accuracy and completeness of these measurements and vouch for the qualifications of all persons taking them.



TABLE OF CONTENTS

TITLE	PAGE NO.
1. GENERAL INFORMATION	5
1.1 Description of EUT & Power	5
1.2 Description of Peripherals	6
1.3 EUT & Peripherals Setup Diagram	7
1.4 EUT Operating Procedure	7
1.5 Description of Laboratory.....	8
1.6 Summary of Test Results	8
2. CONDUCTED POWERLINE TEST	9
2.1 Test Equipments	9
2.2 Test Setup	9
2.3 Conducted Power Line Emission Limit.....	10
2.4 Test Procedure	10
2.5 Uncertainty of Conducted Emission	10
2.6 Line Conducted RF Voltage Measurement.....	11
2.7 Photos of Conduction Test.....	12
3. 20DB BANDWIDTH FOR HOPPING.....	13
3.1 Test Equipments	13
3.2 Test Setup	13
3.3 Limits of 20db Bandwidth Measurement	13
3.4 Test Procedure	13
3.5 Uncertainty of Conducted Emission	14
3.6 Test Results.....	14
3.7 Photo of 20db Bandwidth Measurement.....	15
4. MAXIMUM PEAK OUTPUT POWER	16
4.1 Test Equipments	16
4.2 Test Setup	16
4.3 Limits of Maximum Peak Output Power	16
4.4 Test Procedure	17
4.5 Uncertainty of Conducted Emission	17
4.6 Test Results.....	17
4.7 Photo of Maximum Peak Output Power	18
5. HOPPING CHANNEL SEPARATION.....	19
5.1 Test Equipments	19
5.2 Test Setup	19
5.3 Limits of Hopping Channel Separation	19
5.4 Test Procedure	20
5.5 Uncertainty of Conducted Emission	20
5.6 Test Results.....	20
5.7 Photo of Hopping Channel Separation	20
6. NUMBER OF HOPPING FREQUENCY USED.....	21
6.1 Test Equipments	21
6.2 Test Setup	21
6.3 Limits of Number of Hopping Frequency Used	21
6.4 Test Procedure	22
6.5 Uncertainty of Conducted Emission	22
6.6 Test Results.....	22
6.7 Photo of Number of Hopping Frequency Used	22



TABLE OF CONTENTS

TITLE	PAGE NO.
7. DWELL TIME ON EACH CHANNEL.....	23
7.1 Test Equipments	23
7.2 Test Setup	23
7.3 Limits of Dwell Time on Each Channel	23
7.4 Test Procedure	24
7.5 Uncertainty of Conducted Emission	24
7.6 Test Results.....	24
7.7 Photo of Dwell Time on Each Channel	25
8. BAND EDGE SPURIOUS EMISSIONS.....	26
8.1 Test Equipments	26
8.2 Test Setup	26
8.3 Limits of Band edge Measurements	26
8.4 Test Procedure	27
8.5 Uncertainty of Conducted Emission	27
8.6 Test Results.....	28
8.7 Photo of Band edge Measurement	29-30
9. OUT OF BAND SPURIOUS EMISSIONS -RADIATED MEASUREMENTS.....	31
9.1 Test Equipments	31
9.2 Test Setup	31
9.3 Radiation Limit	32
9.4 Test Procedures.....	33
9.5 Uncertainty of Radiated Emission	33
9.6 Radiated RF Noise Measurement	34-40
9.7 Photos of Open Site	41-42
10. ANTENNA REQUIREMENT	43
10.1 Standard Applicable.....	43
10.2 Antenna Connected Construction	43
11. RF EXPOSURE EVALUATION.....	44
11.1 Friis Formula	44
11.2 EUT Operating Condition.....	44
11.3 Test Result of RF Exposure Evaluation.....	45
11.3.1 Antenna Gain	45
11.3.2 Output Power into Antenna & RF Exposure Evaluation Distance	45



1. GENERAL INFORMATION

1.1 Description of EUT & Power

MANUFACTURER : Microlink Communications Inc.
SAMPLE NAME : Bluetooth USB Button Dongle
MODEL NO : MBT-1203-01
EUT DESCRIPTION : 2.4GHz Frequency Hopping Spread Spectrum
Data Transceiver for Bluetooth USB Button Dongle
FREQUENCY RANGE : 2402 MHz to 2480MHz
CHANNEL NUMBER : 79
CHANNEL Spacing : 1MHz
AIR DATA RATE : 723Kbps
TYPE OF MODULATION : Frequency Hopping Spread Spectrum, GFSK
FREQUENCY SELECTION : BY SOFTWARE
ANTENNA TYPE : Printed Antenna, Antenna gain : 1.6dBi.
POWER SOURCE : 5VDC (From Notebook PC)



1.2 Description of Peripherals

(1) Notebook PC

MANUFACTURER : COMPAQ CORP.
MODEL NUMBER : EV0N800
SERIAL NUMBER : 470052-787
FCC ID : DOC
POWER CORD : Unshielded, Detachable, 1.8m

Adapter

MANUFACTURER : COMPAQ CORP.
MODEL NUMBER : PPP009H
INPUT POWER : 100-240V ~ 1.7A, 50 ~ 60Hz
OUTPUT POWER : 18.5VDC, 3.5A, 65W

(2) Printer

MANUFACTURER : HP CORP.
MODEL NUMBER : C8952D
SERIAL NUMBER : CN29B181H7
FCC ID : DOC
POWER SOURCE : 100-240VAC, 50/60Hz, 0.7A
SIGNAL CABLE : Shielded , Undetachable , 1.8m

1.3 EUT & Peripherals Setup Diagram

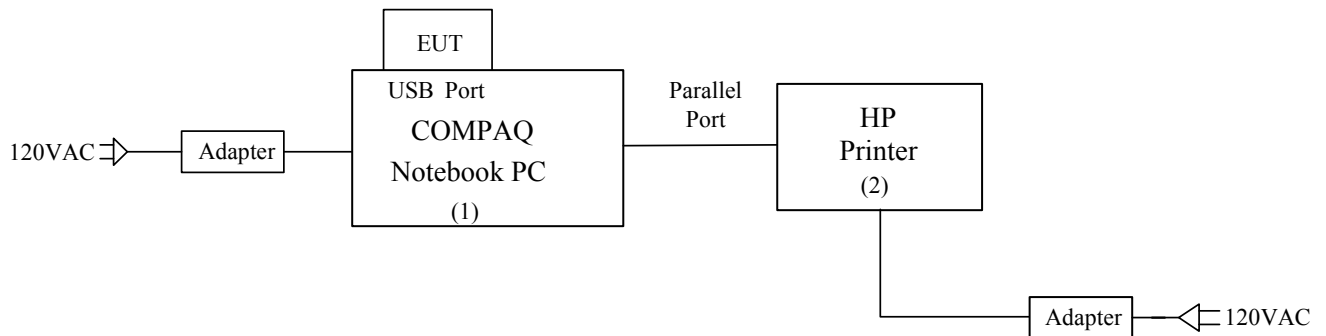

The indicated numbers (1)(2)....., please refer to item 1.2

1.4 EUT Operating Procedure

1. Run Broadcom Blue Tool → Blue Tool.
2. Choice Transport → HCI Control → USB and press ok .
3. Choice Enable USB HID Emulation, and press ok.
4. Start Tx mode test :
 - (a) Choice Set_Tx_Carrier_Frequency, key in channel MHz, and choice Modulate PRBS9, press ok.
5. Start RX mode test :
 - (a) Choice Write_Receive_Only, key in channel MHz, press ok.



Ecom Sertech Corp.

Rm. 258, Bldg. 17, NO.195, Sec. 4 Chung Hsing Rd., ChuTung Chen, Hsinchu, Taiwan 310, R.O.C
TEL:886-3-5918012 FAX : 886-3-5825720

FCC ID : QVZ10350001
Report No. : ER04-04-068FRF
Page 8 of 45

1.5 Description of Laboratory

SITE DESCRIPTION

FCC Certificate NO. : 90585
BSMI Certificate NO. : SL2-IN-E-0002
NVLAP Lab code : 200118-0
CNLA Certificate NO. : CNLA-ZL97018
VCCI Certificate NO. : R-1189, C-1250
TÜV Rheinland Certificate NO. : 10008375

NAME OF SITE : Ecom Sertech Corp. Hsin-Chu Lab.
(Spin-off from ITRI / ERSO on Apr. 01, 2003)
SITE LOCATION : Rm.258, Bldg.17, NO.195 , Sec. 4, Chung Hsing Rd.,
Chu-Tung Chen. Hsin-Chu, Taiwan 310 R.O.C.

1.6 Summary of Test Results

The EUT has been tested according to the following specifications :

APPLIED STANDARD : FCC 47 C.F.R. Part 15, Subpart B and Subpart C

Standard Section	Test Type and Limit	Result	REMARK
15.107 15.207	AC Power Conducted Emission Limit : Sec1.5.107	PASS	Meet the requirement of limit
15.109 15.205 15.209	Transmitter Radiated Emissions Limit : Table 15.209	PASS	Meet the requirement of limit
15.247(a) (1)(i)-(ii)	Transmitter 20dB Bandwidth Limit < 1MHz	PASS	Meet the requirement of limit
15.247(b)(1)	Maximum Peak Output Power Limit : max. 30dBm	PASS	Meet the requirement of limit
15.247(a)(1)	Carrier Frequency Separation	PASS	Meet the requirement of limit
15.247(a) (1)(ii)	Number of Hopping Frequency	PASS	Meet the requirement of limit
15.247(a) (1)(ii)	Time of Occupancy (dwell time)	PASS	Meet the requirement of limit
15.247(c)	Band Edge Compliens	PASS	Meet the requirement of limit
15.247(c)	Out of Band Measurements	PASS	Meet the requirement of limit



2. CONDUCTED POWERLINE TEST

For intentional device, according to § 15.207(a) Line Conducted Emission Limit is required to verify the EUT.

2.1 Test Equipments

The following test equipments are used during the conducted powerline tests :

Manufacturer or Type	Model No.	Serial No.	Date of Calibration	Calibration Period	Remark
HP SPECTRUM ANALYZER & DISPLAY	8568A	2235A02320	November 14, 2003	1 Year	PRETEST
HP QUASI-PEAK ADAPTER	85650 A	2341A00672	November 14, 2003	1 Year	PRETEST
SOLAR ISOLATION TRANSFORMER	7032-1	N/A	N/A	N/A	FINAL
EMCO L.I.S.N.	3850/2	9311-1025 9401-1028	January 08, 2004 For Characteristic impedance	1 Year	FINAL
			May 18, 2004 For Insertion loss		
R & S TEST RECEIVER	ESHS 30	838550/003	February 11, 2004	1 Year	FINAL
KEENE SHIELDED ROOM	5983	No.1	N/A	N/A	FINAL
R & S PULSE LIMIT	EHS3Z2	357.8810.52	July 10, 2003	1 Year	FINAL
N TYPE COAXIAL CABLE	-----	-----	July 10, 2003	1 Year	FINAL
50Ω TERMINATOR	-----	-----	July 10, 2003	1 Year	FINAL

2.2 Test Setup

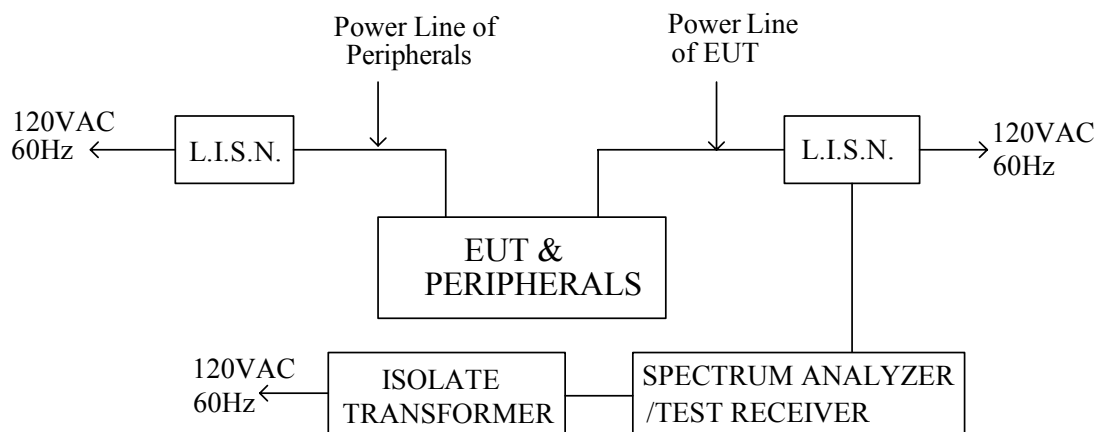



2.3 Conducted Power Line Emission Limit

For unintentional device, according to § 15.107(a) Line Conducted Emission Limits is as following :

Frequency (MHz)	Maximum RF Line Voltage (dB μ v)			
	CLASS A		CLASS B	
	Q.P.	Ave.	Q.P.	Ave.
0.15 - 0.50	79	66	66-56	56-46
0.50 - 5.00	73	60	56	46
5.00 - 30.0	73	60	60	50

For intentional device, according to § 15.207(a) Line Conducted Emission Limit is same as above table.

2.4 Test Procedure

The test procedure is performed in a 12ft×12ft×8ft(L×W×H) shielded room. the EUT along with its peripherals were placed on a 1.0m(W)× 1.5m(L) and 0.8m in height wooden table and the EUT was adjusted to maintain a 0.4 meter space from a vertical reference plane. The EUT was connected to power mains through a line impedance stabilization network (LISN) which provides 50 ohm coupling impedance for measuring instrument and the chasis ground was bounded to the horizontal ground plane of shielded room. All peripherals were connected to the second LISN and the chasis ground also bounded to the horizontal ground plane of shielded room. The excess power cable between the EUT and the LISN was bundled. The power cables of peripherals were unbundled. All connecting cables of EUT and peripherals were moved to find the maximum emission.

2.5 Uncertainty of Conducted Emission

The uncertainty of conducted emission is ± 1.36 dB.



2.6 Line Conducted RF Voltage Measurement

The frequency spectrum from 0.15 MHz to 30 MHz was investigated. All emissions not reported are much lower than the prescribed limits.

Temperature : 24.5°C

Humidity : 56 % RH

Frequency (MHz)	Loss(dB)		Measurement				L1 Emission (dBμV)		L2 Emission (dBμV)		Limits (dBμV)	
			L1(dBμV)		L2(dBμV)		Q.P.	Ave.	Q.P.	Ave.	Q.P.	Ave.
	L1	L2	Q.P.	Ave.	Q.P.	Ave.						
0.150	0.10	0.20	*	*	*	*	*	*	*	*	66.00	56.00
0.153	0.10	0.20	*	*	30.10	*	*	*	30.30	*	65.84	55.84
0.264	0.10	0.20	38.20	*	*	*	38.30	*	*	*	61.30	51.30
0.528	0.10	0.20	34.80	*	24.90	*	34.90	*	25.10	*	56.00	46.00
0.594	0.10	0.20	29.30	*	30.60	*	29.40	*	30.80	*	56.00	46.00
2.046	0.10	0.20	28.10	*	*	*	28.20	*	*	*	56.00	46.00
2.115	0.11	0.20	*	*	26.60	*	*	*	26.80	*	56.00	46.00
2.907	0.19	0.20	20.90	*	*	*	21.09	*	*	*	56.00	46.00
2.979	0.20	0.20	*	*	27.20	*	*	*	27.40	*	56.00	46.00
4.956	0.20	0.20	*	*	15.50	*	*	*	15.70	*	56.00	46.00
6.588	0.30	0.30	24.90	*	*	*	25.20	*	*	*	60.00	50.00
14.109	0.51	0.60	32.30	*	*	*	32.81	*	*	*	60.00	50.00
14.961	0.60	0.60	*	*	33.20	*	*	*	33.80	*	60.00	50.00
15.492	0.65	0.65	*	*	32.40	*	*	*	33.05	*	60.00	50.00
15.558	0.66	0.66	29.40	*	*	*	30.06	*	*	*	60.00	50.00
30.000	1.40	1.80	*	*	*	*	*	*	*	*	60.00	50.00

REMARKS : 1. * Undetectable or the Q.P. value is lower than the limits of Ave.

2.7 Photos of Conduction Test





3. 20DB BANDWIDTH FOR HOPPING

Test Requirement: 15.247(a)(1)(ii)

3.1 Test Equipments

Description & Manufacturer	Model No.	Serial No.	Date Of Calibration
ROHDE & SCHWARZ SPECTRUM ANALYZER	FSEK30	835253/002	June 17, 2003

NOTE :

1. The measurement uncertainty is less than +/- 2.6dB, which is calculated as per the NAMAS document NIS81.
2. The calibration interval of the above test instruments is 12 months and the calibrations are traceable to NML/ROC and NIST/USA.

3.2 Test Setup

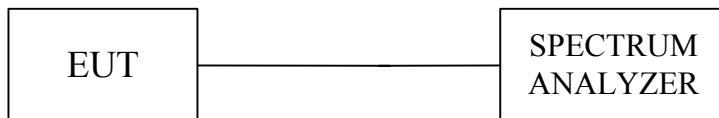

3.3 Limits of 20db Bandwidth Measurement

Limit: 20dB band width < 1MHz

3.4 Test Procedure

The 20dB band width was measured with a spectrum analyzer connected to RF antenna connector(conducted measurement) while EUT was operating in transmit mode at the appropriate center frequency.

The analyzer center frequency was set to the EUT carrier frequency, using the analyzer. Display Line and Marker Delta functions, the 20dB band width of the emission was determined.



Ecom Sertech Corp.

Rm. 258, Bldg. 17, NO.195, Sec. 4 Chung Hsing Rd., ChuTung Chen, Hsinchu, Taiwan 310, R.O.C
TEL:886-3-5918012 FAX: 886-3-5825720

FCC ID : QVZ10350001
Report No. : ER04-04-068FRF
Page 14 of 45

3.5 Uncertainty of Conducted Emission

The uncertainty of conducted emission is ± 10 KHz.

3.6 Test Results

Refer to attached spectrum analyzer data chart.

Input Power (System)	5VDC (From Notebook PC)	Environmental Conditions	14.6°C, 73%RH
Tested By	Stan Peng		

Channel	Channel Frequency (MHz)	20dB Bandwidth (MHz)	Maximum Limit (MHz)	Pass / Fail
01 (Low)	2402	0.976	<1	PASS
40 (Mid)	2441	0.976	<1	PASS
79 (High)	2480	0.981	<1	PASS



Ecom Sertech Corp.

Rm. 258, Bldg. 17, NO.195, Sec. 4 Chung Hsing Rd., ChuTung Chen, Hsinchu, Taiwan 310, R.O.C
TEL:886-3-5918012 FAX : 886-3-5825720

FCC ID : QVZ10350001
Report No. : ER04-04-068FRF
Page 15 of 45

3.7 Photo of 20db Bandwidth Measurement

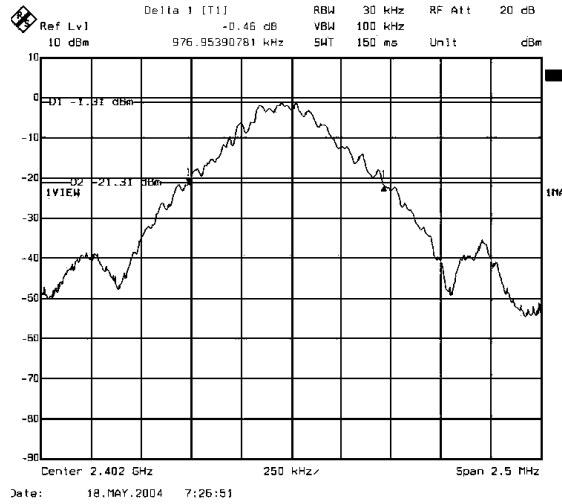

Channel Low

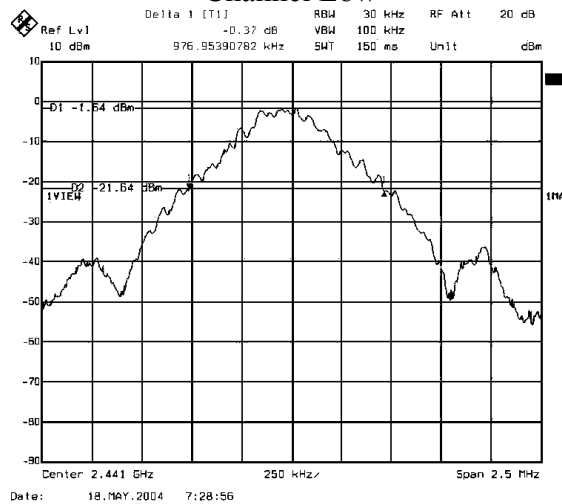

Channel Middle

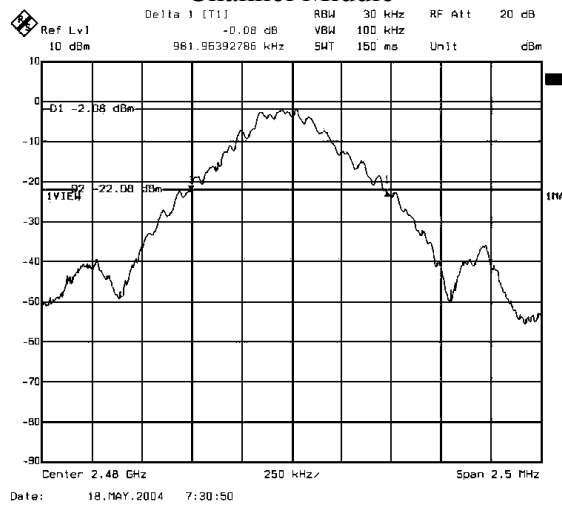

Channel High



4. MAXIMUM PEAK OUTPUT POWER

Test Requirement: 15.247(b)(1)

4.1 Test Equipments

Description & Manufacturer	Model No.	Serial No.	Date Of Calibration
ROHDE & SCHWARZ SPECTRUM ANALYZER	FSEK30	835253/002	June 17, 2003

NOTE :

1. The measurement uncertainty is less than +/- 2.6dB, which is calculated as per the NAMAS document NIS81.
2. The calibration interval of the above test instruments is 12 months and the calibrations are traceable to NML/ROC and NIST/USA.

4.2 Test Setup

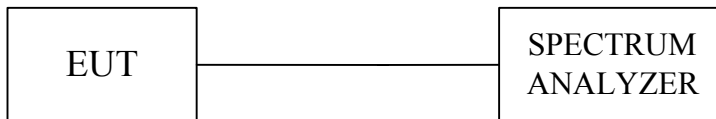

4.3 Limits of Maximum Peak Output Power

The Maximum Peak Output Power Measurement is 1W(30dBm) for frequency hopping systems operating in 2400~2483.5 MHz employing at least 75 hopping channels.



4.4 Test Procedure

The RF power output was measured with a Power meter connected to the RF Antenna connector (conducted measurement) while EUT was operating in transmit mode at the appropriate center frequency, A spectrum analyzer was used to record the shape of the transmit signal see 4.7 for the measurement set up.

4.5 Uncertainty of Conducted Emission

The uncertainty of conducted emission is $\pm 1.82\text{dB}$.

4.6 Test Results

Input Power (System)	5VDC (From Notebook PC)	Environmental Conditions	14.6°C, 73%RH
Tested By	Stan Peng		

Cable loss = 0.5dB

Channel	Channel Frequency (MHz)	Peak Power Output (dBm)	Peak Power Limit (dBm)	Pass / Fail
01 (Low)	2402	1.44	30	PASS
40 (Mid)	2441	1.27	30	PASS
79 (High)	2480	0.96	30	PASS

Note : The result was calculated as follow :

$$\text{Peak Power Output} = \text{Peak Power Reading} + \text{Cable loss}$$



4.7 Photo of Maximum Peak Output Power

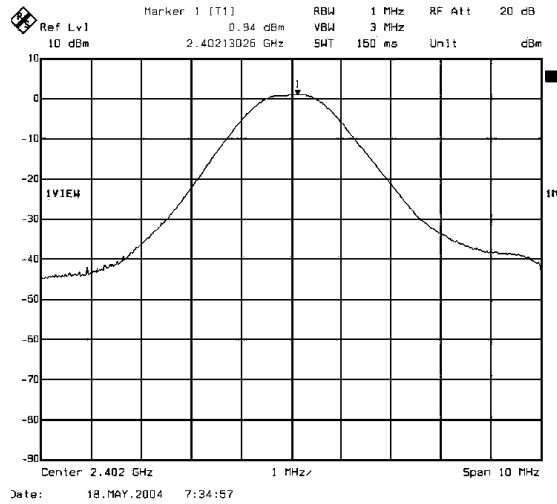

Channel Low

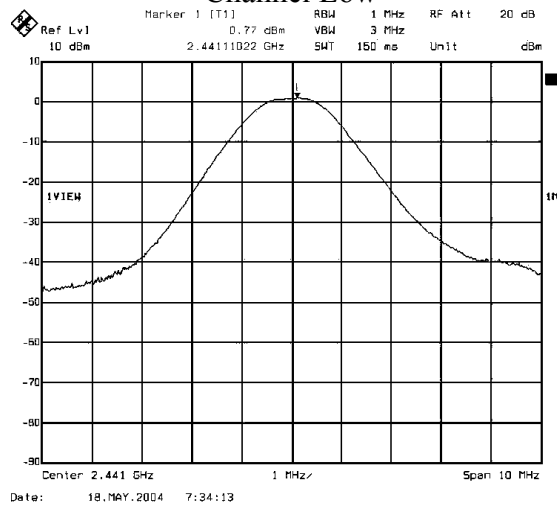

Channel Middle

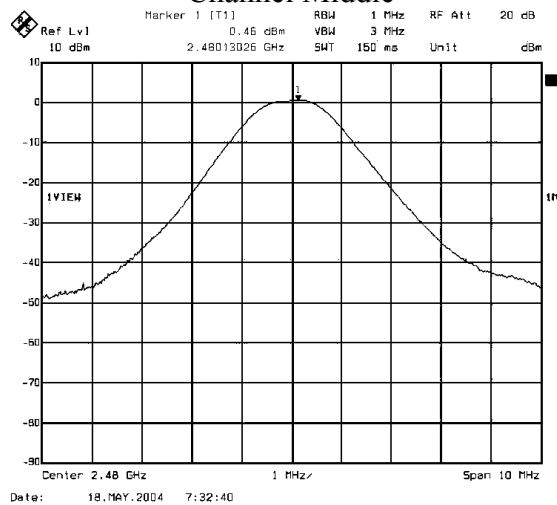

Channel High



5. HOPPING CHANNEL SEPARATION

Test Requirement: 15.247(a)(1)

5.1 Test Equipments

Description & Manufacturer	Model No.	Serial No.	Date Of Calibration
ROHDE & SCHWARZ SPECTRUM ANALYZER	FSEK30	835253/002	June 17, 2003

NOTE :

1. The measurement uncertainty is less than +/- 2.6dB, which is calculated as per the NAMAS document NIS81.
2. The calibration interval of the above test instruments is 12 months and the calibrations are traceable to NML/ROC and NIST/USA.

5.2 Test Setup

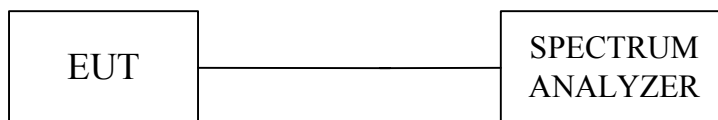

5.3 Limits of Hopping Channel Separation

According to 15.247(a)(1), frequency hopping system shall have, hopping channel carrier frequencies separated by a minimum of 25kHz or the 20dB bandwidth of the hopping channel, whichever is greater.

5.4 Test Procedure

1. Check the calibration of the measuring instrument using either an internal calibrator or a known signal from an external generator.
2. Position the EUT as shown in test setup without connection to measurement instrument. Turn on the EUT and connect it to measurement instrument. Then set it to any one convenient frequency within its operating range.
3. Because of the property of test software and hardware, the TX signal can not be modulated while test.
4. By using the MaxHold function record the separation of adjacent channels.
5. Measure the frequency difference of these two adjacent channels by spectrum analyzer MARK function. And then plot the result on spectrum analyzer screen.

Repeat above procedures until all frequencies measured were complete.

5.5 Uncertainty of Conducted Emission

The uncertainty of conducted emission is ± 10 KHz.

5.6 Test Results

Refer to section 3, 20dB bandwidth measurement, the measured channel separation should be greater than 20dB bandwidth or Minimum bandwidth.

Channel	Adjacent Hopping Channel Separation (kHz)	20dB bandwidth (kHz)	Minimum Bandwidth	Result
2441MHz (Mid)	997.99 kHz	976.95 kHz	25 kHz	PASS

5.7 Photo of Hopping Channel Separation

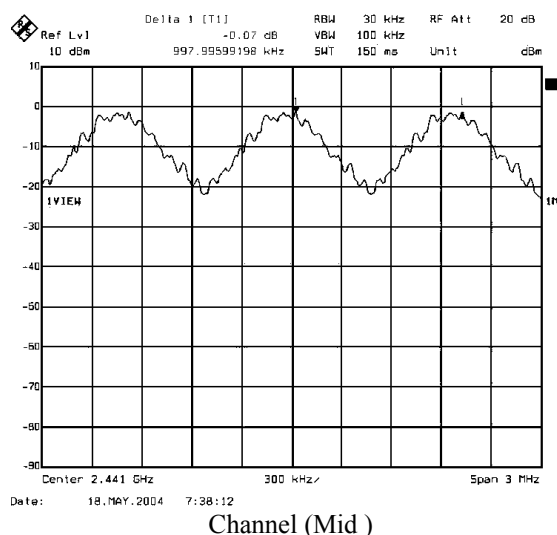



6. NUMBER OF HOPPING FREQUENCY USED

Test Requirement: 15.247(a)(1)(ii)

6.1 Test Equipments

Description & Manufacturer	Model No.	Serial No.	Date Of Calibration
ROHDE & SCHWARZ SPECTRUM ANALYZER	FSEK30	835253/002	June 17, 2003

NOTE :

1. The measurement uncertainty is less than +/- 2.6dB, which is calculated as per the NAMAS document NIS81.
2. The calibration interval of the above test instruments is 12 months and the calibrations are traceable to NML/ROC and NIST/USA.

6.2 Test Setup

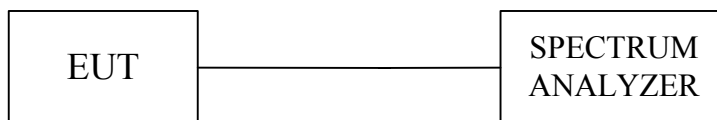

6.3 Limits of Number of Hopping Frequency Used

According to 15.247(a)(1)(ii), for frequency hopping system operating in the 2400-2483.5MHz and 5725-5850 MHz bands shall use at least 75 hopping frequencies

6.4 Test Procedure

1. Check the calibration of the measuring instrument (spectrum analyzer) using either an internal calibrator or a known signal from an external generator.
2. Position the EUT as shown in test setup without connection to measurement instrument. Turn on the EUT and connect its antenna terminal to measurement instrument via a low loss cable. Then set it to any one measured frequency within its operating range and make sure the instrument is operated in its linear range.
3. Set the spectrum analyzer on MaxHold Mode, and then keep the EUT in hopping mode. Record all the signals from each channel until each one has been recorded.
4. Set the spectrum analyzer on View mode and then plot the result on spectrum analyzer screen.
5. Repeat above procedures until all frequencies measured were complete.

6.5 Uncertainty of Conducted Emission

The uncertainty is not applicable.

6.6 Test Results

Refer to the attached graph.

There are 79 hopping frequencies in a hopping sequence.

6.7 Photo of Number of Hopping Frequency Used

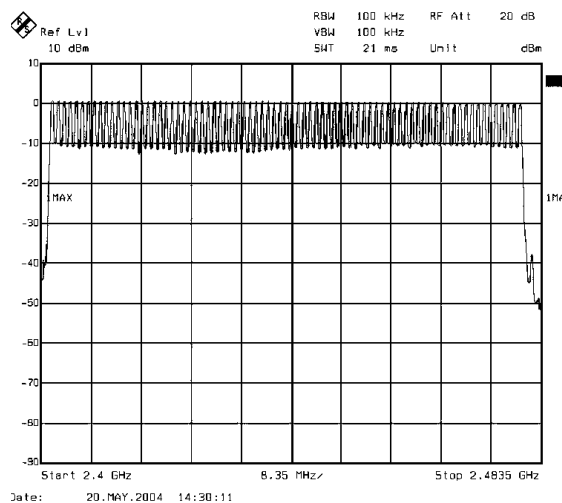



7. DWELL TIME ON EACH CHANNEL

Test Requirement: 15.247(a)(1)(ii)

7.1 Test Equipments

Description & Manufacturer	Model No.	Serial No.	Date Of Calibration
ROHDE & SCHWARZ SPECTRUM ANALYZER	FSEK30	835253/002	June 17, 2003

NOTE :

1. The measurement uncertainty is less than +/- 2.6dB, which is calculated as per the NAMAS document NIS81.
2. The calibration interval of the above test instruments is 12 months and the calibrations are traceable to NML/ROC and NIST/USA.

7.2 Test Setup

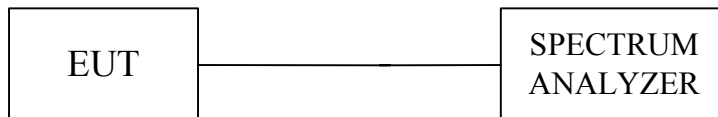

7.3 Limits of Dwell Time on Each Channel

According to 15.247(a)(1)(ii), for frequency hopping system operating in the 2400-2483.5MHz and 5725-5850 MHz band, the average time of occupancy on any frequency shall not be greater than **0.4** second within a 30-second period



7.4 Test Procedure

1. Check the calibration of the measuring instrument using either an internal calibrator or a known signal from an external generator.
2. Position the EUT as shown in test setup without connection to measurement instrument. Turn on the EUT and connect its antenna terminal to measurement instrument via a low loss cable. Then set it to any one measured frequency within its operating range and make sure the instrument is operated in its linear range.
3. Adjust the center frequency of spectrum analyzer on any frequency be measured and set spectrum analyzer to zero span mode. And then, set RBW and VBW of spectrum analyzer to proper value.
4. Measure the time duration of one transmission on the measured frequency. And then plot the result with time difference of this time duration.
5. Repeat above procedures until all frequencies measured were complete.
6. The Bluetooth USB Button Dongle has 3 type of payload, DH1. The hopping rate is 1600 per second. The longer the payload is, the slower the hopping rate is.

7.5 Uncertainty of Conducted Emission

The uncertainty of time is $\pm 5.25\text{ms}$.

7.6 Test Results

Time of occupancy on the TX channel in 30sec = time domain slot length \times hop rate \div number of hop per channel $\times 30$

Refer to the attached graph.

The hopping rates of Bluetooth devices change with different types of payload. The longer the payload is, the slower the hopping rate. The hopping rate scenario is defined in Bluetooth core specification.

Transmitting Frequency	Packet type	Dwell time (ms)	Time of occupancy on the TX channel in 30sec (ms)	Limit for Time of occupancy on the TX channel in 30sec (ms)	Results
2441MHz	DH1	0.420	255.18	400	PASS
2441MHz	DH3	1.680	340.25	400	PASS
2441MHz	DH5	2.930	356.05	400	PASS

DH1 Dwell time = $0.420\text{ms} \times 1600 \div 79 \times 30 = 255.18 \text{ (ms)}$

DH3 Dwell time = $1.680\text{ms} \times (1600 \div 3) \div 79 \times 30 = 340.25 \text{ (ms)}$

DH5 Dwell time = $2.930\text{ms} \times (1600 \div 5) \div 79 \times 30 = 356.05 \text{ (ms)}$



7.7 Photo of Dwell Time on Each Channel

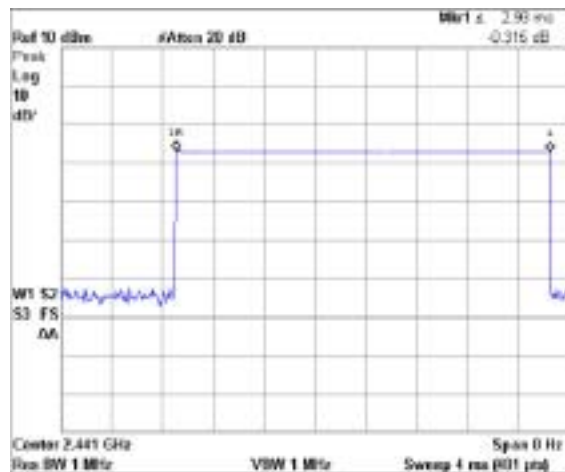
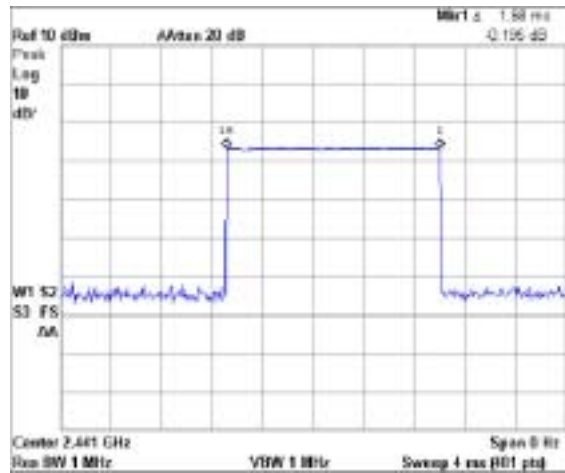
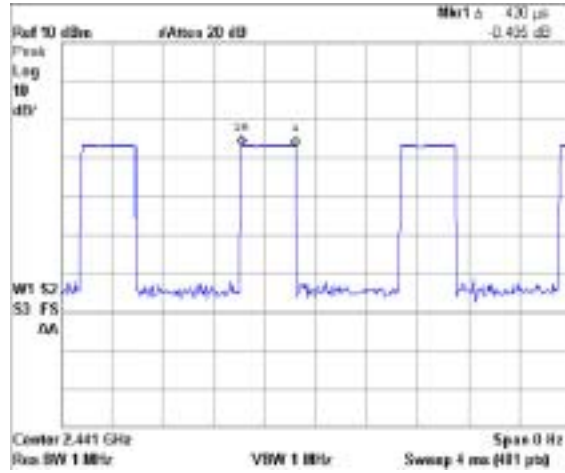



8. BAND EDGE SPURIOUS EMISSIONS

Test Requirement: 15.247(c)

8.1 Test Equipments

Description & Manufacturer	Model No.	Serial No.	Date Of Calibration
ROHDE & SCHWARZ SPECTRUM ANALYZER	FSEK30	835253/002	June 17, 2003

Note :

1. The measurement uncertainty is less than +/- 2.6dB, which is calculated as per the NAMAS document NIS81.
2. The calibration interval of the above test instruments is 12 months and the calibrations are traceable to NML/ROC and NIST/USA.

8.2 Test Setup

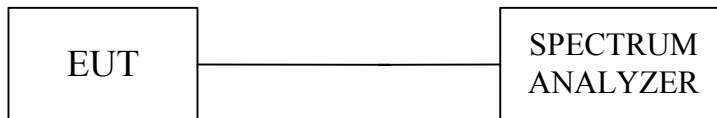

8.3 Limits of Band edge Measurements

1. Below -20dB of the highest emission level of operating band (in 100KHz Resolution Bandwidth).
2. Fall in the restricted bands listed in section 15.205. The maximum permitted average field strength is listed in section 15.209.



8.4 Test Procedure

Section 15.247(c): Spurious emissions. The following tests are required:

Set the span wide enough to capture the peak level of the emission operating on the channel closest to the band edge. Set the RBW and VBW and maxhold the trace. Allow the trace to stabilize. Enable the marker-delta function, then use the marker-delta value function to move the marker to the peak of the in-band emission submit the plot.

8.5 Uncertainty of Conducted Emission

The uncertainty of Frequency : $\pm 100\text{kHz}$.

The uncertainty of Amplitude : $\pm 2\text{dB}$.



8.6 Test Results

Band edge		Measured radiated band edge field strength (dBuV/m)		Radiated band edge field strength limit (dBuV/m)		Test result
		Horizontal	Vertical	Horizontal	Vertical	
2399.90	PK	42.76	46.97	65.44	69.65	PASS
	AVG	41.00	45.35	63.68	68.03	
2483.50	PK	29.95	33.77	74.00	74.00	PASS
	AVG	28.85	32.02	54.00	54.00	

Note : Radiated band edge field strength is measured with FCC recommended mark-delta method.

Measured radiated band edge field strength Test Results = Radiated fundamental emission field strength - DELTA.

DELTA = Relative measurement between conducted measured peak level of fundamental emission and relevant band edge emission. Please refer to 8.7 photo of band edge Measurement.



8.7 Photo of Band edge Measurement

Band edge Compliance of RF Conducted Emissions

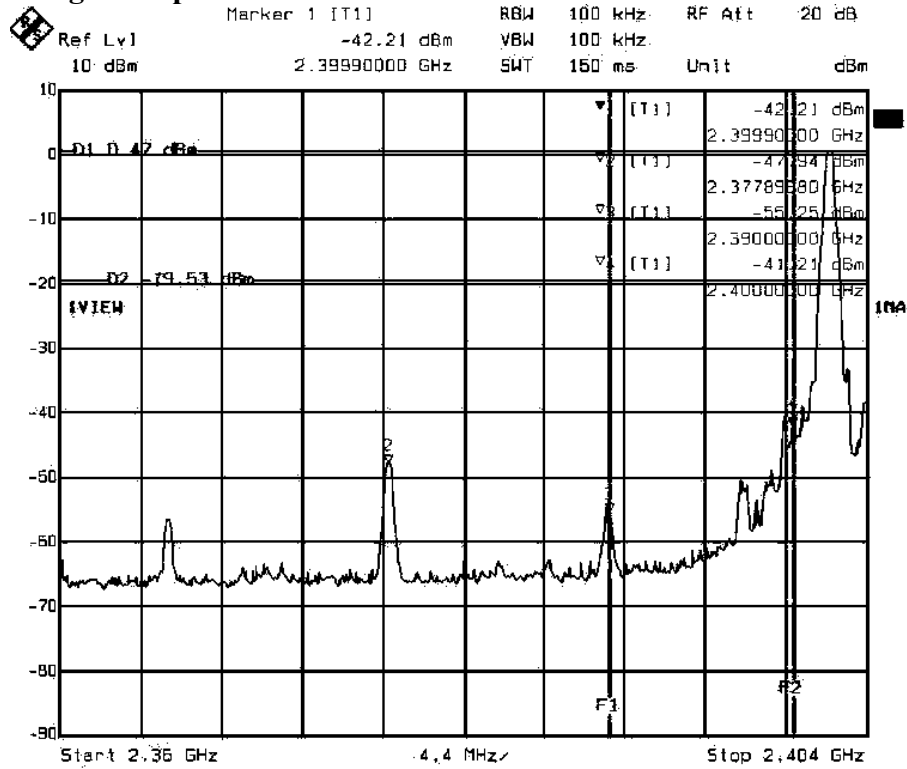

Date: 18.MAY.2004 8:07:16

FRONT

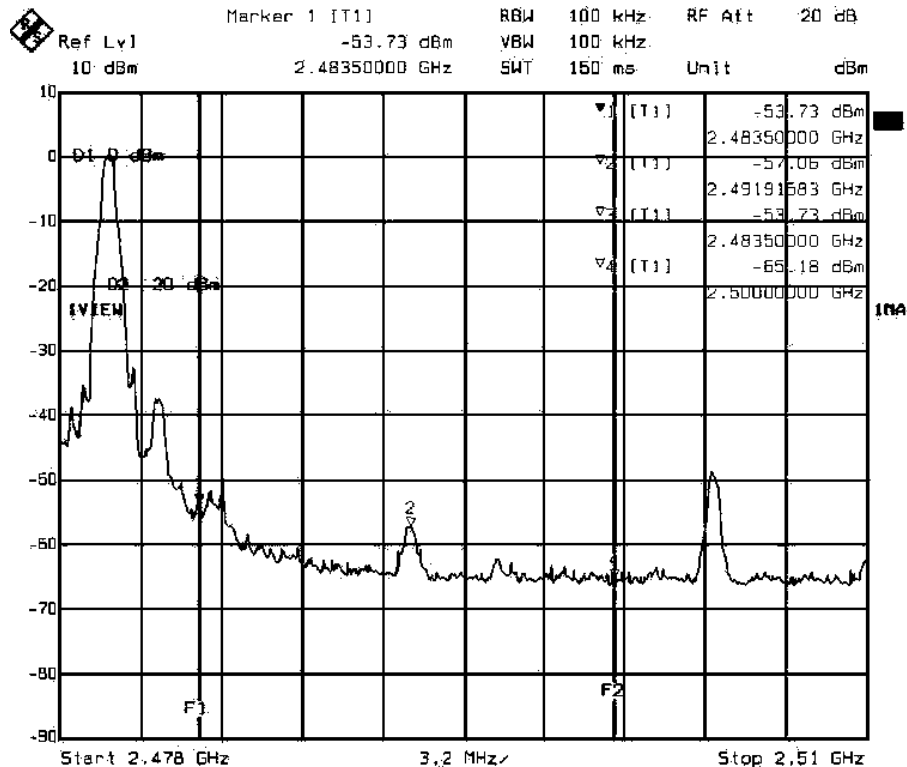

Date: 18.MAY.2004 8:25:18

REAR



Ecom Sertech Corp.

Rm. 258, Bldg. 17, NO.195, Sec. 4 Chung Hsing Rd., ChuTung Chen, Hsinchu, Taiwan 310, R.O.C
TEL:886-3-5918012 FAX: 886-3-5825720

FCC ID : QVZ10320000

Report No. : ER04-01-040FRF

Page 30 of 45

Out-of-band Spurious Emissions-conducted measurement

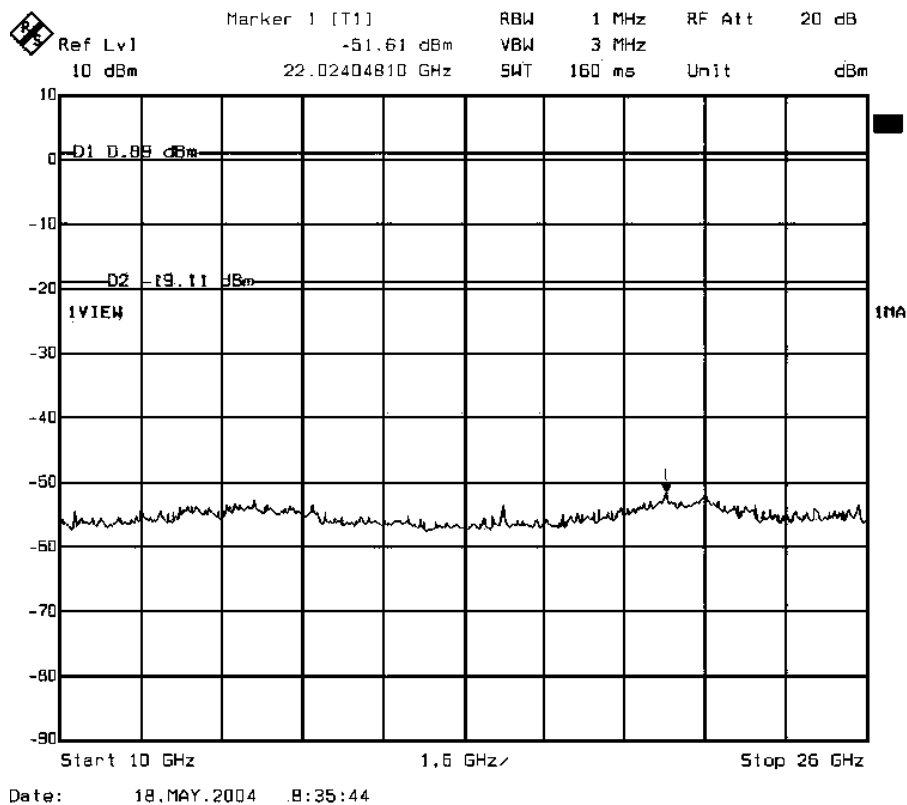
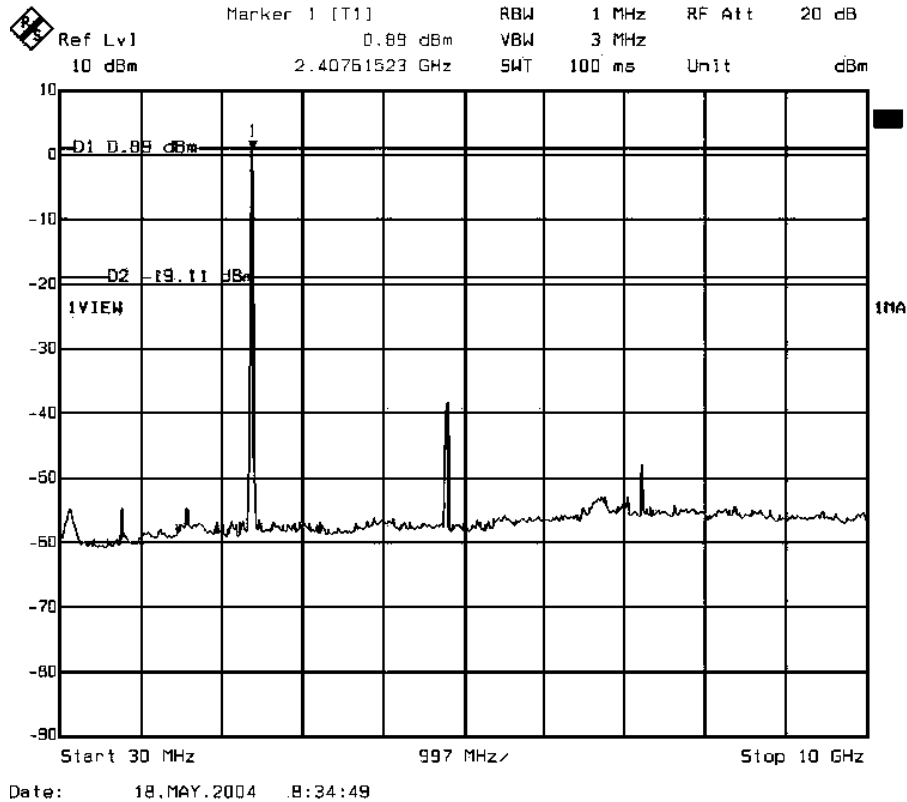

9. OUT OF BAND SPURIOUS EMISSIONS -RADIATED MEASUREMENTS

Test Requirement: 15.247(c)

9.1 Test Equipments

The following test equipments are utilized in making the measurements contained in this report.

Manufacturer or Type	Model No	Serial No	Date of Calibration	Calibration Period	Remark
CHASE BI-LOG ANTENNA	CBL6112B	2421	May 07, 2004	1 Year	FINAL
R/S SPECTRUM ANALYZER	FSEK30	835253/002	June 17, 2003	1 Year	FINAL
OPEN SITE	-----	No.2	May 07, 2004	1 Year	FINAL
N TYPE COAXIAL CABLE	CHA9525	4	July 13, 2003	1 Year	FINAL
Horn Antenna	AH-118	10089	February 25, 2004	1 Year	FINAL
HP Pre-amplifier	8449B	3008A01471	October 11, 2003	1 Year	FINAL
HP High pass filter	84300/80038	011	CAL. ON USE	1 Year	FINAL
Horn Antenna	AH-840	03077	February 25, 2004	1 Year	FINAL

9.2 Test Setup

The diagram below shows the test setup that is utilized to make the measurements for emission from 30 to 1GHz.

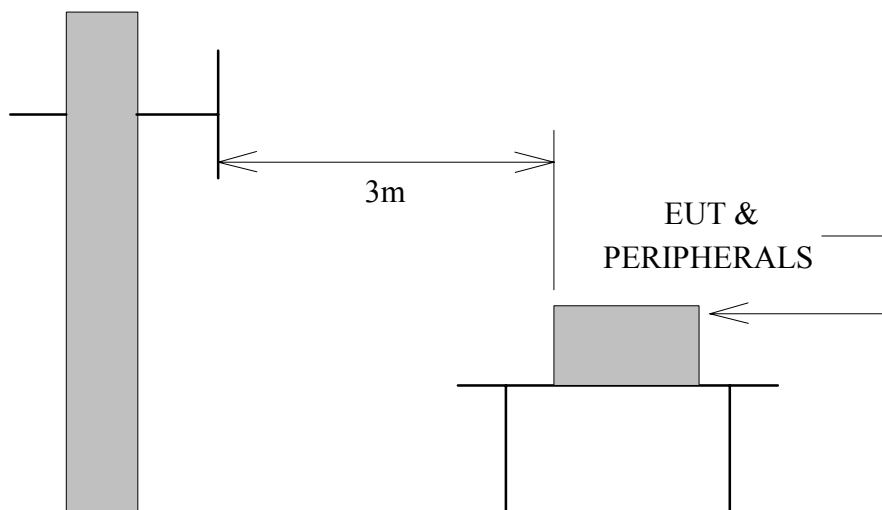

Antenna Elevation Variable

The diagram below shows the test setup that is utilized to make the measurements for emission above 1GHz.

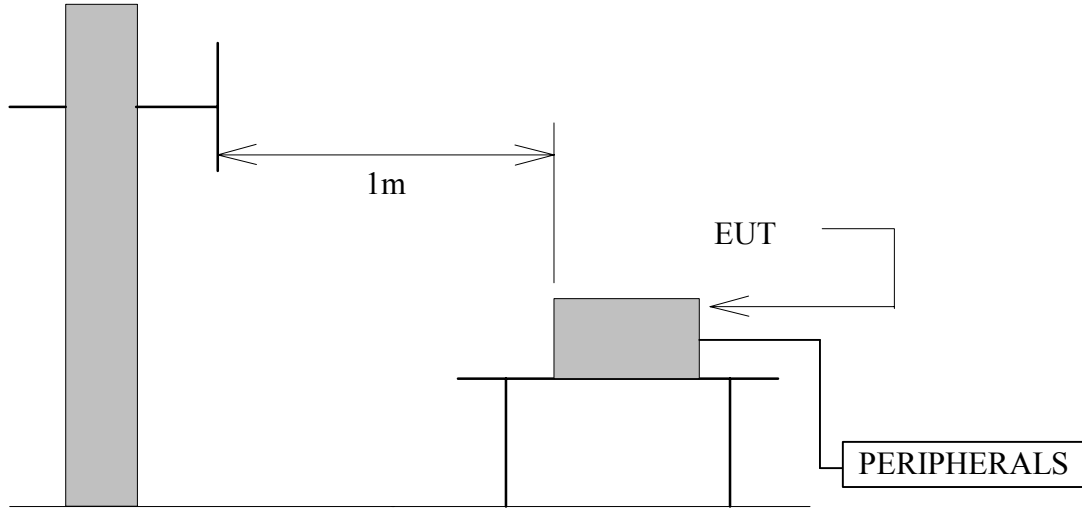

Antenna Elevation Variable

9.3 Radiation Limit

For unintentional device, according to § 15.109(a), except for Class A digital devices, the field strength of radiated emissions from unintentional radiators at a distance of 3 meters shall not exceed the following values :

Frequency (MHz)	Distance (Meters)	Radiated (dBµV/M)	Radiated (µV/M)
30-88	3	40.0	100
88-216	3	43.5	150
216-960	3	46.0	200
Above 960	3	54.0	500

For intentional device, according to § 15.209(a), the general requirement of field strength of radiated emissions from intentional radiators at a distance of 3 meters shall not exceed the above table.



9.4 Test Procedures

- a. The EUT was placed on the top of a rotating table 0.8 meters above the ground at a 10 meter open area test site. The table was rotated 360 degrees to determine the position of the highest radiation.
- b. During performing radiated emission below 1GHz, the EUT was set 3 meters away from the interference-receiving antenna, which was mounted on the top of a variable-height antenna tower. During performing radiated emission above 1GHz, the EUT was set 1 meter away from the interference-receiving antenna.
- c. The antenna is a broadband antenna, and its height is varied from one meter to four meters above the ground to determine the maximum value of the field strength. Both horizontal and vertical polarizations of the antenna are set to make the measurement.
- d. For each suspected emission, the EUT was arranged to its worst case and then the antenna was tuned to heights from 1 meter to 4 meters and the rotatable table was turned from 0 degrees to 360 degrees to find the maximum reading.
- e. The test-receiver system was set to Peak Detect Function and Specified Bandwidth with Maximum Hold Mode.
- f. If the emission level of the EUT in peak mode was 10 dB lower than the limit specified, then testing could be stopped and the peak values of the EUT would be reported. Otherwise the emissions that did not have 10 dB margin would be re-tested one by one using peak, quasi-peak or average method as specified and then reported in a data sheet.

NOTE :

1. The resolution bandwidth and video bandwidth of test receiver/spectrum analyzer is 120 KHz for Peak detection (PK) and Quasi-peak detection (QP) at frequency below 1GHz.
2. The resolution bandwidth and video bandwidth of test receiver/spectrum analyzer is 1 MHz for Peak detection and frequency above 1GHz.
3. The resolution bandwidth of test receiver/spectrum analyzer is 1 MHz and the video bandwidth is 10 Hz for Average detection (AV) at frequency above 1GHz.

9.5 Uncertainty of Radiated Emission

The uncertainty of radiated emission is ± 2.72 dB.



Ecom Sertech Corp.

Rm. 258, Bldg. 17, NO.195, Sec. 4 Chung Hsing Rd., ChuTung Chen, Hsinchu, Taiwan 310, R.O.C
TEL:886-3-5918012 FAX: 886-3-5825720

FCC ID : QVZ10320000

Report No. : ER04-01-040FRF

Page 34 of 45

9.6 Radiated RF Noise Measurement

Test Requirement: 15.109, 15.209

The frequency spectrum from 30 MHz to 1000 MHz was investigated. All emissions not reported are much lower than the prescribed limits.

All readings are quasi-peak values.

Temperature : 24.5 °C

Humidity : 56 % RH

Frequency (MHz)	Antenna Factor (dB)	Cable Loss (dB)	Meter Reading at 3m(dBμV/M)		Limits at 10m (dBμV/M)	Emission Level at 10m(dBμV/M)	
			Horizontal	Vertical		Horizontal	Vertical
30.00	21.39	0.90	*	*	40.00	*	*
125.09	13.33	2.10	6.50	7.10	43.50	21.93	22.53
250.00	13.09	3.20	7.00	6.80	46.00	23.29	23.09
300.00	13.50	3.60	6.50	6.70	46.00	23.60	23.80
350.99	15.41	3.91	11.70	9.60	46.00	31.01	28.91
667.72	19.47	5.74	9.20	8.50	46.00	34.40	33.70
699.24	19.43	5.90	10.20	10.70	46.00	35.53	36.03
750.01	19.98	6.15	5.50	5.70	46.00	31.63	31.83
1000.00	21.58	7.00	*	*	54.00	*	*

REMARKS : 1. * Undetectable

2. Emission level (dB μ V/M) = Antenna Factor (dB/m) + Cable loss (dB)
+ Meter Reading (dB μ V).



Ecom Sertech Corp.

Rm. 258, Bldg. 17, NO.195, Sec. 4 Chung Hsing Rd., ChuTung Chen, Hsinchu, Taiwan 310, R.O.C
 TEL:886-3-5918012 FAX: 886-3-5825720

FCC ID : QVZ10320000

Report No. : ER04-01-040FRF

Page 35 of 45

Test Requirement: 15.205

The frequency spectrum above 1 GHz was investigated. All emissions not reported are much lower than the prescribed limits. Readings are both peak and average values.

Company	Microlink Communications Inc.	Test Date :	2004/04/13
Product Name	Bluetooth USB Button Dongle	Test By:	Stan Peng
Model Name	MBT-1203-01	Temp& Humidity :	22.1°C , 80%

CH01 (2402 MHz) TX (Low)				Measurement Distance at 1m				Horizontal polarity				
Freq.	Reading	AF	Cable	Pre-amp	Dist	Filter	Level	Limit	Margin	Mark	Height	
(MHz)	(dBμV)	(dBμV)	(dB)	(dB)	dB	dB	(dBμV/m)	(dBμV/m)	(dB)	(P/Q/A)	(Meter)	
*	2389.90	22.31	31.81	3.57	0.00	9.50	0.00	48.19	74	-25.81	P	1.00
*	2389.90	11.06	31.81	3.57	0.00	9.50	0.00	36.94	54	-17.06	A	1.00
	2402.12	59.57	31.80	3.58	0.00	9.50	0.00	85.44	Fundamental Frequency		P	1.00
	2402.12	57.81	31.80	3.58	0.00	9.50	0.00	83.68			A	1.00
*	4803.61	58.30	34.30	5.08	35.14	9.50	2.09	55.12	74	-18.88	P	1.00
*	4803.61	56.00	34.30	5.08	35.14	9.50	2.09	52.82	54	-1.18	A	1.00
	7206.26	48.21	39.82	6.72	35.66	9.50	2.00	51.59	74	-22.41	P	1.00
	7206.26	41.57	39.82	6.72	35.66	9.50	2.00	44.95	54	-9.05	A	1.00
	9608.53	53.72	38.54	8.28	36.37	9.50	0.63	55.30	74	-18.70	P	1.00
	9608.53	47.23	38.54	8.28	36.37	9.50	0.63	48.81	54	-5.19	A	1.00
*	12010.60	-----	-----	-----	-----	9.50	0.80	-----	-----	-----	-----	1.00
	14412.72	-----	-----	-----	-----	0.00	0.60	-----	-----	-----	-----	1.00
	16814.84	-----	-----	-----	-----	0.00	0.39	-----	-----	-----	-----	1.00
*	19216.96	-----	-----	-----	-----	0.00	1.86	-----	-----	-----	-----	1.00
	21619.08	-----	-----	-----	-----	0.00	0.85	-----	-----	-----	-----	1.00
	24021.20	-----	-----	-----	-----	0.00	3.07	-----	-----	-----	-----	1.00

Note :

- The measurement was searched to 10th harmonic, Remark “---” means that the emissions level is too low to be measured.
- AF: Antenna Factor, Cable: Cable Loss, Pre-Amp: Preamplifier gain, Filter : High Pass Filter Insertion Loss (3.5GHz)
- Analyzer setting P(Peak): RBW=1MHz, VBW=1MHz, A(Average): RBW=1MHz, VBW=10Hz
- Remark “*” means that Restricted band.
- Dist : correction to extra plate reading to 3m specification distance 1m measurement distance = -9.5dB
- The result basic equation calculation is as follow:
 $Level = Reading + AF + Closs - Preamp + Filter - Dist$, $Margin = Level - Limit$
- The other emission levels were very low against the limit
- The test limit distance is 3M limit.
- The test data marked in gray background means the EUT emission data is located in the margin uncertainty range of emission limits.



Ecom Sertech Corp.

Rm. 258, Bldg. 17, NO.195, Sec. 4 Chung Hsing Rd., ChuTung Chen, Hsinchu, Taiwan 310, R.O.C
 TEL:886-3-5918012 FAX: 886-3-5825720

FCC ID : QVZ10320000

Report No. : ER04-01-040FRF

Page 36 of 45

Test Requirement: 15.205

The frequency spectrum above 1 GHz was investigated. All emissions not reported are much lower than the prescribed limits. Readings are both peak and average values.

Company	Microlink Communications Inc.	Test Date :	2004/04/13
Product Name	Bluetooth USB Button Dongle	Test By:	Stan Peng
Model Name	MBT-1203-01	Temp& Humidity :	22.1°C , 80%

CH01 (2402 MHz) TX (Low)				Measurement Distance at 1m				Vertical polarity			
Freq.	Reading	AF	Cable	Pre-amp	Dist	Filter	Level	Limit	Margin	Mark	Height
(MHz)	(dBμV)	(dBμV)	(dB)	(dB)	dB	dB	(dBμV/m)	(dBμV/m)	(dB)	(P/Q/A)	(Meter)
* 2389.90	24.44	31.81	3.57	0.00	9.50	0.00	50.32	74	-23.68	P	1.00
* 2389.90	11.83	31.81	3.57	0.00	9.50	0.00	37.71	54	-16.29	A	1.00
2402.15	63.78	31.80	3.58	0.00	9.50	0.00	89.65	Fundamental Frequency		P	1.00
2402.15	62.16	31.80	3.58	0.00	9.50	0.00	88.03			A	1.00
* 4803.69	54.29	34.30	5.08	35.14	9.50	2.09	51.11	74	-22.89	P	1.00
* 4803.69	50.98	34.30	5.08	35.14	9.50	2.09	47.80	54	-6.20	A	1.00
7206.11	48.72	39.82	6.72	35.66	9.50	2.00	52.10	74	-21.90	P	1.00
7206.11	41.48	39.82	6.72	35.66	9.50	2.00	44.86	54	-9.14	A	1.00
9608.50	54.27	38.54	8.28	36.37	9.50	0.63	55.85	74	-18.15	P	1.00
9608.50	47.82	38.54	8.28	36.37	9.50	0.63	49.40	54	-4.60	A	1.00
* 12010.75	-----	-----	-----	-----	9.50	0.80	-----	-----	-----	-----	1.00
14412.90	-----	-----	-----	-----	0.00	0.60	-----	-----	-----	-----	1.00
16815.05	-----	-----	-----	-----	0.00	0.39	-----	-----	-----	-----	1.00
* 19217.20	-----	-----	-----	-----	0.00	1.86	-----	-----	-----	-----	1.00
21619.35	-----	-----	-----	-----	0.00	0.85	-----	-----	-----	-----	1.00
24021.50	-----	-----	-----	-----	0.00	3.07	-----	-----	-----	-----	1.00

Note :

- The measurement was searched to 10th harmonic, Remark “---” means that the emissions level is too low to be measured.
- AF: Antenna Factor, Cable: Cable Loss, Pre-Amp: Preamplifier gain, Filter : High Pass Filter Insertion Loss (3.5GHz)
- Analyzer setting P(Peak): RBW=1MHz, VBW=1MHz, A(Average): RBW=1MHz, VBW=10Hz
- Remark “*” means that Restricted band.
- Dist : correction to extra plate reading to 3m specification distance 1m measurement distance = -9.5dB
- The result basic equation calculation is as follow:
 $Level=Reading+AF+Closs-Preamp+Filter-Dist, Margin=Level-Limit$
- The other emission levels were very low against the limit
- The test limit distance is 3M limit.



Ecom Sertech Corp.

Rm. 258, Bldg. 17, NO.195, Sec. 4 Chung Hsing Rd., ChuTung Chen, Hsinchu, Taiwan 310, R.O.C
 TEL:886-3-5918012 FAX: 886-3-5825720

FCC ID : QVZ10320000

Report No. : ER04-01-040FRF

Page 37 of 45

Test Requirement: 15.205

The frequency spectrum above 1 GHz was investigated. All emissions not reported are much lower than the prescribed limits. Readings are both peak and average values.

Company	Microlink Communications Inc.	Test Date :	2004/04/13
Product Name	Bluetooth USB Button Dongle	Test By:	Stan Peng
Model Name	MBT-1203-01	Temp& Humidity :	22.1°C , 80%

CH40 (2441 MHz) TX (Mid)				Measurement Distance at 1m				Horizontal polarity			
Freq.	Reading	AF	Cable	Pre-amp	Dist	Filter	Level	Limit	Margin	Mark	Height
(MHz)	(dBμV)	(dBμV)	(dB)	(dB)	dB	dB	(dBμV/m)	(dBμV/m)	(dB)	(P/Q/A)	(Meter)
2441.11	56.35	31.76	3.59	0.00	9.50	0.00	82.20	Fundamental Frequency		P	1.00
2441.11	54.62	31.76	3.59	0.00	9.50	0.00	80.47			A	1.00
* 4882.15	57.05	34.82	5.10	35.21	9.50	1.77	54.04	74	-19.96	P	1.00
* 4882.15	52.03	34.82	5.10	35.21	9.50	1.77	49.02	54	-4.98	A	1.00
* 7323.13	49.64	39.77	6.80	35.64	9.50	2.00	53.08	74	-20.92	P	1.00
* 7323.13	41.44	39.77	6.80	35.64	9.50	2.00	44.88	54	-9.12	A	1.00
9764.47	52.88	38.52	8.34	36.62	9.50	0.54	54.16	74	-19.84	P	1.00
9764.47	43.09	38.52	8.34	36.62	9.50	0.54	44.37	54	-9.63	A	1.00
* 12205.55	-----	-----	-----	-----	9.50	0.80	-----	-----	-----	-----	1.00
14646.66	-----	-----	-----	-----	0.00	0.58	-----	-----	-----	-----	1.00
17087.77	-----	-----	-----	-----	0.00	0.54	-----	-----	-----	-----	1.00
* 19528.88	-----	-----	-----	-----	0.00	2.23	-----	-----	-----	-----	1.00
21969.99	-----	-----	-----	-----	0.00	0.71	-----	-----	-----	-----	1.00
24411.10	-----	-----	-----	-----	0.00	2.44	-----	-----	-----	-----	1.00

Note :

- The measurement was searched to 10th harmonic, Remark “---” means that the emissions level is too low to be measured.
- AF: Antenna Factor, Cable: Cable Loss, Pre-Amp: Preamplifier gain, Filter : High Pass Filter Insertion Loss (3.5GHz)
- Analyzer setting P(Peak): RBW=1MHz, VBW=1MHz, A(Average): RBW=1MHz, VBW=10Hz
- Remark “*” means that Restricted band.
- Dist : correction to extra plate reading to 3m specification distance 1m measurement distance = -9.5dB
- The result basic equation calculation is as follow:
 $Level = Reading + AF + Closs - Preamp + Filter - Dist, Margin = Level - Limit$
- The other emission levels were very low against the limit
- The test limit distance is 3M limit.



Ecom Sertech Corp.

Rm. 258, Bldg. 17, NO.195, Sec. 4 Chung Hsing Rd., ChuTung Chen, Hsinchu, Taiwan 310, R.O.C
 TEL:886-3-5918012 FAX: 886-3-5825720

FCC ID : QVZ10320000

Report No. : ER04-01-040FRF

Page 38 of 45

Test Requirement: 15.205

The frequency spectrum above 1 GHz was investigated. All emissions not reported are much lower than the prescribed limits. Readings are both peak and average values.

Company	Microlink Communications Inc.	Test Date :	2004/04/13
Product Name	Bluetooth USB Button Dongle	Test By:	Stan Peng
Model Name	MBT-1203-01	Temp& Humidity :	22.1°C , 80%

CH40 (2441 MHz) TX (Mid)				Measurement Distance at 1m				Vertical polarity			
Freq.	Reading	AF	Cable	Pre-amp	Dist	Filter	Level	Limit	Margin	Mark	Height
(MHz)	(dBμV)	(dBμV)	(dB)	(dB)	dB	dB	(dBμV/m)	(dBμV/m)	(dB)	(P/Q/A)	(Meter)
2441.16	59.56	31.76	3.59	0.00	9.50	0.00	85.41	Fundamental Frequency		P	1.00
2441.16	58.35	31.76	3.59	0.00	9.50	0.00	84.20			A	1.00
* 4882.20	55.82	34.82	5.10	35.21	9.50	1.77	52.81	74	-21.19	P	1.00
* 4882.20	48.83	34.82	5.10	35.21	9.50	1.77	45.82	54	-8.18	A	1.00
* 7323.26	53.20	39.77	6.80	35.64	9.50	2.00	56.64	74	-17.36	P	1.00
* 7323.26	44.77	39.77	6.80	35.64	9.50	2.00	48.21	54	-5.79	A	1.00
9764.23	50.78	38.52	8.34	36.62	9.50	0.54	52.06	74	-21.94	P	1.00
9764.23	42.18	38.52	8.34	36.62	9.50	0.54	43.46	54	-10.54	A	1.00
* 12205.80	-----	-----	-----	-----	9.50	0.80	-----	-----	-----	-----	1.00
14646.96	-----	-----	-----	-----	0.00	0.58	-----	-----	-----	-----	1.00
17088.12	-----	-----	-----	-----	0.00	0.54	-----	-----	-----	-----	1.00
* 19529.28	-----	-----	-----	-----	0.00	2.23	-----	-----	-----	-----	1.00
21970.44	-----	-----	-----	-----	0.00	0.71	-----	-----	-----	-----	1.00
24411.60	-----	-----	-----	-----	0.00	2.44	-----	-----	-----	-----	1.00

Note :

- The measurement was searched to 10th harmonic, Remark “---” means that the emissions level is too low to be measured.
- AF: Antenna Factor, Cable: Cable Loss, Pre-Amp: Preamplifier gain, Filter : High Pass Filter Insertion Loss (3.5GHz)
- Analyzer setting P(Peak): RBW=1MHz, VBW=1MHz, A(Average): RBW=1MHz, VBW=10Hz
- Remark “*” means that Restricted band.
- Dist : correction to extra plate reading to 3m specification distance 1m measurement distance = -9.5dB
- The result basic equation calculation is as follow:
 $Level = Reading + AF + Closs - Preamp + Filter - Dist, Margin = Level - Limit$
- The other emission levels were very low against the limit
- The test limit distance is 3M limit.



Ecom Sertech Corp.

Rm. 258, Bldg. 17, NO.195, Sec. 4 Chung Hsing Rd., ChuTung Chen, Hsinchu, Taiwan 310, R.O.C
 TEL:886-3-5918012 FAX: 886-3-5825720

FCC ID : QVZ10320000

Report No. : ER04-01-040FRF

Page 39 of 45

Test Requirement: 15.205

The frequency spectrum above 1 GHz was investigated. All emissions not reported are much lower than the prescribed limits. Readings are both peak and average values.

Company	Microlink Communications Inc.	Test Date :	2004/04/13
Product Name	Bluetooth USB Button Dongle	Test By:	Stan Peng
Model Name	MBT-1203-01	Temp& Humidity :	22.1°C , 80%

CH79 (2480 MHz) TX (High)				Measurement Distance at 1m				Horizontal polarity			
Freq.	Reading	AF	Cable	Pre-amp	Dist	Filter	Level	Limit	Margin	Mark	Height
(MHz)	(dBμV)	(dBμV)	(dB)	(dB)	dB	dB	(dBμV/m)	(dBμV/m)	(dB)	(P/Q/A)	(Meter)
2480.17	57.85	31.72	3.61	0.00	9.50	0.00	83.68	Fundamental Frequency		P	1.00
2480.17	56.75	31.72	3.61	0.00	9.50	0.00	82.58			A	1.00
* 2483.65	22.34	31.72	3.61	0.00	9.50	0.00	48.17	74	-25.83	P	1.00
* 2483.65	10.98	31.72	3.61	0.00	9.50	0.00	36.81	54	-17.19	A	1.00
* 4959.65	58.36	35.33	5.13	35.27	9.50	1.46	55.51	74	-18.49	P	1.00
* 4959.65	56.15	35.33	5.13	35.27	9.50	1.46	53.30	54	-0.70	A	1.00
* 7440.33	51.97	39.72	6.88	35.61	9.50	2.00	55.46	74	-18.54	P	1.00
* 7440.33	45.65	39.72	6.88	35.61	9.50	2.00	49.14	54	-4.86	A	1.00
9920.57	52.33	38.51	8.39	36.87	9.50	0.45	53.30	74	-20.70	P	1.00
9920.57	45.46	38.51	8.39	36.87	9.50	0.45	46.43	54	-7.57	A	1.00
* 12400.85	-----	-----	-----	-----	9.50	0.80	-----	-----	-----	-----	1.00
14881.02	-----	-----	-----	-----	0.00	0.40	-----	-----	-----	-----	1.00
17361.19	-----	-----	-----	-----	0.00	0.64	-----	-----	-----	-----	1.00
* 19841.36	-----	-----	-----	-----	0.00	2.54	-----	-----	-----	-----	1.00
* 22321.53	-----	-----	-----	-----	0.00	0.70	-----	-----	-----	-----	1.00
24801.70	-----	-----	-----	-----	0.00	1.88	-----	-----	-----	-----	1.00

Note :

- The measurement was searched to 10th harmonic, Remark “---” means that the emissions level is too low to be measured.
- AF: Antenna Factor, Cable: Cable Loss, Pre-Amp: Preamplifier gain, Filter : High Pass Filter Insertion Loss (3.5GHz)
- Analyzer setting P(Peak): RBW=1MHz, VBW=1MHz, A(Average): RBW=1MHz, VBW=10Hz
- Remark “*” means that Restricted band.
- Dist : correction to extra plate reading to 3m specification distance 1m measurement distance = -9.5dB
- The result basic equation calculation is as follow:
 $Level=Reading+AF+Closs-Preamp+Filter-Dist, Margin=Level-Limit$
- The other emission levels were very low against the limit
- The test limit distance is 3M limit.
- The test data marked in gray background means the EUT emission data is located in the margin uncertainty range of emission limits.



Ecom Sertech Corp.

Rm. 258, Bldg. 17, NO.195, Sec. 4 Chung Hsing Rd., ChuTung Chen, Hsinchu, Taiwan 310, R.O.C
 TEL:886-3-5918012 FAX: 886-3-5825720

FCC ID : QVZ10320000

Report No. : ER04-01-040FRF

Page 40 of 45

Test Requirement: 15.205

The frequency spectrum above 1 GHz was investigated. All emissions not reported are much lower than the prescribed limits. Readings are both peak and average values.

Company	Microlink Communications Inc.	Test Date :	2004/04/13
Product Name	Bluetooth USB Button Dongle	Test By:	Stan Peng
Model Name	MBT-1203-01	Temp& Humidity :	22.1°C , 80%

CH79 (2480 MHz) TX (High)				Measurement Distance at 1m				Vertical polarity			
Freq.	Reading	AF	Cable	Pre-amp	Dist	Filter	Level	Limit	Margin	Mark	Height
(MHz)	(dBμV)	(dBμV)	(dB)	(dB)	dB	dB	(dBμV/m)	(dBμV/m)	(dB)	(P/Q/A)	(Meter)
2480.20	61.67	31.72	3.61	0.00	9.50	0.00	87.50	Fundamental Frequency		P	1.00
2480.20	59.92	31.72	3.61	0.00	9.50	0.00	85.75			A	1.00
* 2483.65	23.01	31.72	3.61	0.00	9.50	0.00	48.84	74	-25.16	P	1.00
* 2483.65	11.39	31.72	3.61	0.00	9.50	0.00	37.22	54	-16.78	A	1.00
* 4959.65	54.98	35.33	5.13	35.27	9.50	1.46	52.13	74	-21.87	P	1.00
* 4959.65	51.87	35.33	5.13	35.27	9.50	1.46	49.02	54	-4.98	A	1.00
* 7440.21	47.43	39.72	6.88	35.61	9.50	2.00	50.92	74	-23.08	P	1.00
* 7440.21	39.47	39.72	6.88	35.61	9.50	2.00	42.96	54	-11.04	A	1.00
9920.46	50.10	38.51	8.39	36.87	9.50	0.45	51.07	74	-22.93	P	1.00
9920.46	42.48	38.51	8.39	36.87	9.50	0.45	43.45	54	-10.55	A	1.00
* 12401.00	-----	-----	-----	-----	9.50	0.80	-----	-----	-----	-----	1.00
14881.20	-----	-----	-----	-----	0.00	0.40	-----	-----	-----	-----	1.00
17361.40	-----	-----	-----	-----	0.00	0.64	-----	-----	-----	-----	1.00
* 19841.60	-----	-----	-----	-----	0.00	2.54	-----	-----	-----	-----	1.00
* 22321.80	-----	-----	-----	-----	0.00	0.70	-----	-----	-----	-----	1.00
24802.00	-----	-----	-----	-----	0.00	1.88	-----	-----	-----	-----	1.00

Note :

- The measurement was searched to 10th harmonic, Remark “---” means that the emissions level is too low to be measured.
- AF: Antenna Factor, Cable: Cable Loss, Pre-Amp: Preamplifier gain, Filter : High Pass Filter Insertion Loss (3.5GHz)
- Analyzer setting P(Peak): RBW=1MHz, VBW=1MHz, A(Average): RBW=1MHz, VBW=10Hz
- Remark “*” means that Restricted band.
- Dist : correction to extra plate reading to 3m specification distance 1m measurement distance = -9.5dB
- The result basic equation calculation is as follow:
 $Level = Reading + AF + Closs - Preamp + Filter - Dist, Margin = Level - Limit$
- The other emission levels were very low against the limit
- The test limit distance is 3M limit.

9.7 Photos of Open Site





Ecom Sertech Corp.

Rm. 258, Bldg. 17, NO.195, Sec. 4 Chung Hsing Rd., ChuTung Chen, Hsinchu, Taiwan 310, R.O.C
TEL:886-3-5918012 FAX : 886-3-5825720

FCC ID : QVZ10320000

Report No. : ER04-01-040FRF

Page 42 of 45





10. ANTENNA REQUIREMENT

10.1 Standard Applicable

For intentional device, according to FCC 47 CFR Section 15.203, an intentional radiator shall be designed to ensure that no antenna other than that furnished by the responsible party shall be used with the device.

And according to FCC 47 CFR Section 15.247 (b), if transmitting antennas of directional gain greater than 6dBi are used, the power shall be reduced by the amount in dB that the directional gain of the antenna exceeds 6dBi.

10.2 Antenna Connected Construction

The antenna used in this product is Printed antenna. The maximum Gain of this antenna is only 1.6dBi.



11. RF EXPOSURE EVALUATION

According to FCC 1.1310 : The criteria listed in the following table shall be used to evaluate the environment impact of human exposure to radio frequency (RF) radiation as specified in 1.1307(b)
LIMITS FOR MAXIMUM PERMISSIBLE EXPOSURE (MPE)

Frequency Range (MHz)	Electric Field Strength (V/m)	Magnetic Field Strength (A/m)	Power Density (mW/cm ²)	Average Time
(A) Limits for Occupational / Control Exposures				
300-1,500	--	--	F/300	6
1,500-100,000	--	--	5	6
(B) Limits for General Population / Uncontrol Exposures				
300-1,500	--	--	F/1500	6
1,500-100,000	--	--	1	30

11.1 Friis Formula

Friis transmission formula : $P_d = (P_{out} * G) / (4 * \pi * r^2)$

Where

P_d = power density in mW/cm²

P_{out} = output power to antenna in mW

G = gain of antenna in linear scale

π = 3.1416

R = distance between observation point and center of the radiator in cm

P_d is the limit of MPE, 1 mW/cm². If we know the maximum gain of the antenna and the total power input to the antenna, through the calculation, we will know the distance r where the MPE limit is reached.

11.2 EUT Operating Condition

A software provided by client enabled the EUT to transmit and receive data at lowest, middle and highest channel individually.



11.3 Test Result of RF Exposure Evaluation

Test Item : RF Exposure Evaluation Data

Test Mode : Normal Operation

11.3.1 Antenna Gain

Antenna Gain : The maximum Gain measured in fully anechoic chamber is 1.6dBi linear scale.

11.3.2 Output Power into Antenna & RF Exposure Evaluation Distance

Channel	Channel Frequency (MHz)	Output Power to Antenna (dBm) e.i.r.p	Antenna Gain	Power Density at 20cm (mW/cm ²)	LIMITS (mW/cm ²)
CH01 (Low)	2402.00	1.44	1.6	0.000401	1
CH40 (Mid)	2441.00	1.27	1.6	0.000385	1
CH79 (High)	2480.00	0.96	1.6	0.000359	1

The power density Pd (4th column) at a distance of 20cm calculated from the Friis transmission formula is far below the limit of 1 mW/cm². The EUT is classified as portable product and the output power is lower than the FCC low threshold. So, RF exposure limit warning or SAR test are not required.