

USER'S GUIDE

AMM215WTTP

LCD Color Display



ADVAN

Table of Contents

Warnings and Cautions 1

Warnings	2
Cautions	3
Symbol Definitions	4

Usage Notice 9

Precautions	9
-------------------	---

Introduction 10

About AMM215WTTTP Series	10
Touch Screen for AMM215WTTTP	10
Package Overview	11

Installation 13

Product Overview	13
Front View	13
Bottom View (Without Stand)	13
VESA Mount for Your Monitor	14
Start Your Installation	15
Connecting the Display	16
Figure	17

User Controls 18

Side Panel Controls	18
How to Use the OSD Menus	19
On-Screen Display Menus	20

Appendix 21

Troubleshooting	21
Warning Signal	22
No Signal	22
Going to Sleep	22
Out of Range	22
Product Dimensions	23
Compatibility Modes	24
Touch Screen Driver Installation	25
AMM215WTTTP Driver Install Instructions	25

Description of Warranty 27

The information contained in this document is subject to change without notice.

This document contains proprietary information that is protected by copyright. All rights are reserved. No part of this document may be reproduced, translated to another language or stored in a retrieval system, or transmitted by any means, electronic, mechanical, photocopying, recording, or otherwise, without prior written permission. Windows is a registered trademark of Microsoft, Inc. Other brand or product names are trademarks of their respective holders.

Caution!

Any changes or modifications not expressly approved by the party responsible for compliance could void the user's authority to operate the equipment.

Warnings and Cautions

Please read this manual and follow its instructions carefully. The words warning, caution, and note carry special meanings and should be carefully reviewed:



Warning The personal safety of the patient or physician may be involved. Disregarding this information could result in injury to the patient or physician.

Caution Special service procedures or precautions must be followed to avoid damaging the instrument.

Note Special information to make maintenance easier or important information more clear.



A lightning bolt within a triangle is intended to warn of the presence of hazardous voltage. Refer all service to authorized personnel.

Warranty is void if any of these warnings are disregarded.

ADVAN Int'l Corp accepts full responsibility for the effects on safety, reliability, and performance of the equipment only if:

- Re-adjustments, modifications, and/or repairs are carried out exclusively by ADVAN Int'l Corp.
- The electrical installation of the relevant operating room complies with the applicable IEC and CE requirements.



Warning Federal law (United States of America) restricts this device to use by, or on order of a physician.

ADVAN Int'l Corp's AMM215WTTP monitor has been tested under ANSI/AAMI ES60601-1 standard for Medical application.

ADVAN Int'l Corp reserves the right to make improvements in the product(s) described herein. Product(s), therefore, may not agree in detail to the published design or specifications. All specifications are subject to change without notice.

Please use rear cover page with ADVAN contact points or phone your local ADVAN Int'l Corp sales representative or agent for information on changes and new products.

Warnings



Warning TO AVOID POTENTIAL SERIOUS INJURY TO THE USER AND THE PATIENT AND/OR DAMAGE TO THIS DEVICE, THE USER MUST :

1. Read the operating manual thoroughly and be familiar with its contents prior to using this equipment.
2. Carefully unpack the unit and check if any damage occurred during shipment.
3. Should any solid object or liquid fall into the panel, unplug the unit and have it checked by qualified personnel before operating it any further.
4. Unplug the unit if it is not to be used for an extended period of time. To disconnect the cord, pull it out by the plug. Never pull the cord itself.
5. Be a qualified physician, having complete knowledge of the use of this equipment.
6. Test this equipment prior to a medical procedure. This monitor was fully tested at the factory before shipment.
7. Avoid removing covers on control unit to avoid electric shock.
8. Attempt no internal repairs or adjustments not specifically detailed in this operating manual.
9. Pay close attention to the care, cleaning instructions in this manual. A deviation may cause damage (refer to the Cleaning section).
10. DO NOT STERILIZE MONITOR.
11. Read the entire instruction manual before assembling or connecting the camera.
12. Do not place the monitor or any other heavy object on the power cord. Damage to the cable can cause fire or electric shock.
13. Monitor with power supply is suitable for use in patient environment.
14. DO NOT stack more than "6" boxes high.
15. To avoid risk of electric shock, this equipment must only be connected to supply mains with protective earth.
16. Do not modify this equipment without authorization of the manufacturer.
17. Power cord is used as a disconnection device. To de-energize equipment, disconnect the power cord. ME Equipment should be placed easily powered off place.

This equipment has been tested and found to comply with the limits for medical devices in IEC 60601-1-2. These limits are designed to provide reasonable protection against harmful interference in a typical medical installation.

NOTICES TO USER

This device complies with Part 15 of the FCC Rules. Operation is subject to the following two conditions:

(1) this device may not cause harmful interference, and (2) this device must accept any interference received, including interference that may cause undesired operation.

Cautions

1. The AC Adapter must be plugged into a grounded power outlet.
2. Use only the proprietary AMM215WTTP power supply for the AMM215WTTP monitor.
3. Turn power off when unit is not in use. Disconnect the power plug from AC outlet if the product is not going to be used for an extended period of time.
4. Never operate the unit right after having transported from a cold location directly to a warm location.
5. Do not expose the monitor to moisture or directly apply liquid cleaners directly to the screen. Spray the cleaning solution into a soft cloth and clean gently.
6. Handle the monitor with care. Do not strike or scratch the screen.
7. Do not block the monitor cooling vents. The monitor is cooled by natural convection and has no fan.
8. Do not force the monitor past 28 degrees of vertical when adjusting the screen position. (For monitors equipped with stands only.)
9. Remove the power module and connection when transporting the unit.
10. Save the original carton and associated packing material. They will be useful should you have to transport or ship the unit.
11. Allow adequate air circulation to prevent internal heat buildup.
12. Do not place the unit on surfaces (rugs, blankets, etc.) or near materials (curtains, draperies) that may block the ventilation slots.
13. Do not install the unit near sunlight, excessive dust, mechanical vibration or shock.
14. The unit is designed for operation in a horizontal position. Never operate the unit in a vertical position.
15. Keep the unit away from equipment with strong magnets (i.e. a large loudspeaker.)
16. Equipment with SIP/SOP connectors should either comply with IEC 60601-1 and/or IEC 60601-1-1 harmonized national standard or the combination should be evaluated. Do not touch the patient with signal input or output connectors.
17. Use only a hospital grade power supply cord.
18. This equipment has been tested and found to comply with the limit for a Class B digital device, pursuant to Part 15 of the FCC Rules. These limits are designed to provide reasonable generate uses and can radiate radio frequency energy, if not installed and used in accordance with the instructions, may cause harmful interference to radio communications. However, there is no guarantee that interference will not occur in a particular installation, which can be determined by turning the equipment off and on, the user is encourage to try to correct the interference by one or more of the following measures:
 - Reorient or relocate the receiving device.
 - Increase the separation distance between the equipment.
 - Connect the equipment to an outlet on a circuit different from that to which the other device(s) are connected.
 - Consult the manufacturer or field service technician for help.
19. Grounding reliability can only be achieved when the equipment is connected to an equipment receptacle labeled "Hospital Only" or "Hospital Grade."

Caution To connect to an international power supply, use a an attachment plug appropriate for the power outlet.

Caution Refer to the "Electromagnetic Compatibility" (EMC) section of this manual to ensure EMC. The AMM215WTTP must be installed and operated according to the EMC information provided in this manual.

Symbol Definitions



General warning sign of risk of danger



Dangerous: High Voltage



Direct Current



Serial Number



This way up



Fragile, handle with care



Stacking limit by number



Keep dry



Recyclable



Indicates proof of conformity to applicable European "Economic Community Council" directives and to harmonized standards published in the official journal of the European Communities.



Authorized Representative in Europe



Date of Manufacture



Manufacturer



For indoor use only.



Tested to comply with FCC Class B standards.



DC power control switch



Medical Equipment
With respect to electric shock, fire and mechanical hazards only in accordance with ANSI/AAMI ES60601-1(2005/(R)2012 + A1:2012, C1:2009/(R)2012 + A2:2010/(R)2012), and CSA-C22.2 NO. 60601-1:14 Edition 3 - Revision Date 2014.01.01

IPX1

Tested to comply with IP (ingression protection) Rating



WEEE symbol for the recyclable product. Please do not throw the product with this symbol in the bin.



Consult instructions for use

EU Declaration of Conformity for Medical Applications

A Declaration of Conformity has been filed for this product. A sample of this document may be found in the addendum which accompanied this manual. For a copy of the Declaration of Conformity document, please contact ADVAN Int'l Corp. and request for AMM215WTTP DOC.

Cleaning Your Monitor

Turn off the product before cleaning. No specific liquid or chemical is necessary when cleaning this LCD monitor. However, it is suggested to use a soft cloth moistened with mild detergent to clean the display housing.

To clean the screen, do not spray liquid cleaners directly on to the unit. Spray cleaning solution onto a cloth, and without applying excessive pressure, clean the screen.

Caution: Do not use abrasive cleaners, waxes or solvents for your cleaning.

This monitor is intended for use in Health Care Facilities Model AMM215WTTP Equipment is not suitable for use in the presence of flammable anesthetic mixture with air or with oxygen or nitrous oxide.

No user serviceable parts inside, ask qualified personnel when accessing inside.

This product contains electrical waste or electronic equipment. It must not be disposed of as unsorted municipal waste and must be collected separately.

Electrical input rating: 12V DC 3A

Classification

Type of protection against electric shock: Class I Equipment.

Degree of protection against the ingress of water: IPX1 compliance.

Mode of operation: Continuous

This monitor has been tested to comply with IEC/EN 60601-1, IEC/EN60601-1-2 and is certified by UL to medical standard(UL/cUL Mark).

Because many medical offices are located in residential areas, this monitor, in addition to the medical requirements, has also been tested and found to comply with the limits for FCC Class B computing devices in a typically configured system. It is the system integrator or configurer's responsibility to test and ensure that the entire system complies with applicable EMC laws.

Environmental conditions for transport and storage:

- Temperature range within -4° to 140° F (-20° to 60°C)
- Relative humidity range within 10% to 90%
- Atmospheric pressure range within 500 to 1060 hPa.
- Operating within 0° to 40°C

Environmental conditions for operating:

- Operating temperature range within 32° to 104° F (0° to 40°C)

Electromagnetic Compatibility

Like other electrical medical equipment, the AMM215WTTP requires special precautions to ensure electromagnetic compatibility with other electrical medical devices. To ensure electromagnetic compatibility (EMC), the AMM215WTTP must be installed and operated according to the EMC information provided in this manual.

Note The AMM215WTTP has been designed and tested to comply with EN 60601-1-2 requirements for EMC with other devices.

Caution Portable and mobile RF communications equipment may affect the normal function of the AMM215WTTP.



Warning Do not use cables or accessories other than those provided with the AMM215WTTP, as this may result in increased electromagnetic emissions or decreased immunity to such emissions.



Warning If the AMM215WTTP is used adjacent to or stacked with other equipment, observe and verify normal operation of the AMM215WTTP in the configuration in which it will be used prior to using it in a surgical procedure. Consult the tables below for guidance in placing the AMM215WTTP.

Manufacturer's Declaration - Electromagnetic Emission

The Model AMM215WTTP is intended for use in the electromagnetic environment specified below. The user of AMM215WTTP should assure that it is used in such an environment.		
Emission test	Compliance	Electromagnetic Environment - Guidance
RF emissions CISPR 11	Group 1	The Model AMM215WTTP uses RF energy only for its internal function. Therefore, its RF emissions are very low and are not likely to cause any interference in nearby electronic equipment AMM215WTTP is suitable for use in all establishments, including domestic establishments and those directly connected to the public low-voltage power supply network that supplies buildings used for domestic purposes
RF emissions CISPR 11	Class B	
Harmonic emissions IEC61000-3-2	Class D	
Voltage Fluctuations IEC61000-3-3	Complies	

Manufacturer's Declaration - Electromagnetic Immunity

The Model AMM215WTTP is intended for use in the electromagnetic environment specified below. The user of AMM215WTTP should assure that it is used in such an environment.			
Immunity Test	IEC 60601 Test Level	Compliance Level	Electromagnetic Environment - Guidance
Electrostatic discharge (ESD) IEC61000-4-2	6 kV contact 8 kV air	6 kV contact 8 kV air	Floors should be wood, concrete or ceramic tile. If floors are covered with synthetic material, the relative humidity should be at least 30%.
Electrical fast transient /burst IEC61000-4-4	2 kV for power supply lines 1 kV for input / output lines	2 kV for power supply lines 1 kV for input / output lines	Mains power quality should be that of a typical commercial or hospital environment
Surge IEC61000-4-5	1 kV differential mode 2 kV common mode	1 kV differential mode 2 kV common mode	Mains power quality should be that of a typical commercial or hospital environment.

Power frequency (50/60Hz) mag-netic field IEC 61000-4-8	3.0 A/m	3.0 A/m	Power frequency magnetic fields should be at levels characteristic of a typical location in a typical commercial or hospital environment.
Voltage dips, short interruptions and voltage variations on power supply input lines IEC 61000-4-11	<5% Ut (>95% dip in Ut) for 0.5 cycle 40% Ut (60% dip in Ut) for 5 cycles 70% Ut (30% dip in Ut) for 25 cycles <5% Ut (>95% dip in Ut) for 5 sec.	<5% Ut (>95% dip in Ut) for 0.5 cycle 40% Ut (60% dip in Ut) for 5 cycles 70% Ut (30% dip in Ut) for 25 cycles <5% Ut (>95% dip in Ut) for 5 sec.	Mains power quality should be that of a typical commercial or hospital environment. If the user of the AMM215WTTP image intensifier requires continued operation during power mains interruptions, it is commended that the AMM215WTTP image intensifier be powered from an uninterruptible power supply or a battery.
Note: Ut is the A.C. mains voltage prior to application of the test level.			

Manufacturer's Declaration - Electromagnetic Immunity

The Model AMM215WTTP is intended for use in the electromagnetic environment specified below. The customer or the user of AMM215WTTP should ensure that it is used in such an environment.			
Immunity Test	IEC 60601 Test Level	Compliance Level	Electromagnetic Environment - Guidance
Conducted RF IEC 61000-4-6	3 Vrms 150 KHz to 80 MHz	3 Vrms 150 KHz to 80 MHz	Portable and mobile RF communications equipment should be used no closer to any part of the AMM215WTTP, including cables, than the recommended separation distance calculated from the equation applicable to the frequency of the transmitter. Recommended Separation Distance 0.15 MHz to 80 MHz $d = \left[\frac{3.5}{V_1} \right] \sqrt{P}$ 80 MHz to 800 MHz $d = \left[\frac{3.5}{E_1} \right] \sqrt{P}$ 800 MHz to 2.5 GHz $d = \left[\frac{7}{E_1} \right] \sqrt{P}$ where P is the maximum output power rating of the transmitter in watts (W) according to the transmitter manufacturer and is the recommended separation distance in meters (m). Field strengths from fixed RF transmitters, as determined by an electromagnetic site survey (a), should be less than the compliance level in each frequency range (b). Interference may occur in the vicinity of equipment marked with the following symbol: 
Radiated RF IEC 61000-4-3	3 Vrms 800 MHz to 2.5 GHz	3 Vrms 800 MHz to 2.5 GHz	
NOTE 1: At 80MHz and 800MHz, the higher frequency range applies.			
NOTE 2: These guidelines may not apply in all situations. Electromagnetic propagation is affected by absorption and reflection from structures, objects, and people.			
(a) Field strengths from fixed transmitters, such as base stations for radio (cellular/cordless) telephones and land mobile radios, amateur radio, AM and FM radio broadcast and TV broadcast, cannot be predicted theoretically with accuracy. To assess the electromagnetic environment due to fixed RF transmitters, an electromagnetic site survey should be considered. If the measured field strength in the location in which the AMM215WTTP is used exceeds the applicable RF compliance level above, the AMM215WTTP should be observed to verify normal operation. If abnormal performance is observed, additional measures may be necessary, such as reorienting or relocating the AMM215WTTP.			
(b) Over the frequency range 150kHz to 80MHz, field strengths should be less than [V1] V/m.			

Recommended Separation Distances Between Portable and Mobile RF Communications Equipment and the AMM215WTTP System			
The AMM215WTTP system is intended for use in an electromagnetic environment in which radiated RF disturbances are controlled. The user of the AMM215WTTP system can help prevent electromagnetic interference by maintaining a minimum distance between portable and mobile RF communications equipment (transmitters) and the AMM215WTTP system as recommended below, according to the maximum output power of the communications equipment.			
Rated maximum output power (W) of transmitter	Separation distance (m) according to frequency of transmitter		
	150kHz to 80MHz $d=1.17, \sqrt{P}$	80MHz to 800MHz $d=1.17, \sqrt{P}$	800MHz to 2.5GHz $d=2.33, \sqrt{P}$
0.01	0.12	0.12	0.23
0.1	0.37	0.37	0.74
1	1.17	1.17	2.33
10	3.70	3.70	7.37
100	11.70	11.70	23.30
For transmitters rated at a maximum output power not listed above, the recommended separation distance (d) in meters (m) can be estimated using the equation applicable to the frequency of the transmitter, where P is the maximum output power rating of the transmitter in watts (W) according to the transmitter manufacturer.			
NOTE 1: At 80 MHz and 800 MHz, the separation distance for the higher frequency range applies.			
NOTE 2: These guidelines may not apply in all situations. Electromagnetic propagation is affected by absorption and reflection from structures, objects, and people.			

Introduction

About AMM215WTTP Series

The AMM215WTTP Touch screen LCD Monitor displays information from imaging systems and devices.

Features include:

- Direct Analog signal input
- Direct Digital signal input
- Active matrix TFT LCD technology
- 1920 x 1080 resolution
- 21.5" viewable display area - 16:9 aspect ratio
- 31.47 ~ 82.3 KHz horizontal scan
- 56 ~ 75 Hz high refresh rate
- 0.24795mm x 0.24795mm pixel pitch
- Auto adjustment function
- Multilingual OSD user control
- 100 mm VESA mount
- Removable base for flexible mounting solutions.
- Touch screen with USB controller
- Audio output(optional)
- USB HUB 2.0(optional)

Touch Screen for AMM215WTTP

- Projected Capacitive touch screen for finger input only
- Surface: Glare treatment
- Interface: USB controller
- Transmittance: 90%±5%
- HID: Windows® 7
- Driver: VISTA, XP, 2000, CE, XP Embedded, Linux, Apple® Mac OS

Package Overview

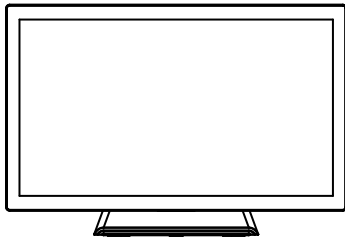

LCD Display

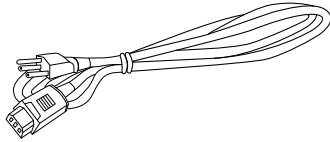

Power Cord

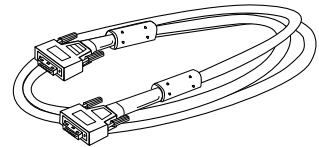

VGA Signal Cable

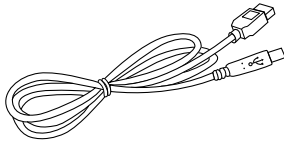

USB Cable (A to B)

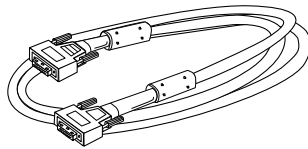

DVI-D Cable

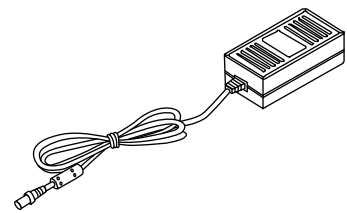

DC Power Supply

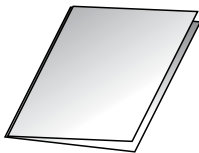

Quick Start Guide



Touch Driver CD

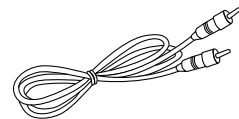

Audio Cable
(optional)

*Accessories might change depending on region.

Unpacking the Monitor

Before you unpack your monitor, prepare a suitable workspace. You need a stable and level surface near a grounded wall outlet in an area which is relatively free of glare from sunlight or other sources of bright light. The monitor is cooled by natural convection (it has no fan). For optimum performance, do not block the cooling vents.

While unpacking the monitor, inspect it and other package contents for shipping damage that could cause a fire or shock hazard. Immediately report any shipping damage to the carrier or transportation company or contact customer service for returns.

After you unpack the monitor, make sure the following items are included:

- Monitor with video cable
- AC adapter with cable
CAUTION: AC Adapter must be plugged into grounded a power outlet

CAUTION : AC adapter
Manufacturer: BridgePower Corp.
Model No: BPM050S12F09
INPUT: 100-240Vac, 50-60 Hz, 1.5A
OUTPUT: 12Vdc, 4.2A

- This operations manual

Note: Your system provider may offer alternative cords or cables depending on the installation requirement and local geography issues.

Installation

Product Overview

- Front View

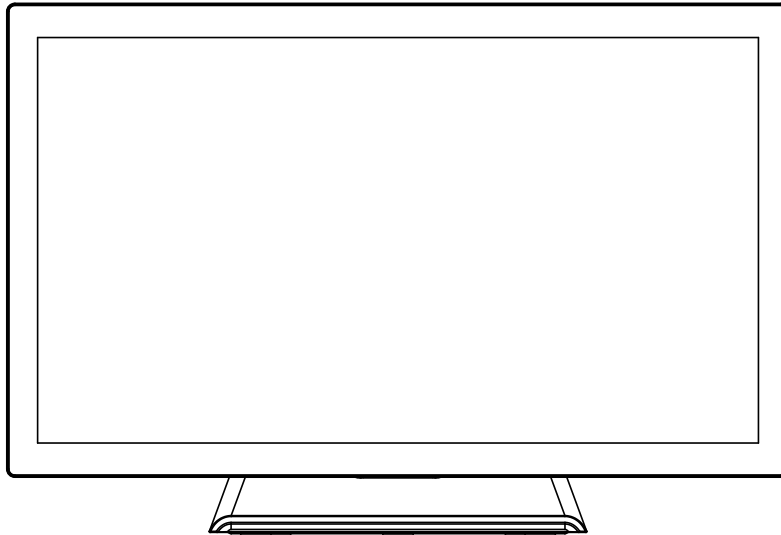

- Bottom View (Without Stand)

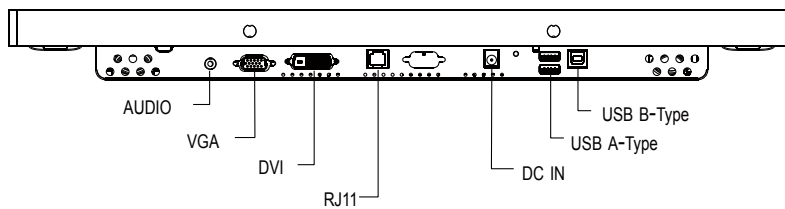

Flat Panel Mounting Physical Mounting Interface by VESA

This monitor conforms to the VESA Flat Panel Mounting Physical Mounting Interface standard which defines a physical mounting interface for flat panel monitors, and corresponding with the standards of flat panel monitor mounting devices, such as wall and table arms. The VESA mounting interface is located on the back of your monitor.

To mount the monitor on a UL certified swing arm or other mounting fixture, follow the instructions included with the mounting fixture to be used.

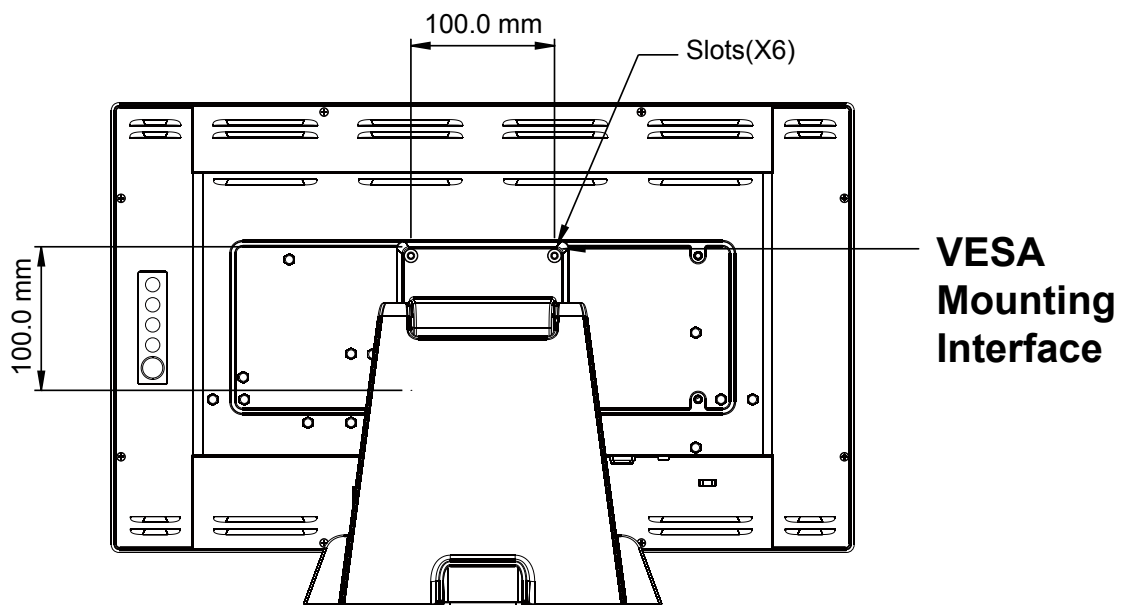

Warning

Please select the proper screws!

The distance between the back cover surface and the bottom of the screw hole is 8 mm. Please use four M4 screws diameter with proper length to mount your monitor. Please note: the mounting stand must be able to support at least 17.6 lbs (8Kg).

Start Your Installation

Please follow these instructions so that you can hook up the cables to associated connectors.

1. Lay the LCD flat on an even surface.
2. Move the stand into position as seen in the step 1 diagram.
3. Connect the cables to the appropriate connectors as seen in the step 2 diagram.

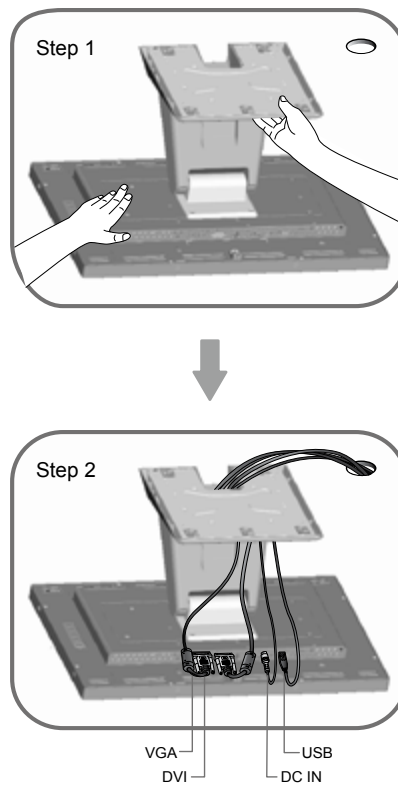

Connecting the Display

To setup this display, please refer to the following figure and procedures.

1. Be sure all equipment is turned off.
2. Connect the DC plug to the power connector on the monitor and the other end into an electrical outlet (8.1).
3. Connect the D-SUB or DVI cable from the display's D-SUB or DVI input connector to the D-SUB or DVI connector of your host computer and tighten the screws (8.1).
4. Connect the USB cable from the USB port of your display to the USB port (8.1) of your computer.
5. Configure the touch screen. Refer to the "Touch Screen Driver Installation" section on page 16.
6. Once the touch screen is configured, the monitor is ready for use.

Note:

Avoid placing the monitor against a bright background or where sunlight or other light sources may reflect on the area of the monitor. Place the monitor just below eye level.

To ensure the LCD display works well with your computer, please configure the display mode of your graphics card to make it less than or equal to 1920 x 1080 resolution and make sure the timing of the display mode is compatible with the LCD display.

We have listed the compatible "Video Modes" of your LCD display in the appendix (on page 24) for your reference.

External power supplies applicable: Bridgepower / BPM050S12F09

Recommendation to Use more than One Unit

As unforeseen situations can occasionally occur with the monitor, when the display is used please use a safety control. It is strongly recommended the user uses more than one unit or prepares a spare unit in case there is an emergency.

On Burn-in

Permanent burn-in may occur from the followings:

- Displaying color bar or static images repeatedly or for a long period of time.
- Using the unit repeatedly in a high temperature/ high humidity environment
- Displaying an image smaller than the monitor continuously.

Figure

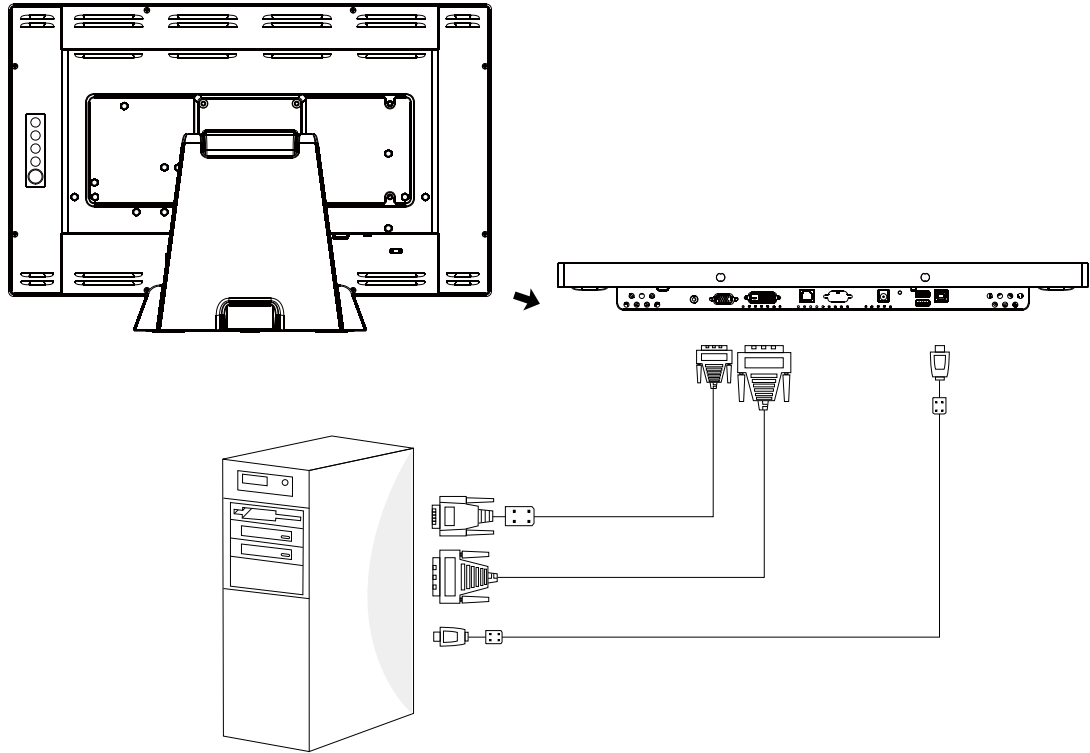



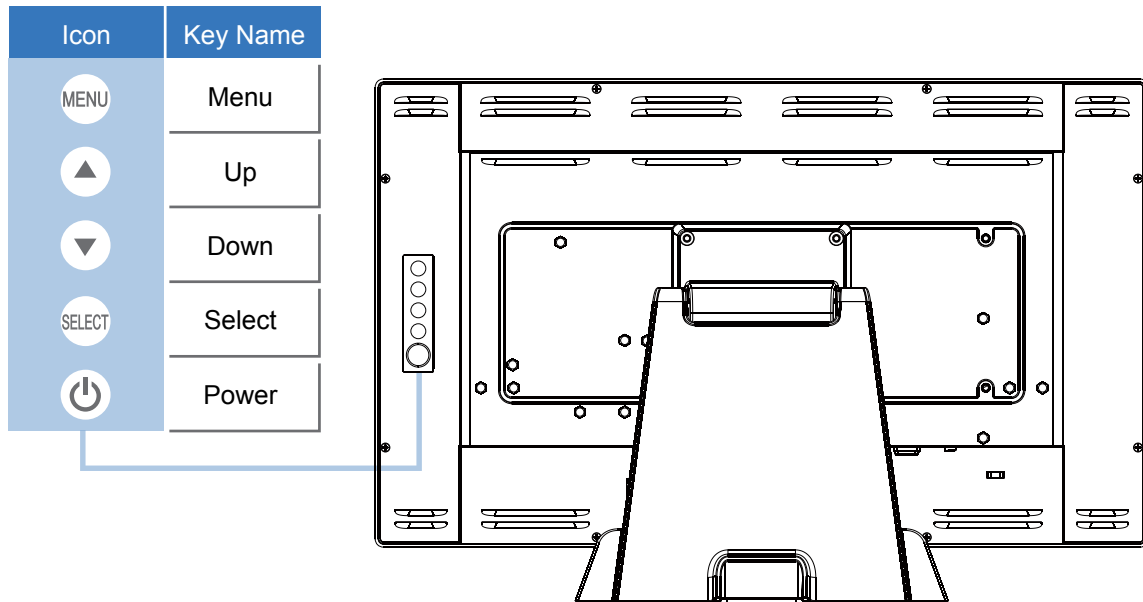

User Controls

Back Panel Controls



OSD Key	Menu off status	Menu on status
MENU	Menu appear	Menu disappear / return to main item
▲	Brightness	Main item select up / Adjust up
▼	Mute	Main item select down / Adjust down
SELECT	Select sub-item function	
⏻	Power On / Off	

How to Use the OSD Menu

Icon	Key Name
	Menu
	Up
	Down
	Select
	Power

1. Press the “Menu” button to pop up the “on-screen menu” and press “Up” or “Down” button to select among the five functions in the main menu.
2. Choose the adjustment items by pressing the “Select” button.
3. Adjust the value of the adjustment items by pressing the “Up” or “Down” button.
4. With the OSD menu on the screen, press the “Menu” button to return to the main menu or to exit OSD.
5. The OSD menu will automatically close, if you have left it idle for a pre-set time.
6. To Lock the OSD / Power menu buttons, please follow the instructions below.
(Please note: the monitor has to be turned ON with a valid signal pre-set)
 - (a.) Press the “Menu” key; the OSD menu will open.
 - (b.) Press and hold the “Menu” key again with the OSD menu on the screen; the OSD menu will disappear. Then press the “Power” key 1 time while the menu key is still being pressed. The “Lock/Unlock” menu will appear for 3 seconds.
 - (c.) Use the “Select” key to select OSD or Power setting then set at “Lock” by pushing the “UP” or “Down” button.
 - (d.) When the “UP” or “Down” button is released, the previous setting will be saved and exit the “Lock/Unlock” menu automatically.
7. To Unlock the OSD / Power menu buttons, please follow the instructions below.
(Please note: the monitor has to be turned ON with a valid signal pre-set)
 - (a.) Press and hold the “Menu” key then press the “Power” key simultaneously; the “Lock/Unlock” menu will appear for 3 seconds.
 - (b.) Use the “Select” key to select OSD or Power setting then set at “Unlock” by pushing the “UP” or “Down” button.
 - (c.) When the “Up” or “Down” button is released, the previous setting will be saved, and the “Lock/Unlock” menu will close automatically.

Please note:

- a. When the OSD Lock function is selected, this indicates that all the buttons except the “power” button are now disabled.
- b. When the Power Lock function is selected, the “Power” key is disabled. The user cannot turn off the monitor with the “Power” key.

On-Screen Display Menus

Main OSD Menu:

ITEM	CONTENT
Contrast	The monitor luminance level control.
Brightness	The monitor backlight level control.
Auto Adjust	Fine-tune the image to full screen automatically.
Left/Right	Moving screen image horizontal position to left or right.
Up/Down	Moving screen image vertical position to up or down.
Horizontal size	The screen image horizontal dot clock adjustment.
Fine	The screen image pixel phase adjustment.
OSD Left/Right	Moving OSD menu horizontal position to left or right.
OSD Up/Down	Moving OSD menu vertical position to up or down.
OSD Time out	OSD auto-disappear time selection.
OSD Language	OSD menu language selection. (English, French, Japanese, Deutsch, Spanish, Italian, Traditional Chinese and Simplified Chinese)
Factory Reset	Factory default value restored.
RGB	Color temperature selection. (9300K, 6500K, 5500K, 7500K, User)
Volume	Audio volume adjustment
Mute	Audio ON/OFF control

Appendix

Troubleshooting

If you are experiencing trouble with the LCD display, refer to the following. If the problem persists, please contact your local dealer or our service center.

Problem: No image appears on screen.

- ▶ Check that all the I/O and power connectors are correctly and well connected as described in the “Installation” section.
- ▶ Make sure the pins of the connectors are not crooked or broken.

Problem: Partial Image or incorrectly displayed image.

- ▶ Check to see if the resolution of your computer is higher than that of the LCD display.
- ▶ Reconfigure the resolution of your computer to make it less than or equal to 1920 x 1080.

Problem: Image has vertical flickering line bars.

- ▶ Use “Horizontal size” to make an adjustment.
- ▶ Check and reconfigure the display mode of the vertical refresh rate of your graphic card to make it compatible with the LCD display.

Problem: Image is unstable and flickering

- ▶ Use “Fine” to make an adjustment.

Problem: Image is scrolling

- ▶ Check and make sure the VGA signal cable (or adapter) is securely connected.
- ▶ Check and reconfigure the display mode of the vertical refresh rate of your graphics card to make it compatible with the LCD display.

Problem: Vague image (characters and graphics)

- ▶ Use “Horizontal size” to make an adjustment. If this problem still exists, use “Fine” to make an adjustment.

Warning Signal

If you see warning messages on your LCD screen, this means that the LCD display cannot receive a clean signal from the computer graphics card.

Below are the three kinds of Warning Signal. Please check the cable connections or contact your local dealer or our service center for more information.

No Signal

This message means that the LCD display has been powered on but it cannot receive any signal from the computer graphics card. Check all the power switches, power cables, and VGA/DVI signal cable.

Going to Sleep

The LCD display is under the power saving mode. In addition, the LCD display will enter power saving mode when experiencing a sudden signal disconnecting problem.

The monitor can be activated by pressing any keyboard, triggering the mouse or touching the screen.

Out of Range

This message means that the signal of the computer graphic card is not compatible with the LCD display. When the signal is not included in the "Video Modes" list we have listed in the Appendix of this manual, the LCD monitor will display this message.

Product Dimensions

► Front View

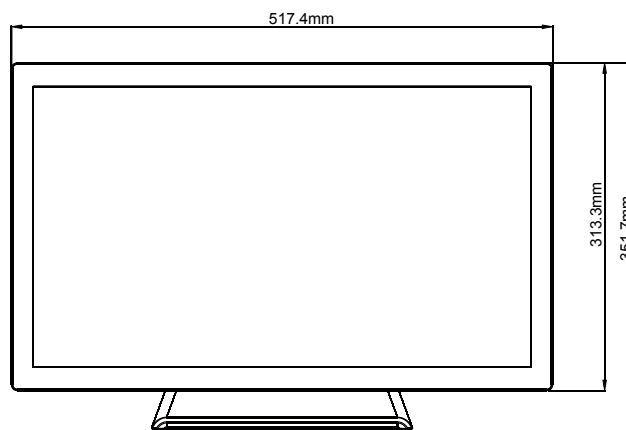

► Side View

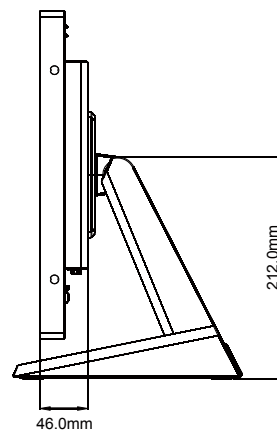

► Top View

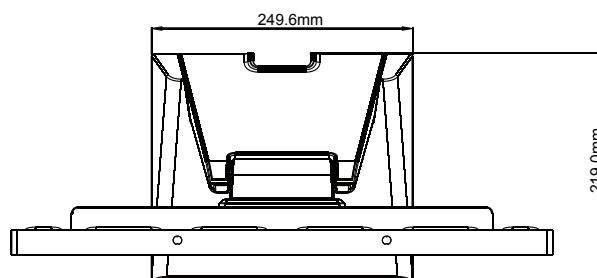

Compatibility Modes

Mode	Resolution	H-Frequency(khz)	V-Frequency(hz)
IBM VGA	720X400	31.47	70
IBM VGA	640X480	31.47	60
Apple MacII	640X480	35.00	66
VESA VGA	640X480	37.86	72
VESA VGA	640X480	37.50	75
VESA SVGA	800X600	35.16	56
VESA SVGA	800X600	37.88	60
VESA SVGA	800X600	48.08	72
VESA SVGA	800X600	46.88	75
Apple Mac	832X624	49.72	75
VESA XGA	1024X768	48.36	60
VESA XGA	1024X768	56.48	70
VESA XGA	1024X768	60.02	75
VESA SXGA	1280X1024	64.00	60
VESA SXGA	1280X1024	80.00	75
VESA SXGA	1152X864	67.50	75
VESA SXGA	1280X960	60.00	60
WXGA+	1440X900	56.00	60
WXGA+	1440X900	70.60	75
WSXGA+	1680X1050	65.20	60
WSXGA+	1680X1050 (VGA only)	82.30	75
VESA WXGA	1280X768	47.776	60
WSXGA+	1920X1080	67.50	60

Touch Screen Driver Installation

The AMM215WTTP is available with USB connections. The touch driver is located on the enclosed CD-ROM for these operating systems: VISTA, XP, 2000, CE, XP Embedded, Linux, Apple® Mac OS.

Please Note:

1. The AMM215WTTP is Microsoft® Windows® HID (Human Interface Device) compatible if you use the USB touch screen interface. No additional software driver is required for general operation of the touch screen.
2. For AMM215WTTP, the system requires 15 seconds for Windows 7 to install/uninstall the touch drivers while turning power on/off or plugging/unplugging USB cable.

AMM215WTTP Driver Install Instructions:

If you are using a PC running VISTA, XP, 2000, follow the instructions below:

1. Power on the PC.
2. Be sure the USB cable is connected from the PC to the LCD display.
3. Open the CD-ROM.
4. Follow the step-by-step instructions as shown on the pop-up windows.

If you are using a PC running Windows® XP Embedded, follow the instructions below:

Express:

1. Power on the computer.
2. Make sure that the USB cable is connected to the computer.
3. Be sure that your EWF is disabled. If your EWF is enabled, please disable the EWF by using the EWF Manager command.
4. Once the EWF is disabled click on the XP driver on the CD-ROM and follow the step-by-step instructions as shown on the pop-up windows.

Custom:

1. Power on the computer.
2. Make sure that the USB cable is connected to the computer.
3. Follow the step-by-step instructions found in the folder file on the CD-ROM.

If you are using a PC running Windows® CE, follow the instructions below:

1. Power on the computer.
2. Make sure that the USB cable is connected to the computer.
3. Using Platform Builder, build an image file by following the step-by-step instructions found in the folder file on the CD-ROM.

If you are using a PC running Linux or Apple® Mac OS, follow the instructions below:

1. Power on the computer.
2. Make sure that the USB cable is connected to the computer.
3. Follow the step-by-step instructions found in the folder file on the CD-ROM.

Description of Warranty

ADVAN warrants to the first Buyer (Buyer) that the product purchased when shipped in its original container will conform to ADVAN specifications, and to any ADVAN approved specifications furnished to ADVAN by the Buyer, and will be free of defects in materials and workmanship. ADVAN warrants that the product purchased is manufactured from new components which meet ADVAN's standards, quality and specifications.

Subject to the conditions and limitations set forth below, ADVAN will, at its option, either repair any component of its products that prove defective by reason of improper workmanship or materials or ADVAN has the exclusive right to replace with refurbished units or with an equivalent product. ADVAN warrants that the components used for repair, refurbished units or equivalent product will meet ADVAN standards, quality and specifications.

Commencement and Duration of Warranty

The product purchased will be warranted for a period of eighteen (18) months (excluding the LCD panel, touch screen, and the protection filter) from the date of shipment. LCD panels and touch screens are warranted for a period of twelve (12) months from the date of shipment.

Protection filters are not warranted as damage to the protection filter is considered to be normal wear and tear and can be replaced at the Buyer's cost.

Components used for repair, refurbished units or equivalent product will be warranted for a period of twelve (12) months from the date of repair.

Limitation of Warranty

This limited warranty does not cover any damage to this product or other non-ADVAN products that results from any of the following: improper installation or operation; accident; abuse; misuse; natural disaster; war; insufficient or excessive electrical supply; abnormal mechanical or environmental conditions; any unauthorized disassembly, repair or modification; normal wear and tear; tampering by anyone other than an ADVAN engineer or an ADVAN Authorized Service Center (ASC); the use of supplies, consumable items and conditions beyond the control of ADVAN, such as common carrier provided equipment and/or facilities; operation of ADVAN product in excess of the specifications. This limited warranty also does not apply to any product that has not been handled or packaged correctly, that has been sold as second-hand or has been resold contrary to the US export regulations, on which the original identification information (i.e. serial number, rating and/or warranty label) has been altered, obliterated or removed.

Return Material Authorization (RMA) Procedure

All claims must be submitted through the ADVAN website, whether in warranty or out, first Buyer, distributor or OEM. End Users who have purchased through a distributor or OEM, please contact the distributor or OEM.

<http://www.advancorprma.com>

Follow the instructions to receive an RMA number, shipping instructions and a shipping label to be placed on the outside of the shipping container. A serial number and a detailed reason for return are required.

In-transit damage is not covered by warranty. ADVAN will only pay for the return shipment by surface transportation.

Returns without an RMA number will not be accepted.

For product support, please e-mail details of your inquiry including product model: service@advancorp.com

In Warranty

ADVAN or its ASC will repair or replace if defective in material or workmanship without cost, for a period of eighteen (18) months, (LCD panels and touch screens for a period of twelve (12) months) after the date of shipment.

Buyer must notify ADVAN or its ASC of the defect before expiration of the warranty period, and request a RMA number. If the configuration has been modified in any manner, the product must be returned to its original configuration before any warranty service will be performed by ADVAN or its ASC. No goods are to be returned to ADVAN or its ASC without prior authorization. Buyer will be responsible for packaging (preferably original container) and shipping the defective goods to ADVAN or its ASC, shipping charges prepaid.

ADVAN or its ASC will return the in warranty product, at no cost to the buyer.

Out-of-Warranty

ADVAN or its ASC will repair or replace if defective in material or workmanship with fee, any product which the warranty period has expired (out-of-warranty).

Buyer must notify ADVAN or its ASC of the defect and request a RMA number. If the configuration has been modified in any manner, the product must be returned to its original configuration before any service will be performed by ADVAN or its ASC.

No goods are to be returned to ADVAN or its ASC without prior authorization. Buyer will be responsible for packaging (preferably original container) and shipping the defective goods to

ADVAN or its ASC, shipping charges prepaid.

ADVAN or its ASC will return the out-of-warranty product, at cost to the buyer.

Product End of Life (EOL)

In the event of a RMA of an EOL product(s), ADVAN will hold or store major components of its products for a period of five (5) years, after the EOL of its products. ADVAN shall continue to perform the service of its products as long as ADVAN holds or stores said components of the products, with reasonable charge.

The forgoing Warranty and Out-of-Warranty terms apply.



ADVAN Korea

#605, Kolon Science Valley 2-cha, 55, Digital-ro, 34-gil, Guro-gu, Seoul, 152-728
Korea

Tel : +82 2 783 5197

Fax : +82 2 868 0880

Web Page : <http://www.advancorp.com>

ADVAN INT'L CORP

47817 Fremont Blvd. Fremont, CA 94538, USA

Tel : 1 510 490 1005

Fax : 1 510 490 1151

Web Page : <http://www.advancorp.com>

ADVAN RoHS Compliance

