

FCC and ISED Test Report

Dyson Technology Limited
Air Purifying Headphones, Model: WP01

In accordance with FCC 47 CFR Part 15C, ISED
RSS-247 and ISED RSS-GEN
(2.4 GHz Bluetooth Low Energy)

Prepared for: Dyson Technology Limited
Tetbury Hill, Malmesbury
SN16 0RP, United Kingdom

FCC ID: QVHWP01001

IC: 7968A-WP01001



Add value.
Inspire trust.

COMMERCIAL-IN-CONFIDENCE

Document 75950381-04 Issue 02

SIGNATURE

NAME	JOB TITLE	RESPONSIBLE FOR	ISSUE DATE
Steve Marshall	Senior Engineer	Authorised Signatory	23 March 2023

Signatures in this approval box have checked this document in line with the requirements of TÜV SÜD document control rules.

ENGINEERING STATEMENT

The measurements shown in this report were made in accordance with the procedures described on test pages. All reported testing was carried out on a sample equipment to demonstrate limited compliance with FCC 47 CFR Part 15C, ISED RSS-247 and ISED RSS-GEN. The sample tested was found to comply with the requirements defined in the applied rules.

RESPONSIBLE FOR	NAME	DATE	SIGNATURE
Testing	Pier Lorusso	23 March 2023	
Testing	Thomas Biddlecombe	23 March 2023	

FCC Accreditation

90987 Octagon House, Fareham Test Laboratory

ISED Accreditation

12669A Octagon House, Fareham Test Laboratory

EXECUTIVE SUMMARY

A sample of this product was tested and found to be compliant with FCC 47 CFR Part 15C: 2020, ISED RSS-247: Issue 2 (02-2017) and ISED RSS-GEN: Issue 5 (04-2018) + A2 (02-2021) for the tests detailed in section 1.3.



DISCLAIMER AND COPYRIGHT

This non-binding report has been prepared by TÜV SÜD with all reasonable skill and care. The document is confidential to the potential Client and TÜV SÜD. No part of this document may be reproduced without the prior written approval of TÜV SÜD. © 2023 TÜV SÜD. This report relates only to the actual item/items tested.

ACCREDITATION

Our UKAS Accreditation does not cover opinions and interpretations and any expressed are outside the scope of our UKAS Accreditation. Results of tests not covered by our UKAS Accreditation Schedule are marked NUA (Not UKAS Accredited).

TÜV SÜD
is a trading name of TÜV SÜD Ltd
Registered in Scotland at East Kilbride,
Glasgow G75 0QF, United Kingdom
Registered number: SC215164

TÜV SÜD Ltd is a
TÜV SÜD Group Company

Phone: +44 (0) 1489 558100
Fax: +44 (0) 1489 558101
www.tuvsud.com/en

TÜV SÜD
Octagon House
Concorde Way
Fareham
Hampshire PO15 5RL
United Kingdom



Contents

1	Report Summary	2
1.1	Report Modification Record.....	2
1.2	Introduction.....	2
1.3	Brief Summary of Results	3
1.4	Application Form	4
1.5	Product Information	7
1.6	Deviations from the Standard.....	7
1.7	EUT Modification Record	7
1.8	Test Location	8
2	Test Details	9
2.1	Restricted Band Edges.....	9
2.2	Emission Bandwidth	13
2.3	Maximum Conducted Output Power	19
2.4	Authorised Band Edges	23
2.5	Spurious Radiated Emissions	27
2.6	Power Spectral Density	60
3	Photographs	64
3.1	Test Setup Photographs	64
4	Measurement Uncertainty	66



1 Report Summary

1.1 Report Modification Record

Alterations and additions to this report will be issued to the holders of each copy in the form of a complete document.

Issue	Description of Change	Date of Issue
1	First Issue	13-January-2023
2	Amended application form Conducted Power and Temperature Ranges	23-March-2023

Table 1

1.2 Introduction

Applicant	Dyson Technology Limited
Manufacturer	Dyson Technology Limited
Model Number(s)	WP01
Serial Number(s)	F40E11710006, F40E11710004, M8C-CN-FDN0393X, M8D-CN-FDN00012X and M8D-CN-FDN00014X
Hardware Version(s)	OR1
Software Version(s)	10.3
Number of Samples Tested	5
Test Specification/Issue/Date	FCC 47 CFR Part 15C: 2020 ISED RSS-247: Issue 2 (02-2017) ISED RSS-GEN: Issue 5 (04-2018) + A2 (02-2021)
Order Number	6000091736
Date	06-November-2020
Date of Receipt of EUT	20-January-2022 and 26-August-2022
Start of Test	25-January-2022
Finish of Test	05-October-2022
Name of Engineer(s)	Pier Lorusso and Thomas Biddlecombe
Related Document(s)	ANSI C63.10 (2020) ANSI C63.10 (2013)



1.3 Brief Summary of Results

A brief summary of the tests carried out in accordance with FCC 47 CFR Part 15C, ISED RSS-247 and ISED RSS-GEN is shown below.

Section	Specification Clause			Test Description	Result	Comments/Base Standard
	Part 15C	RSS-247	RSS-GEN			
Configuration and Mode: 2.4 GHz Bluetooth Low Energy - Right Cup						
-	15.203	-	-	Antenna Requirement	N/T	The device complies with the provisions of this section, as it uses permanently attached integral antennas.
2.1	15.205	3.3	8.10	Restricted Band Edges	Pass	
2.2	15.247 (a)(2)	5.2	6.7	Emission Bandwidth	Pass	
2.3	15.247 (b)	5.4	6.12	Maximum Conducted Output Power	Pass	
2.4	15.247 (d)	5.5	-	Authorised Band Edges	Pass	
2.5	15.247 (d) and 15.209	3.3 and 5.5	6.13 and 8.9	Spurious Radiated Emissions	Pass	
2.6	15.247 (e)	5.2	6.12	Power Spectral Density	Pass	
Configuration and Mode: 2.4 GHz Bluetooth Low Energy - Left Cup						
2.3	15.247 (b)	5.4	6.12	Maximum Conducted Output Power	Pass	
2.5	15.247 (d) and 15.209	3.3 and 5.5	6.13 and 8.9	Spurious Radiated Emissions	Pass	
2.6	15.247 (e)	5.2	6.12	Power Spectral Density	Pass	

Table 2



1.4 Application Form

Equipment Description

Technical Description: <i>(Please provide a brief description of the intended use of the equipment including the technologies the product supports)</i>	The EUT is an Air Purifying Headphone with Bluetooth BR/EDR and Bluetooth Low Energy technologies	
Manufacturer:	Dyson Technology Limited	
Model:	WP01	
Part Number:	WP01	
Hardware Version:	OR1	
Software Version:	10.3	
FCC ID of the product under test – see guidance here	QVHWP01001	
IC ID of the product under test – see guidance here	7968A-WP01001	

Table 3

Intentional Radiators

Technology	Bluetooth (BR+EDR)	Bluetooth Low Energy				
Frequency Range (MHz to MHz)	2400-2483.5	2400-2483.5				
Conducted Declared Output Power (dBm)	11.5	7.70				
Antenna Gain (dBi)	2.25	2.25				
Supported Bandwidth(s) (MHz) (e.g. 1 MHz, 20 MHz, 40 MHz)	1	1, 2				
Modulation Scheme(s) (e.g. GFSK, QPSK etc)	GFSK, $\pi/4$ DQPSK, 8-DPSK	GFSK				
ITU Emission Designator (see guidance here) (not mandatory for Part 15 devices)	1M00GXW	1M00GXW, 2M00GXW				
Bottom Frequency (MHz)	2402	2402				
Middle Frequency (MHz)	2441	2440				
Top Frequency (MHz)	2480	2480				

Table 4

Un-intentional Radiators

Highest frequency generated or used in the device or on which the device operates or tunes	2483.5
Lowest frequency generated or used in the device or on which the device operates or tunes	2400
Class A Digital Device (Use in commercial, industrial or business environment) <input type="checkbox"/>	
Class B Digital Device (Use in residential environment only) <input checked="" type="checkbox"/>	

Table 5



Battery Power Source

Voltage:	3.85	V
End-point voltage:	4.4	V (Point at which the battery will terminate)
Alkaline <input type="checkbox"/> Leclanche <input type="checkbox"/> Lithium <input checked="" type="checkbox"/> Nickel Cadmium <input type="checkbox"/> Lead Acid* <input type="checkbox"/> *(Vehicle regulated)		
Other <input type="checkbox"/>	Please detail:	

Table 6

Charging

Can the EUT transmit whilst being charged	Yes <input checked="" type="checkbox"/> No <input type="checkbox"/>
---	---

Table 7

Temperature

Minimum temperature:	-10	°C
Maximum temperature:	40	°C

Table 8

Cable Loss

Adapter Cable Loss (Conducted sample)	0.6	dB
---------------------------------------	-----	----

Table 9



Antenna Characteristics

Antenna connector <input type="checkbox"/>		State impedance		Ohm
Temporary antenna connector <input type="checkbox"/>		State impedance		Ohm
Integral antenna <input checked="" type="checkbox"/>	Type:		Gain	2.25 dBi
External antenna <input type="checkbox"/>	Type:		Gain	dBi
For external antenna only: Standard Antenna Jack <input type="checkbox"/> If yes, describe how user is prohibited from changing antenna (if not professional installed): Equipment is only ever professionally installed <input type="checkbox"/> Non-standard Antenna Jack <input type="checkbox"/>				

Table 10

Ancillaries (if applicable)

Manufacturer:		Part Number:	
Model:		Country of Origin:	

Table 11

The above information was provided by the applicant.



1.5 Product Information

1.5.1 Technical Description

The EUT is an Air Purifying Headphone with Bluetooth BR/EDR and Bluetooth Low Energy technologies.

1.6 Deviations from the Standard

No deviations from the applicable test standard were made during testing.

1.7 EUT Modification Record

The table below details modifications made to the EUT during the test programme.

The modifications incorporated during each test are recorded on the appropriate test pages.

Modification State	Description of Modification still fitted to EUT	Modification Fitted By	Date Modification Fitted
Model: WP01, Serial Number: F40E11710006			
0	As supplied by the customer	Not Applicable	Not Applicable
Model: WP01, Serial Number: F40E11710004			
0	As supplied by the customer	Not Applicable	Not Applicable
Model: WP01, Serial Number: M8C-CN-FDN0393X			
0	As supplied by the customer	Not Applicable	Not Applicable
Model: WP01, Serial Number: M8D-CN-FDN00012X			
0	As supplied by the customer	Not Applicable	Not Applicable
Model: WP01, Serial Number: M8D-CN-FDN00014X			
0	As supplied by the customer	Not Applicable	Not Applicable

Table 12



1.8 Test Location

TÜV SÜD conducted the following tests at our Octagon House Test Laboratory.

Test Name	Name of Engineer(s)	Accreditation
Configuration and Mode: 2.4 GHz Bluetooth Low Energy - Right Cup		
Restricted Band Edges	Pier Lorusso	UKAS
Emission Bandwidth	Thomas Biddlecombe	UKAS
Maximum Conducted Output Power	Thomas Biddlecombe	UKAS
Spurious Radiated Emissions	Pier Lorusso	UKAS
Authorised Band Edges	Pier Lorusso	UKAS
Power Spectral Density	Thomas Biddlecombe	UKAS
Configuration and Mode: 2.4 GHz Bluetooth Low Energy - Left Cup		
Maximum Conducted Output Power	Thomas Biddlecombe	UKAS
Spurious Radiated Emissions	Pier Lorusso	UKAS
Power Spectral Density	Thomas Biddlecombe	UKAS

Table 13

Office Address:

TÜV SÜD
Octagon House
Concorde Way
Fareham
Hampshire
PO15 5RL
United Kingdom



2 Test Details

2.1 Restricted Band Edges

2.1.1 Specification Reference

FCC 47 CFR Part 15C, Clause 15.205
ISED RSS-247, Clause 3.3
ISED RSS-GEN, Clause 8.10

2.1.2 Equipment Under Test and Modification State

WP01, S/N: M8C-CN-FDN0393X - Modification State 0

2.1.3 Date of Test

05-October-2022

2.1.4 Test Method

This test was performed in accordance with ANSI C63.10, clause 6.10.5 and 11.12.1.

Plots for average measurements were taken in accordance with ANSI C63.10, clause 11.12.2.5.2.

The following conversion can be applied to convert from dB μ V/m to μ V/m:

$10^{(\text{Field Strength in dB}\mu\text{V/m}/20)}$.

2.1.5 Environmental Conditions

Ambient Temperature	22.9 °C
Relative Humidity	53.5 %



2.1.6 Test Results

2.4 GHz Bluetooth Low Energy - Right Cup

Modulation	Frequency (MHz)	Band Edge Frequency (MHz)	Peak Level (dBµV/m)	Average Level (dBµV/m)
GFSK	2402	2390	48.96	36.24
GFSK	2480	2483.5	51.29	37.33

Table 14

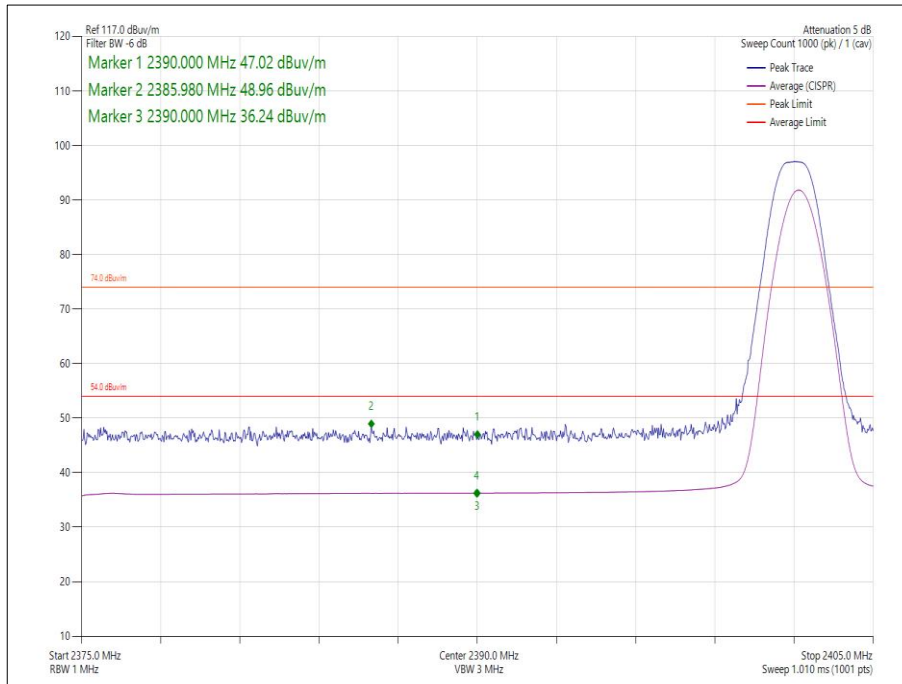

Figure 1 - GFSK - 2402 MHz - Band Edge Frequency 2390 MHz

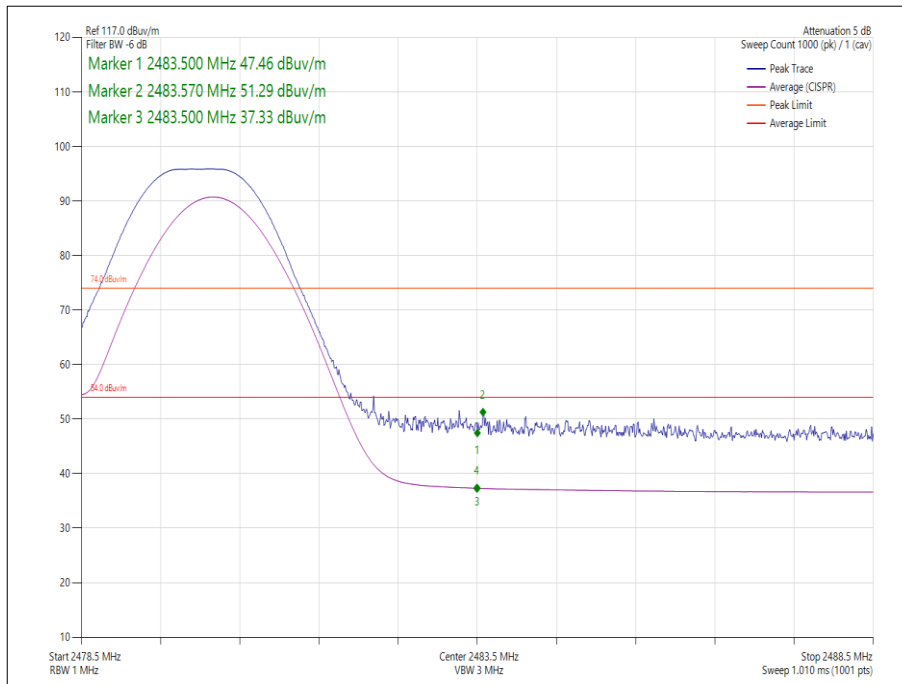

Figure 2 - GFSK - 2480 MHz - Band Edge Frequency 2483.5 MHz

FCC 47 CFR Part 15, Limit Clause 15.209

Frequency (MHz)	Field Strength ($\mu\text{V}/\text{m}$ at 3 m)
30 to 88	100
88 to 216	150
216 to 960	200
Above 960	500

Table 15

ISED RSS-GEN, Limit Clause 8.9

Frequency (MHz)	Field Strength ($\mu\text{V}/\text{m}$ at 3 m)
30 to 88	100
88 to 216	150
216 to 960	200
Above 960*	500

Table 16

*Unless otherwise specified, for all frequencies greater than 1 GHz, the radiated emission limits for licence-exempt radio apparatus stated in applicable RSSs (including RSS-Gen) are based on measurements using a linear average detector function having a minimum resolution bandwidth of 1 MHz. If an average limit is specified for the EUT, then the peak emission shall also be measured with instrumentation properly adjusted for such factors as pulse desensitization to ensure the peak emission is less than 20 dB above the average limit.



2.1.7 Test Location and Test Equipment Used

This test was carried out in RF Chamber 11.

Instrument	Manufacturer	Type No	TE No	Calibration Period (months)	Calibration Expires
EMI Test Receiver	Rohde & Schwarz	ESW44	5084	12	17-May-2023
Emissions Software	TUV SUD	EmX V3.1.4	5125	-	Software
Screened Room (11)	Rainford	Rainford	5136	36	24-Nov-2024
Mast	Maturo	TAM 4.0-P	5158	-	TU
Mast and Turntable Controller	Maturo	Maturo NCD	5159	-	TU
Turntable	Maturo	TT 15WF	5160	-	TU
Antenna (DRG 1-10.5GHz)	Schwarzbeck	BBHA9120B	5215	12	28-May-2023
Thermo-Hygro-Barometer	PCE Instruments	OCE-THB-40	5470	12	07-Apr-2023
2m SMA Cable	Junkosha	MWX221-02000AMSAMS/A	5518	12	12-Apr-2023
8m N Type Cable	Junkosha	MWX221-08000NMSNMS/B	5522	12	24-Mar-2023

Table 17

TU - Traceability Unscheduled



2.2 Emission Bandwidth

2.2.1 Specification Reference

FCC 47 CFR Part 15C, Clause 15.247 (a)(2)
ISED RSS-247, Clause 5.2
ISED RSS-GEN, Clause 6.7

2.2.2 Equipment Under Test and Modification State

WP01, S/N: F40E11710006 - Modification State 0

2.2.3 Date of Test

25-January-2022

2.2.4 Test Method

This test was performed in accordance with ANSI C63.10, clause 11.8.1 for 6 dB BW and 6.9.3 for 99% occupied bandwidth measurements.

2.2.5 Environmental Conditions

Ambient Temperature	21.5 °C
Relative Humidity	27.1 %



2.2.6 Test Results

2.4 GHz Bluetooth Low Energy - Right Cup

Test Configuration			
Frequency Range:	2400-2483.5 MHz	Band:	2.4 GHz
Limit Clause(s):	15.247 (a)(2) RSS-247 5.2 a)	Test Method(s):	C63.10 6.9.3 C63.10 11.8.1
Additional Reference(s):	-		

DUT Configuration			
Mode:	BT GFSK (LE 1M)	Duty Cycle (%):	-
Antenna Configuration:	SISO	DCCF (dB):	-
Active Port(s):	A (R Cup)	Peak Antenna Gain (dBi):	-

Test Frequency (MHz)	6 dB Bandwidth (MHz)					Limit (kHz)
	A	B	C	D	Minimum	
2402	0.692	-	-	-	0.692	≥500.0
2440	0.696	-	-	-	0.696	≥500.0
2480	0.708	-	-	-	0.708	≥500.0

Table 18 - 6 dB Bandwidth Results

Test Frequency (MHz)	99% Bandwidth (MHz)					Limit (kHz)
	A	B	C	D	Minimum	
2402	1.020	-	-	-	1.020	-
2440	1.020	-	-	-	1.020	-
2480	1.020	-	-	-	1.020	-

Table 19 - 99% Bandwidth Results

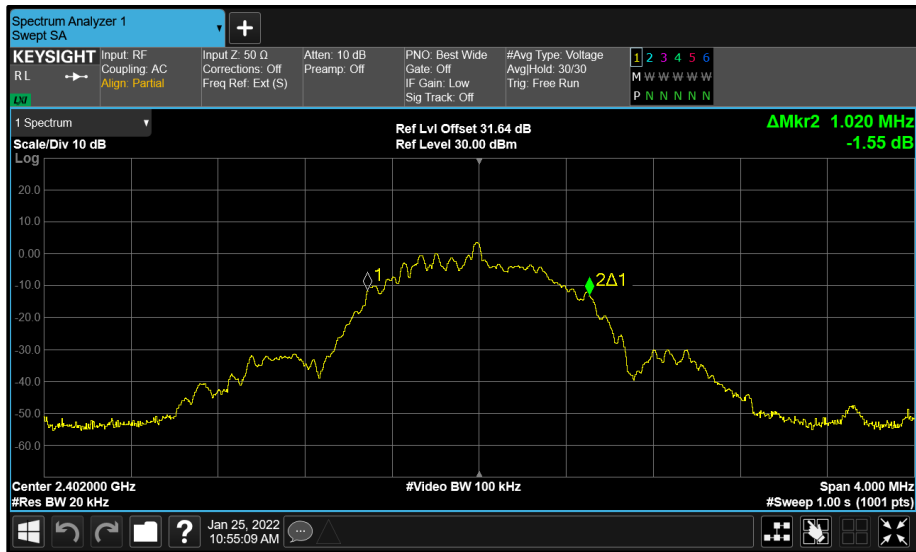

Figure 3 - R Cup (A) 2402 MHz (CH37) 99% Bandwidth

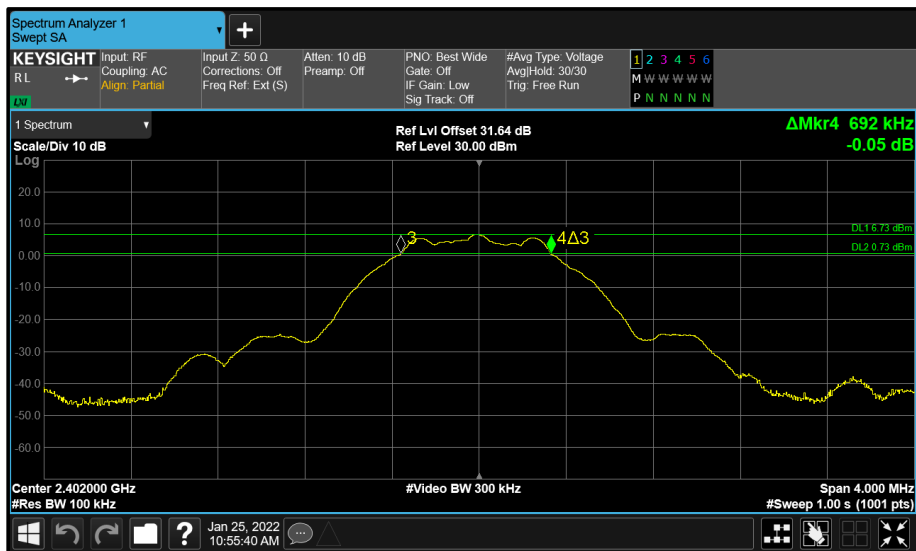

Figure 4 - R Cup (A) 2402 MHz (CH37) 6 dB Bandwidth

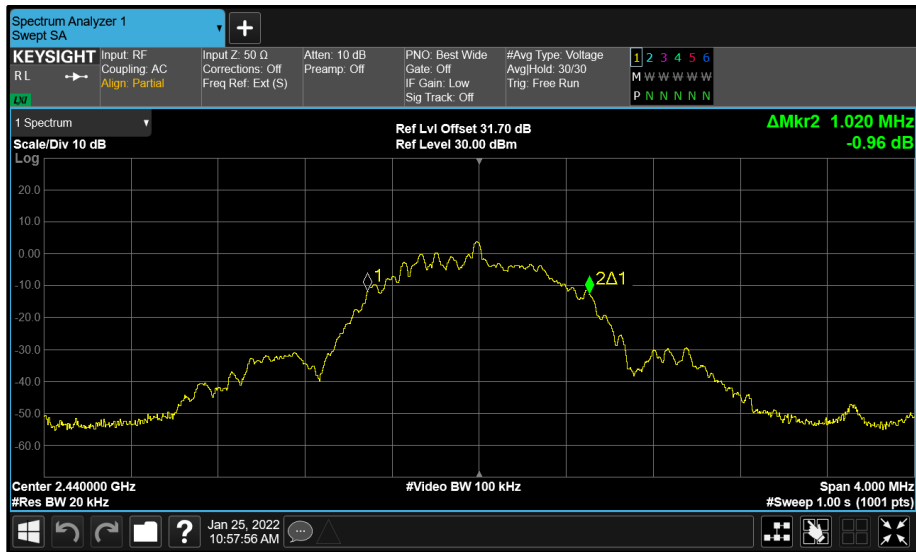

Figure 5 - R Cup (A) 2440 MHz (CH17) 99% Bandwidth

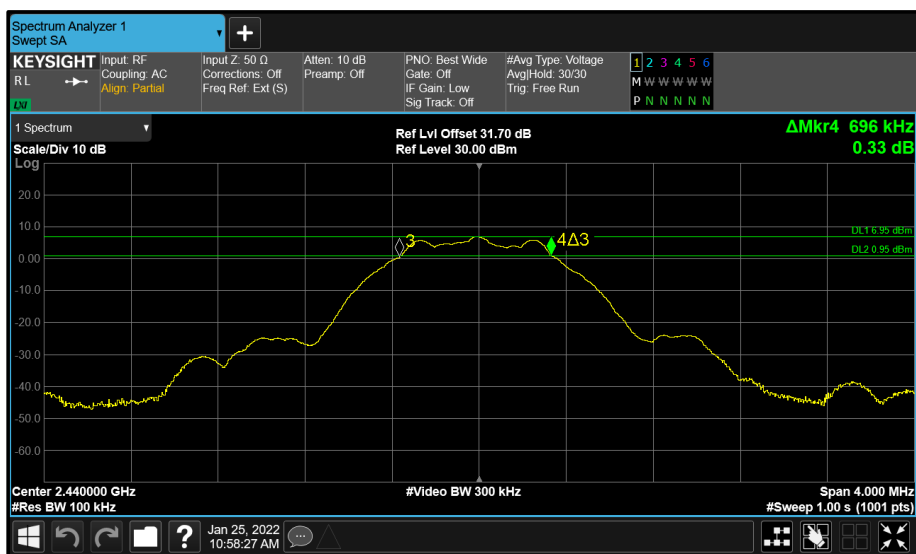

Figure 6 - R Cup (A) 2440 MHz (CH17) 6 dB Bandwidth

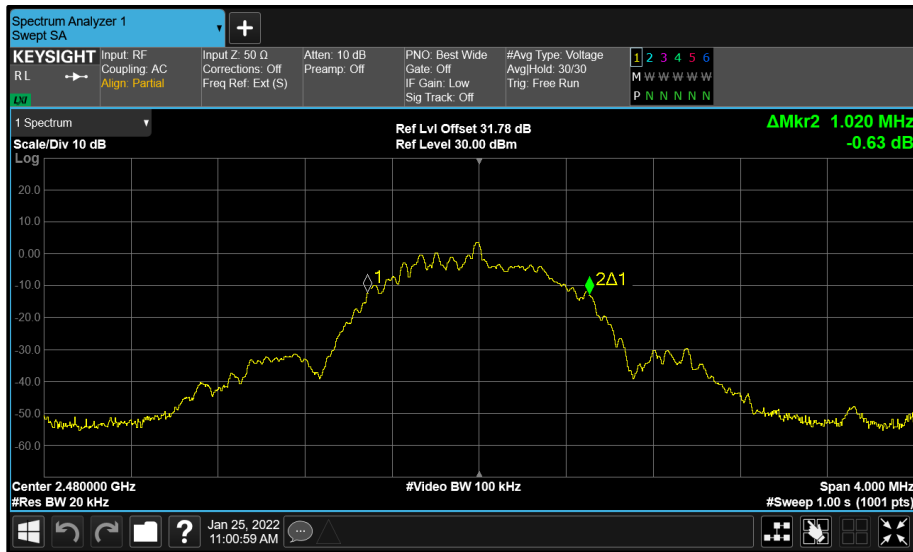

Figure 7 - R Cup (A) 2480 MHz (CH39) 99% Bandwidth

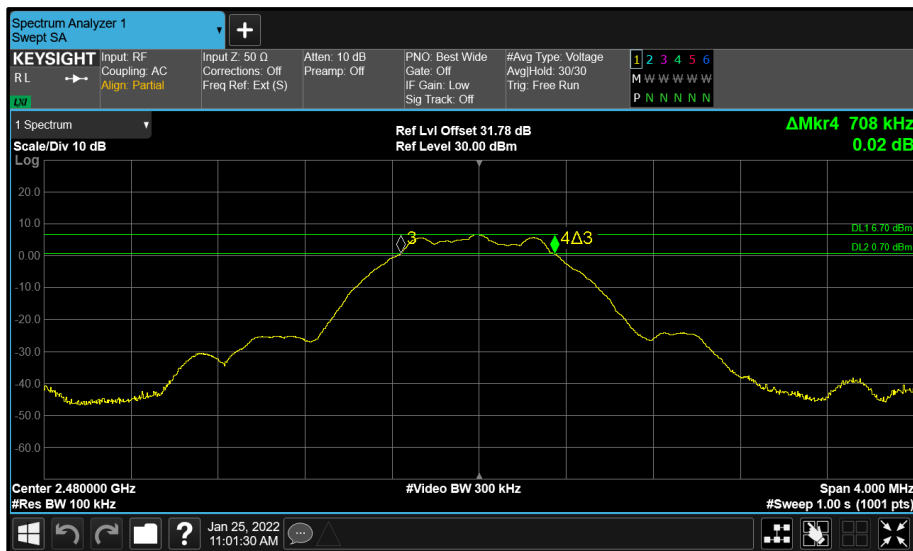

Figure 8 - R Cup (A) 2480 MHz (CH39) 6 dB Bandwidth

FCC 47 CFR Part 15, Limit Clause 15.247(a)(2) and ISED RSS-247, Clause 5.2(a)

The minimum 6 dB Bandwidth shall be at least 500 kHz.



2.2.7 Test Location and Test Equipment Used

This test was carried out in RF Laboratory 1.

Instrument	Manufacturer	Type No	TE No	Calibration Period (months)	Calibration Expires
Hygrometer	Rotronic	I-1000	3220	12	05-Nov-2022
Frequency Standard	Spectracom	SecureSync 1200-0408-0601	4393	6	01-Feb-2023
MXA Signal Analyser	Keysight Technologies	N9020B	5528	24	21-Mar-2024
Signal Conditioning Unit	TUV SUD	SPECTRUM SCU001	5546	12	06-Apr-2023

Table 20



2.3 Maximum Conducted Output Power

2.3.1 Specification Reference

FCC 47 CFR Part 15C, Clause 15.247 (b)
ISED RSS-247, Clause 5.4
ISED RSS-GEN, Clause 6.12

2.3.2 Equipment Under Test and Modification State

WP01, S/N: F40E11710006 - Modification State 0
WP01, S/N: F40E11710004 - Modification State 0

2.3.3 Date of Test

25-January-2022

2.3.4 Test Method

The test was performed in accordance with ANSI C63.10 2013, clause 11.9.1.3 Method PKPM1 for FCC testing and ANSI C63.10 2020, clause 11.9.1.2 PKPM1 for ISED testing.

2.3.5 Environmental Conditions

Ambient Temperature	21.5 °C
Relative Humidity	27.1 %



2.3.6 Test Results

2.4 GHz Bluetooth Low Energy - Right Cup

Test Configuration			
Frequency Range:	2400-2483.5 MHz	Band:	2.4 GHz
Limit Clause(s):	15.247 (b)(3) RSS-247 5.4 d)	Test Method(s):	C63.10 11.9.1.3
Additional Reference(s):	-		

DUT Configuration			
Mode:	BT GFSK (LE 1M)	Duty Cycle (%):	66.5
Antenna Configuration:	SISO	DCCF (dB):	-
Active Port(s):	A (R Cup)	Peak Antenna Gain (dBi):	2.25

Test Frequency (MHz)	Maximum Conducted Output Power (dBm)					Limit (dBm)	Margin (dB)
	A	B	C	D	Σ		
2402	7.07	-	-	-	-	30.00	-22.93
2440	7.26	-	-	-	-	30.00	-22.74
2480	7.03	-	-	-	-	30.00	-22.97

Table 21 - FCC Maximum Conducted (peak) Output Power Results

Test Frequency (MHz)	Maximum Conducted Output Power (dBm)					Limit (dBm)	Margin (dB)	EIRP (dBm)	EIRP Limit (dBm)	EIRP Margin (dB)
	A	B	C	D	Σ					
2402	7.07	-	-	-	-	30.00	-22.93	9.32	36.00	-26.68
2440	7.26	-	-	-	-	30.00	-22.74	9.51	36.00	-26.49
2480	7.03	-	-	-	-	30.00	-22.97	9.28	36.00	-26.72

Table 22 - ISED Maximum Conducted (peak) Output Power Results

FCC 47 CFR Part 15, Limit Clause 15.247 (b)(3)

For systems using digital modulation in the 902–928 MHz, 2400–2483.5 MHz, and 5725–5850 MHz bands: 1 Watt.

ISED RSS-247, Limit Clause 5.4 (b)

For DTSSs employing digital modulation techniques operating in the bands 902-928 MHz and 2400-2483.5 MHz, the maximum peak conducted output power shall not exceed 1 W. The e.i.r.p. shall not exceed 4 W, except as provided in section 5.4(e) of the specification.



2.4 GHz Bluetooth Low Energy - Left Cup

Test Configuration			
Frequency Range:	2400-2483.5 MHz	Band:	2.4 GHz
Limit Clause(s):	15.247 (b)(3) RSS-247 5.4 d)	Test Method(s):	C63.10 11.9.1.3
Additional Reference(s):	-		

DUT Configuration			
Mode:	BT GFSK (LE 1M)	Duty Cycle (%):	66.5
Antenna Configuration:	SISO	DCCF (dB):	-
Active Port(s):	B (L Cup)	Peak Antenna Gain (dBi):	2.25

Test Frequency (MHz)	Maximum Conducted Output Power (dBm)					Limit (dBm)	Margin (dB)
	A	B	C	D	Σ		
2402	-	7.17	-	-	-	30.00	-22.83
2440	-	7.45	-	-	-	30.00	-22.55
2480	-	7.65	-	-	-	30.00	-22.35

Table 23 - FCC Maximum Conducted (peak) Output Power Results

Test Frequency (MHz)	Maximum Conducted Output Power (dBm)					Limit (dBm)	Margin (dB)	EIRP (dBm)	EIRP Limit (dBm)	EIRP Margin (dB)
	A	B	C	D	Σ					
2402	-	7.17	-	-	-	30.00	-22.83	9.42	36.00	-26.58
2440	-	7.45	-	-	-	30.00	-22.55	9.70	36.00	-26.30
2480	-	7.65	-	-	-	30.00	-22.35	9.90	36.00	-26.10

Table 24 - ISED Maximum Conducted (peak) Output Power Results

FCC 47 CFR Part 15, Limit Clause 15.247 (b)(3)

For systems using digital modulation in the 902–928 MHz, 2400–2483.5 MHz, and 5725–5850 MHz bands: 1 Watt.

ISED RSS-247, Limit Clause 5.4 (d)

For DTSs employing digital modulation techniques operating in the bands 902-928 MHz and 2400-2483.5 MHz, the maximum peak conducted output power shall not exceed 1 W. The e.i.r.p. shall not exceed 4 W, except as provided in section 5.4(e) of the specification.



2.3.7 Test Location and Test Equipment Used

This test was carried out in RF Laboratory 1.

Instrument	Manufacturer	Type No	TE No	Calibration Period (months)	Calibration Expires
Hygrometer	Rotronic	I-1000	3220	12	05-Nov-2022
USB Power Sensor	Boonton	RTP5006	5184	12	19-Apr-2022
USB Power Sensor	Boonton	RTP5006	5187	12	19-Apr-2022
Signal Conditioning Unit	TUV SUD	SPECTRUM SCU001	5546	12	16-Apr-2022

Table 25

O/P Mon – Output Monitored using calibrated equipment



2.4 Authorised Band Edges

2.4.1 Specification Reference

FCC 47 CFR Part 15C, Clause 15.247 (d)
ISED RSS-247, Clause 5.5

2.4.2 Equipment Under Test and Modification State

WP01, S/N: M8D-CN-FDN00014X - Modification State 0

2.4.3 Date of Test

05-October-2022

2.4.4 Test Method

The test was performed in accordance with ANSI C63.10, clause 6.10.4.

2.4.5 Environmental Conditions

Ambient Temperature	22.9 °C
Relative Humidity	53.5 %



2.4.6 Test Results

2.4 GHz Bluetooth Low Energy - Right Cup

Modulation	Frequency (MHz)	Band Edge Frequency (MHz)	Level (dBc)
GFSK	2402	2400	-52.58
GFSK	2480	2483.5	-56.51

Table 26

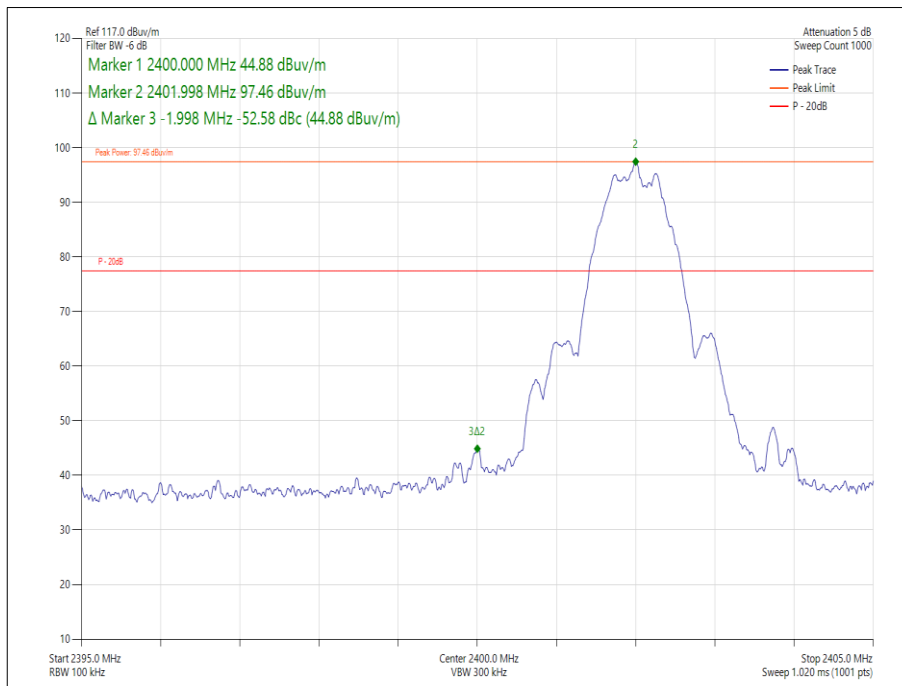

Figure 9 - GFSK, 2402 MHz - Measured Frequency 2400 MHz

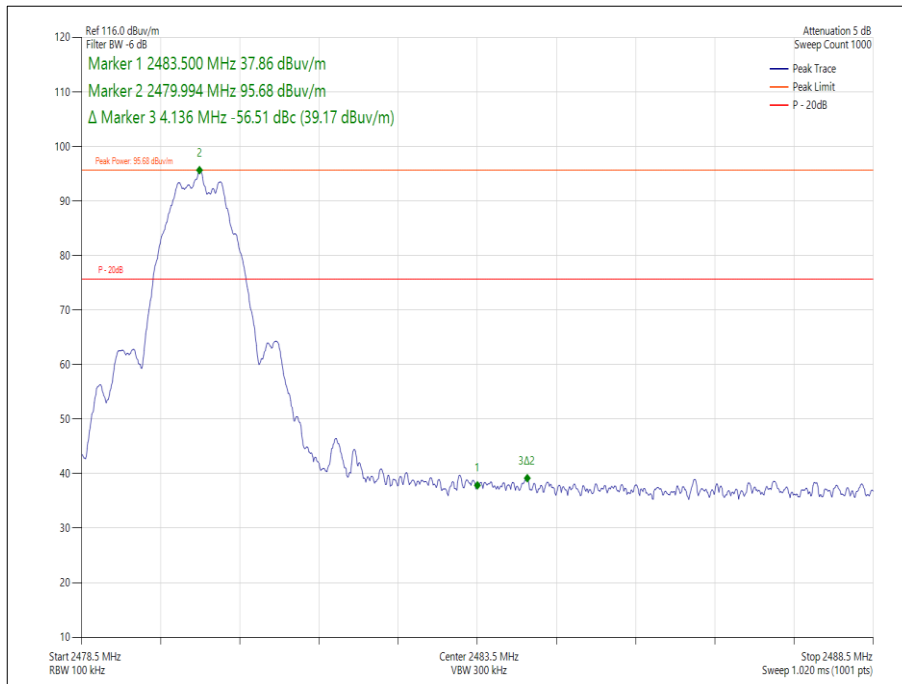

Figure 10 - GFSK, 2480 MHz - Measured Frequency 2483.5 MHz

FCC 47 CFR Part 15, Limit Clause 15.247 (d)

20 dB below the fundamental measured in a 100 kHz bandwidth using a peak detector. If the transmitter complies with the conducted power limits, based on the use of RMS averaging over a time interval, the attenuation required shall be 30 dB below the fundamental instead of 20 dB.

ISED RSS-247, Limit Clause 5.5

In any 100 kHz bandwidth outside the frequency band in which the spread spectrum or digitally modulated device is operating, the RF power that is produced shall be at least 20 dB below that in the 100 kHz bandwidth within the band that contains the highest level of the desired power, based on either an RF conducted or a radiated measurement, provided that the transmitter demonstrates compliance with the peak conducted power limits. If the transmitter complies with the conducted power limits based on the use of root-mean-square averaging over a time interval, as permitted under Section 5.4(4), the attenuation required shall be 30 dB instead of 20 dB. Attenuation below the general field strength limits specified in RSS-Gen is not required.



2.4.7 Test Location and Test Equipment Used

This test was carried out in RF Chamber 11.

Instrument	Manufacturer	Type No	TE No	Calibration Period (months)	Calibration Expires
EMI Test Receiver	Rohde & Schwarz	ESW44	5084	12	17-May-2023
Emissions Software	TUV SUD	EmX V3.1.4	5125	-	Software
Screened Room (11)	Rainford	Rainford	5136	36	24-Nov-2024
Mast	Maturo	TAM 4.0-P	5158	-	TU
Mast and Turntable Controller	Maturo	Maturo NCD	5159	-	TU
Turntable	Maturo	TT 15WF	5160	-	TU
Antenna (DRG 1-10.5GHz)	Schwarzbeck	BBHA9120B	5215	12	28-May-2023
Thermo-Hygro-Barometer	PCE Instruments	OCE-THB-40	5470	12	07-Apr-2023
2m SMA Cable	Junkosha	MWX221-02000AMSAMS/A	5518	12	12-Apr-2023
8m N Type Cable	Junkosha	MWX221-08000NMSNMS/B	5522	12	24-Mar-2023

Table 27

TU - Traceability Unscheduled



2.5 Spurious Radiated Emissions

2.5.1 Specification Reference

FCC 47 CFR Part 15C, Clause 15.247 (d) and 15.209
ISED RSS-247, Clause 3.3 and 5.5
ISED RSS-GEN, Clause 6.13 and 8.9

2.5.2 Equipment Under Test and Modification State

WP01, S/N: M8D-CN-FDN00012X - Modification State 0
WP01, S/N: M8D-CN-FDN00014X - Modification State 0

2.5.3 Date of Test

29-September-2022 to 04-October-2022

2.5.4 Test Method

This test was performed in accordance with ANSI C63.10, clause 6.3, 6.5 and 6.6.

Prior to emission pre-scans, checks on the fundamental were performed with the device positioned flat, on its side and up-right on the turntable platform. With the measurement antenna orientated in both horizontal and vertical polarisation, it was determined which position resulted in the maximum level of the fundamental signal. Any emission identified within 10 dB of the limit was then investigated in the other positions.

For frequencies > 1 GHz, plots for average measurements were taken in accordance with ANSI C63.10, clause 11.12.2.5.2 to characterize the EUT.

The EUT was placed on the non-conducting platform in a manner typical of a normal installation.

The plots shown are the characterisation of the EUT. The limits on the plots represent the most stringent case for restricted bands, (74/54 dBuV/m) when compared to 20 dBc outside restricted bands. The limits shown have been used as a threshold to determine where further measurements are necessary. Where results are within 10 dB of the limits shown on the plots, further investigation was carried out and reported in results tables.

The following conversion can be applied to convert from dBuV/m to uV/m:

$$10^{(\text{Field Strength in dBuV/m}/20)}$$

Above 18 GHz, the measurement distance was reduced to 1 m. The limit line was increased by $20 \cdot \text{LOG}(3/1) = 9.54$ dB.

Where formal measurements have been necessary, the results have been presented in the emissions table.

2.5.5 Test Setup Diagram

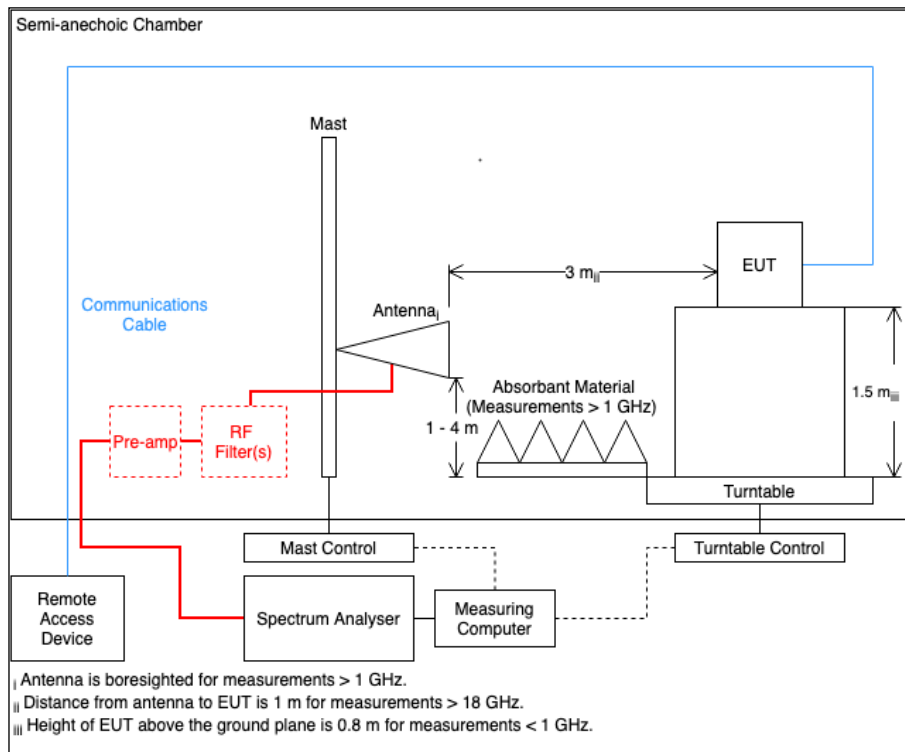

Figure 11

2.5.6 Environmental Conditions

Ambient Temperature 20.0 - 21.6 °C
Relative Humidity 38.7 - 56.3 %



2.5.7 Test Results

2.4 GHz Bluetooth Low Energy - Right Cup

Modulation/Packet Type: GFSK/DH1

Frequency (MHz)	Level (dBµV/m)	Limit (dBµV/m)	Margin (dB)	Detector	Angle (°)	Height (cm)	Polarisation	Orientation
*								

Table 28 - 2402 MHz, 30 MHz to 1 GHz

*No emissions were detected within 10 dB of the limit.

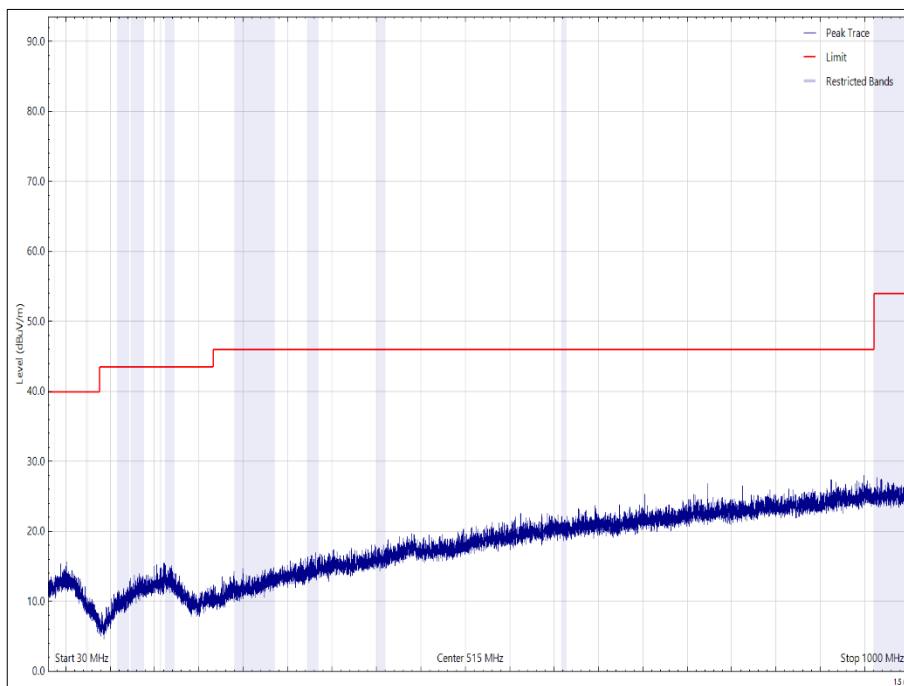

Figure 12 - 2402 MHz, 30 MHz to 1 GHz, Vertical

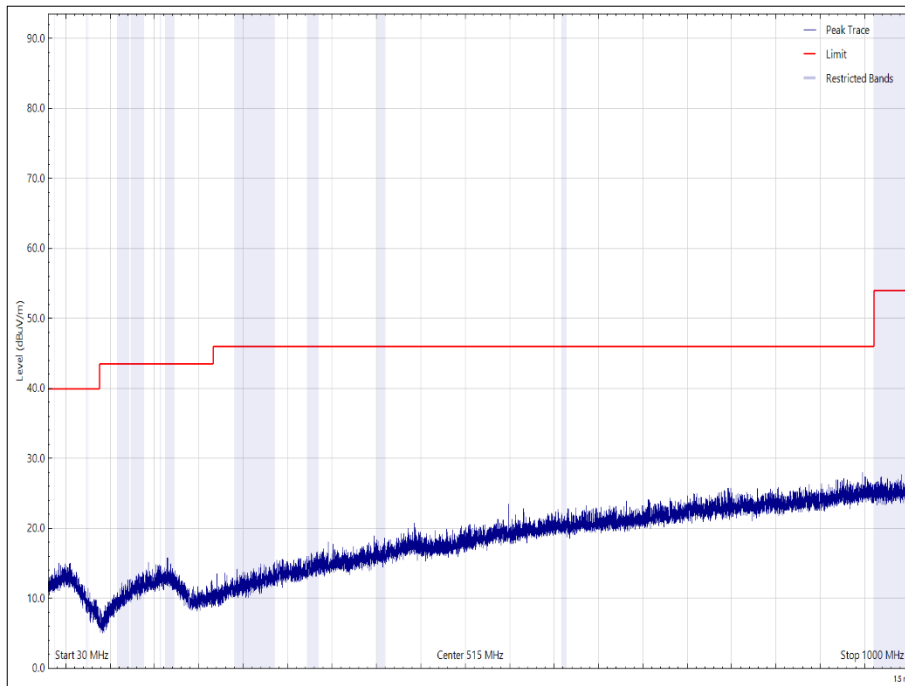

Figure 13 - 2402 MHz, 30 MHz to 1 GHz, Horizontal



Frequency (MHz)	Level (dB μ V/m)	Limit (dB μ V/m)	Margin (dB)	Detector	Angle (°)	Height (cm)	Polarisation	Orientation
*								

Table 29 - 2402 MHz, 1 GHz to 25 GHz

*No emissions were detected within 10 dB of the limit.

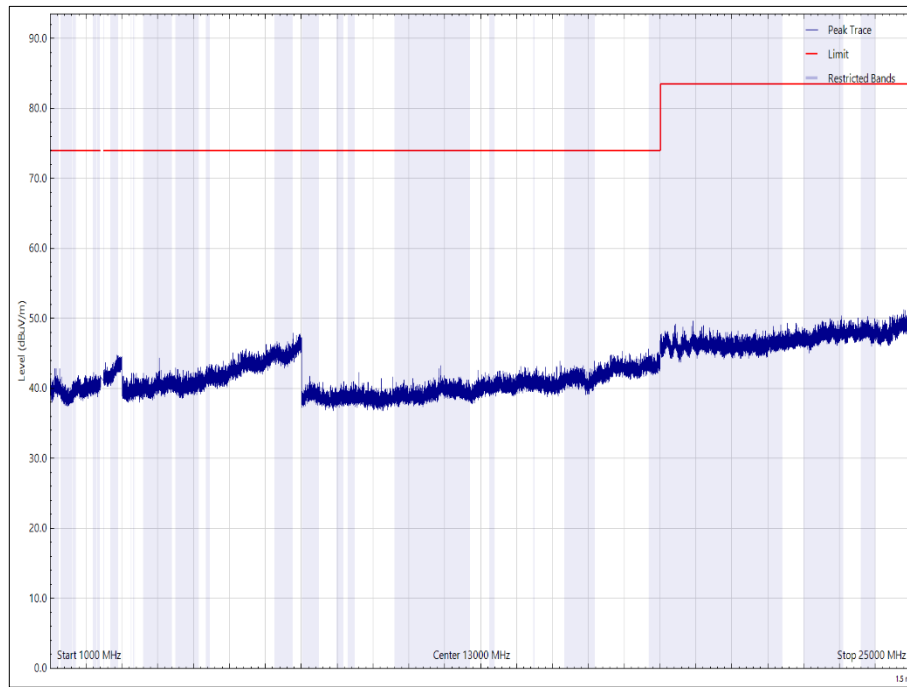

Figure 14 - 2402 MHz, 1 GHz to 25 GHz, Vertical - Peak

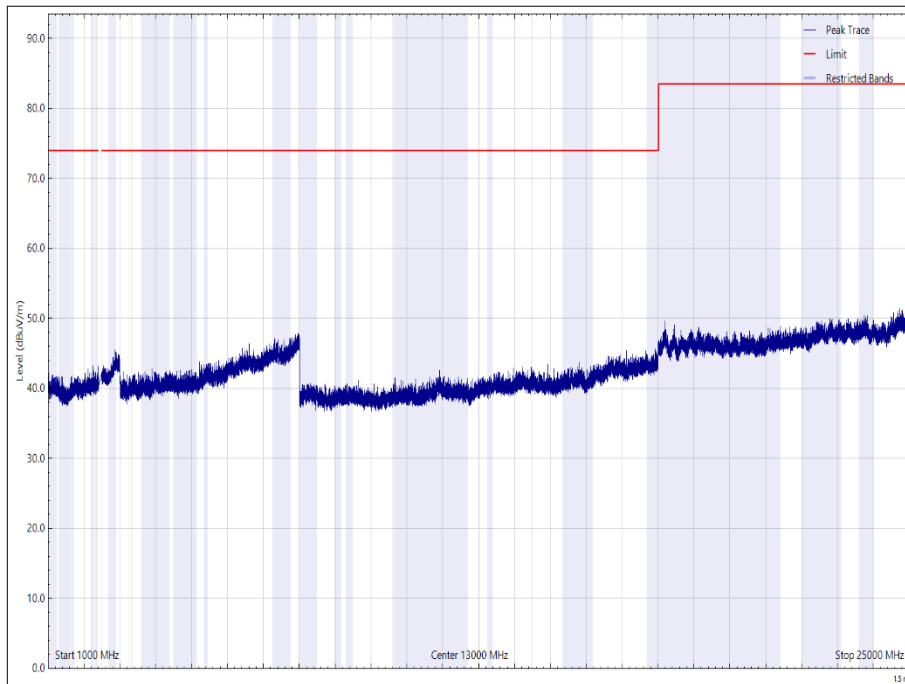

Figure 15 - 2402 MHz, 1 GHz to 25 GHz, Horizontal - Peak

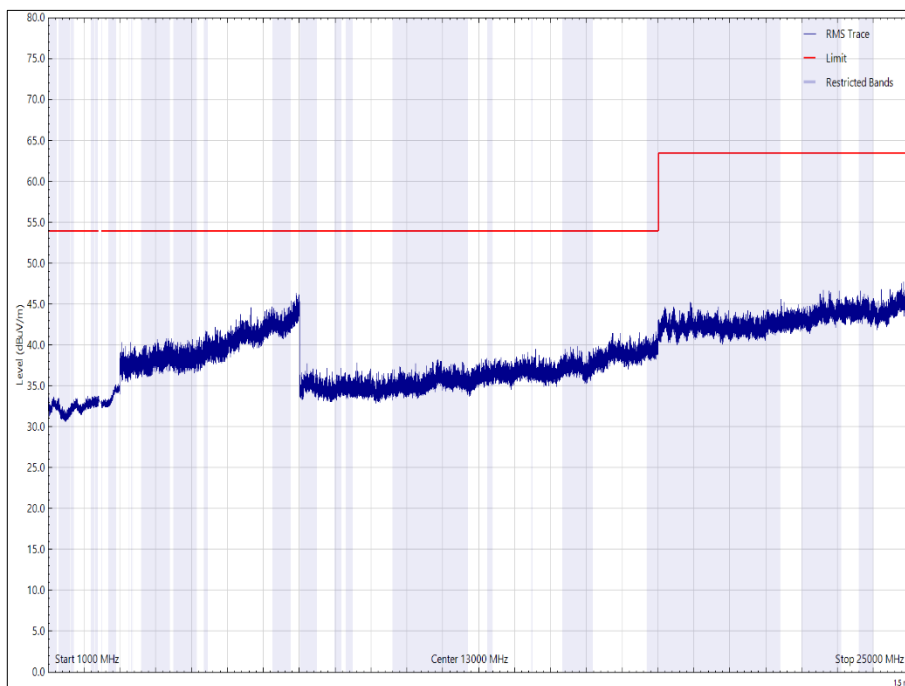

Figure 16 - 2402 MHz, 1 GHz to 25 GHz, Vertical - Average

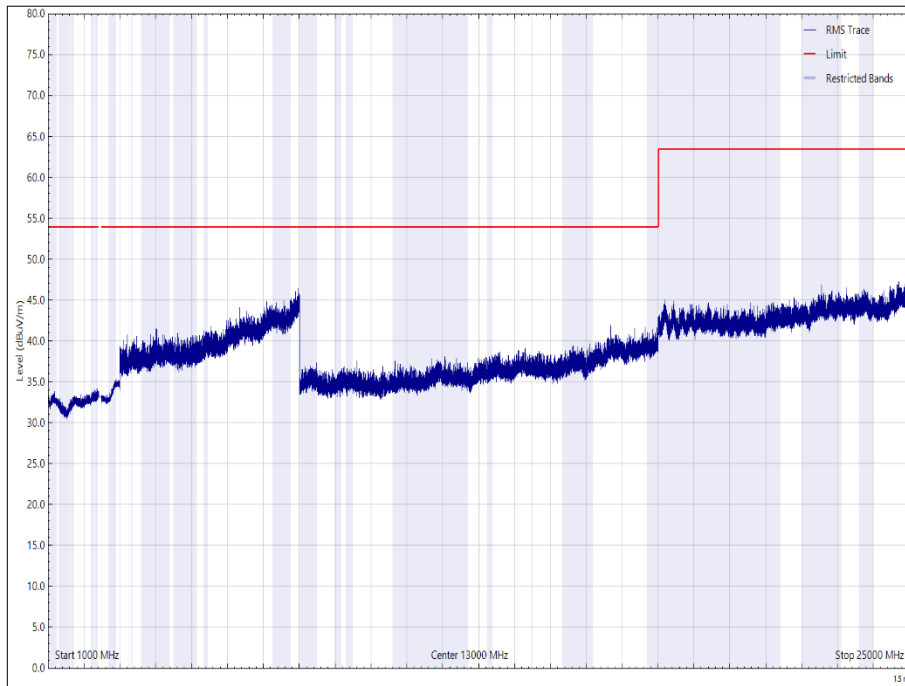

Figure 17 - 2402 MHz, 1 GHz to 25 GHz, Horizontal - Average



Frequency (MHz)	Level (dBµV/m)	Limit (dBµV/m)	Margin (dB)	Detector	Angle (°)	Height (cm)	Polarisation	Orientation
*								

Table 30 – 2440 MHz, 30 MHz to 1 GHz

*No emissions were detected within 10 dB of the limit.

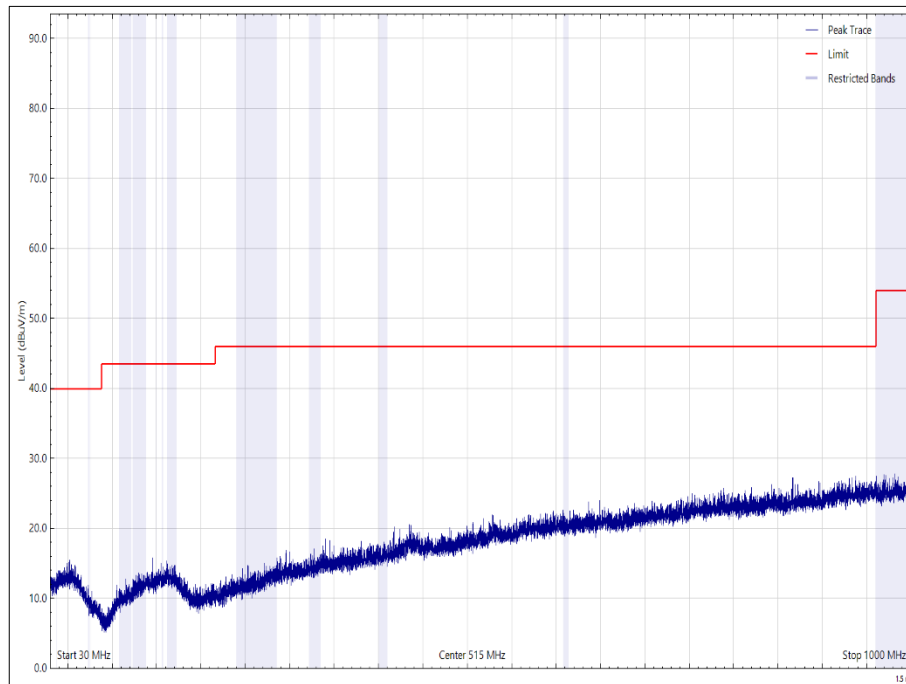

Figure 18 - 2440 MHz, 30 MHz to 1 GHz, Vertical

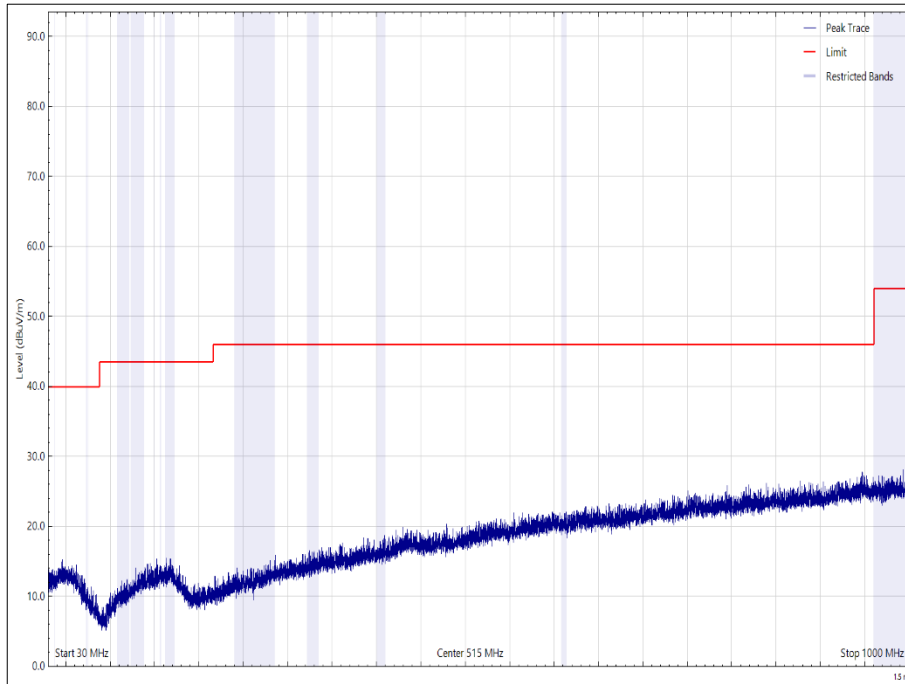

Figure 19 - 2440 MHz, 30 MHz to 1 GHz, Horizontal



Frequency (MHz)	Level (dBµV/m)	Limit (dBµV/m)	Margin (dB)	Detector	Angle (°)	Height (cm)	Polarisation	Orientation
*								

Table 31 - 2440 MHz - 1 GHz to 25 GHz

*No emissions were detected within 6 dB of the limit.

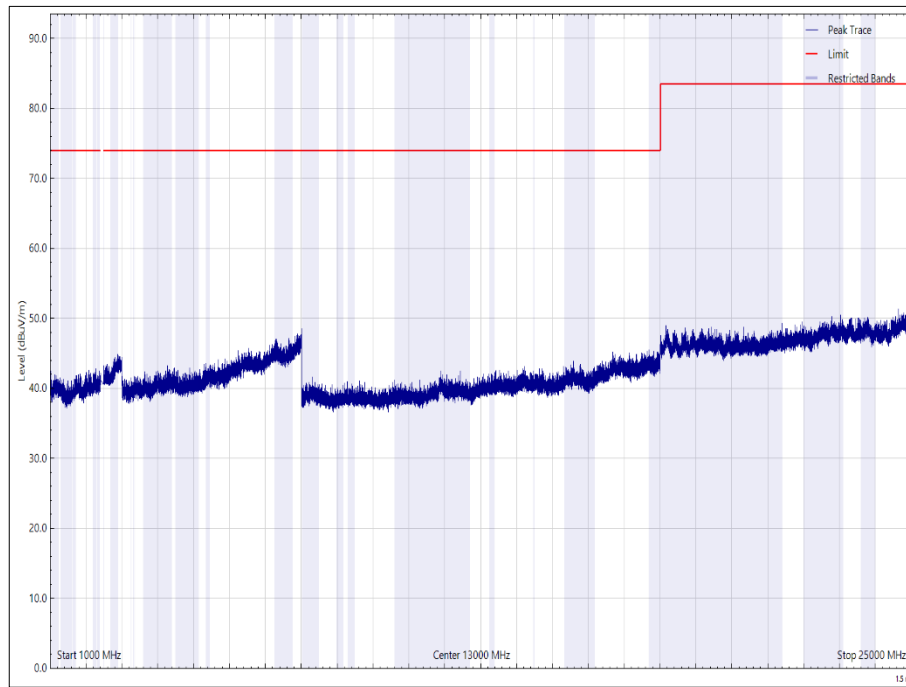

Figure 20 - 2440 MHz - 1 GHz to 25 GHz, Vertical - Peak

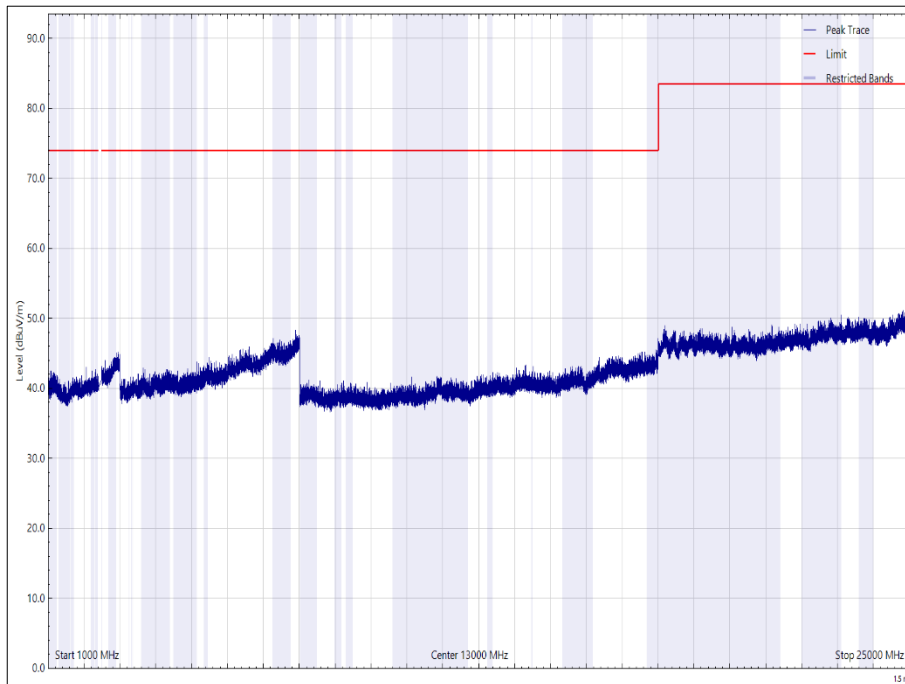

Figure 21 - 2440 MHz - 1 GHz to 25 GHz, Horizontal - Peak

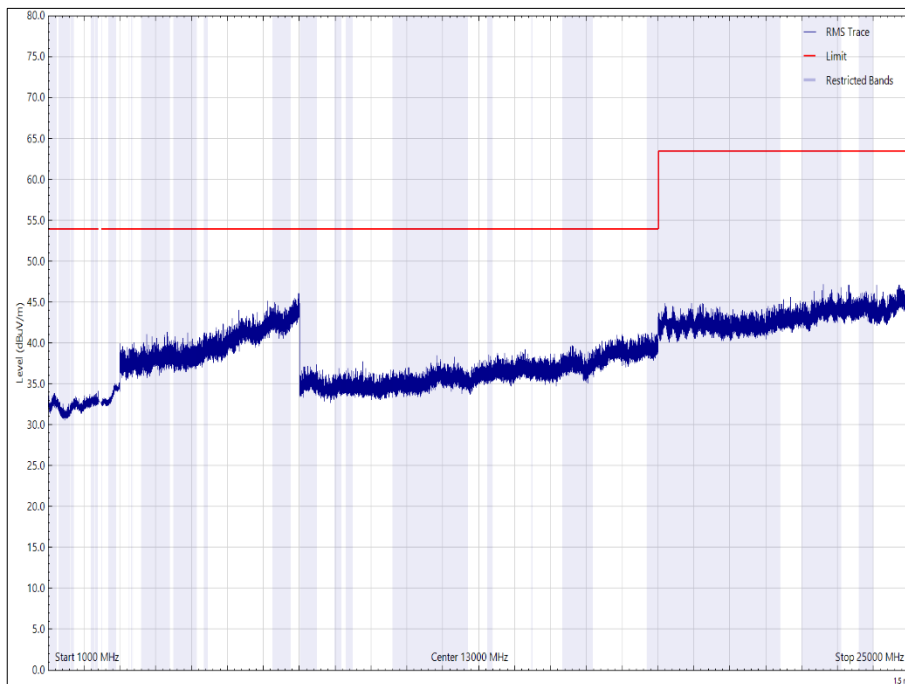

Figure 22 - 2440 MHz - 1 GHz to 25 GHz, Vertical - Average

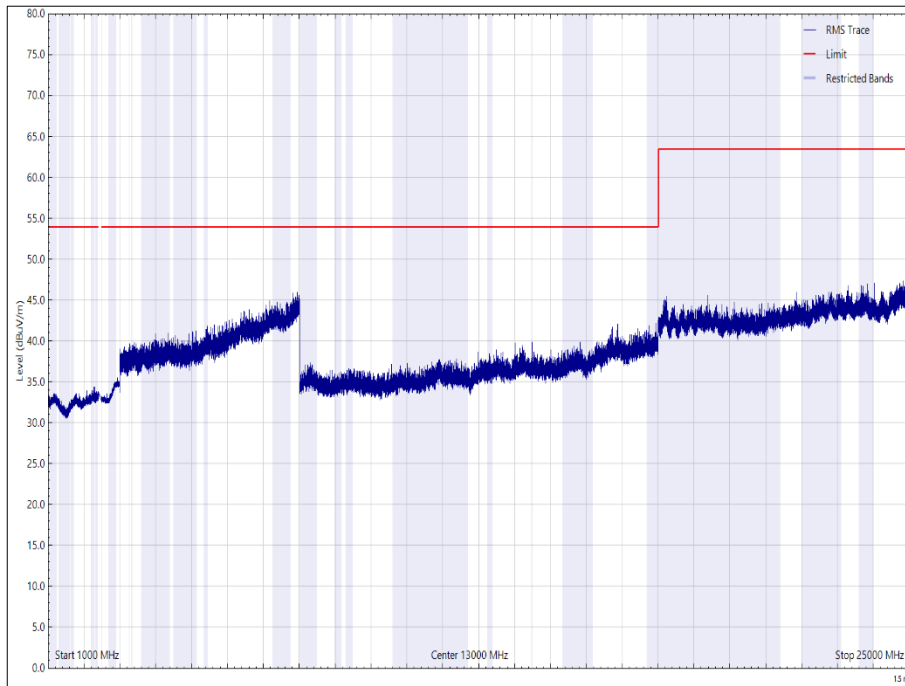

Figure 23 - 2440 MHz - 1 GHz to 25 GHz, Horizontal - Average



Frequency (MHz)	Level (dBµV/m)	Limit (dBµV/m)	Margin (dB)	Detector	Angle (°)	Height (cm)	Polarisation	Orientation
*								

Table 32 - 2480 MHz, 30 MHz to 1 GHz

*No emissions were detected within 10 dB of the limit.

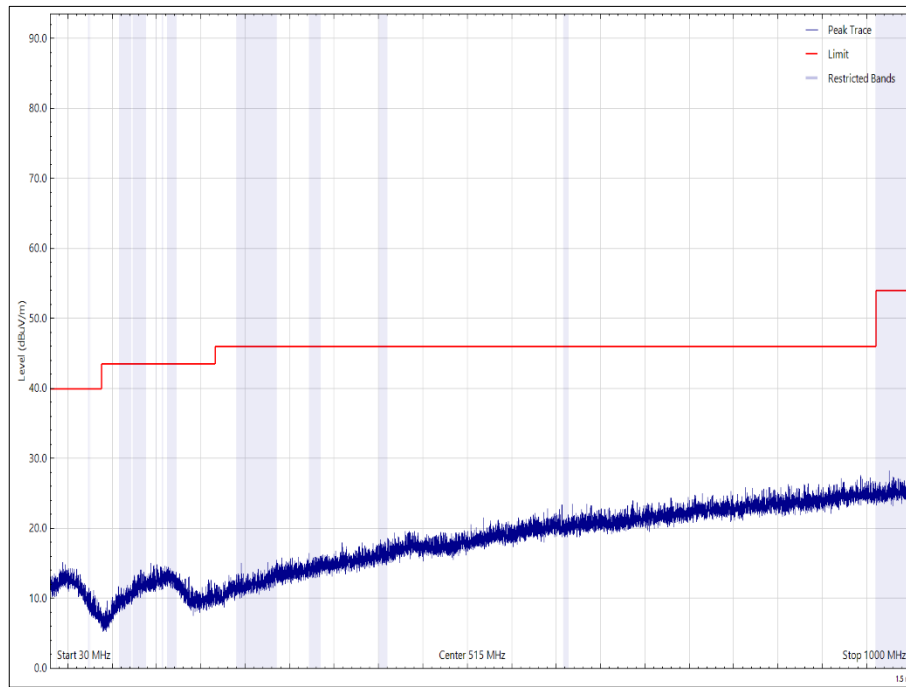

Figure 24 - 2480 MHz, 30 MHz to 1 GHz, Vertical

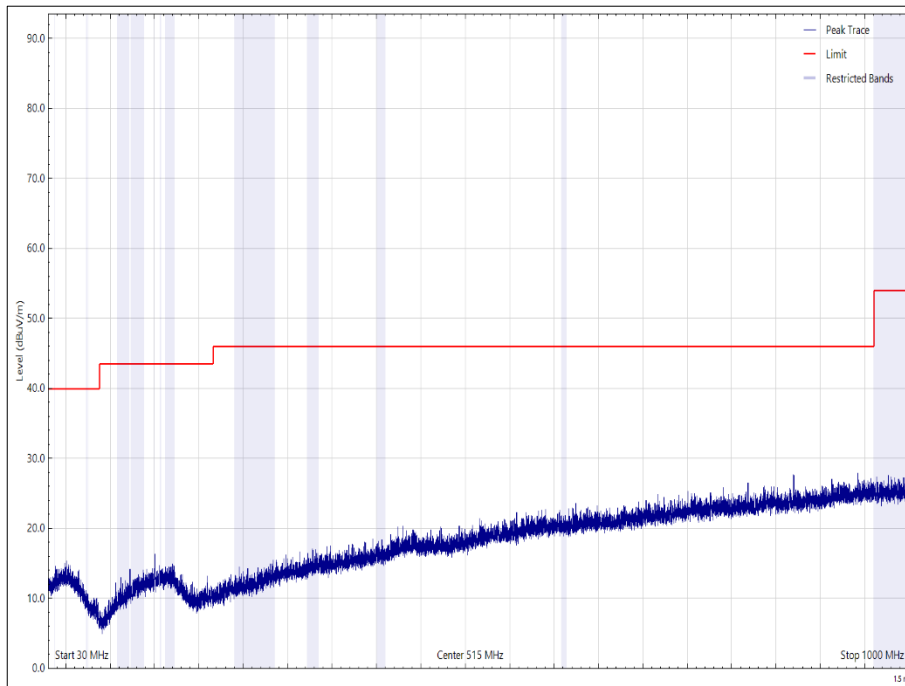

Figure 25 - 2480 MHz, 30 MHz to 1 GHz, Horizontal



Frequency (MHz)	Level (dBµV/m)	Limit (dBµV/m)	Margin (dB)	Detector	Angle (°)	Height (cm)	Polarisation	Orientation
*								

Table 33 - 2480 MHz - 1 GHz to 25 GHz

*No emissions were detected within 10 dB of the limit.

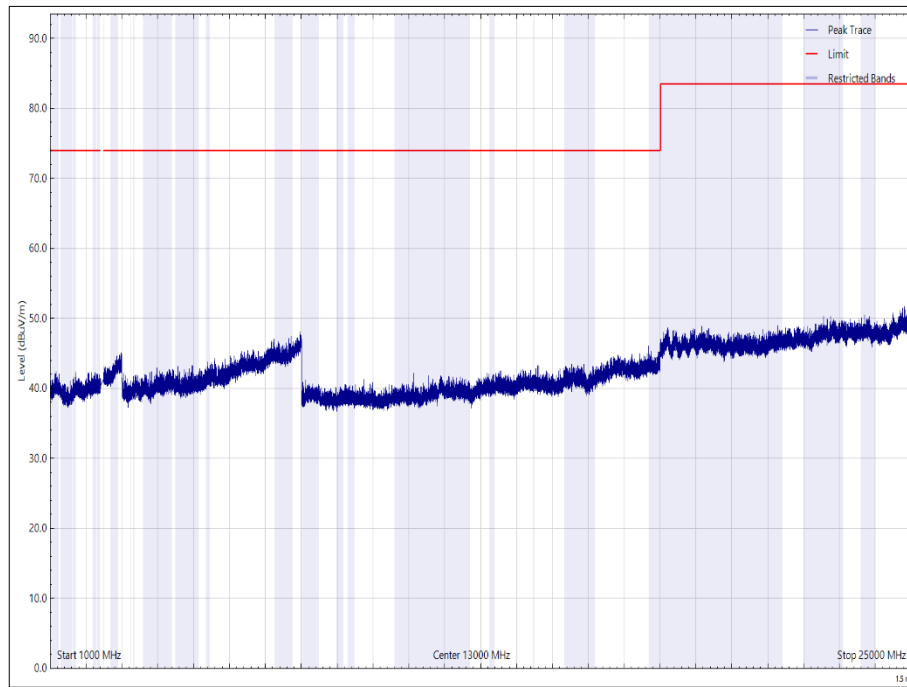

Figure 26 - 2480 MHz - 1 GHz to 25 GHz, Vertical - Peak

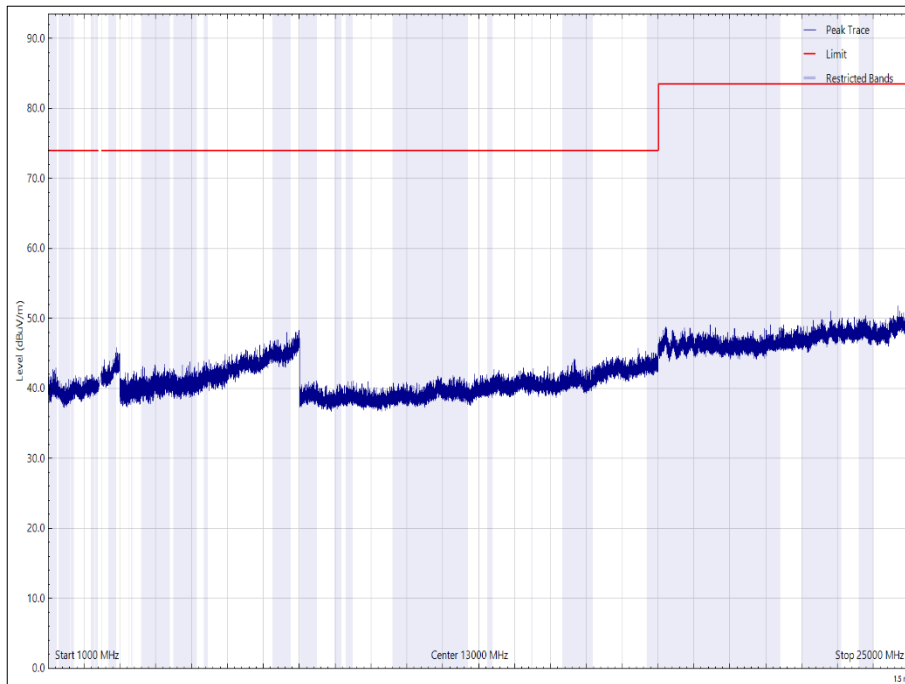

Figure 27 - 2480 MHz - 1 GHz to 25 GHz, Horizontal - Peak

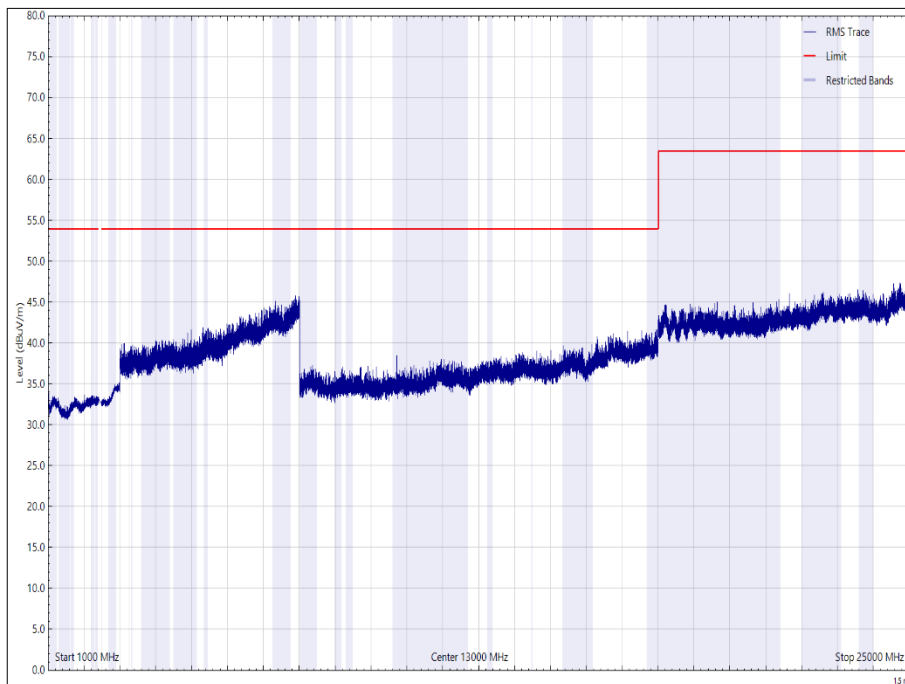

Figure 28 - 2480 MHz - 1 GHz to 25 GHz, Vertical - Average

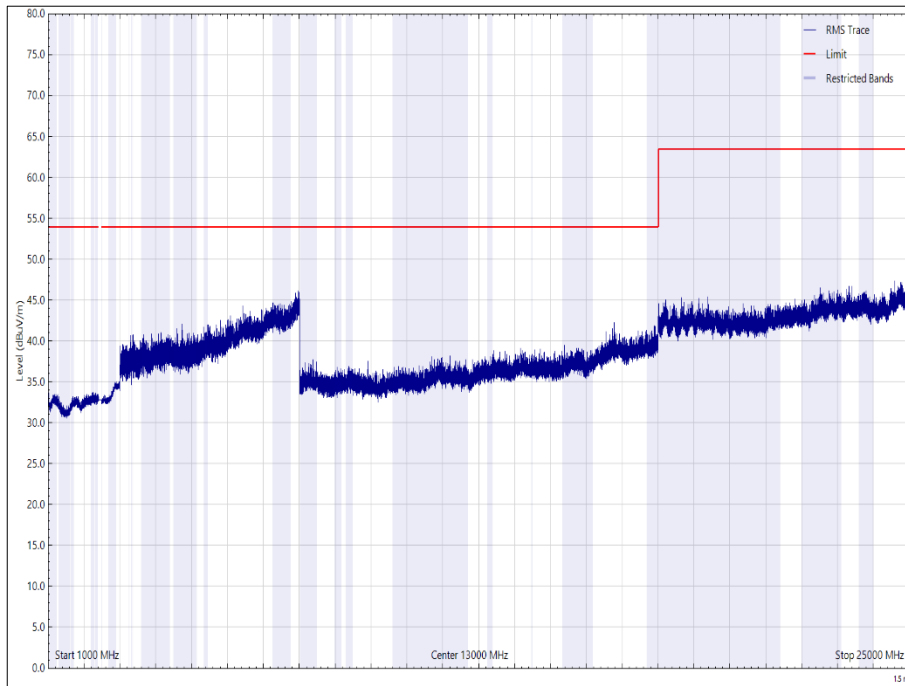

Figure 29 - 2480 MHz - 1 GHz to 25 GHz, Horizontal - Average



2.4 GHz Bluetooth Low Energy - Left Cup

Modulation/Packet Type: GFSK/DH1

Frequency (MHz)	Level (dB μ V/m)	Limit (dB μ V/m)	Margin (dB)	Detector	Angle (°)	Height (cm)	Polarisation	Orientation
*								

Table 34 - 2402 MHz, 30 MHz to 1 GHz

*No emissions were detected within 10 dB of the limit.

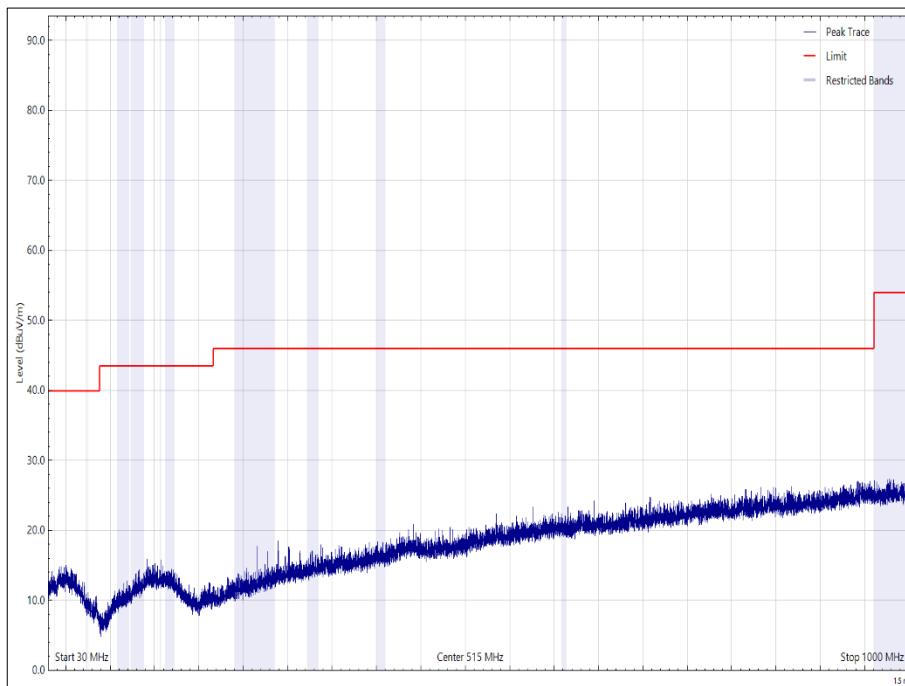

Figure 30 - 2402 MHz, 30 MHz to 1 GHz, Vertical

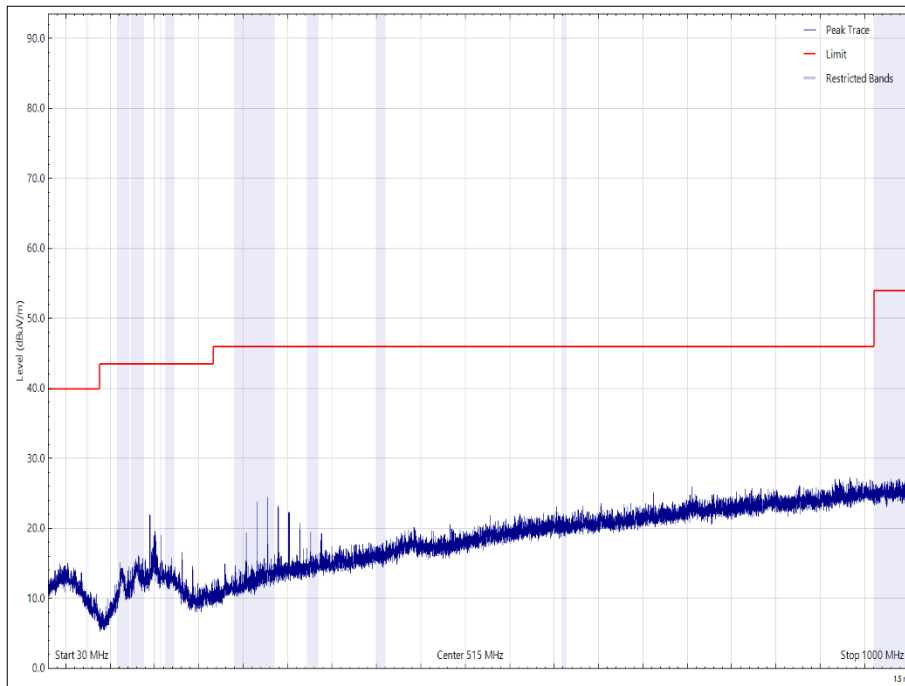

Figure 31 - 2402 MHz, 30 MHz to 1 GHz, Horizontal



Frequency (MHz)	Level (dBµV/m)	Limit (dBµV/m)	Margin (dB)	Detector	Angle (°)	Height (cm)	Polarisation	Orientation
*								

Table 35 - 2402 MHz, 1 GHz to 25 GHz

*No emissions were detected within 10 dB of the limit.

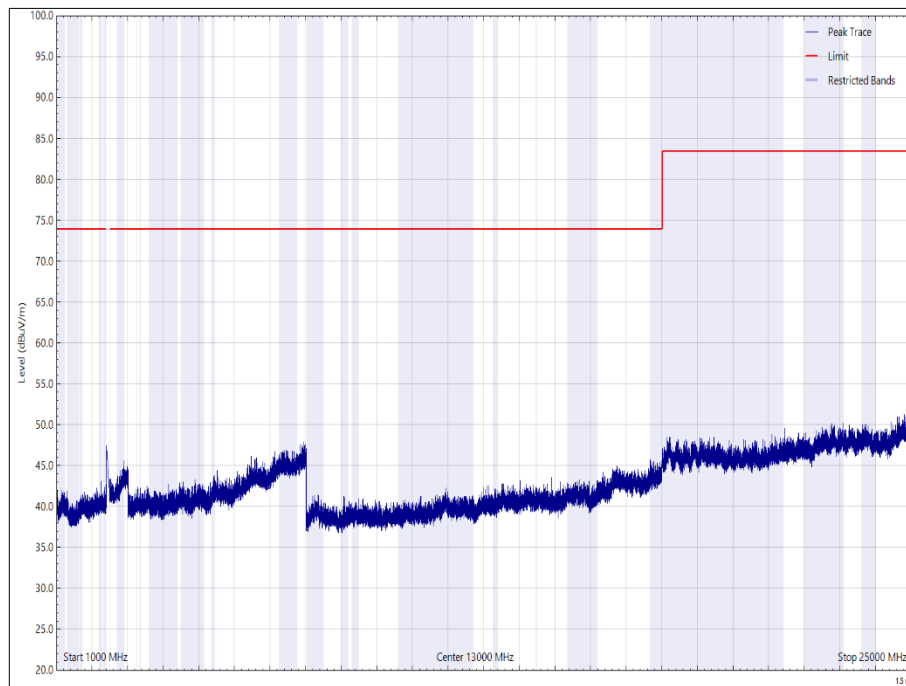

Figure 32 - 2402 MHz, 1 GHz to 25 GHz, Vertical - Peak

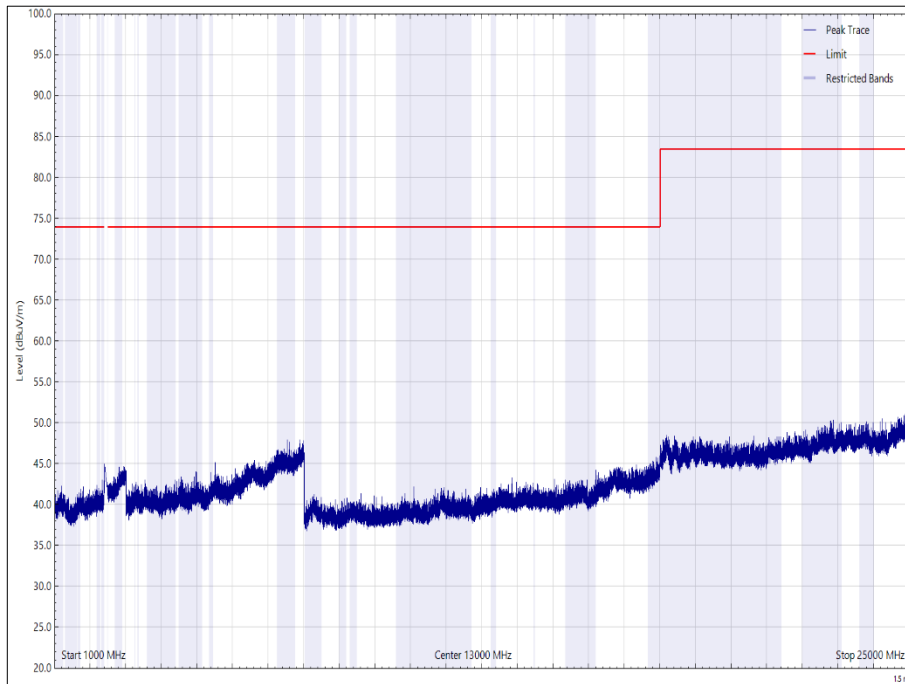

Figure 33 - 2402 MHz, 1 GHz to 25 GHz, Horizontal - Peak

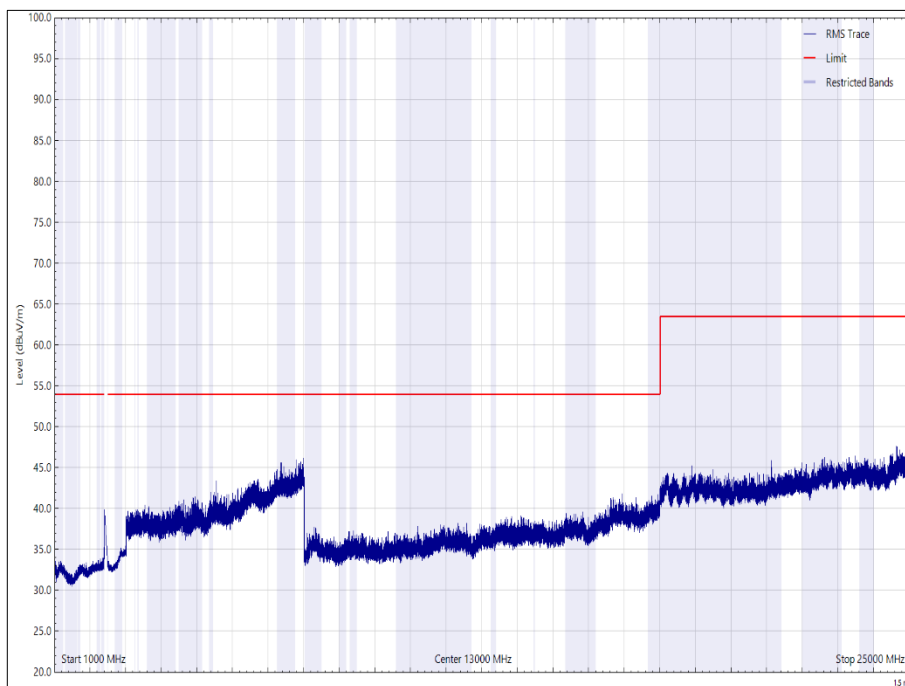

Figure 34 - 2402 MHz, 1 GHz to 25 GHz, Vertical - Average

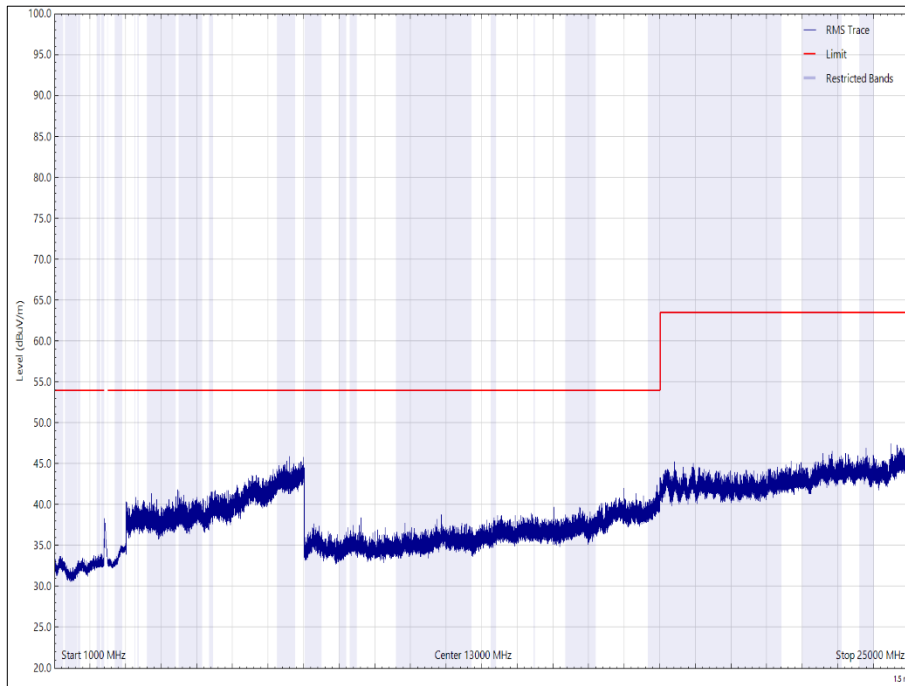

Figure 35 - 2402 MHz, 1 GHz to 25 GHz, Horizontal - Average



Frequency (MHz)	Level (dB μ V/m)	Limit (dB μ V/m)	Margin (dB)	Detector	Angle (°)	Height (cm)	Polarisation	Orientation
*								

Table 36 - 2440 MHz, 30 MHz to 1 GHz

*No emissions were detected within 10 dB of the limit.

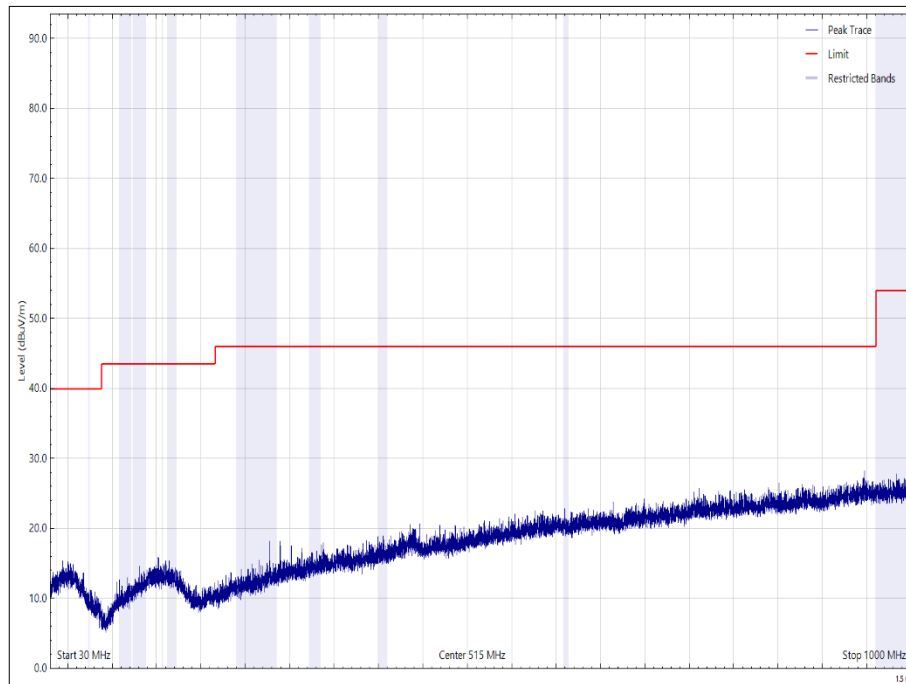

Figure 36 - 2440 MHz, 30 MHz to 1 GHz, Vertical

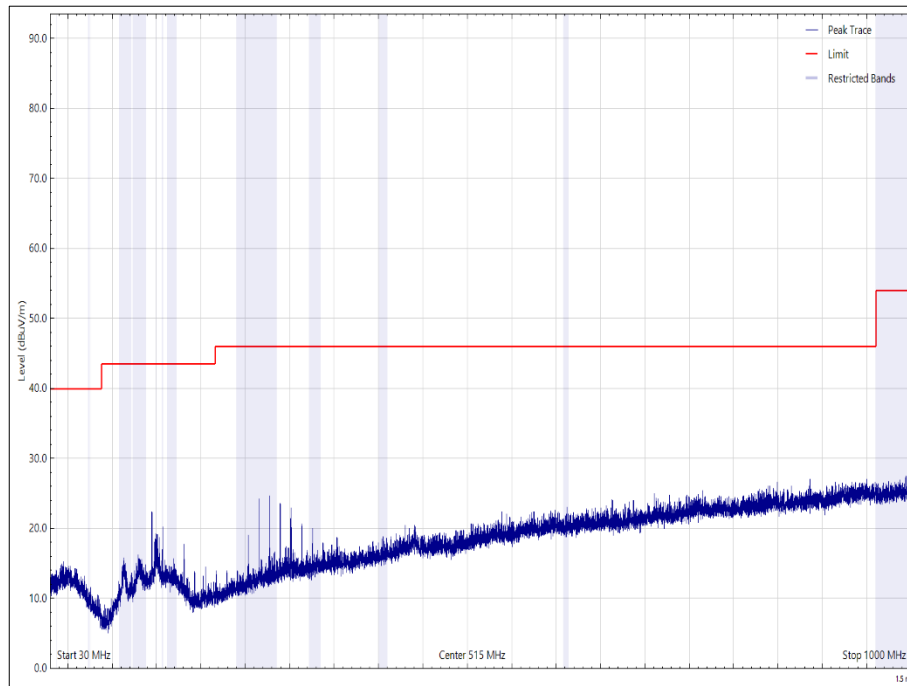

Figure 37 - 2440 MHz, 30 MHz to 1 GHz, Horizontal



Frequency (MHz)	Level (dBµV/m)	Limit (dBµV/m)	Margin (dB)	Detector	Angle (°)	Height (cm)	Polarisation	Orientation
*								

Table 37 - 2440 MHz - 1 GHz to 25 GHz

*No emissions were detected within 10 dB of the limit.

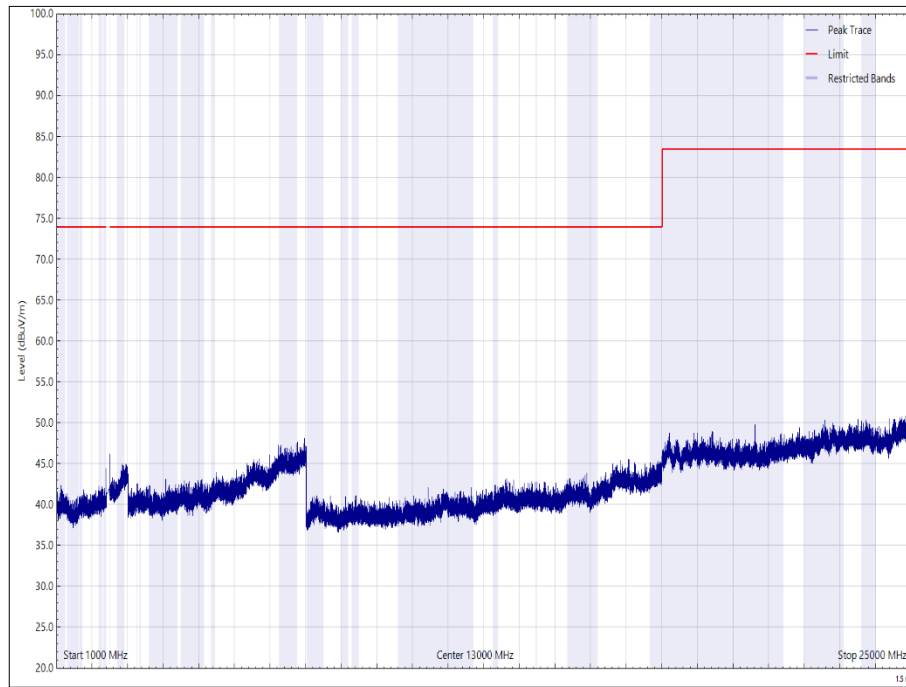

Figure 38 - 2440 MHz - 1 GHz to 25 GHz, Vertical - Peak

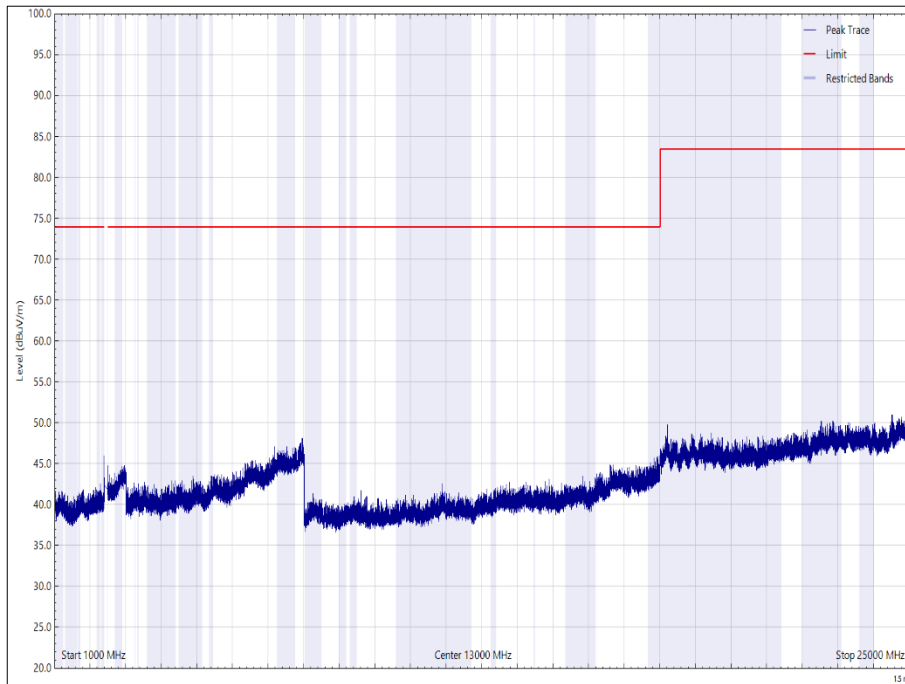

Figure 39 - 2440 MHz - 1 GHz to 25 GHz, Horizontal - Peak

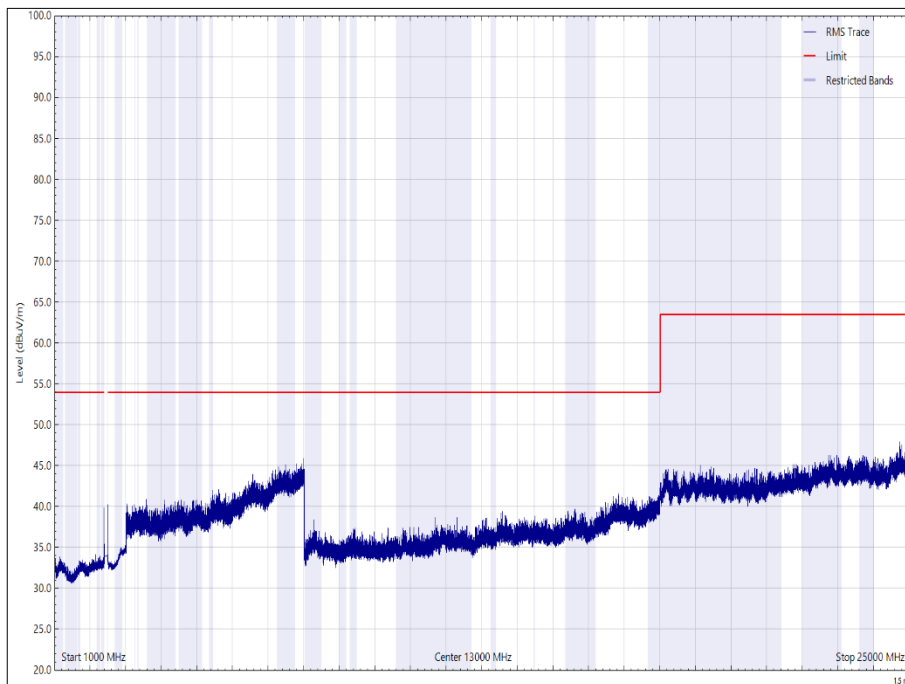

Figure 40 - 2440 MHz - 1 GHz to 25 GHz, Vertical - Average

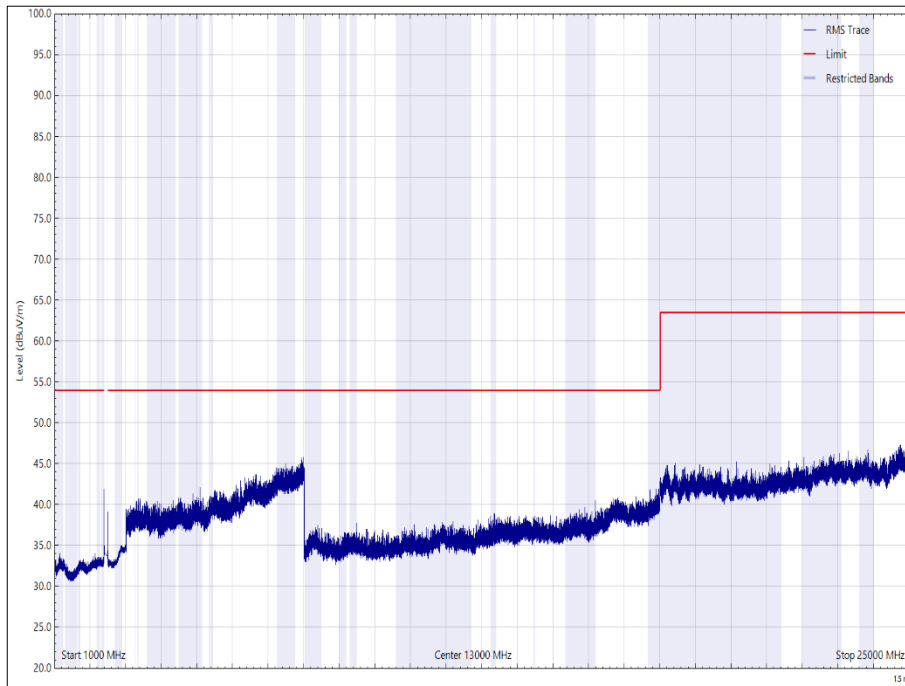

Figure 41 - 2440 MHz - 1 GHz to 25 GHz, Horizontal - Average



Frequency (MHz)	Level (dB μ V/m)	Limit (dB μ V/m)	Margin (dB)	Detector	Angle (°)	Height (cm)	Polarisation	Orientation
*								

Table 38 - 2480 MHz, 30 MHz to 1 GHz

*No emissions were detected within 10 dB of the limit.

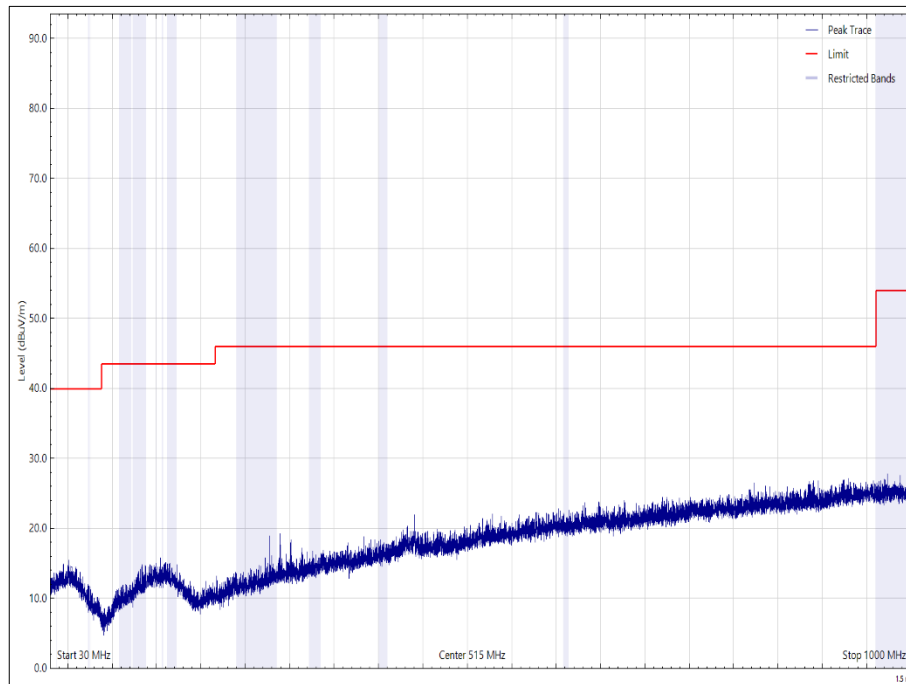

Figure 42 - 2480 MHz, 30 MHz to 1 GHz, Vertical

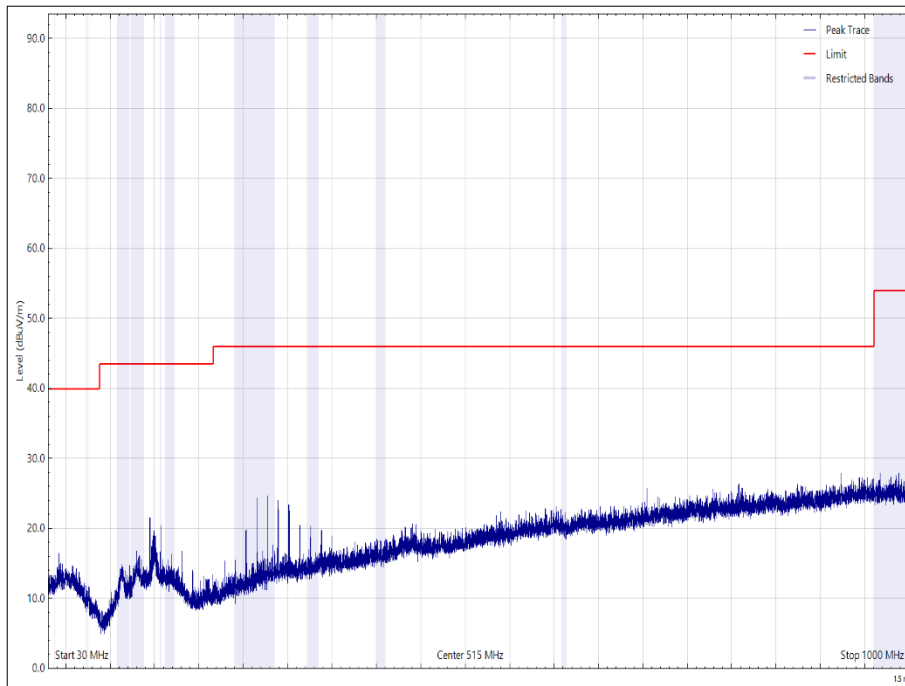

Figure 43 - 2480 MHz, 30 MHz to 1 GHz, Horizontal



Frequency (MHz)	Level (dBµV/m)	Limit (dBµV/m)	Margin (dB)	Detector	Angle (°)	Height (cm)	Polarisation	Orientation
*30 MHz to 1 GHz								

Table 39 - 2480 MHz - 1 GHz to 25 GHz

*No emissions were detected within 10 dB of the limit.

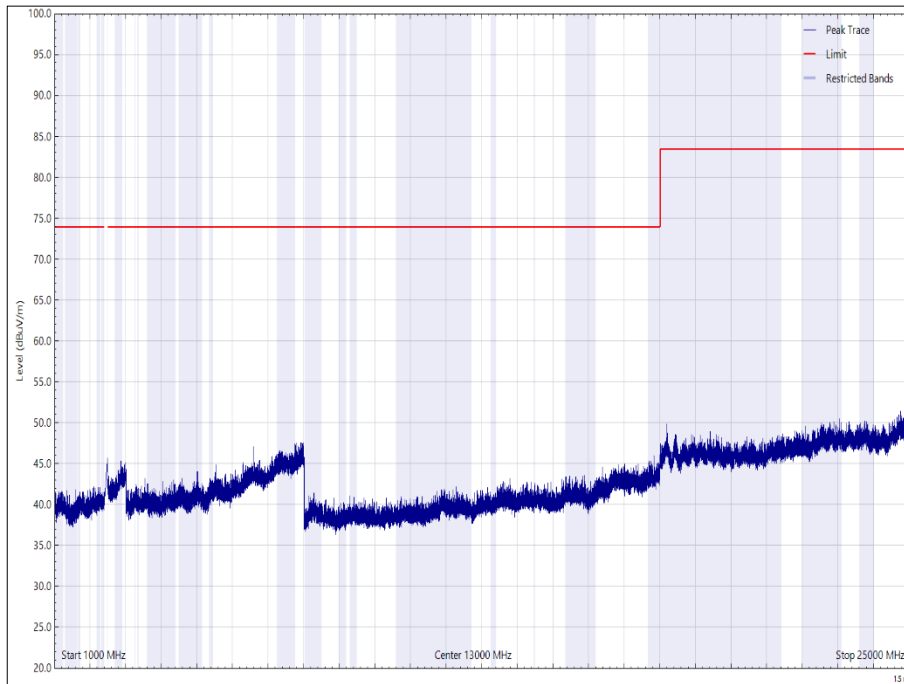

Figure 44 - 2480 MHz - 1 GHz to 25 GHz, Vertical, X Orientation - Peak

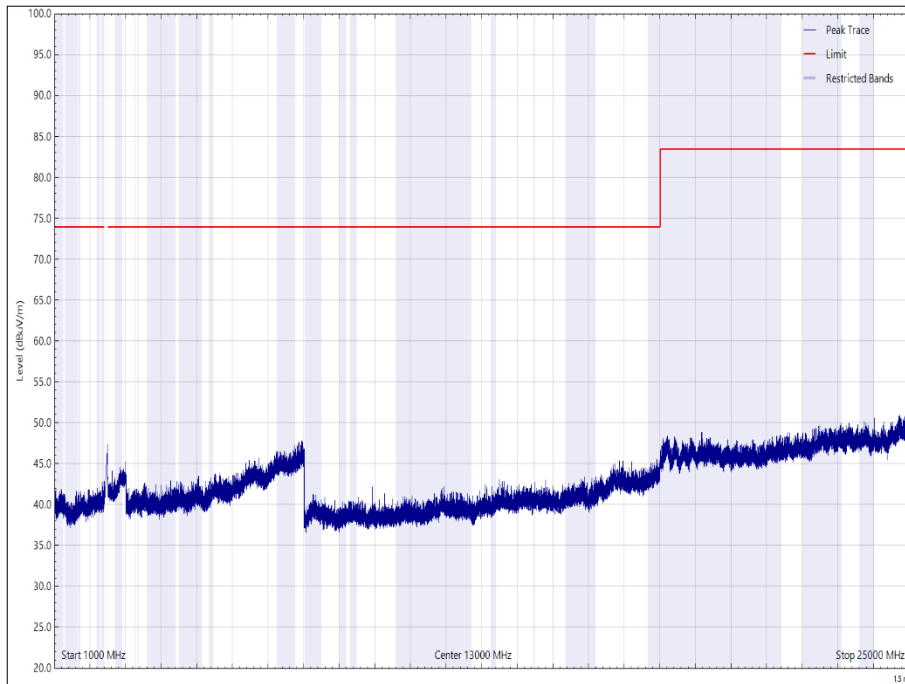

Figure 45 - 2480 MHz - 1 GHz to 25 GHz, Horizontal - Peak

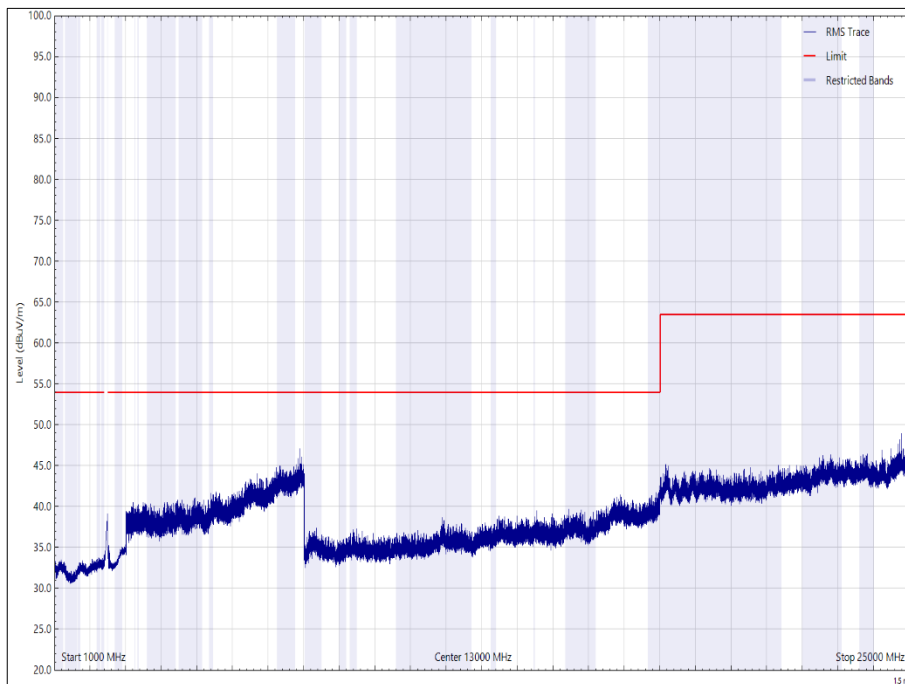

Figure 46 - 2480 MHz - 1 GHz to 25 GHz, Vertical - Average

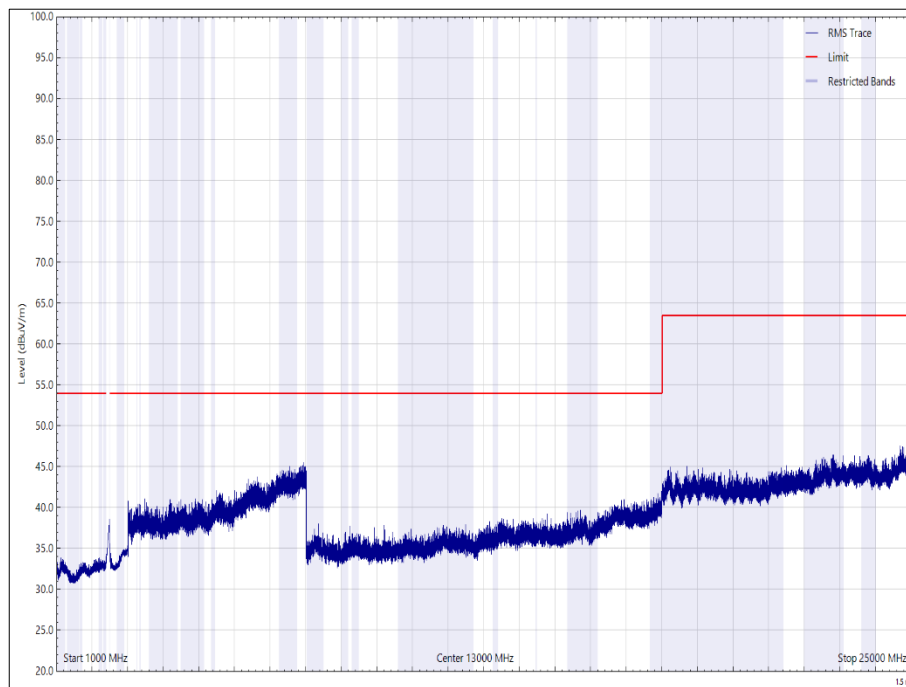

Figure 47 - 2480 MHz - 1 GHz to 25 GHz, Horizontal - Average

FCC 47 CFR Part 15, Limit Clause 15.247 (d)

In any 100 kHz bandwidth outside the frequency band in which the spread spectrum or digitally modulated intentional radiator is operating, the radio frequency power that is produced by the intentional radiator shall be at least 20 dB below that in the 100 kHz bandwidth within the band that contains the highest level of the desired power, based on either an RF conducted or a radiated measurement, provided the transmitter demonstrates compliance with the peak conducted power limits. If the transmitter complies with the conducted power limits based on the use of RMS averaging over a time interval, as permitted under paragraph (b)(3) of this section, the attenuation required under this paragraph shall be 30 dB instead of 20 dB.

Attenuation below the general limits specified in § 15.209(a) is not required. In addition, radiated emissions which fall in the restricted bands, as defined in § 15.205(a), must also comply with the radiated emission limits specified in 15.209(a).

ISED RSS-247, Limit Clause 5.5

In any 100 kHz bandwidth outside the frequency band in which the spread spectrum or digitally modulated device is operating, the RF power that is produced shall be at least 20 dB below that in the 100 kHz bandwidth within the band that contains the highest level of the desired power, based on either an RF conducted or a radiated measurement, provided that the transmitter demonstrates compliance with the peak conducted power limits. If the transmitter complies with the conducted power limits based on the use of root-mean-square averaging over a time interval, as permitted under Section 5.4(4), the attenuation required shall be 30 dB instead of 20 dB. Attenuation below the general field strength limits specified in RSS-Gen is not required.

In addition, radiated emissions which fall in the restricted bands, as defined in RSS-GEN, clause 8.10, must also comply with the radiated emission limits specified in RSS-GEN clause 8.9.



2.5.8 Test Location and Test Equipment Used

This test was carried out in RF Chamber 11.

Instrument	Manufacturer	Type No	TE No	Calibration Period (months)	Calibration Expires
True RMS Multimeter	Fluke	179	4006	12	29-Mar-2023
Pre-Amplifier (8 GHz to 18 GHz)	Wright Technologies	PS06-0061/PS06-0060	4971	6	19-Nov-2022
EMI Test Receiver	Rohde & Schwarz	ESW44	5084	12	17-May-2023
Cable (18 GHz)	Rosenberger	LU7-071-1000	5103	12	17-Nov-2022
Emissions Software	TUV SUD	EmX V3.1.4	5125	-	Software
Screened Room (11)	Rainford	Rainford	5136	36	24-Nov-2024
Mast	Maturo	TAM 4.0-P	5158	-	TU
Mast and Turntable Controller	Maturo	Maturo NCD	5159	-	TU
Turntable	Maturo	TT 15WF	5160	-	TU
Antenna (DRG 1-10.5GHz)	Schwarzbeck	BBHA9120B	5215	12	28-May-2023
DRG Horn Antenna (7.5-18GHz)	Schwarzbeck	HWRD750	5216	12	29-May-2023
Antenna (DRG, 15 GHz to 40 GHz)	Schwarzbeck	BBHA 9170	5217	12	25-Jan-2023
3 GHz High pass filter	Wainwright	WHKX12-2580-3000-18000-80SS	5220	12	23-Mar-2023
Preamplifier (30dB 1GHz to 18GHz)	Schwarzbeck	BBV 9718 C	5261	12	08-Apr-2023
Thermo-Hygro-Barometer	PCE Instruments	OCE-THB-40	5470	12	07-Apr-2023
2m SMA Cable	Junkosha	MWX221-02000AMSAMS/A	5518	12	12-Apr-2023
8m N Type Cable	Junkosha	MWX221-08000NMSNMS/B	5522	12	24-Mar-2023
7 GHz High pass Filter	Wainwright	WHKX12-5850-6800-18000-80SS	5550	12	19-May-2023
Cable (K Type 2m)	Junkosha	MWX241-01000KMSKMS/B	5934	12	14-May-2023
TRILOG Super Broadband Test Antenna	Schwarzbeck	VULB 9168	5942	24	03-Feb-2024

Table 40

TU - Traceability Unscheduled



2.6 Power Spectral Density

2.6.1 Specification Reference

FCC 47 CFR Part 15C, Clause 15.247 (e)
ISED RSS-247, Clause 5.2
ISED RSS-GEN, Clause 6.12

2.6.2 Equipment Under Test and Modification State

WP01, S/N: F40E11710006 - Modification State 0
WP01, S/N: F40E11710004 - Modification State 0

2.6.3 Date of Test

25-January-2022

2.6.4 Test Method

This test was performed in accordance with ANSI C63.10, clause 11.10.2.

2.6.5 Environmental Conditions

Ambient Temperature	21.5 °C
Relative Humidity	27.1 %



2.6.6 Test Results

2.4 GHz Bluetooth Low Energy - Right Cup

Test Configuration			
Frequency Range:	2400-2483.5 MHz	Band:	2.4 GHz
Limit Clause(s):	15.247 (e) RSS-247 5.2 b)	Test Method(s):	C63.10 11.10.2
Additional Reference(s):	-		

DUT Configuration			
Mode:	BT GFSK (LE 1M)	Duty Cycle (%):	66.5
Antenna Configuration:	SISO	DCCF (dB):	-
Active Port(s):	A (R Cup)	Peak Antenna Gain (dBi):	-

Test Frequency (MHz)	RBW (kHz)	PSD (dBm/RBW)					Limit (dBm/3 kHz)	Margin (dB)
		A	B	C	D	Σ		
2402	3.0	-8.14	-	-	-	-	8.00	-16.14
2440	3.0	-7.80	-	-	-	-	8.00	-15.80
2480	3.0	-7.95	-	-	-	-	8.00	-15.95

Table 41 - Maximum Power Spectral Density Results



2.4 GHz Bluetooth Low Energy - Left Cup

Test Configuration			
Frequency Range:	2400-2483.5 MHz	Band:	2.4 GHz
Limit Clause(s):	15.247 (e) RSS-247 5.2 b)	Test Method(s):	C63.10 11.10.2
Additional Reference(s):	-		

DUT Configuration			
Mode:	BT GFSK (LE 1M)	Duty Cycle (%):	66.5
Antenna Configuration:	SISO	DCCF (dB):	-
Active Port(s):	B (L Cup)	Peak Antenna Gain (dBi):	-

Test Frequency (MHz)	RBW (kHz)	PSD (dBm/RBW)					Limit (dBm/3 kHz)	Margin (dB)
		A	B	C	D	Σ		
2402	3.0	-	-7.80	-	-	-	8.00	-15.80
2440	3.0	-	-7.61	-	-	-	8.00	-15.61
2480	3.0	-	-7.35	-	-	-	8.00	-15.35

Table 42 - Maximum Power Spectral Density Results

FCC 47 CFR Part 15, Limit Clause 15.247 (e)

The power spectral density conducted from the intentional radiator to the antenna shall not be greater than 8 dBm in any 3 kHz band during any time interval of continuous transmission.

ISED RSS-247, Limit Clause 5.2(b)

The transmitter power spectral density conducted from the transmitter to the antenna shall not be greater than 8 dBm in any 3 kHz band during any time interval of continuous transmission.



2.6.7 Test Location and Test Equipment Used

This test was carried out in RF Laboratory 1.

Instrument	Manufacturer	Type No	TE No	Calibration Period (months)	Calibration Expires
Hygrometer	Rotronic	I-1000	3220	12	05-Nov-2022
Frequency Standard	Spectracom	SecureSync 1200-0408-0601	4393	6	30-Jun-2022
MXA Signal Analyser	Keysight Technologies	N9020B	5528	24	04-Mar-2022
Signal Conditioning Unit	TUV SUD	SPECTRUM SCU001	5546	12	16-Apr-2022

Table 43

O/P Mon – Output Monitored using calibrated equipment

3 Photographs

3.1 Test Setup Photographs

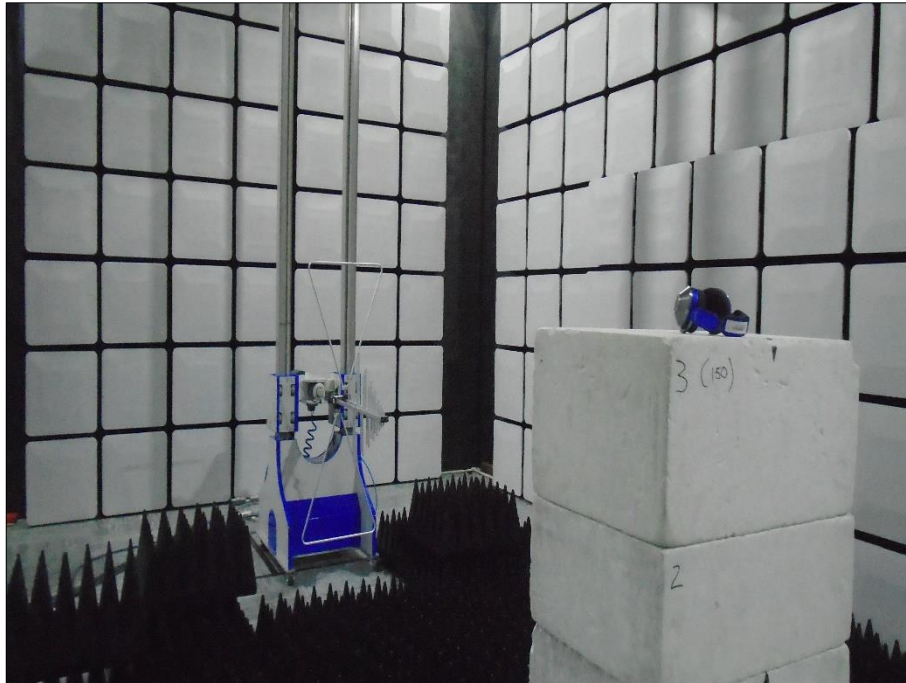

Figure 48 - Test Setup - 30 MHz to 1 GHz

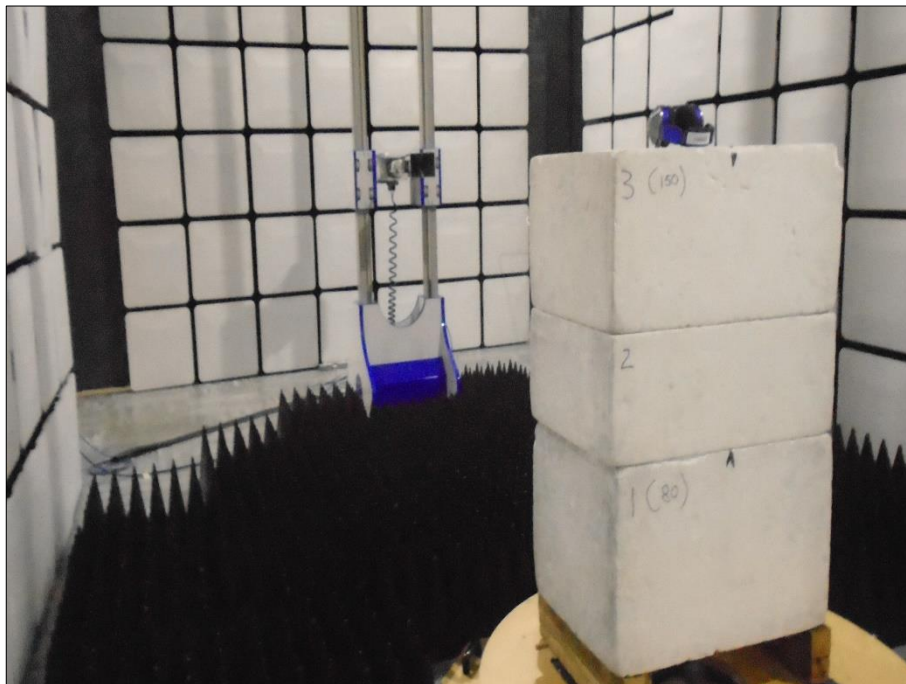

Figure 49 - Test Setup - 1 GHz to 18 GHz

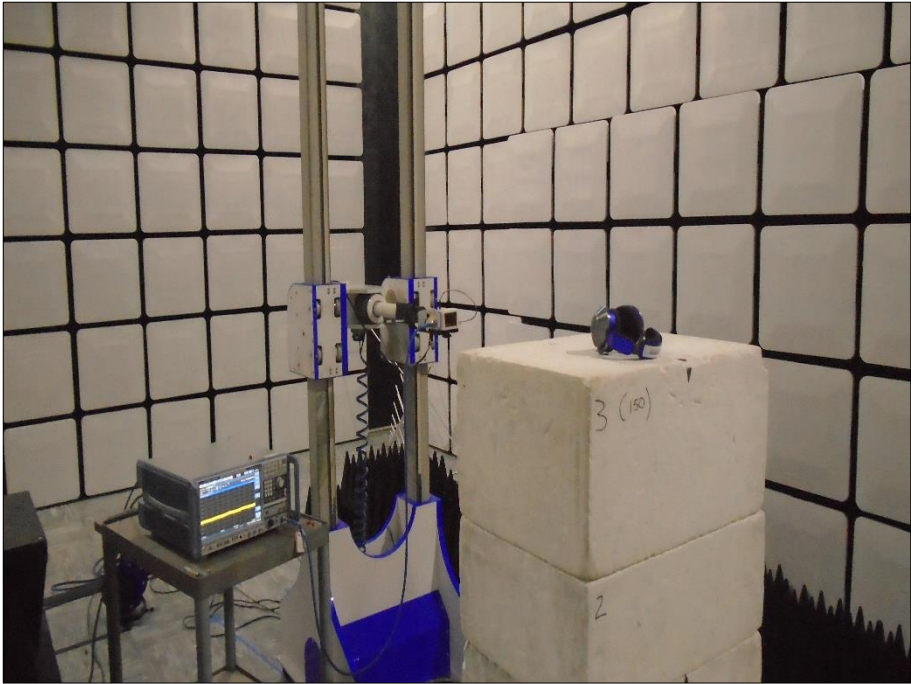

Figure 50 - Test Setup - 18 GHz to 25 GHz



4 Measurement Uncertainty

For a 95% confidence level, the measurement uncertainties for defined systems are:

Test Name	Measurement Uncertainty
Restricted Band Edges	30 MHz to 1 GHz: ± 5.2 dB 1 GHz to 40 GHz: ± 6.3 dB
Emission Bandwidth	± 25.35 kHz
Maximum Conducted Output Power	± 1.38 dB
Authorised Band Edges	30 MHz to 1 GHz: ± 5.2 dB 1 GHz to 40 GHz: ± 6.3 dB
Spurious Radiated Emissions	30 MHz to 1 GHz: ± 5.2 dB 1 GHz to 40 GHz: ± 6.3 dB
Power Spectral Density	± 1.49 dB

Table 44

Measurement Uncertainty Decision Rule – Accuracy Method

Determination of conformity with the specification limits is based on the decision rule according to IEC Guide 115:2021, Clause 4.4.3 (Procedure 2). The measurement results are directly compared with the test limit to determine conformance with the requirements of the standard.

Risk: The uncertainty of measurement about the measured result is negligible with regard to the final pass/fail decision. The measurement result can be directly compared with the test limit to determine conformance with the requirement (compare IEC Guide 115). The level of risk to falsely accept and falsely reject items is further described in ILAC-G8.