



TEST REPORT

Test Report No. : UL-RPT-RP11906202-1216C

Manufacturer : Dyson Technology Limited
Model No. : DBWIFIBLE01
FCC ID : QVHDBWIFIBLE01
Technology : WLAN (802.11 a/n)
Test Standard(s) : FCC Part 15.407(h)(2)

1. This test report shall not be reproduced in full or partial, without the written approval of UL VS LTD.
2. The results in this report apply only to the sample(s) tested.
3. The sample tested is in compliance with the above standard(s).
4. The test results in this report are traceable to the national or international standards.
5. Version 1.0

Date of Issue: 12 January 2018

Checked by:

Ben Mercer
Senior Test Engineer, Radio Laboratory

Company Signatory:

Sarah Williams
Senior Test Engineer, Radio Laboratory
UL VS LTD



This laboratory is accredited by UKAS.
The tests reported herein have been
performed in accordance with its terms
of accreditation.

UL VS LTD

Pavilion A, Ashwood Park, Ashwood Way, Basingstoke, Hampshire, RG23 8BG, UK
Telephone: +44 (0)1256 312000
Facsimile: +44 (0)1256 312001

This page has been left intentionally blank.

Table of Contents

1. Customer Information.....	4
2. Summary of Testing.....	5
2.1. General Information	5
2.2. Summary of Test Results	5
2.3. Methods and Procedures	5
2.4. Deviations from the Test Specification	5
3. Equipment Under Test (EUT)	6
3.1. Identification of Equipment Under Test (EUT)	6
3.2. Description of EUT	6
3.3. Modifications Incorporated in the EUT	6
3.4. Additional Information Related to Testing	6
3.5. Support Equipment	7
4. Operation and Monitoring of the EUT during Testing	8
4.1. Operating Modes	8
4.2. Configuration and Peripherals	9
5. Measurements, Examinations and Derived Results	13
5.1. General Comments	13
5.2. Test Results	14
5.2.1. Channel Closing Transmission Time and Channel Move Time	14
5.2.2. Non-occupancy Period	17
6. Measurement Uncertainty	20
7. Report Revision History	21
Appendix 1. Radar Calibration	22
Appendix 2. System Noise Floor Reference Plots.....	23
Appendix 3. Channel Loading.....	24

1. Customer Information





Company Name:	Dyson Technology Limited
Address:	Tetbury Hill Malmesbury Swindon SN16 0RP United Kingdom

2. Summary of Testing

2.1. General Information

Specification Reference:	47CFR15.407
Specification Title:	Code of Federal Regulations Volume 47 (Telecommunications): Part 15 Subpart E (Unlicensed National Information Infrastructure Devices) - Section 15.407
Location of Testing:	UL VS LTD, Unit 3 Horizon, Wade Road, Kingsland Business Park, Basingstoke, Hampshire, RG24 8AH, United Kingdom
Test Dates:	22 November 2017 to 23 November 2017

2.2. Summary of Test Results

FCC Reference (47CFR)	Measurement	Note	Result
Part 15.407(h)(2)(iii)	Channel Closing Transmission Time and Channel Move Time	-	
Part 15.407(h)(2)(iv)	Non Occupancy Period	2	
Key to Results			
 = Complied  = Did not comply			

Note(s):

1. The manufacturer confirms that the information regarding the parameters of the radar waveforms is not available to the end user.
2. This test is not required for a client without radar detection according to Tables 1 and 2 of KDB 905462 D02, however it was performed to show compliance with KDB 905462 D02 5.1.2 e) and KDB 905462 D03, section (b)(5) and (b)(6)

2.3. Methods and Procedures

Reference:	FCC KDB 905462 D02 UNII DFS Compliance Procedures New Rules v02 (April 08, 2016)
Title:	Compliance Measurement Procedures for Unlicensed-National Information Infrastructure Devices Operating in the 5250-5350 MHz and 5470-5725 MHz Bands Incorporating Dynamic Frequency Selection

2.4. Deviations from the Test Specification

For the measurements contained within this test report, there were no deviations from, additions to, or exclusions from the test specification identified above.

3. Equipment Under Test (EUT)

3.1. Identification of Equipment Under Test (EUT)

Brand Name:	Dyson
Model Name or Number:	DBWIFIBLE01
Serial Number:	26 <i>(Conducted sample)</i>
Hardware Version Number:	259866-01/05 (EB2.2)
Software Version Number:	MFG SDK 442.1
FCC ID:	QVHDBWIFIBLE01

3.2. Description of EUT

The equipment under test was a WLAN module operating in the 2.4 & 5 GHz bands.

3.3. Modifications Incorporated in the EUT

No modifications were applied to the EUT during testing.

3.4. Additional Information Related to Testing

Technology Tested:	Unlicensed National Information Infrastructure Devices (U-NII)	
Type of Unit:	Transceiver	
Modulation:	BPSK, QPSK, 16QAM & 64QAM	
Data Rates:	IEEE 802 11a	6 Mbps
	IEEE 802.11n HT20	MCS0 (1 spatial stream)
Power Supply Requirement(s):	Nominal	3.3 VDC
Transmit / Receive Frequency Range:	5470 to 5725 MHz	
Transmit / Receive Channels Tested at 20 MHz Bandwidth setting:	Channel ID	Channel Centre Frequency (MHz)
	100	5500

3.5. Support Equipment

The following support equipment was used to exercise the EUT during testing:

Description:	Wireless Dual Band Router (DFS Master)
Brand Name:	CISCO
Model Name or Number:	AIR CAP3702E-A-K9
Serial Number:	FJC1938F3G6
FCC ID:	LDK102087

Description:	Laptop PC
Brand Name:	Lenovo
Model Name or Number:	T420
Serial Number:	R8-VM66DE

4. Operation and Monitoring of the EUT during Testing

4.1. Operating Modes

The EUT was tested in the following operating modes, unless otherwise stated:

- Operating on the channel selected by the Master device in UNII Band 2C.
- The Master device controls the channel bandwidth and modulation of the EUT. The Master device was set to 802.11n / MCS0 with 20 MHz channel bandwidth.
- For the required channel loading of >17% in KDB 905642 D02 7.7 c), a UDP data transfer of 7 Mbit/s was performed between a Laptop PC connected to the DFS master router and the EUT. This gave a channel loading (duty cycle) of 56.78% at the modulation scheme and bandwidth above. See Appendix 3 Channel Loading for further details.

4.2. Configuration and Peripherals

The EUT was tested in the following configuration(s):

- The EUT is a DFS Client without Radar Detection capability. It was tested in combination with an FCC approved Cisco DFS enabled router (FCC ID: LDK102087) being used as the Master. A Radar Type 0 was injected to the Master to test the Clients Channel Move Time and Channel Closing Transmission Time after receiving the channel shutdown command from the Master.
- All measurements were made using a conducted link. The EUT has one external antenna port fitted for test purposes. System losses for the interconnecting hardware were measured and taken into consideration.
- The Radar test platform used was a SMBV100A Vector Signal Generator.
- The DFS detection threshold of -56.0 dBm (-62 + 1 dB + 5 dBi) was used at the Master device antenna port. Note this is not dependent on the EUT EIRP, Spectral Density or EUT Antenna Gain, only the antenna gain of the master device, as the EUT does not have radar detection. The Cisco DFS Master Test router was configured with an internal setting for a 5 dBi antenna.

KDB 905462 D02 Table 3: DFS Detection Thresholds for Master Devices and Client Devices With Radar Detection

Maximum Transmit Power	Value (See Notes)
EIRP ≥ 200 milliwatt	-64 dBm
EIRP < 200 milliwatt and power spectral density < 10 dBm/MHz	-62 dBm
EIRP < 200 milliwatt that do not meet the power spectral density requirement	-64 dBm
Note 1: This is the level at the input of the receiver assuming a 0 dBi receive antenna. Note 2: Throughout these test procedures an additional 1 dB has been added to the amplitude of the test transmission waveforms to account for variations in measurement equipment. This will ensure that the test signal is at or above the detection threshold level to trigger a DFS response. Note 3: EIRP is based on the highest antenna gain. For MIMO devices refer to KDB Publication 662911 D01.	

- The Master device used for test was set to 17 dBm / 50 mW with TPC enabled.
- Plots and data were captured using a Rohde and Schwarz FSV 30 Signal Analyser. The number of data points was increased to maximum and the trace data exported so it could be analysed in far greater detail than available on the built-in display.
- The Channel Move Time was the time taken from the end of the radar waveform to the time the Client ceased transmissions. The Channel Closing Transmission Time was calculated to the nearest sample from any additional pulses occurring >200 ms after the end of the radar.

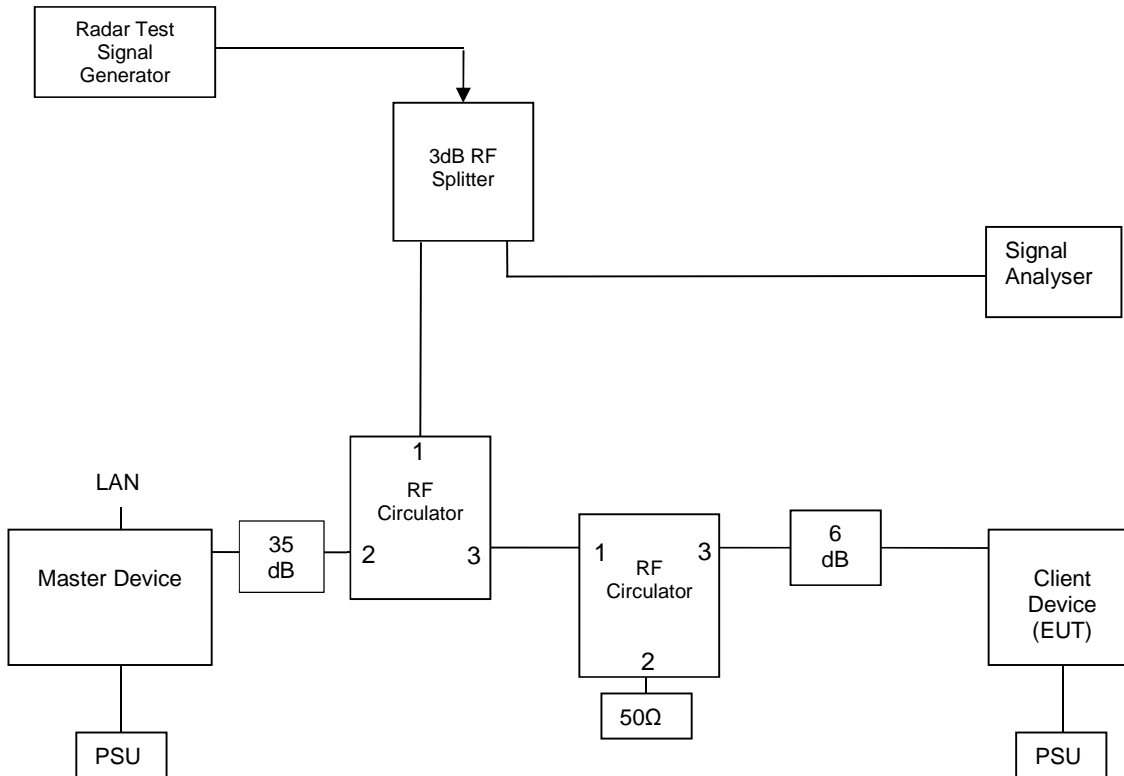
Setup diagram for test of DFS Client without Radar Detection:**Rationale**

The setup shown above ensures the waveforms indicated on the spectrum analyser are in order of magnitude. The circulators have typically 18 dB attenuation in the reverse direction. The left-hand circulator directs the radar towards the master, ensuring there is not an overly large radar pulse into the client (EUT) even though there is the same attenuation between the client and the radar generator. The radar signal should be approximately 26 dB smaller at the client antenna port than at the master. The right-hand circulator is to give the same path loss between master and client in both directions of the 802.11 communications link.

The Radar signal is most predominant on the spectrum analyser, coming straight through a 3 dB splitter. The client is 2nd largest, being attenuated by the 20 dB, and the (typically 18 dB) isolation from the directional splitter. The smallest signal is the master, being attenuated by 30 dB from the attenuator and approximately 18 dB from the left-hand circulator and 18 dB across the splitter.

The RF path from the radar generator to the DFS Master crosses no isolated ports of any splitters or circulators and any change of impedance in load between calibration and test is isolated from any circulators by 50 Ω attenuators which further minimises mismatch. This setup therefore meets the requirements of KDB 905462 D02 clause 7.2 points (A) and (B) whilst providing greater radar generator amplitude headroom and lower radar signal at the client.

Applicability of DFS requirements prior to use of a channel

Requirement	Operational Mode		
	Master	Client Without Radar Detection	Client With Radar Detection
<i>Non-Occupancy Period</i>	Yes	Not required	Yes
<i>DFS Detection Threshold</i>	Yes	Not required	Yes
<i>Channel Availability Check Time</i>	Yes	Not required	Not required
<i>Uniform Spreading</i>	Yes	Not required	Yes

Applicability of DFS requirements during normal operation

Requirement	Operational Mode	
	Master Device or Client with Radar Detection	Client Without Radar Detection
<i>DFS Detection Threshold</i>	Yes	Not required
<i>Channel Closing Transmission Time</i>	Yes	Yes
<i>Channel Move Time</i>	Yes	Yes
<i>U-NII Detection Bandwidth</i>	Yes	Not required

Additional requirements for devices with multiple bandwidth modes	Master Device or Client with Radar Detection	Client Without Radar Detection
<i>U-NII Detection Bandwidth and Statistical Performance Check</i>	All BW modes must be tested	Not required
<i>Channel Move Time and Channel Closing Transmission Time</i>	Test using widest BW mode available	Test using the widest BW mode available for the link
<i>All other tests</i>	Any single BW mode	Not required

Note: Frequencies selected for statistical performance check (Section 7.8.4) should include several frequencies within the radar detection bandwidth and frequencies near the edge of the radar detection bandwidth. For 802.11 devices it is suggested to select frequencies in each of the bonded 20 MHz channels and the channel center frequency.

Interference Threshold values, Master or Client incorporating In-Service Monitoring

Maximum Transmit Power	Value (see notes)
EIRP \geq 200 milliwatt	-64 dBm
EIRP < 200 milliwatt and power spectral density < 10 dBm/MHz	-62 dBm
EIRP < 200 milliwatt that do not meet the power spectral density requirement	-64 dBm

Note 1: This is the level at the input of the receiver assuming a 0 dBi receive antenna

Note 2: Throughout these test procedures an additional 1dB has been added to the amplitude of the test transmission waveforms to account for variations in measurement equipment. This will ensure that the test signal is at or above the detection threshold level to trigger a DFS response.

Note 3: EIRP is based on the highest antenna gain. For MIMO devices refer to KDB Publication 662911 D01.

DFS Response requirement values

Parameter	Value
<i>Non-occupancy period</i>	Minimum 30 minutes
<i>Channel Availability Check Time</i>	60 seconds
<i>Channel Move Time</i>	10 seconds See Note 1.
<i>Channel Closing Transmission Time</i>	200 milliseconds + an aggregate of 60 milliseconds over remaining 10 second period. See Notes 1 and 2.
<i>U-NII Detection Bandwidth</i>	Minimum 100% of the U-NII 99% transmission power bandwidth. See Note 3.

Note 1: *Channel Move Time* and the *Channel Closing Transmission Time* should be performed with Radar Type 0. The measurement timing begins at the end of the Radar Type 0 burst.

Note 2: The *Channel Closing Transmission Time* is comprised of 200 milliseconds starting at the beginning of the *Channel Move Time* plus any additional intermittent control signals required to facilitate a *Channel* move (an aggregate of 60 milliseconds) during the remainder of the 10 second period. The aggregate duration of control signals will not count quiet periods in between transmissions.

Note 3: During the *U-NII Detection Bandwidth* detection test, radar type 0 should be used. For each frequency step the minimum percentage of detection is 90 percent. Measurements are performed with no data traffic.

Short Pulse Radar Test Waveforms

Radar Type	Pulse Width (Microseconds)	PRI (Microseconds)	Pulses	Minimum Percentage of Successful Detection	Minimum Trials
0	1	1428	18	See Note 1	See Note 1

Note 1: should be used for the detection bandwidth test, channel move time and channel closing time tests.

5. Measurements, Examinations and Derived Results

5.1. General Comments

Measurement uncertainties are evaluated in accordance with current best practice. Our reported expanded uncertainties are based on standard uncertainties, which are multiplied by an appropriate coverage factor to provide a statistical confidence level of approximately 95%. Please refer to *Section 6 Measurement Uncertainty* for details.

In accordance with UKAS requirements all the measurement equipment is on a calibration schedule. All equipment was within the calibration period on the date of testing.

5.2. Test Results**5.2.1. Channel Closing Transmission Time and Channel Move Time****Test Summary:**

Test Engineer:	Max Passell	Test Dates:	22 November 2017 & 23 November 2017
Test Sample Serial Number:	26		

FCC Reference:	Part 15.407(h)(2)(iii)
Test Method Used:	KDB 905462 D02 Section 7.8.3

Environmental Conditions:

Temperature (°C):	23 to 24
Relative Humidity (%):	52

Note(s):

1. The channel move time is the time taken from the end of the radar burst to the ceasing of transmissions of the EUT.
2. The Total Aggregate Channel Closing Transmission Time shown in the table below was measured from 200 ms after the end of the radar burst and compared to the 60 ms limit.

Results:

Channel Frequency (MHz)	Channel Move Time (ms)	Limit (ms)	Margin (ms)	Result
5500	87.3125	10000	9912.6875	Complied

Channel Frequency (MHz)	Total Aggregate Channel Closing Time after first 200 ms (ms)	Limit (ms)	Margin (ms)	Result
5500	0.0	60	60.0	Complied

Radar burst type 0 was detected and channel move occurred.

Channel Closing Transmission Time and Channel Move Time (continued)

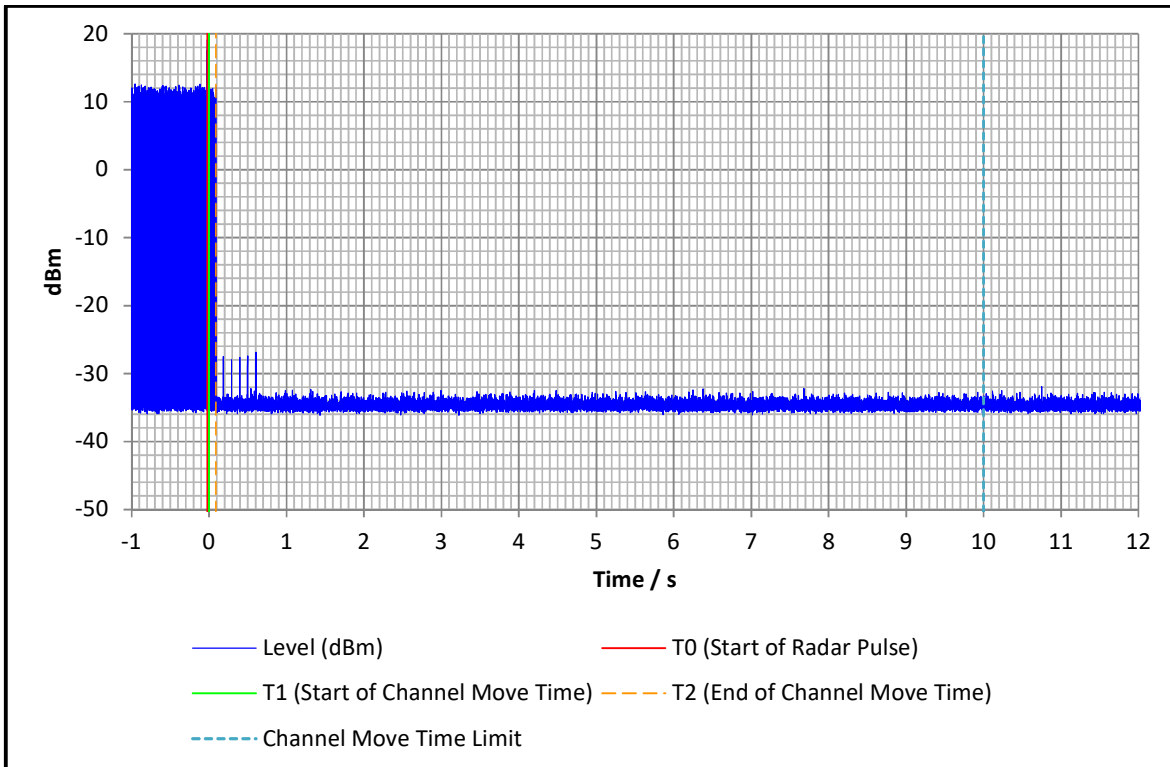

Channel Move Time 5500 MHz – Short Radar (Type 0) – Full 10 seconds

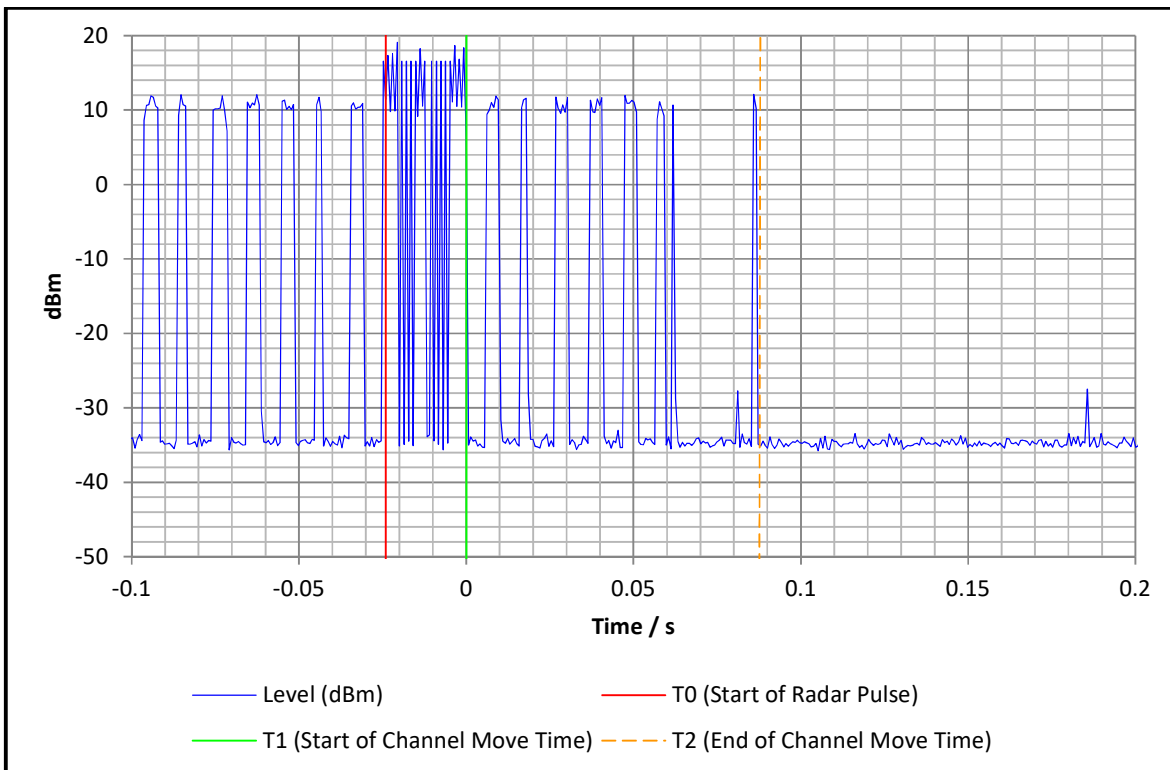

Channel Move Time 5500 MHz – Short Radar (Type 0) – Zoomed Plot

Channel Closing Transmission Time and Channel Move Time (continued)**Limits:****Part 15.407(h)(2)(iii)**

After a radar's presence is detected, all transmissions shall cease on the operating channel within 10 seconds. Transmissions during this period shall consist of normal traffic for a maximum of 200 ms after detection of the radar signal. In addition, intermittent management and control signals can be sent during the remaining time to facilitate vacating the operating channel.

KDB 905462 D02 Table 4: DFS Response Requirement Values

Parameter	Value
<i>Channel Move Time</i>	10 seconds See Note 1.
<i>Channel Closing Transmission Time</i>	200 milliseconds + an aggregate of 60 milliseconds over remaining 10 second period. See Notes 1 and 2.
<p>Note 1: <i>Channel Move Time</i> and the <i>Channel Closing Transmission Time</i> should be performed with Radar Type 0. The measurement timing begins at the end of the Radar Type 0 burst.</p> <p>Note 2: The <i>Channel Closing Transmission Time</i> is comprised of 200 milliseconds starting at the beginning of the <i>Channel Move Time</i> plus any additional intermittent control signals required to facilitate a <i>Channel</i> move (an aggregate of 60 milliseconds) during the remainder of the 10 second period. The aggregate duration of control signals will not count quiet periods in between transmissions.</p>	

Test Equipment Used:

Asset No.	Instrument	Manufacturer	Type No.	Serial No.	Date Calibration Due	Cal. Interval (Months)
M2001	Thermohygrometer	Testo	608-H1	45041824	22 Feb 2018	12
G0615	Vector Signal Generator	Rohde & Schwarz	SMBV100A	260473	08 May 2020	36
M1883	Signal Analyser	Rohde & Schwarz	FSV30	103084	02 May 2018	12
A030	Step Attenuator	Narda	745-69	01544	Calibrated before use	-
A1535	Step Attenuator	Hewlett Packard	8495B/8494B	00007	Calibrated before use	-
A2120	Power Splitter	Mini-Circuits	ZN2PD-63-S+	SUU12701 203	Calibrated before use	-
A2180	Coaxial Circulator	AtlanTecRF	ACC-20130-SF-SF-SF	12409233	Calibrated before use	-
A2182	Coaxial Circulator	AtlanTecRF	ACC-20130-SF-SF-SF	120409231	Calibrated before use	-
S0538	Power Supply Unit	Thurlby Thandar	PL154	250135	Calibrated before use	-
M1269	Multimeter	Fluke	179	90250210	02 May 2018	12

5.2.2. Non-occupancy Period**Test Summary:**

Test Engineer:	Max Passell	Test Dates:	22 November 2017 & 23 November 2017
Test Sample Serial Number:	26		

FCC Reference:	Part 15.407(h)(2)(iv)
Test Method Used:	KDB 905462 D02 Section 7.8.3

Environmental Conditions:

Temperature (°C):	23 to 24
Relative Humidity (%):	52

Notes:

1. This test is not required for a client without radar detection according to Tables 1 and 2 of KDB 905462 D02, however it was performed to show compliance with KDB 905462 D02 5.1.2 e) and KDB 905462 D03, section (b)(6). Therefore no specified bandwidth requirement is given and so was performed using an 20 MHz channel bandwidth; as used for *Channel Closing Transmission Time and Channel Move Time*.
2. Radar burst type 0 was detected and the channel was vacated for >1800 seconds. Since the client has no radar detection and is therefore not performing an 'intelligent' blacklisting of the channel, the device was shown not to transmit for greater than 30 minutes after its own shutdown time, not the shutdown of the DFS master.
3. The noise floor remains below the -27 dBm/MHz spurious limit for the 30 minute (1800 second) non-occupancy period. Therefore the EUT is deemed to comply.

Non-occupancy Period (continued)

Results:

Channel (MHz)	Trial	Non-Occ (min)	Limit (min)	Margin (min)	Result
5500	1	>34.5	30	>4.5	Complied

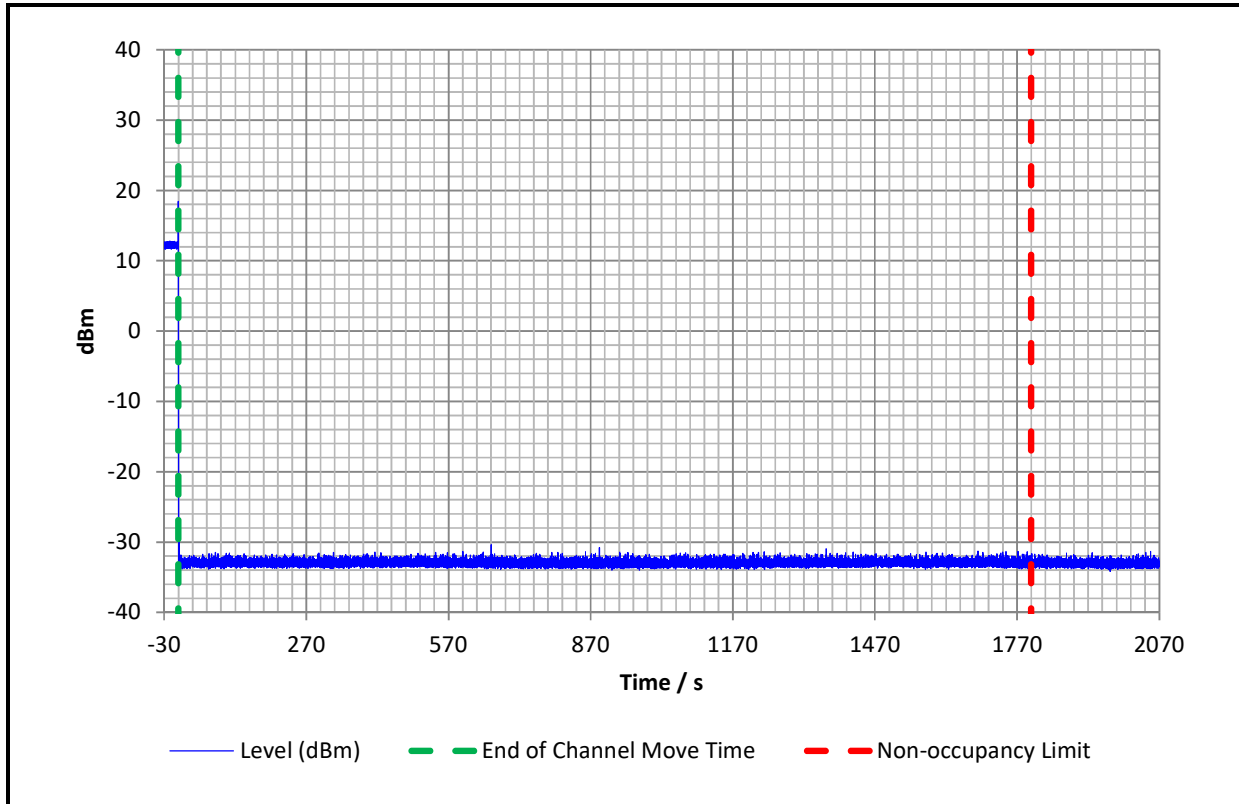

Limits:

Part 15.407(h)(2)(iv)

A channel that has been flagged as containing a radar system, either by a channel availability check or in-service monitoring, is subject to a non-occupancy period of at least 30 minutes. The non-occupancy period starts at the time when the radar system is detected.

KDB 905462 D02 Table 4: DFS Response Requirement Values

Parameter	Value
Non-occupancy period	Minimum 30 minutes

Non-occupancy Period (continued)**Test Equipment Used:**

Asset No.	Instrument	Manufacturer	Type No.	Serial No.	Date Calibration Due	Cal. Interval (Months)
M2001	Thermohygrometer	Testo	608-H1	45041824	22 Feb 2018	12
G0615	Vector Signal Generator	Rohde & Schwarz	SMBV100A	260473	08 May 2020	36
M1883	Signal Analyser	Rohde & Schwarz	FSV30	103084	02 May 2018	12
A030	Step Attenuator	Narda	745-69	01544	Calibrated before use	-
A1535	Step Attenuator	Hewlett Packard	8495B/8494B	00007	Calibrated before use	-
A2120	Power Splitter	Mini-Circuits	ZN2PD-63-S+	SUU12701 203	Calibrated before use	-
A2180	Coaxial Circulator	AtlanTecRF	ACC-20130-SF-SF-SF	12409233	Calibrated before use	-
A2182	Coaxial Circulator	AtlanTecRF	ACC-20130-SF-SF-SF	120409231	Calibrated before use	-
S0538	Power Supply Unit	Thurlby Thandar	PL154	250135	Calibrated before use	-
M1269	Multimeter	Fluke	179	90250210	02 May 2018	12

6. Measurement Uncertainty

No measurement or test can ever be perfect and the imperfections give rise to error of measurement in the results. Consequently the result of a measurement is only an approximation to the value of the measurand (the specific quantity subject to measurement) and is only complete when accompanied by a statement of the uncertainty of the approximation.

The expression of uncertainty of a measurement result allows realistic comparison of results with reference values and limits given in specifications and standards.

The uncertainty of the result may need to be taken into account when interpreting the measurement results.

The reported expanded uncertainties below are based on a standard uncertainty multiplied by an appropriate coverage factor such that a confidence level of approximately 95% is maintained. For the purposes of this document "approximately" is interpreted as meaning "effectively" or "for most practical purposes".

Measurement Type	Range	Confidence Level (%)	Calculated Uncertainty
DFS Radar Amplitude	5.15 GHz to 5.825 GHz	95%	±2.17 dB
Channel Shutdown Timing	5.15 GHz to 5.825 GHz	95%	±0.45 ms
Non-Occupancy Timing	5.15 GHz to 5.825 GHz	95%	±79.25 ms

The methods used to calculate the above uncertainties are in line with those recommended within the various measurement specifications. Where measurement specifications do not include guidelines for the evaluation of measurement uncertainty the published guidance of the appropriate accreditation body is followed.

7. Report Revision History

Version Number	Revision Details		
	Page No(s)	Clause	Details
1.0	-	-	Initial Version

Appendix 1. Radar Calibration

Radar calibration procedure.

The system was configured as shown in section 4.2, but with the signal analyser port terminated into a 50Ω load, and a signal analyser connected to the master port. The radar was then replayed by the SMBV100A Vector Signal Generator, the waveform captured, and the amplitude adjusted until correct.

Due to the difficulty of measuring the 1 μs burst accurately across the duration of a radar pulse sequence the output of the Radar generator with both CW and test Radars has been correlated. The test network loss is then calibrated using a CW signal from the radar generator, and an offset put into the radar generation software. All radars are then generated at the correct level at the Master device antenna port.

Below is an example plot of the type 0 radar burst at the DFS master port of the attenuation network. The SMBV100A Vector Signal Generator was set to -56.0 dBm output and the correct path loss offset applied.

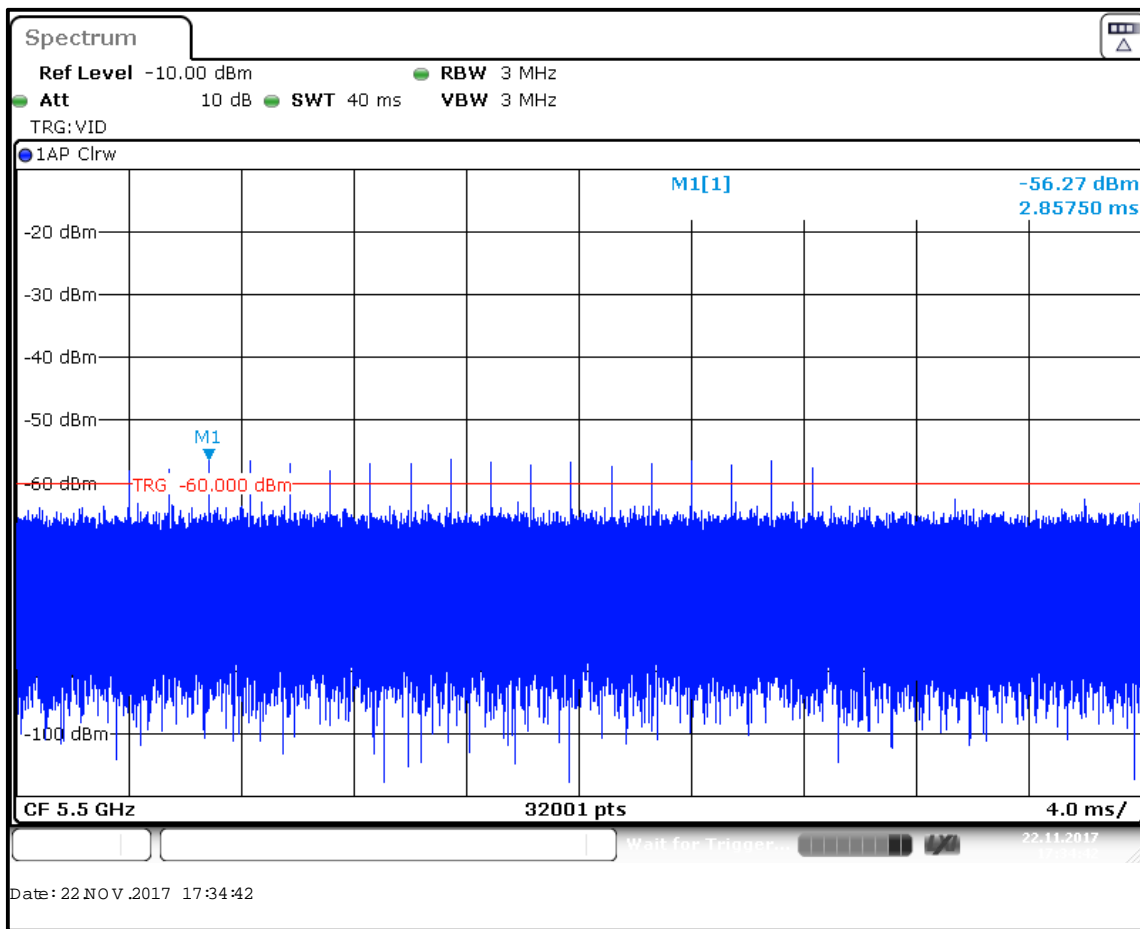

Type 0 Radar

Appendix 2. System Noise Floor Reference Plots

As required by Section 8.3 d)3) and 8.3 g) of KDB 905462 D02, the following plot shows the reference noise floor of the system used during measurement. It also shows compliance with Section 8.3.7 of KDB 905462 D02 when the path loss of the coupling network shown in Section 4.2 *Configuration and Peripherals* is added to the noise floor.

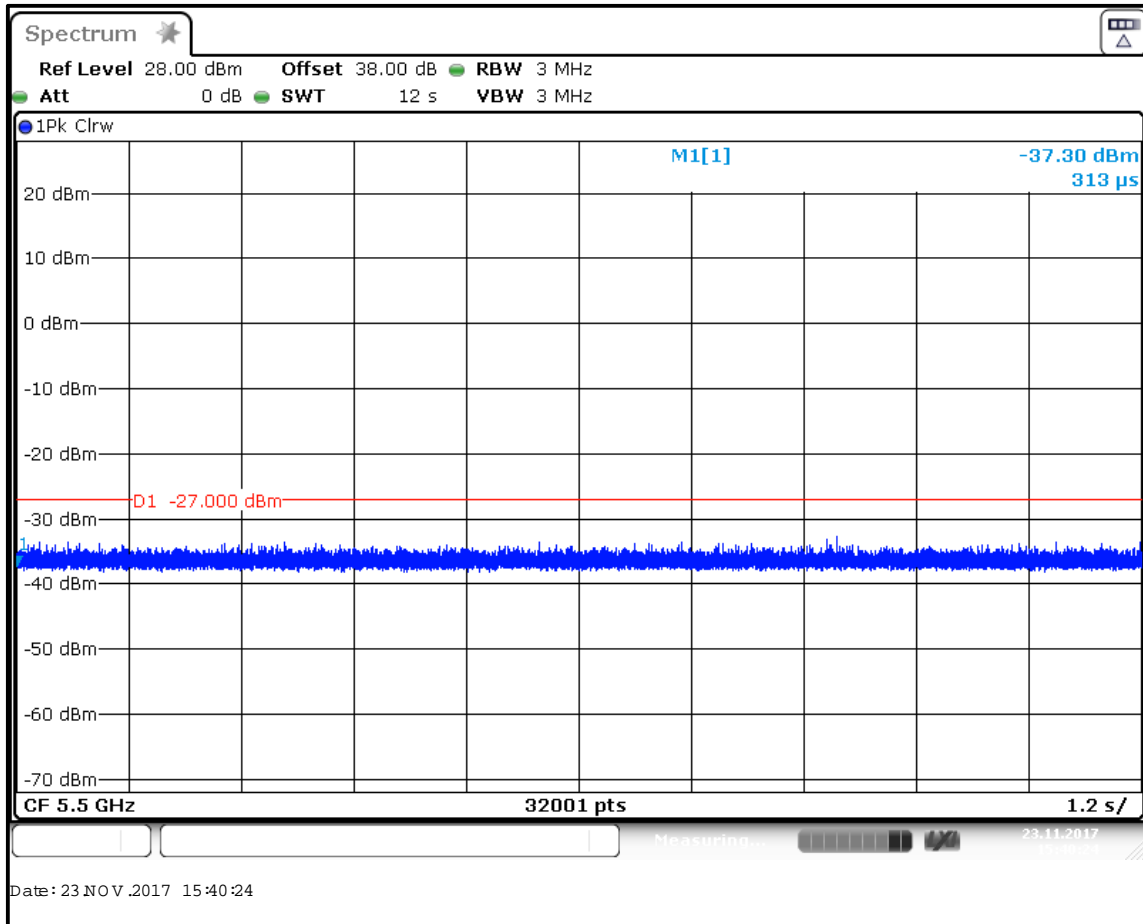

Noise Floor of Spectrum Analyser

Appendix 3. Channel Loading

As required by Section 8.3. 3 f) of KDB 605642 D02, the following plot and calculations shows the duty cycle of the channel used during testing.

Streaming representative file types as defined in Section 7.7 a) of KDB 905462 D02, were found not to produce a high enough duty cycle of >17%, as required by 7.7 c), on a 20 MHz channel bandwidth. This included lowest data rate with modulation coding scheme MCS0, maximum video size (1080p) and the minimum video compression ratio during encoding. Therefore alternative pseudo-random data transfer as per 7.7 b) was streamed to simulate data transfer. A suitable duty cycle was obtained with the link using MCS0 and a throughput-limited file transfer.

The duty cycle was calculated over 100 milliseconds. This was captured on a spectrum analyser in the time domain using a 0 Hz span and 32000 sweep points to ensure it included any longer term variations whilst maintaining accurate to a 3.125 µs sample size.

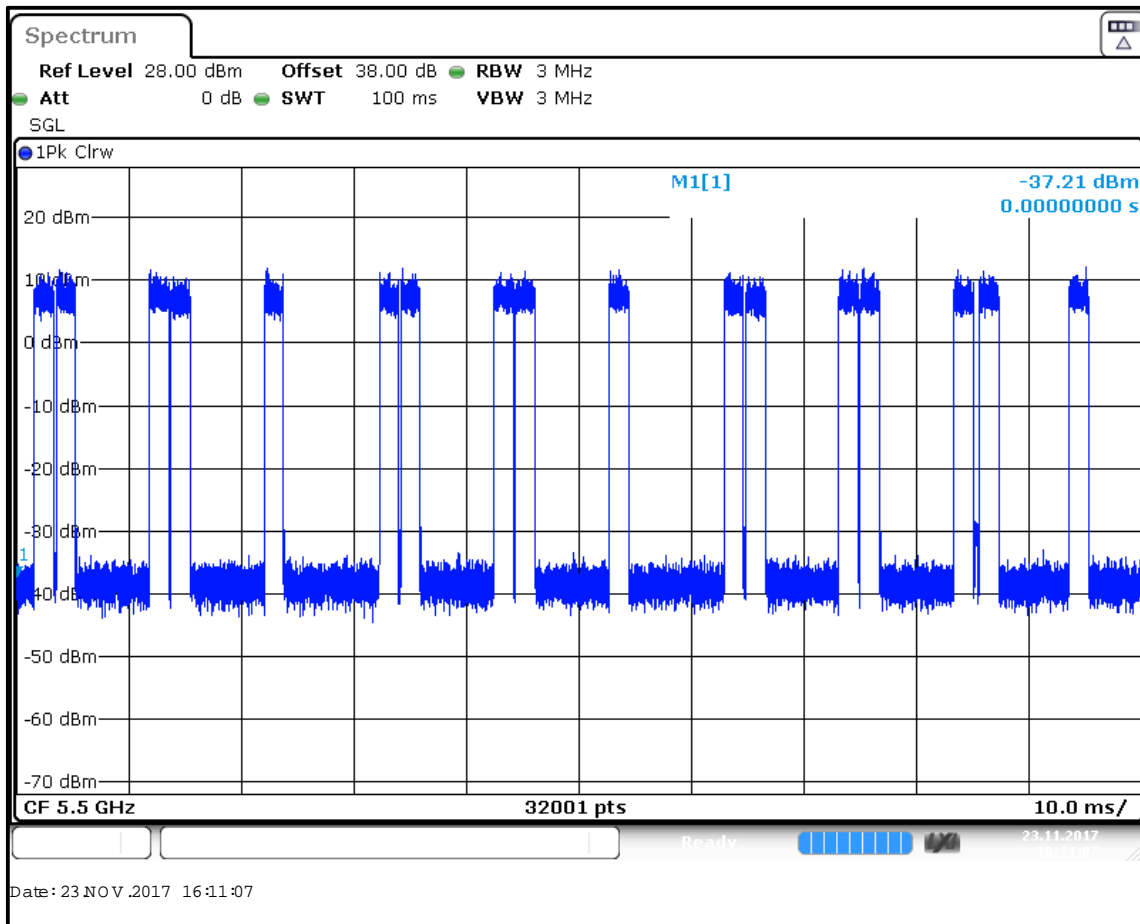

The number of samples greater than -30 dBm was compared to the total number of samples to calculate the duty cycle. The EUT and test router were found to be transmitting above this threshold for 56.78% of the total, and hence meeting the requirement of greater than 17 % channel loading.

--- END OF REPORT ---