

FCC PART 15.247

INDUSTRY CANADA RSS-210, ISSUE 7, JUNE 2007



TEST AND MEASUREMENT REPORT

For

Load Systems International, Inc.

4495 Blvd Hamel, Suite 110, Quebec, QC, Canada, G1P 2J7

FCC ID: QVBGS200
IC: 7076A-ICGS200

Report Type: Original Report	Product Type: Radio Receiver Module
Test Engineers: Jack Liu	
Report Number: R0904281	
Report Date: 2009-06-08	
Reviewed By: Victor Zhang Test Engineer	
Prepared By: (84)	Bay Area Compliance Laboratories Corp. 1274 Anvilwood Ave Sunnyvale, CA 94089, USA Tel: (408) 732-9162 Fax: (408) 732 9164

Note: This test report is prepared for the customer shown above and for the device described herein. It may not be duplicated or used in part without prior written consent from Bay Area Compliance Laboratories Corp. This report **must not** be used by the customer to claim product certification, approval, or endorsement by NVLAP*, NIST, or any agency of the Federal Government.

* This report may contain data that are not covered by the NVLAP accreditation and are marked with an asterisk "*" ...

TABLE OF CONTENTS

1	General Information.....	5
1.1	Product Description for Equipment under Test (EUT)	5
1.2	Mechanical Description of EUT	5
1.3	EUT Photo.....	5
1.4	Objective	6
1.5	Related Submittal(s)/Grant(s)	6
1.6	Test Methodology	6
1.7	Measurement Uncertainty	6
1.8	Test Facility.....	7
2	System Test Configuration.....	8
2.1	Justification	8
2.2	EUT Exercise Software.....	8
2.3	Special Accessories	8
2.4	Equipment Modifications.....	8
2.5	Internal Parts List and Details	8
2.6	Interface Ports and Cabling.....	8
2.7	Test Setup Block Diagrams.....	9
3	Summary of Test Results.....	10
4	FCC §15.203 & IC RSS-GEN § 7.1.4 - Antenna Requirement	11
4.1	Applicable Standard	11
4.2	Antenna Photo.....	11
4.3	Results.....	11
5	§15.207 & IC RSS-GEN § 7.2.2- Conducted Emissions.....	12
5.1	Applicable Standard	12
5.2	Test Setup.....	12
5.3	Test Procedure.....	12
5.4	Summary of Test Results	12
6	FCC §15.247(a) (2) & RSS-210 § A8.2 (a) – 6 dB Occupied Bandwidth	13
6.1	Applicable Standard	13
6.2	Measurement Procedure.....	13
6.3	Test Equipment List and Details	13
6.4	Environmental Conditions	13
6.5	Summary of Test Results	13
7	FCC §15.247(b) & RSS210 § A8.4 - Peak Output Power	16
7.1	Applicable Standard.....	16
7.2	Measurement Procedure.....	16
7.3	Test Equipment List and Details	16
7.4	Environmental Conditions	16
7.5	Summary of Test Results	17
8	FCC §15.247(d) & RSS-210 § A8.5 – Out of Band Emissions.....	18
8.1	Applicable Standard	18
8.2	Measurement Procedure.....	18
8.3	Test Equipment List and Details	18
8.4	Environmental Conditions	18
9	FCC §15.247(e) & RSS-210 § A8.2 (b) - Power Spectral Density	25
9.1	Applicable Standard.....	25
9.2	Measurement Procedure.....	25

9.3	Test Equipment List and Details	25
9.4	Environmental Conditions	25
9.5	Summary of Test Results	26
10	FCC §15.205, §15.209 & §15.247(c) & IC RSS-Gen §4.9 - Spurious Radiated Emissions	28
10.1	Applicable Standard	28
10.2	Test Setup.....	29
10.3	EUT Setup.....	29
10.4	Test Procedure.....	29
10.5	Corrected Amplitude & Margin Calculation.....	30
10.6	Test Equipment List and Details	30
10.7	Environmental Conditions	30
10.8	Summary of Test Results	31
10.9	Radiated Emissions Test Plot & Data	32
11	RSS-210 § 2.6 Receiver Spurious Radiated Emissions	36
11.1	Applicable Standard	36
11.2	Test Setup.....	36
11.3	Test Procedure.....	37
11.4	Corrected Amplitude & Margin Calculation.....	37
11.5	Test Equipment List and Details	37
11.6	Environmental Conditions	37
11.7	Summary of Test Results	38
11.8	Radiated Emissions Test Plots and Data	39
12	§15.247 (i), § 2.1091 & RSS-102 - RF Exposure.....	40
12.1	Applicable Standard	40
12.2	MPE Prediction.....	41
12.3	Test Result.....	41
13	Exhibit A – FCC & IC Equipment Labeling Requirements.....	42
13.1	FCC ID Label Requirements.....	42
13.2	IC Label Requirements	42
13.3	FCC ID & IC Label.....	43
13.4	FCC ID and IC Label Location	43
14	Exhibit B - Test Setup Photographs.....	44
14.1	Radiated Emissions – Front View (Below 1 GHz)	44
14.2	Radiated Emissions – Rear View (Below 1 GHz).....	44
14.3	Radiated Emissions – Front View (Above 1 GHz).....	45
14.4	Radiated Emissions – Rear View (Above 1 GHz)	45
14.5	Antenna Port Conducted Measurement.....	46
15	Exhibit C - EUT Photographs	47
15.1	EUT - Front Side View	47
15.2	EUT - Back Side View.....	47
15.3	EUT - Cover off View.....	48
15.4	EUT – PCB Assembly Top View	48
15.5	EUT – PCB Assembly Bottom View	49
15.6	EUT – Antenna View.....	49

DOCUMENT REVISION HISTORY

Revision Number	Report Number	Description of Revision	Date of Revision
0	R0904281	Original	2009-06-08

1 General Information

1.1 Product Description for Equipment under Test (EUT)

The *Load Systems International, Inc.* product, *FCC ID: QVBGS200, IC: 7076A-ICGS200, model: GS200* or the “EUT” as referred to this report is a Radio Receiver Module that operates in the frequency range 903 MHz~927 MHz.

1.2 Mechanical Description of EUT

The *EUT* measures approximately 150mm (L) x 120 mm (W) x 59 mm (H), weighing approximately 834 g.
* *The test data gathered are from typical production sample, serial number: R0904281-1, Sample ID: 72339, provided by BAACL.*

1.3 EUT Photo



Please refer to Exhibit C for addition EUT photographs.

1.4 Objective

This report is prepared on behalf of *Load Systems International, Inc.* in accordance with Part 2, Subpart J, Part 15, Subparts A, B and C of the Federal Communication Commissions rules and Industry Canada RSS-210 Issue 7, June 2007.

The objective is to determine compliance with FCC and IC standards, rules and limits for this device including:

- RF Exposure
- Antenna Requirement
- Conducted Emissions
- Spurious Emissions at Antenna Port
- Radiated Spurious Emissions
- Restricted Band
- Receiver Spurious Emissions
- 6 dB Bandwidth & 99% Bandwidth
- Maximum Peak Output Power
- 100 kHz Bandwidth of Frequency Band Edge
- Power Spectral Density

1.5 Related Submittal(s)/Grant(s)

No related submittals.

1.6 Test Methodology

All measurements contained in this report were conducted in accordance with ANSI C63.4-2003, American National Standard for Methods of Measurement of Radio-Noise Emissions from Low-Voltage Electrical and Electronic Equipment in the range of 9 kHz to 40 GHz.

1.7 Measurement Uncertainty

All measurements involve certain levels of uncertainties, especially in field of EMC. The factors contributing to uncertainties are spectrum analyzer, cable loss, antenna factor calibration, antenna directivity, antenna factor variation with height, antenna phase center variation, antenna factor frequency interpolation, measurement distance variation, site imperfections, mismatch (average), and system repeatability.

Based on NIS 81, The Treatment of Uncertainty in EMC Measurements, the values range from ± 2.0 for Conducted Emissions tests and ± 4.0 dB for Radiated Emissions tests are the most accurate estimates pertaining to uncertainty of EMC measurements at BACL.

Detailed instrumentation measurement uncertainties can be found in BACL report QAP-018.

All radiated and conducted emissions measurement was performed at Bay Area Compliance Laboratory, Corp. The radiated testing was performed at an antenna-to-EUT distance of 3 meters.

1.8 Test Facility

The test site used by BACL Corp. to collect radiated and conducted emissions measurement data is located at its facility in Sunnyvale, California, USA.

The test sites at BACL have been fully described in reports submitted to the Federal Communication Commission (FCC) and Voluntary Control Council for Interference (VCCI). The details of these reports has been found to be in compliance with the requirements of Section 2.948 of the FCC Rules on February 11 and December 10, 1997 and Article 8 of the VCCI regulations on December 25, 1997. The facility also complies with the radiated and AC line conducted test site criteria set forth in ANSI C63.4-2003.

The Federal Communications Commission, Industry Canada, and Voluntary Control Council for Interference has the reports on file and is listed under FCC registration number: 90464, IC registration number: 3062A, and VCCI Registration Number: C-2463 and R-2698. The test site has been approved by the FCC, IC, and VCCI for public use and is listed in the FCC Public Access Link (PAL) database.

Additionally, BACL is a National Institute of Standards and Technology (NIST) accredited laboratory, under the National Voluntary Laboratory Accredited Program (Lab Code 200167-0). The current scope of accreditations can be found at <http://ts.nist.gov/Standards/scopes/2001670.htm>

2 System Test Configuration

2.1 Justification

The host system was configured for testing according to ANSI C63.4-2003.

The EUT was tested in the testing mode to represent *worst*-case results during the final qualification test.

2.2 EUT Exercise Software

The EUT is programmed to transmit a specific signal for a specific length of time during testing. Test frequencies are as follows:

Channel	Low CH	Middle CH	High CH
Frequency	903 MHz	915 MHz	927 MHz

2.3 Special Accessories

There were no special accessories were required, included, or intended for use with EUT during these tests.

2.4 Equipment Modifications

No modifications were made to the EUT.

2.5 Internal Parts List and Details

Manufacturer	Description	Model	Serial Number
Load System International Inc.	Main board	UB0035-PCB0025B	-

2.6 Interface Ports and Cabling

Cable Description	Length (cm)	From	To
Data cable	<150cm	EUT	CAN Network
USB cable	<150cm	EUT	Laptop
DC Power Cable	< 450cm	EUT	DC Power Source

2.7 Test Setup Block Diagrams

Radiated Emission

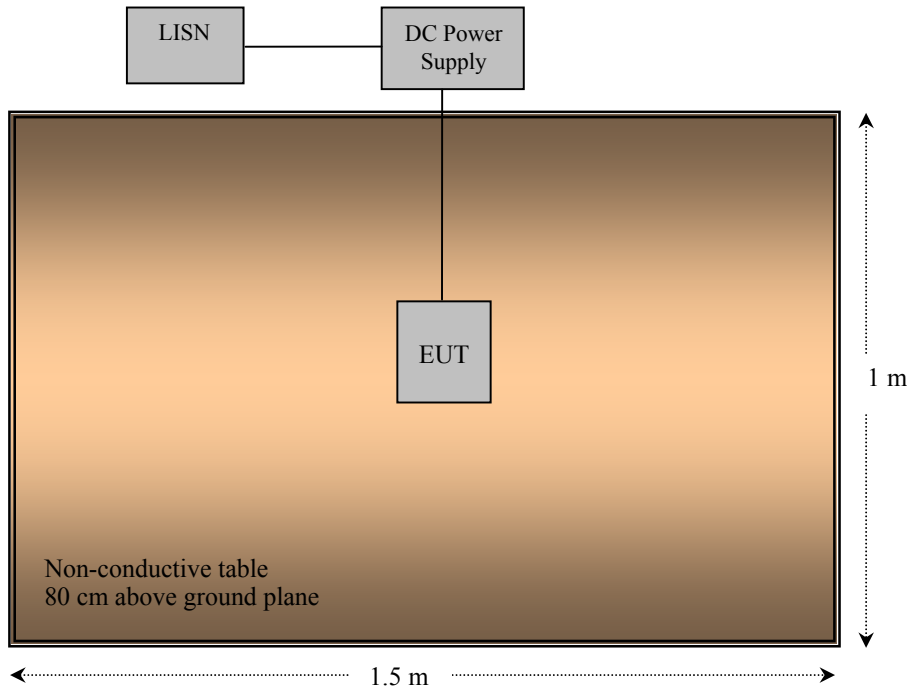

Conducted Measurement at Antenna Port

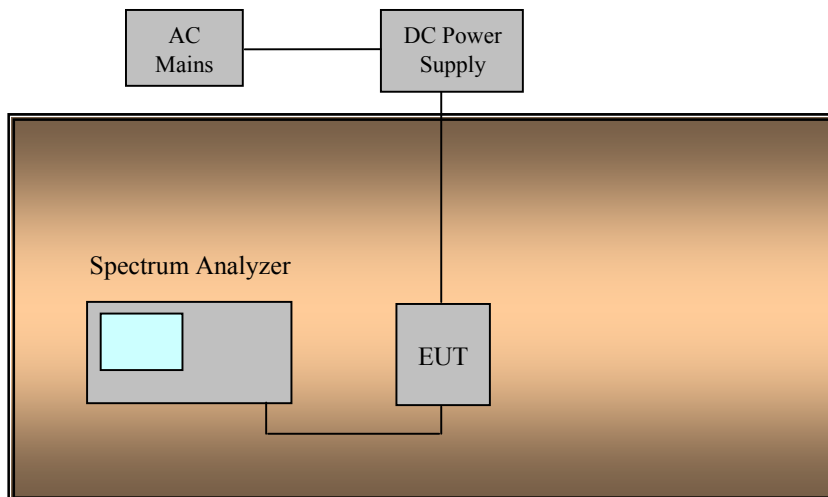

3 Summary of Test Results

Results reported relate only to the product tested.

FCC Part 15C & RSS-210/RSS-Gen Rules	Description of Test	Result
FCC §15.203 RSS-Gen §7.1.4	Antenna Requirement	Compliant
FCC § 15.207 (a) RSS-Gen §7.2.2	Conducted Emissions	N/A *
FCC §15.247 (a)(2) RSS-210 §A8.2 (a)	6 dB Bandwidth & 99% Bandwidth	Compliant
FCC §15.247 (b)(3) RSS210 § A8.4	Maximum Peak Output Power	Compliant
FCC § 15.247 (d) RSS210 § A8.5	Out of Band Emissions	Compliant
FCC §15.247 (e) RSS-210 §A8.2 (b)	Power Spectral Density	Compliant
FCC §15.205, §15.209 & §15.247(c) IC RSS-Gen §4.9	Radiated Spurious Emissions	Compliant
FCC §15.205 RSS-210 § 2.6	Restricted Band	Compliant
RSS-210 § 2.6 RSS-Gen § 6	Receiver Spurious Emissions	Compliant
FCC§15.247 (i), §2.1091 RSS-102	RF Exposure	Compliant

Note: * EUT is powered by DC voltage source

4 FCC §15.203 & IC RSS-GEN § 7.1.4 - Antenna Requirement

4.1 Applicable Standard

For intentional device, according to FCC Part §15.203, an intentional radiator shall be designed to ensure that no antenna other than that furnished by the responsible party shall be used.

Per IC RSS-Gen §7.1.4, A transmitter can only be sold or operated with antennas with which it was certified. A transmitter maybe certified with multiple antenna types. An antenna type comprises antennas having similar in-band and out-of-band radiation patterns. Testing shall be performed using the highest-gain antenna of each combination of transmitter and antenna type for which certification is being sought, with the transmitter output power set at the maximum level. Any antenna of the same type and having equal or lesser gain as an antenna that had been successfully tested for certification with the transmitter, will also be considered certified with the transmitter, and may be used and marketed with the transmitter. The manufacturer shall include with the application for certification a list of acceptable antenna types to be used with the transmitter.

When a measurement at the antenna connector is used to determine RF output power, the effective gain of the device's antenna shall be stated, based on measurement or on data from the antenna manufacturer. Any antenna gain in excess of 6 dBi (6 dB above isotropic gain) shall be added to the measured RF output power before using the power limits specified in IC RSS-210 or RSS-310 for devices of RF output powers of 10 milliwatts or less. For devices of output powers greater than 10 milliwatts, except devices subject to IC RSS-210 Annex 8 or RSS-210 Annex 9, the total antenna gain shall be added to the measured RF output power before using the specified power limits. For devices subject to IC RSS-210 Annex 8 or Annex 9, the antenna gain shall not be added.

4.2 Antenna Photo

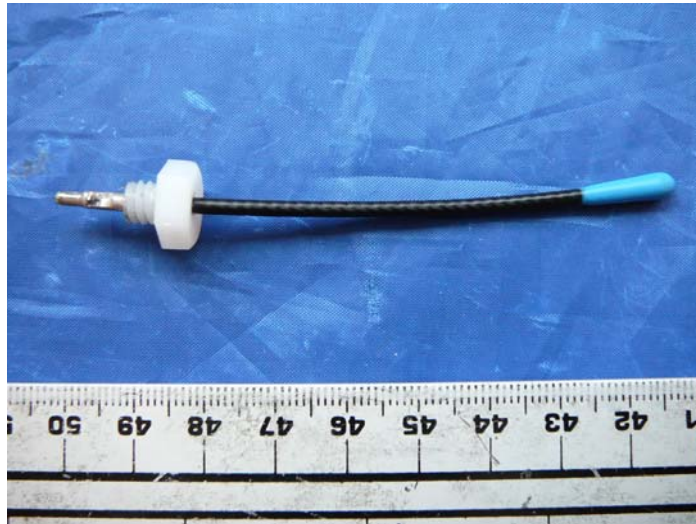

4.3 Results

The EUT has 1/4wave monopole integrate antenna and maximum gain of 0.5dBi, which in accordance to sections FCC Part 15.203 and IC RSS-Gen §7.1.4, is considered sufficient to comply with the provisions of these sections.

5 §15.207 & IC RSS-GEN § 7.2.2- Conducted Emissions

5.1 Applicable Standard

FCC Part 15.207 Conducted limits:

For an intentional radiator that is designed to be connected to the public utility (AC) power line, the radio frequency voltage that is conducted back onto the AC power line on any frequency or frequencies within the band 150 kHz to 30 MHz shall not exceed the limits in the following table, as measured using a 50 μ H/50 ohms line impedance stabilization network (LISN). Compliance with the provisions of this paragraph shall be based on the measurement of the radio frequency voltage between each power line and ground at the power terminal. The lower limit applies at the boundary between the frequencies ranges.

Frequency of Emission (MHz)	Conducted Limit (dBuV)	
	Quasi-Peak	Average
0.15-0.5	66 to 56 *	56 to 46 *
0.5-5	56	46
5-30	60	50

* Decreases with the logarithm of the frequency.

5.2 Test Setup

The measurement was performed at shield room, using the setup per ANSI C63.4 – 2003 measurement procedure. The specification used was FCC Part15.207 limits.

External I/O cables were draped along the edge of the test table and bundle when necessary.

The EUT AC/DC power adapter was connected with LISN-1 which provided 120 V / 60 Hz AC power.

5.3 Test Procedure

During the conducted emissions test, the power cord of the EUT host system was connected to the mains outlet of the LISN-2.

Maximizing procedure was performed on the six (6) highest emissions of the EUT.

All data was recorded in the peak detection mode, quasi-peak and average. Quasi-Peak readings are distinguished with a “QP”. Average readings are distinguished with an “Ave”.

5.4 Summary of Test Results

This test is not applicable (N/A) as the device is powered by DC voltage source.

6 FCC §15.247(a) (2) & RSS-210 § A8.2 (a) – 6 dB Occupied Bandwidth

6.1 Applicable Standard

According to §15.247(a)(2) and RSS-210 A8.2 (a), systems using digital modulation techniques may operate in the 902-928 MHz, 2400-2483.5 MHz, and 5725-5850 MHz bands. The minimum 6 dB bandwidth shall be at least 500 kHz

6.2 Measurement Procedure

1. Check the calibration of the measuring instrument using either an internal calibrator or a known signal from an external generator.
2. Position the EUT without connection to measurement instrument. Turn on the EUT and connect it to measurement instrument. Then set it to any one convenient frequency within its operating range. Set a reference level on the measuring instrument equal to the highest peak value.
3. Measure the frequency difference of two frequencies that were attenuated 6 dB from the reference level. Record the frequency difference as the emissions bandwidth. (6 dB bandwidth for DTS)
4. Repeat above procedures until all frequencies measured were complete.

6.3 Test Equipment List and Details

Manufacturer	Description	Model	Serial Number	Calibration Date
Agilent	Spectrum Analyzer	E4440A	US45303156	2009-03-25

* **Statement of Traceability:** **BACL Corp.** attests that all calibrations have been performed per the NVLAP requirements, traceable to the NIST.

6.4 Environmental Conditions

Temperature:	21°C~22°C
Relative Humidity:	30 %~35 %
ATM Pressure:	101.1~101.4kPa

*The testing was performed by Jack Liu on 2009-05-26 ~ 2009-05-27.

6.5 Summary of Test Results

Channel	Frequency (MHz)	99% OBW (kHz)	6 dB OBW (kHz)	Limit (kHz)
Low	903	846.4004	774.282	>500
Middle	915	851.6054	769.976	>500
High	927	845.1376	755.269	>500

Please refer to the following plots for detailed test results

Low Channel

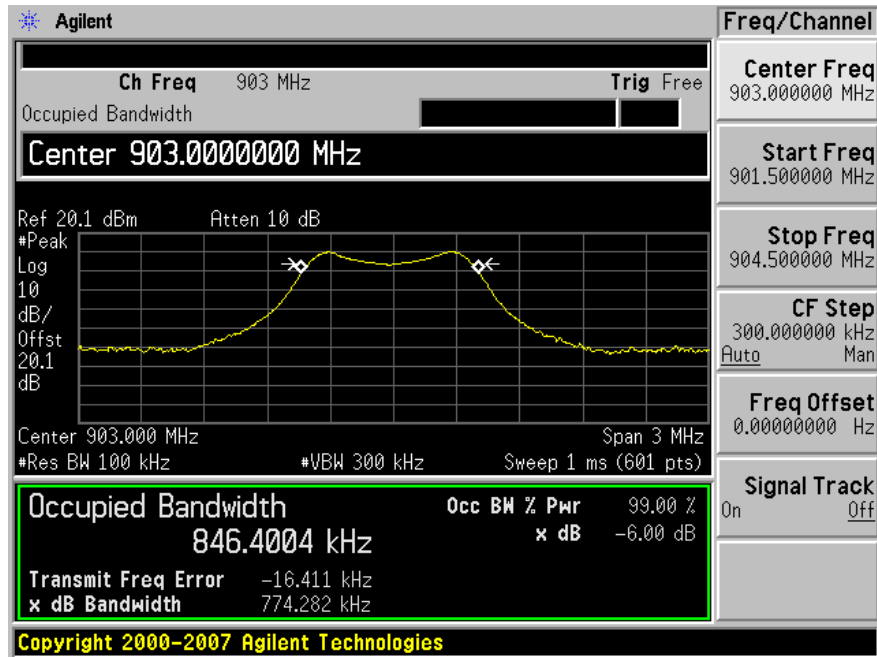

Middle Channel

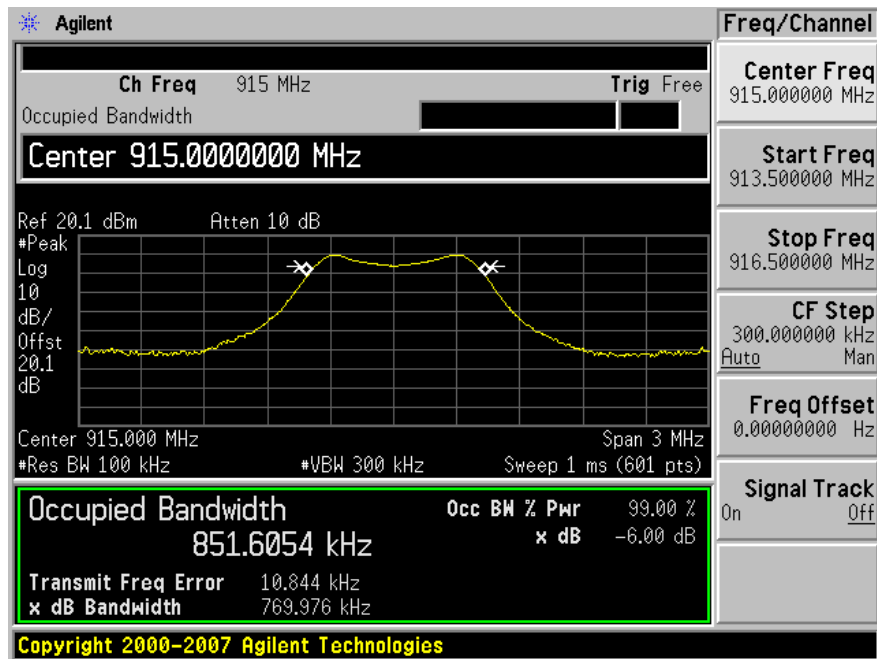

High Channel

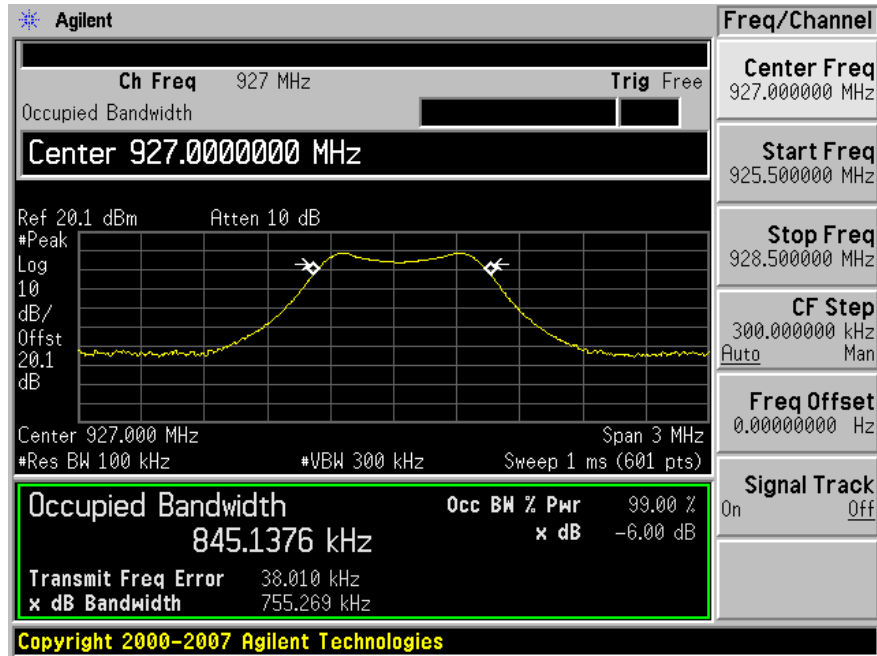

7 FCC §15.247(b) & RSS210 § A8.4 - Peak Output Power

7.1 Applicable Standard

According to §15.247(b) (3) and RSS210 § A8.4 (4) for systems using digital modulation in the 902–928 MHz, 2400–2483.5 MHz, and 5725–5850 MHz bands: 1 Watt.

7.2 Measurement Procedure

1. Place the EUT on a bench and set it in transmitting mode.
2. Remove the antenna from the EUT and then connect a low loss RF cable from the antenna port to a spectrum analyzer.

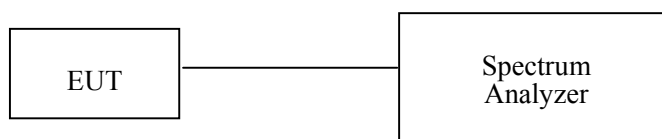

7.3 Test Equipment List and Details

Manufacturer	Description	Model	Serial Number	Calibration Date
Agilent	Spectrum Analyzer	E4440A	US45303156	2009-03-25

* **Statement of Traceability:** **BACL Corp.** attests that all calibrations have been performed per the NVLAP requirements, traceable to the NIST.

7.4 Environmental Conditions

Temperature:	21°C~22°C
Relative Humidity:	30 %~35 %
ATM Pressure:	101.1~101.4kPa

*The testing was performed by Jack Liu on 2009-05-26 ~ 2009-05-27.

7.5 Summary of Test Results

Channel	Frequency (MHz)	Max Power (dBm)	Max Power (Watt)	Limit (Watt)	Result
Low	903	10.05	0.01001	1.0	Compliant
Mid	915	9.72	0.00937	1.0	Compliant
High	927	8.86	0.00769	1.0	Compliant

8 FCC §15.247(d) & RSS-210 § A8.5 – Out of Band Emissions

8.1 Applicable Standard

According to §15.247(d), in any 100 kHz bandwidth outside the frequency bands in which the spread spectrum intentional radiator is operating, the radio frequency power that is produced by the intentional radiator shall be at least 20 dB below that in the 100 kHz bandwidth within the band that contains the highest level of the desired power, based on either an RF conducted or a radiated measurement. In addition, radiated emissions which fall in the restricted bands, as defined in §15.205(a), must also comply with the radiated emissions limits specified in §15.209(a) see §15.205(c)).

RSS210§ A8.5: In any 100 kHz bandwidth outside the frequency band in which the spread spectrum or digitally modulated device is operating, the radio frequency power that is produced shall be at least 20 dB below that in the 100 kHz bandwidth within the band that contains the highest level of the desired power, based on either an RF conducted or a radiated measurement, provided the transmitter demonstrates compliance with the peak conducted power limits. If the transmitter complies with the conducted power limits based on the use of RMS averaging over a time interval, as permitted under section A8.4(4), the attenuation required shall be 30 dB instead of 20 dB. Attenuation below the general limits specified in Tables 2 and 3 is not required. In addition, radiated emissions which fall in the restricted bands of Table 1 must also comply with the radiated emissions limits specified in Tables 2 and 3.

8.2 Measurement Procedure

1. Check the calibration of the measuring instrument using either an internal calibrator or a known signal from an external generator.
2. Position the EUT without connection to measurement instrument. Turn on the EUT and connect its antenna terminal to measurement instrument via a low loss cable. Then set it to any one measured frequency within its operating range, and make sure the instrument is operated in its linear range.
3. Set both RBW and VBW of spectrum analyzer to 100 kHz with a convenient frequency span including 100 kHz bandwidth from band edge.
4. Measure the highest amplitude appearing on spectral display and set it as a reference level. Plot the graph with marking the highest point and edge frequency.
5. Repeat above procedures until all measured frequencies were complete.

8.3 Test Equipment List and Details

Manufacturer	Description	Model	Serial Number	Calibration Due Date
Agilent	Spectrum Analyzer	E4440A	US45303156	2009-03-25

* **Statement of Traceability: BACL Corp.** attests that all calibrations have been performed per the NVLAP requirements, traceable to the NIST.

8.4 Environmental Conditions

Temperature:	21°C~22°C
Relative Humidity:	30 %~35 %
ATM Pressure:	101.1~101.4kPa

*The testing was performed by Jack Liu on 2009-05-26 ~ 2009-05-27.

Please Refer to the Following Plots

Plots of 100 kHz Band Edge:

Lowest Channel

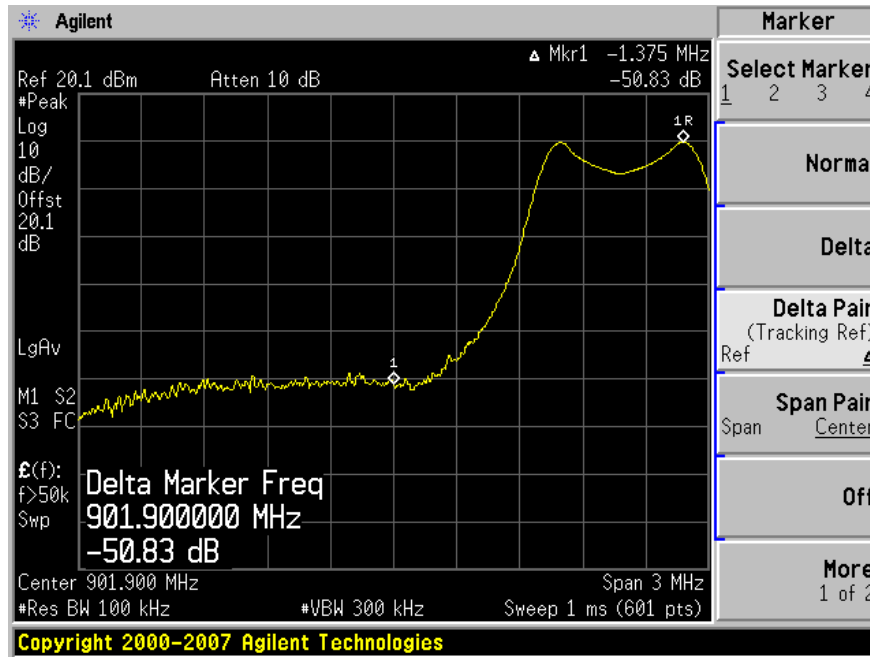

Highest Channel

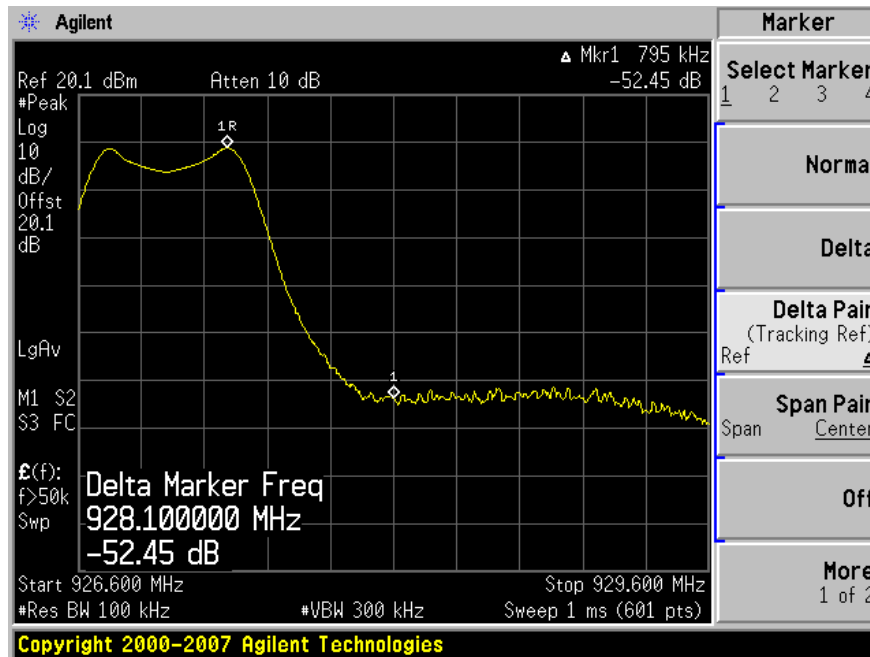

Plots of spurious emission at antenna port

Low Channel

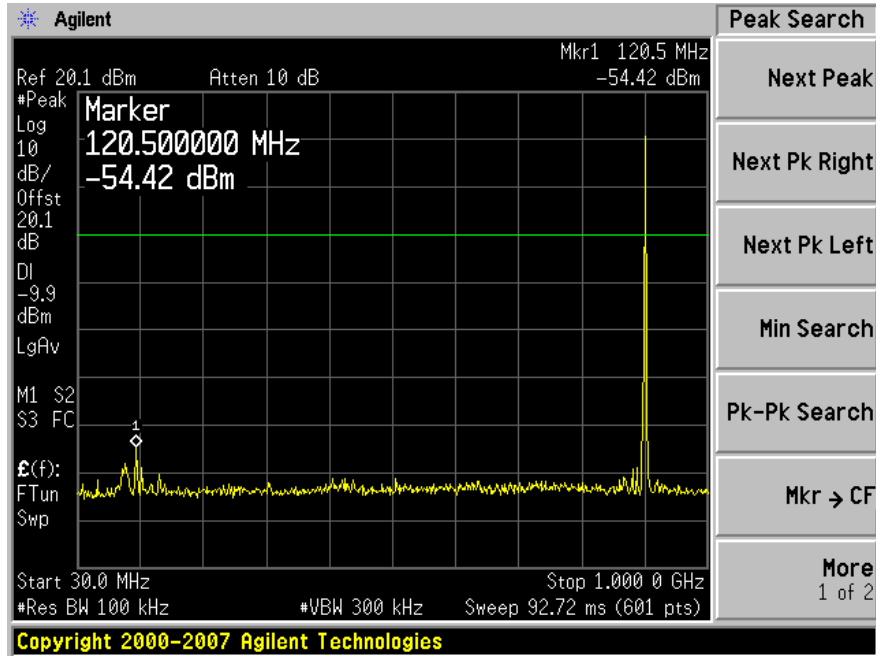

Plot 1: 30 MHz~1 GHz

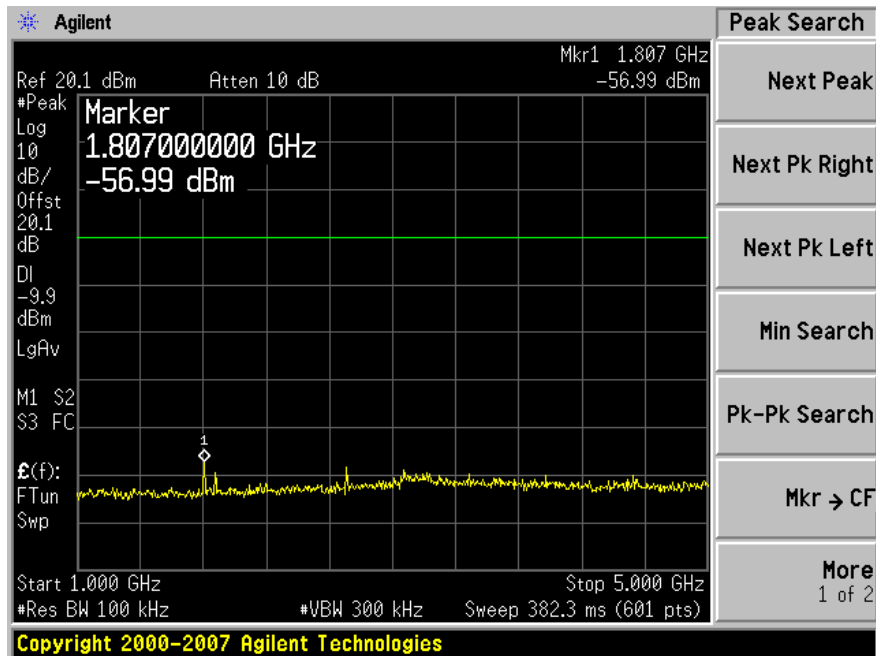

Plot 2: 1 GHz~5 GHz

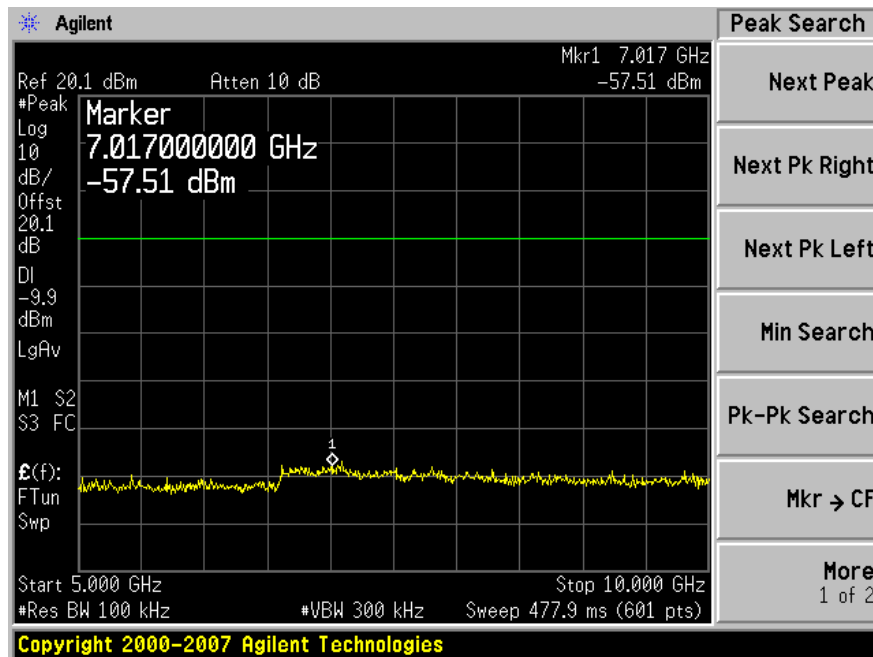

Plot 3: 5 GHz~10 GHz

Middle Channel

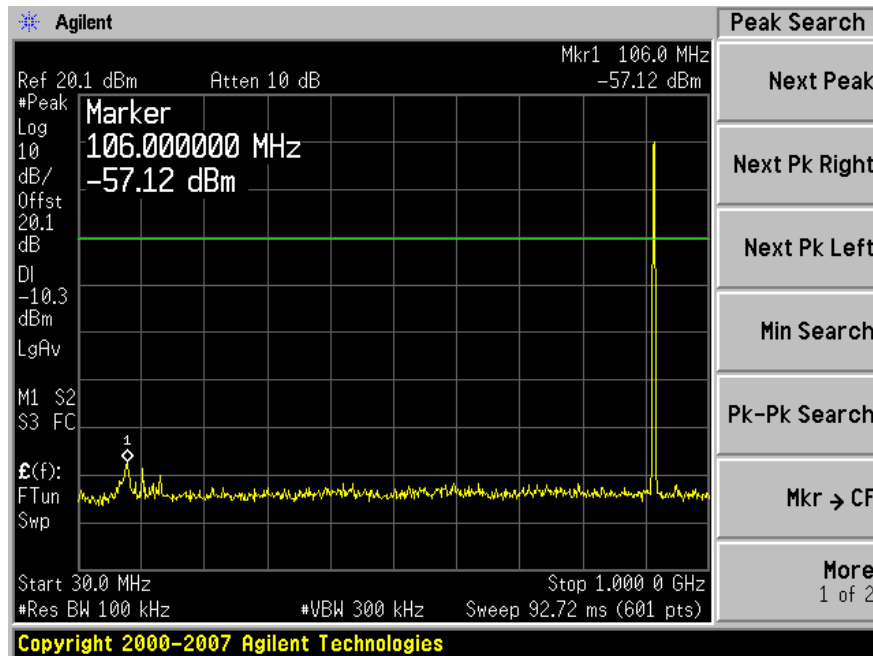

Plot 1: 30 MHz~1 GHz

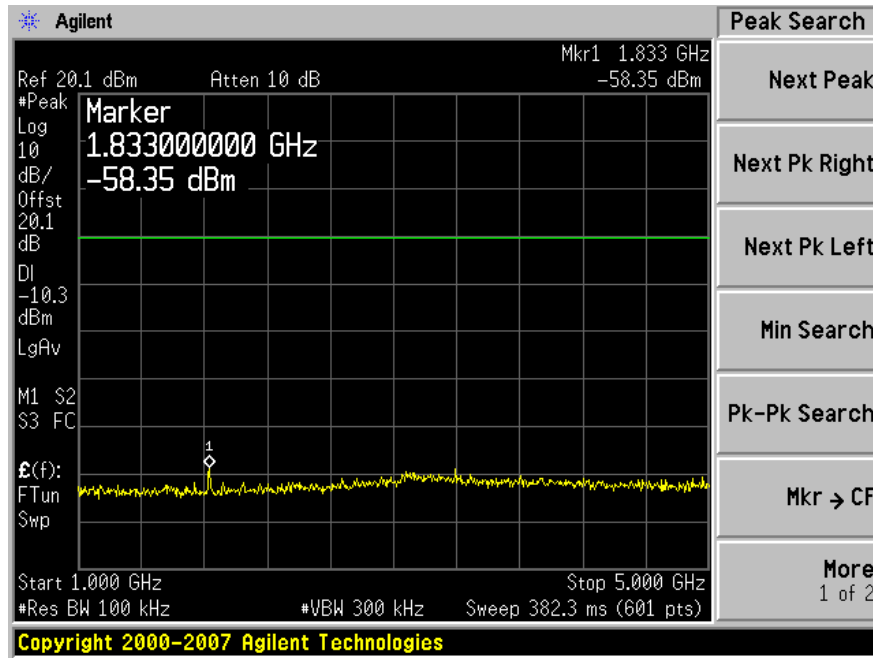

Plot 2: 1 GHz~5 GHz

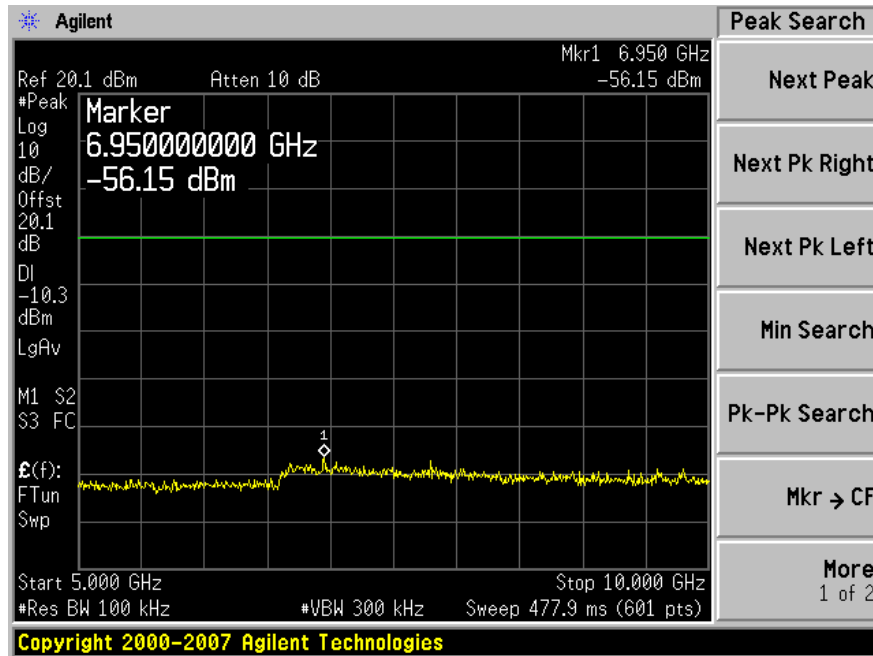

Plot 3: 5 GHz~10 GHz

High Channel

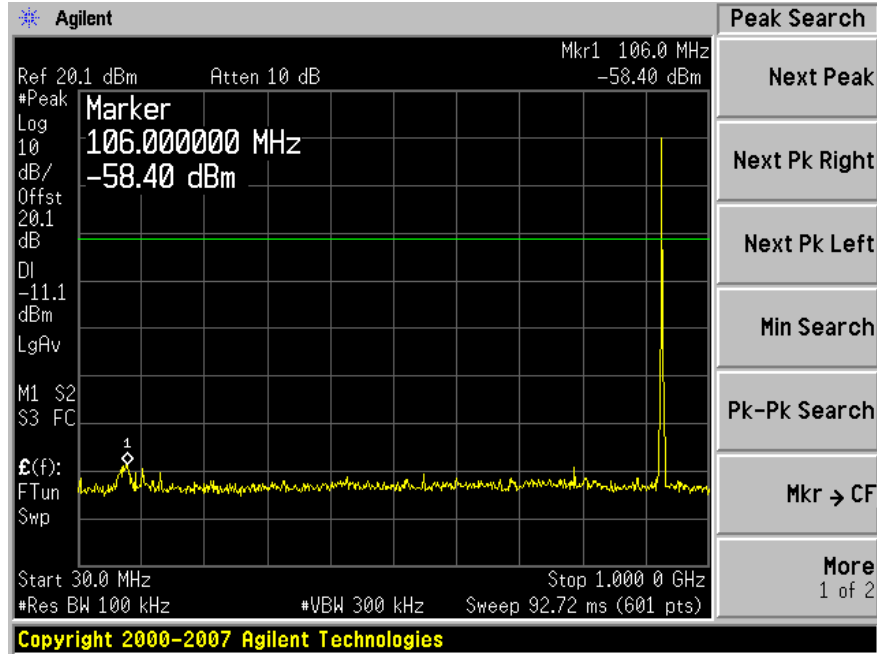

Plot 1: 30 MHz~1 GHz

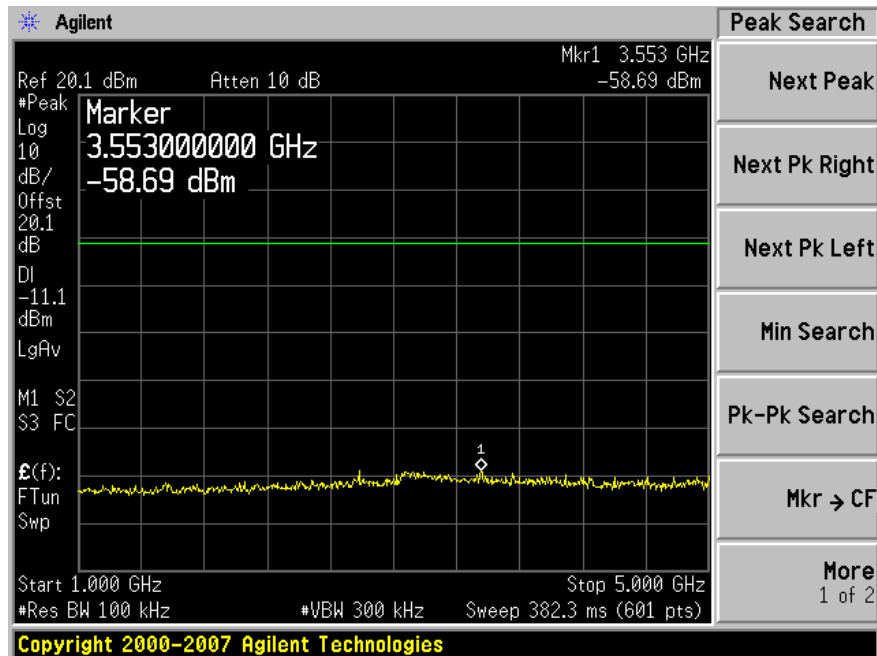

Plot 2: 1 GHz~5 GHz

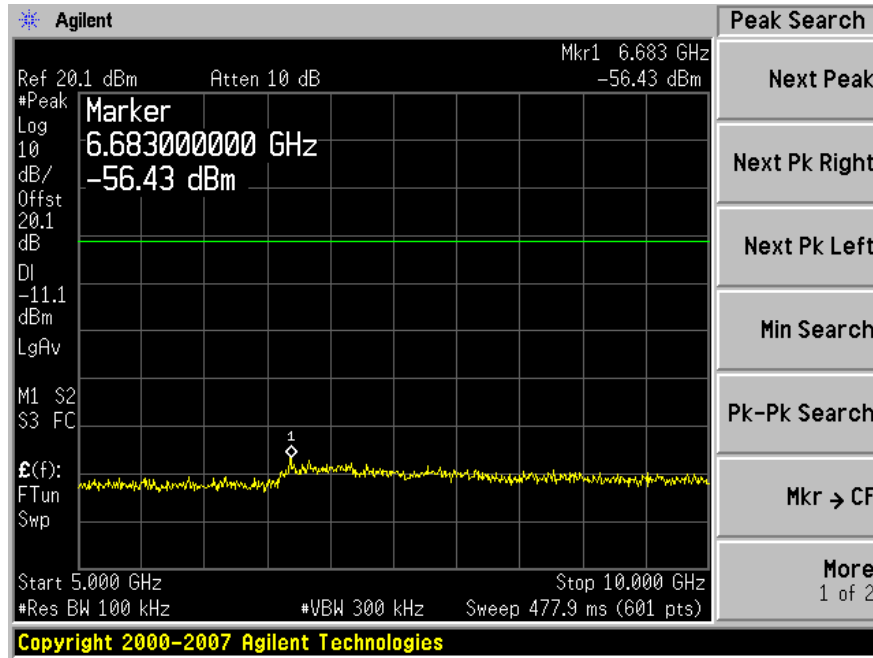

Plot 3: 5 GHz~10 GHz

9 FCC §15.247(e) & RSS-210 § A8.2 (b) - Power Spectral Density

9.1 Applicable Standard

According to §15.247 (e) and RSS-210 § A8.2 (b) , for digitally modulated systems, the power spectral density conducted from the intentional radiator to the antenna shall not be greater than 8 dBm in any 3 kHz band during any time interval of continuous transmission.

9.2 Measurement Procedure

1. Check the calibration of the measuring instrument using either an internal calibrator or a known signal from an external generator.
2. Position the EUT was set without connection to measurement instrument. Turn on the EUT and connect its antenna terminal to measurement instrument via a low loss cable. Then set it to any one measured frequency within its operating range, and make sure the instrument is operated in its linear range.
3. Measure the power spectral density as follows:
 - A. Tune the analyzer to the highest point of the maximized fundamental emission. Reset the analyzer to a RBW = 3 kHz, VBW > RBW, span = 99% OBW, sweep = (span/3kHz) second.
 - B. From the peak level obtained in (A), derive the field strength, E, by applying the appropriate antenna factor, cable loss, pre-amp gain, etc.
4. $P = (E \times d)^2 / (30 \times G)$
 - G = the numeric gain of the transmitting antenna over an isotropic radiator.
 - d = the distance in meters from which the field strength was measured.
 - P = the power in watts for which you are solving:
5. Using the equation listed in (4), calculate a power level for comparison to the + 8 dBm limit.

9.3 Test Equipment List and Details

Manufacturer	Description	Model	Serial Number	Calibration Date
Agilent	Spectrum Analyzer	E4440A	US45303156	2009-03-25

* **Statement of Traceability: BACL Corp.** attests that all calibrations have been performed per the NVLAP requirements, traceable to the NIST.

9.4 Environmental Conditions

Temperature:	21°C~22°C
Relative Humidity:	30 %~35 %
ATM Pressure:	101.1~101.4kPa

*The testing was performed by Jack Liu on 2009-05-26 ~ 2009-05-27.

9.5 Summary of Test Results

Frequency (MHz)	PPSD (dBm/3kHz)	Limit (dBm/3kHz)	Result
903	2.42	8	Compliant
915	1.62	8	Compliant
927	1.19	8	Compliant

Please refer to the following plots for detailed test results

Low Channel

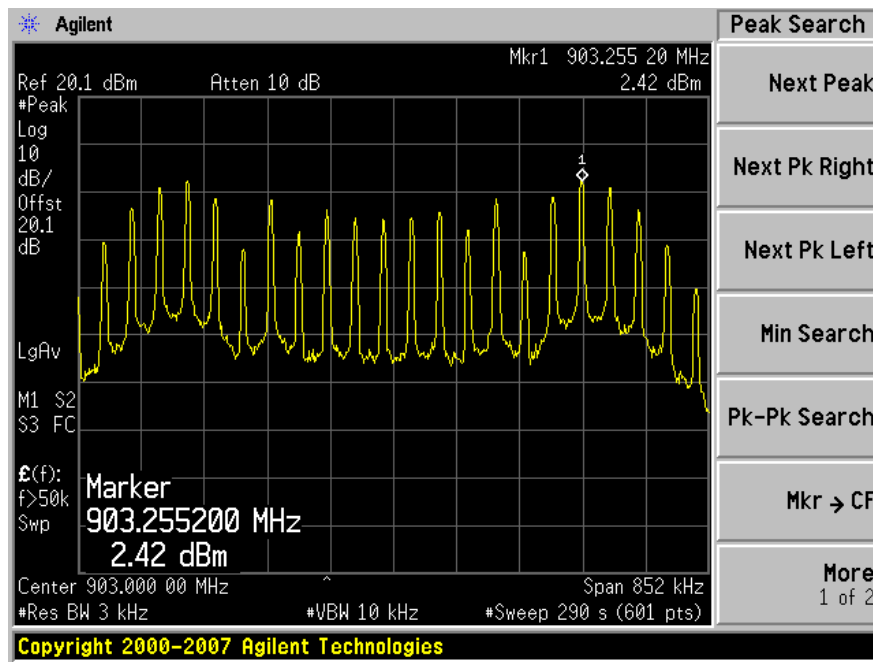

Middle Channel

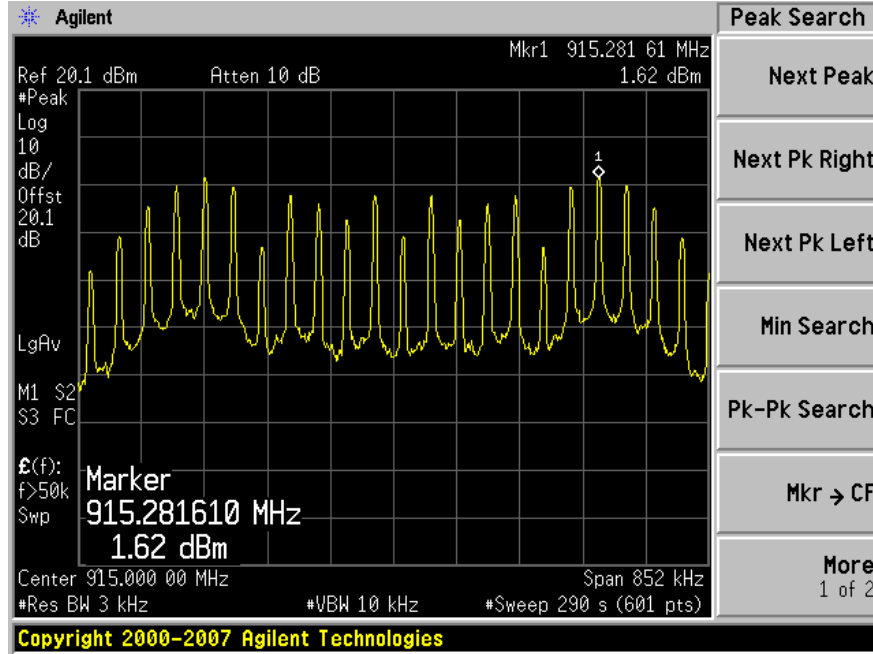

High Channel

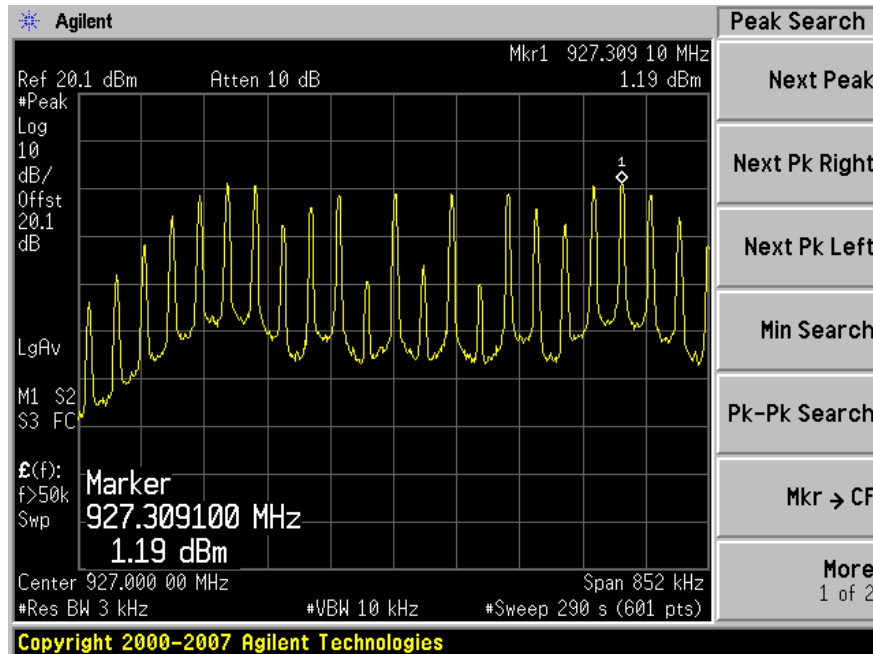

Note: Sweep time \geq (852 kHz/3kHz) seconds = 284 seconds

10 FCC §15.205, §15.209 & §15.247(c) & IC RSS-Gen §4.9 - Spurious Radiated Emissions

10.1 Applicable Standard

As per FCC §15.35(d): Unless otherwise specified, on any frequency or frequencies above 1000 MHz, the radiated emission limits are based on the use of measurement instrumentation employing an average detector function. Unless otherwise specified, measurements above 1000 MHz shall be performed using a minimum resolution bandwidth of 1 MHz.

As per FCC §15.209(a): Except as provided elsewhere in this Subpart, the emissions from an intentional radiator shall not exceed the field strength levels specified in the following table

Frequency (MHz)	Field Strength (micro volts/meter)	Measurement Distance (meters)
0.009 - 0.490	2400/F(kHz)	300
0.490 - 1.705	24000/F(kHz)	30
1.705 - 30.0	30	30
30 - 88	100**	3
88 - 216	150**	3
216 - 960	200**	3
Above 960	500	3

** Except as provided in paragraph (g), fundamental emissions from intentional radiators operating under this Section shall not be located in the frequency bands 54-72 MHz, 76-88 MHz, 174-216 MHz or 470-806 MHz. However, operation within these frequency bands is permitted under other sections of this Part, e.g., Sections 15.231 and 15.241.

As Per FCC §15.205(a) except as show in paragraph (d) of this section, only spurious emissions are permitted in any of the frequency bands listed below:

MHz	MHz	MHz	GHz
0.090 – 0.110	16.42 – 16.423	960 – 1240	4.5 – 5.15
0.495 – 0.505	16.69475 – 16.69525	1300 – 1427	5.35 – 5.46
2.1735 – 2.1905	25.5 – 25.67	1435 – 1626.5	7.25 – 7.75
4.125 – 4.128	37.5 – 38.25	1645.5 – 1646.5	8.025 – 8.5
4.17725 – 4.17775	73 – 74.6	1660 – 1710	9.0 – 9.2
4.20725 – 4.20775	74.8 – 75.2	1718.8 – 1722.2	9.3 – 9.5
6.215 – 6.218	108 – 121.94	2200 – 2300	10.6 – 12.7
6.26775 – 6.26825	123 – 138	2310 – 2390	13.25 – 13.4
6.31175 – 6.31225	149.9 – 150.05	2483.5 – 2500	14.47 – 14.5
8.291 – 8.294	156.52475 – 156.52525	2690 – 2900	15.35 – 16.2
8.362 – 8.366	156.7 – 156.9	3260 – 3267	17.7 – 21.4
8.37625 – 8.38675	162.0125 – 167.17	3.332 – 3.339	22.01 – 23.12
8.41425 – 8.41475	167.72 – 173.2	3.3458 – 3.358	23.6 – 24.0
12.29 – 12.293	240 – 285	3.600 – 4.400	31.2 – 31.8
12.51975 – 12.52025	322 – 335.4		36.43 – 36.5
12.57675 – 12.57725	399.9 – 410		Above 38.6
13.36 – 13.41	608 – 614		

As per FCC §15.247 (d) In any 100 kHz bandwidth outside the frequency band in which the spread spectrum or digitally modulated intentional radiator is operating, the radio frequency power that is produced by the intentional radiator shall be at least 20 dB below that in the 100 kHz bandwidth within the band that contains the highest level of the desired power, based on either an RF conducted or a radiated measurement, provided the transmitter demonstrates compliance with the peak conducted power limits. If the transmitter complies with the conducted power limits based on the use of RMS averaging over a time interval, as permitted under paragraph (b)(3) of this section, the attenuation required under this paragraph shall be 30 dB instead of 20 dB. Attenuation below the general limits specified in §15.209(a) is not required. In addition, radiated emissions which fall in the restricted bands, as defined in §15.205(a), must also comply with the radiated emission limits specified in §15.209(a) (see §15.205(c)).

IC RSS-GEN §4.9 the measurement method shall be described in the test report. The same parameter, peak power or average power, used for the transmitter output power measurement shall be used for unwanted emission measurements. The search for unwanted emissions shall be from the lowest frequency internally generated or used in the device (local oscillator, intermediate or carrier frequency), or from 30 MHz, whichever is the lower, to the 5th harmonic of the highest frequency generated without exceeding 40 GHz.

10.2 Test Setup

The radiated emissions tests were performed in the 3-meter open area test site, using the setup in accordance with ANSI C63.4-2003. The specification used was the FCC 15 Subpart C and RSS-210 limits.

10.3 EUT Setup

The radiated emissions tests were performed using the setup accordance with the ANSI C63.4-2003. The specification used was the FCC 15C and RSS-210 limits.

The spacing between the peripherals was 3 centimeters.

External I/O cables were draped along the edge of the test table and bundle when necessary.

10.4 Test Procedure

For the radiated emissions test, the EUT was connected to the DC power source, and all support equipment power cords was connected to the AC floor outlet.

Maximizing procedure was performed on the highest emissions to ensure that the EUT complied with all installation combinations.

The EUT is set 3 meters away from the testing antenna, which is varied from 1-4 meters, and the EUT is placed on a turntable, which is 0.8 meter above ground plane, the table shall be rotated for 360 degrees to find out the highest emission. The receiving antenna should be changed the polarization both of horizontal and vertical.

The spectrum analyzer or receiver is set as:

Below 1000 MHz:

RBW = 100 kHz / VBW = 300 kHz / Sweep = Auto

Above 1000 MHz:

- (1) Peak: RBW = 1MHz / VBW = 1MHz / Sweep = Auto
- (2) Average: RBW = 1MHz / VBW = 10Hz / Sweep = Auto

10.5 Corrected Amplitude & Margin Calculation

The Corrected Amplitude is calculated by adding the Antenna Factor and Cable Factor, and subtracting the Amplifier Gain from the Amplitude reading. The basic equation is as follows:

$$\text{Corrected Amplitude} = \text{Indicated Reading} + \text{Antenna Factor} + \text{Cable Factor} - \text{Amplifier Gain}$$

The “**Margin**” column of the following data tables indicates the degree of compliance with the applicable limit. For example, a margin of -7dB means the emission is 7dB below the maximum limit. The equation for margin calculation is as follows:

$$\text{Margin} = \text{Corrected Amplitude} - \text{Limit}$$

10.6 Test Equipment List and Details

Manufacturer	Description	Model	Serial Number	Calibration Date
Agilent	Spectrum Analyzer	E4440A	US44303352	2009-03-25
Sunol Sciences	Antenna	JB1	A020106-1	2009-04-17
A.R.A	Horn Antenna	DRG-118/A	1132	2008-07-28
A. H. Systems	Antenna, Horn, DRG	SAS-200/571	261	2008-07-01
Ducommun	Pre-Amplifier	ALN-09173030-01	99-297-01R	2009-03-04
HP	Pre-Amplifier	8447D	2944A06639	2009-03-06

* **Statement of Traceability:** BACL attests that all calibrations have been performed per the NVLAP requirements, traceable to NIST.

10.7 Environmental Conditions

Temperature:	21°C~22°C
Relative Humidity:	30 %~35 %
ATM Pressure:	101.1~101.4kPa

*The testing was performed by Jack Liu on 2009-05-26 ~ 2009-05-27.

10.8 Summary of Test Results

According to the data hereinafter, the EUT complied with the FCC and IC requirements, and had the worst margin readings of:

Low Channel: 903 MHz

Margin (dB)	Frequency (MHz)	Polarization (Horizontal/Vertical)	Range (MHz)
-3.85	160.0033	Vertical	30 to 1000 MHz
-14.3	1806	Vertical	Above 1 GHz

Middle Channel: 915 MHz

Margin (dB)	Frequency (MHz)	Polarization (Horizontal/Vertical)	Range (MHz)
-5.61	159.9829	Vertical	30 to 1000 MHz
-22.96	1830	Vertical	Above 1 GHz

High Channel: 927 MHz

Margin (dB)	Frequency (MHz)	Polarization (Horizontal/Vertical)	Range (MHz)
-8.64	160.0033	Vertical	30 to 1000 MHz
-19.37	1854	Vertical	Above 1 GHz

10.9 Radiated Emissions Test Plot & Data

30 MHz – 1 GHz measured at 3 meters

Low Channel: 903 MHz

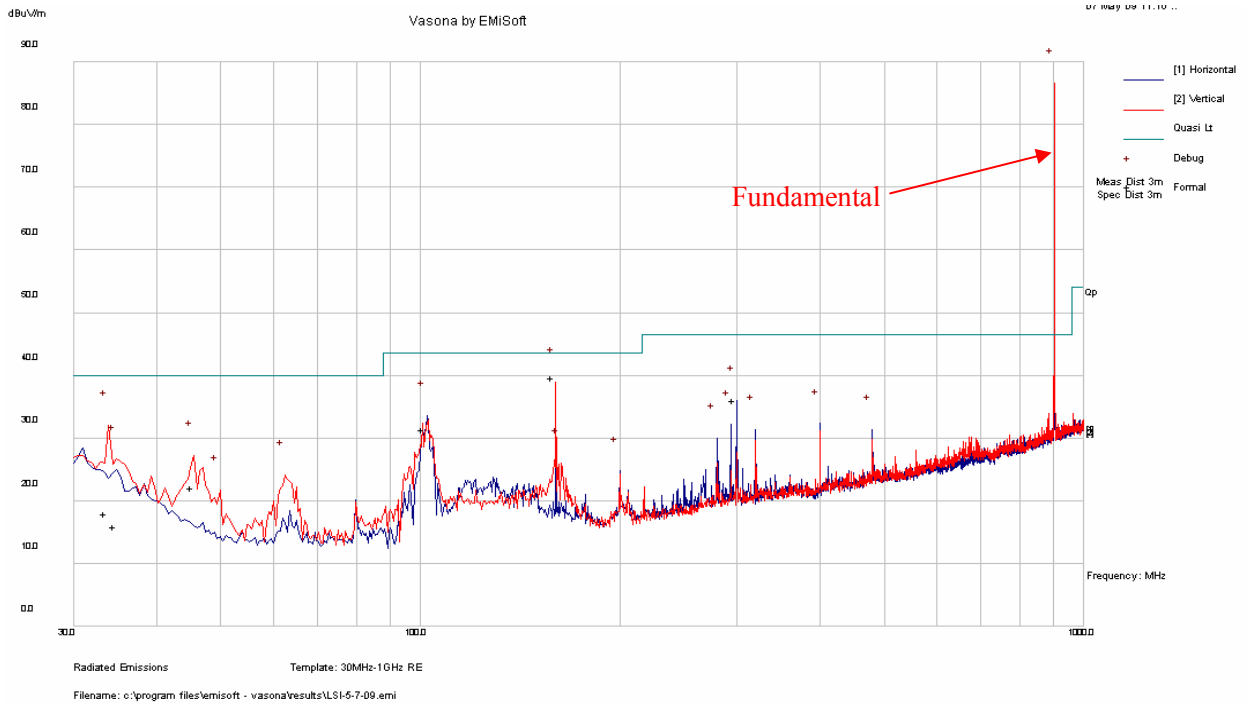

Frequency (MHz)	Quasi-Peak (dB μ V/m)	Antenna Height (cm)	Antenna Polarity (H/V)	Azimuth (degrees)	Limit (dB μ V/m)	Margin (dB)
160.00330	39.65	92	V	167	43.5	-3.85
299.98920	35.99	95	H	132	46.5	-10.51
102.21270	31.44	211	H	91	43.5	-12.06
45.73408	22.03	166	V	1	40.0	-17.97
33.85312	18.01	131	V	286	40.0	-21.99
35.02976	15.91	188	V	90	40.0	-24.09

Middle Channel: 915 MHz

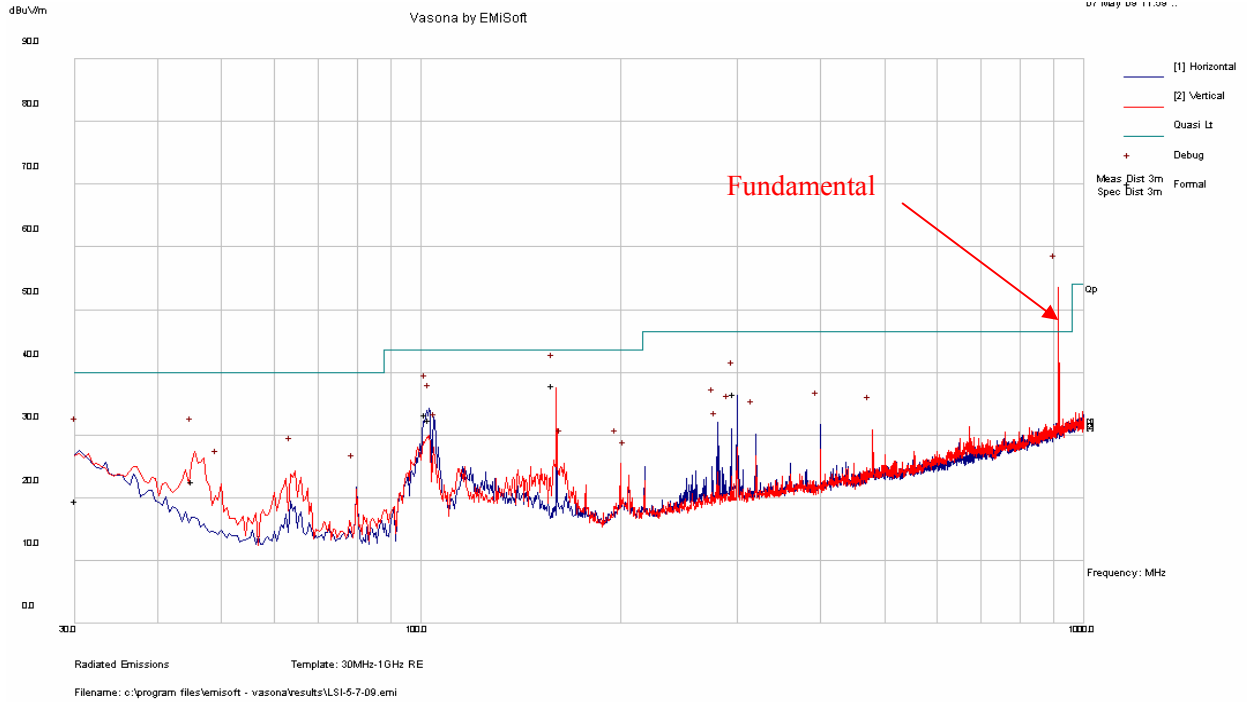

Frequency (MHz)	Quasi-Peak (dBμV/m)	Antenna Height (cm)	Antenna Polarity (H/V)	Azimuth (degrees)	Limit (dBμV/m)	Margin (dB)
159.98290	37.89	100	V	182	43.5	-5.61
299.97580	36.60	93	H	136	46.5	-9.90
102.83600	33.32	162	H	82	43.5	-10.18
104.12460	32.45	244	H	100	43.5	-11.05
45.73768	22.63	166	V	32	40.0	-17.37
30.58724	19.54	161	H	316	40.0	-20.46

High Channel: 927 MHz

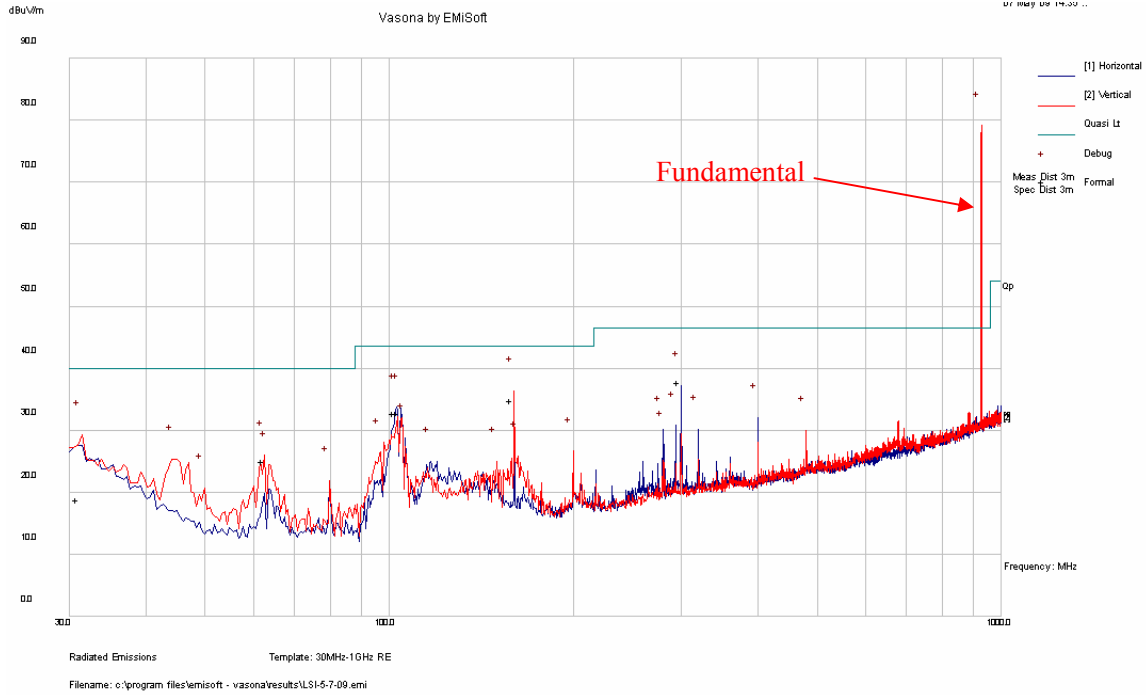

Frequency (MHz)	Quasi-Peak (dBµV/m)	Antenna Height (cm)	Antenna Polarity (H/V)	Azimuth (degrees)	Limit (dBµV/m)	Margin (dB)
160.00330	34.86	160	V	293	43.5	-8.64
299.97350	37.71	99	H	131	46.5	-8.79
102.87550	32.79	256	H	93	43.5	-10.71
104.10040	32.70	258	H	114	43.5	-10.8
62.86888	24.98	173	V	50	40.0	-15.02
31.32780	18.87	245	V	297	40.0	-21.13

1 GHz – 25 GHz measured at 3 meters

Low Channel: 903 MHz

Frequency (MHz)	Indicated Reading (dBµV)	Table Azimuth (degree)	Test Antenna			Cable Loss (dB)	Pre-Amp. Gain (dB)	Cord. Reading (dBµV/m)	FCC & IC		Comments
			Height (cm)	Polarity (H/V)	Factor (dB/m)				Limit (dBµV/m)	Margin (dB)	
1806	48.50	360	101	V	25.8	5.13	39.73	39.70	54	-14.30	Average
2709	37.62	160	100	V	29.6	6.64	41.89	31.97	54	-22.03	Average
1806	39.94	145	101	H	25.8	5.13	39.72	31.15	54	-22.85	Average
1806	58.96	360	101	V	25.8	5.13	39.72	50.17	74	-23.83	Peak
2709	34.27	209	100	H	29.6	6.64	41.89	28.62	54	-25.38	Average
2709	51.48	160	100	V	29.6	6.64	41.89	45.83	74	-28.17	Peak
2709	49.31	209	100	H	29.6	6.64	41.89	43.66	74	-30.34	Peak
1806	50.83	145	102	H	25.8	5.13	39.72	42.04	74	-31.96	Peak

Middle Channel: 915 MHz

Frequency (MHz)	Indicated Reading (dBµV)	Table Azimuth (degree)	Test Antenna			Cable Loss (dB)	Pre-Amp. Gain (dB)	Cord. Reading (dBµV/m)	FCC & IC		Comments
			Height (cm)	Polarity (H/V)	Factor (dB/m)				Limit (dBµV/m)	Margin (dB)	
1830	39.63	188	100	V	26.0	5.23	39.82	31.04	54	-22.96	Average
2745	36.37	84	100	V	29.6	6.64	41.89	30.72	54	-23.28	Average
2745	34.30	102	100	H	29.6	6.64	41.89	28.65	54	-25.35	Average
2745	50.62	84	100	V	29.6	6.64	41.89	44.97	74	-29.03	Peak
1830	32.06	188	100	H	26.0	5.23	39.82	23.47	54	-30.53	Average
2745	48.62	102	100	H	29.6	6.64	41.89	42.97	74	-31.03	Peak
1830	50.56	188	100	V	26.0	5.23	39.82	41.97	74	-32.03	Peak
1830	45.21	188	100	H	26.0	5.23	39.82	36.62	74	-37.38	Peak

High Channel: 927 MHz

Frequency (MHz)	Indicated Reading (dBµV)	Table Azimuth (degree)	Test Antenna			Cable Loss (dB)	Pre-Amp. Gain (dB)	Cord. Reading (dBµV/m)	FCC & IC		Comments
			Height (cm)	Polarity (H/V)	Factor (dB/m)				Limit (dBµV/m)	Margin (dB)	
1854	43.44	59	100	V	26.0	5.19	40.00	34.63	54	-19.37	Average
2781	36.87	175	100	V	29.2	6.77	41.89	30.95	54	-23.05	Average
2781	34.02	24	100	H	29.2	6.77	41.89	28.10	54	-25.90	Average
1854	54.11	59	100	V	26.0	5.19	40.00	45.30	74	-28.70	Peak
2781	50.94	175	100	V	29.2	6.77	41.89	45.02	74	-28.98	Peak
2781	48.44	24	100	H	29.2	6.77	41.89	42.52	74	-31.48	Peak
1854	30.29	118	100	H	26.0	5.19	40.00	21.48	54	-32.52	Average
1854	44.32	118	100	H	26.0	5.19	40.00	35.51	74	-38.49	Peak

11 RSS-210 § 2.6 Receiver Spurious Radiated Emissions

11.1 Applicable Standard

As per RSS-210 § 2.6

Tables 2 and 3 show the general field strength limits of unwanted emissions, where applicable, for transmitters and receivers operating in accordance with the provisions specified in this RSS. Transmitters whose wanted emissions are also within the limits shown in Tables 2 and 3 may operate in any of the frequency bands of Tables 2 and 3, other than the restricted bands of Table 1 and the TV bands, and shall be certified under RSS-210. (Note: Devices operating below 490 kHz all of whose emissions are at least 40 dB below the limit given in Table 3 are Category II devices subject to RSS-310.) Unwanted emissions of transmitters and receivers are permitted to fall into Table 1 and TV frequencies but intentional emissions are prohibited. See the note of Table 2 for further details.

Table 2: General Field Strength Limits for Transmitters and Receivers at Frequencies above 30 MHz ^(Note)

Frequency (MHz)	Field Strength Microvolts/m at 3 meters (watts, e.i.r.p.)	
	Transmitters	Receivers
30-88	100 (3 nW)	100 (3 nW)
88-216	150 (6.8 nW)	150 (6.8 nW)
216-960	200 (12 nW)	200 (12 nW)
Above 960	500 (75 nW)	500 (75 nW)

Note: Transmitting devices are not permitted in Table 1 bands or in TV bands (54-72 MHz, 76-88 MHz, 174-216 MHz, 470-608 MHz, and 614-806 MHz). Prohibition of operation in TV bands does not apply to momentary devices, or to medical telemetry devices in the band 174-216 MHz, and to perimeter protection systems in the bands 54-72 and 76-88 MHz. The perimeter protection devices are to meet Table 3 field strengths limits.

Table 3: General Field Strength Limits for Transmitters at Frequencies below 30 MHz (Transmit)

Frequency (fundamental or spurious)	Field Strength (microvolts/m)	Magnetic H-Field (microamperes/m)	Measurement Distance (metres)
9-490 kHz	2,400/F (F in kHz)	2,400/377F (F in kHz)	300
490-1,705 kHz	24,000/F (F in kHz)	24,000/377F (F in kHz)	30
1.705-30 MHz	30	N/A	30

Note: The emission limits for the bands 9-90 kHz and 110-490 kHz are based on measurements employing an average detector.

11.2 Test Setup

The radiated emissions tests were performed in the 3 meter chamber, using the setup in accordance with ANSI C63.4-2003.

11.3 Test Procedure

Maximizing procedure was performed on the six (6) highest emissions to ensure EUT compliance is with all installation combinations.

All data were recorded in the peak detection mode. Quasi-peak readings was performed only when an emissions was found to be marginal (within -4 dB of specification limits), and are distinguished with a "QP" in the data table.

11.4 Corrected Amplitude & Margin Calculation

The Corrected Amplitude is calculated by adding the Antenna Factor and Cable Factor, and subtracting the Amplifier Gain from the Amplitude reading. The basic equation is as follows:

$$\text{Corrected Amplitude} = \text{Indicated Reading} + \text{Antenna Factor} + \text{Cable Factor} - \text{Amplifier Gain}$$

The "Margin" column of the following data tables indicates the degree of compliance with the applicable limit. For example, a margin of -7dB means the emission is 7dB below the maximum limit. The equation for margin calculation is as follows:

$$\text{Margin} = \text{Corrected Amplitude} - \text{Limit}$$

11.5 Test Equipment List and Details

Manufacturer	Description	Model	Serial Number	Calibration Date
Agilent	Spectrum Analyzer	E4440A	US45303156	2009-03-25
Sunol Sciences	Antenna	JB1	A103106-1	2009-04-17
A.R.A	Horn Antenna	DRG-118/A	1132	2008-07-28
A. H. Systems	Antenna, Horn, DRG	SAS-200/571	261	2008-07-01
Ducommun	Pre-Amplifier	ALN-09173030-01	99-297-01R	2009-03-04
HP	Pre-Amplifier	8447D	2944A06639	2009-03-06

* **Statement of Traceability:** BACL attests that all calibrations have been performed per the NVLAP requirements, traceable to NIST.

11.6 Environmental Conditions

Temperature:	21°C~22°C
Relative Humidity:	30 %~35 %
ATM Pressure:	101.1~101.4kPa

*The testing was performed by Jack Liu on 2009-05-26 ~ 2009-05-27.

11.7 Summary of Test Results

According to the recorded data, the EUT complied with RSS-210 Standard, and had the worst margin reading of:

Receiving Mode:

Margin (dB)	Frequency (MHz)	Polarization (Horizontal/Vertical)	Range
-6.88	160.0162	Vertical	30 MHz to 1 GHz
-	-	-	Above 1 GHz*

***Note:** All above 1 GHz emission levels are at the noise floor and/or more than 20 dB below the limit.

Please refer to the following plot and data:

11.8 Radiated Emissions Test Plots and Data

30 MHz – 1 GHz (Middle Channel measured at 3 meters)

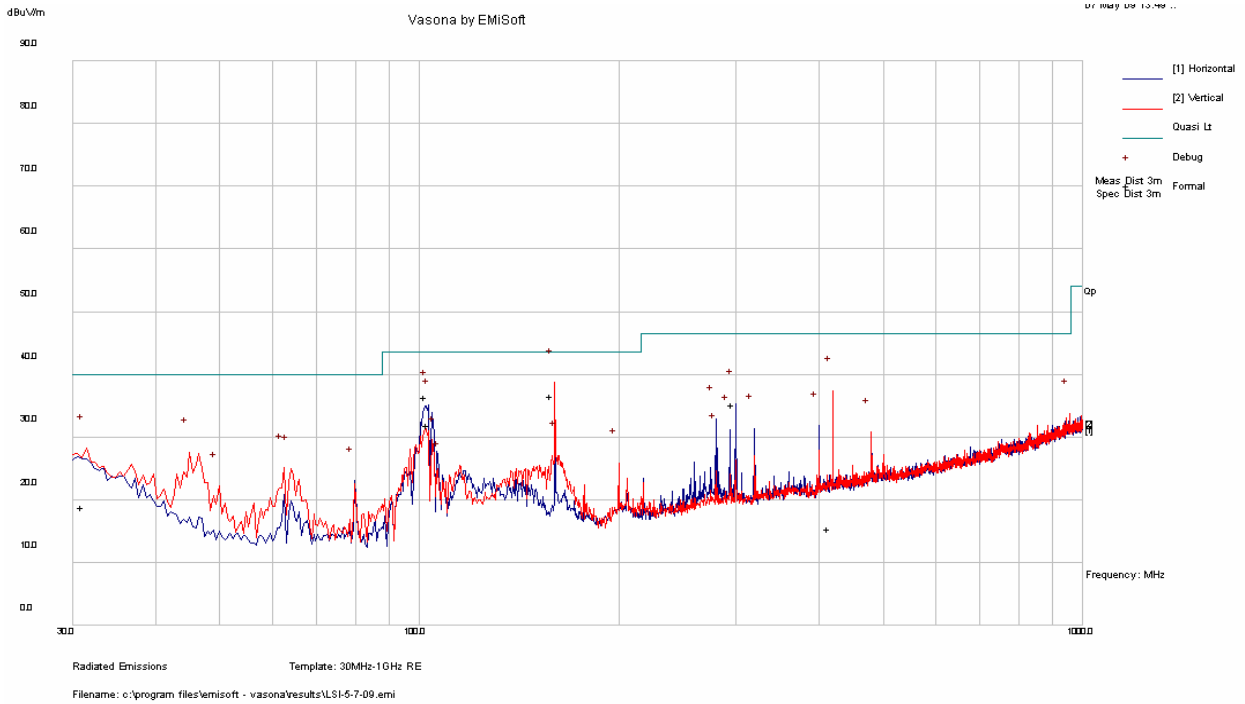

Frequency (MHz)	Quasi-Peak (dBµV/m)	Antenna Height (cm)	Antenna Polarity (H/V)	Azimuth (degrees)	Limit (dBµV/m)	Margin (dB)
160.01620	36.62	96	V	152	43.5	-6.88
103.54130	36.38	267	H	259	43.5	-7.12
299.97780	35.11	101	H	129	46.5	-11.39
104.17690	31.89	223	H	276	43.5	-11.61
31.43388	18.78	216	V	14	40.0	-21.22
419.73580	15.44	185	V	196	46.5	-31.06

Above 1 GHz (Middle Channel measured at 3 meters)

Frequency (MHz)	Indicated Reading (dBµV)	Table Azimuth (degree)	Test Antenna			Cable Loss (dB)	Pre-Amp. Gain (dB)	Cord. Reading (dBµV/m)	IC RSS-Gen		Comments
			Height (cm)	Polarity (H/V)	Factor (dB/m)				Limit (dBµV/m)	Margin (dB)	
-	-	-	-	-	-	-	-	-	-	-	.*
-	-	-	-	-	-	-	-	-	-	-	.*

*Note: All emission levels are at the noise floor and/or more then 20 dB below the limit.

12 §15.247 (i), § 2.1091 & RSS-102 - RF Exposure

12.1 Applicable Standard

According to §15.247(i) and §1.1307(b)(1), systems operating under the provisions of this section shall be operated in a manner that ensures that the public is not exposed to radio frequency energy level in excess of the Commission's guidelines.

According to §1.1310 and §2.1091 RF exposure is calculated.

Limits for General Population/Uncontrolled Exposure

Frequency Range (MHz)	Electric Field Strength (V/m)	Magnetic Field Strength (A/m)	Power Density (mW/cm ²)	Averaging Time (minutes)
Limits for General Population/Uncontrolled Exposure				
0.3-1.34	614	1.63	*(100)	30
1.34-30	824/f	2.19/f	*(180/f ²)	30
30-300	27.5	0.073	0.2	30
300-1500	/	/	f/1500	30
1500-100,000	/	/	1.0	30

f = frequency in MHz

* = Plane-wave equivalent power density

Before equipment certification is granted, the procedure of RSS-102 must be followed concerning the exposure of humans to RF fields.

According to RSS-102 Issue 2 section 4.1, RF limits used for general public will be applied to the EUT.

Frequency Range (MHz)	Electric Field (V/m rms)	Magnetic Field (A/m rms)	Power Density (W/m ²)	Time Averaging (min)
0.003 - 1	280	2.19	-	6
1 - 10	280 / f	2.19 / f	-	6
10 - 30	28	2.19 / f	-	6
30 - 300	28	0.073	2*	6
300 - 1 500	1.585 f ^{0.5}	0.0042 f ^{0.5}	f / 150	6
1 500 - 15 000	61.4	0.163	10	6
15 000 - 150 000	61.4	0.163	10	616000 / f ^{1.2}
150 000- 300 000	0.158 f ^{0.5}	4.21 x 10 ⁻⁴ f ^{0.5}	6.67 x 10 ⁻⁵ f	616000 / f ^{1.2}

Note: f is frequency in MHz

* Power density limit is applicable at frequencies greater than 100 MHz

12.2 MPE Prediction

Predication of MPE limit at a given distance

Equation from page 18 of OET Bulletin 65, Edition 97-01

$$S = PG/4\pi R^2$$

Where: S = power density

P = power input to antenna

G = power gain of the antenna in the direction of interest relative to an isotropic radiator

R = distance to the center of radiation of the antenna

<u>Maximum peak output power at antenna input terminal (dBm):</u>	<u>10.05</u>
<u>Maximum peak output power at antenna input terminal (mW):</u>	<u>10.12</u>
<u>Prediction distance (cm):</u>	<u>20</u>
<u>Prediction frequency (MHz):</u>	<u>903</u>
<u>Maximum Antenna Gain, typical (dBi):</u>	<u>0.5</u>
<u>Maximum Antenna Gain (numeric):</u>	<u>1.122</u>
<u>Power density of prediction frequency at 20.0 cm (mW/cm²):</u>	<u>0.002259</u>
<u>Power density of prediction frequency at 20.0 cm (W/m²):</u>	<u>0.02259</u>
<u>MPE limit for uncontrolled exposure at prediction frequency (mW/cm²):</u>	<u>0.602</u>
<u>MPE limit for uncontrolled exposure at prediction frequency (W/m²):</u>	<u>6.02</u>

12.3 Test Result

The device is compliant with the requirement MPE limit for uncontrolled exposure. The maximum power density at the distance of 20 cm is 0.002259 mW/cm² (0.02259 W/m²). Limit is 0.602 mW/cm² (6.02 W/m²).