

1.6 User Manual

AGE 14+

R/C HELICOPTER USING INSTRUCTION

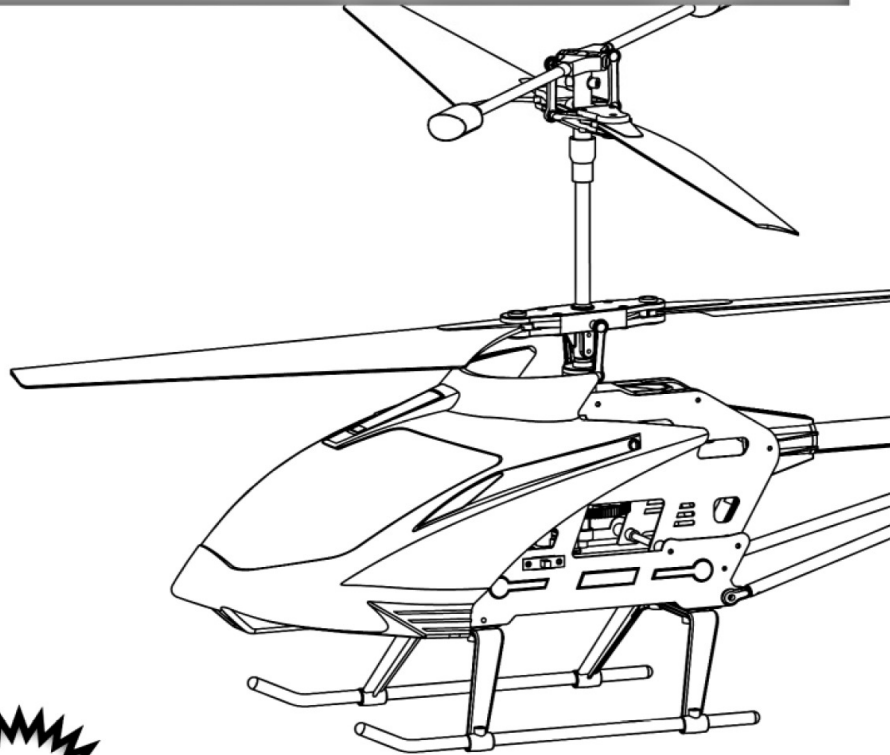

To avoid copter's damage and player's injury, please read this instruction before flying!

In this instruction of material, the specification or parts within the accessories bag is for reference only. The company will not be responsible for any change of printed part and notify the consumers. Any update or change please refer to the website of SYMA (www.symatoys.com).

Safety regulations

1. Placed in small parts of the reach of children, to avoid accidents.
2. The blades of this helicopter is used activities blades,don't screw up.
3. The helicopter was powerful, should be gradually pushed up the remote control shift lever on the left for first flight, to avoid the surge caused the helicopter crash damage.
4. Should be turn off the power of controller first then turn off the power of the helicopter when finished flight.
5. Do not place the battery in high temperature, heating place(e.g:fire or electric heating devices)
6. Note that when the helicopter to keep the user or other persons from 2-3 m to avoid the helicopter flight, landing crashed into another person's head, face and body and so on.
7. Children should control the helicopter by adults in the guidance and ensure the helicopter control in manipulator (or guides) line of sight range, easy to control.
8. Non-rechargeable battery is not charging,installation the lithium battery, please note that the battery polarity. Do not mix old batteries and new batteries or different type batteries.
9. Should be turn off the power of the controller and helicopter when not in use.
10. Power terminal is not allow short circuiting.

Ready to fly

1. Please recheck the ground, keep away from the crowds, animals and other barriers.
2. Turn the remote control on, after a while, the LEDs will be flashing. Push the motive handle must be pushed to the maximum control route of travel first, then adjust it to the lowest; When the remote control LEDs keep lighting, it means the helicopter is going to fly.
3. Open remote control power switch, then the remote status light was flashing and accompanied by the rhythmic sound, and then push up the up / down variable speed joystick to the top, then its back to the most low-end; the status of the remote controlThe indicator is lit and the sound stopped, the remote control to enter the preparatory off state.
4. Push the motive handle slowly, then the helicopter will fly up.

Low volatage protection

Low-voltage protection: When the helicopter battery is low, the helicopter control system battery will be protected, and stop the supply of helicopter rotor; low power protection, the need to charge to secure a new flight of the helicopter.

Overcurrent protection: When the helicopter blades in the rotating state by collision or jammed, the helicopter circuit overcurrent protection.

Maintenance

1. Cleaning the helicopter with clean and soft cloth.
2. Don't put the helicopter under the direct sun or strong lighting
3. Don't soak the toys in the water, or the electronic parts will be destructed.
4. Regularly check the plug and other spare parts, if find some parts broken, please stopping using till the product in good condition.

1-

Assembly transmitter & helicopter charging

Assembly transmitter

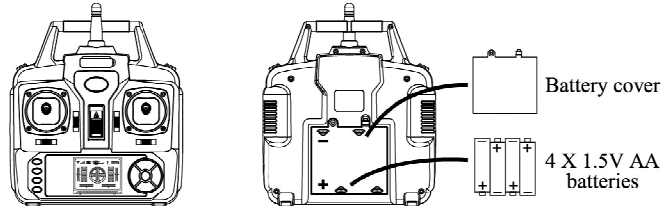

Install batteries: Open the cover of battery case, insert 4 batteries (size 1.5V AA) properly followed by polar indicator. (batteries to be purchased)



1. Install batteries carefully.
2. Do not mix old and new batteries.
3. Do not mix different types of batteries.

Battery-Helicopter

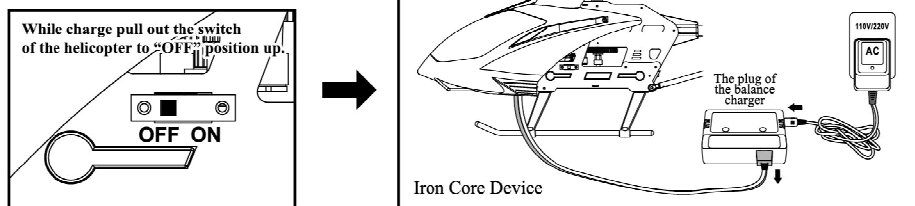

Balance charging (Iron core device)

- a. Plug the DC 10V output pin of the power adapter to the input of charge box, the red LED will light up at the time.
- b. Insert the three feet plug of battery to output port of charge box, and the green LED light up. When the green LED put out the recharging finishes.
(Note: When install the batteries to the charge box and the green LED does not change, it means the batteries are full and no need to recharge)

Iron core device charging time: can be 150 minutes flying about 7~8 minutes!

- Helicopter is equipped with a Li-Poly battery, please also pay attention to the following cautions or safety use.
- Do not use or leave the battery near a heat source such as fire or heater. Otherwise it will cause damage or explode.
- Do not use the battery slam or beating hard surface.
- Do not immerse the battery in water, and keep the battery in a cool dry place.
- Charger included with the product can only be used for the product charge.
- Do not disassemble the battery.
- Never leave the battery unattended during charging.

Remote Control Keypad and LCD

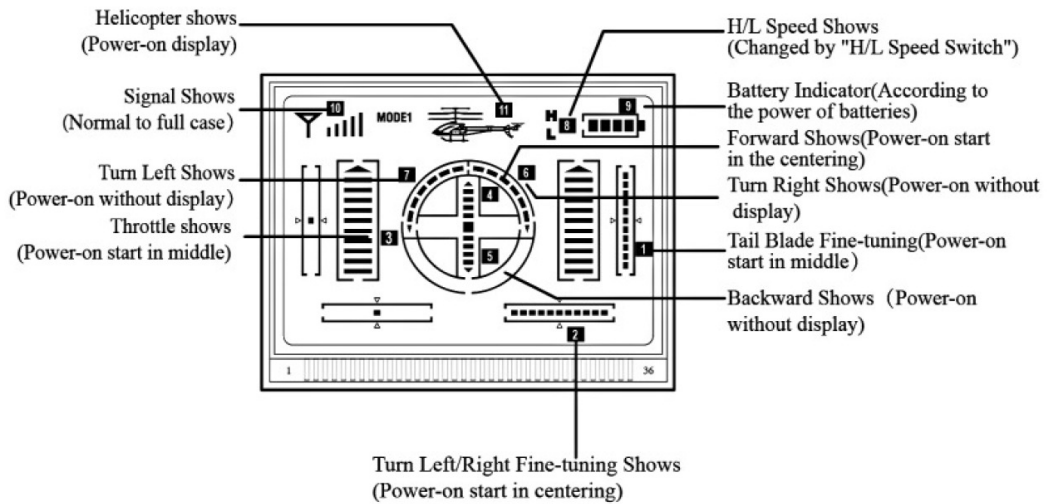
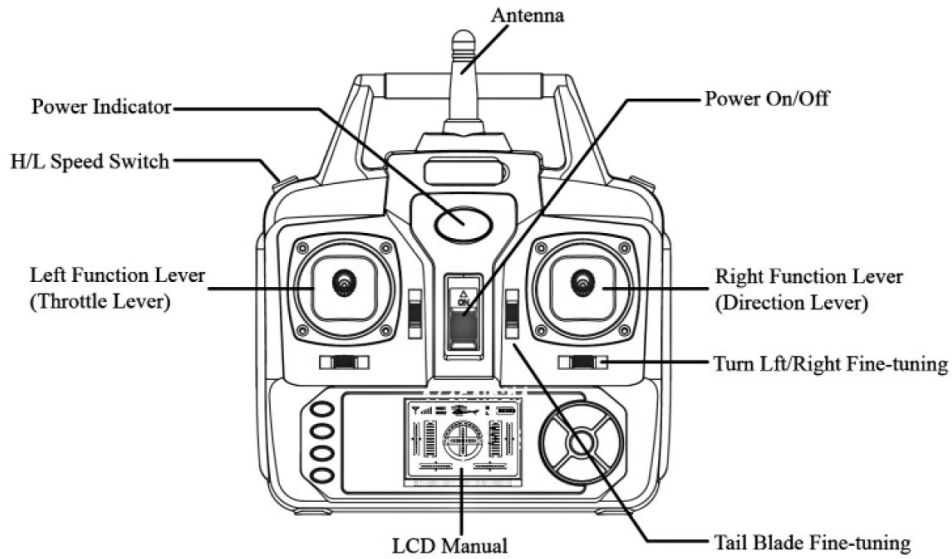

Helicopter control ways



Pushed the right stick (steering stick) to the left, the head of helicopter turns to left.



Push up the right stick (steering stick), the nose incline to down, the helicopter is moving to forward.

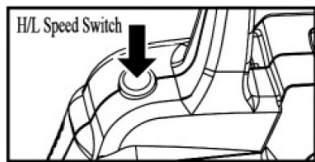

Build with two modes to both beginner and advanced.

1. Beginner mode (the default settings low speed)
2. Advanced mode: Press the button on top left of controller, enter or exit from the mode. Advanced mode high speed brings more pleasure to you

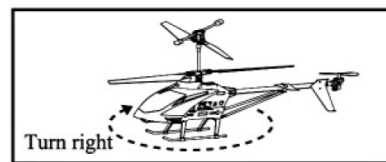

Pushed the right stick (steering stick) to the right, the head of helicopter turns to right.

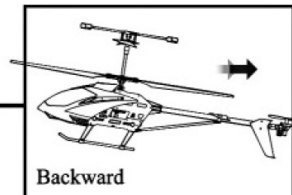
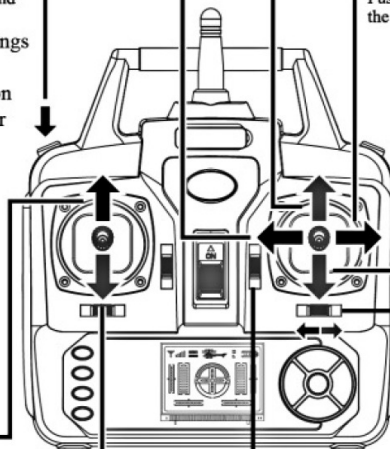

Push down the right stick (steering stick), the nose incline to up, the helicopter is moving to backward.

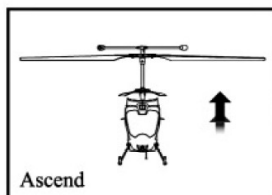

Push up the left stick (throttle stick), the spinning speed of the main rotor blade is increase and the helicopter begin to ascend.

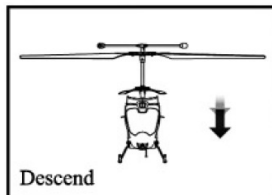

Push down the left stick (throttle stick), the spinning speed of the main rotor blade is decrease and the helicopter begin to descend.

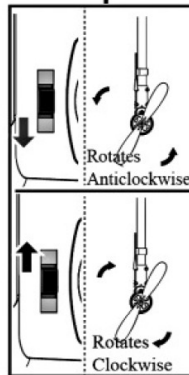

In hovering, when the tail blade rotates clockwise anticlockwise, please use this button for fine-tuning as figure shows.

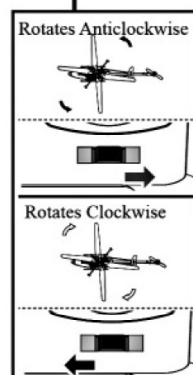























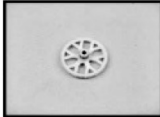



When the helicopter lose hovering with automatic anticlockwise/clockwise rotation, please use the right/left inching switch yo keep balance.

Maintenance program

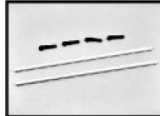
Problem	Cause	Check this
No reaction from the helicopter	1. Not enough power for the helicopter. 2. Not enough power for the controller. 3. The channel was different from helicopter and the controller. 4. The gyro of the helicopter can't find out the right point.	1. helicopter for charging. 2. replace the remote control batteries. 3. Close the remote control and the aircraft power supply, re-code. 4. The helicopter flat on the ground, re-open the helicopter power until the helicopter gyro re-tested.
Not reaction from the helicopter when was fly	1. the remote control are running low. 2. antenna Weld.	1. replace the remote control batteries. 2. antenna re-welding.

Spare parts list

Order by item number from local distributors.

					
S33-01 Head cover	S33-02 Main frame	S33-03 Battery case	S33-04 Ascend and descend	S33-05 Main blades	S33-06 Tail blade
					
S33-07 Connect buckle	S33-08 Top blades grip set	S33-09 Under blades grip set	S33-10 Transmission gear components	S33-11 Tail decoration	S33-12 Balance bar
					
S33-13 Gear A	S33-14 Gear B	S33-15 Light circuit	S33-16 Lights decoration	S33-17 Metal frame	S33-18 Motor protect slice
					
S33-19 Main shaft	S33-20 Tail competent	S33-21 Tail support pipe	S33-22 Tail motor set	S33-23 Motor A	S33-24 Motor B
					
S33-25 Tail motor set	S33-26 3.7V Li-Poly	S33-27 Circuit board			

Graphic detail

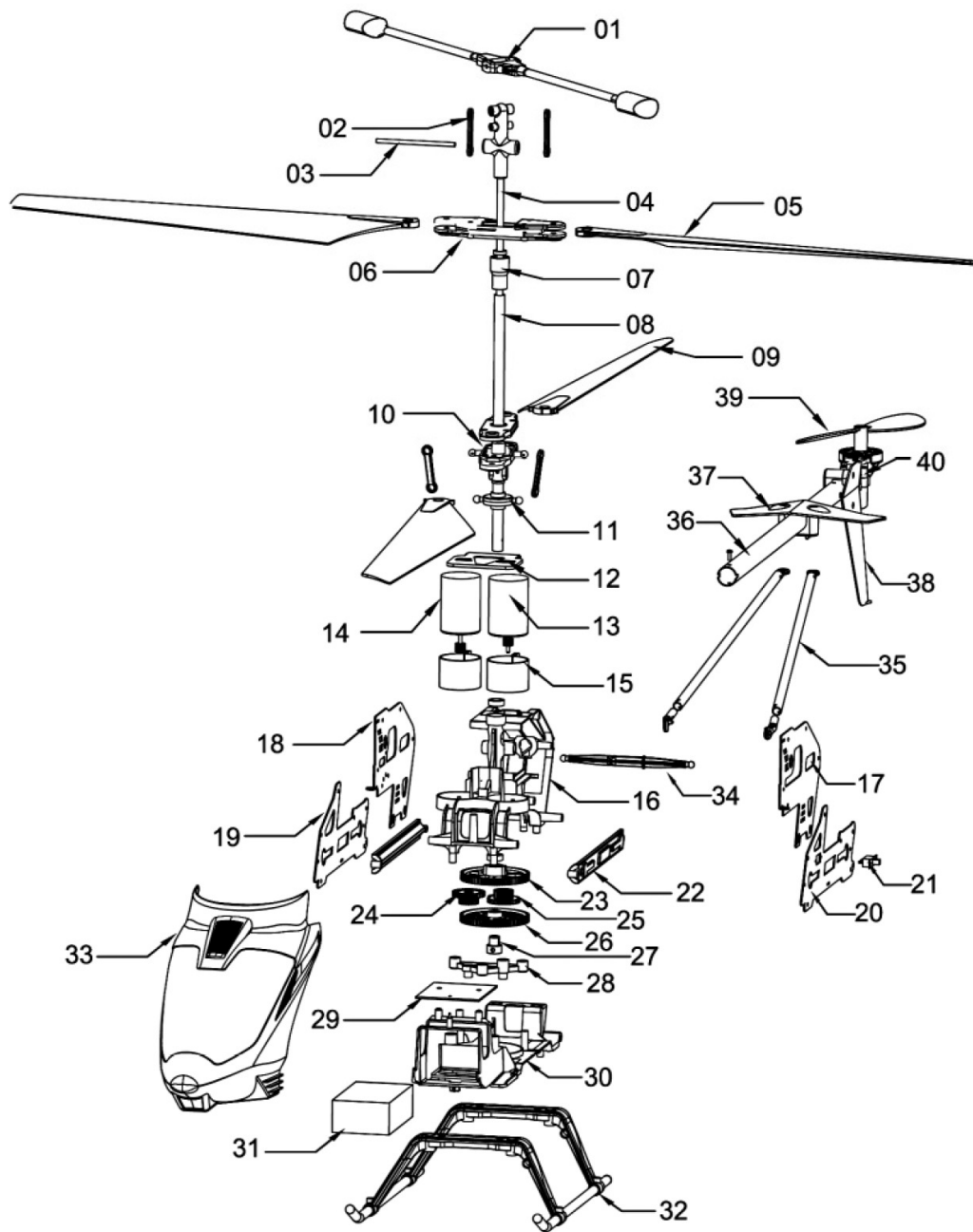

Ltem Number	Description	Qty Need	Ltem Number	Description	Qty Need
01	Balance bar	1	32	Ascend and descend	1
02	Connect buckle	2	33	Head cover	1
03	Screw	1	34	Head cover buckle	1
04	Inner shaft	1	35	Tail support price	2
05	Upper blade	2	36	Tail aluminum	1
06	Top blade grip set	1	37	Horizontal tail	1
07	Bearing set	1	38	Vertical fin	1
08	Stainless steel tube	1	39	Tail blade	1
09	Lower blade	2	40	Tail rotor rack module	1
10	Lower blade grip set	1			
11	Limit decoration	1			
12	Main frame decoration	1			
13	Main motor A	1			
14	Main motor B	1			
15	Motor cooling set	2			
16	Main frame	1			
17	Upper aluminum(right)	1			
18	Upper aluminum(left)	1			
19	Lower aluminum(right)	1			
20	Lower aluminum(left)	1			
21	ON/OFF	1			
22	Light bar	2			
23	Lower blade gear	1			
24	Transition lie 1	1			
25	Transition lie 2	1			
26	Upper blade gear	1			
27	Die steel set limit	1			
28	Triangle tableting	1			
29	PCB	1			
30	Underframe	1			
31	Battery	1			

This device complies with Part 15 of the FCC Rules. Operation is subject to the following two conditions: (1) this device may not cause harmful interference, and (2) this device must accept any interference received, including interference that may cause undesired operation.

Changes or modifications not expressly approved by the party responsible for compliance could void the user's authority to operate the equipment.

7-