



Product Description

Sirenza Microdevices' SXA-389B amplifier is a high efficiency GaAs Heterojunction Bipolar Transistor (HBT) MMIC housed in low-cost surface-mountable plastic package. These HBT MMICs are fabricated using molecular beam epitaxial growth technology which produces reliable and consistent performance from wafer to wafer and lot to lot.

These amplifiers are specially designed for use as driver devices for infrastructure equipment in the 400-2500 MHz cellular, ISM, WLL, PCS, W-CDMA applications.

Its high linearity makes it an ideal choice for multi-carrier as well as digital applications.

Typical OIP₃, P1dB, Gain

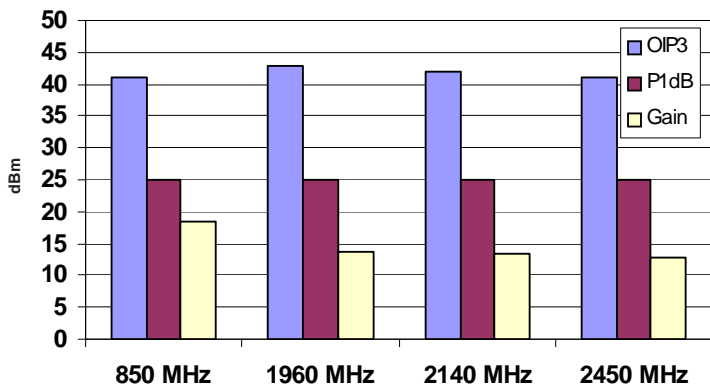

SXA-389B

SXA-389BZ



400-2500 MHz 1/4 W Medium Power GaAs HBT Amplifier with Active Bias



Product Features

- Now Available in Lead Free, RoHS Compliant, & Green Packaging
- Lower R_{th} for increased MTTF
10⁸ hrs. at T_{Lead} = 85°C
- On-chip Active Bias Control, Single 5V Supply
- Excellent Linearity:
+43 dBm typ. OIP₃ at 1960 MHz
- High P1dB : +25 dBm typ.
- High Gain: +18.5 dB at 850 MHz
- Efficient: consumes only 575 mW

Applications

- W-CDMA, PCS, Cellular Systems
- Multi-Carrier Applications

Symbol	Parameters: Test Conditions: Z ₀ = 50 Ohms, T _a = 25°C		Units	Min.	Typ.	Max.
P _{1dB}	Output Power at 1dB Compression	f = 850 MHz f = 1960 MHz f = 2140 MHz f = 2450 MHz	dBm	24	25 25 25 25	
S ₂₁	Small signal gain	f = 850 MHz f = 1960 MHz f = 2140 MHz f = 2450 MHz	dB	12.5	18.4 13.6 13.5 12.8	15
S ₁₁	Input VSWR	f = 850 MHz f = 1960 MHz f = 2140 MHz f = 2450 MHz	-		1.2:1 1.3:1 1.2:1 1.2:1	2.0:1
OIP ₃	Output Third Order Intercept Point (P _{out} /Tone = +11 dBm, Tone spacing = 1 MHz)	f = 850 MHz f = 1960 MHz f = 2140 MHz f = 2450 MHz	dBm	39	41 43 42 41	
NF	Noise Figure	f = 850 MHz f = 1960 MHz f = 2140 MHz f = 2450 MHz	dB		4.5 4.8 5.0 5.7	6.3
I _b	Device Current	V _{cc} = 5V	mA	90	115	135
P _{DISS}	Operating Dissipated Power		mW		575	
R _{th(j-l)}	Thermal Resistance (junction - lead)		° C/W		70	

The information provided herein is believed to be reliable at press time. Sirenza Microdevices assumes no responsibility for inaccuracies or omissions. Sirenza Microdevices assumes no responsibility for the use of this information, and all such information shall be entirely at the user's own risk. Prices and specifications are subject to change without notice. No patent rights or licenses to any of the circuits described herein are implied or granted to any third party. Sirenza Microdevices does not authorize or warrant any Sirenza Microdevices product for use in life-support devices and/or systems. Copyright 2003 Sirenza Microdevices, Inc. All worldwide rights reserved.

850 MHz Application Circuit Data, $V_{CC}=5V$, $I_D=115mA$

Note: Tuned for Output IP3

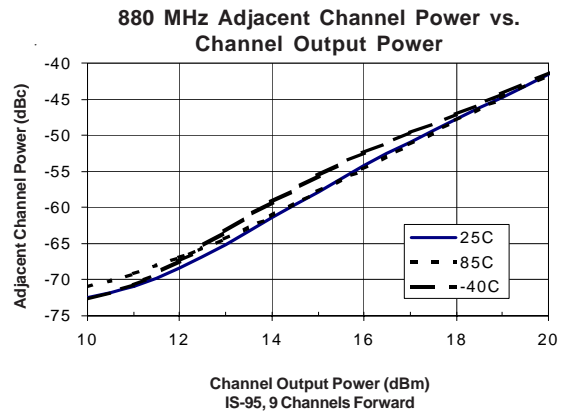
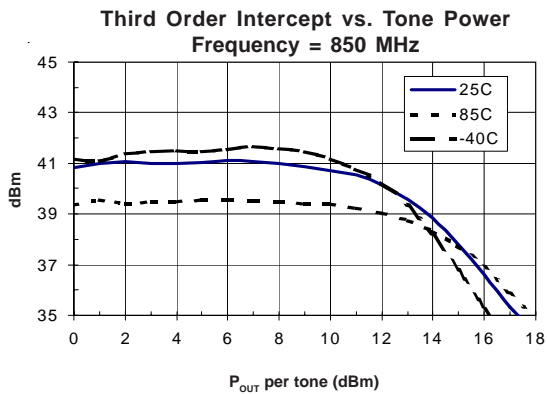
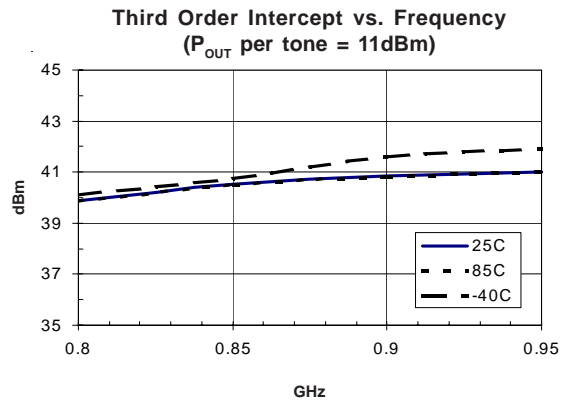
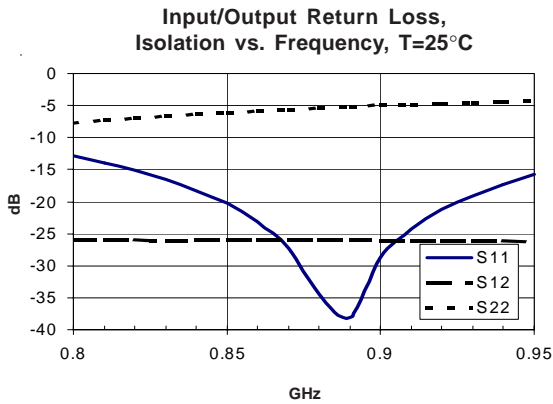
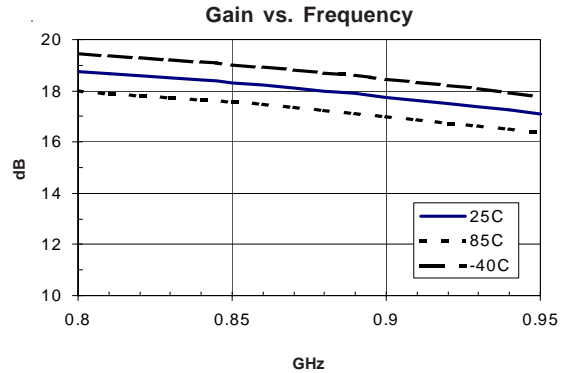
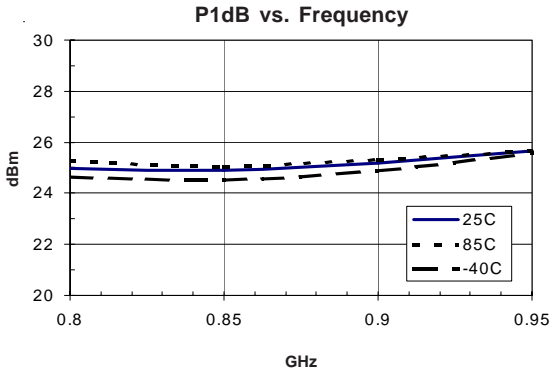

1960 MHz Application Circuit Data, $V_{CC} = 5V, I_D = 115mA$

Note: Tuned for Output IP3

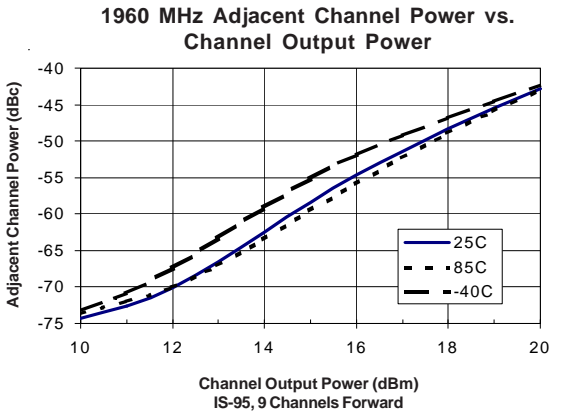
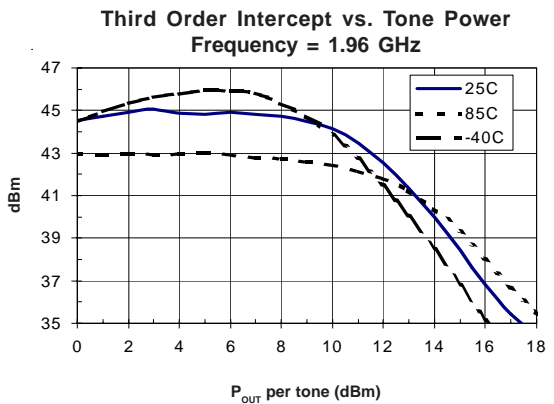
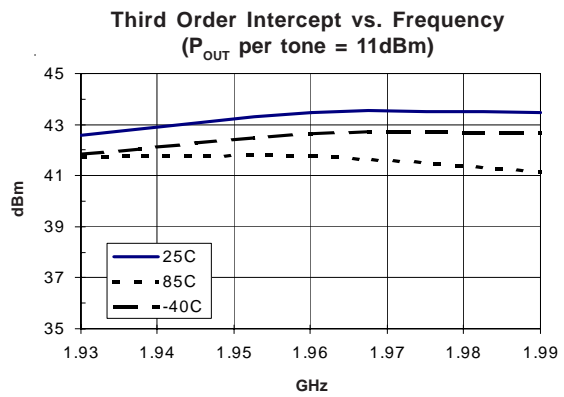
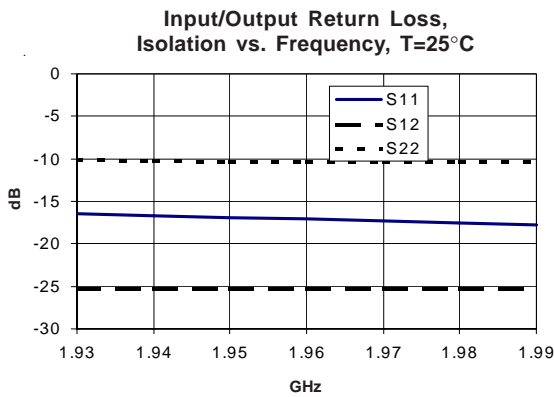
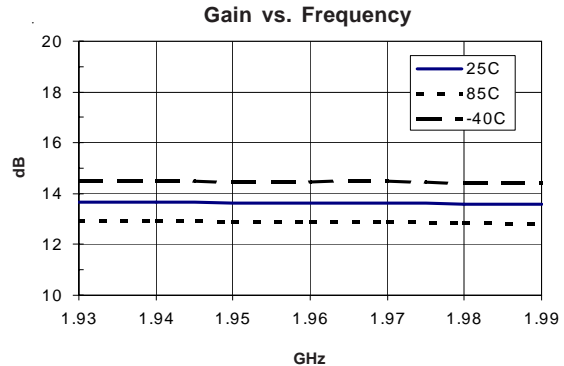
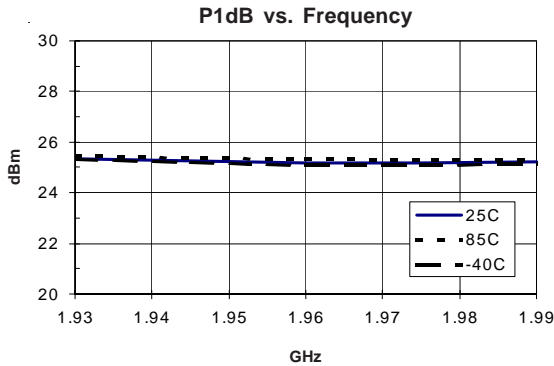

2140 MHz Application Circuit Data, $V_{CC}=5V$, $I_D=115mA$

Note: Tuned for Output IP3

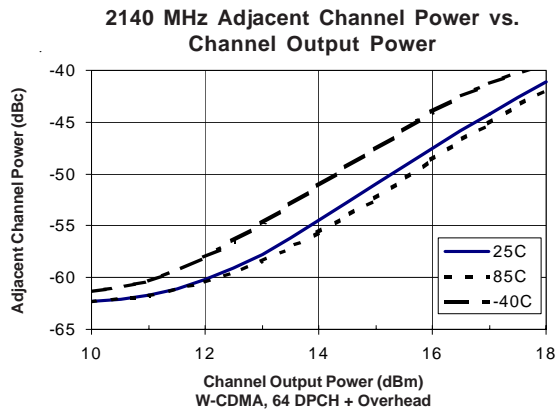
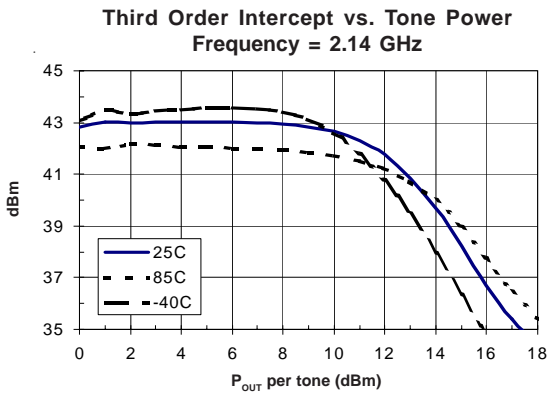
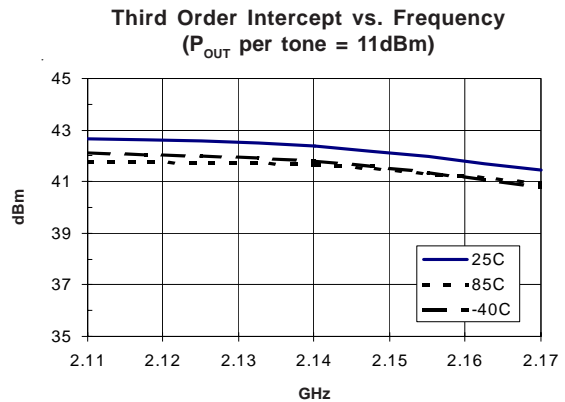
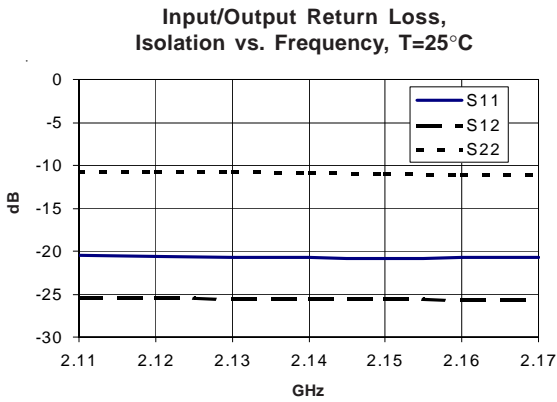
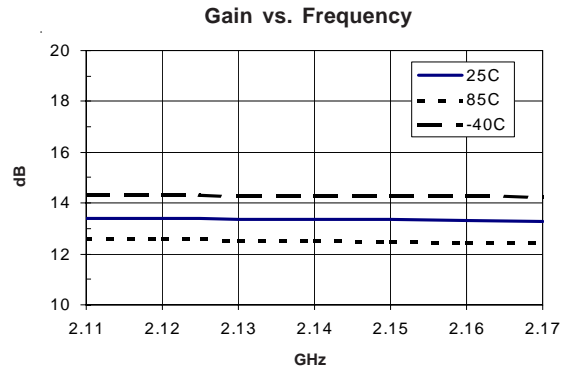
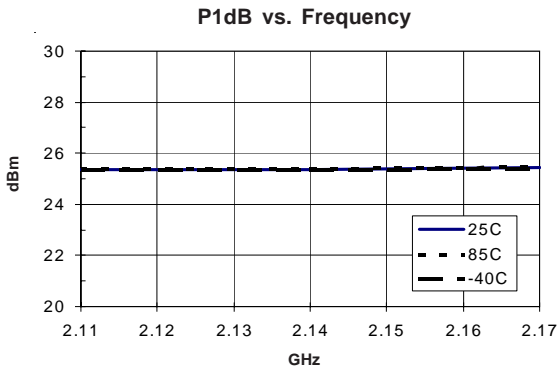

2450 MHz Application Circuit Data, $V_{CC}=5V$, $I_D=115mA$

Note: Tuned for Output IP3

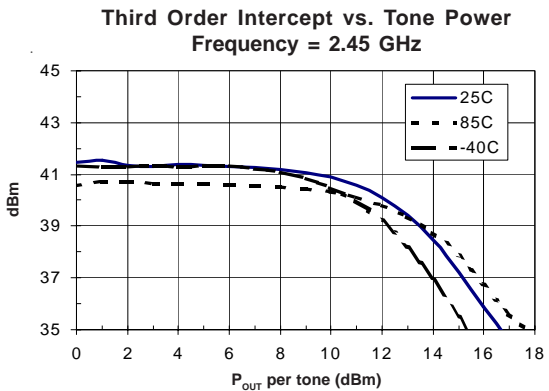
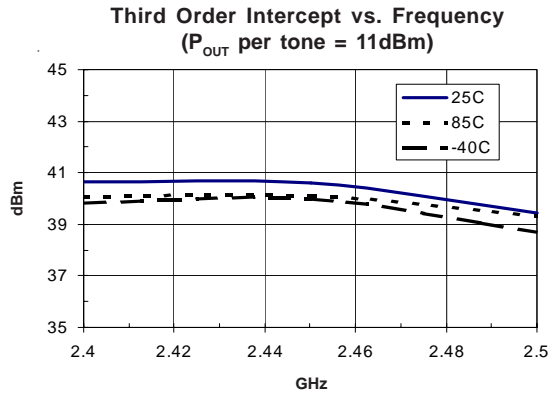
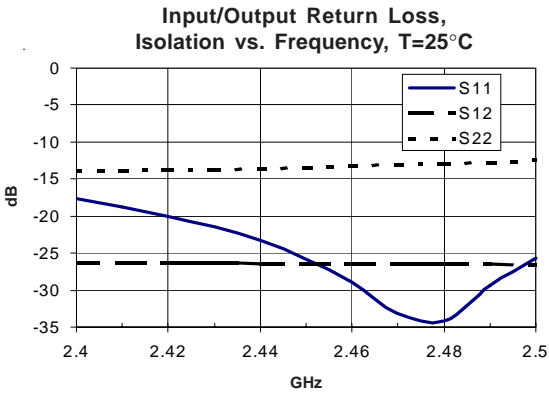
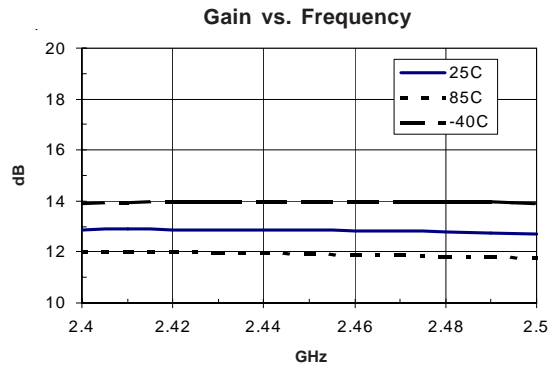
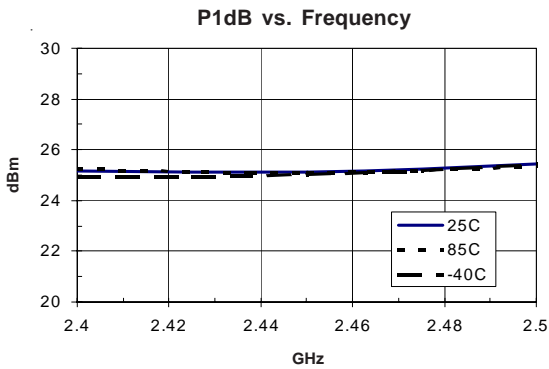

Application Schematic for 850 MHz, 2450 MHz

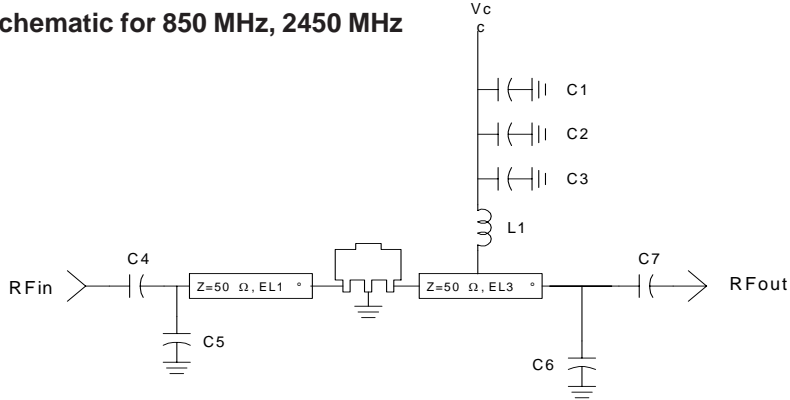

Ref. Des.	Vendor Series	850 MHz	2450 MHz
C1	Matsuo 267M3502104K	0.1uF 10%	0.1uF 10%
C2	Rohm MCH18	1000pF 5%	1000pF 5%
C3, C7	Rohm MCH18	47pF 5%	22pF 5%
C4	Rohm MCH18	47pF 5%	1.2pF ±0.25pF
C5	Rohm MCH18	5.6pF ±0.25pF	-

Ref. Des.	Vendor Series	850 MHz	2450 MHz
C6	Rohm MCH18	3.9pF ±0.25pF	1.0pF ±0.25pF
C6 Position		1	2
L1	Toko LL1608-FS	33nH 5%	15nH 5%
EL1		15	76
EL3		7.2	31.5

Evaluation Board Layout for 850 MHz, 2450 MHz

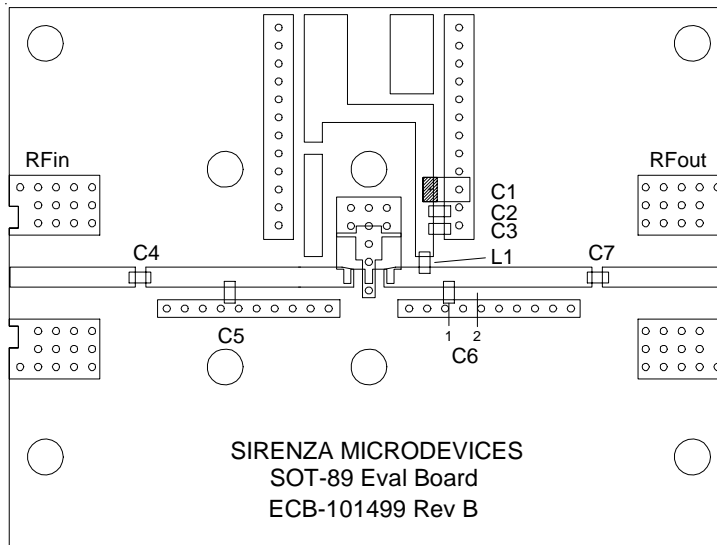

Application Schematic for 1960 MHz, 2140 MHz

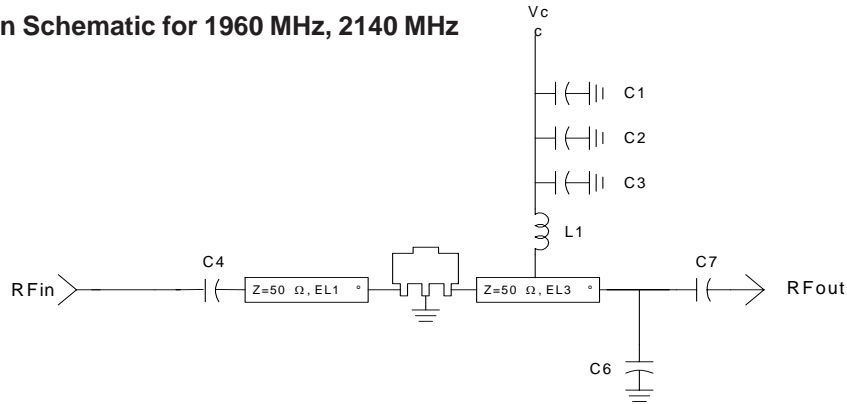

Ref. Des.	Vendor Series	1960/2140 MHz
C1	Matsuo 267M3502104K	0.1uF 10%
C2	Rohm MCH18	1000pF 5%
C3, C7	Rohm MCH18	22pF 5%
C4	Rohm MCH18	2.2pF ±0.25pF
C5	Rohm MCH18	-

Ref. Des.	Vendor Series	1960/2140 MHz
C6	Rohm MCH18	1.0pF ±0.25pF
L1	Toko LL1608-FS	18nH 5%
EL1		35
EL3		30

Evaluation Board Layout for 1960 MHz, 2140 MHz

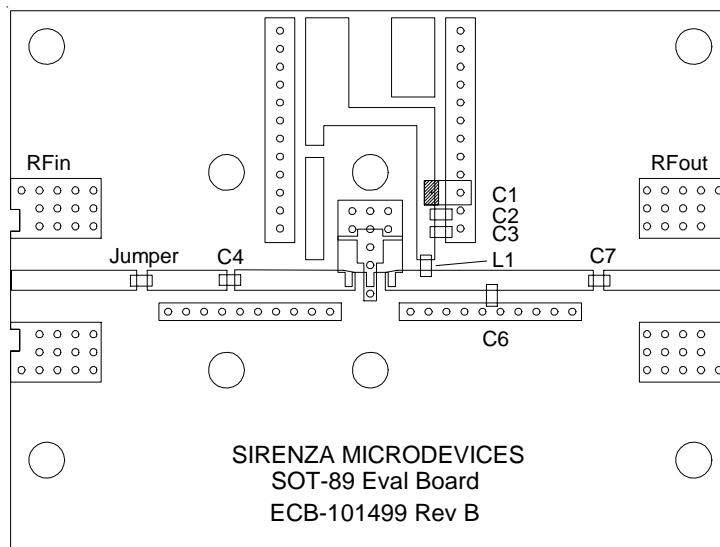

Absolute Maximum Ratings

Parameter	Absolute Limit
Max. Supply Current (I_b)	240 mA
Max. Device Voltage (V_{cc})	6.0 V
Max. Power Dissipation	1500 mW
Max. RF Input Power	100 mW
Max. Junction Temp. (T_j)	+165 °C
Operating Lead Temp. (T_L)	-40 to +85 °C
Max. Storage Temp.	+150 °C

Operation of this device beyond any one of these limits may cause permanent damage. For reliable continuous operation, the device voltage and current must not exceed the maximum operating values specified in the table on page one.

Bias Conditions should also satisfy the following expression:
 $I_b V_{cc} (max) < (T_j - T_{j0}) / R_{\theta j-c}$



ESD: Class 1B (Passes 500V ESD Pulse)
 Appropriate precautions in handling, packaging and testing devices must be observed.

Part Number Ordering Information

Part Number	Devices Per Reel	Reel Size
SXA-389B	1000	7"
SXA-389BZ	1000	7"

Pin Description

Pin #	Function	Description
1	Base	Base Pin
2	GND & Emitter	Connection to ground. Use via holes to reduce lead inductance. Place vias as close to ground leads as possible.
3	Collector	Collector Pin
4	GND & Emitter	Same as Pin 2

Part Identification Marking

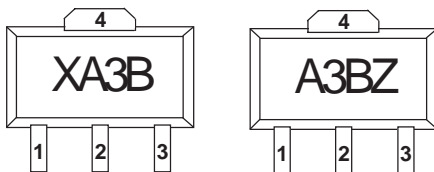

**See Application Note AN-075
 for Package Outline Drawing**

Recommended Mounting Configuration for Optimum RF and Thermal Performance

