

## FCC IC RF Test Report

**Report No.:** FCC\_IC\_SL20051401-JAD-003\_HF

**FCC ID:** QV5MERCURY3E

**IC:** 5407A-MERCURY3E

**Models:** M3e

**Received Date:** 07/07/2020

**Test Date:** 07/28/2020-07/30/2020

**Issued Date:** 08/06/2020

**Applicant name:** JADAK, a business unit of Novanta Corporation

**Address:** 125 Middlesex Turnpike, Bedford, MA 01730

**Manufacturer:** JADAK, a business unit of Novanta Corporation

**Address:** 125 Middlesex Turnpike, Bedford, MA 01730

**Issued By:** Bureau Veritas Consumer Products Services, Inc.

**Lab Address:** 775 Montague Expressway, Milpitas, CA 95035

**FCC Registration /  
Designation Number:** 540430

**ISED# / CAB identifier:** 4842D



TESTING CERT # 2742-01

This report is for your exclusive use. Any copying or replication of this report to or for any other person or entity, or use of our name or trademark, is permitted only with our prior written permission. This report sets forth our findings solely with respect to the test samples identified herein. The results set forth in this report are not indicative or representative of the quality or characteristics of the lot from which a test sample was taken or any similar or identical product unless specifically and expressly noted. Our report includes all of the tests requested by you and the results thereof based upon the information that you provided to us. You have 60 days from date of issuance of this report to notify us of any material error or omission caused by our negligence, provided, however, that such notice shall be in writing and shall specifically address the issue you wish to raise. A failure to raise such issue within the prescribed time shall constitute your unqualified acceptance of the completeness of this report, the tests conducted and the correctness of the report contents. Unless specifically mentioned, the uncertainty of measurement has been explicitly taken into account to declare the compliance or non-compliance to the specification. The report must not be used by the client to claim product certification, approval, or endorsement by A2LA or any government agencies.

## Table of Contents

<b>Release Control Record .....</b>	<b>3</b>
<b>1 Certificate of Conformity.....</b>	<b>4</b>
<b>2 Summary of Test Results .....</b>	<b>5</b>
2.1 Measurement Uncertainty .....	5
2.2 Modification Record .....	5
<b>3 General Information.....</b>	<b>6</b>
3.1 General Description of EUT .....	6
3.2 Description of Test Modes .....	7
3.2.1 1 channel is provided to this EUT.....	7
3.2.2 Test Mode Applicability and Tested Channel Detail.....	7
3.3 Description of Support Units .....	8
3.3.1 Configuration of System under Test .....	8
3.4 General Description of Applied Standards .....	8
<b>4 Test Types and Results .....</b>	<b>9</b>
4.1 Radiated Emission Measurement .....	9
4.1.1 Limits of Radiated Emission Measurement .....	9
4.1.2 Test Instruments .....	10
4.1.3 Test Procedures.....	11
4.1.4 Deviation from Test Standard .....	11
4.1.5 Test Setup.....	12
4.1.6 EUT Operating Conditions.....	12
4.1.7 Test Results .....	13
4.2 Conducted Emission Measurement .....	18
4.2.1 Limits of Conducted Emission Measurement .....	18
4.2.2 Test Instruments .....	18
4.2.3 Test Procedures.....	18
4.2.4 Deviation from Test Standard .....	18
4.2.5 Test Setup.....	19
4.2.6 EUT Operating Conditions.....	19
4.2.7 Test Results .....	20
4.3 Frequency Stability.....	22
4.3.1 Limits of Frequency Stability Measurement .....	22
4.3.2 Test Setup.....	22
4.3.3 Test Instruments .....	22
4.3.4 Test Procedure .....	22
4.3.5 Deviation from Test Standard .....	22
4.3.6 EUT Operating Conditions.....	22
4.3.7 Test Result .....	23
4.4 20dB Bandwidth .....	24
4.4.1 Limits of 20dB Bandwidth Measurement.....	24
4.4.2 Test Setup.....	24
4.4.3 Test Instruments .....	24
4.4.4 Test Procedures.....	24
4.4.5 Deviation from Test Standard .....	24
4.4.6 EUT Operating Conditions.....	24
4.4.7 Test Results .....	25
<b>5 Pictures of Test Arrangements.....</b>	<b>26</b>
<b>Appendix – Information on the Testing Laboratories .....</b>	<b>27</b>



### Release Control Record

Issue No.	Description	Date Issued
FCC_IC_SL20051401-JAD-003_HF	Initial Release	08/06/2020



## 2 Summary of Test Results

47 CFR FCC Part 15, Subpart C (Section 15.225 / 15.215) RSS 210 Issue 9, RSS Gen Issue 5			
FCC IC Clause	Test Item	Result	Remarks
15.207 RSS Gen 8.8	AC Power Conducted Emission	Pass	Meet the requirement of limit.
15.225 (a) RSS 210 B.6.a.i	The field strength of any emissions within the band 13.553-13.567 MHz	Pass	Meet the requirement of limit.
15.225 (b) RSS 210 B.6.a.ii	The field strength of any emissions within the bands 13.410-13.553 MHz and 13.567-13.710 MHz	Pass	Meet the requirement of limit.
15.225 (c) RSS 210 B.6.a.iii	The field strength of any emissions within the bands 13.110-13.410 MHz and 13.710-14.010 MHz	Pass	Meet the requirement of limit.
15.225 (d) RSS Gen	The field strength of any emissions appearing outside of the 13.110-14.010 MHz band	Pass	Meet the requirement of limit.
15.225 (e) RSS 210 B.6.b	The frequency tolerance	Pass	Meet the requirement of limit.
15.215 (c) RSS Gen 6.7	20dB Bandwidth & 99% Bandwidth	Pass	Meet the requirement of limit.

### 2.1 Measurement Uncertainty

Where relevant, the following measurement uncertainty levels have been estimated for tests performed on the EUT as specified in CISPR 16-4-2:

Measurement	Frequency	Expanded Uncertainty (k=2) ( $\pm$ )
Conducted Emissions at mains ports	150kHz ~ 30MHz	3.51dB
Radiated Emissions up to 1 GHz	30MHz ~ 1GHz	3.73dB

### 2.2 Modification Record

There were no modifications required for compliance.

### 3 General Information

#### 3.1 General Description of EUT

Product	M3E LF/HF Embedded RFID Module
Brand	JADAK, a business unit of Novanta Corporation
Test Model	M3e
Status of EUT	Engineering sample
Power Supply Rating	5Vdc
Modulation Type	ASK
Operating Frequency	13.56 MHz (HF)
Antenna Type	PCB loop antenna for 13.56 MHz (HF)
Antenna inductance	1uH nominal for 13.56 MHz (HF)

Note:

1. The above EUT information is declared by manufacturer and for more detailed features description, please refers to the manufacturer's specifications or user's manual.

### 3.2 Description of Test Modes

3.2.1 1 channel is provided to this EUT

Channel	Freq. (MHz)
1	13.56

3.2.2 Test Mode Applicability and Tested Channel Detail

EUT CONFIGURE MODE	APPLICABLE TO				DESCRIPTION
	RE	PLC	FS	EB	
A	-	-	-	√	Power from battery
B	√	√	√	-	Power from USB via laptop

Where **RE:** Radiated Emission **PLC:** Power Line Conducted Emission  
**FS:** Frequency Stability **EB:** 20dB Bandwidth measurement

**NOTE:** The EUT had been pre-tested on the positioned of each 3 axis. The worst case was found when positioned on **Y-plane**.  
**NOTE:** "-" means no effect.

#### Radiated Emission Test:

- Pre-Scan has been conducted to determine the worst-case mode from all possible combinations between available modulations, data rates and antenna ports (if EUT with antenna diversity architecture).
- Following channel(s) was (were) selected for the final test as listed below.

EUT Configure Mode	Available Channel	Tested Channel	Modulation Type
B	1	1	ASK

#### Power Line Conducted Emission Test:

- Pre-Scan has been conducted to determine the worst-case mode from all possible combinations between available modulations, data rates and antenna ports (if EUT with antenna diversity architecture).
- Following channel(s) was (were) selected for the final test as listed below.

EUT Configure Mode	Available Channel	Tested Channel	Modulation Type
B	1	1	ASK

#### Frequency Stability:

- Pre-Scan has been conducted to determine the worst-case mode from all possible combinations between available modulations, data rates and antenna ports (if EUT with antenna diversity architecture).
- Following channel(s) was (were) selected for the final test as listed below.

EUT Configure Mode	Available Channel	Tested Channel	Modulation Type
B	1	1	ASK

#### Test Condition:

APPLICABLE TO	ENVIRONMENTAL CONDITIONS	INPUT POWER	TESTED BY
RE	25deg. C, 65%RH	5Vdc	Deon Dai
PLC	25deg. C, 65%RH	5Vdc	Deon Dai
FS	25deg. C, 68%RH	5Vdc	Deon Dai
BW	21deg. C, 60%RH	5Vdc	Deon Dai

### 3.3 Description of Support Units

The EUT has been tested as an independent unit together with other necessary accessories or support units. The following support units or accessories were used to form a representative test configuration during the tests.

ID	Product	Brand	Model No.	Serial No.	FCC ID	Remarks
A.	Laptop	Thinkpad	0578-CTO	LR-16MAW	-	Provided by Customer
B.						

ID	Descriptions	Qty.	Length (m)	Shielding (Yes/No)	Cores (Qty.)	Remarks
1.	USB cable	1	0.8	N	0	Provided by Customer

Note: The core(s) is(are) originally attached to the cable(s).

#### 3.3.1 Configuration of System under Test

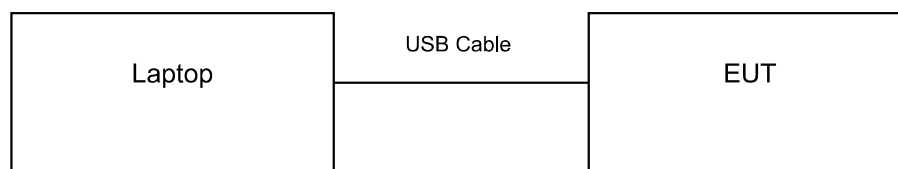

### 3.4 General Description of Applied Standards

The EUT is a RF Product. According to the specifications of the manufacturer, it must comply with the requirements of the following standards:

**47 CFR FCC Part 15, Subpart C (Section 15.225)**

**47 CFR FCC Part 15, Subpart C (Section 15.215)**

**RSS 210 Issue 9, August 2016**

**ANSI C63.10:2013**

**RSS Gen Issue 5, March 2019**

All test items have been performed and recorded as per the above standards.



## 4 Test Types and Results

### 4.1 Radiated Emission Measurement

#### 4.1.1 Limits of Radiated Emission Measurement

The field strength of any emissions within the band 13.553-13.567 MHz shall not exceed 15,848 microvolts/meter at 30 meters.

Within the bands 13.410-13.553 MHz and 13.567-13.710 MHz, the field strength of any emissions shall not exceed 334 microvolts/meter at 30 meters.

Within the bands 13.110-13.410 MHz and 13.710-14.010 MHz the field strength of any emissions shall not exceed 106 microvolts/meter at 30 meters.

The field strength of any emissions appearing outside of the 13.110-14.010 MHz band shall not exceed the general radiated emission limits in § 15.209.

Frequencies (MHz)	Field Strength (microvolts/meter)	Measurement Distance (meters)
0.009 ~ 0.490	2400/F(kHz)	300
0.490 ~ 1.705	24000/F(kHz)	30
1.705 ~ 30.0	30	30
30 ~ 88	100	3
88 ~ 216	150	3
216 ~ 960	200	3
Above 960	500	3

#### NOTE:

1. The lower limit shall apply at the transition frequencies.
2. Distance extrapolation factor =  $40 \log (\text{specific distance} / \text{test distance})$   
Limit Line (dBuV/m) =  $20 \log \text{Emission level (uV/m)} + \text{Distance extrapolation factor}$
3. For frequencies above 1000MHz, the field strength limits are based on average detector, however, the peak field strength of any emission shall not exceed the maximum permitted average limits, specified above by more than 20dB under any condition of modulation.

## 4.1.2 Test Instruments

DESCRIPTION & MANUFACTURER	MODEL NO.	SERIAL NO.	DATE OF CALIBRATION	DUE DATE OF CALIBRATION
EMI Test Receiver ROHDE & SCHWARZ	ESW 44	100179	08/30/2019	08/30/2020
Passive Loop Antenna (9k-30MHz)	6512	49120	07/14/2020	07/14/2021
Hybrid Antenna SUNAR	JB6	A111717	03/09/2020	03/09/2021
Preamplifier RF-BAY	LNA-150	12170607	02/16/2020	02/16/2021

#### 4.1.3 Test Procedures

##### **For Radiated emission below 30MHz**

- a. The EUT was placed on the top of a rotating table 0.8 meters above the ground at a 3 meter chamber room. The table was rotated 360 degrees to determine the position of the highest radiation.
- b. The EUT was set 3 meters away from the interference-receiving antenna, which was mounted on the top of a variable-height antenna tower.
- c. Parallel, perpendicular, and ground-parallel orientations of the antenna are set to make the measurement.
- d. For each suspected emission, the EUT was arranged to its worst case and the rotatable table was turned from 0 degrees to 360 degrees to find the maximum reading.
- e. The test-receiver system was set to Quasi-Peak Detect Function and Specified Bandwidth with Maximum Hold Mode.

##### **NOTE:**

1. The resolution bandwidth and video bandwidth of test receiver/spectrum analyzer is 9 kHz at frequency below 30MHz.

##### **For Radiated emission above 30MHz**

- a. The EUT was placed on the top of a rotating table 0.8 meters (for 30MHz ~ 1GHz) / 1.5 meters (for above 1GHz) above the ground at 3 meter chamber room for test. The table was rotated 360 degrees to determine the position of the highest radiation.
- b. The EUT was set 3 meters away from the interference-receiving antenna, which was mounted on the top of a variable-height antenna tower.
- c. The height of antenna is varied from one meter to four meters above the ground to determine the maximum value of the field strength. Both horizontal and vertical polarizations of the antenna are set to make the measurement.
- d. For each suspected emission, the EUT was arranged to its worst case and then the antenna was tuned to heights from 1 meter to 4 meters and the rotatable table was turned from 0 degrees to 360 degrees to find the maximum reading.
- e. The test-receiver system was set to quasi-peak detect function and specified bandwidth with maximum hold mode when the test frequency is below 1 GHz.
- f. The test-receiver system was set to peak and average detects function and specified bandwidth with maximum hold mode when the test frequency is above 1 GHz. If the peak reading value also meets average limit, measurement with the average detector is unnecessary.

##### **Note:**

1. The resolution bandwidth and video bandwidth of test receiver/spectrum analyzer is 120 kHz for Quasi-peak detection (QP) at frequency below 1GHz.
2. The resolution bandwidth of test receiver/spectrum analyzer is 1 MHz and the video bandwidth is 3 MHz for Peak detection (PK) at frequency above 1GHz.
3. The resolution bandwidth of test receiver/spectrum analyzer is 1MHz and the video bandwidth is  $\geq 1/T$  (Duty cycle  $< 98\%$ ) or 10Hz (Duty cycle  $\geq 98\%$ ) for Average detection (AV) at frequency above 1GHz.
4. All modes of operation were investigated and the worst-case emissions are reported.

#### 4.1.4 Deviation from Test Standard

No deviation.

#### 4.1.5 Test Setup

##### For Radiated emission below 30MHz

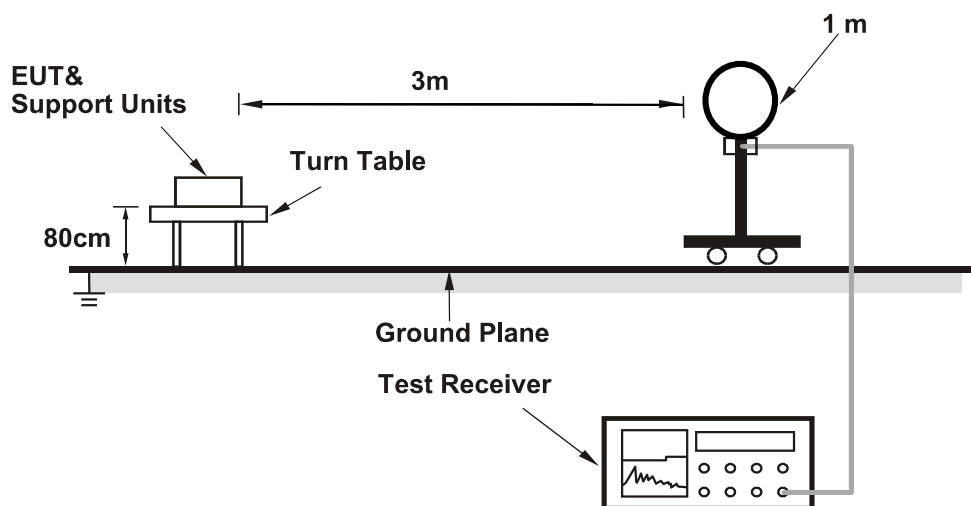

##### For Radiated emission 30MHz to 1GHz

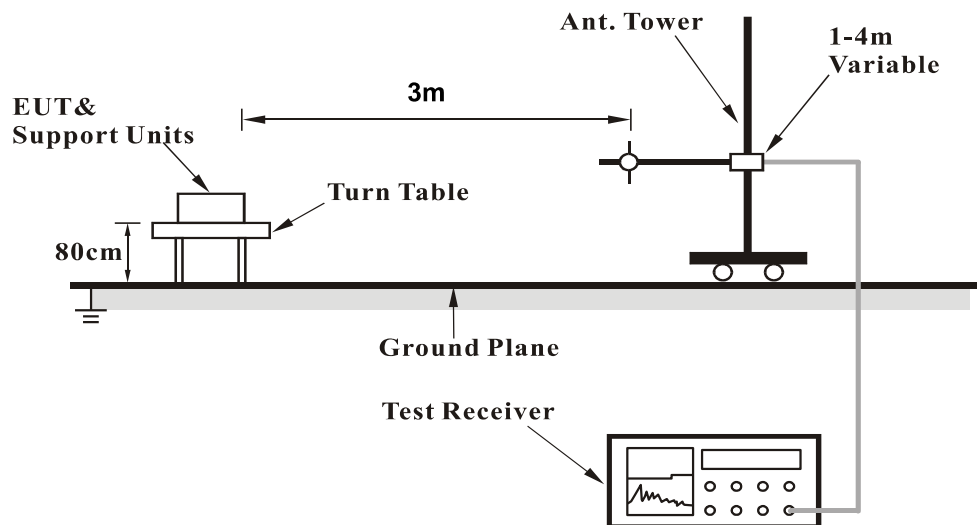

#### 4.1.6 EUT Operating Conditions

- a. Connected the EUT with the Notebook Computer which is placed on remote site.
- b. Controlling software has been activated to set the EUT on specific status.

4.1.7 Test Results

**Field strength of Fundermental Emissions**

EUT Test Condition		Measurement Detail	
Channel	Channel 1	Frequency Range	13.553 ~ 13.567MHz
Input Power	DC5V	Detector Function	Quasi-Peak
Environmental Conditions	25 deg. C, 70% RH	Tested By	Deon Dai

Antenna Polarity & Test Distance: Loop Antenna 0 degree At 3m

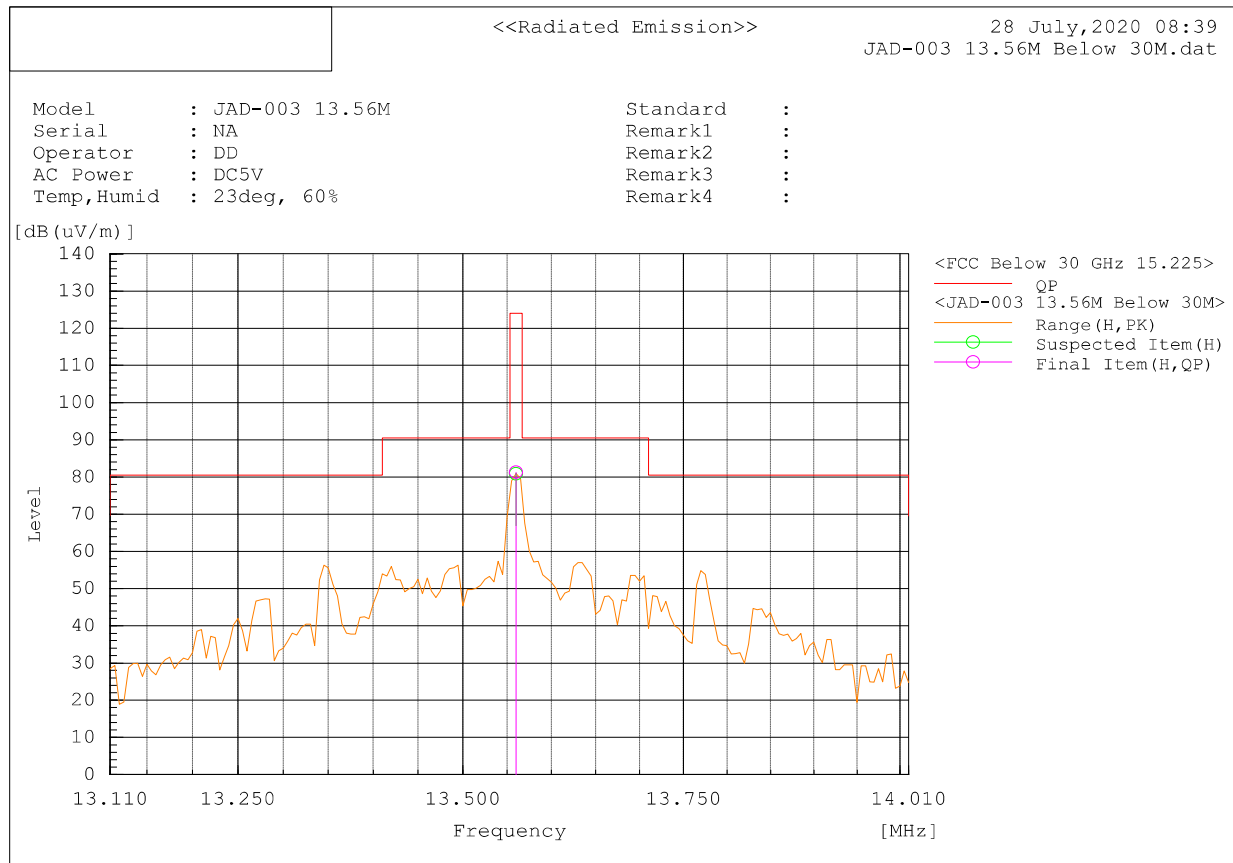

Antenna Polarity & Test Distance: Loop Antenna 0 degree At 3m

No.	Frequency (MHz)	Polarization	Reading QP [dB(uV)]	Factor [dB(1/m)]	Level QP [dB(uV/m)]	LimitQP dB(uV/m)	Margin QP [dB]	Height (cm)	Angle (Deg)	Pass/ Fail
1	13.56	0	79.5	1.8	81.3	124	-42.7	100	214	Pass

**REMARKS:**

1. Level (dBUV) = Reading (dBUV) + Factor (dB(1/m)).
2. Factor (dB(1/m)) = Antenna Factor(AF) (dB(1/m)) + Cable Loss (dB)
3. Margin value = Emission level – Limit value.

**Antenna Polarity & Test Distance: Loop Antenna 90 degree At 3m**

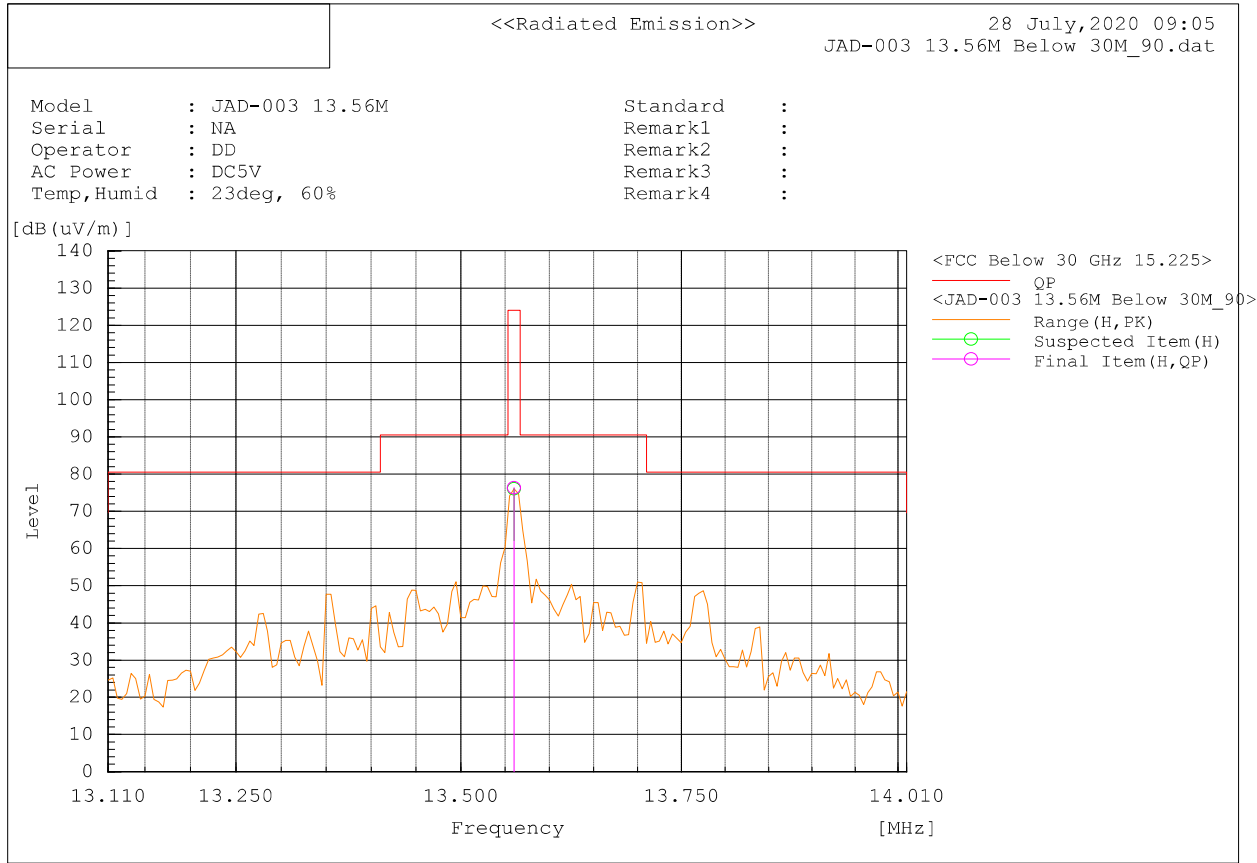

**Antenna Polarity & Test Distance: Loop Antenna 90 degree At 3m**

No.	Frequency (MHz)	Polarization	Reading QP [dB(uV)]	Factor [dB(1/m)]	Level QP [dB(uV/m)]	Limit\QP dB(uV/m)	Margin QP [dB]	Height (cm)	Angle (Deg)	Pass/ Fail
1	13.56	90	74.6	1.8	76.4	124	-47.6	100	134.8	Pass

**REMARKS:**

1. Level (dBuV) = Reading (dBuV) + Factor (dB(1/m)).
2. Factor (dB(1/m)) = Antenna Factor(AF) (dB(1/m)) + Cable Loss (dB)
3. Margin value = Emission level – Limit value.

## Radiated Emissions (9 kHz~30 MHz)

EUT Test Condition		Measurement Detail	
Channel	Channel 1	Frequency Range	13.56MHz
Input Power	DC5V	Detector Function	Quasi-Peak
Environmental Conditions	25 deg. C, 70% RH	Tested By	Deon Dai

Antenna Polarity & Test Distance: Loop Antenna 0 degree At 3m										
No.	Frequency (MHz)	Polarization	Reading QP [dB(uV)]	Factor [dB(1/m)]	Level QP [dB(uV/m)]	LimitQP dB(uV/m)	Margin QP [dB]	Height (cm)	Angle (Deg)	Pass/Fail
1	0.294	0	32.1	23	55.1	98.2	-43.1	100	2.4	Pass
2	0.589	0	32.4	17.1	49.5	72.2	-22.7	100	12.4	Pass
3	0.879	0	27.7	13.9	41.6	68.7	-27.1	100	80.9	Pass
4	1.174	0	26.5	11.7	38.2	66.2	-28	100	181	Pass
5	1.354	0	30.8	10.7	41.5	65	-23.5	100	49.4	Pass
6	13.56	0	79.5	1.8	81.3	124	-42.7	100	214	Pass

### REMARKS:

1. Level (dBuV) = Reading (dBuV) + Factor (dB(1/m)).
2. Factor (dB(1/m)) = Antenna Factor(AF) (dB(1/m)) + Cable Loss (dB)
3. Margin value = Emission level – Limit value.

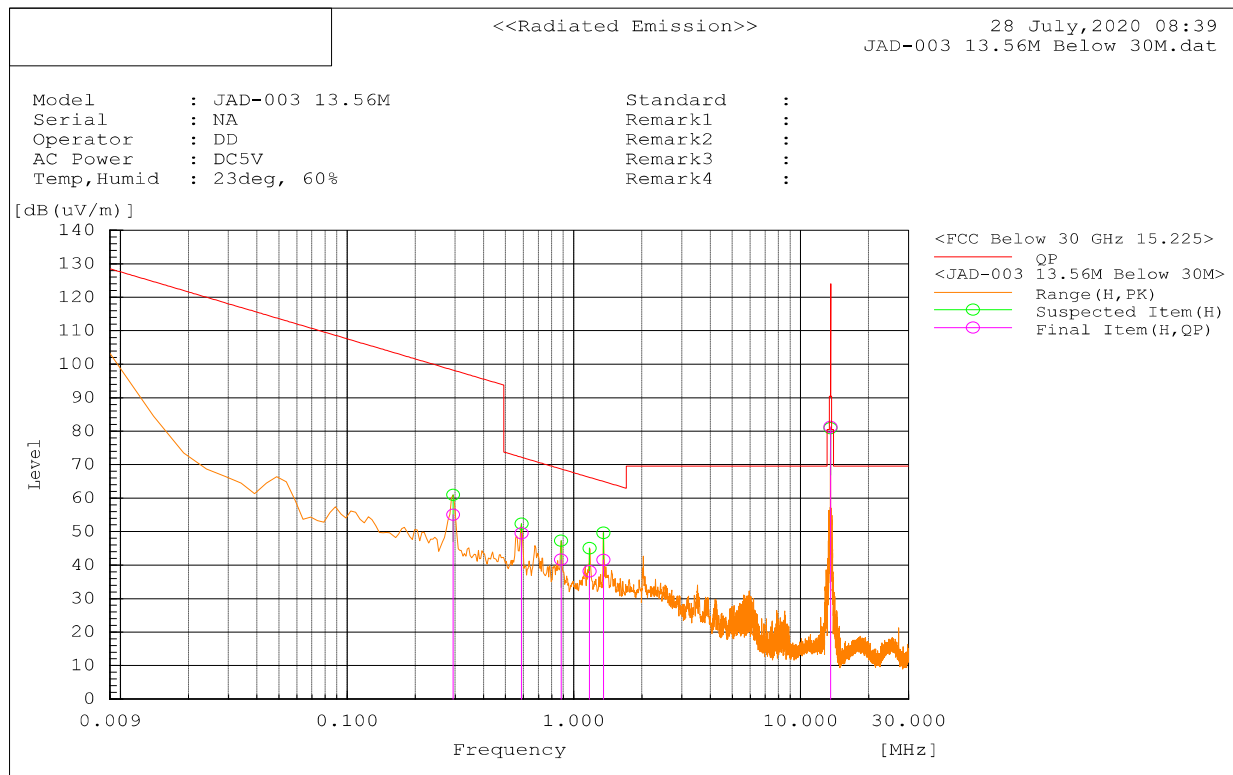

EUT Test Condition		Measurement Detail	
Channel	Channel 1	Frequency Range	Below 30MHz
Input Power	DC5V	Detector Function	Quasi-Peak
Environmental Conditions	25 deg. C, 70% RH	Tested By	Deon Dai

Antenna Polarity & Test Distance: Loop Antenna 90 degree At 3m										
No.	Frequency (MHz)	Polarization	Reading QP [dB(uV)]	Factor [dB(1/m)]	Level QP [dB(uV/m)]	LimitQP dB(uV/m)	Margin QP [dB]	Height (cm)	Angle (Deg)	Pass/Fail
1	0.009	90	59.3	51.5	111	128.5	-17.7	100	328	Pass
2	0.284	90	26.9	23.3	50.2	98.5	-48.3	100	144	Pass
3	0.589	90	27.1	17.1	44.2	72.2	-28	100	150	Pass
4	0.724	90	24	15.5	39.5	70.4	-30.9	100	144	Pass
5	1.179	90	26.2	11.7	37.9	66.2	-28.3	100	119	Pass
6	13.56	90	74.6	1.8	76.4	124	-47.6	100	135	Pass

**REMARKS:**

1. Level (dBuV) = Reading (dBuV) + Factor (dB(1/m)).
2. Factor (dB(1/m)) = Antenna Factor(AF) (dB(1/m)) + Cable Loss (dB)
3. Margin value = Emission level – Limit value.

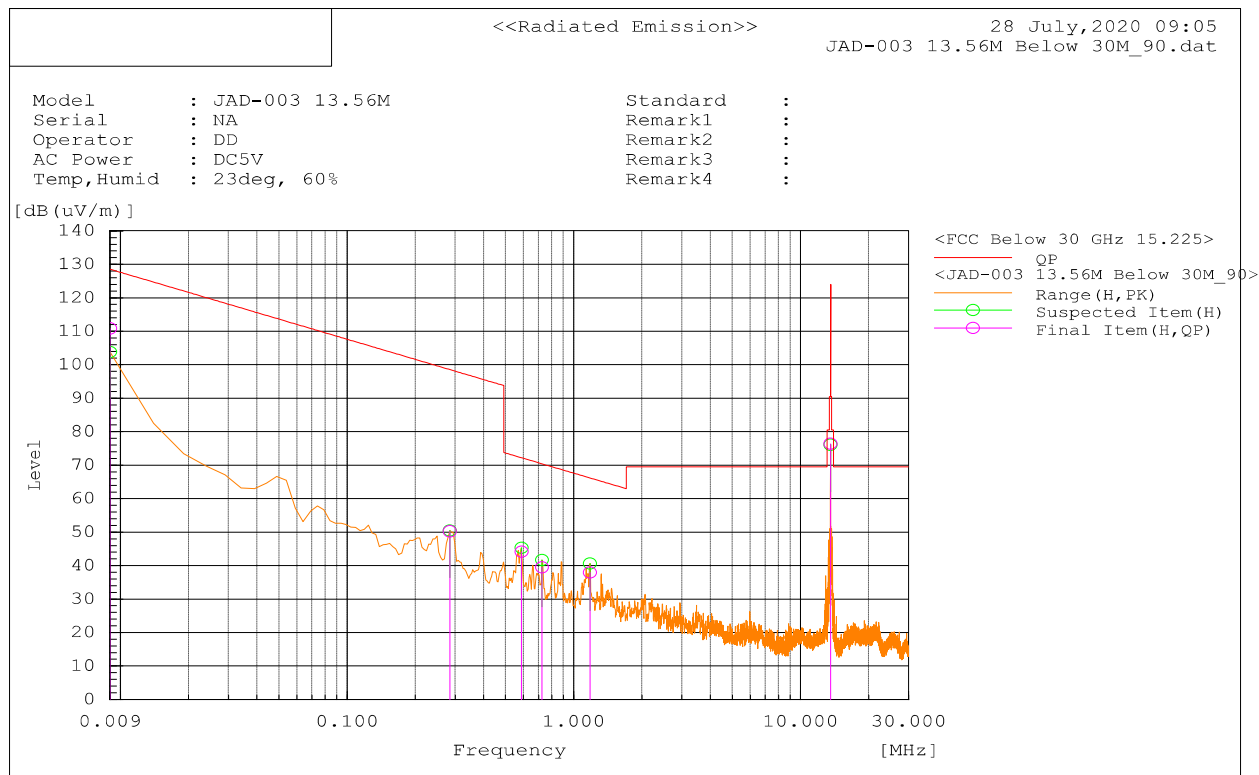



## Radiated Emissions (30 MHz~1000 MHz)

EUT Test Condition		Measurement Detail	
Channel	Channel 1	Frequency Range	13.56MHz
Input Power	DC 5V	Detector Function	Quasi-Peak
Environmental Conditions	25 deg. C, 70% RH	Tested By	Deon Dai

Antenna Polarity & Test Distance: Horizontal & Vertical at 3 m

No.	Frequency (MHz)	Polarization	Reading QP [dB(uV)]	Factor [dB(1/m)]	Level QP [dB(uV/m)]	LimitQP dB(uV/m)	Margin QP [dB]	Height (cm)	Angle (Deg)	Pass/Fail
1	108.484	H	23.4	18.3	41.7	43.5	-1.8	Pass	285	Pass
2	122.042	H	23.6	19.4	43	43.5	-0.5	Pass	252	Pass
3	135.597	H	23.1	19.3	42.4	43.5	-1.1	Pass	219	Pass
4	336.759	H	7.1	20.9	28	46	-18	Pass	112	Pass
5	488.151	H	13.3	25.3	38.6	46	-7.4	Pass	180	Pass
6	528.862	V	13.7	25.3	39	46	-7	Pass	112	Pass

### REMARKS:

1. Level (dBuV) = Reading (dBuV) + Factor (dB(1/m)).
2. Factor (dB(1/m)) = Antenna Factor(AF) (dB(1/m)) + Cable Loss (dB)
3. Margin value = Emission level – Limit value.

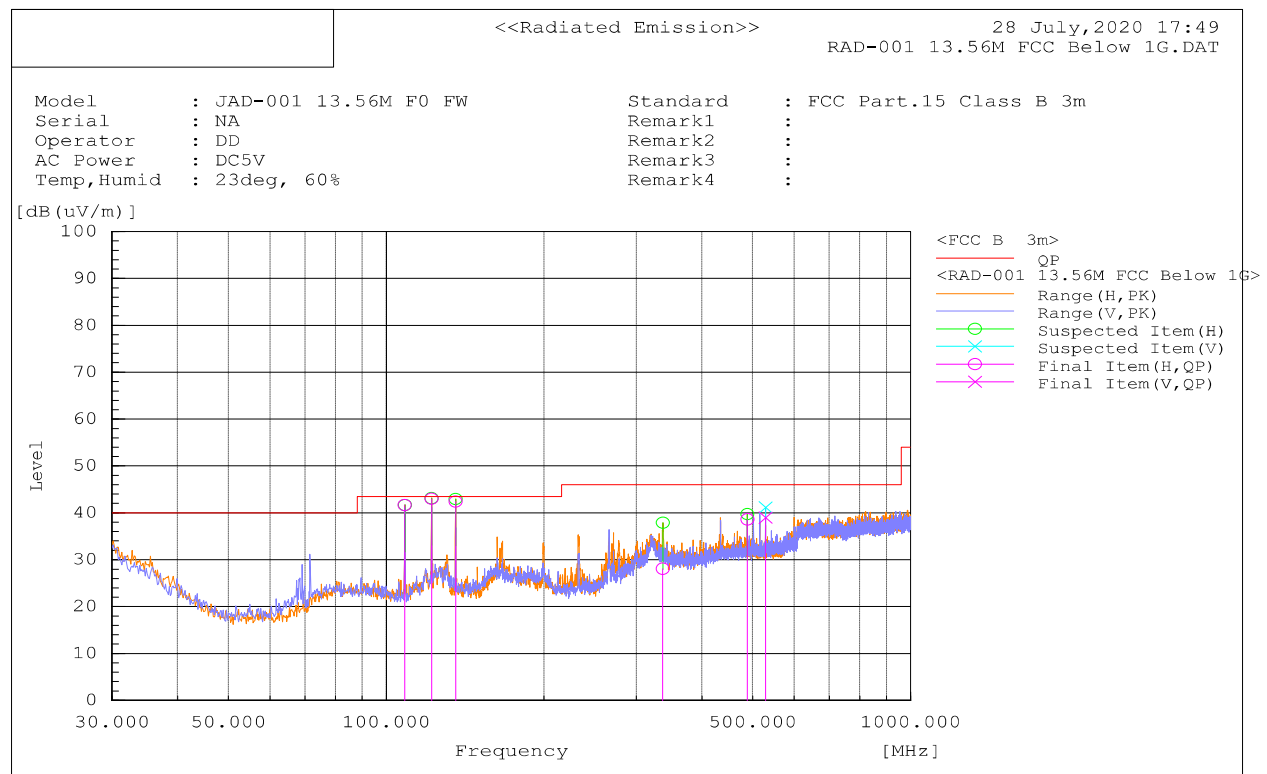

## 4.2 Conducted Emission Measurement

### 4.2.1 Limits of Conducted Emission Measurement

Frequency (MHz)	Conducted Limit (dBuV)	
	Quasi-peak	Average
0.15 - 0.5	66 - 56	56 - 46
0.50 - 5.0	56	46
5.0 - 30.0	60	50

Note: 1. The lower limit shall apply at the transition frequencies.

2. The limit decreases in line with the logarithm of the frequency in the range of 0.15 to 0.50MHz.

### 4.2.2 Test Instruments

Description & Manufacturer	Model No.	Serial No.	Date Of Calibration	Due Date Of Calibration
EMI Test Receiver ROHDE & SCHWARZ	ESIB 40	100179	08/28/2019	08/28/2020
Transient Limiter ELECTRO-METRICS	EM-7600-5	106	12/31/2019	12/31/2020
LISN EMCO	3816/2NM	214372	04/10/2019	04/10/2020

### 4.2.3 Test Procedures

- The EUT was placed 0.4 meters from the conducting wall of the shielded room with EUT being connected to the power mains through a line impedance stabilization network (LISN). Other support units were connected to the power mains through another LISN. The two LISNs provide 50 ohm/ 50uH of coupling impedance for the measuring instrument.
- Both lines of the power mains connected to the EUT were checked for maximum conducted interference.
- The frequency range from 150 kHz to 30MHz was searched. Emission levels under (Limit - 20dB) was not recorded.

**NOTE:** The resolution bandwidth and video bandwidth of test receiver is 9 kHz for quasi-peak detection (QP) and average detection (AV) at frequency 0.15MHz-30MHz.

### 4.2.4 Deviation from Test Standard

No deviation.

4.2.5

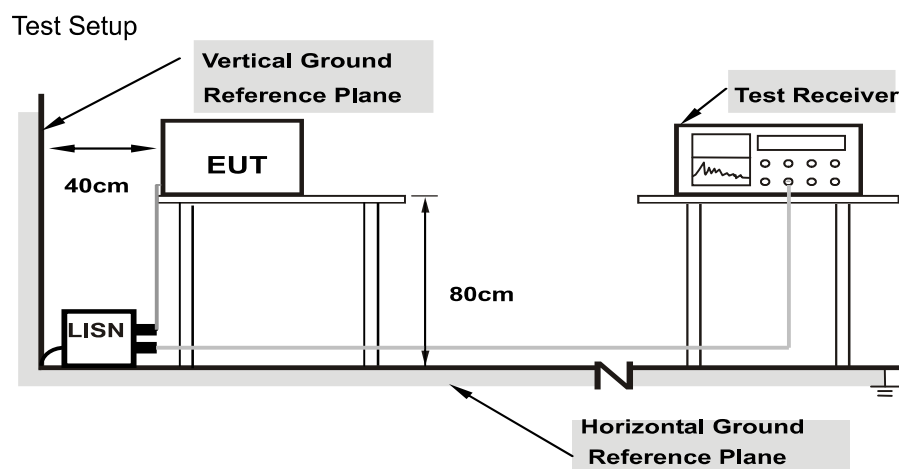

**Note: 1.Support units were connected to second LISN.**

For the actual test configuration, please refer to the attached file (Test Setup Photo).

4.2.6 EUT Operating Conditions

Same as 4.1.6.

#### 4.2.7 Test Results

Phase	Line (L)	Detector Function	Quasi-Peak / Average
-------	----------	-------------------	----------------------

No	Freq.	Raw	Calc Loss	Factors	Level	Measurement Type	Line	Limit	Margin	Pass /Fail
	[MHz]	(dBuV)	(dB)	(dB)	(dBuV)			(dBuV)	(dB)	
1	0.565647	28.31	9.46	0.04	37.81	Quasi Peak	Live	56	-18.19	Pass
2	0.547467	28.81	9.45	0.04	38.3	Quasi Peak	Live	56	-17.7	Pass
3	3.05892	25.55	9.52	0.06	35.14	Quasi Peak	Live	56	-20.86	Pass
4	2.695583	25.9	9.51	0.06	35.47	Quasi Peak	Live	56	-20.53	Pass
5	0.921655	26.46	9.48	0.04	35.98	Quasi Peak	Live	56	-20.02	Pass
6	21.66786	25.54	9.79	0.53	35.86	Quasi Peak	Live	60	-24.14	Pass
7	0.565647	16.31	9.46	0.04	25.8	Average	Live	46	-20.2	Pass
8	0.547467	17.24	9.45	0.04	26.73	Average	Live	46	-19.27	Pass
9	3.05892	20.81	9.52	0.06	30.4	Average	Live	46	-15.6	Pass
10	2.695583	20.62	9.51	0.06	30.18	Average	Live	46	-15.82	Pass
11	0.921655	19.85	9.48	0.04	29.37	Average	Live	46	-16.63	Pass
12	21.66786	19.76	9.79	0.53	30.08	Average	Live	50	-19.92	Pass

#### REMARKS:

1. The emission levels of other frequencies were very low against the limit.
2. Margin value = Emission level - Limit value
3. Emission Level = Correction Factor + Raw Value + Factors Value.

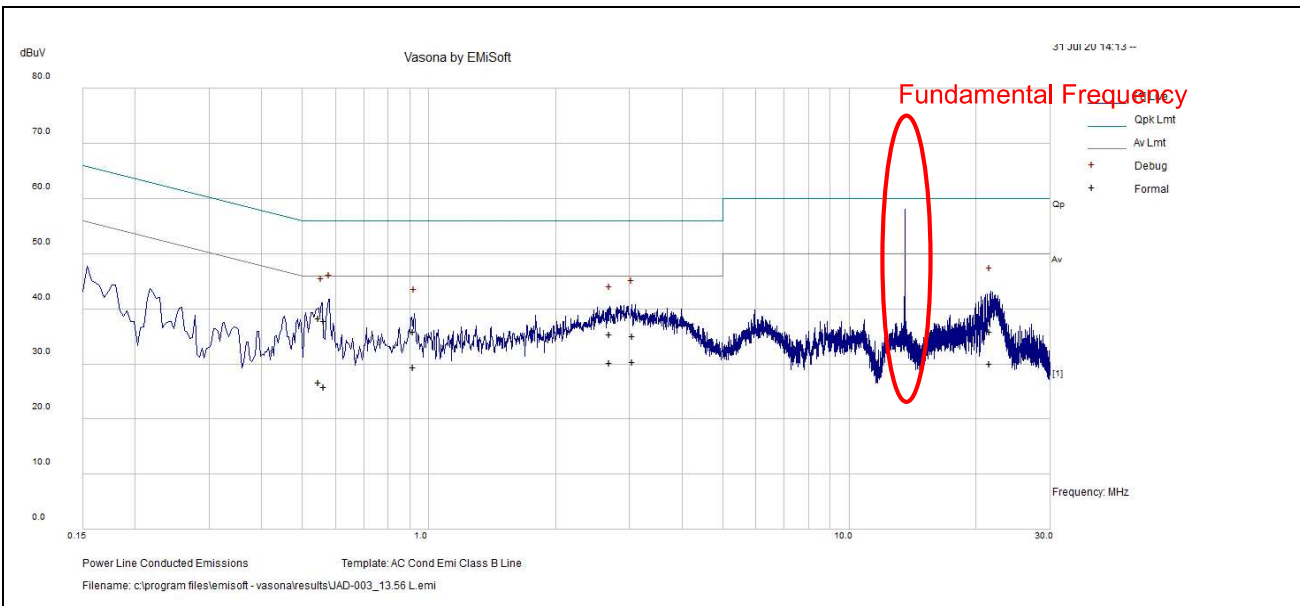

Phase	Neutral (N)	Detector Function	Quasi-Peak / Average
-------	-------------	-------------------	----------------------

No	Freq.	Raw	Cale Loss	Factors	Level	Measurement Type	Line	Limit	Margin	Pass /Fail
	[MHz]	(dBuV)	(dB)	(dB)	(dBuV)			(dBuV)	(dB)	
1	22.14851	13.77	9.79	0.55	24.11	Quasi Peak	Neutral	60	-35.89	Pass
2	21.93713	14.41	9.78	0.54	24.73	Quasi Peak	Neutral	60	-35.27	Pass
3	20.73783	15.26	9.8	0.5	25.56	Quasi Peak	Neutral	60	-34.44	Pass
4	22.45707	12.67	9.81	0.56	23.05	Quasi Peak	Neutral	60	-36.95	Pass
5	21.59386	15.4	9.79	0.53	25.72	Quasi Peak	Neutral	60	-34.28	Pass
6	2.489439	23.87	9.5	0.05	33.42	Quasi Peak	Neutral	56	-22.58	Pass
7	22.14851	12.25	9.79	0.55	22.59	Average	Neutral	50	-27.41	Pass
8	21.93713	8.9	9.78	0.54	19.22	Average	Neutral	50	-30.78	Pass
9	20.73783	10.56	9.8	0.5	20.86	Average	Neutral	50	-29.14	Pass
10	22.45707	9.67	9.81	0.56	20.04	Average	Neutral	50	-29.96	Pass
11	21.59386	15.56	9.79	0.53	25.87	Average	Neutral	50	-24.13	Pass
12	2.489439	17.49	9.5	0.05	27.04	Average	Neutral	46	-18.96	Pass

**REMARKS:**

1. The emission levels of other frequencies were very low against the limit.
2. Margin value = Emission level - Limit value
3. Emission Level = Correction Factor + Raw Value + Factors Value.

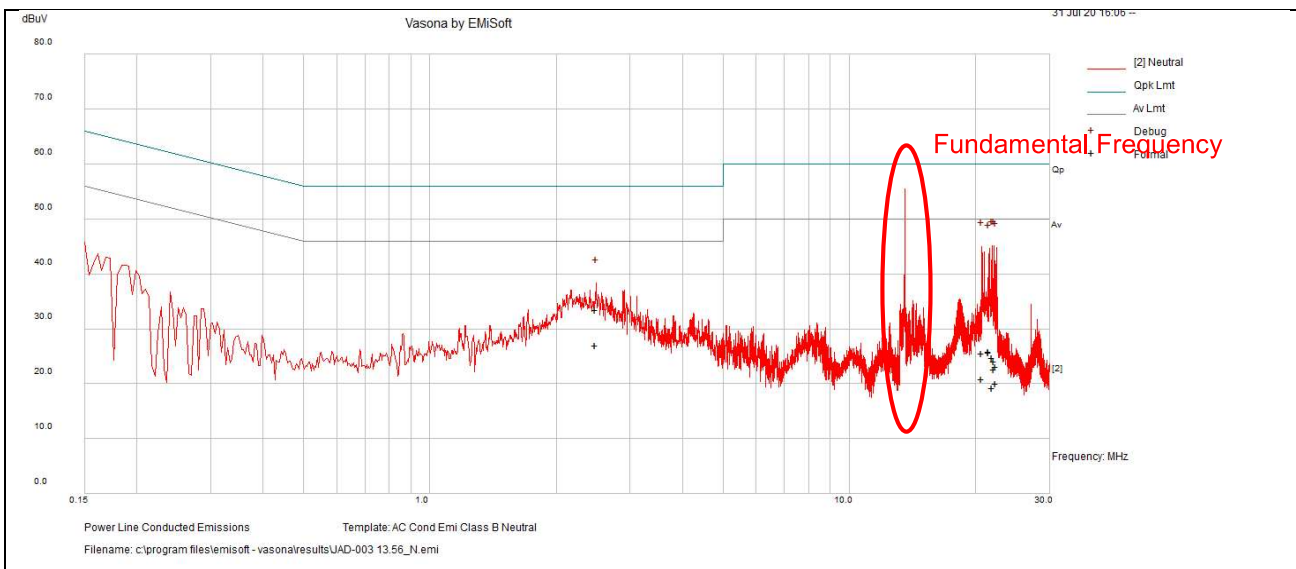

### 4.3 Frequency Stability

#### 4.3.1 Limits of Frequency Stability Measurement

The frequency tolerance of the carrier signal shall be maintained within  $\pm 0.01\%$  of the operating frequency over a temperature variation of  $-20$  degrees to  $50$  degrees C at normal supply voltage, and for a variation in the primary supply voltage from  $85\%$  to  $115\%$  of the rated supply voltage at a temperature of  $20$  degrees C.

#### 4.3.2 Test Setup

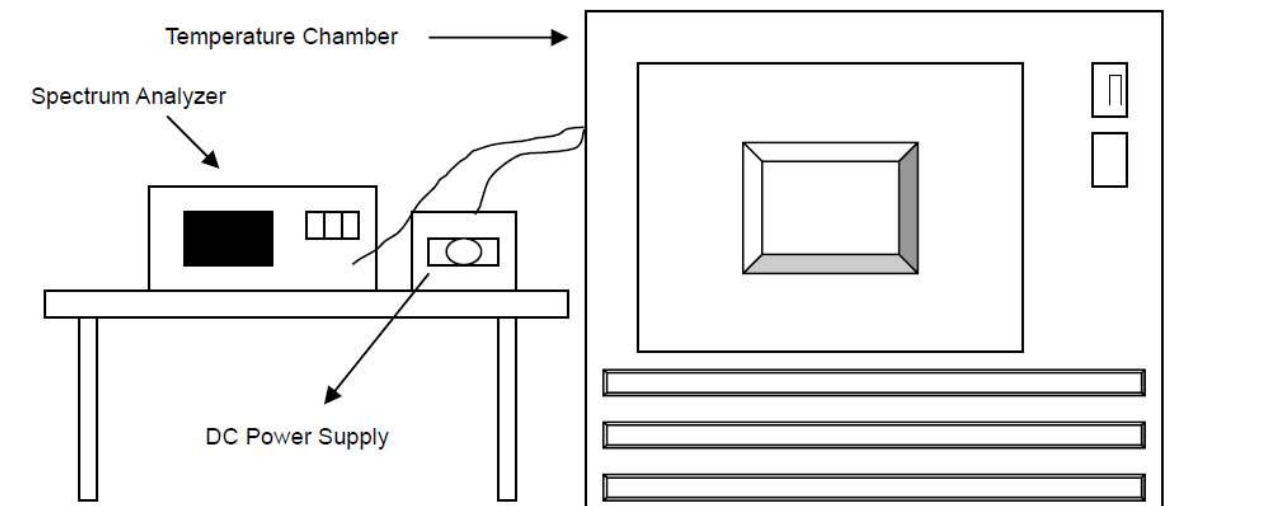

#### 4.3.3 Test Instruments

Refer to section 4.1.2 to get information of above instrument.

#### 4.3.4 Test Procedure

- The EUT was placed inside the environmental test chamber and powered by nominal AC voltage.
- Turned the EUT on and coupled its output to a spectrum analyzer.
- Turned the EUT off and set the chamber to the highest temperature specified.
- Allowed sufficient time (approximately 30 min) for the temperature of the chamber to stabilize then turned the EUT on and measured the operating frequency after 2, 5, and 10 minutes.
- Repeated step 2 and 3 with the temperature chamber set to the lowest temperature.
- The test chamber was allowed to stabilize at  $+20$  degree C for a minimum of 30 minutes. The supply voltage was then adjusted on the EUT from  $85\%$  to  $115\%$  and the frequency record.

#### 4.3.5 Deviation from Test Standard

No deviation.

#### 4.3.6 EUT Operating Conditions

Same as Item 4.1.6.

4.3.7 Test Result

Frequency Stability Versus Temp.				
TEMP. (°C)	Power Supply (Vdc)	Measured Frequency (MHz)	Frequency Dev. (Hz)	Deviation (%)
50	5	13.56002	20	0.000147
40		13.55997	-30	-0.000221
30		13.55997	-30	-0.000221
20		13.56006	60	0.000442
10		13.55994	-60	-0.000442
0		13.56003	30	0.000221
-10		13.55994	-60	-0.000442
-20		13.56005	50	0.000369
20		4.25	13.55992	-80
	5.75	13.55994	-60	-0.000442

## 4.4 20dB Bandwidth

### 4.4.1 Limits of 20dB Bandwidth Measurement

The 20dB bandwidth shall be specified in operating frequency band.

### 4.4.2 Test Setup

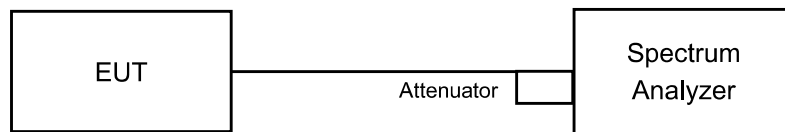

### 4.4.3 Test Instruments

Refer to section 4.1.2 to get information of above instrument.

### 4.4.4 Test Procedures

The bandwidth of the fundamental frequency was measured by spectrum analyzer with 1kHz RBW and 3kHz VBW. The 20dB bandwidth is defined as the total spectrum the power of which is higher than peak power minus 20dB.

### 4.4.5 Deviation from Test Standard

No deviation.

### 4.4.6 EUT Operating Conditions

Same as Item 4.1.6.



#### 4.4.7 Test Results

Frequency (MHz)	20dB Bandwidth (kHz)	99% Bandwidth (kHz)
13.56	4.916	15.617

Test Plots:

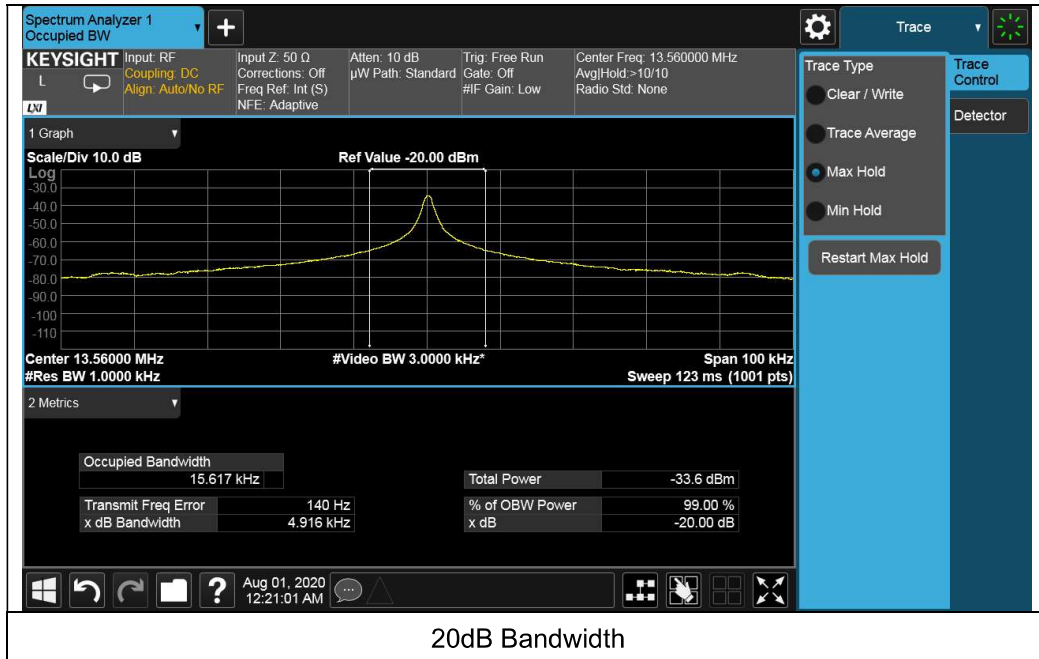

## 5 Pictures of Test Arrangements

Please see setup photo file.



## Appendix – Information on the Testing Laboratories

Bureau Veritas is a global leader in testing, inspection and certification (TIC) services. We help businesses improve safety, sustainability and productivity; and our clients include the majority of leading brands in retail, manufacturing and other industries. With a presence in every major country around the world, our quality assurance and compliance solutions are vital in helping our customers enhance product quality and concept-to-consumer journeys. We also assist with increasing speed to market, profitability and brand equity throughout the supply chain. Bureau Veritas is a leading wireless/IoT testing, inspection, audit and certification provider, with a global network of test laboratories to support the IoT industry in areas of connectivity, security, interoperability as well as quality, health & safety, and environmental/chemical requirements.

If you have any comments, please feel free to contact us at the following:

**Milpitas EMC/RF/Safety/Telecom Lab**

775 Montague Expressway, Milpitas, CA 95035

Tel: +1 408 526 1188

**Sunnyvale OTA/Bluetooth Lab**

1293 Anvilwood Avenue, Sunnyvale, CA

94089

Tel: +1 669 600 5293

**Littleton EMC/RF/Safety/Environmental Lab**

1 Distribution Center Cir #1, Littleton, MA 01460

Tel: +1 978 486 8880

**Email:** [sales.eaw@us.bureauveritas.com](mailto:sales.eaw@us.bureauveritas.com)

**Web Site:** [www.cpsusa-bureauveritas.com](http://www.cpsusa-bureauveritas.com)

The address and road map of all our labs can be found in our web site also.

--- END ---