



110 Nortech Parkway  
San Jose, CA, 95134  
(408) 635 2000  
www.airespace.com

**FCC Part 15, Subpart E,  
UNII (Part 15.401)  
Certification Application**

**EMI Test Report  
and  
Technical Documentation  
on  
Airespace Virtual Access point.  
Model: 1200**

**FCC ID: QTZWN1200ABG**

**Prepared by:**  
David Waitt  
202 Calvert Drive #217  
Cupertino, Ca. 95014  
[david@waitt.us](mailto:david@waitt.us)  
(408) 832 7053

**Table of Contents**

<b>Section</b>	<b>Page</b>
General information-----	3
Detailed product information-----	4
Results summary-----	5
Test facilities-----	6
Test Equipment-----	7
Test methods-----	8
Test Results	
Maximum power at RF Output-----	11
26dB Bandwidth-----	14
Power spectral density-----	18
Out of band emissions -----	23
Peak Excursion -----	43
Radiated emissions in restricted bands-----	47
AC Line Conducted Emissions-----	54

## General Information

**Unit(s) Under Test:** Airespace Access point  
**Model:** 1200  
**Product Description:** IEEE 802.11A / B / G Access point

**FCC ID:** **QTZWN1200ABG**

**Tested For:** Airespace  
110 Nortech Parkway  
San Jose, CA. 95134

**Tested At:** Elliott Laboratories  
684 West Maude Ave  
Sunnyvale, CA 94086

**Tested By:** Juan Martinez, Sr. Test Engineer, Elliott Laboratories  
David Waitt, (Independent Consultant)

**Test Specifications:** FCC CFR 47, Part Subpart E, (15 401 UNII )

**Test Date:** March 2003 / Nov 2003

**Requested Certification:** Part 15 Subpart E Certification

## Detailed Product Information / Operational Description

The Airespace radio is an IEEE 802.11 A / B / G Access point is intended to be professionally installed and configured in corporate and industrial environments.

The device utilizes a mini PCI module manufactured by an outside vendor. The module was certified with lower gain antennas and the manufacturer would not permit a outside company to request a permissive change to its grant. For this reason, Airespace is pursuing its own certification.

The access point utilizes integral antennas on the 802.11 A / B / G bands. The access point includes two integral 5 GHz patch antennas pointing 180° from each other to create a somewhat omni directional 5GHz pattern. The access point effectively includes only a single 2.4GHz patch antenna (the 2.4 GHz antenna is discussed in the 15.247 report). The effective gain of the 5 GHz antenna path (the power divider and the antenna itself) is 7.4dBi. The diagrams below outline the RF path from the output of the mini PCI module within the access point to the integral antennas within the access point (Note that only the Subpart E, 15.401 UNII 5 GHz portion is covered by this particular report)

There is a provision for attaching external 5 GHz antennas to the access point (which, when implemented will disable the integral antennas) however at this time, since external 5GHz antennas are not included in this certification application, the ability to utilize an external antenna on this band will be disabled in the configuration software. The hardware was put in place to support the future use of external 5 GHz antennas once such use is authorized by the commission either by permissive change of new grant.

The access point is powered either by an external 48V power supply or via power over Ethernet.

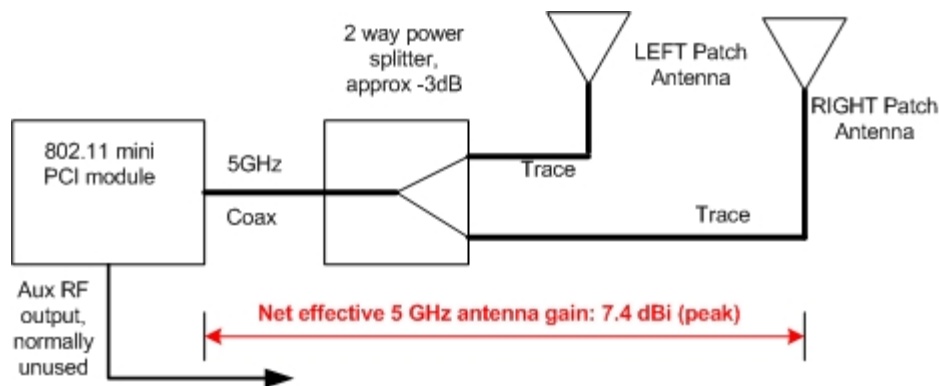

RF Path Block Diagram

## Report Organization and Results Summary

This report presents the results of the tests that verify compliance with FCC Part 15.401. Though this product must comply with FCC Part 15.247 as well, only the 15.401 (UNII) results are contained in this report. The compliance information for Part 15.247 is contained in a separate report.

A brief results summary of all the in this report is below.

<b>Part 15 Paragraph</b>	<b>Test</b>	<b>Results</b>
15.407(a) (5)	Power Spectral Density	-4.0 dBm MAX
15.407(b) (1)	Out of Band Emissions (5.15 - 5.25)	-44.5 dBm MAX
15.407(b) (1)	Out of Band Emissions (5.25 - 5.35)	-39.33 dBm MAX
15.407(b) (1)	Out of Band Emissions (5.725 - 5.825)	-34.83 dBm MAX
15.407(a)	26dB Bandwidth	45.58 MHz
15.407(a) (1)	Transmit Power (5.15 - 5.35)	17.3 dBm MAX 24.7 dBm EIRP
15.407(a) (3)	Transmit Power (5.275 - 5.825)	20.9 dBm MAX 28.3 dBm EIRP
15.407(a) (6)	Peak Excursion	2.97 MAX
15.205	Radiated Emissions in Restricted bands	.7 dB in spec
CISPR 22	AC Line Conducted Emissions	15.25 dB in Spec

## Test Facilities

All of the certification tests were performed at:

Elliott Labs  
684 West Maude Ave  
Sunnyvale, CA 94086

### General:

Final radiated test measurements were taken in March 2003 and Nov 2003 at Elliott Laboratories Open Area Test Site #4.

The test site contains separate areas for radiated and conducted emissions testing. Pursuant to section 2.948 of the Rules, construction, calibration, and equipment data has been filed with the Commission.

The FCC recommends that ambient noise at the test site be at least 6 dB below the allowable limits. Ambient levels are below this requirement with the exception of predictable local TV, radio, and mobile communications traffic. The test site contains separate areas for radiated and conducted emissions testing. Considerable engineering effort has been expended to ensure that the facilities conform to all pertinent FCC requirements.

### OATS:

The FCC has determined that radiation measurements made in a shielded enclosure are not suitable for determining levels of radiated emissions. Radiated emissions are performed in an open field environment. The test site is maintained free of conductive objects within the CISPR defined elliptical area incorporated in ANSI C63.4 Guidelines.

### Antenna, Antenna Mast and Turntable

The Horn antennas that are used to measure radiated emissions above 1000MHz are mounted on a non-conductive antenna mast equipped with a motor drive to vary the antenna height.

ANSI C63.4 specifies that the test height above the ground plane shall be 80cm unless the equipment is intended to be floor mounted. During the radiated emissions tests the equipment is positioned on a motorized turntable in conformance with the ANSI requirement.

## Equipment Lists

### Instrument Calibration

All test equipment is regularly checked to ensure that performance is maintained in accordance with the manufacturer's specifications. All antennas are calibrated at regular intervals with respect to tuned half-wave dipoles. An exhibit of this report contains the list of test equipment used and calibration information.

The following test equipment was used to perform the testing

### Elliott Test Equipment

<u>Item</u>	<u>Desc.</u>	<u>Manufacturer</u>	<u>Model</u>	<u>S/N</u>	<u>(Elliott #)</u>	<u>Cal due date</u>
Spectrum Analyzer	3.5 GHz HPF	Hewlett Packard	8595EM	NA	84300-80038	2 Feb 04
Pre Amp		HP		ASF 44	805817	1 Mar 04
Antenna		Miteq		3115	9711-5359	7 Jan 04
Microwave test system		EMCO		84125		20 April 04
		Hewlett Packard				2 April 04

### Additional Test Equipment

<u>Item</u>	<u>Desc.</u>	<u>Manufacturer</u>	<u>Model</u>	<u>S/N</u>	<u>Cal due date</u>
Spectrum Analyzer		Agilent	E4404B	US40521093	3 Sep 04

## Test Methods

Many of the tests are performed at a low, middle and high channel of the applicable band. The typical frequencies used for the test for each band are listed below. Recall that this report details the results for the UNII bands only. Where applicable, the test procedures outlined in FCC Public notice DA 02-2138 (30 Aug 2002) were used.

<b>UNII 802.11 A</b>	
<b>5.15 – 5.25 GHz &amp; 5.25 – 5.35 GHz</b>	
Channel	Freq( MHz )
Low	5180
Mid	5260
High	5320

<b>UNII / 802.11 A</b>	
<b>5.725 5.825 GHz</b>	
Channel	Freq( MHz )
Low	5745
Mid	5765
High	5805

In order to comply with the “radiated emissions in restricted bands” requirements the transmit power had to be lowered on some of the channels at the edges of the band. The maximum power setting that yielded compliance with the radiated emissions requirements will be programmed into the configuration firmware of the access point ensuring that maximum possible power setting will be correct for each channel. Given that the access point will normally be operated at these power settings, they were also used during the “bench top” conducted RF tests (spectral density, bandwidth etc).



The tests listed below are performed using the basic test setup shown below. In several cases, the EUT was running special diagnostic firmware to allow it to transmit random data on a particular channel indefinitely.

<b>Part 15</b>	<b>Test</b>
15.407(a)(5)	Power Spectral Density
15.407(b)(1)	Out of Band Emissions (5.15 - 5.25)
15.407(b)(1)	Out of Band Emissions (5.25 - 5.35)
15.407(b)(1)	Out of Band Emissions (5.725 - 5.825)
15.407(a)	26dB Bandwidth
15.407(a)(1)	Transmit Power (5.15 - 5.25)
15.407(a)(2)	Transmit Power (5.25 - 5.35)
15.407(a)(3)	Transmit Power (5.275 - 5.825)
15.407(a)(6)	Peak Excursion

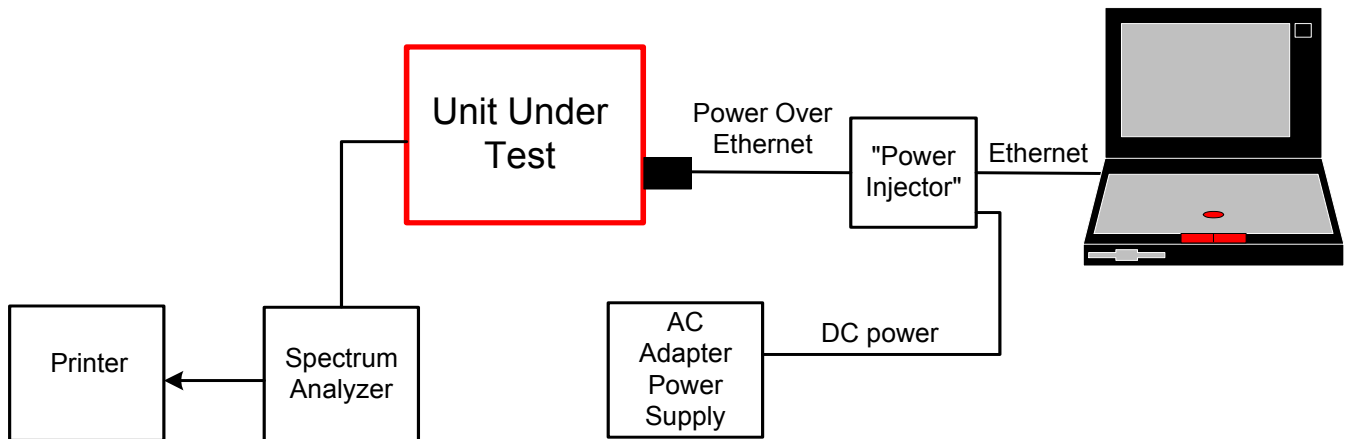

**Basic Conducted RF Bench Test Setup**

Unless otherwise noted, the support equipment for the bench tests is listed below.

Support Equipment				
Description	Model number	FCC ID or SN	Manufacturer	Power Cable
Laptop	Armada E 500	P31000T4X20DC12N2	Compaq	Laptop PS
Test Software	Atheros Radio Test		Atheros	
48VDC AC adapter	Generic		Generic	Standard Twin lead DC wire

## Test Results

Detailed test procedures and test results are contained in the following sections. In cases where the test setup differs from the Conducted RF test setup shown earlier, the test setup is also presented.

<b>Test Conditions</b>			
<b>Temperature</b>	20 C	<b>Humidity:</b>	40%
<b>ATM pressure</b>	1017 mBar	<b>Grounding:</b>	None
<b>Tested By</b>	David Waitt / Juan Martinez	<b>Date of Test:</b>	March 2003 November 2003
<b>Test Reference</b>	Refer to individual test results		
<b>Tested Range</b>	Test Dependent		
<b>Test Voltage</b>	48 VDC to the access point		
<b>Modifications</b>	No modifications were made to the unit during the tests		

## 802.11 A Maximum RF Power Output at Antenna Terminals

**Specifications:**

FCC Specification: Paragraph(s): 15.401(a)(1), 15.401(a)(2), 15.401(a)(3)

**Procedure:**

The test was conducted by connecting the secondary output of the 802.11 module directly to a spectrum analyzer. This measured power is therefore the same level that will be present at the input of the FET antenna switch under normal operation.

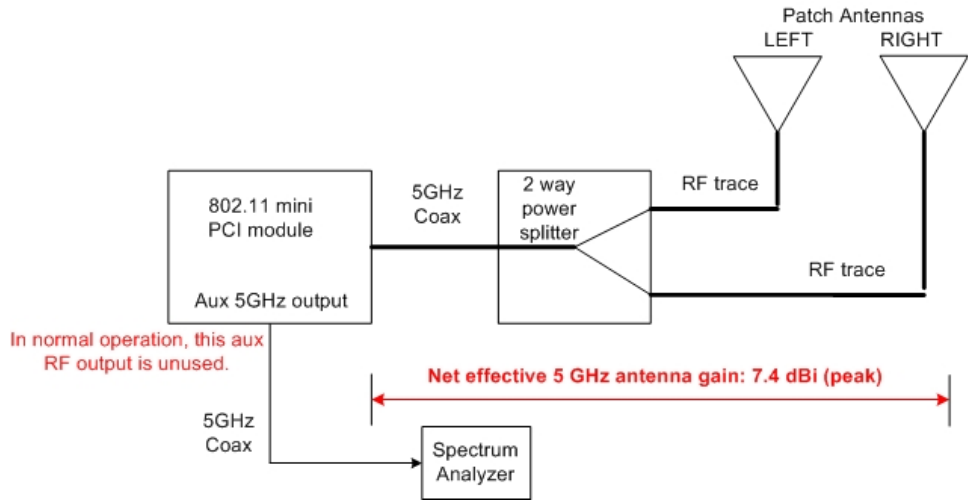

The unit was tuned to the test channels and configured to transmit continuous random data packets. The integrated power over the 26 dB bandwidth was read directly off the spectrum analyzer

Because the unit will be operated at different power levels depending on the channel / band being used, the RF power out was measured at the appropriate power setting for the given test channel / band. The settings that were used during the test are the settings that will be entered into the firmware of the access point. These firmware configuration limits will ensure that the power levels are not exceeded.

Power measurements were performed with a spectrum analyzer with sample detector using channel power integration over the 26 dB effective bandwidth. This was achieved by selecting video averaging on and then selecting trace max hold. The spectrum analyzer changes from sample to positive peak detector if max hold is selected without fist selecting video averaging. The measurements were made per FCC "Method 3" outlined in public notice DA 02-2138 dated 30 Aug 2002.

**RF Transmit Power Result:**

Pout settings Vs. Channel	Frequency (MHz)	Spec (dBm) into 6 dBi	Msrd 26 dB Chan power from module (dBm/26 dB BW)	Pwr into antenna after power divider (- 3dB ) (dBm)	Pwr into antenna (mWatts)
5 GHz UNII upper	5745.00	30	20.9	17.9	61.66
	5765.00	30	20.3	17.3	53.70
	5805.00	30	19.0	16.0	39.80
5 GHz UNII lower	5180.00	17	14.8	11.8	15.13
	5240.00	17	15.5	12.5	17.78
	5260.00	24	17.3	14.3	26.91
	5320.00	24	14.1	11.1	12.88

Pout @ 5180  
MHz

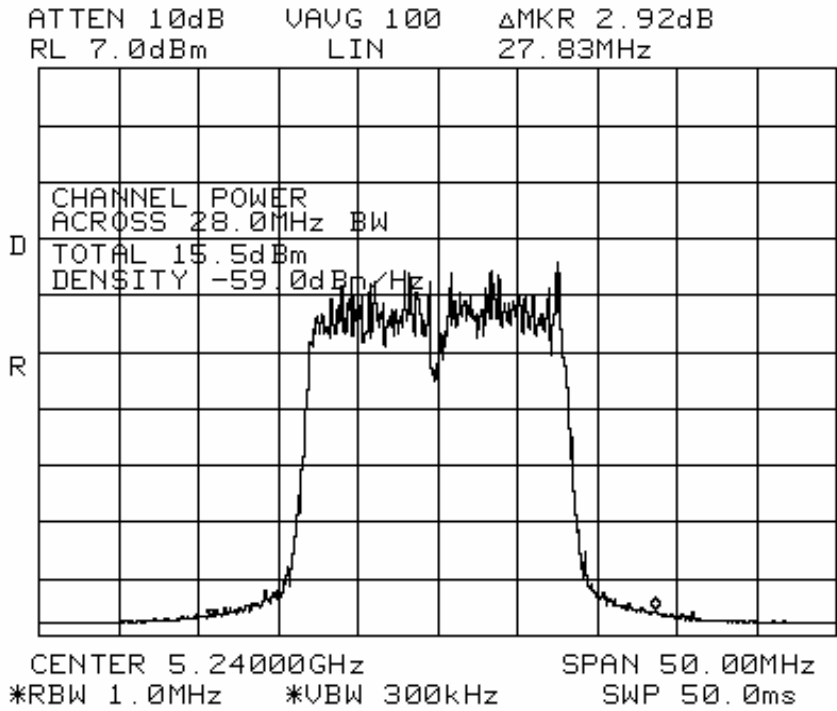
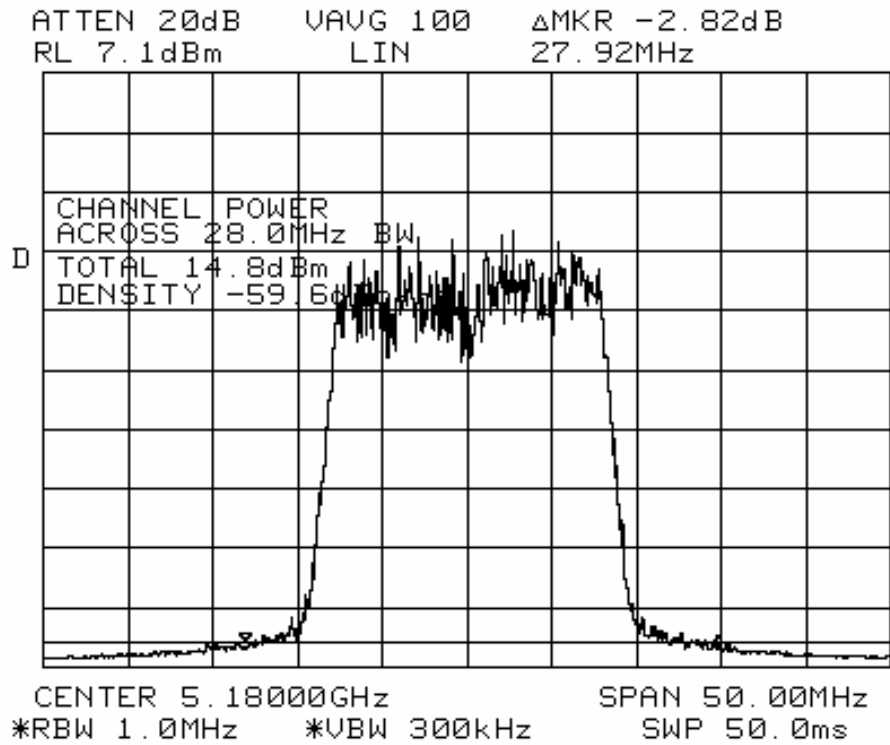

Pout @ 5240 MHz

**Pout @ 5260 MHz**

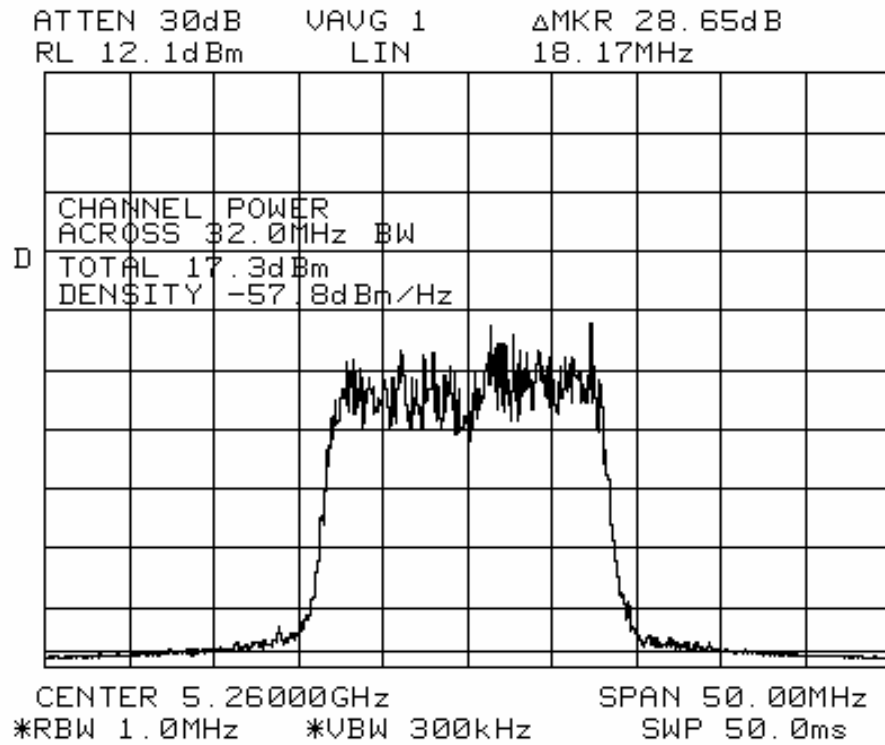

**Pout @ 5320 MHz**

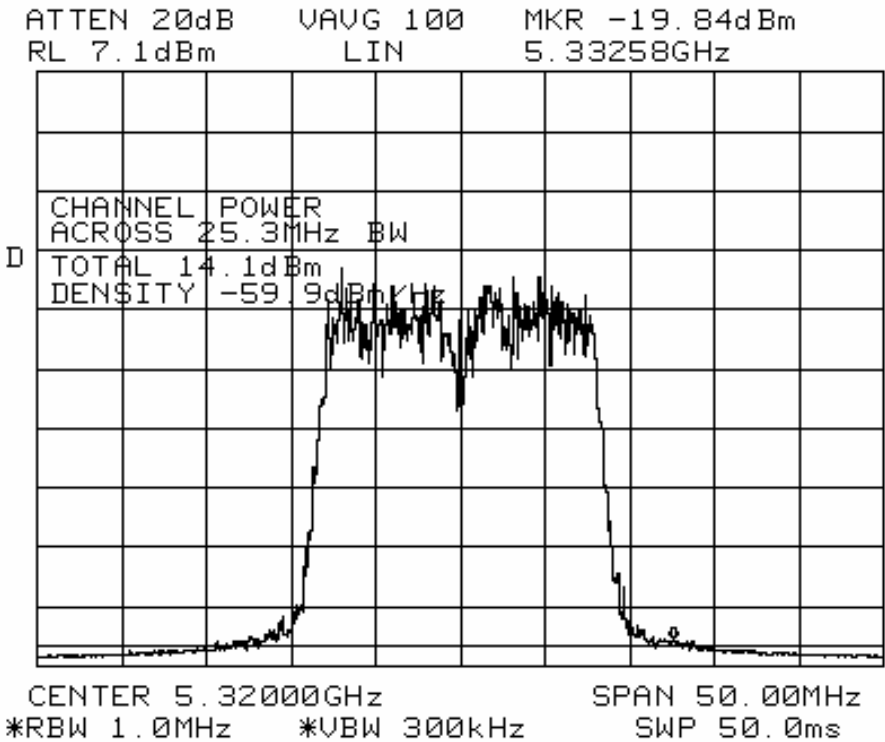

**Pout @ 5745 MHz**

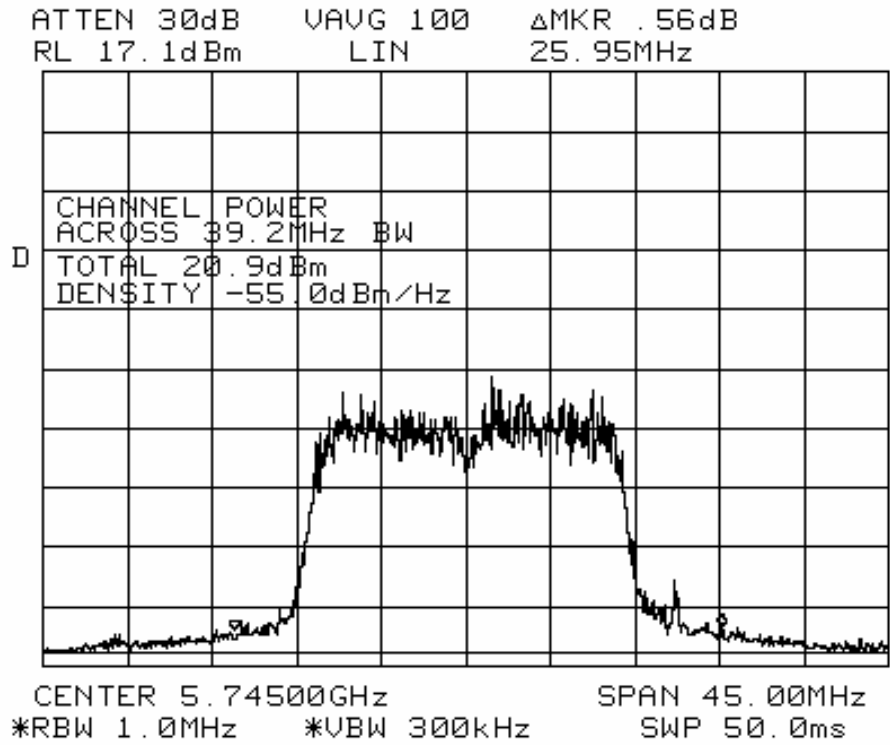

**Pout @ 5765 MHz**

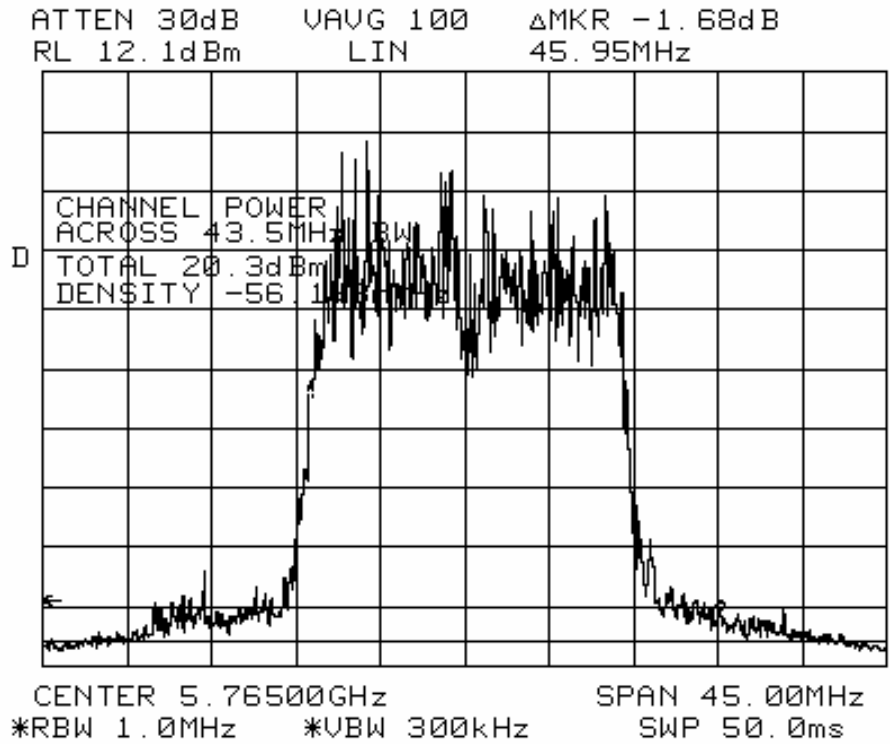

**Pout @ 5805  
MHz**

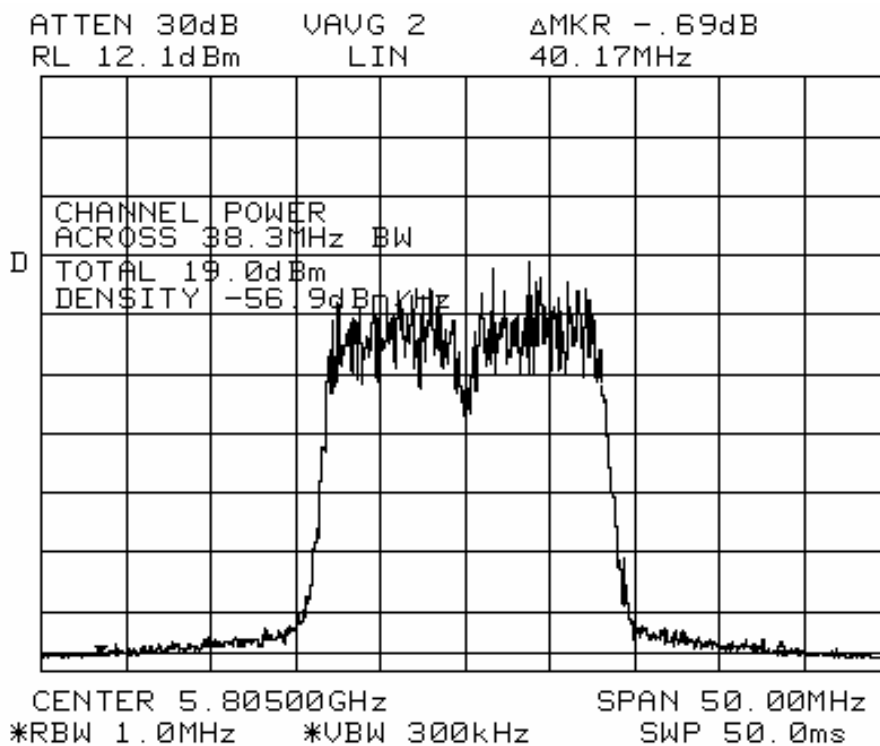

# 5 GHz 26 dB bandwidth

## Specification

FCC Specification: Paragraph 15.407(a)

The Airespace access point operates on the standard IEEE 802.11 A channels. The 26dB bandwidth was measured on the low middle and high channel of the 5 GHz UNII bands using the conducted RF test setup. The spectrum analyzer was configured for MAX HOLD and the trace allowed to stabilize. A peak search was performed and the then Delta-Marker used to locate the point -26dB below the peak.

Once this was complete, the point was used as a reference and another delta measurement was performed to the and an attempt made to make the two markers "level". The delta frequency between the two markers was measured as the 26 dB BW of the signal. The bandwidth test was performed at the power settings that will be used in the final system.

## Results:

Channel	Frequency (MHz)	Resolution Bandwidth	26 dB Signal Bandwidth (MHz)	20 dB Signal Bandwidth (MHz)
161	5805	300 kHz	45.58	28.33
153	5765	300 kHz	25.83	19.25
149	5745	300 kHz	26.67	19.08
64	5320	300 kHz	26.33	19.67
52	5260	300 kHz	29.08	19.92
36	5180	300 kHz	26.92	19.25

## 26dB BW Plots

Channel 161 (5805)

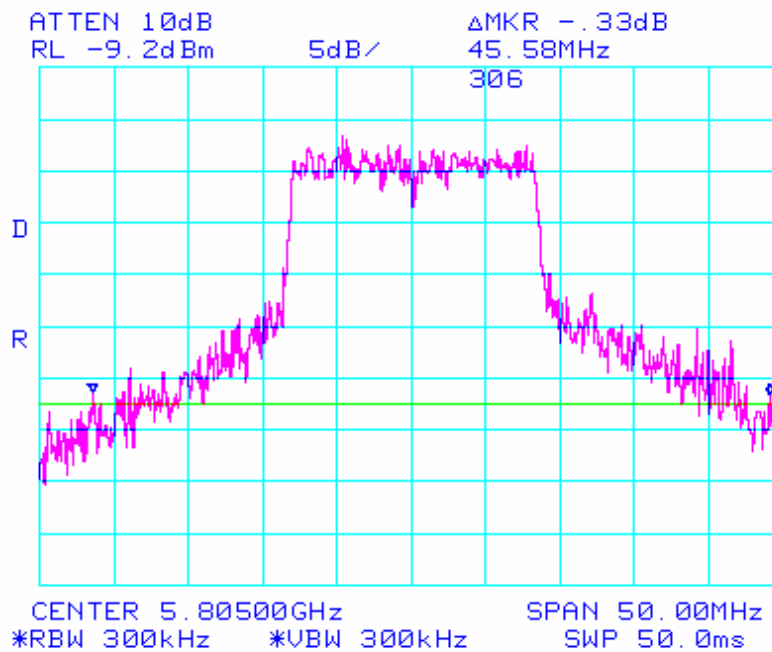



### Channel 153 (5765)

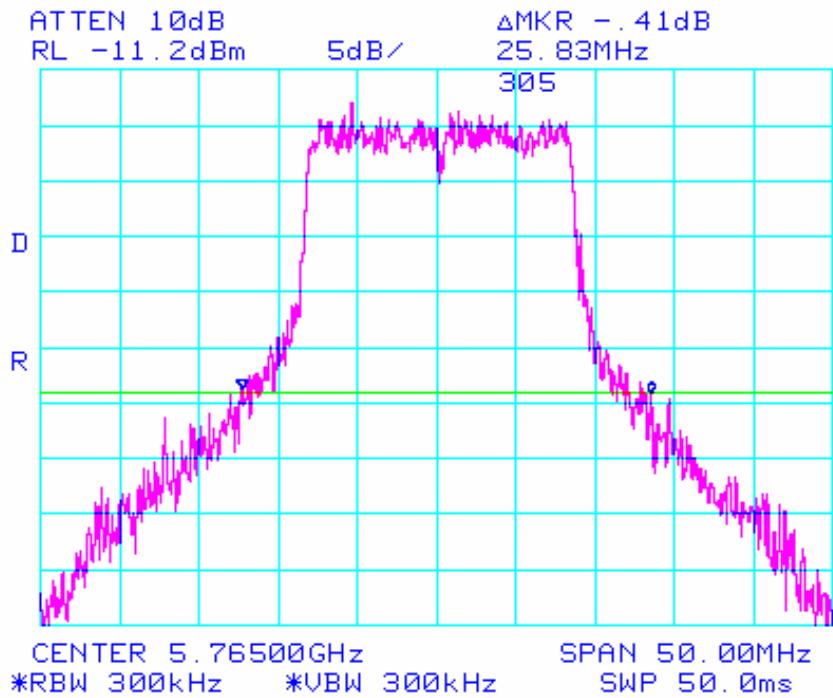

### Channel 149 (5745)

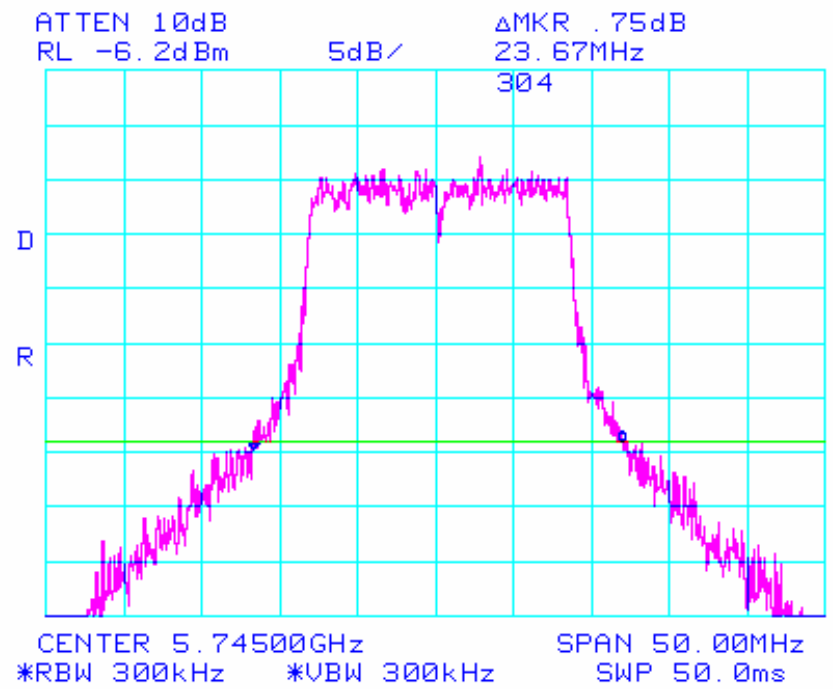

### Channel 64 (5320)

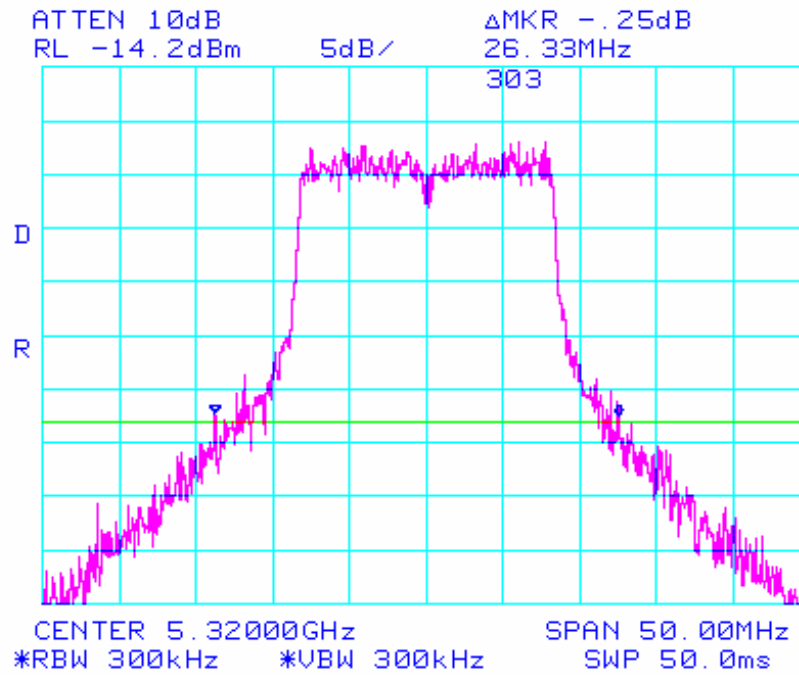

### Channel 52 (5260)

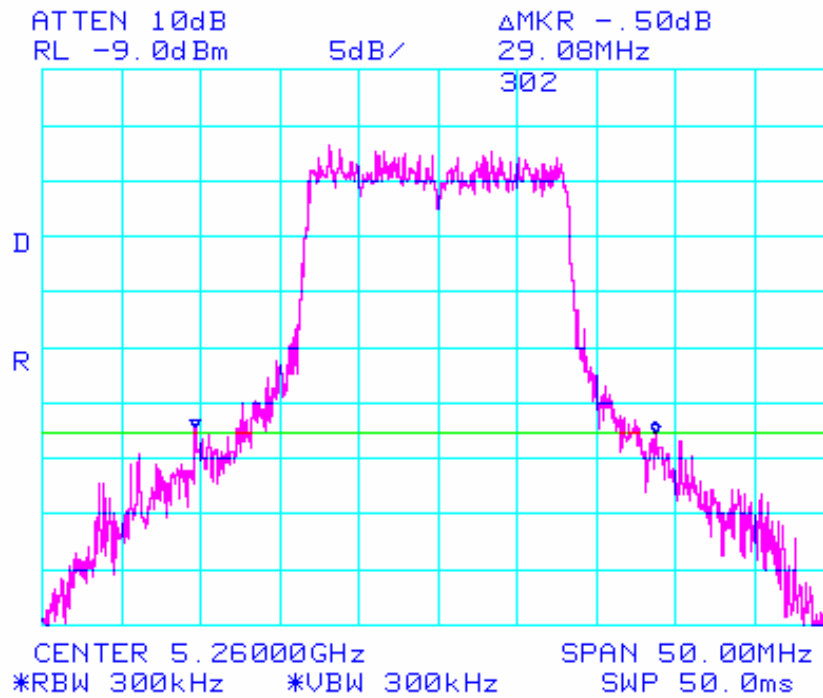

### Channel 36 (5180)

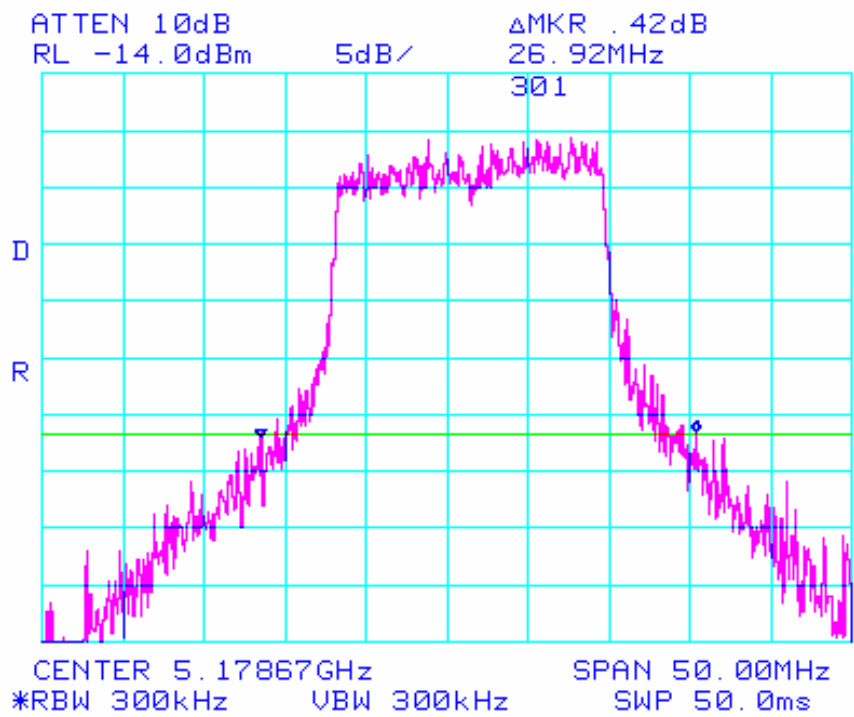

## 5 GHz Power Spectral Density

### Specification

FCC Specification: Paragraph 15.407(a)(5)

### Procedure:

The test setup was configured as shown in the conducted test setup. The UUT was configured to continuously transmit random data packets. Initially the bandwidth of the entire channel was examined. Using MAX HOLD and peak search, the frequency with the maximum power was determined.

The above measurements were made using RBW = 1MHz, VBW = 1MHz, video averaging on. The peak PSD of -4 dBm did not exceed the maximum permitted average PSD in any band, (Peak PSD limits have an additional 6 dB) so no restriction are placed on the output power or average PSD )

The power spectral density was measured at the designated test channels with the appropriate power setting for the given test channel.

### Results:

Frequency (MHz)	FCC P.S.D. (dBm/MHz)	FCC Limit (dBm)
5805	-8.3	17.0
5765	-4.4	17.0
5745	-4.5	17.0
5320	-6.8	11.0
5260	-4.0	11.0
5180	-6.4	4.0



Channel 149 (5745)

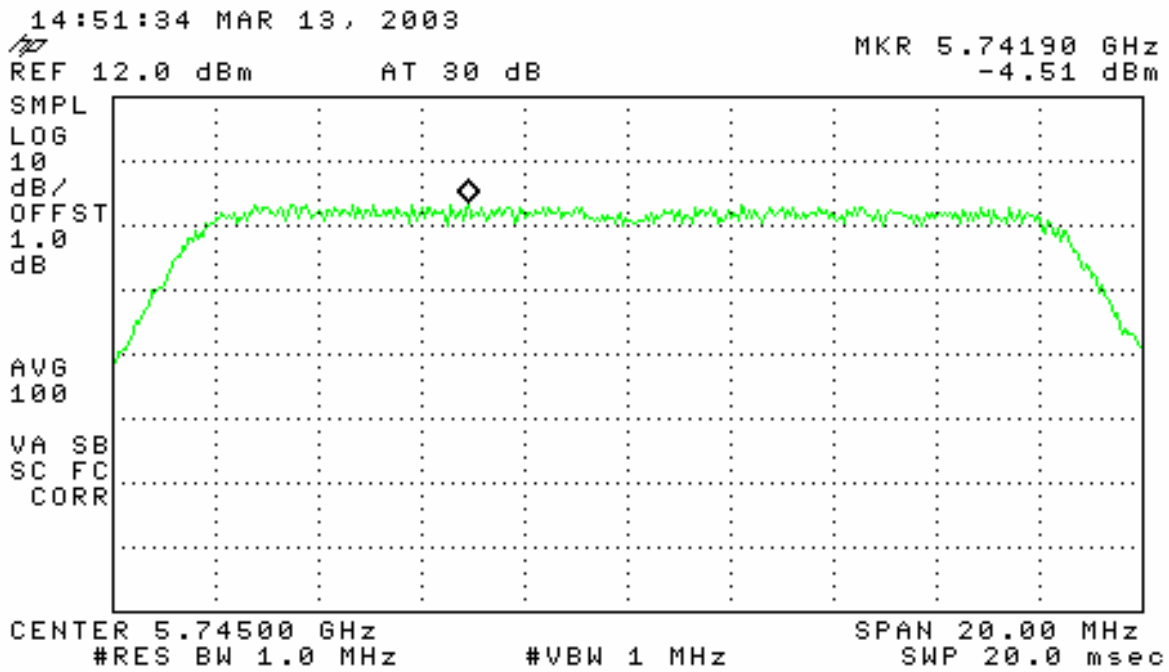

Channel 64 (5320)

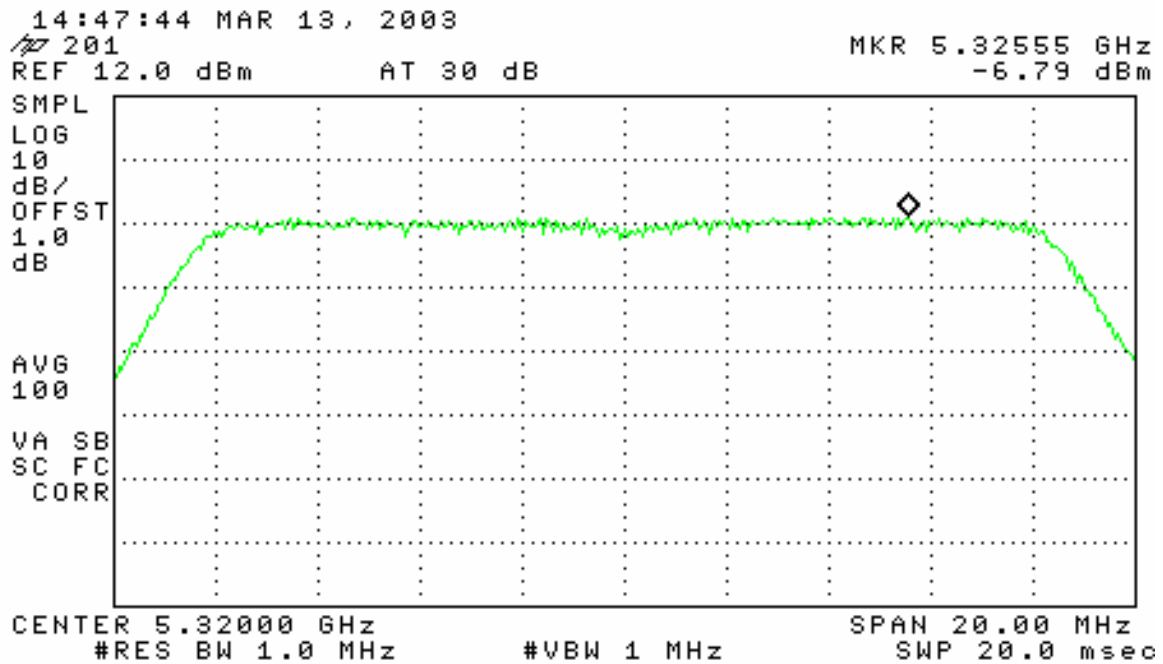

Channel 52 (5260)

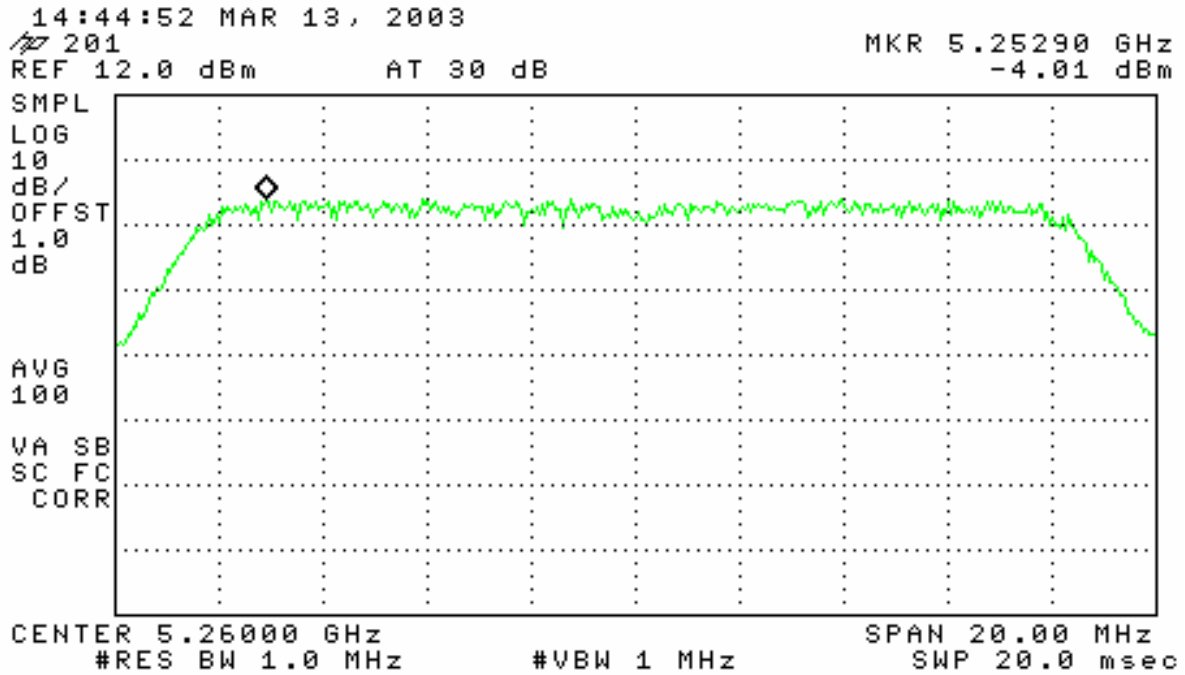

Channel 36 (5180)

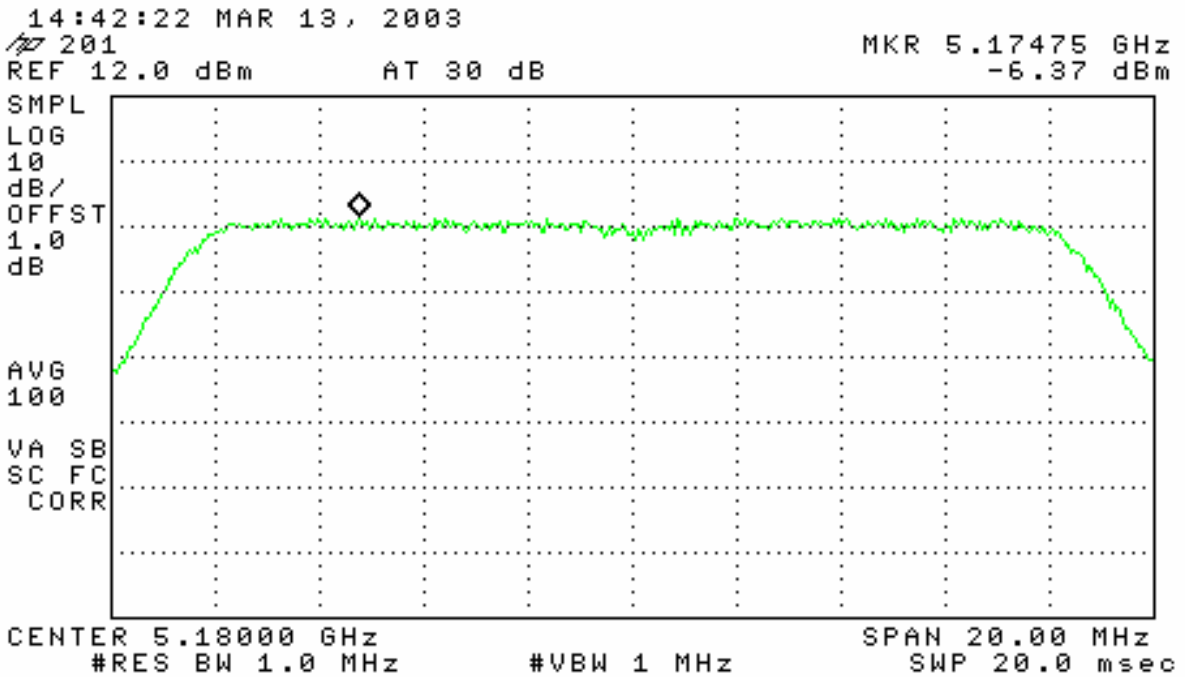

## 5 GHz Out of band Spurious Emissions

### **Specification**

FCC Specifications: Paragraphs 15.407(b)(1), 15.407(b)(2), 15.407(b)(3),

### **Procedure:**

The test was configured as shown in the Conducted RF test setup. The UUT was configured to transmit random data packets. The band from 1 GHz to 40 GHz was examined for spurious emissions. This test was conducted with the unit transmitting at the appropriate power setting and configured to transmit continuous random data packets indicated in the "power setting table" depending on the test channel.

Limit Calculation:

Antenna Gain: 7.4 dBi

Out of band signal limit: -27dBm/MHz EIRP (for signals not in a restricted band)

Conducted limit: 27dBm/MHz - 7.4 dBi = 34.4 dBm/MHz EIRP

(This assumes that the antenna gain is 7.4 dBi within 100MHz of the upper and lower band edges.). For signals greater than 100 MHz from the band edge, a radiated measurement was made if the amplitude of the signal exceeded -37 dBm

### **Results:**

Tabular results are on the following page followed by plots of the conducted emissions.



**Results:****Lower UNII band(s) emissions summary**

<b>Xmit Frequency (MHz)</b>	<b>Frequency Range</b>	<b>Spurious Freq (GHz)</b>	<b>Highest Spurious Signal (dBm)</b>	<b>Limit (-27dBm - 7.4dBi = -34.4dBm/MHz EIRP)</b>	<b>dB below Spec</b>	<b>Graph reference #</b>
<b>5180</b>	30 - 1000 MHz	See Note				
	1 to 5.15 GHz	4.13	-54.00	-34.4	19.6	502
	5.25 to 10 GHz	6.22	-47.33	-34.4	12.93	503
	10 GHz to 20 GHz	10.33	-44.50	-34.4	10.1	504
	20 GHz to 40 GHz	36.77	-44.50	-34.4	10.1	505
<b>5260</b>	30 - 1000 MHz	See Note				
	1 to 5.25 GHz	4.21	-54.67	-34.4	20.27	507
	5.35 to 10 GHz	6.31	-46.17	-34.4	11.77	508
	10 GHz to 20 GHz	10.50	-39.33	-34.4	4.93	509
	20 GHz to 40 GHz	36.80	-43.17	-34.4	8.77	510
<b>5320</b>	30 - 1000 MHz	See Note				
	1 to 5.25 GHz	5.09	-47.83	-34.4	13.43	512
	5.35 to 10 GHz	6.38	-49.00	-34.4	14.6	513
	10 GHz to 20 GHz	10.62	-53.50	-34.4	19.1	514
	20 GHz to 40 GHz	37.57	-44.33	-34.4	9.93	515
<b>5745</b>	30 - 1000 MHz	See Note				
	1 to 5.725 GHz	4.60	-52.67	-34.4	18.27	517
	5.825 to 10 GHz	5.88	-51.33	-34.4	16.93	518
	10 GHz to 20 GHz	11.48	-38.83	-34.4	4.43	519
	20 GHz to 40 GHz	36.33	-44.17	-34.4	9.77	520
<b>5765</b>	30 - 1000 MHz	See Note				
	1 to 5.725 GHz	4.61	-52.83	-34.4	18.43	522
	5.825 to 10 GHz	5.83	-49.00	-34.4	14.6	523
	10 GHz to 20 GHz	11.52	-34.83	-34.4	0.43	524
	20 GHz to 40 GHz	37.10	-44.00	-34.4	9.6	525
<b>5805</b>	30 - 1000 MHz	See Note				
	1 to 5.725 GHz	4.65	-48.33	-34.4	13.93	527
	5.825 to 10 GHz	7.59	-52.67	-34.4	18.27	528
	10 GHz to 20 GHz	11.60	-42.50	-34.4	8.1	529
	20 GHz to 40 GHz	36.57	-43.17	-34.4	8.77	530







### Lower UNII band(s) emissions plots UUT Transmitting on 5.26 GHz

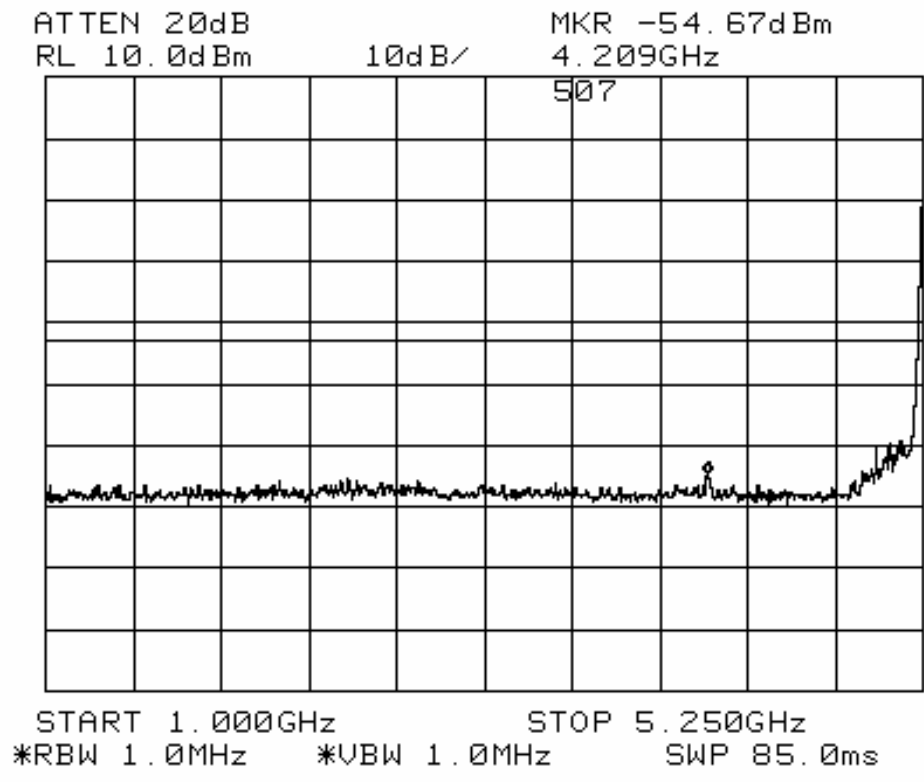
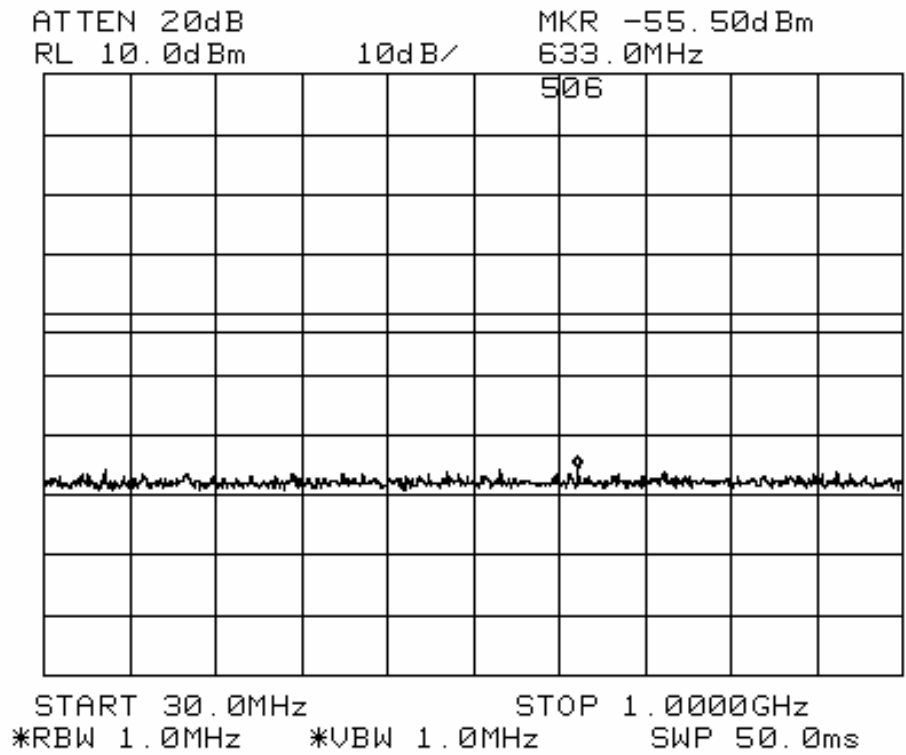









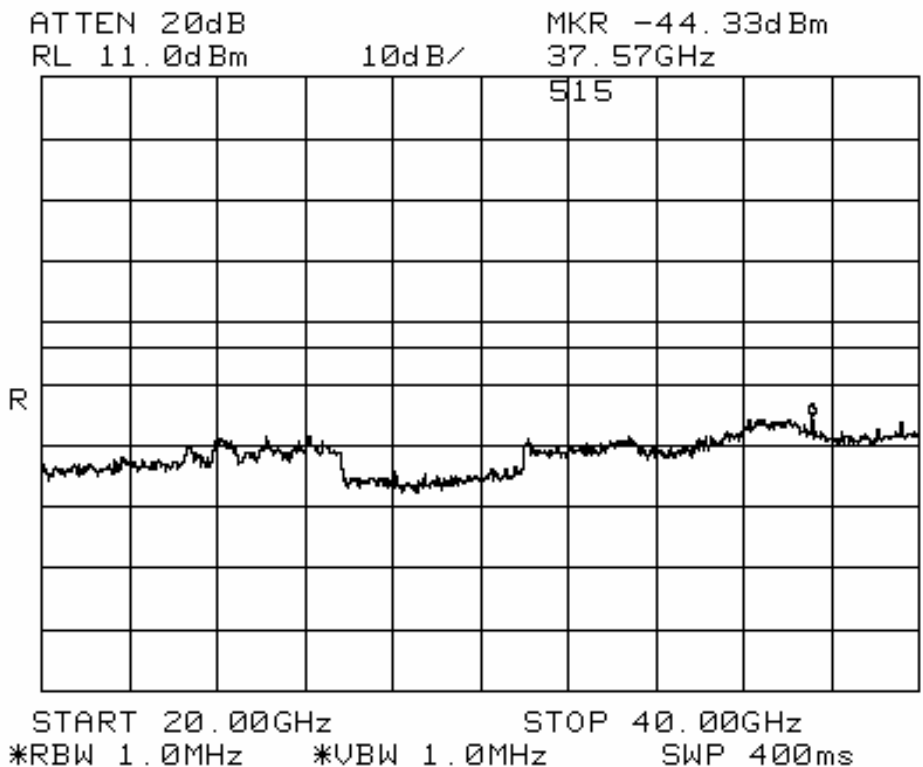
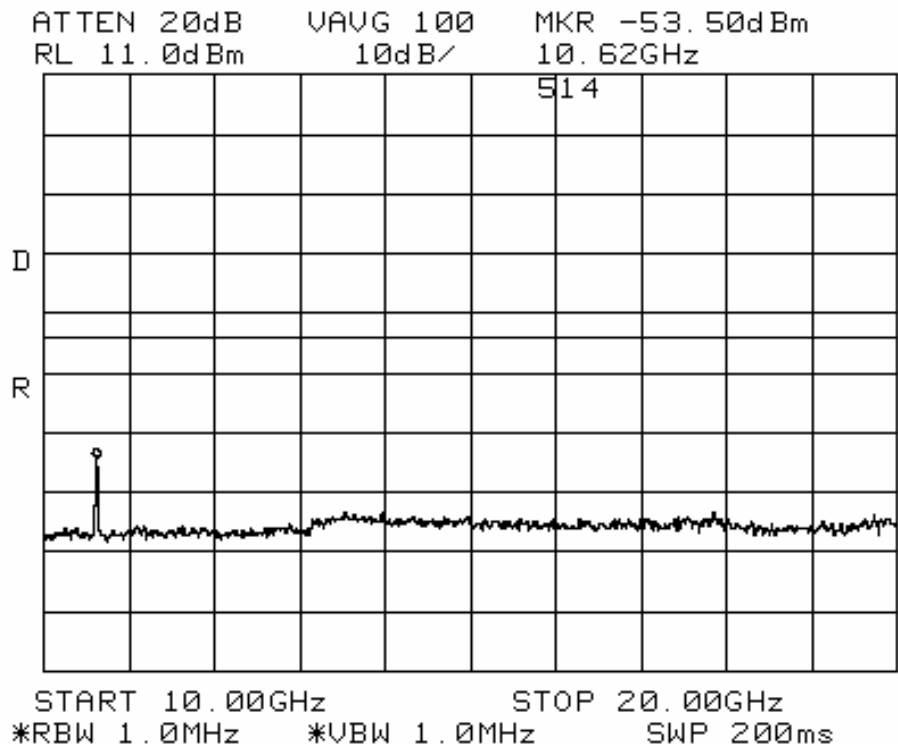



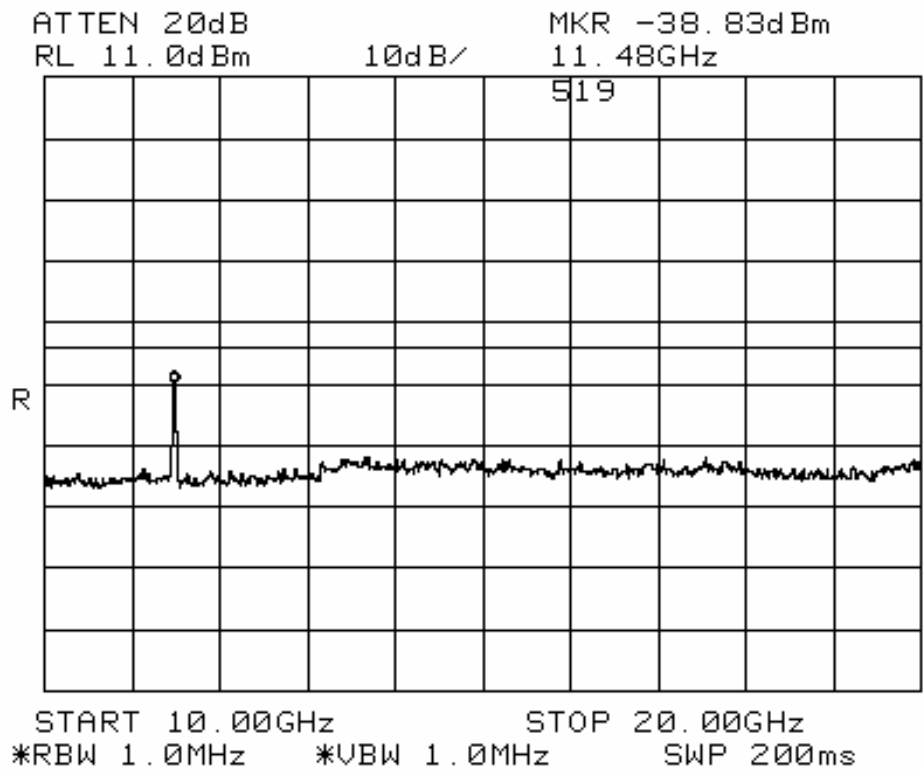
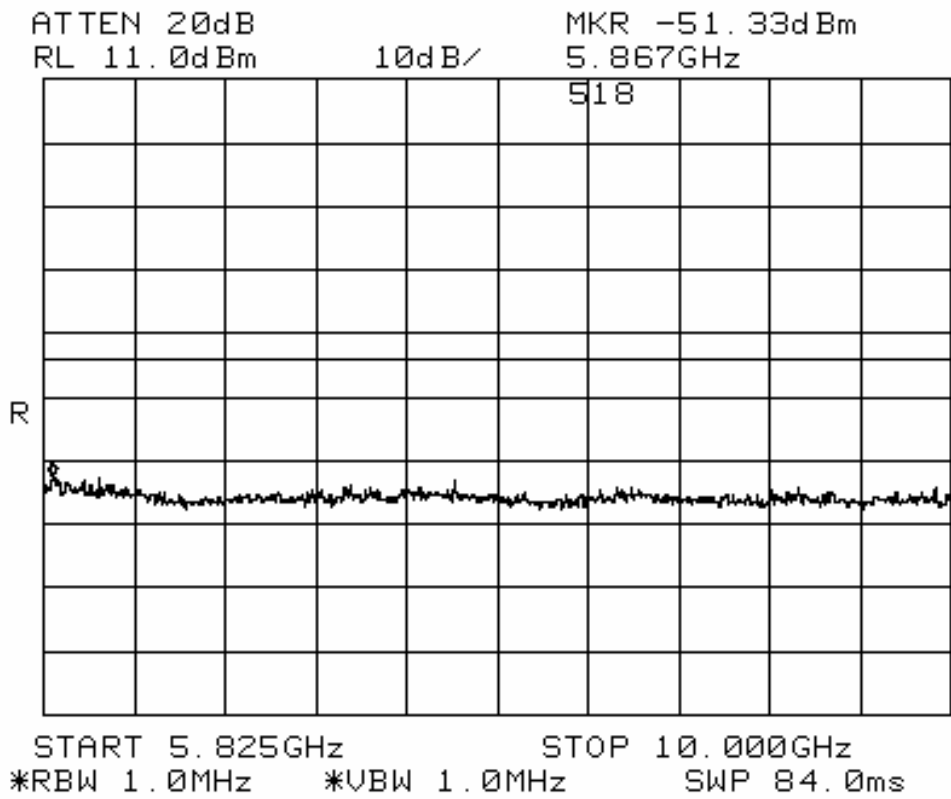

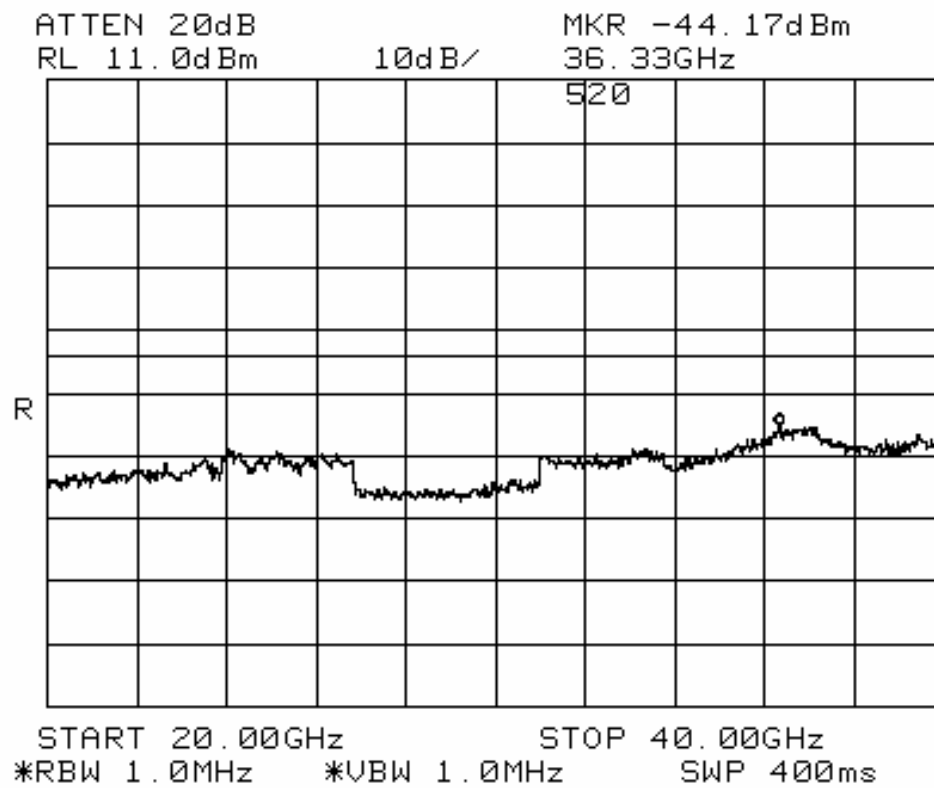

Upper UNII band(s) emissions plots  
UUT Transmitting on 5.765 GHz

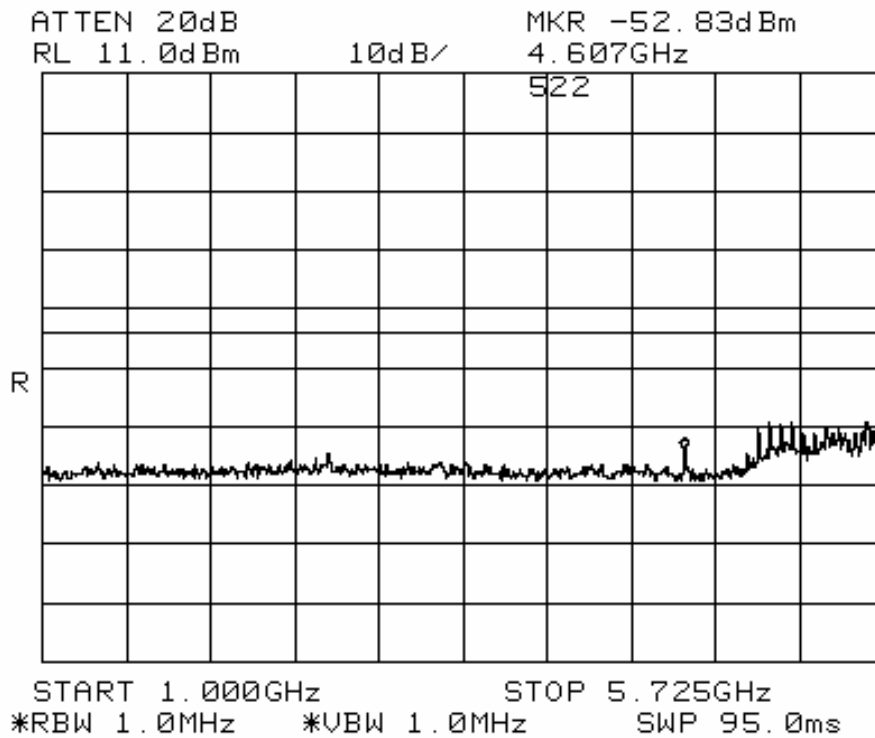
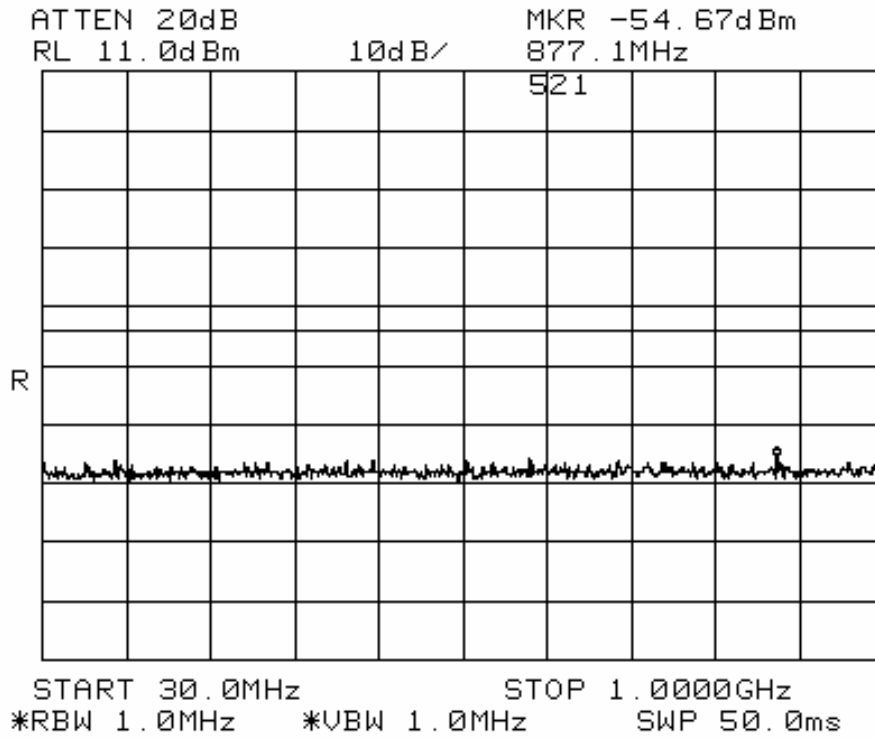



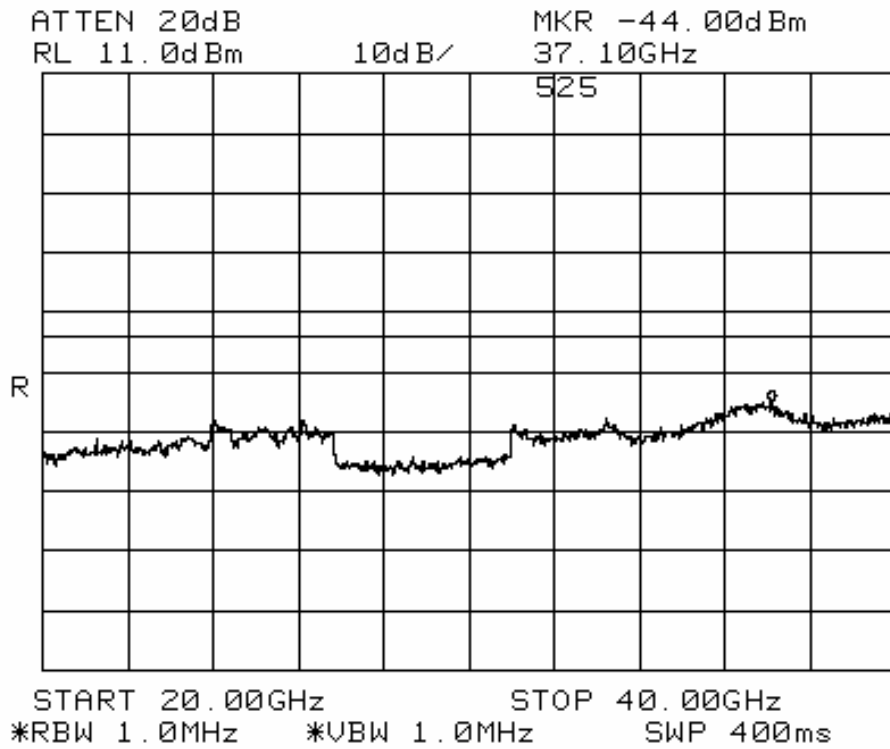

Upper UNII band(s) emissions plots  
UUT Transmitting on 5.805 GHz

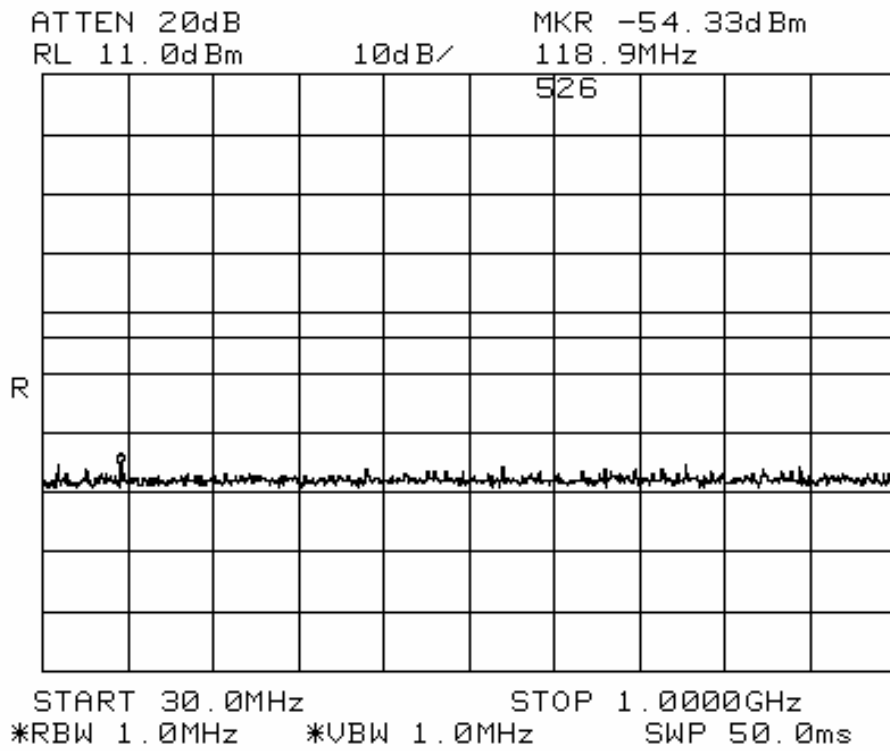





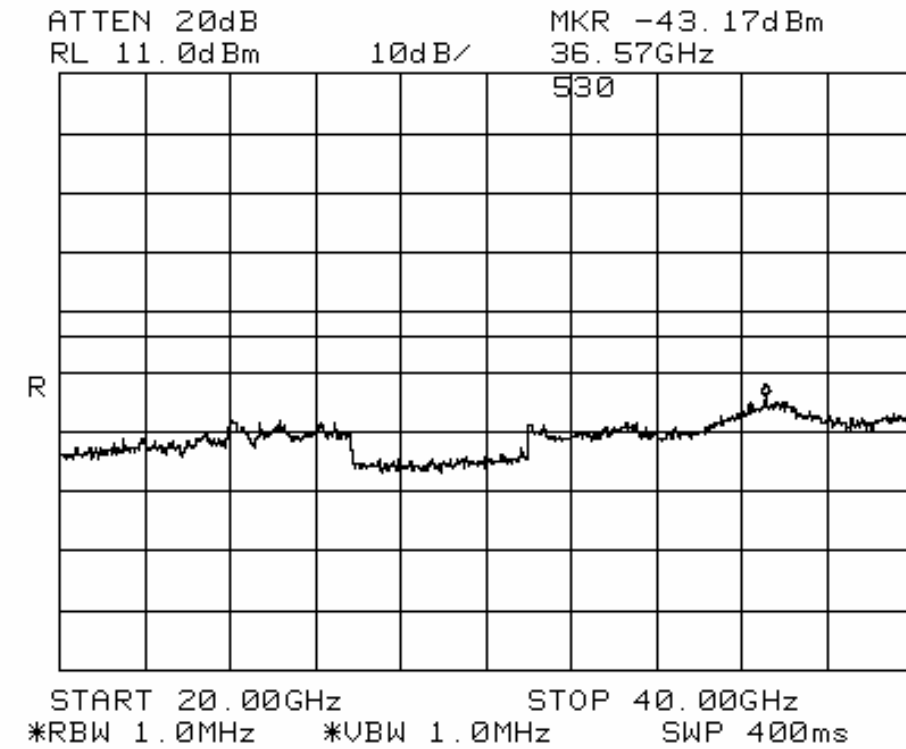
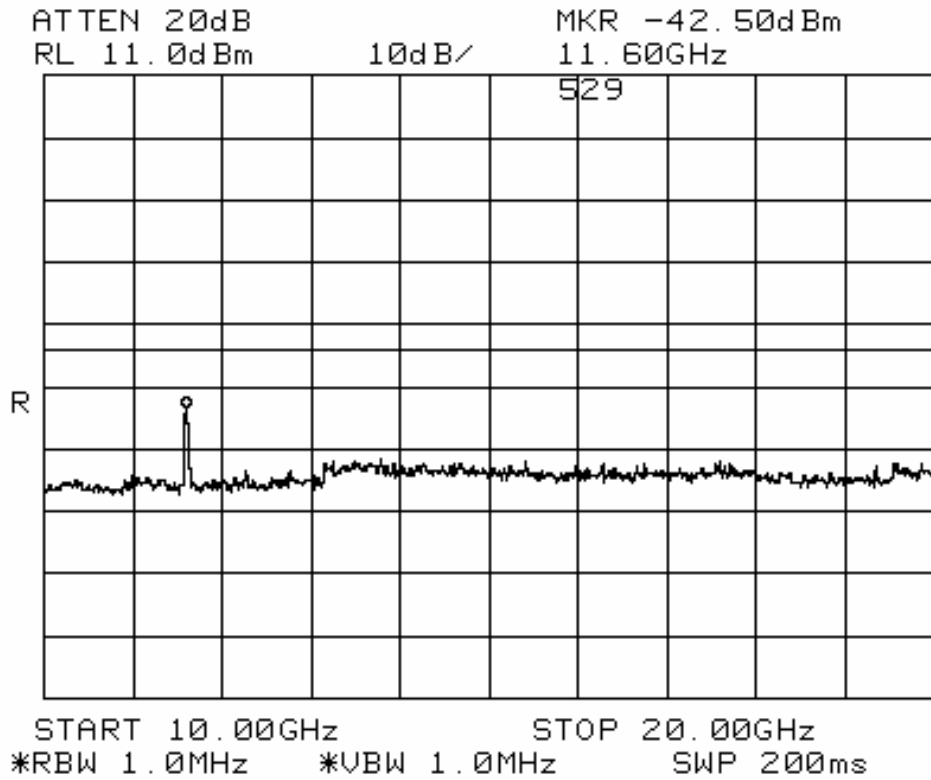

# 5.725 – 5.825 GHz bandedge

**Specification**

FCC Specifications: Paragraphs 15.407(b)(3)

**Procedure:**

For signals in the restricted bands immediately above and below the 5.725 to 5.825 GHz band, measurements were made of the antenna conducted power. The test was configured as shown in the Conducted RF test setup. The UUT was configured to transmit continuous random data packets on the standard channel closest to the band edge being examined. The UUT was configured to the appropriate power setting depending on the test channel.

Since the specification is in EIRP, the spec appropriate specification limit was adjusted account for the antenna gain. The measurements wee made with RBW = 1MHz, VBW = 1MHz, video averaging on. The band edges and their appropriate limits (un adjusted for antenna gain) are shown below.

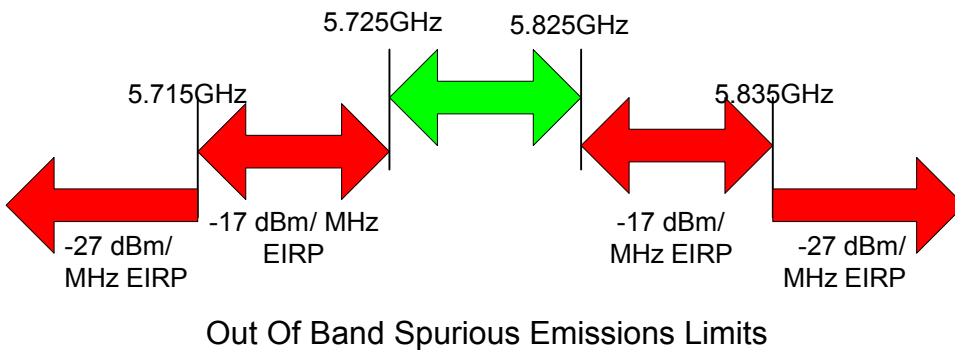
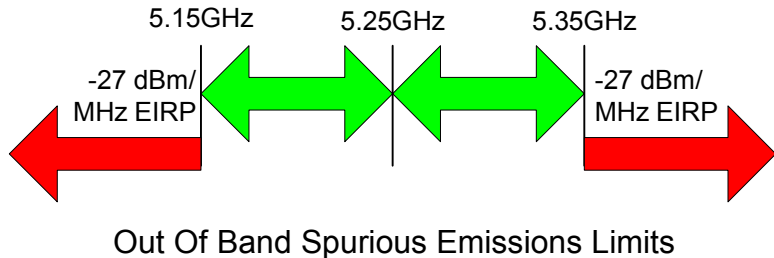

**Results:**

UNII band edge emissions summary. Adjusted limit reflects an antenna gain of 7.4 dBi.

Transmit Frequency (MHz)	Frequency Range	Unadjusted Limit -dBm/MHz EIRP	Adjusted Limit -dBm/MHz EIRP	Level at the band edge (dBm)	Delta dB Below Limit
5180	F < 5.15 GHz	-27	-34.4	-37.33	2.93
5320	F > 5.35 GHz	-27	-34.4	-34.67	0.27
5745	F < 5.715 GHz	-27	-34.4	-39.50	5.10
5745	5.715 - 5.725 GHz	-17	-24.4	-40.83	16.43
5805	5.825 - 5.835 GHz	-17	-24.4	-48.50	24.10
5805	F > 5.835	-27	-34.4	-42.50	8.10

Plots of the out of band emissions at the band edges are shown on the following page.

Out of band emissions  
F < 5.15 GHz

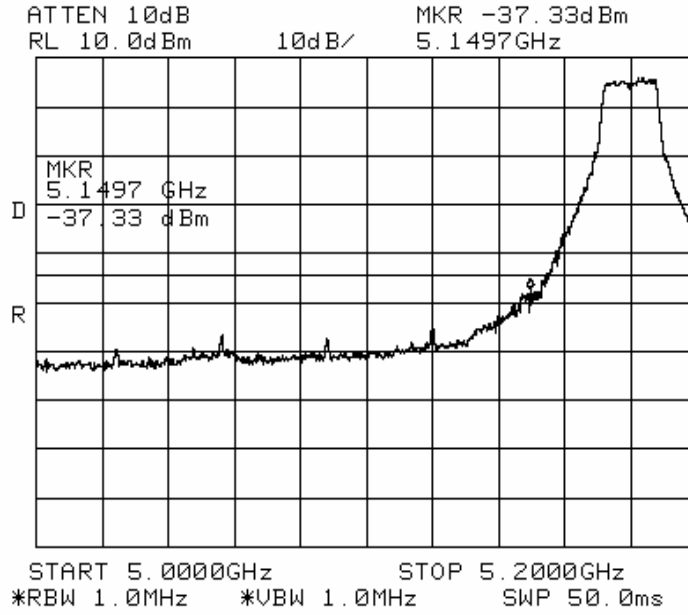

Out of band emissions  
F > 5.35 GHz

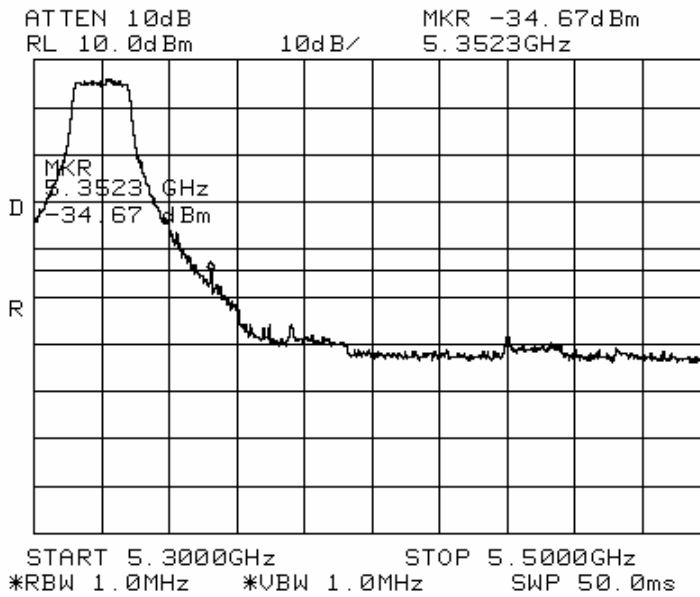

Out of band emissions

F <5.715 GHz

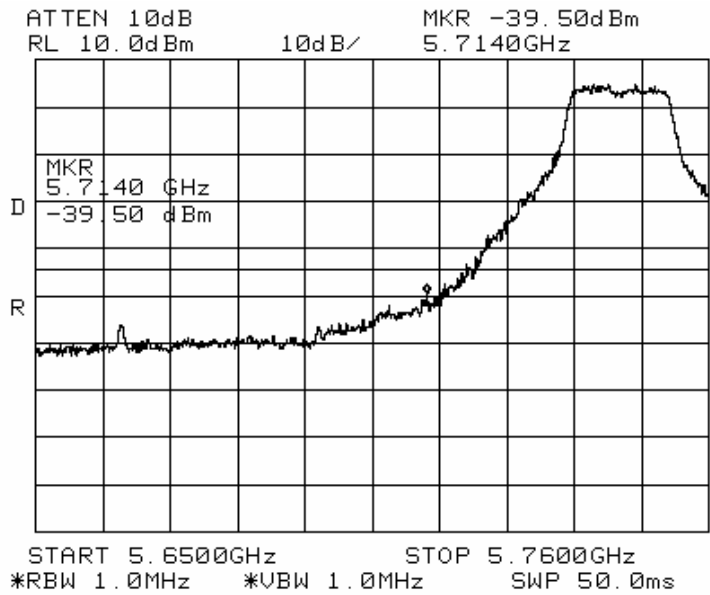

Plot of the 5,725 GHz lower band edge showing the peak @ -40.83dBm

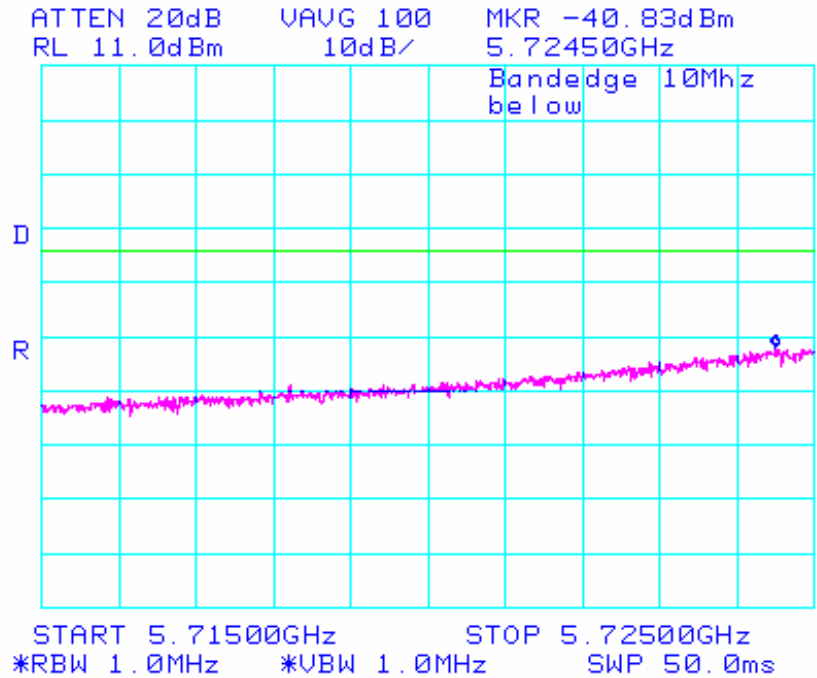

Plot of the 5.825 GHz upper band edge showing the peak @ -48.5dBm

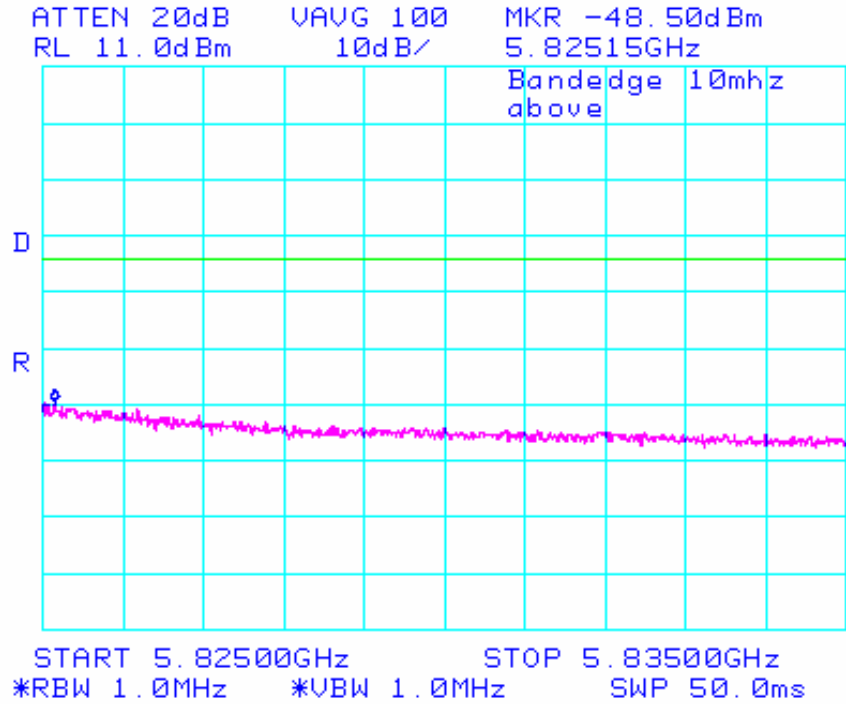

Out of band emissions

F>5.835 GHz

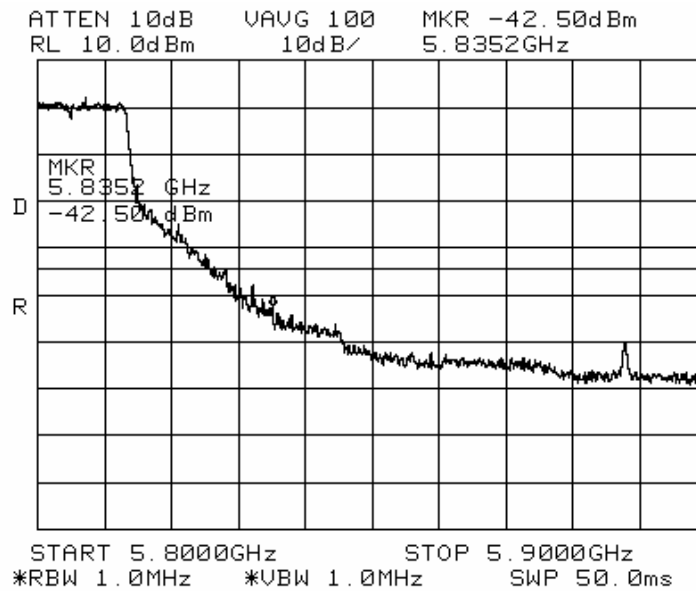

# Peak Excursion

## Specification

FCC Specifications: Paragraphs 15.407(a)(5)

## Procedure:

The test equipment was configured as shown in the RF Conducted bench setup. The analyzer was set to an appropriate span to view the entire emission bandwidth. There were two traces made in order to determine the peak excursion. The following settings were used for the two traces. The delta between the two traces must be less than 13 dB

**Trace 1:** RBW = 1 MHz, VBW = 3 MHz with peak detector and max-hold settings.

**Trace 2:** RBW = 1 MHz. Set VBW = 300 kHz, set to Max Hold and allowed to settle for 60 seconds.

## Results:

Frequency (MHz)	Peak Excursion (dB)	FCC Limit (dBm)
5805	1.80	17.0
5765	2.76	17.0
5745	2.57	17.0
5320	2.90	11.0
5260	2.76	11.0
5180	2.97	4.0

Peak Excursion = 1.8 dB. Frequency 5805 MHz

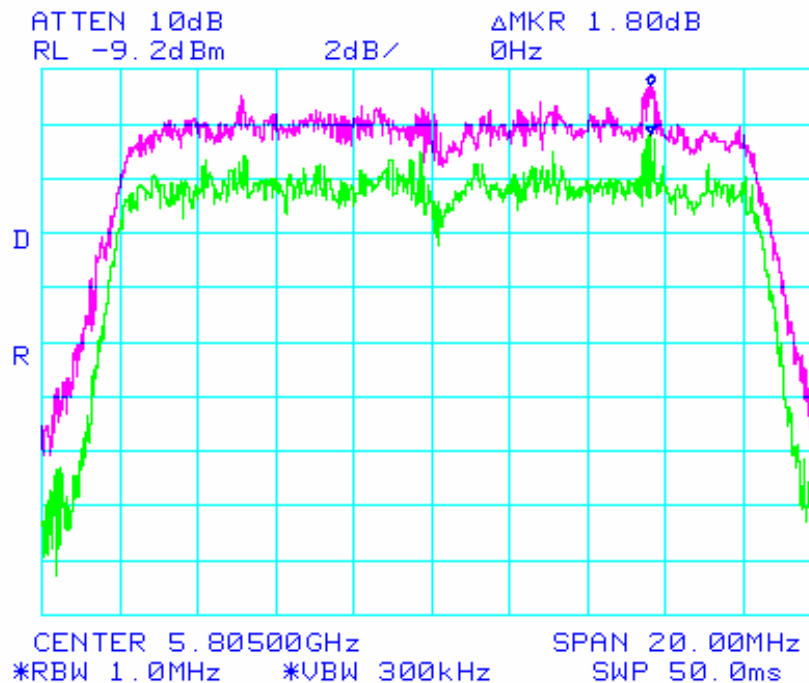

**Peak Excursion = 2.76 dB. Frequency 5765 MHz**

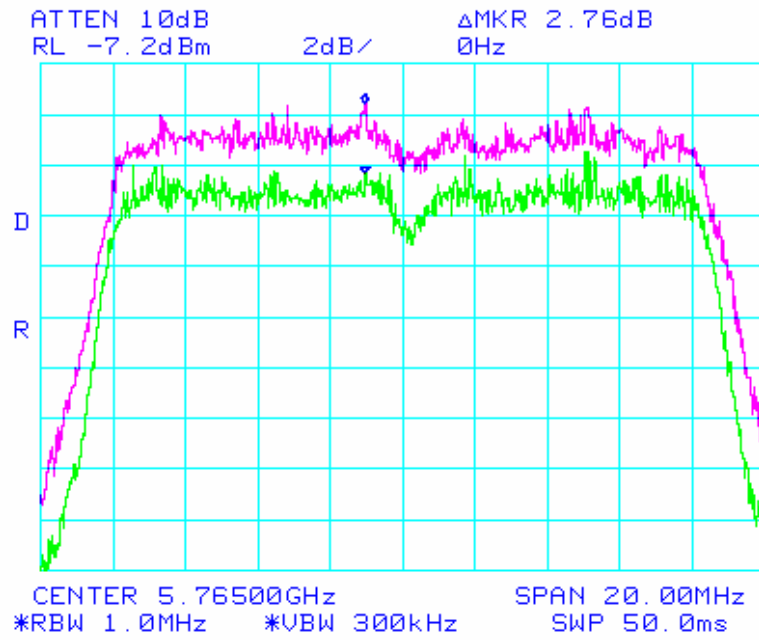

**Peak Excursion = 2.57 dB. Frequency 5745 MHz**

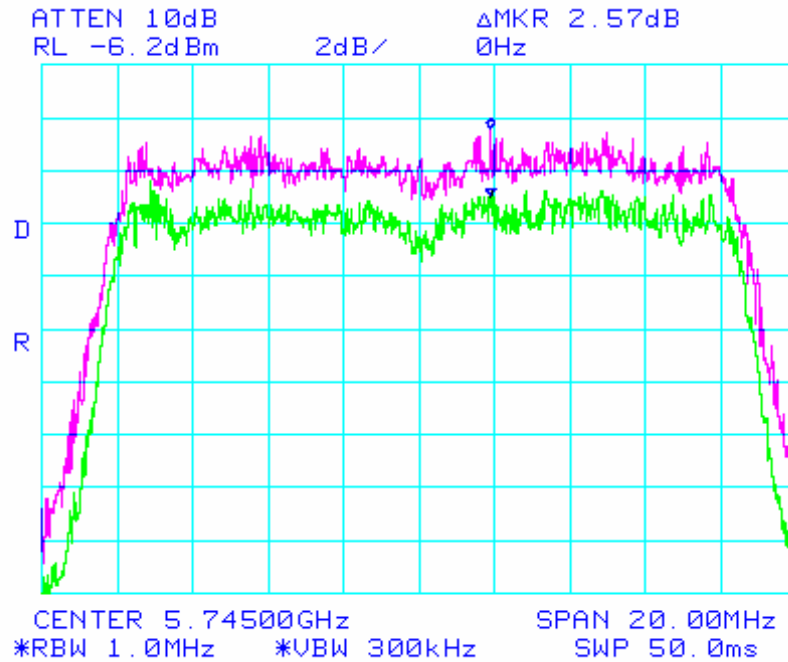





Peak Excursion = 2.97 dB. Frequency 5180 MHz

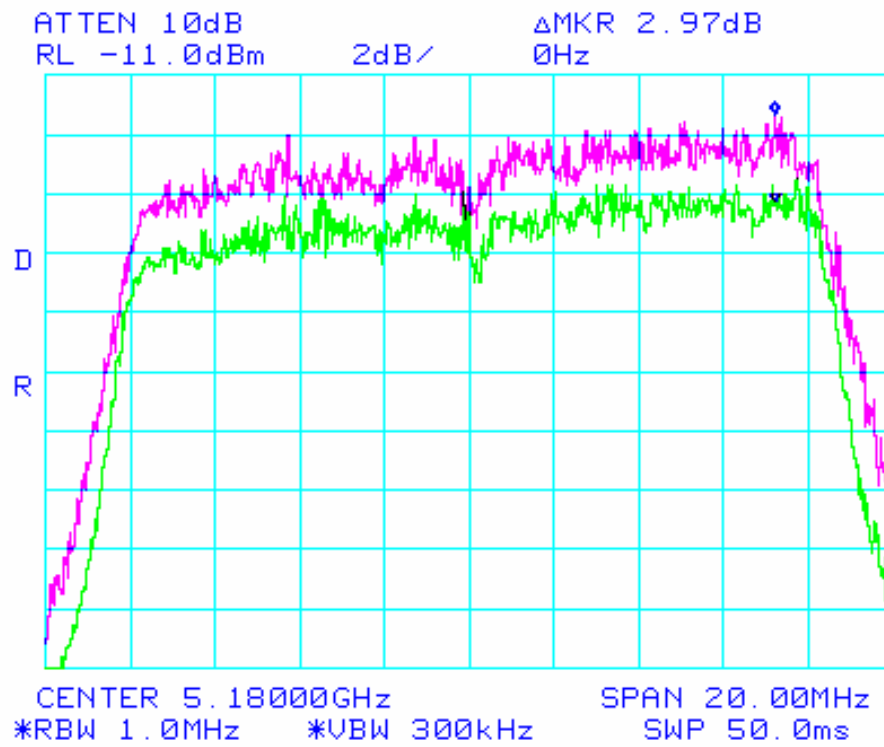

## 5 GHz Radiated Emissions in Restricted bands

### Specification:

FCC Specification:

Paragraph 15.407(b)(6)

### Procedure:

This test was conducted on a 3-meter open-air test site at Elliott Laboratories. The unit was placed on a rotating wooden table 80cm above the ground plane. A Horn antenna(s) were secured to a mast 3 meters away. The unit was tested at each of the Low, Mid and High channels. The UUT was running in the diagnostic mode and set to transmit random data. The transmit power was set to the settings outlined in the power setting table. The test equipment was configured as shown below.

The band from 1 to 40 GHz was scanned (40 GHz is the limit of the available test equipment). A high pass filter prior to the pre-amplifier was required to prevent the signal level of the fundamental frequency from overloading the front end of the spectrum analyzer and creating harmonics within the analyzer.

The EUT was rotated 360 degrees and the height of the antenna adjusted from 1 to 4 meters above the ground plane to determine the maximum level of the emission. The level of the harmonic emission was measured in two modes, "Peak" and "Average".

The spectrum analyzer reading was entered into a spreadsheet where correction factors (antenna factor, cable loss, pre-amplifier gain, HPF loss...) were then applied by Elliott Lab's Software to obtain a final corrected measurement.

This procedure was repeated for the low mid and high channels across the 5 GHz bands.

Fund	2	3	4	5	6	7	8	9	10
5180	10360	15540	20720	25900	31080	36260	41440	46620	51800
5260	10520	15780	21040	26300	31560	36820	42080	47340	52600
5320	10640	15960	21280	26600	31920	37240	42560	47880	53200
5745	11490	17235	22980	28725	34470	40215	45960	51705	57450
5765	11530	17295	23060	28825	34590	40355	46120	51885	57650
5805	11610	17415	23220	29025	34830	40635	46440	52245	58050

### 15.407(b)(6) Harmonic test table

*NOTE: RED indicates a harmonic that falls within a restricted band, the harmonics in gray are NOT in restricted bands.*

### Test Setup

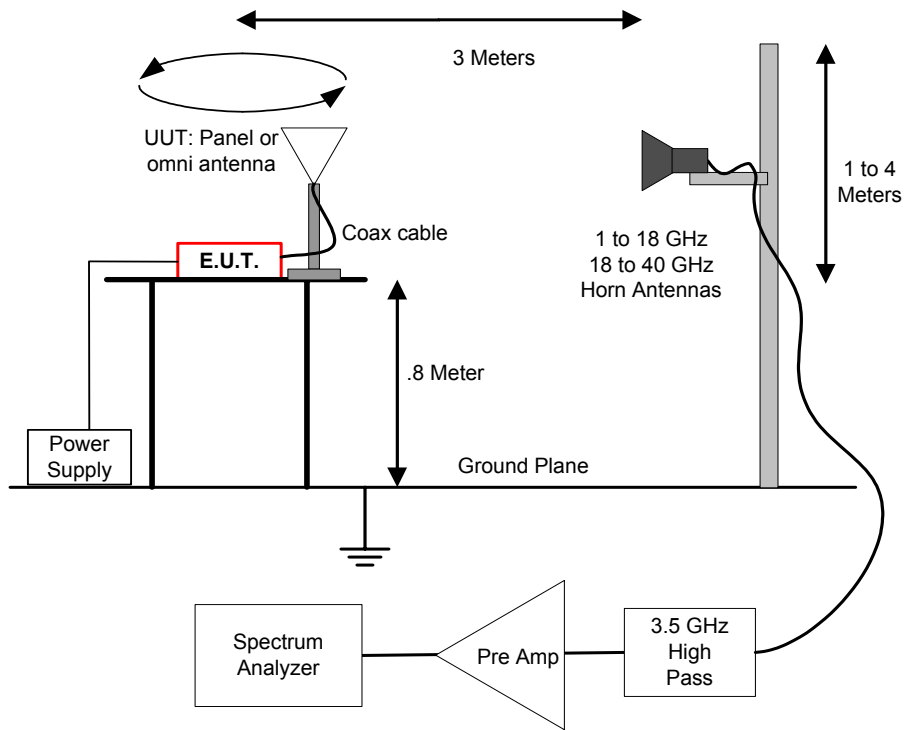

Radiated Emissions in Restricted Bands Test Setup

<b>Support Equipment</b>				
Description	Model number	FCC ID or SN	Manufacturer	Power Cable
Laptop	Armada E 500	P31000T4X20DC12N2	Compaq	Laptop PS
Test Software	Atheros Radio Test		Atheros	"Zip" cord

<b>Test Conditions</b>			
<b>Temperature</b>	17 C	<b>Humidity:</b>	40%
<b>ATM pressure</b>	1020 mBar	<b>Grounding:</b>	None
<b>Tested By</b>	J Martinez	<b>Date of Test:</b>	March 2003
<b>Test Reference</b>	FCC Part 15.205 IC Paragraph RSS210, 6.2.3 ( c )		
<b>Setup Method</b>	ANSI C63.4		
<b>Tested Range</b>	1 GHz to 40 GHz		
<b>Test Voltage</b>	120 VAC / 60 Hz		
<b>Modifications</b>	No modifications were made to the unit		

**Results:** There were some emissions detected during the test. The results are below. In some cases the emission was not within a restricted band. These emissions are highlighted in green. No emissions above approximately the third harmonic (17 GHz) were detected.

Frequency (MHz)	Level dBmV/m	Pol v/h	15.209 / 15.407		Detector Pk/QP/Avg	Azimuth degrees	Height meters	Comments
			Limit	Margin				
<b>LOW UNII Band EUT Xmitting on 5.18GHz Power setting 14</b>								
10360.0	62.6	h	68.3	-5.7	Note 3	285	1.1	Note 3
15540.0	58.2	h	74.0	-15.8	Pk	42	1.1	Note 2
15540.0	45.7	h	54.0	-8.3	Avg	42	1.1	Note 2
10360.0	54.4	v	68.3	-13.9	Note 3	194	1.0	Note 3
15540.0	58.3	v	74.0	-15.7	Pk	60	1.0	Note 2
15540.0	46.0	v	54.0	-8.0	Avg	60	1.0	Note 2
<b>LOW UNII Band EUT Xmitting on 5.26GHz Power setting 17</b>								
15780.0	58.1	v	74.0	-15.9	Pk	0	1.0	Note 2
15780.0	46.3	v	54.0	-7.7	Avg	0	1.0	Note 2
10520.0	52.1	v	68.3	-16.2	Note 3	250	1.0	Note 3
15780.0	58.3	h	74.0	-15.7	Pk	284	1.0	Note 2
15780.0	46.6	h	54.0	-7.4	Avg	284	1.0	Note 2
10520.0	57.2	h	68.3	-11.1	Note 3	166	1.1	Note 3
<b>LOW UNII Band EUT Xmitting on 5.32GHz Power setting 14</b>								
10640.0	59.1	v	74.0	-14.9	Pk	207	1.1	Note 2
10640.0	46.3	v	54.0	-7.7	Avg	207	1.1	Note 2
15960.0	56.9	v	74.0	-17.1	Pk	63	1.0	Note 2
15960.0	45.0	v	54.0	-9.0	Avg	63	1.0	Note 2
10640.0	64.2	h	74.0	-9.8	Pk	133	1.0	Note 2
10640.0	50.3	h	54.0	-3.7	Avg	133	1.0	Note 2
15960.0	57.0	h	74.0	-17.0	Pk	349	1.0	Note 2
15960.0	45.2	h	54.0	-8.8	Avg	349	1.0	Note 2
<b>UPPER UNII Band EUT Xmitting on 5.745GHz Power setting 13</b>								
11490.0	65.4	h	74.0	-8.6	Pk	298	1.0	Note 2
11490.0	53.5	h	54.0	-0.5	Avg	298	1.0	Note 2
17235.0	56.4	h	68.3	-11.9	Note 3	307	1.0	Note 3
11490.0	56.5	v	74.0	-17.5	Pk	110	1.1	Note 2
11490.0	44.2	v	54.0	-9.8	Avg	110	1.1	Note 2
17235.0	57.0	v	68.3	-11.3	Note 3	21	1.0	Note 3
<b>UPPER UNII Band EUT Xmitting on 5765GHz Power setting 13</b>								
11530.0	66.3	h	74.0	-7.7	Pk	331	1.1	Note 2
11530.0	53.9	h	54.0	-0.1	Avg	331	1.1	Note 2
17295.0	56.7	h	68.3	-11.6	Note 3	289	1.1	Note 3
11530.0	58.7	v	74.0	-15.3	Pk	126	1.2	Note 2
11530.0	46.4	v	54.0	-7.6	Avg	126	1.2	Note 2
17295.0	56.4	v	68.3	-11.9	Note 3	0	1.0	Note 3
<b>UPPER UNII Band EUT Xmitting on 5.805GHz Power setting 11</b>								
11610.0	67.1	h	74.0	-6.9	Pk	124	1.0	Note 2
11610.0	53.5	h	54.0	-0.5	Avg	124	1.0	Note 2
17415.0	56.9	h	68.3	-11.4	Note 3	0	1.0	Note 3
11610.0	56.9	v	74.0	-17.1	Pk	244	1.1	Note 2
11610.0	44.8	v	54.0	-9.2	Avg	244	1.1	Note 2
17415.0	56.8	v	68.3	-11.5	Note 3	22	1.1	Note 3

**Notes:**

**#2** Emission is within a restricted band.

Peak measurements: Resolution and Video BW: 1 MHz, 74 dBuV Limit

Average Measurements: Resolution BW: 1MHz and Video BW: 10 Hz, 54 dBuV Limit

Peak measurements: 74 dBuV Limit

Average Measurements: 54 dBuV Limit

**#3** Emission is NOT within a restricted band.

Measurement settings: Resolution BW = 1MHz and VBW = 3MHz.

Video averaging on (100 samples).

Limit -27 dBm / MHz EIRP, adjusted to 3M field strength: 68.3 dBuV

For emissions falling in the restricted bands detailed in 15.205 the general limits of 15.209 apply. For all other emissions the limit is EIRP < -27dBm (equivalent to a field strength at 3m of 68.3 dBuV/m)

## Radiated Emissions in Restricted bands at the band edges.

Ending at 5.15 GHz and beginning at 5.35 GHz

### Procedure

There are three steps to performing this test.

STEP 1: Make a radiated measurement of the fundamental signal with the UUT on the highest channel. This measurement is used using the peak and average RBW and VBW of 1MHz/1MHz and 1MHz/10Hz. This measured radiated level is then used as a reference and is referred to as the *Fundamental Reference Measurement* in the table below

STEP 2: Additional conducted measurements are made for Peak and Average -dBc values. The peak and average bandwidths are:

PEAK: RBW = 1 MHz      VBW = 1 MHz

AVG: RBW = 1 MHz      VBW = 10 Hz

These measurements determine a –dBc (delta dB) level between the fundamental reference level ( in a 1 MHz BW) and the actual level at highest point within the restricted band. This dBc is then subtracted from the associated (peak or avg) radiated field strength reference measurement made earlier.

STEP 3      A third and final measurement is made to determine the apparent drop in fundamental carrier power when the RBW is narrowed from 1MHz (in the reference measurement) to 100kHz (the specification BW) This is referred to below as the “BW Delta”. This correction factor is only allowed in the highest emission in the restricted band is less than 2 “standard bandwidths” from the edge of the restricted band.

This measurement is made at the highest emission within the restricted band and is the apparent drop in level when the RBW is narrowed from 1 MHz to 100 kHz.

This procedure is outline in FCC Public Notice DA 00-705, released on 30 March 2000 and is referred to as the “Marker-Delta Method”

The restricted bands that are of concern in the test are 4.5 – 5.15 GHz and 5.35 – 5.46GHz because these restricted bands are adjacent to one of the operating bands of the VAP.



The power setting of the access point during this test was as shown in the power settings table.

### 5 GHz UNII Band Edge (Restricted band @5.15GHz)

Pol	Fundamental Ref Msmt		dBc Msmt		RBW Delta	Radiated Level at Band Edge		Specification		Delta (dB below Limit)	
	Peak dbuv/m	Avg dbuv/m	Peak dBc	Avg dBc		Peak dB	Avg dB	Peak dBuv/m	Avg dBuv/m	Peak dBuv/m	Avg dBuv/m
Vert	114.2	103.7	49.1	47.1	13	52.07	43.59	74	54	21.9	10.4
Horz	108.3	97.4	49.1	47.1	13	46.17	37.29	74	54	27.8	16.7

### 5GHz UNII Band Edge (Restricted band @5.35 GHz)

Chan	Fundamental Ref Msmt		dBc Msmt		RBW Delta	Radiated Level at Band Edge		Specification		Delta (dB below Limit)	
	Peak dbuv/m	Avg dbuv/m	Peak dBc	Avg dBc		Peak dB	Avg dB	Peak dBuv/m	Avg dBuv/m	Peak dBuv/m	Avg dBuv/m
Vert	116.8	106.6	43.3	46.3	11.5	61.98	48.82	74	54	12	5.18
Horz	108.5	98.9	43.3	46.3	11.5	53.68	41.12	74	54	20.3	12.9

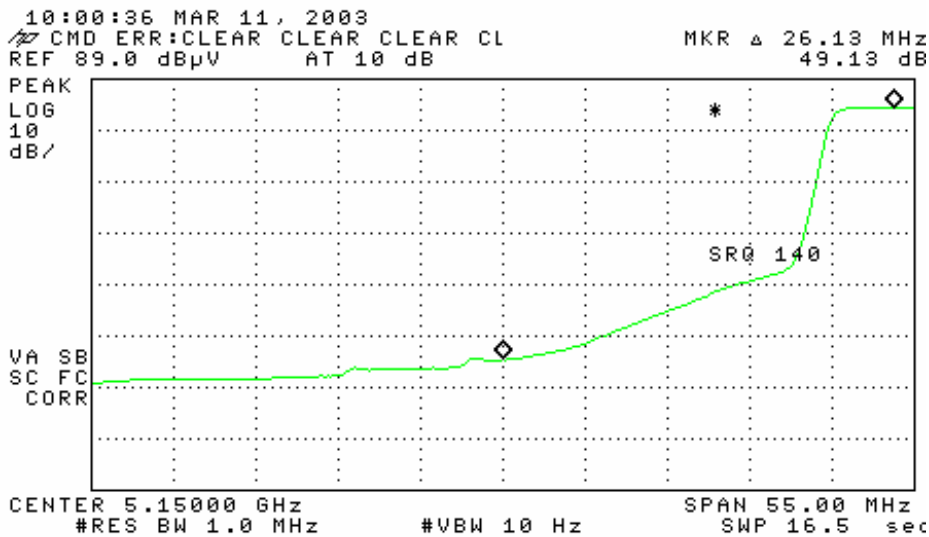

dBc measurement at the low band edge, Avg, RBW = 1MHz, VBW = 10 Hz

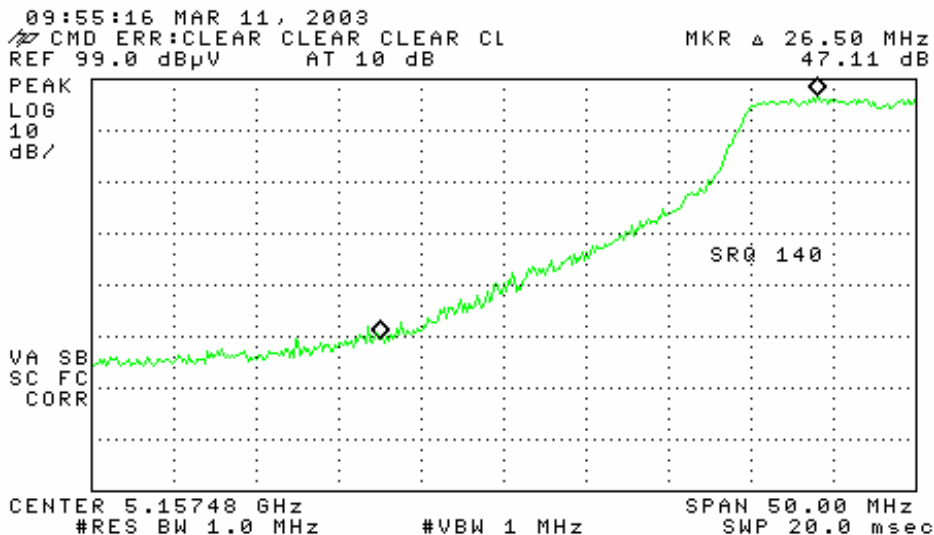

dBc measurement at the low band edge, Peak, RBW = 1MHz, VBW = 1MHz

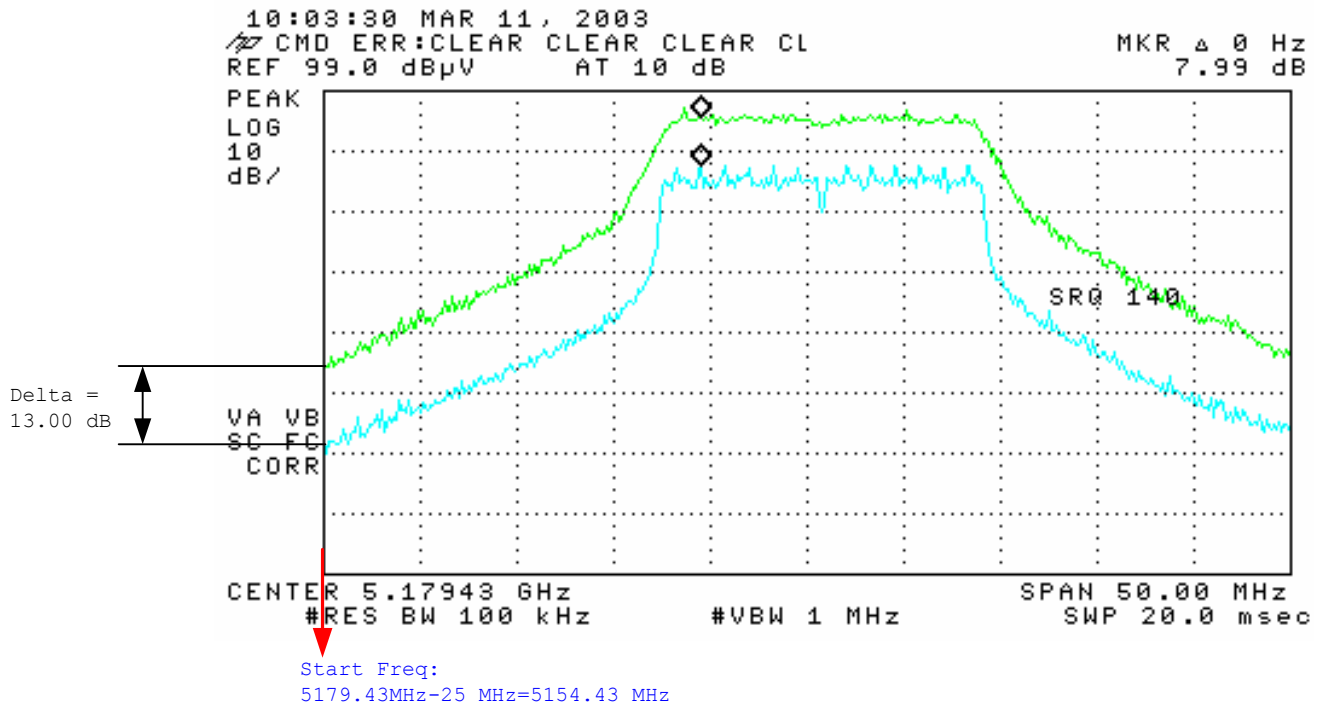

BW Delta measurement at the low band edge



dBc measurement at the low band edge, Avg,  
RBW = 1MHz  
VBW = 10 Hz

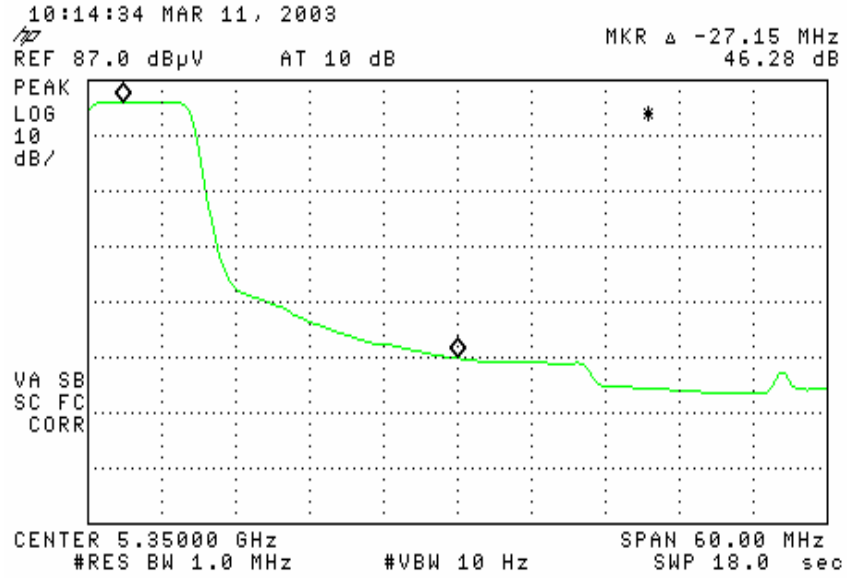

RL

dBc measurement at the low band edge, Peak,  
RBW = 1MHz  
VBW = 1MHz

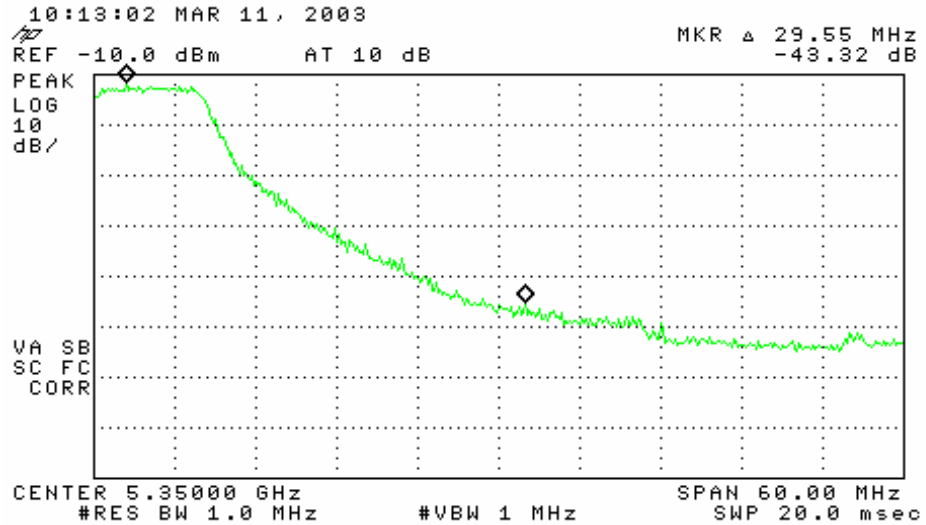

RL

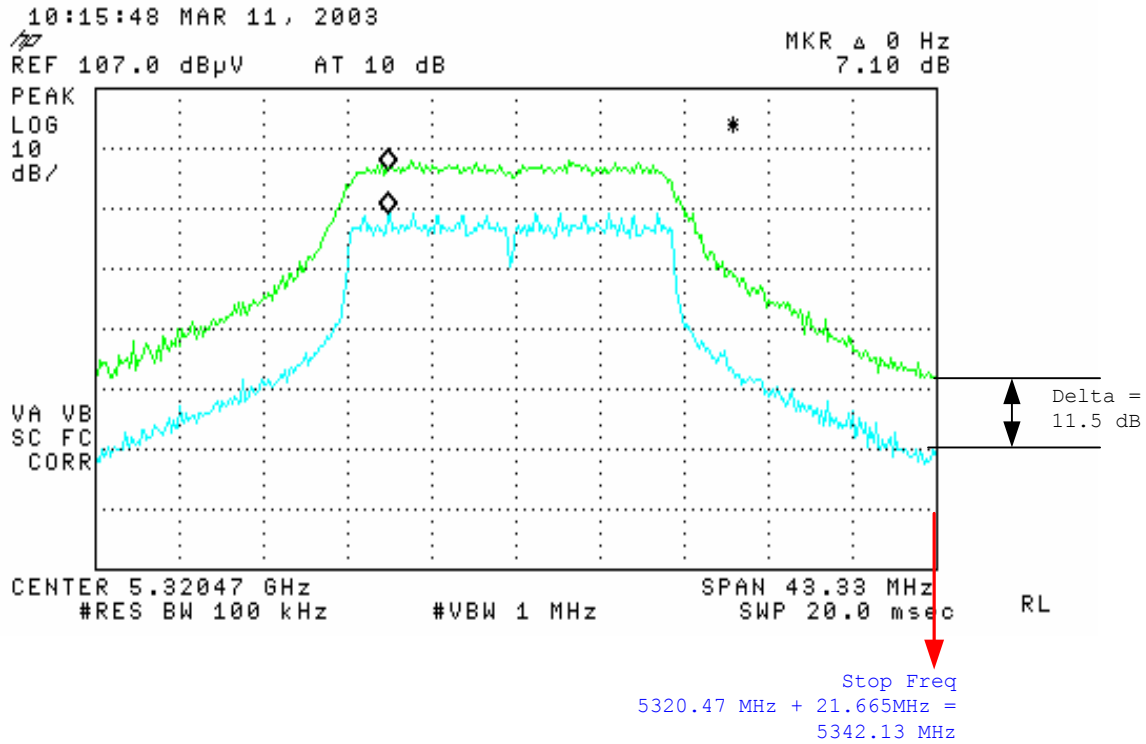

BW Delta measurement at the high band edge

### Radiated Emissions Sample Calculations

<b>Restricted band level (AVG) = AVG reference level - AVG delta dB - BW Delta dB</b>
<b>Restricted band level (Peak) = Peak reference level - Peak delta dB - BW Delta dB</b>

## AC Line Conducted Emissions

### **Specification:**

**FCC Specification:** Paragraph CISPR 22

### **Procedure:**

The test was set up according to the guidelines set forth in EN55022:1998 and FCC Part 2 for AC Line Conducted Emissions. The measurement used a LISN line on each AC line and an EMI receiver. A peak scan was made over the measurement frequency range (150 kHz to 30 MHz). The highest peaks were then marked and re-measured and quasi-peaked and averaged.

The test was configured as shown below. The product was tested while running on 120 VAC @ 60 Hz .

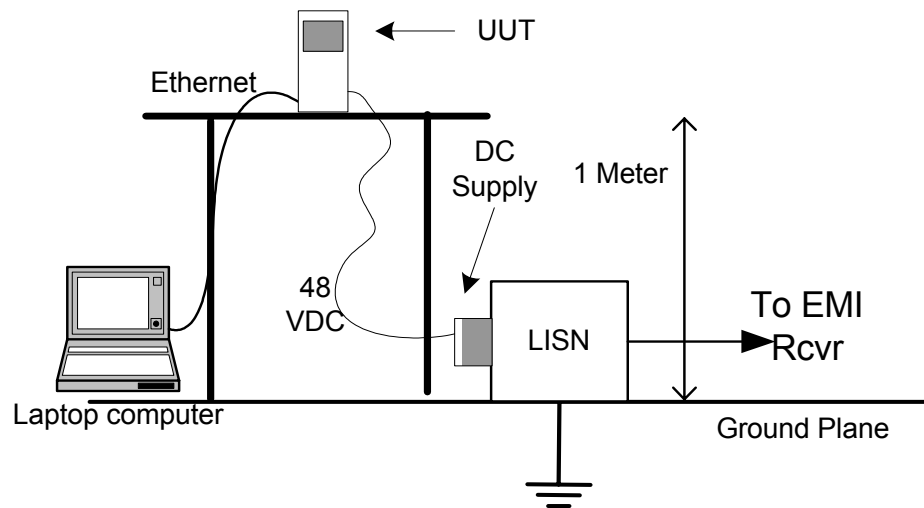

### **Results:**

The "Quasi-peak" results for the unit transmitting packets are contained in the table below. The complete range band of 150 kHz to 30 MHz was scanned, however, the highest levels of emissions were within the relatively narrow band between 25 and 30 MHz.

**Quasi Peak Test Results, CISPR 22 Class B limits**

Freq (MHz)	Line	QP Level (dBuV)	Class B QP Limit (dBuV)	Delta (dB)	Freq (MHz)	Line	Class B QP Limit (dBuV)	Spec (dBuV)	Delta (dB)
	Neutral					Neutral			
25.83	Line	40.97	60	19.03	25.65.	Neutral	40.05	60	19.95
26.35	Line	47.89	60	12.11	26.35	Neutral	43.48	60	16.52
26.62	Line	41.25	60	18.75	26.62	Neutral	42.53	60	17.47
26.85	Line	46.92	60	13.08	26.84	Neutral	46.86	60	13.14
27.1	Line	46.91	60	13.09	27.1	Neutral	43.35	60	16.65
27.29	Line	58.75	60	1.25	27.59	Neutral	48.14	60	11.86
27.6	Line	46.98	60	13.02	27.86	Neutral	41.28	60	18.72
27.83	Line	48.61	60	11.39	28/09	Neutral	46.23	60	13.77
28.12	Line	41.46	60	18.54	28.32	Neutral	48.92	60	11.08
29.58	Line	45.29	60	14.71	28.57	Neutral	45.2	60	14.8

**AVG Test Results, CISPR 22, Class B limits**

Freq (MHz)	Line	AVG Level (dBuV)	Class B AVG limit (dBuV)	Delta (dB)	Freq (MHz)	Line	AVG Level (dBuV)	Class B AVG limit (dBuV)	Delta (dB)
	Neutral					Neutral			
25.83	Line	25.475	50	24.53	25.65.	Neutral	30.7	50	19.3
26.35	Line	30.23	50	19.77	26.35	Neutral	30.35	50	19.65
26.62	Line	31.44	50	18.56	26.62	Neutral	33.05	50	16.95
26.85	Line	34.257	50	15.74	26.84	Neutral	32.17	50	17.83
27.1	Line	29.59	50	20.41	27.1	Neutral	30.37	50	19.63
27.29	Line	36.118	50	13.9	27.59	Neutral	27.96	50	22.04
27.6	Line	28.64	50	21.36	27.86	Neutral	31.04	50	18.96
27.83	Line	29.9	50	20.1	28/09	Neutral	31.55	50	18.45
28.12	Line	34.03	50	15.97	28.32	Neutral	35.91	50	14.09
29.58	Line	32.43	50	17.57	28.57	Neutral	28.19	50	21.81