



110 Nortech Parkway
San Jose, CA, 95134
(408) 635 2000
www.airespace.com

FCC Part 15.247 Class II Permissive Change Application

Industrie Canada RSS210 Reassessment Application

EMI Test Report on IEEE 802.11 Access Point. Models:1250, 1250INT, 1250B, 1250BINT

FCC ID: QTZ1200W

IC ID: 4518A-1200W

Report#: AES_1200W_C2PC

Prepared by:
David Waitt
202 Calvert Drive #217
Cupertino, Ca. 95014
david@waitt.us
(408) 832 7053

Table of Contents

Section	Page
General Information	3
Permissive Change Summary / Detailed Product Information	4
Internal Antenna Version	6
Internal / External Antenna Version	7
Test Results Summary	8
Test Facilities	9
Equipment Lists	10
Instrument Calibration	10
Elliott Test Equipment.....	10
Additional Test Equipment.....	10
Test Methods	11
Test Results	12
802.11 B/G/A Maximum RF Power Output at Antenna Terminals	13
802.11 B/G.....	14
802.11 A (ISM).....	14
Power Spectral Density	15
Specifications:.....	15
Procedure:	15
Results:.....	15
Radiated Emissions In Restricted Bands & Out Of Band Emissions	18
Specifications:.....	18
Procedure:	18
Results:.....	20
802.11 B 13 dBi Panel Antenna MP24103XFPTMSMA	20
802.11 G 13 dBi Panel Antenna MP24103XFPTMSMA.....	22
802.11 A 14 dBi Panel Antenna (ISM Band) S51514WP36RTN.....	24
802.11 B 8 dBi Omni Antenna MFB24008NM.....	26
802.11 G 8 dBi Omni Antenna MFB24008NM	30
802.11 A 9 dBi Omni Antenna MFB58009.....	34
802.11 B 3 dBi "Squint" Omni Antenna SQ2403PN36RTNMO	Error! Bookmark not defined.
802.11 G 3 dBi "Squint" Omni Antenna SQ2403PN36RTNMO.....	Error! Bookmark not defined.
802.11 A 6 dBi Omni Antenna (ISM Band) S5153WPBX36RTN	38
Radiated Emissions in Restricted bands (2.4 GHz Band Edges).....	42
Results Summary Table (2.4 GHz 802.11 B & G) 12 dBi Panel Antenna.....	43

General Information

Unit(s) Under Test: IEEE 802.11 Access Point (AP)
Model(s): 1250, 1250INT, 1250B, 1250BINT

Product Description: IEEE 802.11 A/B/G Access point

FCC ID: QTZ1200W
IC ID: 4518A-1200W

Tested For: Airespace Inc.
110 Nortech Parkway
San Jose 95134

Tested At: Elliott Laboratories
684 West Maude Ave
Sunnyvale, CA 94086

Tested By: Yalda Noor Test Engineer, Elliott Laboratories
Juan Martinez, Test Engineer, Elliott Laboratories
David Waitt, (Independent Consultant)

Test Specifications: FCC CFR 47, Part 15.247, 2.4 GHz / 5.8 GHz

Test Date: Jan - Feb 2005

Requested Certifications: FCC Class II Permissive Change Request
IC Reassessment

Permissive Change Summary / Detailed Product Information

The access point radio is an IEEE 802.11 A/B/G Access point (AP) intended to be professionally installed and configured in corporate and industrial environments. There are two versions of the AP

- Internal Antennas only
- Internal / External Antennas

The purpose of this permissive change is to authorize additional external antennas to be used with the external antenna version of the access point. These additional antennas consist of both, antennas of a different type than what was originally certified and antennas with higher gain than what was originally certified.

While this permissive change seeks to follow FCC policy and allow antennas of the same type of equal or lesser gain to be used with the product from various manufacturers, a table of the desired antennas and those that were actually tested with the access point is below.

Mfg	Mfg PN	Freq Band (MHz)	Net Gain (dBi)	Type	Comment	C2PC Tested
MaxRad	MFB58009	5.725 - 5.875	9.0	Omni	Omni directional	YES
Cushcraft	S5153WPBX36RTN	5.15-5.875	6.0	Omni	Omni directional	YES
Cushcraft	S51514WP36RTN	5.15-5.875	14.0	Panel	Panel	YES
MaxRad	MFB24008NM	2.4 - 2.5	8.0	Omni	Omni Directional	YES
Maxrad	MP24103XFPTMSMA	2.4 - 2.5	13.0	Panel	Panel	YES

In addition to allowing the use of additional external antennas, this permissive seeks to reclassify the 5.725 - 5.825 from UNII to ISM for both types of access points, (internal and external antenna types)

Additionally, this permissive change requests authorization for operation within the band 5825MHz to 5850MHz for both types of access points, (internal and external antenna types)

Testing was performed as indicated below to verify the continued compliance of the access points. All of the tests were performed at the power levels specified in the original test reports.

TEST	Performed (Y / N)	Justification
Radiated emissions in Restricted bands / Out of band emissions	Y	It is reasonable to assume that the radiated emissions performance of the AP may be affected by utilizing an different antenna
2.4 GHz Power Spectral Density	N	The power spectral density specification is NOT in terms of EIRP, therefore, as long as the transmit power is unchanged, the PSD should not be affected by a different antenna
5 GHz Power Spectral Density	Y	Because of the reclassification on the upper 5 GHz band, the PSD specification is different. Even though the ISM specification is less stringent, this parameter was re-tested.
RF Transmit power	N	While the transmit power was verified for the radiated emissions testing, to ensure it is the same as the original grant, it is not presented in this report
Bandwidth	N	There is no reason to expect that the use of a different antenna would affect the bandwidth of the signal
Line Conducted Emissions	N	There is no reason to expect that the use of a different antenna would affect the AC line conducted emissions of the access point

Internal Antenna Version

(Not applicable to the external antenna portion of this permissive change)

The AP utilizes integral antennas on the 802.11 B/G band. The access point effectively includes only a single 2.4GHz patch antenna, however, there are actually two 2.4 GHz antennas internal to the access point chassis. The module switches rapidly between the two antennas and when a signal is detected, the access point uses the antenna offering the best transmission characteristics. At any one time, there is only one antenna connected to the internal PCI module.

The effective gain of the 2.4 GHz internal antenna path is 7.8dBi. The diagrams below outline the RF path from the output of the RF circuitry to the integral antennas within the access point. The software within the internal antenna version shown below prohibits the switching of the FET antenna switches.

Not shown on the diagram below, but present on the actual AP are external antenna connectors mounted in the AP chassis. These external antenna connectors are present on the “internal antenna only version” to allow both versions to use the same chassis. These connectors are not present to facilitate a modification to the access point.

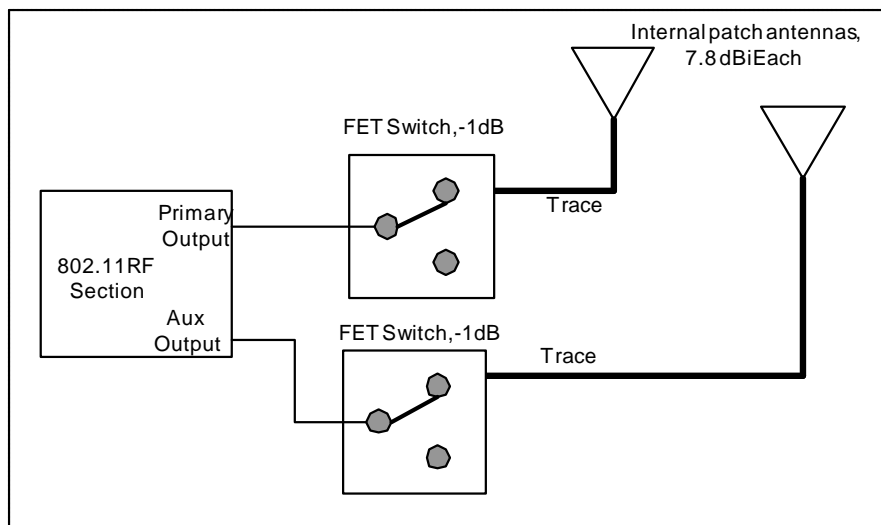

2.4 GHz RF Block Diagram (Internal Antenna Version)

Internal / External Antenna Version

Additionally, there is a version of the access point which allows connection of external antennas. When external antennas are connected to the access point, the configuration software switches the internal antenna switches into the EXT position. The antenna diversity functionality described earlier works in a similar manor to the internal antennas. The external antennas used with the access point must be “patch” type antennas and have a net effective gain (antenna gain - cable loss) equal to 7.8 dBi or less. At any one time, ONLY the internal or external antennas may be selected. It is NOT possible to configure the access point to rapidly toggle between external and internal antennas.

The only physical difference between the internal only version and the internal / external version of the access point is the addition of a small coax cable from the PCB to an external 15.203 compliant antenna connector in the chassis.

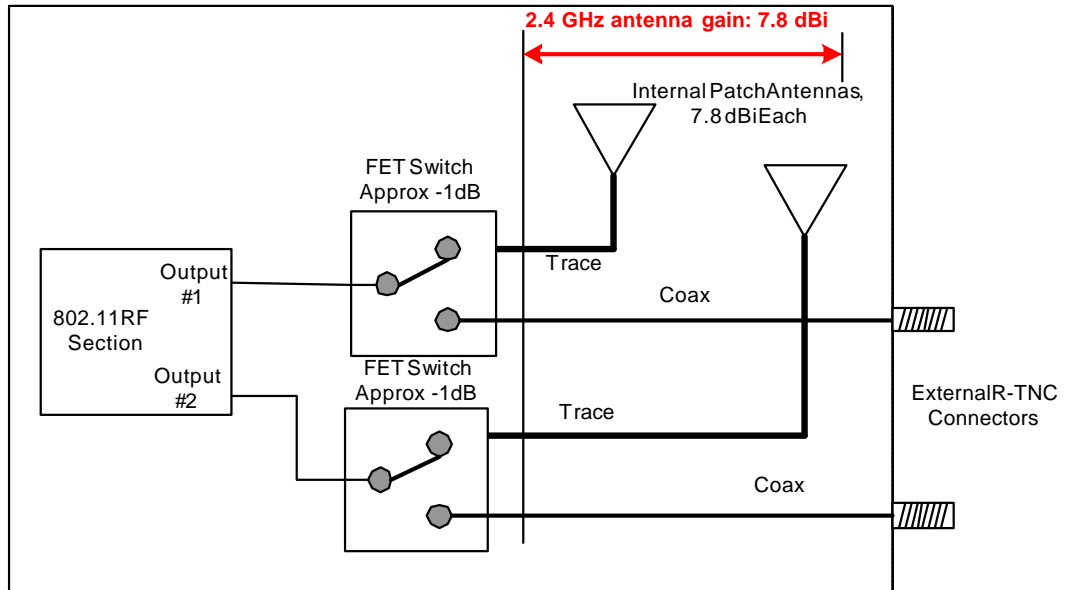

2.4 GHz RF Block Diagram (Internal / External Antenna Version)

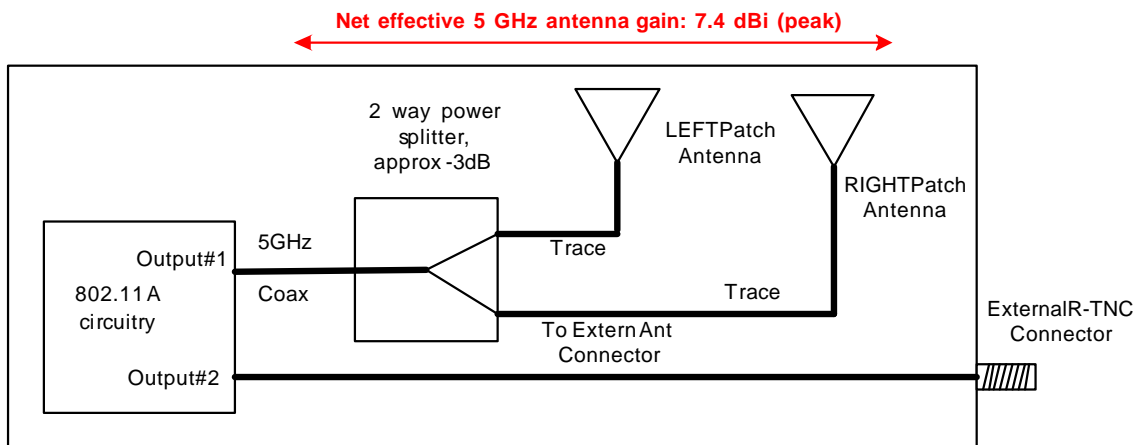

5 GHz RF Block Diagram (Internal / External Antenna Version)

Test Results Summary

This report presents the results of the tests that verify compliance with FCC Part 15.247 and

A brief results summary of all the in this report is below.

Part 15 Paragraph	RSS-210 Paragraph	Test	Results
15.205	6.3(c)	Radiated Emissions in Restricted bands	.3 dB in spec min @4873 MHz (2D harmonic of 2437)
15.247	6.2	ISM Power Spectral Density	-5.36 dBm/8kHz
15.247	6.2	Emissions at the 5.725 - 5.85 GHz band edge	-31.718dBc

Test Facilities

The radiated emissions tests were performed at:

Elliott Labs
684 West Maude Ave
Sunnyvale, CA 94086

The tests performed at Elliott include:

- All radiated emissions tests required in FCC Part 15.205 for 2.4 GHz.
- Out of band emissions (Conducted) (for 2.4 GHz)

General:

Final 802.11 B radiated test measurements were taken at Elliott Laboratories Chamber #5.

The test site contains separate areas for radiated and conducted emissions testing. Pursuant to section 2.948 of the Rules, construction, calibration, and equipment data has been filed with the Commission.

The FCC recommends that ambient noise at the test site be at least 6 dB below the allowable limits. Ambient levels are below this requirement with the exception of predictable local TV, radio, and mobile communications traffic. The test site contains separate areas for radiated and conducted emissions testing. Considerable engineering effort has been expended to ensure that the facilities conform to all pertinent FCC requirements.

OATS:

The FCC has determined that radiation measurements made in a shielded enclosure are not suitable for determining levels of radiated emissions. Radiated emissions are performed in an open field environment. The test site is maintained free of conductive objects within the CISPR defined elliptical area incorporated in ANSI C63.4 Guidelines.

Antenna, Antenna Mast and Turntable

The Horn antennas that are used to measure radiated emissions above 1000MHz are mounted on a non-conductive antenna mast equipped with a motor drive to vary the antenna height.

ANSI C63.4 specifies that the test height above the ground plane shall be 80cm unless the equipment is intended to be floor mounted. During the radiated emissions tests the equipment is positioned on a motorized turntable in conformance with the ANSI requirement.

Equipment Lists

Instrument Calibration

All test equipment is regularly checked to ensure that performance is maintained in accordance with the manufacturer's specifications. All antennas are calibrated at regular intervals with respect to tuned half-wave dipoles. An exhibit of this report contains the list of test equipment used and calibration information.

The following test equipment was used to perform the testing

Elliott Test Equipment

<u>Manufacturer</u>	<u>Description</u>	<u>Model #</u>	<u>Asset #</u>	<u>Cal Due</u>
Hewlett Packard	Microwave Preamplifier, 1-26.5GHz	8449B	263	09-Jan-06
EMCO	Horn Antenna, D. Ridge 1-18GHz	3115	868	20-Apr-06
Hewlett Packard	Microwave EMI test system (SA40, 9kHz - 40GHz) Fremont	84125C	1410	26-Mar-05
Hewlett Packard	EMC Spectrum Analyzer 9KHz-26.5GHz, non programmable	8563E	284	15-Mar-05
Rohde & Schwarz	Power Meter, Single Channel	NRVS	1290	22-Apr-05
Rohde & Schwarz	Peak Power Sensor 100uW - 2 Watts	NRV-Z32	1536	22-Apr-05

Additional Test Equipment

<u>Item Desc.</u>	<u>Manufacturer</u>	<u>Model</u>	<u>S/N</u>	<u>Cal due date</u>
1. Spectrum Analyzer	Agilent	E4440A	MY43362314	16 Jan 2006

Test Methods

The tests are performed at a low, middle and high channel of the applicable band. The typical frequencies used for the Part15.247 ISM tests are shown in the table to the right. Unless otherwise noted, all testing was performed on these channels / frequencies

ISM 802.11 B / G 2400 – 2483.5 MHz			ISM 802.11 A 5725 - 5825 MHz	
Channel		Freq(MHz)	Channel	Freq(MHz)
Low	Chan 1	2412	Low	5745
Mid	Chan 6	2437	Mid	5785
High	Chan 11	2462	High	5825

In order to comply with the “radiated emissions in restricted bands” requirements the transmit power had to be lowered on some of the channels at the edges of the operating band. The maximum power setting that allowed compliance with the radiated emissions requirements will be programmed into the configuration firmware of the access point ensuring that maximum possible power setting will be correct for each channel.

Given that the access point will normally be operated at these power settings, these same settings were also used during the “bench top” conducted RF tests (Spectral density, bandwidth etc).

The tests listed below are performed using the basic “conducted” test setup shown below unless otherwise noted. In most cases, the EUT was running special diagnostic software to allow it to transmit random data on a particular channel indefinitely.

Part 15 **Test**
 15.247(a)(1)(i) Power Spectral Density

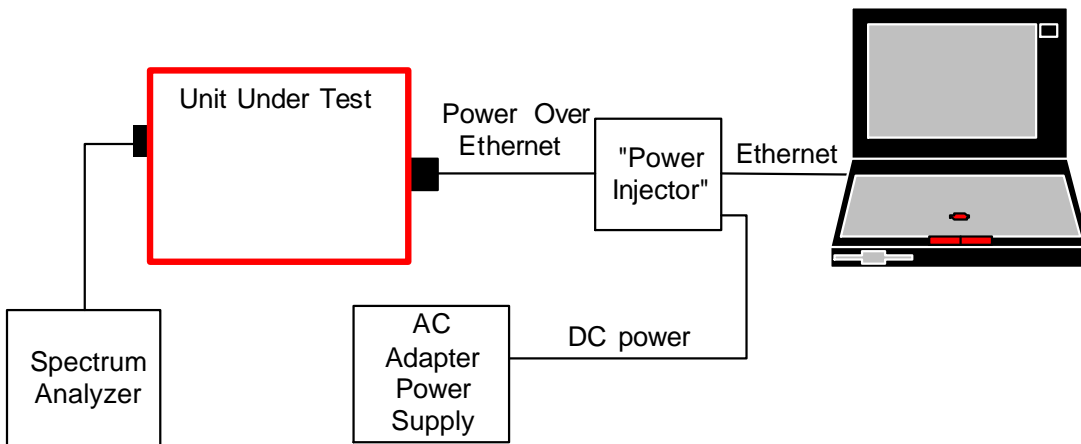

Basic Conducted RF Bench Test Setup

Unless otherwise noted, the support equipment for the bench tests is listed below.

Support Equipment				
Description	Model number	FCC ID or SN	Manufacturer	Power Cable
Laptop	A20	DOC	IBM	Laptop PS
Test Software	Atheros Radio Test		Atheros	
48VDC AC adapter	Generic		Generic	Standard Twin lead DC wire

NOTE: The “Power Injector” is simply a connector attached to wires “broken out” of the Ethernet cable. It is not really a piece of equipment.

Test Results

Detailed test procedures and test results are contained in the following sections. In cases where the test setup differs from the Conducted RF test setup shown earlier, the test setup is also presented.

Test Conditions			
Temperature	23C	Humidity:	45%
ATM pressure	1010 mBar	Grounding:	None
Tested By	David Waitt	Date of Test:	Feb 2005
Test Reference	Refer to individual test results		
Tested Range	Test Dependent		
Test Voltage	48 VDC to the AP		
Modifications	No modifications were made to the unit during the tests		

802.11 B/G/A Maximum RF Power Output at Antenna Terminals

(For Reference only from initial test report)

Specifications:

FCC Specification: Paragraph: 15.247(b)

IC Specification: RSS-210, 6.2.2.(o)(b)

Procedure:

The test was configured as shown in the conducted RF test setup. The unit was tuned to the test channels and configured to transmit random data packets. The integration bandwidth of the spectrum analyzer was then set to the previously measured 20 dB bandwidth of the signal. The integrated channel power was then measured over that bandwidth.

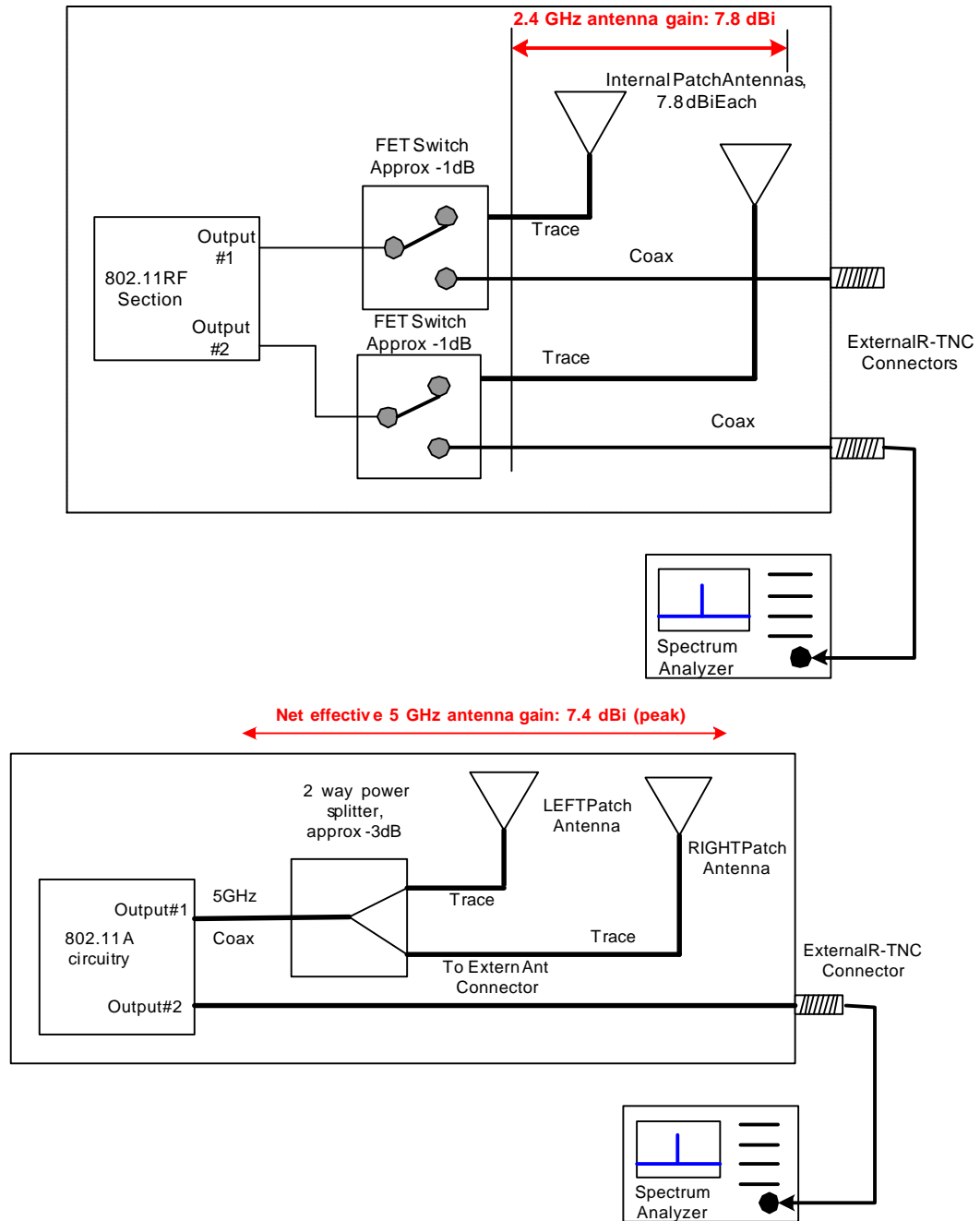

The power levels below reflect the power into the antenna due to the fact that the power out of the external connector is the same as into the antenna. The power measurements listed in the tables above are also applicable for the power into the external antennas if used with the product

NOTE: The power was reduced on 802.11 B Channel 1 (2412 MHz) band edge to comply with restricted band radiated emissions requirements at 2390 MHz.

802.11 B/G

Freq (MHz)	802.11 B			802.11 G			EIRP Spec (dBm)	Min Spec Delta (dB)
	Power into antenna (dBm)	Power into antenna (mW)	Xmit Power (dBm EIRP)	Power into antenna (dBm)	Power into antenna (mW)	Xmit Power (dBm EIRP)		
2412	16.48	44.46	24.28	17.10	51.29	24.90	36.00	11.10
2437	18.77	75.34	26.57	17.30	53.70	25.10	36.00	9.43
2462	18.97	78.89	26.77	17.77	59.84	25.57	36.00	9.23

802.11 A (ISM)

INTERNAL or EXTERNAL ANTENNA								
Frequency MHz	Measured 26 dB Channel Power at Ext Ant connector		Power Spec dBm	Delta dBm	Maximum EIRP (Ant gain = 7.4dBi MAX)		Maximum EIRP Spec Pout+6dBi dBm EIRP	Delta dB
	dBm	mW			dBm	mW		
5745	19.55	90.16	30.00	10.45	26.95	495.45	36.00	9.05
5765	19.69	93.11	30.00	10.31	27.09	511.68	36.00	8.91
5805	19.35	86.10	30.00	10.65	26.75	473.15	36.00	9.25

5825 MHz Maximum RF Power Output at Antenna Terminals

Specifications:

FCC Specification: Paragraph: 15.247(b)

IC Specification: RSS-210, 6.2.2.(o)(b)

Procedure:

The RF transmit power on 5.825 GHz was measured using the procedure outlined above. This measurement was performed for this permissive change because the initial grant did not include this channel.

Result: The measured 26dB Channel power for 5.825GHz is : 19.2 dBm

Power Spectral Density

Specifications:

FCC Specification: Paragraph 15.247(4)(d)

IC Specification: RSS-210 .6.2.2(o)(b)

Procedure:

The 5.8 GHz ISM PSD was retested as part of this permissive change request. Because the 2.4 GHz ISM PSD is a conducted test and not an EIRP limit, it was NOT retested as part of this permissive change request.

The test setup was configured as shown in the conducted test setup. The UUT was configured to continuously transmit random data packets. Initially the bandwidth of the entire channel was examined. Using MAX HOLD, the trace was allowed to stabilize. Once the trace was stable, a peak search was performed and the frequency with the maximum power was determined.

The measurement span was then narrowed to 300kHz and centered on the "MAX power" frequency, the RBW set to 3 kHz with a 100 second sweep. The analyzer was then set to MAX HOLD and a display line placed at +8dBm.

The power spectral density was measured at the low, middle and high-test channels with the appropriate power setting for the given test channel.

Results:

Frequency MHz	Specification (dBm/3 kHz)	802.11 A Measured PSD (dBm)	Spec Delta 802.11 B dB min
5745	8	-5.36	13.36
5785	8	-6.26	14.26
5825	8	-5.57	13.57

Agilent 19:45:32 Feb 21, 2005

Power Spectral Density, 802.11 A LOW Channel, ISM 5745MHz

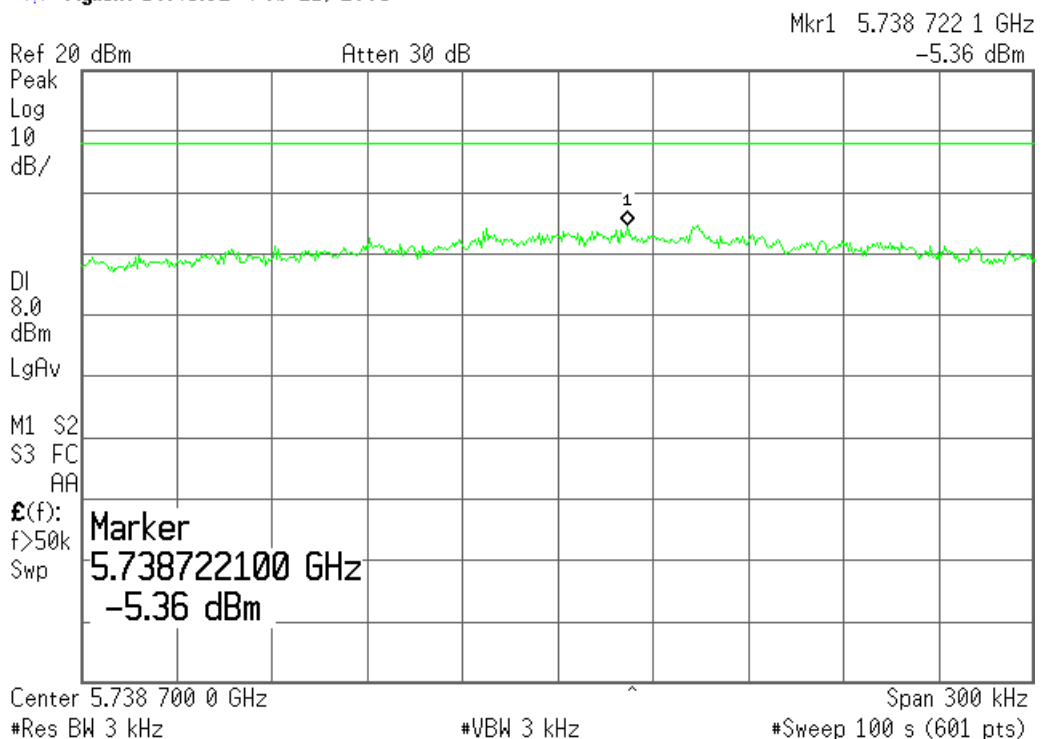

Agilent 19:52:16 Feb 21, 2005

Mkr1 5.786 202 5 GHz
-6.26 dBm

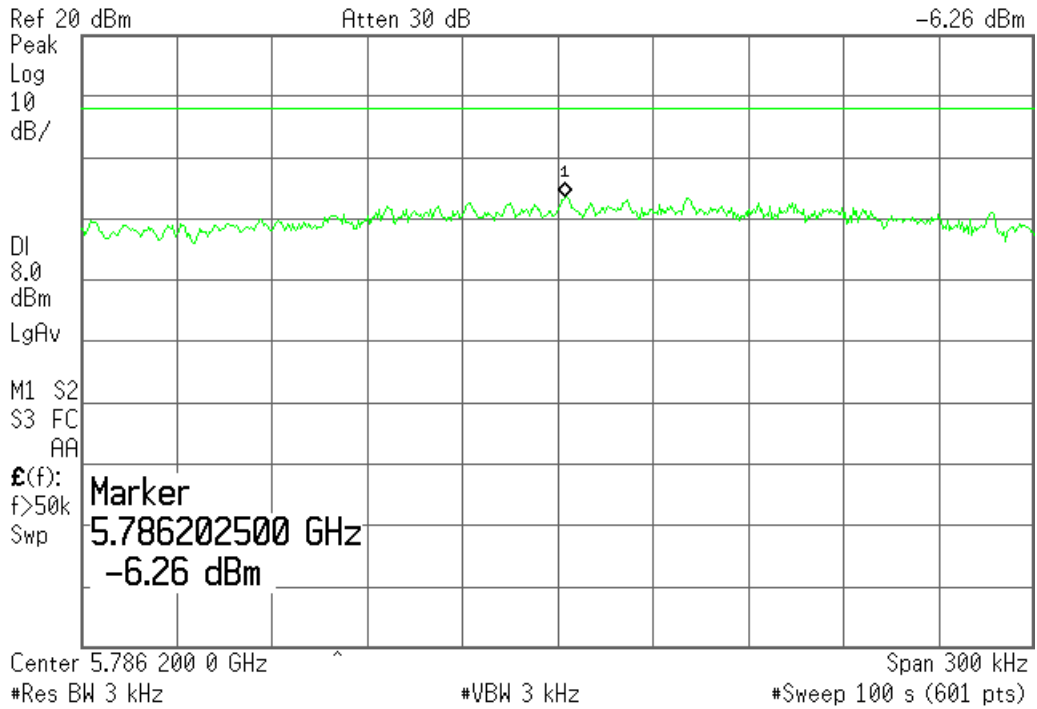

Power Spectral
Density, 802.11 A
MID Channel, ISM
5785 MHz

Agilent 20:05:32 Feb 21, 2005

Mkr1 5.822 138 2 GHz
-5.57 dBm

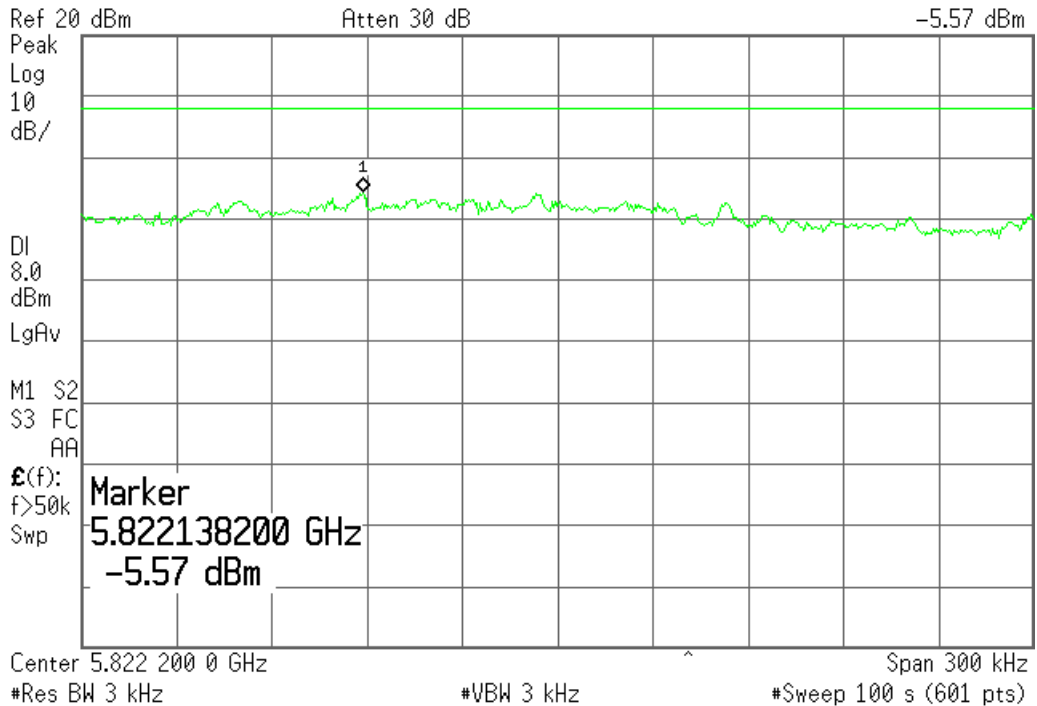

Power Spectral
Density, 802.11 A
HIGH Channel,
ISM 5825 MHz

5.725 & 5.85 GHz Band Edge

Specifications:

FCC Specification: Paragraph 15.247(4)(d)

IC Specification: RSS-210 .6.2.2(o)(b)

Procedure:

The test setup was configured as shown in the conducted test setup. The UUT was configured to continuously transmit random data packets. The span of the analyzer was centered on the 5.725 and 5.85 GHz band edge respectively.

The RBW & VBW were set to 1 MHz. The trace was allowed to stabilize then a Peak-search and a marker delta to the band edge was performed to determine that the carrier power at the band edge was at least 20 dB below the peak for the fundamental level.

Results:

Level at 5.725 GHz: -31.718 dBc Spec -20 dBc

Level at 5.85 GHz: -36.987 dBc Spec -20 dBc

5.85GHz Bandedge

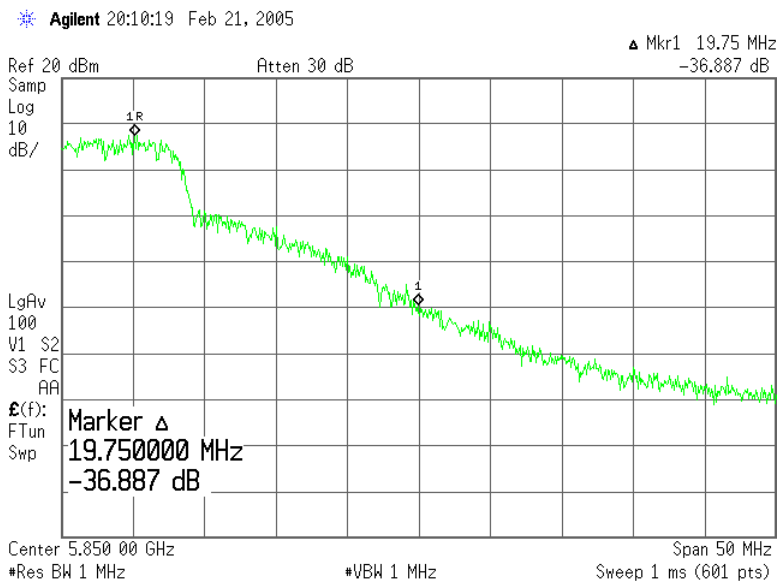

5.725GHz Bandedge

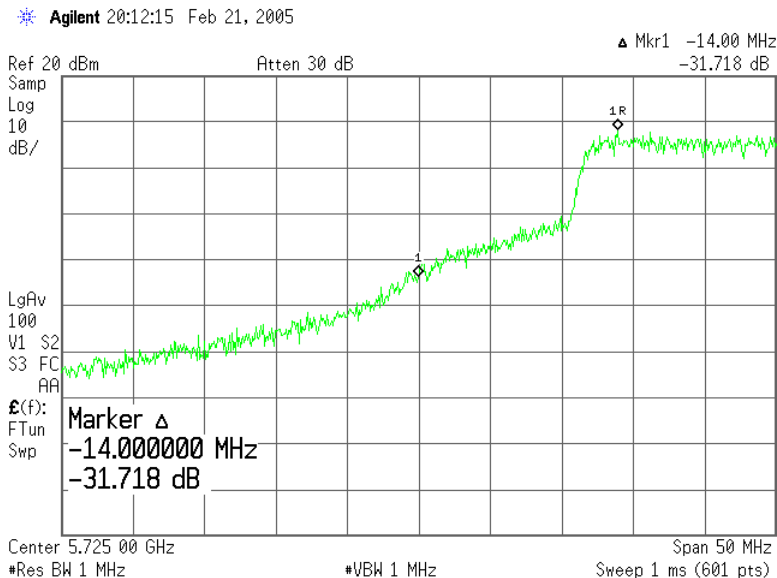

Radiated Emissions In Restricted Bands & Out Of Band Emissions

Specifications:

FCC Specification: Paragraph 15.247(c)

IC Specification: RSS-210 6.3(c) & RSS-210 .6.2.2(o)(e1)

Procedure:

This test was conducted inside a semi-anechoic chamber at Elliott Laboratories The unit was placed on a rotating wooden table 80cm above the ground plane. A Horn antenna was secured to a mast 3 meters away. The unit was tested at each of the Low, Mid and High channels. The UUT was running in the diagnostic mode and set to transmit at maximum power on each of the channels. The test equipment was configured as shown below.

Out of band emissions starting at 1GHz were measured. A notch or a high pass filter prior to the pre-amplifier was required to prevent the large signal level of the fundamental frequency from overloading the front end preamplifier and creating harmonics within the analyzer.

The EUT was rotated 360 degrees and the height of the antenna adjusted from 1 to 4 meters above the ground plane to determine the maximum level of the emission. The level of the harmonic emission was measured in two modes, "Peak" and "Average" .

The spectrum analyzer reading made by the test software and the appropriate correction factors (antenna factor, cable loss, pre-amplifier gain, HPF loss...) were then applied by Elliott Lab's Software to obtain a final corrected measurement.

This procedure was performed for all of the channels outlined in the Test Methods section of this report.

The band up to 40 GHz was examined, however there were no spurious emissions noted above approximately 18 GHz. The table below indicates the harmonics that fall within restricted bands.c

FUND	Harmonic (MHz)								
	2	3	4	5	6	7	8	9	10
2412	4824	7236	9648	12060	14472	16884	19296	21708	24120
2437	4874	7311	9748	12185	14622	17059	19496	21933	24370
2462	4924	7386	9848	12310	14772	17234	19696	22158	24620

Fund	2	3	4	5	6	7	8	9	10
5745	11490	17235	22980	28725	34470	40215	45960	51705	57450
5765	11530	17295	23060	28825	34590	40355	46120	51885	57650
5805	11610	17415	23220	29025	34830	40635	46440	52245	58050

15.205 Harmonic test tables

NOTE: RED indicates a harmonic that falls within a restricted band and is subject to 15.205. The harmonics in black are NOT in restricted bands and are subject to 15.209

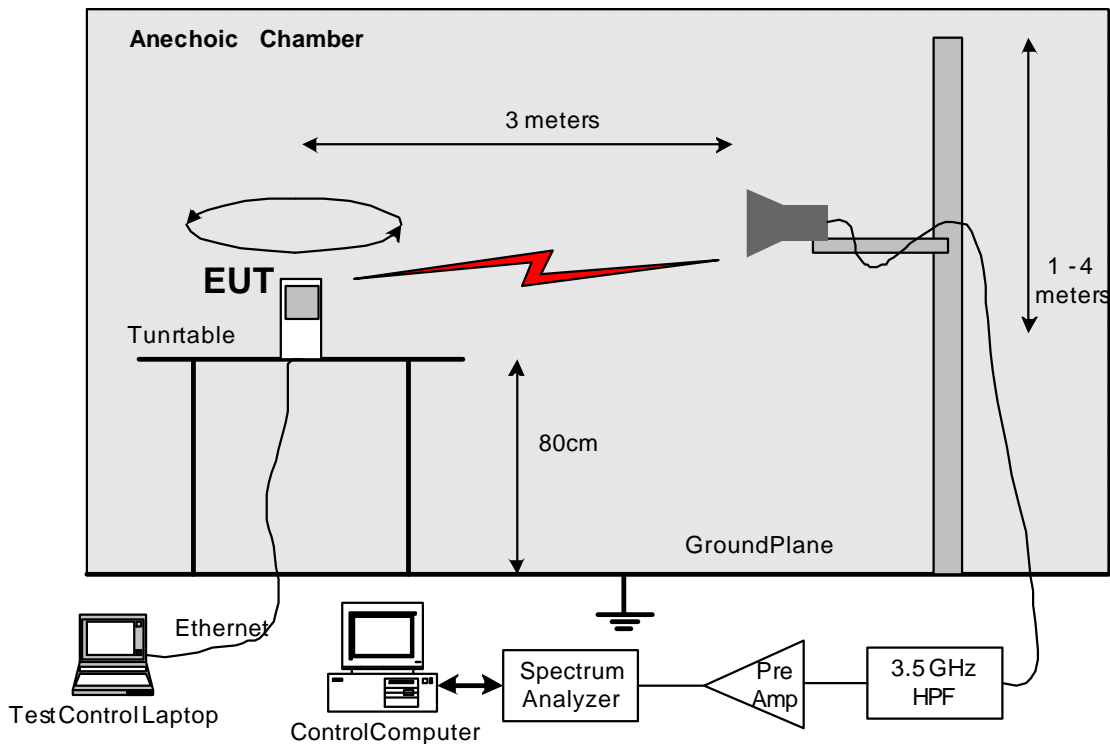

Radiated Emissions in Restricted Bands Test Setup

Support Equipment				
Description	Model number	FCC ID or SN	Manufacturer	Power Cable
Laptop, Generic	A20	DOC	IBM	Laptop PS
Test Software	Atheros Radio Test		Atheros	
48VDC AC adapter	Generic		Generic	Standard Twin lead DC wire

Test Conditions			
Temperature	22 C	Humidity:	43%
ATM pressure	1023 mBar	Grounding:	None
Tested By	Yaldo Noor Elliott Labs	Date of Test:	Feb 2005
Test Reference	FCC Part 15.205 IC Paragraph RSS210, 6.2.3 (c)		
Setup Method	ANSI C63.4		
Tested Range	1 GHz to 24 GHz		
Test Voltage	48 VDC		
Modifications	No modifications were made to the unit		

NOTES: For emissions in restricted bands, the limit of 15.209 was used. For all other emissions, the limit was set 20dB below the level of the fundamental.

No Emissions were detected above 18 GHz

Restricted Band Peak Measurements: Resolution and Video BW: 1 MHz

Restricted Band Average Measurements: Resolution BW: 1MHz and Video BW: 10 Hz.

All other measurements, RBW = 1MHz and VBW = 3MHz, video averaging on (100 samples).

Results:

The tables below presents a summary of the radiated emission in restricted bands for the low, middle and high channels for both 802.11 B , 802.11 G 802.11 A ISM modes of operation. Associated plots follow each table.

802.11 B 13 dBi Panel Antenna MP24103XFPTMSMA

Fund Freq	Frequency	Level	Pol	15.209 / 15.247		Detector	Azimuth	Height	Comments
MHz	MHz	dB μ V/m	v/h	Limit	Margin	Pk/OP/Avg	degrees	meters	
2412	2412.00	115.2	V	-	-	PK	180	1.5	CH#1 Fundamental
2412	1320.02	47.1	V	54.0	-6.9	AVG	70	1.0	Restricted
2412	1320.02	49.5	V	74.0	-24.5	PK	70	1.0	Restricted
2412	4824.05	43.4	V	54.0	-10.6	AVG	135	1.1	Restricted
2412	4824.05	47.5	V	74.0	-26.5	PK	135	1.1	Restricted
2412	7238.99	49.4	V	85.2	-35.8	PK	269	1.5	Non-restricted
2437	1320.03	47.3	V	54.0	-6.7	AVG	72	2.5	Restricted
2437	1320.03	49.4	V	74.0	-24.6	PK	72	2.5	Restricted
2437	4873.97	53.7	V	54.0	-0.3	AVG	223	1.3	Restricted
2437	4873.97	55.3	V	74.0	-18.7	PK	223	1.3	Restricted
2437	7306.96	47.0	V	54.0	-7.0	AVG	265	2.5	Restricted
2437	7306.96	51.7	V	74.0	-22.3	PK	265	2.5	Restricted
2462	7383.43	42.6	V	54.0	-11.4	AVG	80	1.5	Restricted
2462	7383.43	48.7	V	74.0	-25.3	PK	80	1.5	Restricted
2462	4924.02	47.8	V	54.0	-6.2	AVG	144	1.5	Restricted
2462	4924.02	50.6	V	74.0	-23.4	PK	144	1.5	Restricted
2462	1320.05	46.7	V	54.0	-7.3	AVG	78	1.0	Restricted
2462	1320.05	48.8	V	74.0	-25.2	PK	78	1.0	Restricted

Unit transmitting on 2412 MHz 802.11 B 13 dBi Panel Antenna MP24103XFPTMSMA

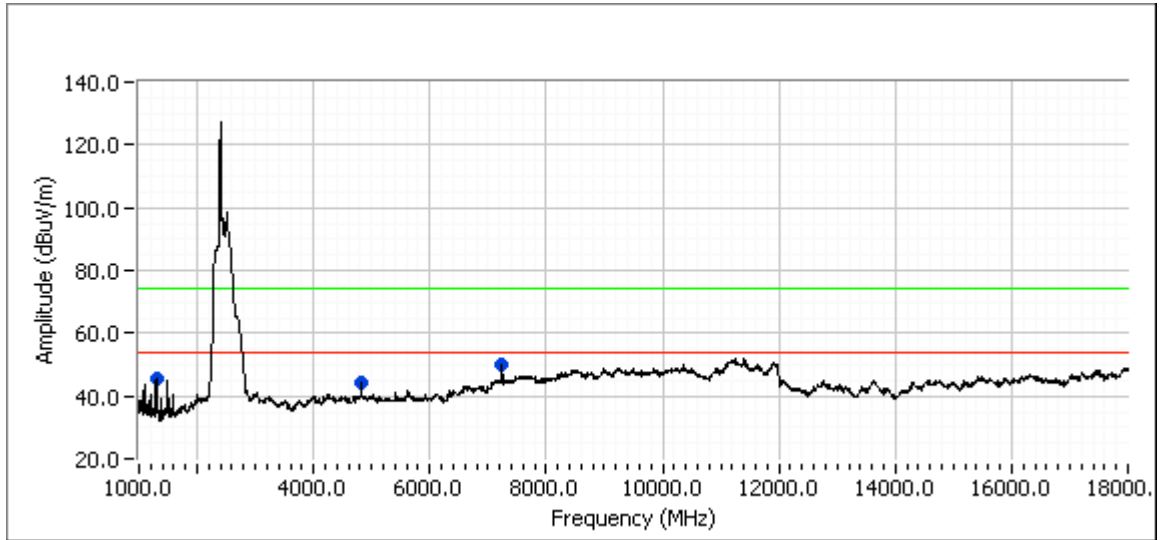

Unit transmitting on 2437 MHz 802.11 B 13 dBi Panel Antenna MP24103XFPTMSMA

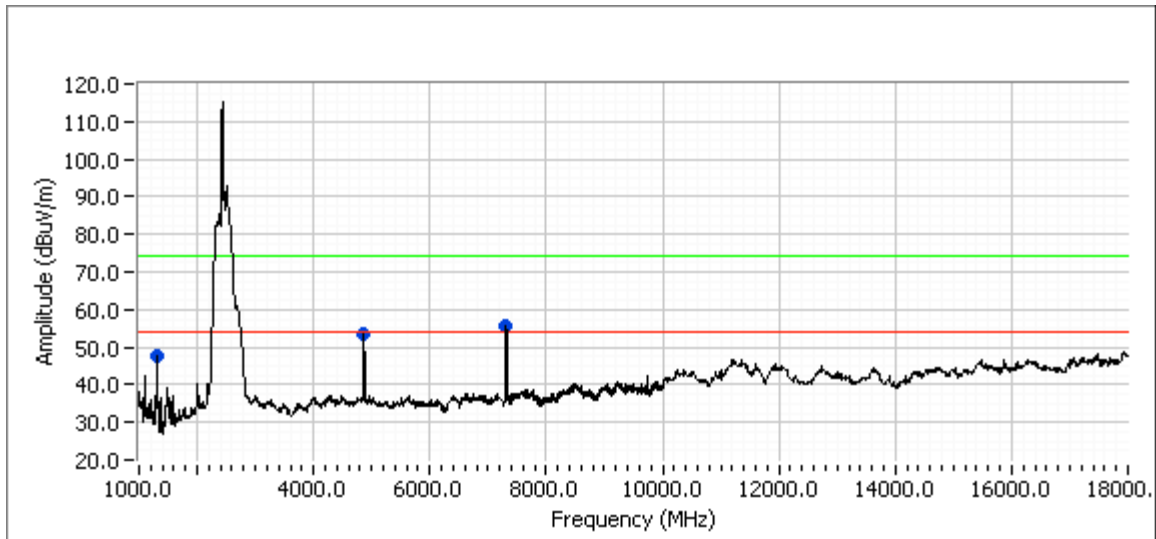

Unit transmitting on 2462 MHz 802.11 B 13 dBi Panel Antenna MP24103XFPTMSMA

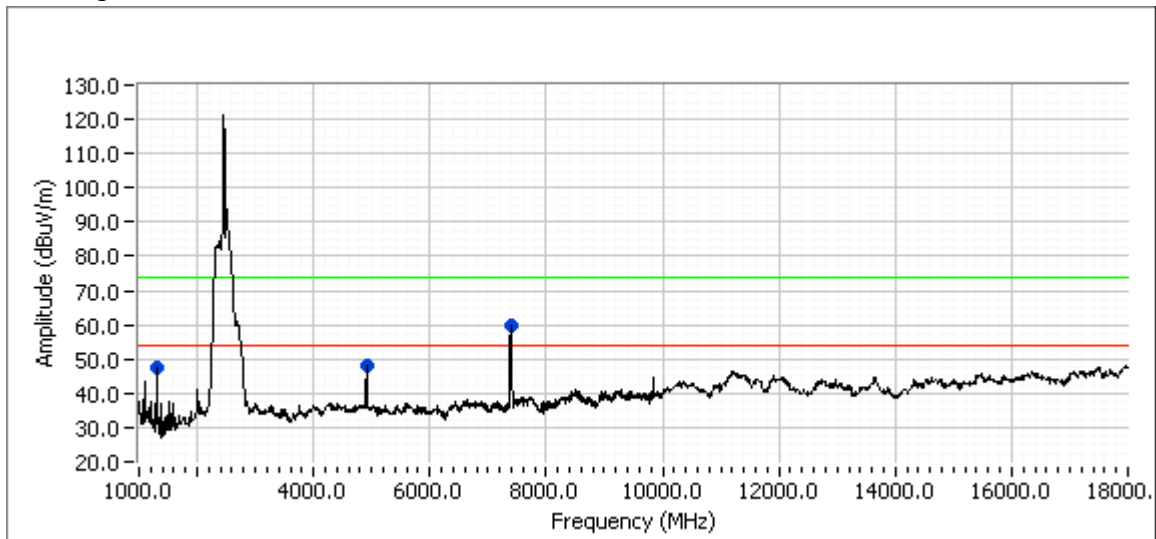

802.11 G 13 dBi Panel Antenna MP24103XFPTMSMA

Fund Freq	Frequency	Level	Pol	15.209 / 15.247		Detector	Azimuth	Height	Comments
				Limit	Margin				
2412	2412.00	117.0	V	-	-	PK	177	1.2	CH#1g Fundamental
2412	7234.35	71.1	V	87.0	-15.9	PK	271	1.5	Non-restricted
2412	1320.02	46.0	V	54.0	-8.0	AVG	77	1.0	Restricted
2412	1320.02	48.0	V	74.0	-26.0	PK	77	1.0	Restricted
2437	7311.74	50.8	V	54.0	-3.2	AVG	265	1.5	Restricted
2437	7311.74	72.5	V	74.0	-1.5	PK	265	1.5	Restricted
2437	4875.00	38.3	V	54.0	-15.7	AVG	229	1.0	Restricted
2437	4875.00	53.7	V	74.0	-20.3	PK	229	1.0	Restricted
2437	1319.96	44.1	V	54.0	-9.9	AVG	79	1.4	Restricted
2437	1319.96	46.6	V	74.0	-27.5	PK	79	1.4	Restricted
2462	7384.18	51.5	V	54.0	-2.5	AVG	265	1.5	Restricted
2462	7384.18	70.6	V	74.0	-3.4	PK	265	1.5	Restricted
2462	1319.98	45.1	V	54.0	-8.9	AVG	100	1.0	Restricted
2462	1319.98	48.6	V	54.0	-5.5	PK	100	1.0	Restricted

Unit transmitting on 2412 MHz 802.11 G 13 dBi Panel Antenna MP24103XFPTMSMA

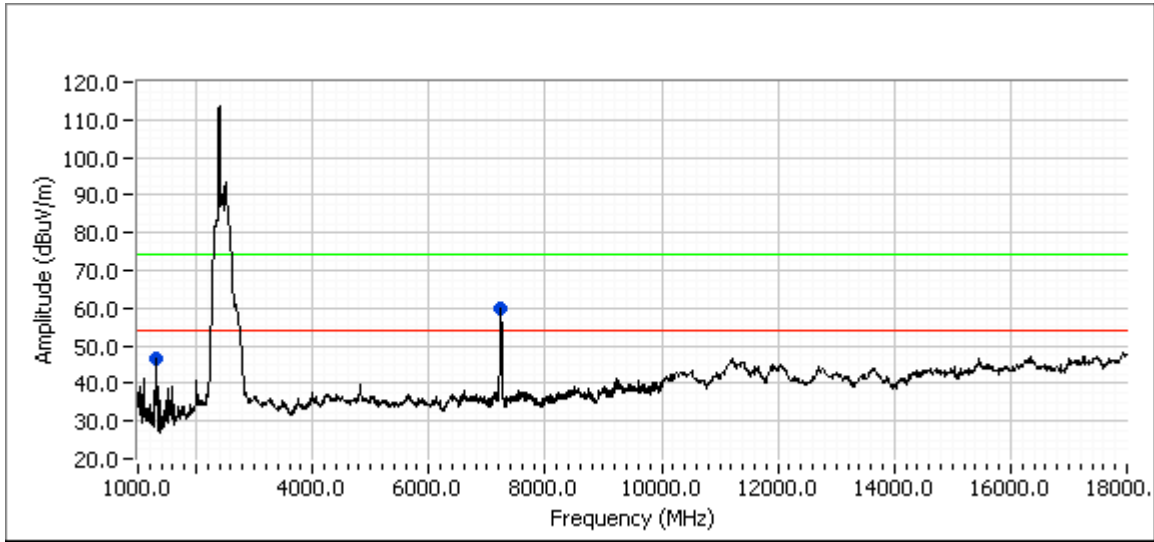

Unit transmitting on 2437 MHz 802.11 G 13 dBi Panel Antenna MP24103XFPTMSMA

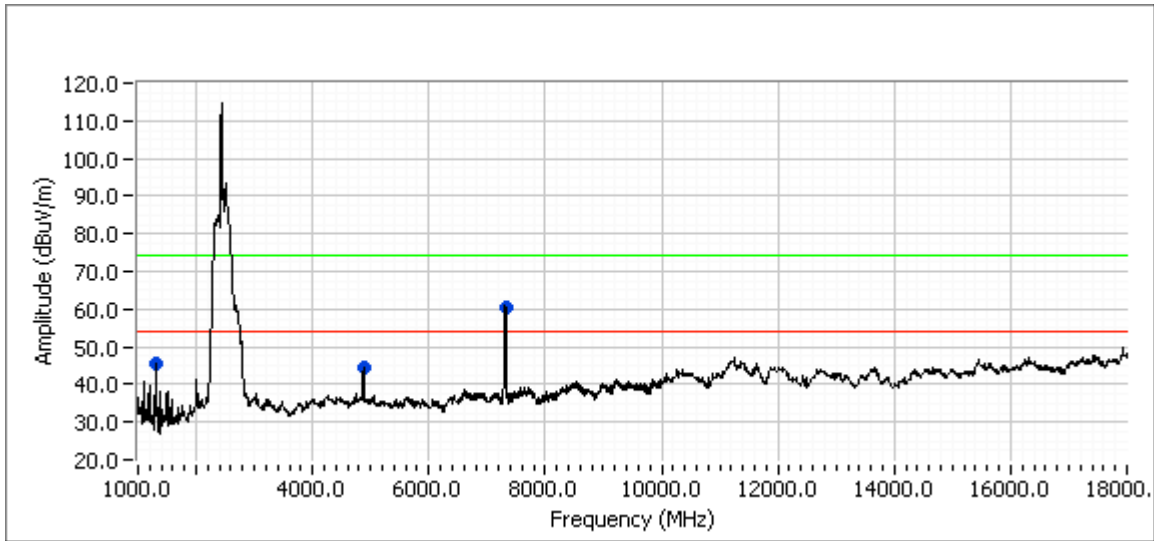

Unit transmitting on 2462 MHz 802.11 G 13 dBi Panel Antenna MP24103XFPTMSMA

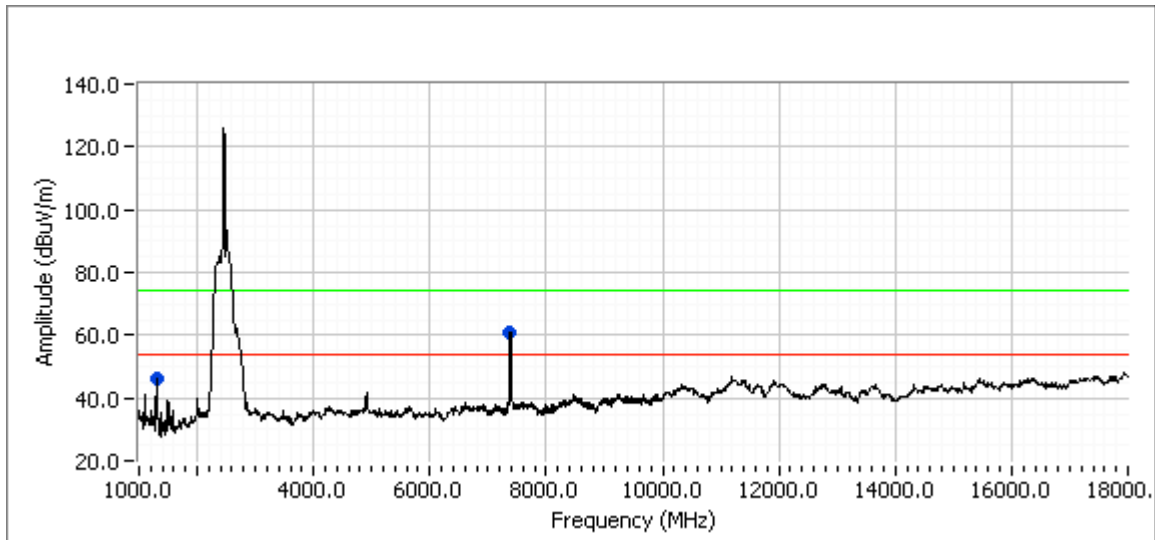

802.11 A 14 dBi Panel Antenna (ISM Band) S51514WP36RTN

The specified operating frequency range of this antenna is 5.15 - 5.85GHz. The emissions for the UNII band are contained within the UNII report as part of this permissive change application.

Fund Freq	Frequency	Level	Pol	15.209 / 15.247		Detector	Azimuth	Height	Comments
				Limit	Margin				
MHz	MHz	dBµV/m	v/h			PK/QP/Avg	degrees	meters	
5745	5745.00	115.4	V	-	-	PK	165	1.0	
5745	5745.00	95.3	H	-	-	PK	210	1.0	
5745	5209.997	67.3	V	85.4	-18.2	PK	162	1.0	Non-restricted
5745	5210.321	54.1	H	85.4	-31.3	PK	99	1.0	Non-restricted
5745	1328.532	44.9	V	54.0	-9.1	AVG	179	1.0	Restricted
5745	1328.532	60.0	V	74.0	-14.0	PK	179	1.0	Restricted
5745	1329.792	37.6	H	54.0	-16.4	AVG	322	1.0	Restricted
5745	1329.792	51.4	H	74.0	-22.6	PK	322	1.0	Restricted
5785	1320.424	43.3	V	54.0	-10.7	AVG	166	1.0	Restricted
5785	1320.424	51.0	V	74.0	-23.0	PK	166	1.0	Restricted
5785	1319.960	39.8	H	54.0	-14.2	AVG	200	1.0	Restricted
5785	1319.960	48.7	H	74.0	-25.3	PK	200	1.0	Restricted
5785	11537.65	36.9	V	54.0	-17.1	AVG	288	1.0	Restricted
5785	11537.65	48.1	V	74.0	-26.0	PK	288	1.0	Restricted
5785	11537.65	36.9	H	54.0	-17.1	AVG	305	1.0	Restricted
5785	11537.65	48.3	H	74.0	-25.7	PK	305	1.0	Restricted
5825	11608.72	36.6	V	54.0	-17.4	AVG	298	1.0	Restricted
5825	11608.72	47.5	V	74.0	-26.5	PK	298	1.0	Restricted
5825	11608.72	36.6	H	54.0	-17.4	AVG	255	1.0	Restricted
5825	11608.72	49.4	H	74.0	-24.6	PK	255	1.0	Restricted
5825	1320.01	42.2	V	54.0	-11.8	AVG	178	1.0	Restricted
5825	1320.01	51.2	V	74.0	-22.8	PK	178	1.0	Restricted
5825	1320.10	41.6	H	54.0	-12.4	AVG	201	1.0	Restricted
5825	1320.10	49.2	H	74.0	-24.8	PK	201	1.0	Restricted

Unit transmitting on 5745 MHz 802.11 A 14 dBi Panel Antenna S51514WP36RTN

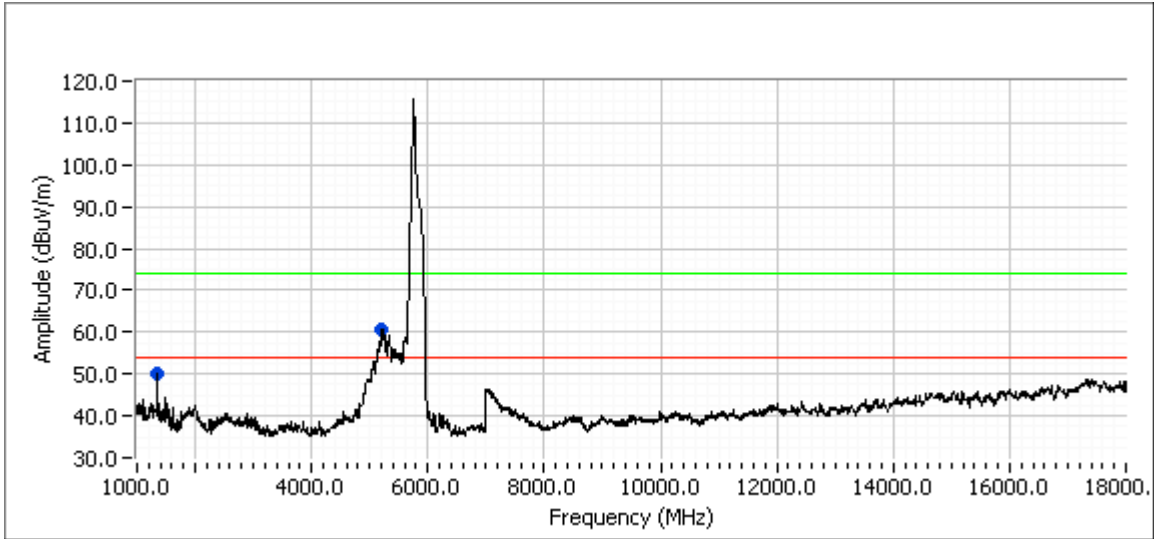

Unit transmitting on 5785 MHz 802.11 A 14 dBi Panel Antenna S51514WP36RTN

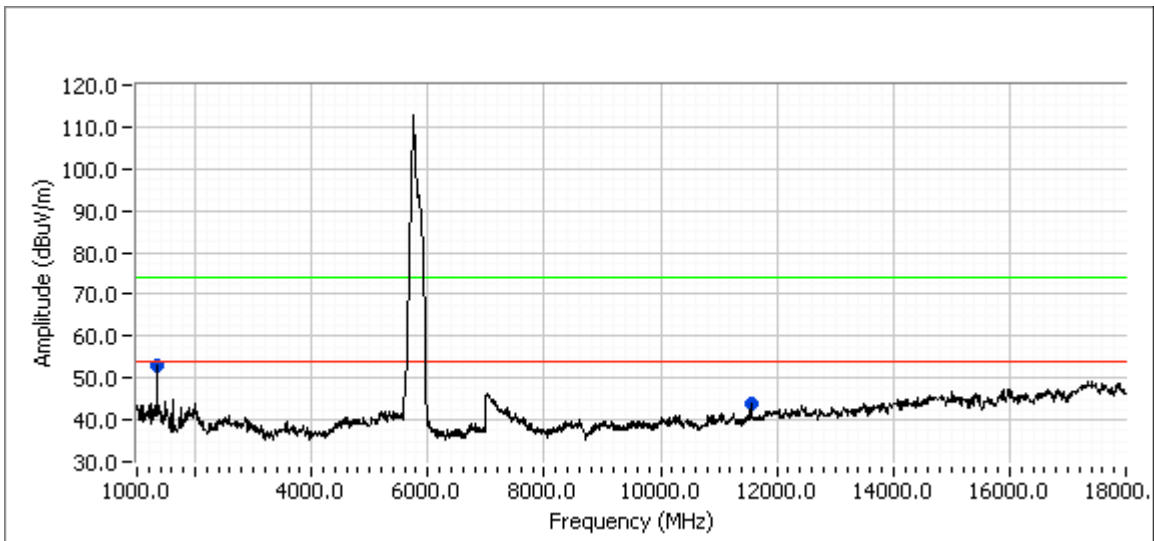

Unit transmitting on 5825 MHz 802.11 A 14 dBi Panel Antenna S51514WP36RTN

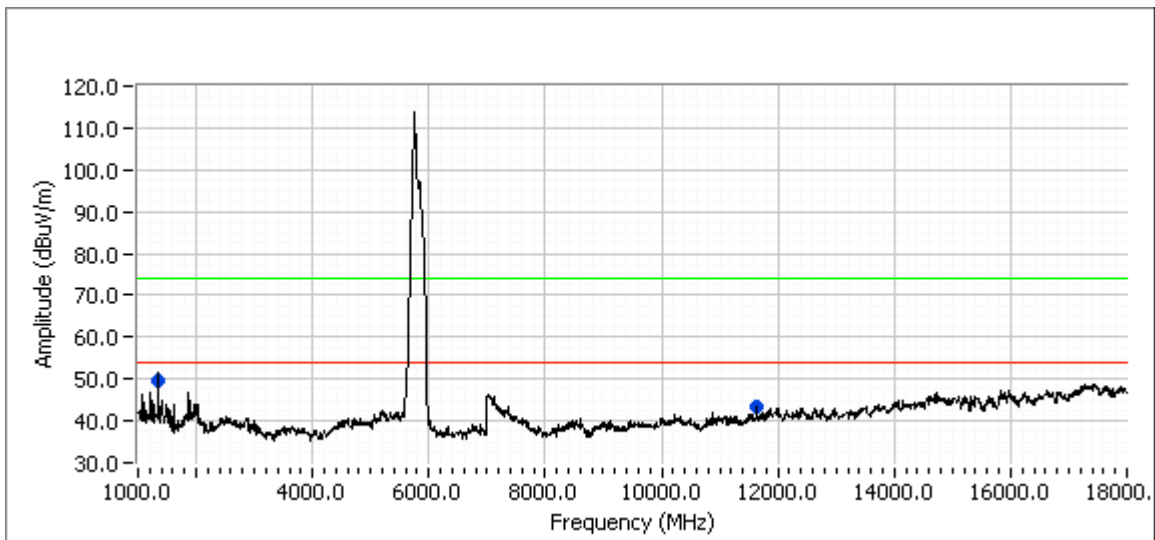

802.11 B 8 dBi Omni Antenna MFB24008NM

Fund Freq	Frequency	Level	Pol	15.209 / 15.247		Detector	Azimuth	Height	Comments
MHz	MHz	dB μ V/m	v/h	Limit	Margin	Pk/QP/Avg	degrees	meters	
2412	7235.88	44.9	H	54.0	-9.1	AVG	199	1.5	Restricted
2412	7235.88	53.7	H	54.0	-0.3	PK	199	1.5	Restricted
2437	2356.02	47.8	V	54.0	-6.2	AVG	273	1.0	Restricted
2437	2356.02	58.3	V	74.0	-15.7	PK	273	1.0	Restricted
2437	7313.32	49.4	V	54.0	-4.7	AVG	41	1.0	Restricted
2437	7313.32	58.1	V	74.0	-15.9	PK	41	1.0	Restricted
2462	2360.19	48.0	V	54.0	-6.0	AVG	295	1.2	Restricted
2462	2360.19	61.8	V	74.0	-12.2	PK	295	1.2	Restricted
2462	7400.94	40.8	H	54.0	-13.2	AVG	265	1.5	Restricted
2462	7400.94	49.8	H	74.0	-24.2	PK	265	1.5	Restricted

Unit transmitting on 2412 MHz 802.11 B 8 dBi Omni Antenna MFB24008NM

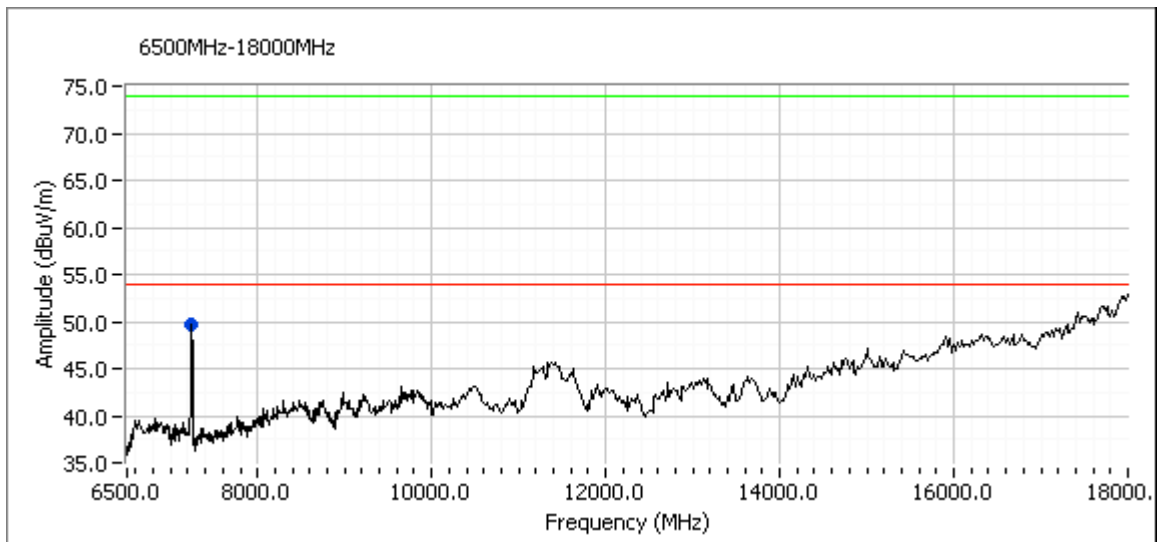
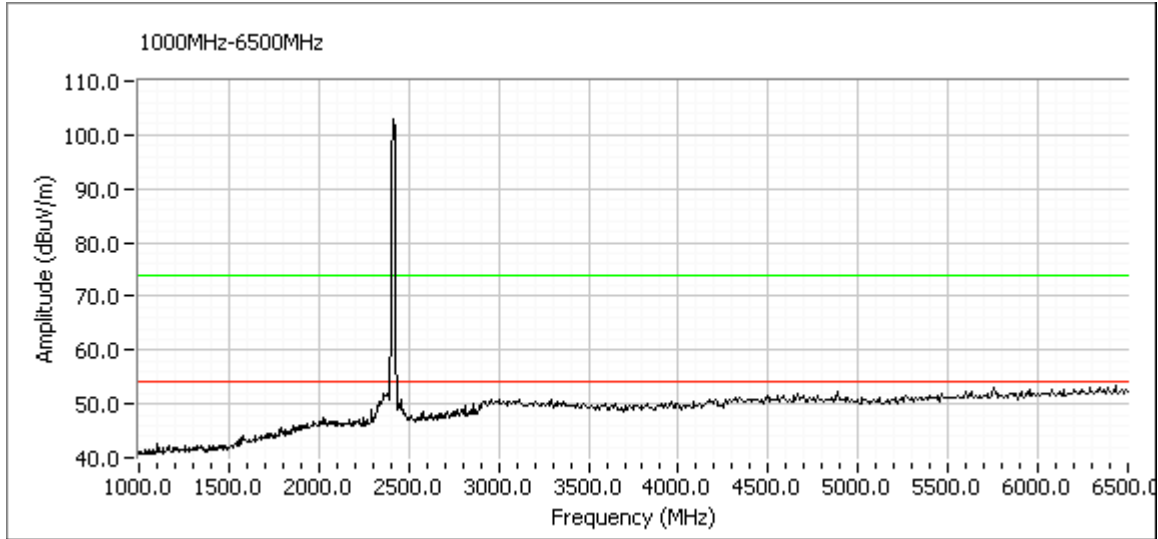

Unit transmitting on 2437 MHz 802.11 B 8 dBi Omni Antenna MFB24008NM

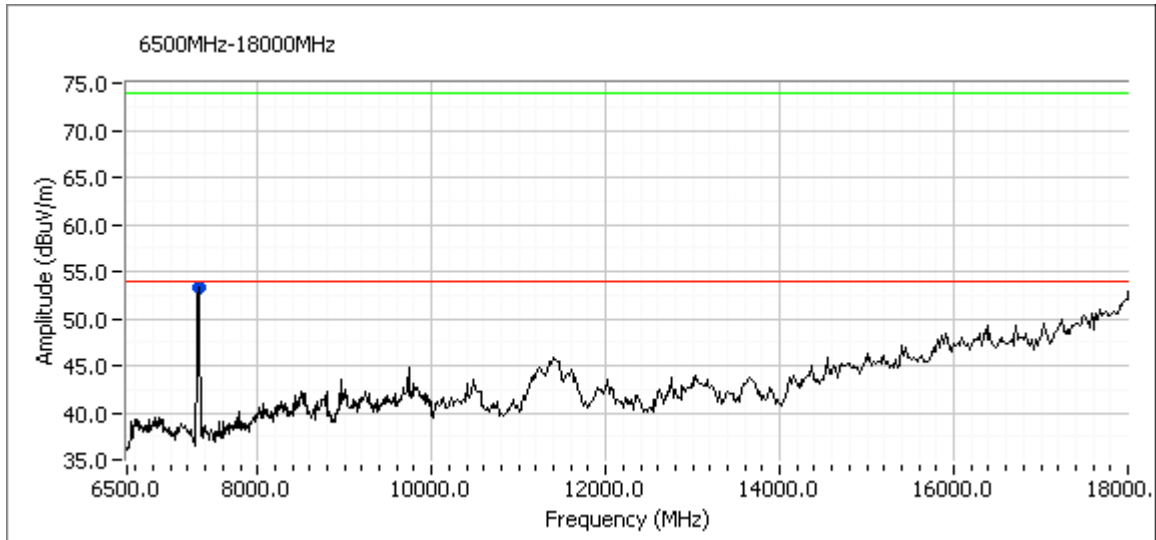
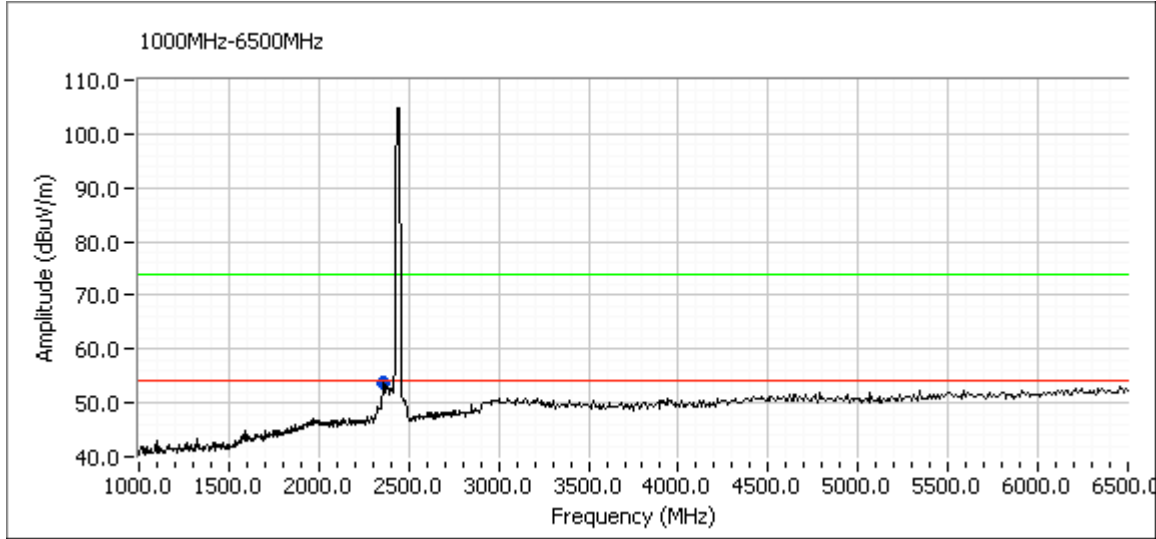

Unit transmitting on 2462 MHz 802.11 B 8 dBi Omni Antenna MFB24008NM

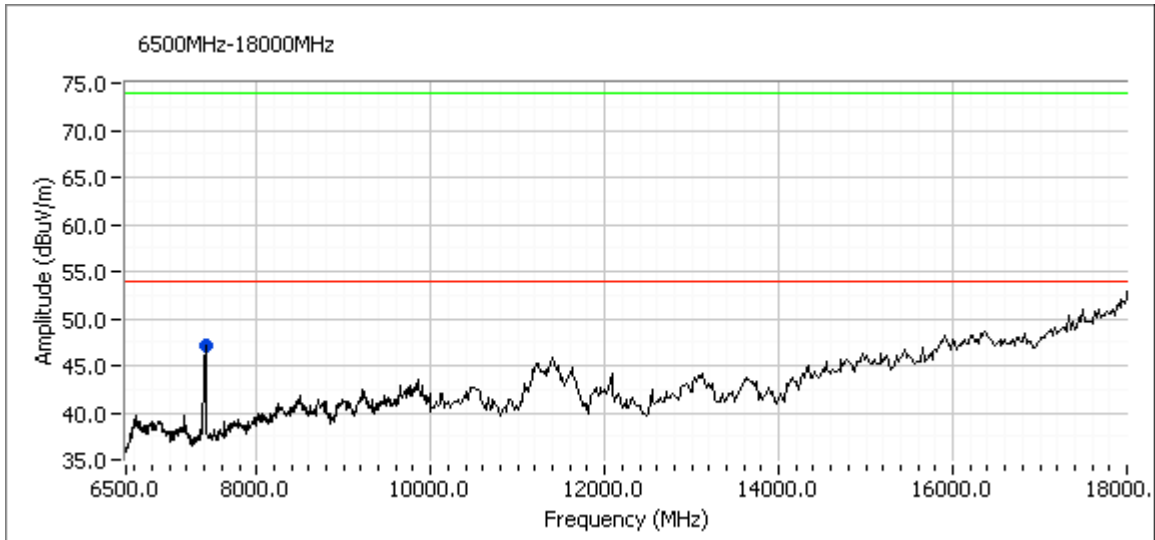
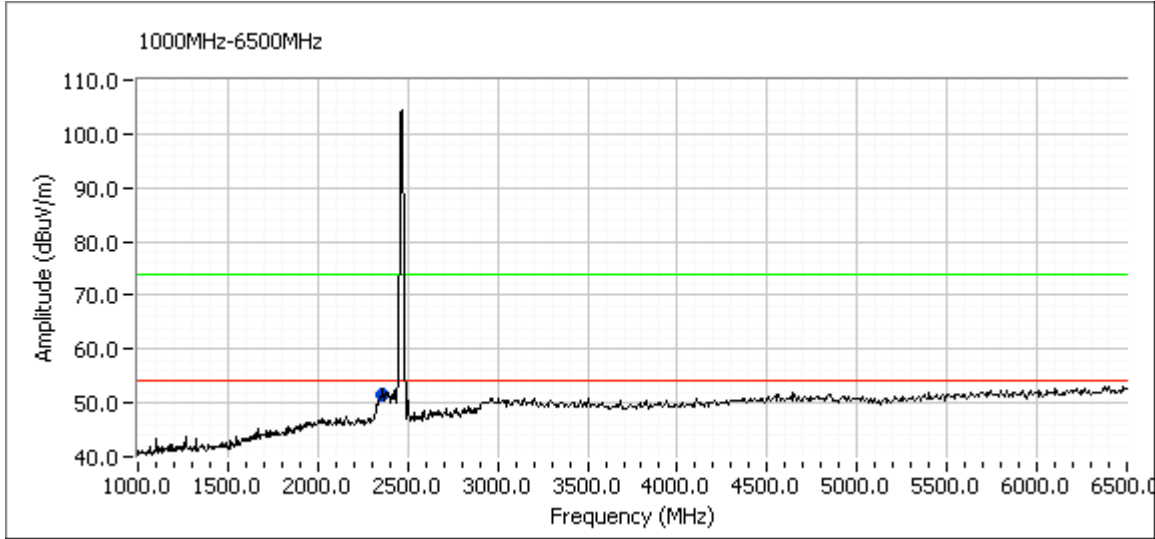

802.11 G 8 dBi Omni Antenna MFB24008NM

Fund Freq	Frequency	Level	Pol	15.209 / 15.247		Detector	Azimuth	Height	Comments
				Limit	Margin				
2412	4386.82	41.9	V	54.0	-12.1	AVG	188	1.0	Restricted
2412	4386.82	54.0	V	74.0	-20.0	PK	188	1.0	Restricted
2412	4128.69	40.9	H	54.0	-13.1	AVG	360	1.0	Restricted
2412	4128.69	52.7	H	74.0	-21.3	PK	360	1.0	Restricted
2412	7235.56	52.6	H	54.0	-1.5	AVG	199	1.5	Restricted
2412	7235.56	70.1	H	74.0	-3.9	PK	199	1.5	Restricted
2437	2358.98	45.7	V	54.0	-8.3	AVG	264	1.0	Restricted
2437	2358.98	56.2	V	74.0	-17.8	PK	264	1.0	Restricted
2437	7308.91	51.1	H	54.0	-2.9	AVG	249	1.0	Restricted
2437	7308.91	68.2	H	74.0	-5.8	PK	249	1.0	Restricted
2462	2462.00	115.6	V	-	-	PK	105	1.0	Ch#11g Fundamental
2462	2359.81	45.6	V	54.0	-8.4	AVG	251	1.0	Restricted
2462	2359.81	56.7	V	74.0	-17.3	PK	251	1.0	Restricted
2462	5497.89	53.9	V	85.6	-31.7	PK	225	2.5	Non-restricted
2462	7382.45	39.7	H	54.0	-14.3	AVG	212	1.5	Restricted
2462	7382.45	49.1	H	54.0	-4.9	PK	212	1.5	Restricted

Unit transmitting on 2412 MHz 802.11 G 8 dBi Omni Antenna MFB24008NM

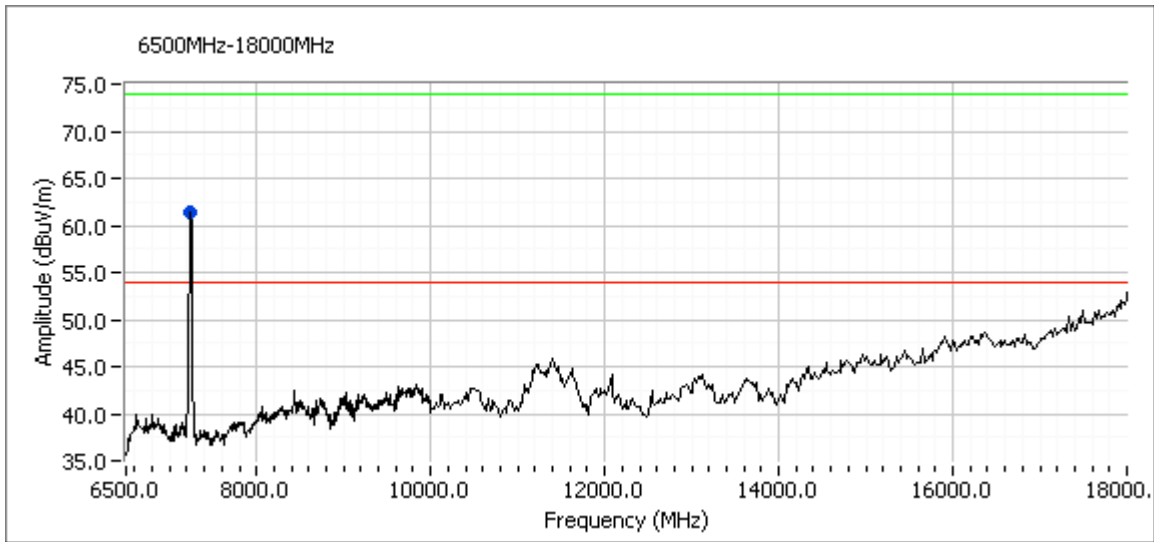
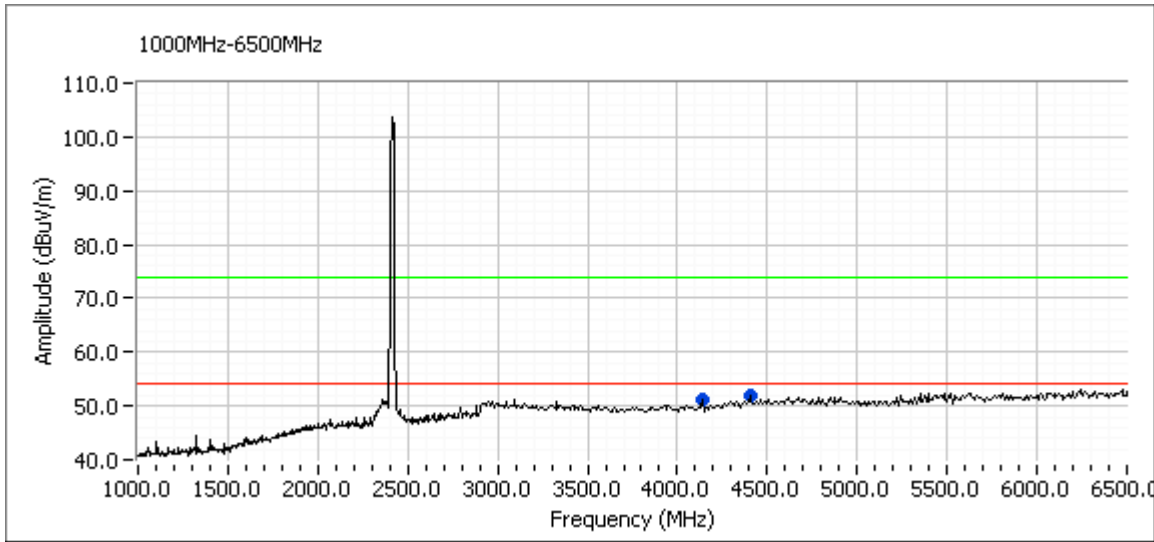

Unit transmitting on 2437 MHz 802.11 G 8 dBi Omni Antenna MFB24008NM

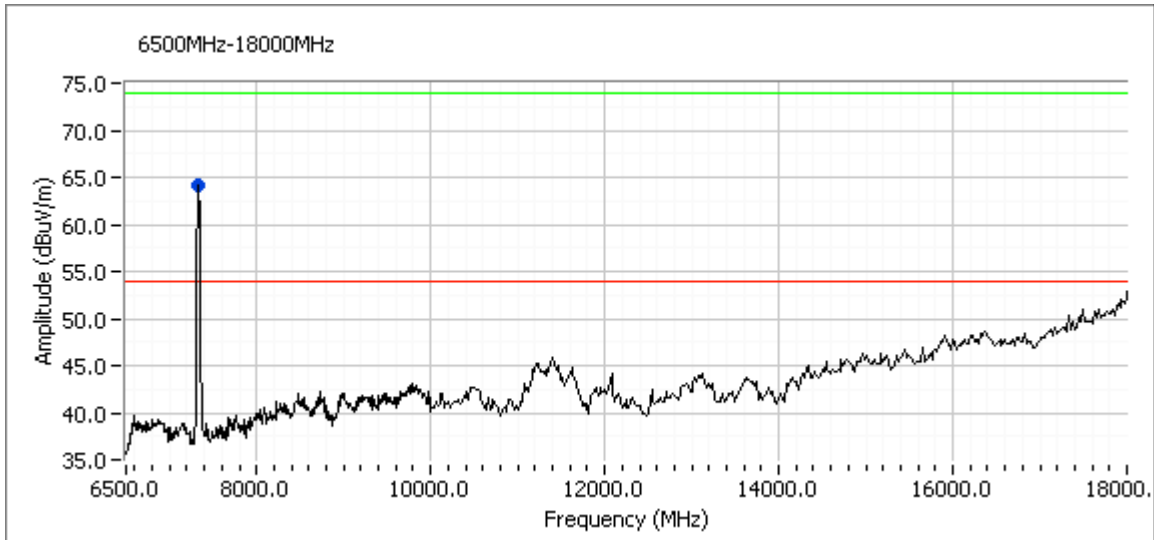
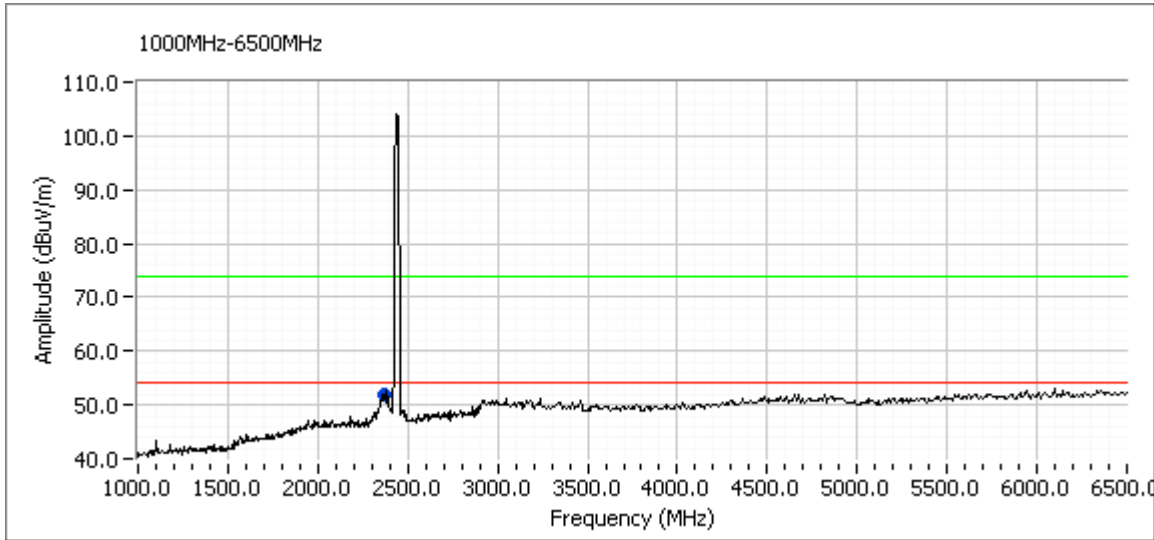

Unit transmitting on 2462 MHz 802.11 G 8 dBi Omni Antenna MFB24008NM

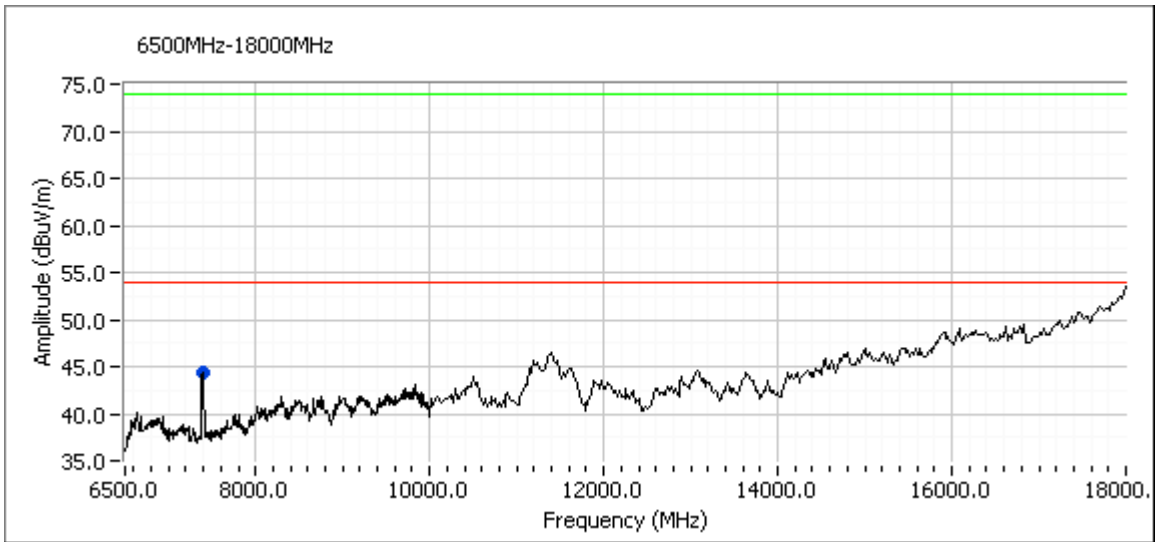
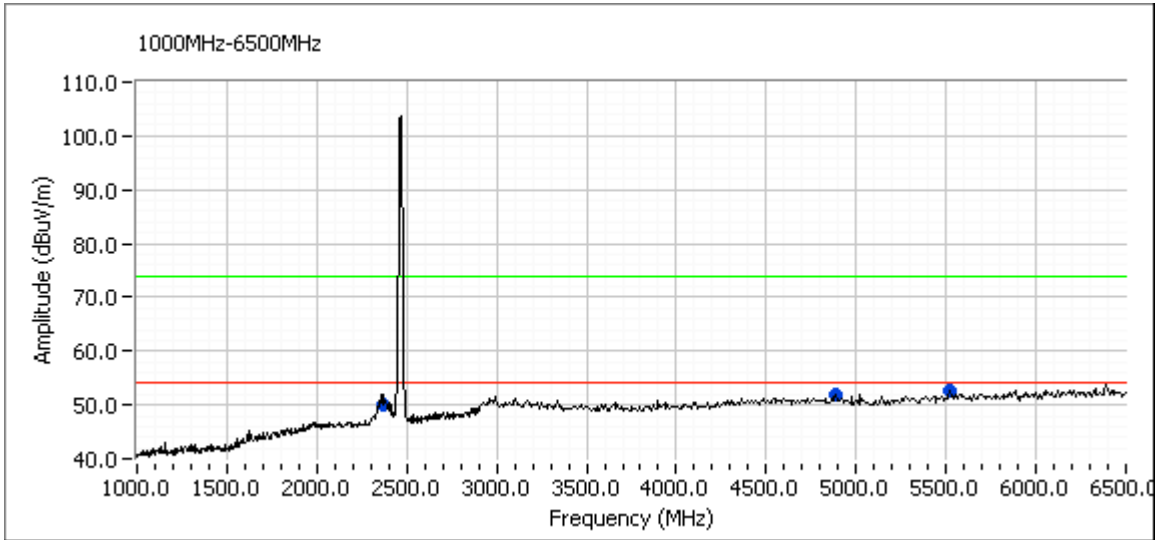

802.11 A 9 dBi Omni Antenna MFB58009

The specified operating frequency range of this antenna is 5.725 - 5.85GHz. However, on occasion this antenna may be used in the 5.15 - 5.35 GHz UNII band. Therefore it was tested in the UNII band as well. The emissions for the UNII band are contained within the UNII report as part of this permissive change application.

Fund Freq	Frequency	Level	Pol	15.209 / 15.247		Detector	Azimuth	Height	Comments
				Limit	Margin				
MHz	MHz	dBμV/m	v/h			Pk/QP/Avg	degrees	meters	
5745	5745.00	116.2	V	-	-	PK	183	1.0	
5745	1094.49	46.7	V	54.0	-7.3	AVG	183	1.0	Restricted
5745	1094.49	59.4	V	74.0	-14.6	PK	183	1.0	Restricted
5745	5743.97	56.4	V	86.2	-29.8	PK	183	1.1	Non-restricted
5745	1320.04	53.3	V	54.0	-0.7	AVG	255	1.0	Restricted
5745	1320.04	55.4	V	74.0	-18.6	PK	255	1.0	Restricted
5785	5785.00	113.3	V	-	-	PK	166	1.0	
5785	1096.02	49.6	V	54.0	-4.4	AVG	163	1.0	Restricted
5785	1096.02	64.4	V	74.0	-9.6	PK	163	1.0	Restricted
5785	5778.89	52.2	V	83.3	-1.8	PK	186	1.0	Non-restricted
5785	1320.02	53.4	V	54.0	-0.6	AVG	256	1.0	Restricted
5785	1320.02	55.5	V	74.0	-18.5	PK	256	1.0	Restricted
5785	14038.62	55.0	V	83.3	-1.8	PK	299	2.0	Non-restricted
5825	5825.00	109.5	V	-	-	PK	159	1.0	
5825	1095.30	46.2	V	54.0	-7.8	AVG	212	1.0	Restricted
5825	1095.30	60.9	V	74.0	-13.1	PK	212	1.0	Restricted
5825	5831.45	64.8	V	79.5	-14.7	PK	170	1.0	Non-restricted
5825	1318.89	34.6	V	54.0	-19.4	AVG	255	1.0	Restricted
5825	1318.89	46.3	V	74.0	-27.7	PK	255	1.0	Restricted

Unit transmitting on 5745 MHz 802.11 A 9 dBi Omni Antenna MFB58009

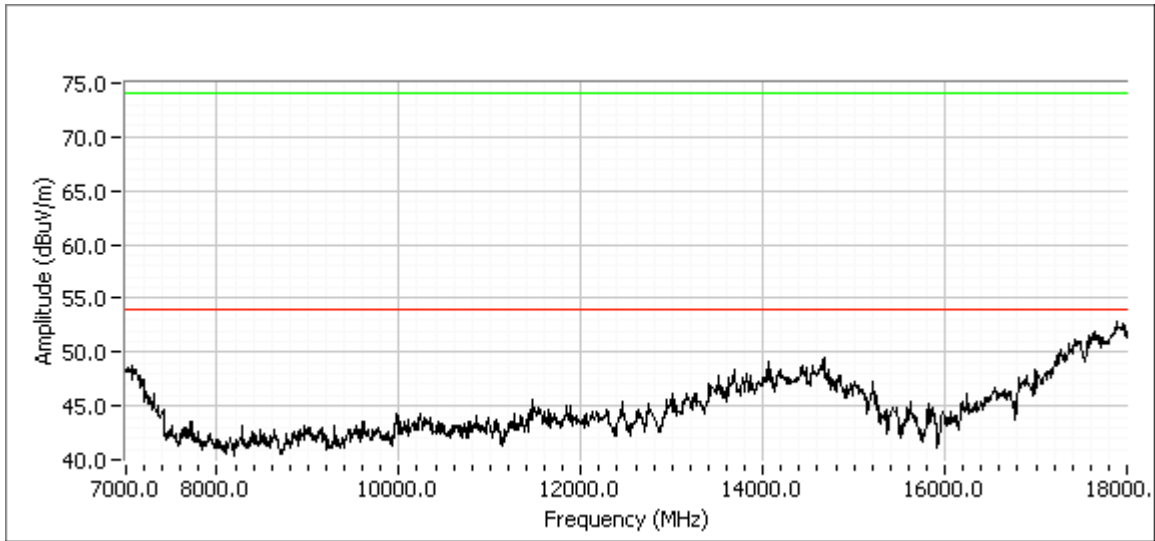
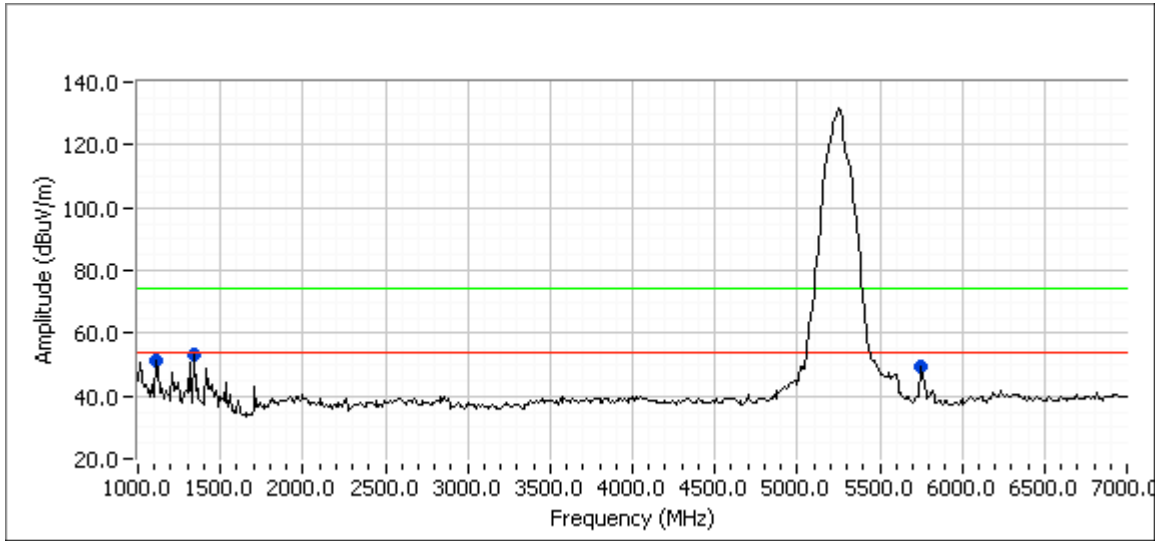

Unit transmitting on 5785 MHz 802.11 A 9 dBi Omni Antenna MFB58009

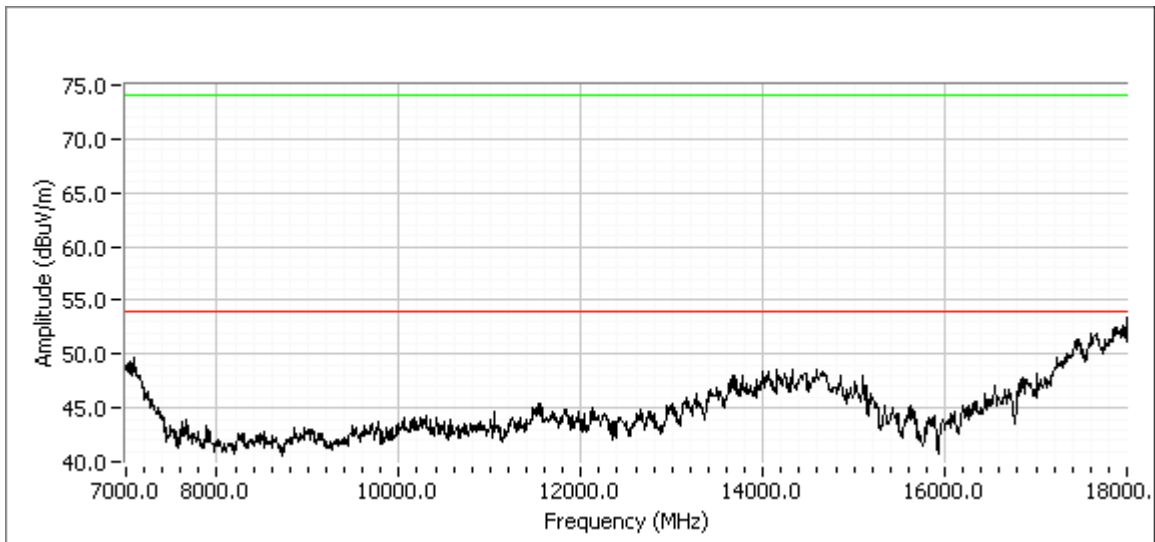
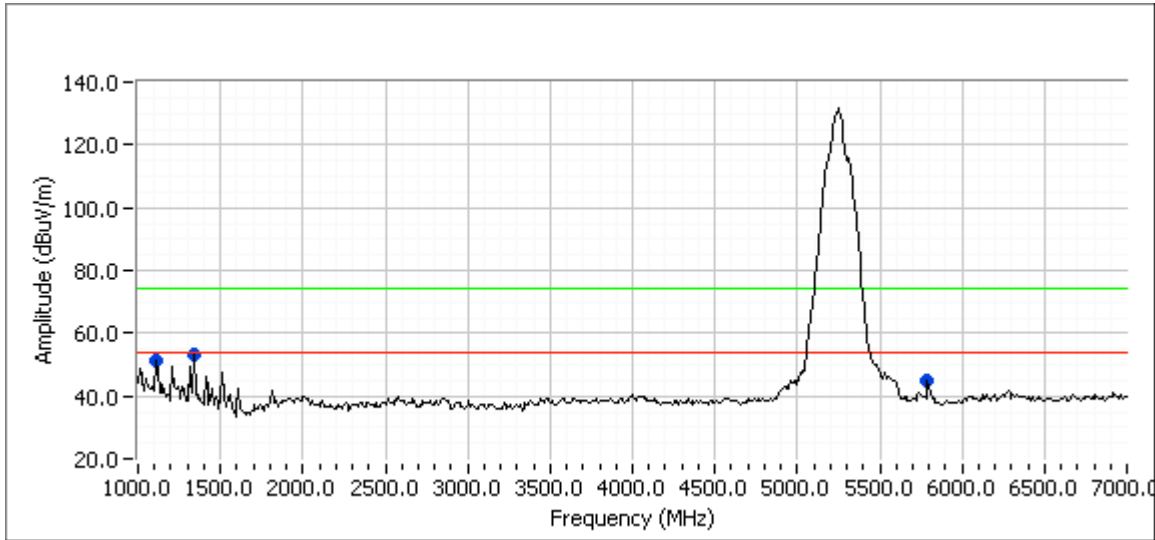

Unit transmitting on 5825 MHz 802.11 A 9 dBi Omni Antenna MFB58009

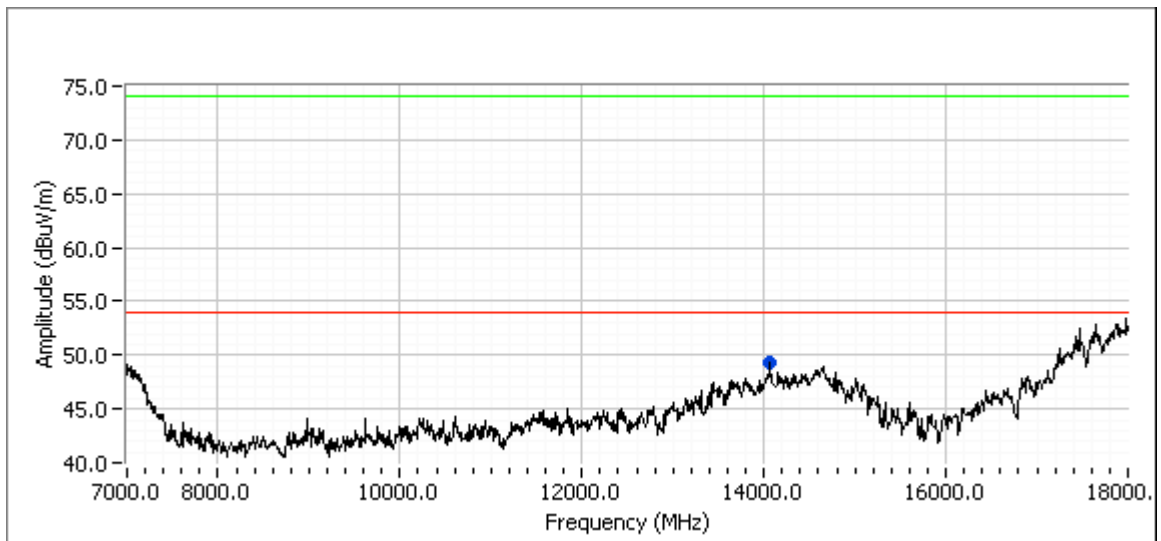
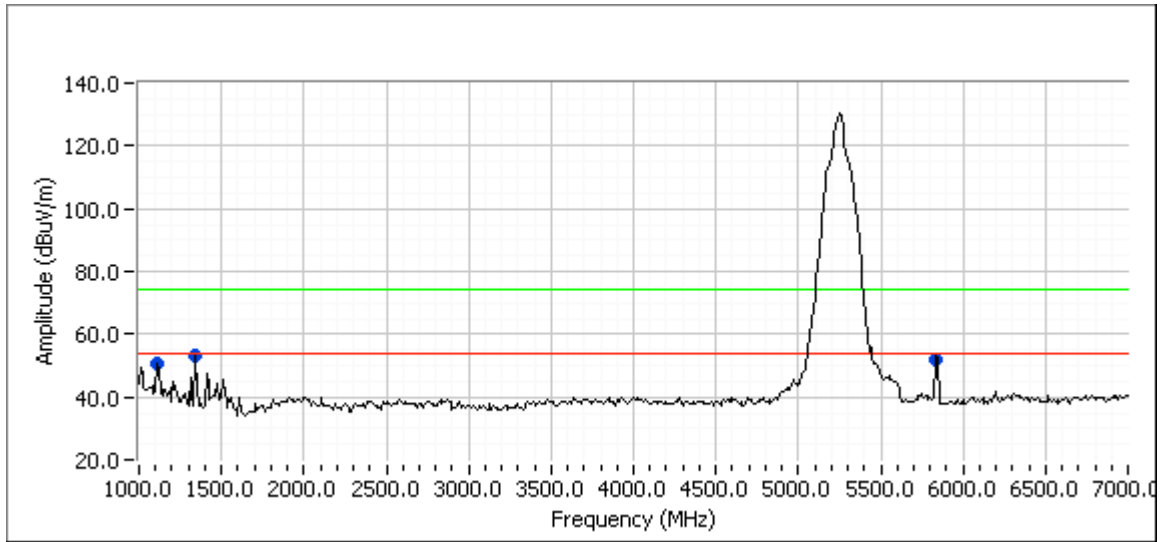

802.11 A 6 dBi Omni Antenna (ISM Band) S5153WPBX36RTN

The specified operating frequency range of this antenna is 5.15 - 5.85GHz. The emissions for the UNII band are contained within the UNII report as part of this permissive change application.

Fund Freq	Frequency	Level	Pol	15.209 / 15.247		Detector	Azimuth	Height	Comments
				Limit	Margin				
MHz	MHz	dBmV/m	v/h			Pk/QP/Avg	degrees	meters	
5745	5745.00	112.4	V	-	-	PK	232	1.0	
5745	1319.958	53.1	V	54.0	-0.9	AVG	186	1.0	Restricted
5745	1319.958	55.8	V	74.0	-18.2	PK	186	1.0	Restricted
5745	5189.931	64.3	V	82.4	-18.1	PK	327	1.0	Non-restricted
5745	5356.610	50.7	V	54.0	-3.3	AVG	333	1.5	Restricted
5745	5356.610	62.7	V	74.0	-11.3	PK	333	1.5	Restricted
5785	5312.680	53.1	V	54.0	-0.9	AVG	106	1.0	Restricted
5785	5312.680	63.6	V	74.0	-10.4	PK	106	1.0	Restricted
5785	5000.648	43.9	V	54.0	-10.1	AVG	155	1.0	Restricted
5785	5000.648	57.4	V	74.0	-16.6	PK	155	1.0	Restricted
5785	1335.870	33.0	V	54.0	-21.0	AVG	190	1.0	Restricted
5785	1335.870	44.9	V	74.0	-29.1	PK	190	1.0	Restricted
5825	5350.197	53.0	V	54.0	-1.0	AVG	143	1.0	Restricted
5825	5350.197	65.8	V	74.0	-8.2	PK	143	1.0	Restricted
5825	1319.918	51.6	V	54.0	-2.4	AVG	192	1.0	Restricted
5825	1319.918	54.3	V	74.0	-19.8	PK	192	1.0	Restricted
5825	5108.726	47.4	V	54.0	-6.6	AVG	319	1.0	Restricted
5825	5108.726	57.9	V	74.0	-16.1	PK	319	1.0	Restricted

Unit transmitting on 5745 MHz 802.11 A 6 dBi Omni Antenna S5153WPBX36RTN

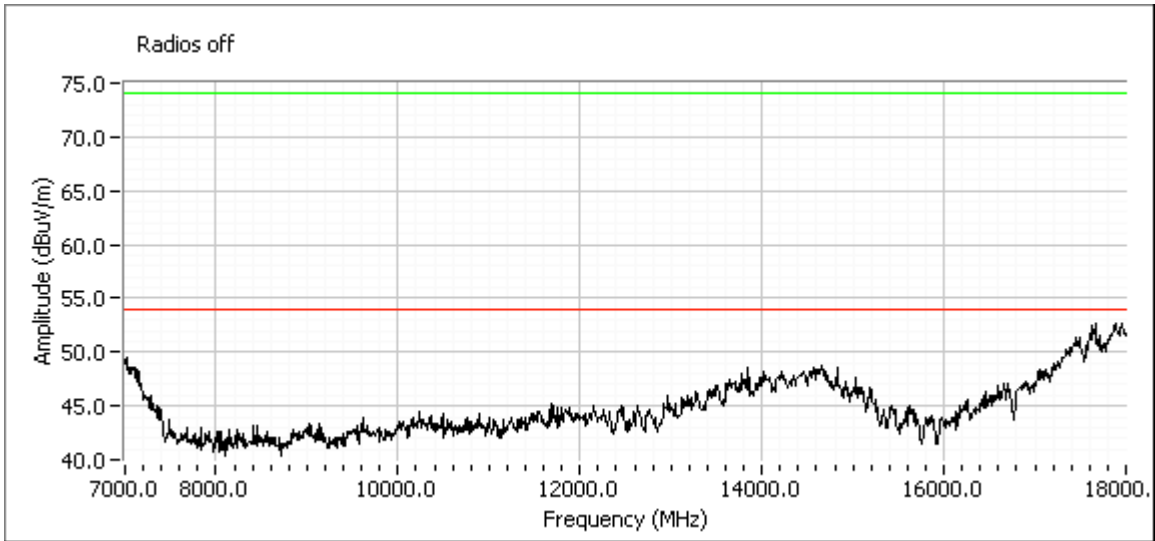
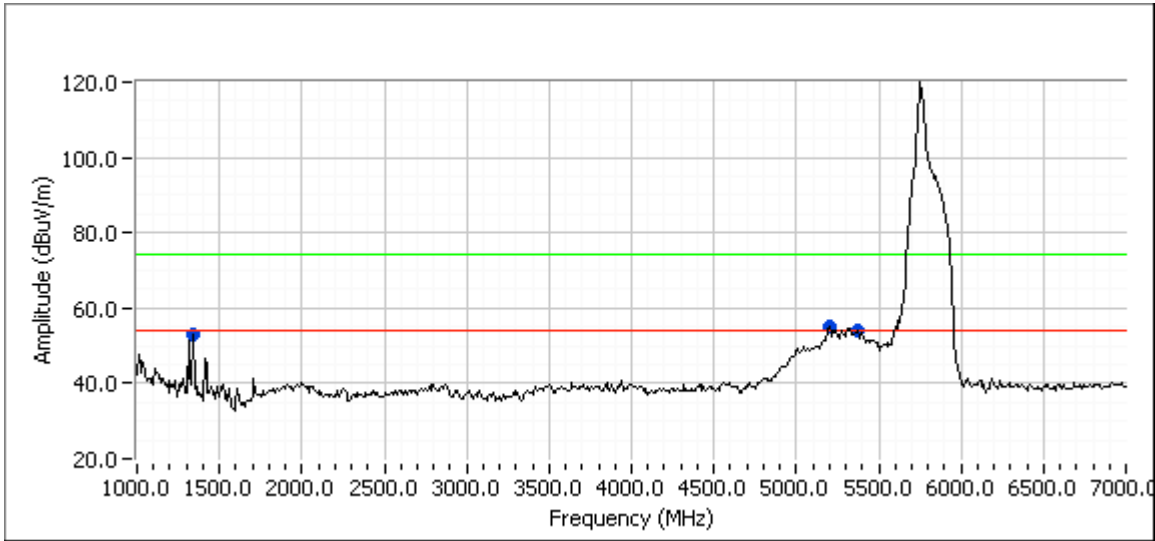

Unit transmitting on 5745 MHz 802.11 A 6 dBi Omni Antenna S5153WPBX36RTN

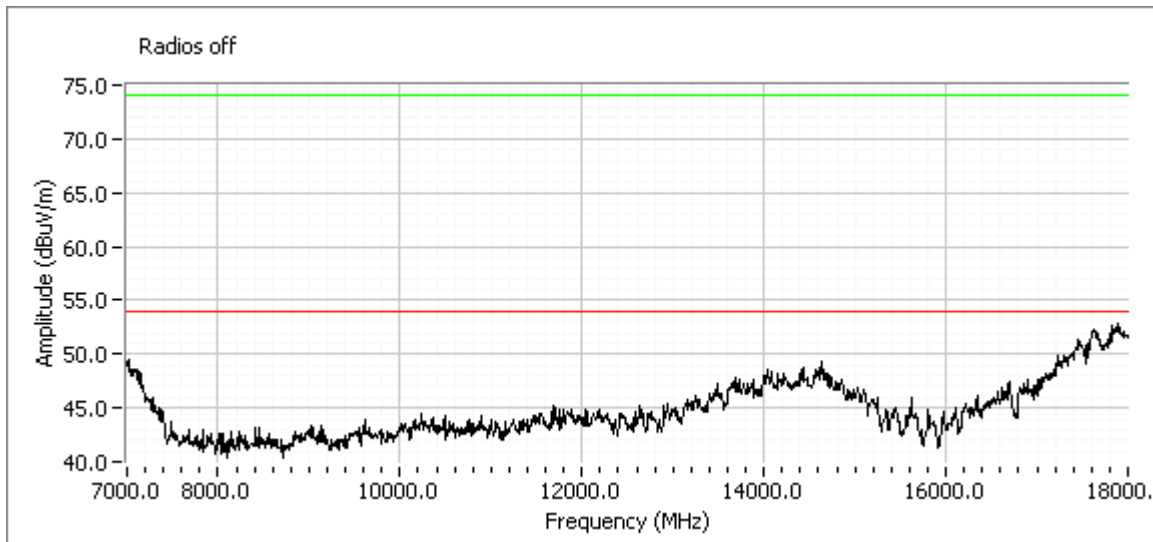

Unit transmitting on 5825 MHz 802.11 A 6 dBi Omni Antenna S5153WPBX36RTN

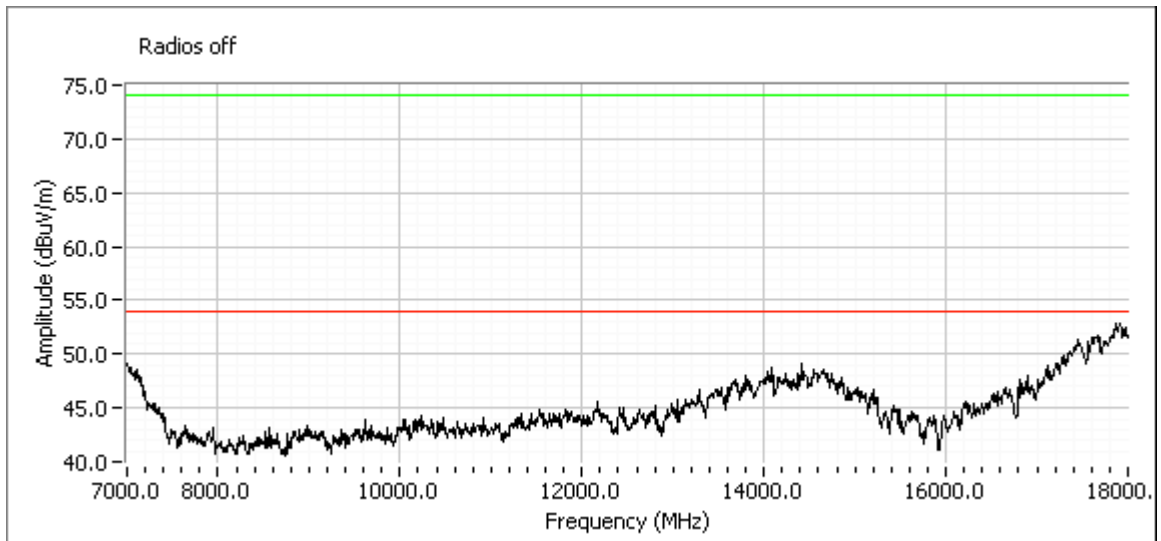
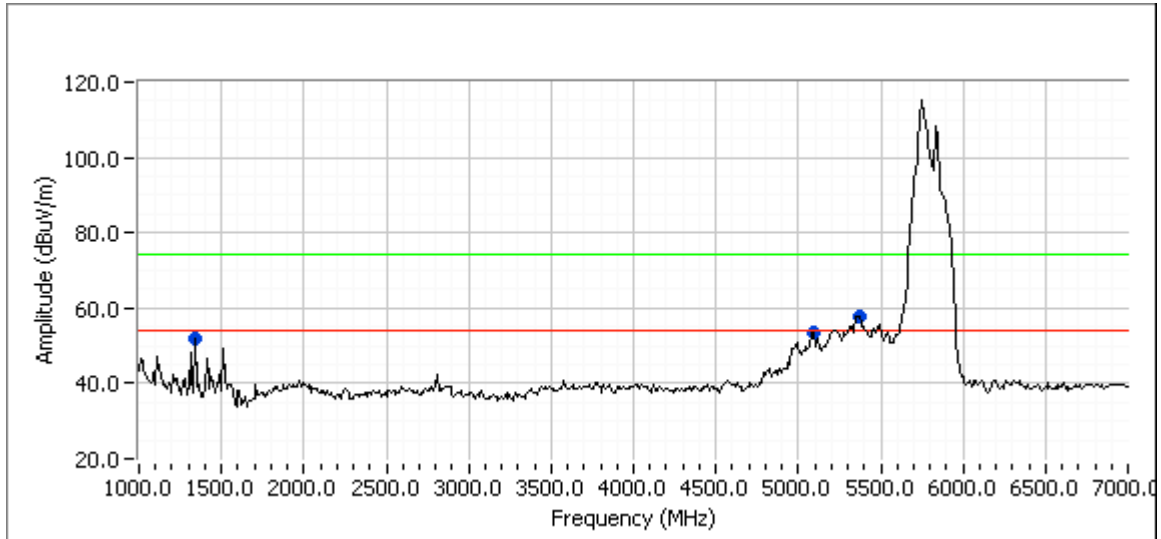

Radiated Emissions in Restricted bands (2.4 GHz Band Edges)

FCC Specifications: Paragraph 15.247(c)

Procedure:

Since this is a 2.4 GHz product, there is a restricted band that begins immediately at the high end of the operating band and another that begins 10 MHz below the low end of the operating band.



This test was conducted in a semi-anechoic chamber #5 4 at Elliott labs Fremont facility. There are three steps to performing this test.

STEP 1) The first involves making a radiated measurement of the fundamental signal with the UUT on the operating channel closest to the edge of the band. The unit was placed on a rotating wooden table 80cm above the OATS ground plane. A Horn antenna was secured to a mast 3 meters away. The test equipment was configured as shown below.

The EUT was rotated 360 degrees and the height of the antenna adjusted from 1 to 4 meters above the ground plane to determine the maximum level of the emission. The level of the fundamental emission was measured in two modes, “Peak” and “Average” using RBW and VBW of 1MHz/1MHz and 1MHz/10Hz respectively.

STEP 2) A second measurement (conducted) is made using to determine a Peak (RBW 1 MHz / VBW 1 MHz) and Avg (RBW 1 MHz / VBW 10 Hz) -dBc value. This value is measured from the peak of the “carrier” to the highest point within the restricted band.

STEP 3) A third and final measurement (conducted) is made to determine the apparent drop in signal level when the RBW is narrowed from 1MHz (in the reference measurement) to 100kHz (the bandwidth required for the restricted band emission measurement). This is referred to below as the “BW Delta”.

Peak Delta: RBW 1MHz VBW 1 MHz to RBW 100 kHz VBW 1 MHz

Avg Delta: RBW 1MHz VBW 10 Hz to RBW 100 kHz VBW 10 Hz

In some cases, this third measurement was not made if compliance was demonstrated without this measurement. In this case, if this measurement were made, it would only serve to increase the margin.

The level of the emission in the restricted band is then calculated using the following formulas.

$\text{Restricted band level (AVG)} = \text{AVG reference level} - \text{delta dB} - \text{BW Delta dB}$ $\text{Restricted band level (Peak)} = \text{Peak reference level} - \text{delta dB} - \text{BW Delta dB}$

Results Summary Table (2.4 GHz 802.11 B & G) 12 dBi Panel Antenna

802.11 B Band Edge (Restricted band @ 2.390GHz)												
Pol	Fundamental Radiated Ref Msmt		Delta Msmt		RBW Msmt		Radiated Level at Band Edge		Specification		Delta (dB below Limit)	
	Peak dbuv/m	Avg dbuv/m	Peak dBc	Avg dBc	Pk dB	Avg dB	Peak dBuv/m	Avg dBuv/m	Peak dBuv/m	Avg dBuv/m	Peak dBuv/m	Avg dBuv/m
Vert	115.2	112.6	48.72	53.6		7.72	66.48	51.27	74	54	7.52	2.73
Horz	102.1	99.3					53.38	37.97			20.62	16.03
802.11 B Band Edge (Restricted band @ 2.4835GHz)												
Pol	Fundamental Radiated Ref Msmt		Delta Msmt		RBW Msmt		Radiated Level at Band Edge		Specification		Delta (dB below Limit)	
	Peak dbuv/m	Avg dbuv/m	Peak dBc	Avg dBc	Pk dB	Avg dB	Peak dBuv/m	Avg dBuv/m	Peak dBuv/m	Avg dBuv/m	Peak dBuv/m	Avg dBuv/m
Vert	116.1	113.5	48.7	53.7		8.33	67.4	51.44	74	54	6.6	2.56
Horz	102.1	99.6					53.4	37.54			20.6	16.46
802.11 G Band Edge (Restricted band @ 2.390GHz)												
Pol	Fundamental Radiated Ref Msmt		Delta Msmt		RBW Msmt		Radiated Level at Band Edge		Specification		Delta (dB below Limit)	
	Peak dbuv/m	Avg dbuv/m	Peak dBc	Avg dBc	Pk dB	Avg dB	Peak dBuv/m	Avg dBuv/m	Peak dBuv/m	Avg dBuv/m	Peak dBuv/m	Avg dBuv/m
Vert	117	108.8	37.9	42.6	14.18	13.83	64.92	52.368	74	54	9.08	1.632
Horz	105.3	96.7					53.22	40.268			20.78	13.732
802.11 G Band Edge (Restricted band @ 2.4835GHz)												
Pol	Fundamental Radiated Ref Msmt		Delta Msmt		RBW Msmt		Radiated Level at Band Edge		Specification		Delta (dB below Limit)	
	Peak dbuv/m	Avg dbuv/m	Peak dBc	Avg dBc	Pk dB	Avg dB	Peak dBuv/m	Avg dBuv/m	Peak dBuv/m	Avg dBuv/m	Peak dBuv/m	Avg dBuv/m
Vert	106.8	97.8	32.2	38.3	10.39	8.07	64.215	51.43	74	54	9.785	2.57
Horz	101	92.1					58.415	45.73			15.585	8.27

NOTE: Zero entered for the RBW measurement indicates that the measurement was not made because it was not required in order to demonstrate compliance

Radiated emissions at band edge sample calculation (Vertical, Avg, 802.11 G, Low Edge):

$$\text{Emission Level} = \text{Fund Ref msmt} - \text{Delta msmt} - \text{RBW Delta msmt}$$

Example: 108.8 dBuV/m – 42.6 dBc – 13.83dB = 52.368dBuv/m
 54 dBuv/m - 52.368dBuv/m = 1.632 dB margin

Agilent 07:52:58 May 10, 2004

802.11 B
-dBc Msmt @ 2390
Peak

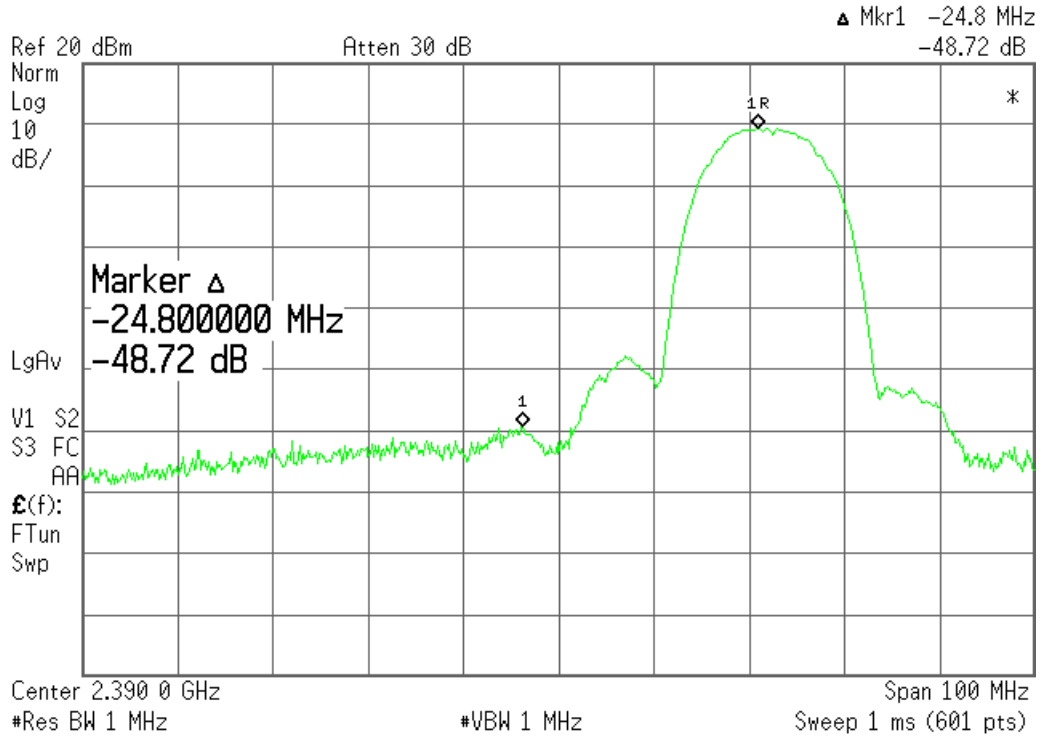

Agilent 07:56:58 May 10, 2004

802.11 B
-dBc Msmt @ 2390
Avg

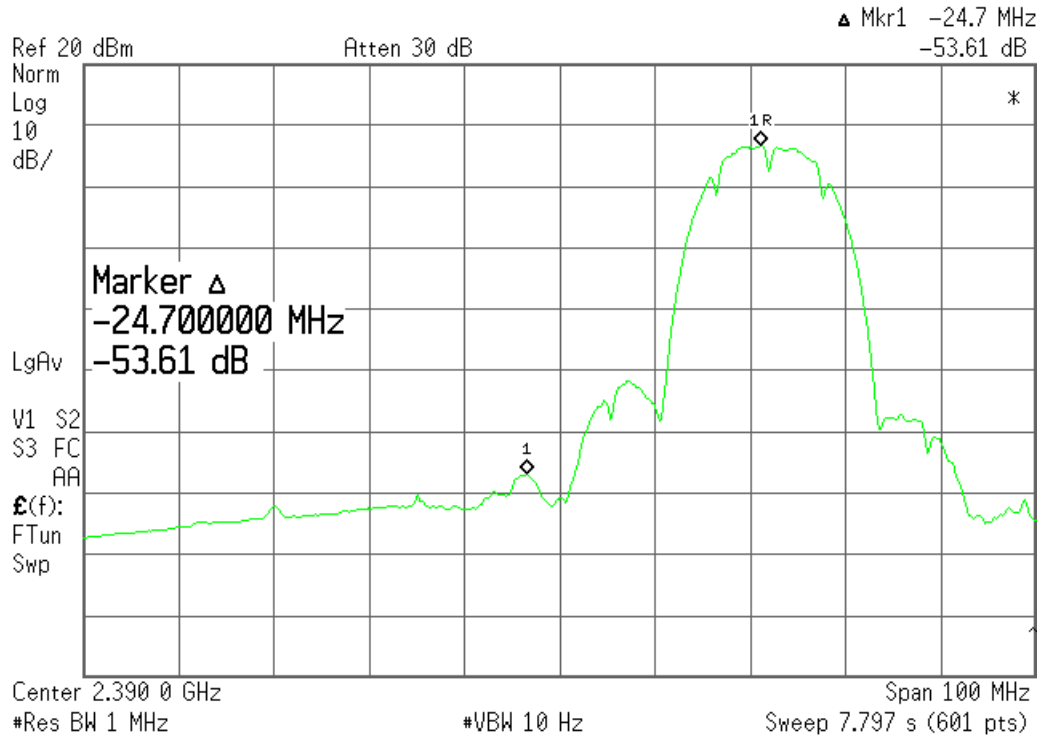

Agilent 18:34:44 Feb 21, 2005

802.11 B
BW Delta Msmt @ 2390
Avg

1MHz/10Hz Vs
100kHz/10Hz

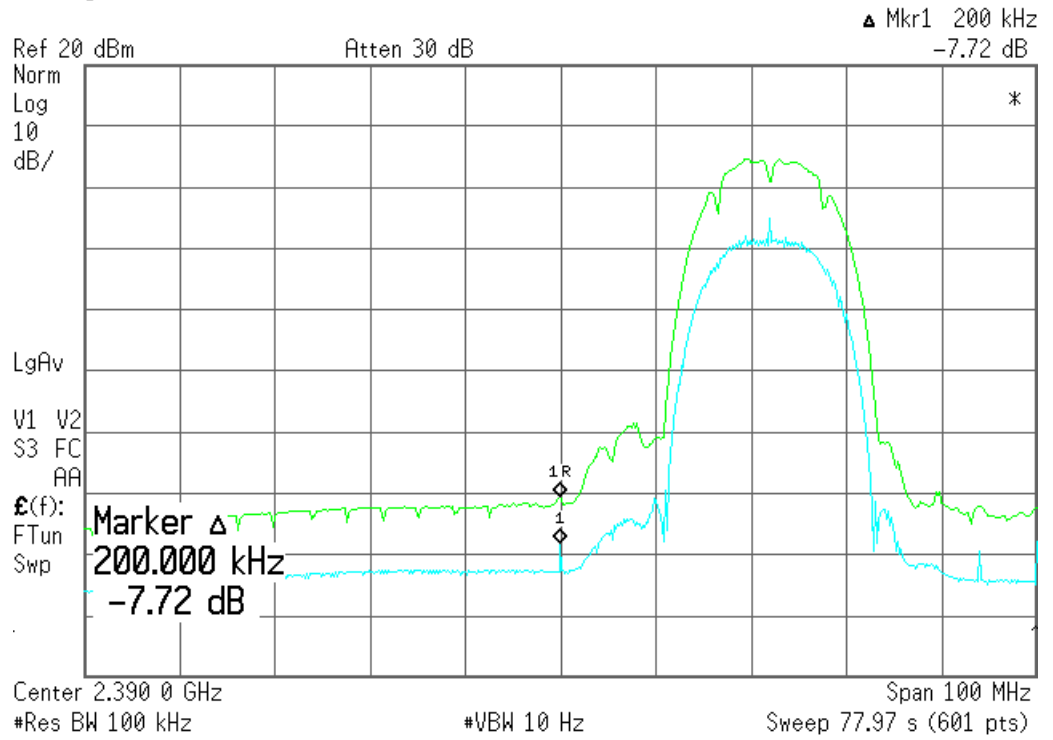

Agilent 07:18:37 May 10, 2004

802.11 G
-dBc Msmt @ 2390
Peak

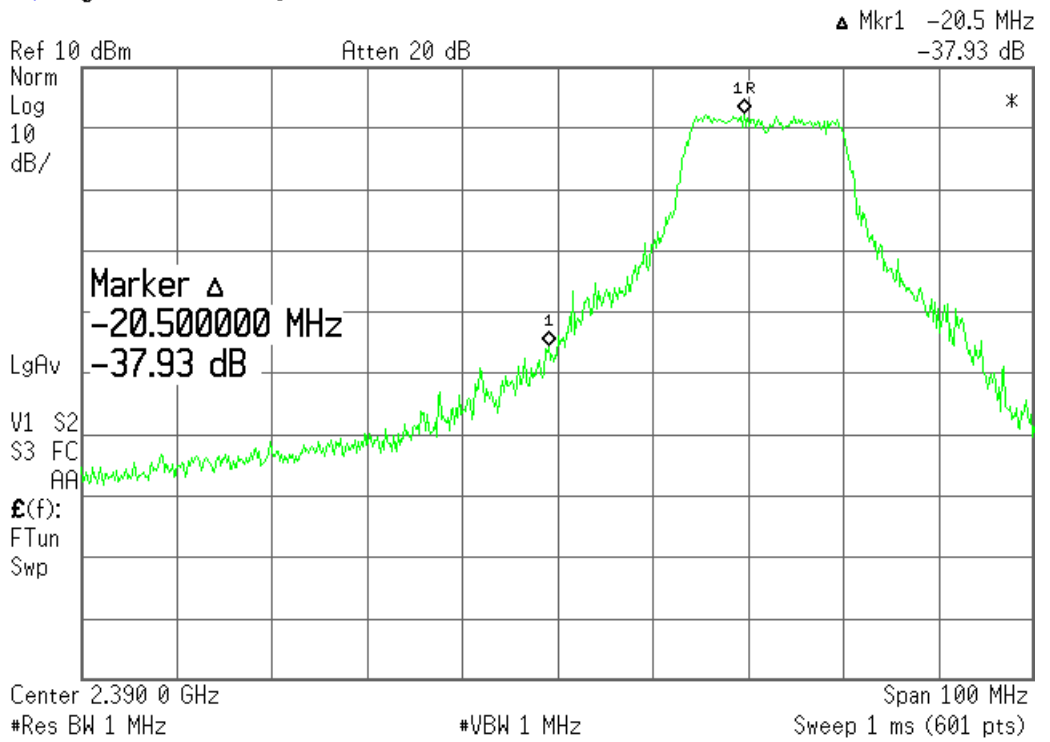

Agilent 07:20:13 May 10, 2004

802.11 G
-dBc Msmt @ 2390
Avg

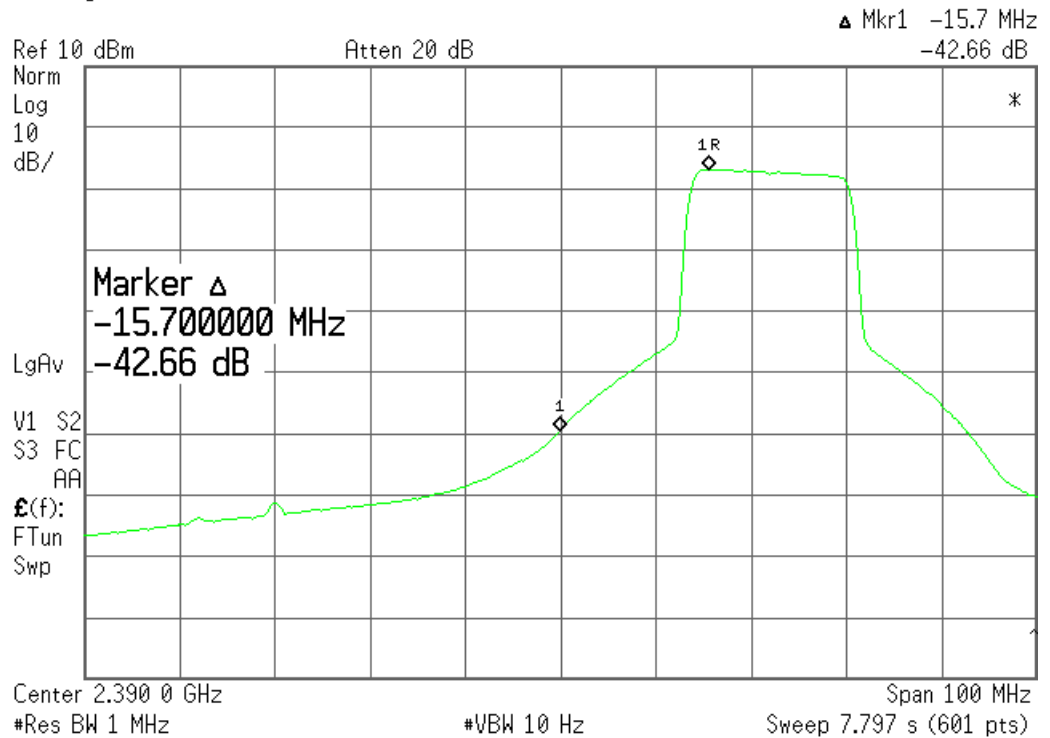

Agilent 18:41:39 Feb 21, 2005

802.11 G
 BW Delta Msmt @ 2390
 PK

1MHz/1 MHz Vs
 100kHz/1MHz

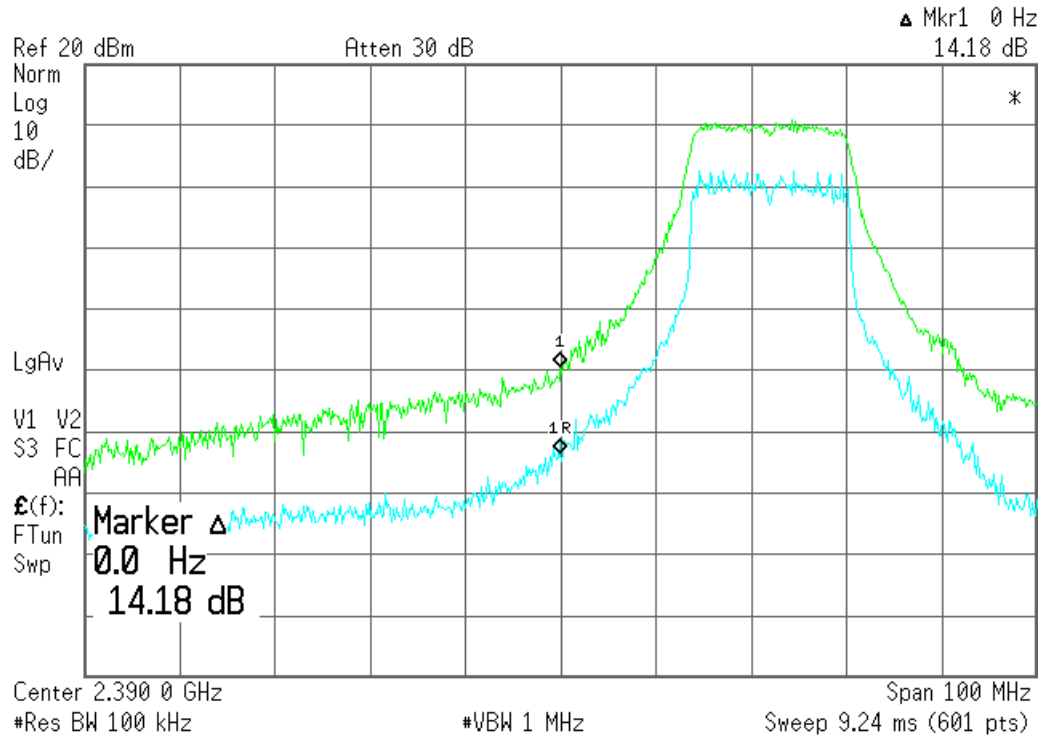

Agilent 19:16:09 Feb 21, 2005

802.11 G
 BW Delta Msmt @
 2390 Avg

1MHz/10Hz Vs
 100kHz/10Hz

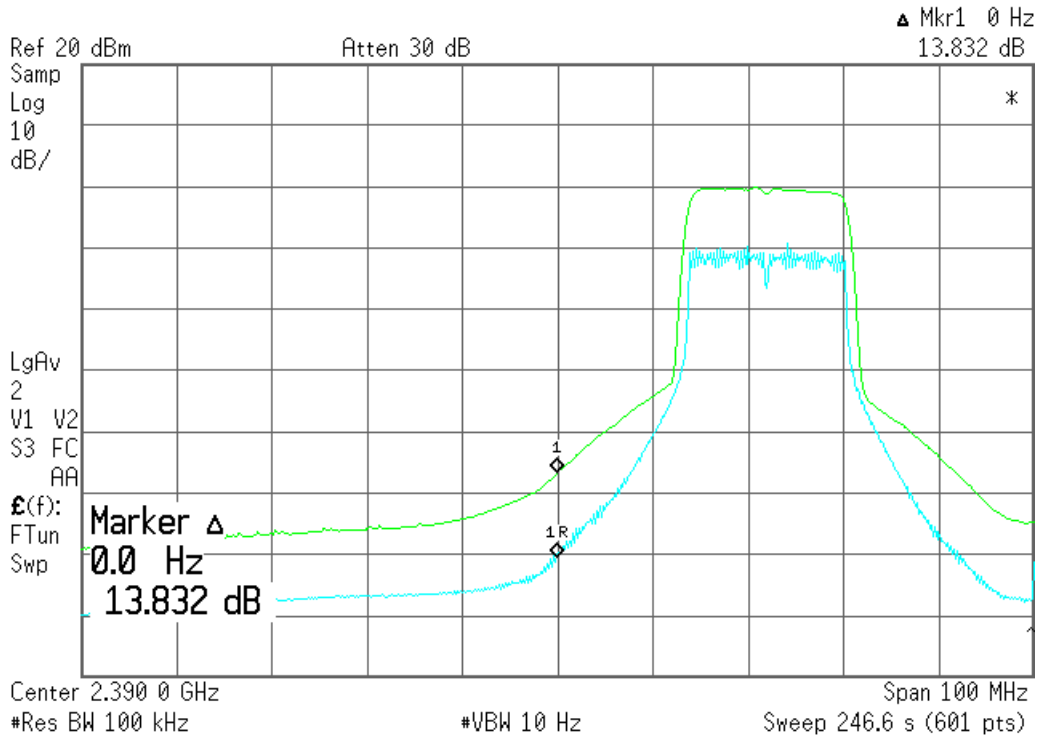

Agilent 08:02:35 May 10, 2004

Mkr1 21.7 MHz
-48.77 dB

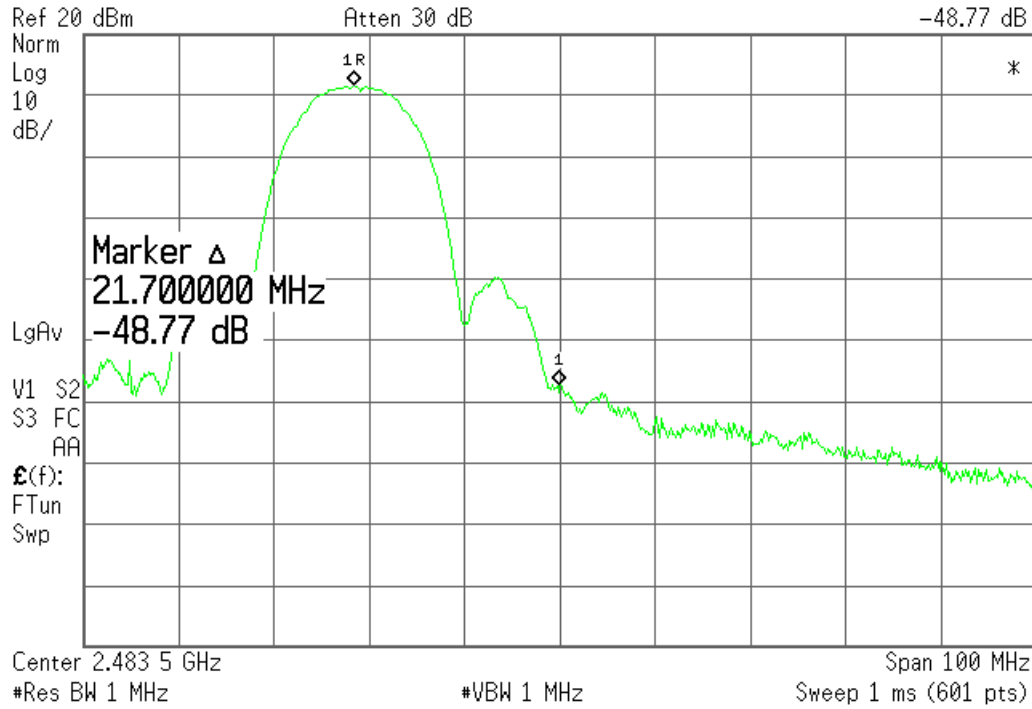

802.11 B
-dBc Msmt @
2483.5 Peak

Agilent 08:07:52 May 10, 2004

Mkr1 22.5 MHz
-53.73 dB

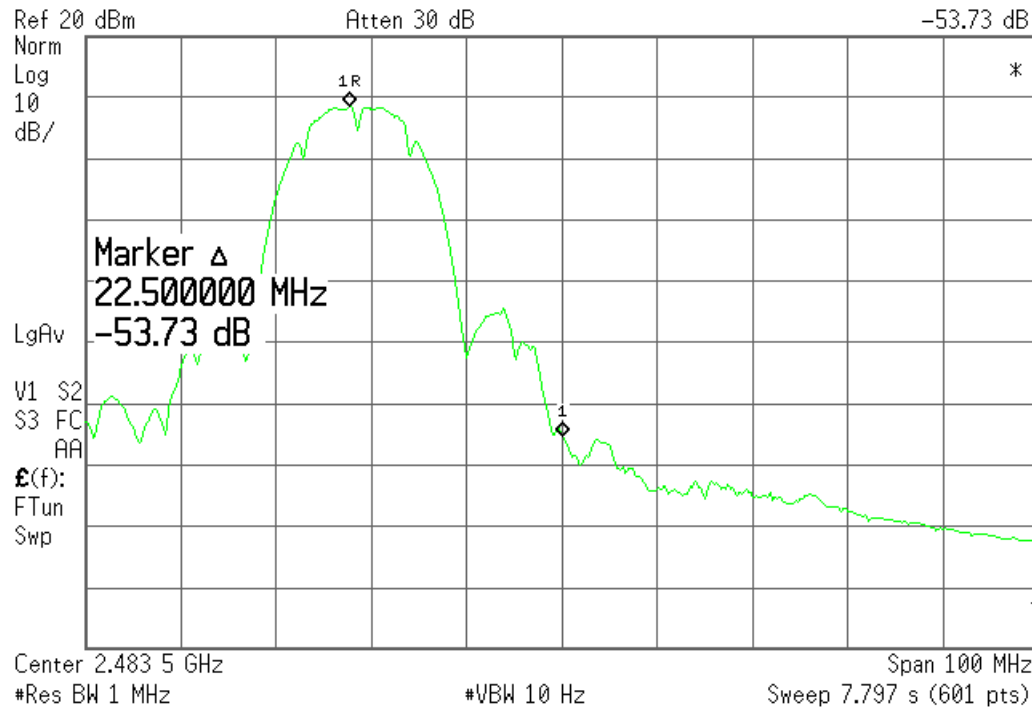

802.11 B
-dBc Msmt @
2483.5 Avg

Agilent 08:18:36 May 10, 2004

Mkr1 0 Hz
8.33 dB

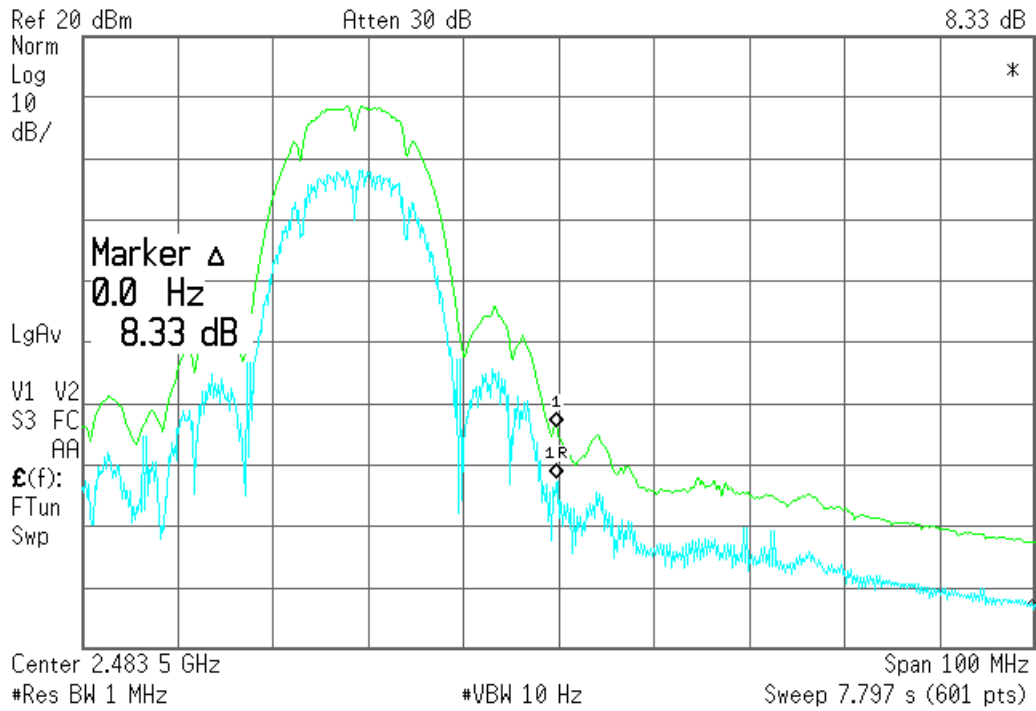

802.11 G
 -dBc Msmt @ 2483.5
 Peak

Agilent 08:33:45 May 10, 2004

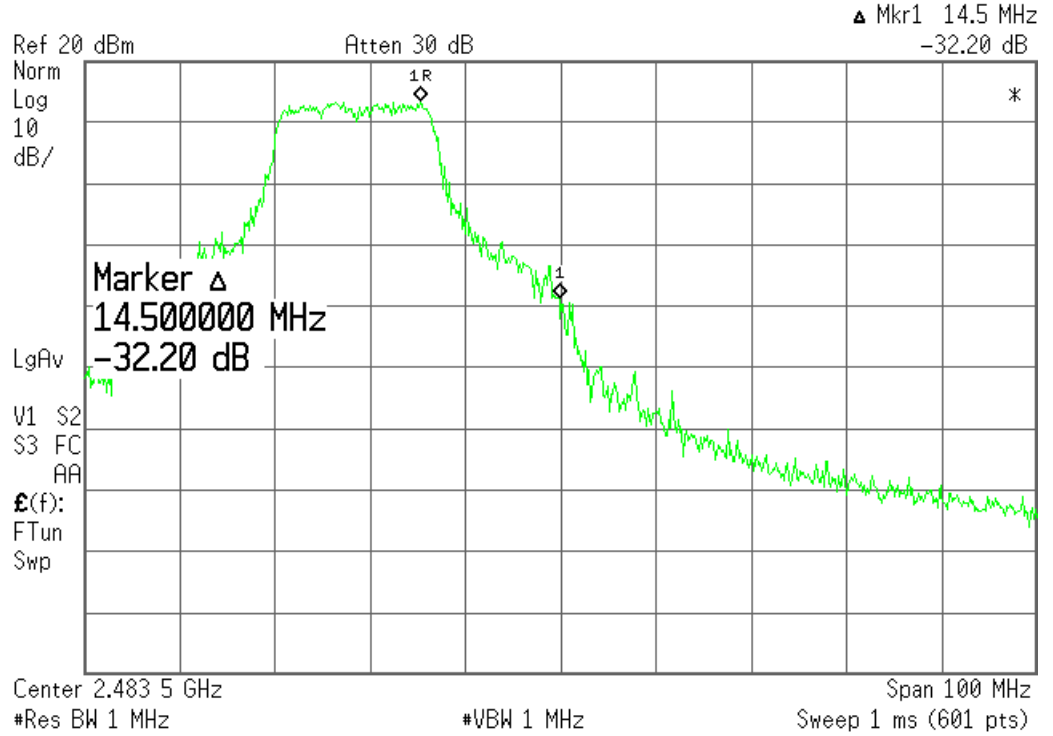

802.11 G
 -dBc Msmt @ 2483.5
 Avg

Agilent 08:35:57 May 10, 2004

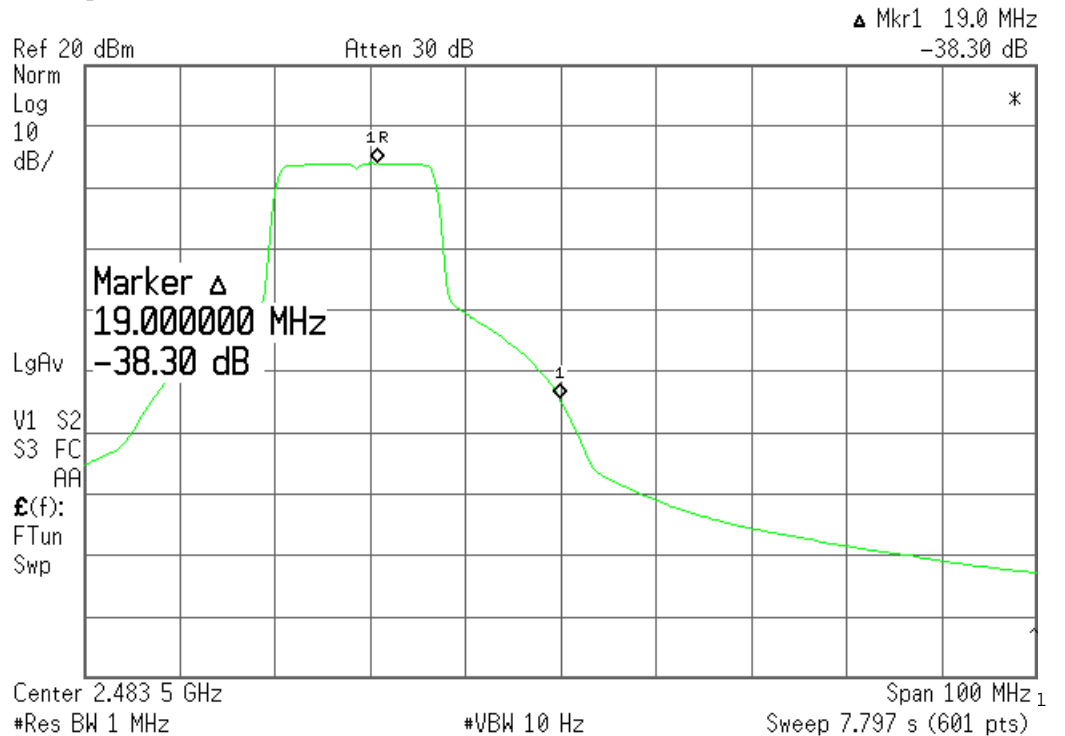

Agilent 08:40:12 May 10, 2004

802.11 G
 BW Delta Msmt @
 2483.5 Avg

1MHz/10Hz Vs
 100kHz/10Hz

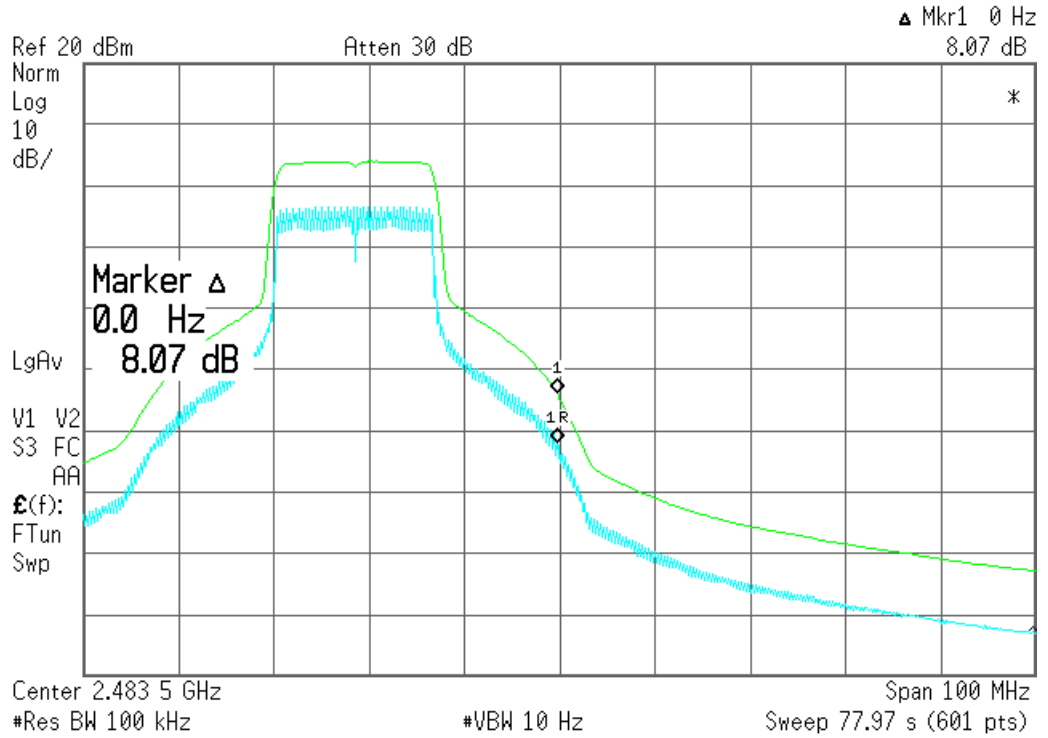

Agilent 19:24:04 Feb 21, 2005

802.11 G
 BW Delta Msmt @
 2483.5 A Peak

1MHz/1MHz Vs
 100kHz/1MHz

