



# FCC TEST REPORT

**REPORT NO.:** RF930929H03

**MODEL NO.:** AS-1250-ABG-INT, AS-1250-ABG-EXT

**RECEIVED:** Sep. 29, 2004

**TESTED:** Oct. 08 to Nov. 01, 2004

**ISSUED:** Nov. 05, 2004

**APPLICANT:** Airespace Inc.

**ADDRESS:** 110 Nortech Parkway, San Jose, CA 95134, USA

**ISSUED BY:** Advance Data Technology Corporation

**LAB LOCATION:** No. 81-1, Lu Liao Keng, 9 Ling, Wu Lung Tsuen,  
Chiung Lin Hsiang, Hsin Chu Hsien,  
Taiwan, R.O.C.

This test report consists of 146 pages in total. It may be duplicated completely for legal use with the approval of the applicant. It should not be reproduced except in full, without the written approval of our laboratory. The client should not use it to claim product endorsement by CNLA, A2LA or any government agencies. The test results in the report only apply to the tested sample. The test results in this report are traceable to the national or international standards.



0536  
ILAC MRA



No. 2177-01



## Table of Contents

1.	CERTIFICATION .....	6
2.	SUMMARY OF TEST RESULTS.....	7
3.	GENERAL INFORMATION .....	10
3.1	GENERAL DESCRIPTION OF EUT.....	10
3.2	GENERAL DESCRIPTION OF APPLIED STANDARDS.....	13
3.3	DESCRIPTION OF SUPPORT UNITS.....	14
3.4	CONFIGURATION OF SYSTEM UNDER TEST.....	15
4.	TEST TYPES AND RESULTS (FOR PART 802.11G).....	18
4.1	CONDUCTED EMISSION MEASUREMENT.....	18
4.1.1	LIMITS OF CONDUCTED EMISSION MEASUREMENT .....	18
4.1.2	TEST INSTRUMENTS .....	18
4.1.3	TEST PROCEDURES.....	19
4.1.4	DEVIATION FROM TEST STANDARD .....	19
4.1.5	TEST SETUP .....	20
4.1.6	EUT OPERATING CONDITIONS.....	20
4.1.7	TEST RESULTS .....	21
4.2	RADIATED EMISSION MEASUREMENT.....	25
4.2.1	LIMITS OF RADIATED EMISSION MEASUREMENT .....	25
4.2.2	TEST INSTRUMENTS .....	26
4.2.3	TEST PROCEDURES.....	27
4.2.4	DEVIATION FROM TEST STANDARD .....	27
4.2.5	TEST SETUP .....	28
4.2.6	EUT OPERATING CONDITIONS.....	28
4.2.7	TEST RESULTS .....	29
4.2.8	TEST RESULTS - DSSS.....	31
4.2.9	TEST RESULTS - OFDM .....	34
4.3	6DB BANDWIDTH MEASUREMENT.....	37
4.3.1	LIMITS OF 6DB BANDWIDTH MEASUREMENT.....	37
4.3.2	TEST INSTRUMENTS .....	37
4.3.3	TEST PROCEDURE .....	38
4.3.4	DEVIATION FROM TEST STANDARD .....	38
4.3.5	TEST SETUP .....	38
4.3.6	EUT OPERATING CONDITIONS.....	38
4.3.7	TEST RESULTS -DSSS .....	39
4.3.8	TEST RESULTS -OFDM .....	43
4.4	MAXIMUM PEAK OUTPUT POWER .....	47
4.4.1	LIMITS OF MAXIMUM PEAK OUTPUT POWER MEASUREMENT .....	47
4.4.2	INSTRUMENTS.....	47
4.4.3	TEST PROCEDURES.....	48
4.4.4	TEST SETUP .....	48
4.4.5	EUT OPERATING CONDITIONS.....	48



4.4.6	TEST RESULTS -DSSS .....	49
4.4.7	TEST RESULTS -OFDM .....	50
4.5	POWER SPECTRAL DENSITY MEASUREMENT .....	51
4.5.1	LIMITS OF POWER SPECTRAL DENSITY MEASUREMENT.....	51
4.5.2	TEST INSTRUMENTS .....	51
4.5.3	TEST PROCEDURE .....	52
4.5.4	DEVIATION FROM TEST STANDARD .....	52
4.5.5	TEST SETUP .....	52
4.5.6	EUT OPERATING CONDITION .....	52
4.5.7	TEST RESULTS-DSSS .....	53
4.5.8	TEST RESULTS-OFDM .....	57
4.6	BAND EDGES MEASUREMENT.....	61
4.6.1	LIMITS OF BAND EDGES MEASUREMENT .....	61
4.6.2	TEST INSTRUMENTS .....	61
4.6.3	TEST PROCEDURE .....	61
4.6.4	DEVIATION FROM TEST STANDARD .....	61
4.6.5	EUT OPERATING CONDITION .....	61
4.6.6	TEST RESULTS –DSSS .....	62
4.6.7	TEST RESULTS –OFDM .....	65
4.7	ANTENNA REQUIREMENT .....	68
4.7.1	STANDARD APPLICABLE .....	68
4.7.2	ANTENNA CONNECTED CONSTRUCTION .....	68
5.	TEST TYPES AND RESULTS (FOR PART 802.11A) .....	69
5.1	CONDUCTED EMISSION MEASUREMENT.....	69
5.1.1	LIMITS OF CONDUCTED EMISSION MEASUREMENT .....	69
5.1.2	TEST INSTRUMENTS .....	69
5.1.3	TEST PROCEDURES .....	70
5.1.4	DEVIATION FROM TEST STANDARD .....	70
5.1.5	TEST SETUP .....	71
5.1.6	EUT OPERATING CONDITIONS.....	71
5.1.7	TEST RESULTS .....	72
5.2	RADIATED EMISSION MEASUREMENT.....	76
5.2.1	LIMITS OF RADIATED EMISSION MEASUREMENT .....	76
5.2.2	LIMITS OF UNWANTED EMISSION OUT OF THE RESTRICTED BANDS .....	77
5.2.3	TEST INSTRUMENTS .....	78
5.2.4	TEST PROCEDURES .....	79
5.2.5	DEVIATION FROM TEST STANDARD .....	79
5.2.6	TEST SETUP .....	80
5.2.7	EUT OPERATING CONDITIONS.....	80
5.2.8	TEST RESULTS .....	81
	FOR FREQUENCY 5.15~5.35GHZ.....	90
5.3	PEAK TRANSMIT POWER MEASUREMENT .....	90
5.3.1	LIMITS OF PEAK TRANSMIT POWER MEASUREMENT .....	90
5.3.2	TEST INSTRUMENTS .....	90



5.3.3	TEST PROCEDURE .....	91
5.3.4	TEST SETUP .....	91
5.3.5	EUT OPERATING CONDITIONS.....	91
5.3.6	TEST RESULTS .....	92
5.4	PEAK POWER EXCURSION MEASUREMENT .....	101
5.4.1	LIMITS OF PEAK POWER EXCURSION MEASUREMENT .....	101
5.4.2	TEST INSTRUMENTS .....	101
5.4.3	TEST PROCEDURE .....	102
5.4.4	DEVIATION FROM TEST STANDARD .....	102
5.4.5	TEST SETUP .....	102
5.4.6	EUT OPERATING CONDITIONS.....	102
5.4.7	TEST RESULTS .....	103
5.5	PEAK POWER SPECTRAL DENSITY MEASUREMENT.....	108
5.5.1	LIMITS OF PEAK POWER SPECTRAL DENSITY MEASUREMENT .....	108
5.5.2	TEST INSTRUMENTS .....	108
5.5.3	TEST PROCEDURES .....	109
5.5.4	DEVIATION FROM TEST STANDARD .....	109
5.5.5	TEST SETUP .....	109
5.5.6	EUT OPERATING CONDITIONS.....	109
5.5.7	TEST RESULTS .....	110
5.6	FREQUENCY STABILITY .....	115
5.6.1	LIMITS OF FREQUENCY STABILITY MEASUREMENT .....	115
5.6.2	TEST INSTRUMENTS .....	115
5.6.3	TEST PROCEDURE .....	115
5.6.4	DEVIATION FROM TEST STANDARD .....	115
5.6.5	TEST SETUP .....	116
5.6.6	EUT OPERATING CONDITION .....	116
5.6.7	TEST RESULTS .....	117
5.7	BAND EDGES MEASUREMENT .....	118
5.7.1	TEST INSTRUMENTS .....	118
5.7.2	TEST PROCEDURE .....	118
5.7.3	EUT OPERATING CONDITION .....	118
5.7.4	TEST RESULTS .....	119
	FOR FREQUENCY 5.725~5.850GHZ.....	122
5.8	6DB BANDWIDTH MEASUREMENT.....	122
5.8.1	LIMITS OF 6DB BANDWIDTH MEASUREMENT.....	122
5.8.2	TEST INSTRUMENTS .....	122
5.8.3	TEST PROCEDURE .....	123
5.8.4	DEVIATION FROM TEST STANDARD .....	123
5.8.5	TEST SETUP .....	123
5.8.6	EUT OPERATING CONDITIONS.....	123
5.8.7	TEST RESULTS .....	124
5.9	MAXIMUM PEAK OUTPUT POWER .....	128
5.9.1	LIMITS OF PEAK TRANSMIT POWER MEASUREMENT .....	128



5.9.2	TEST INSTRUMENTS .....	128
5.9.3	TEST PROCEDURE .....	129
5.9.4	TEST SETUP .....	129
5.9.5	EUT OPERATING CONDITIONS.....	129
5.9.6	TEST RESULTS .....	130
5.10	POWER SPECTRAL DENSITY MEASUREMENT .....	131
5.10.1	LIMITS OF POWER SPECTRAL DENSITY MEASUREMENT.....	131
5.10.2	TEST INSTRUMENTS .....	131
5.10.3	TEST PROCEDURE .....	132
5.10.4	DEVIATION FROM TEST STANDARD .....	132
5.10.5	TEST SETUP .....	132
5.10.6	EUT OPERATING CONDITION .....	132
5.10.7	TEST RESULTS .....	133
5.11	BAND EDGES MEASUREMENT.....	137
5.11.1	LIMITS OF BAND EDGES MEASUREMENT .....	137
5.11.2	TEST INSTRUMENTS .....	137
5.11.3	TEST PROCEDURE .....	137
5.11.4	DEVIATION FROM TEST STANDARD .....	137
5.11.5	EUT OPERATING CONDITION .....	138
5.11.6	TEST RESULTS .....	138
5.12	ANTENNA REQUIREMENT .....	141
5.12.1	STANDARD APPLICABLE .....	141
5.12.2	ANTENNA CONNECTED CONSTRUCTION .....	141
6.	PHOTOGRAPHS OF THE TEST CONFIGURATION.....	142
7.	INFORMATION ON THE TESTING LABORATORIES.....	146



## 1. CERTIFICATION

**PRODUCT :** IEEE 802.11a/g Wireless LAN Access Point  
**BRAND NAME :** Airespace  
**MODEL NO. :** AS-1250-ABG-INT, AS-1250-ABG-EXT  
**TESTED:** Oct. 08 to Nov. 01, 2004  
**APPLICANT :** Airespace Inc.  
**TEST ITEM:** ENGINEERING SAMPLE  
**STANDARDS :** 47 CFR FCC Part 15, Subpart C (Section 15.247)  
47 CFR FCC Part 15, Subpart E (Section 15.407)  
ANSI C63.4-2003

The above equipment (Model: AS-1250-ABG-EXT) has been tested by **Advance Data Technology Corporation**, and found compliance with the requirement of the above standards. The test record, data evaluation & Equipment Under Test (EUT) configurations represented herein are true and accurate accounts of the measurements of the sample's EMC characteristics under the conditions specified in this report.

**PREPARED BY :** Carol Liao , **DATE:** Nov. 05, 2004  
( Carol Liao )

**TECHNICAL ACCEPTANCE :** Hank Chung , **DATE:** Nov. 05, 2004  
Responsible for RF ( Hank Chung )

**APPROVED BY :** Eric Lin , **DATE:** Nov. 05, 2004  
( Eric Lin, Manager )



## 2. SUMMARY OF TEST RESULTS

The EUT has been tested according to the following specifications:

<b>APPLIED STANDARD: 47 CFR Part 15, Subpart C</b>			
<b>Standard Section</b>	<b>Test Type and Limit</b>	<b>Result</b>	<b>REMARK</b>
15.207	AC Power Conducted Emission	PASS	Meet the requirement of limit Minimum passing margin is -13.80dBuV at 1.064MHz
15.247(a)(2)	Spectrum Bandwidth of a Direct Sequence Spread Spectrum System Limit: min. 500kHz	PASS	Meet the requirement of limit
15.247(b)	Maximum Peak Output Power Limit: max. 30dBm	PASS	Meet the requirement of limit
15.247(c)	Transmitter Radiated Emissions FCC Limit: Table 15.209	PASS	Meet the requirement of limit Minimum passing margin is -1.0dBuV at 2390.0MHz
15.247(d)	Power Spectral Density Limit: max. 8dBm	PASS	Meet the requirement of limit
15.247(c)	Band Edge Measurement Limit: 20 dB less than the peak value of fundamental frequency	PASS	Meet the requirement of limit



for freq. 5.15~5.35GHz :

<b>APPLIED STANDARD: 47 CFR Part 15, Subpart E</b>			
<b>Standard Section</b>	<b>Test Type</b>	<b>Result</b>	<b>REMARK</b>
15.407(b)(5)	AC Power Conducted Emission	PASS	Meet the requirement of limit Minimum passing margin is -13.80dBuV at 1.064MHz
15.407(b)(1/2/3) (b)(5)	Electric Field Strength Spurious Emissions, 30MHz ~ 40000MHz	PASS	Meet the requirement of limit Minimum passing margin is -3.90dBuV at 5350MHz
15.407(a)(1/2/3)	Peak Transmit Power	PASS	Meet the requirement of limit
15.407(a)(6)	Peak Power Excursion	PASS	Meet the requirement of limit
15.407(a)(1/2/3)	Peak Power Spectral Density	PASS	Meet the requirement of limit
15.407(g)	Frequency Stability	PASS	Meet the requirement of limit





for freq. 5.725~5.850GHz :

<b>APPLIED STANDARD: 47 CFR Part 15, Subpart C</b>			
<b>Standard Section</b>	<b>Test Type and Limit</b>	<b>Result</b>	<b>REMARK</b>
15.207	AC Power Conducted Emission	PASS	Meet the requirement of limit Minimum passing margin is -13.80dBuV at 1.064MHz
15.247(a)(2)	Spectrum Bandwidth of a Direct Sequence Spread Spectrum System Limit: min. 500kHz	PASS	Meet the requirement of limit
15.247(b)	Maximum Peak Output Power Limit: max. 30dBm	PASS	Meet the requirement of limit
15.247(c)	Transmitter Radiated Emissions FCC Limit: Table 15.209	PASS	Meet the requirement of limit Minimum passing margin is -1.10dBuV at 11490MHz and 11650MHz
15.247(d)	Power Spectral Density Limit: max. 8dBm	PASS	Meet the requirement of limit
15.247(c)	Band Edge Measurement Limit: 20 dB less than the peak value of fundamental frequency	PASS	Meet the requirement of limit



### 3. GENERAL INFORMATION

#### 3.1 GENERAL DESCRIPTION OF EUT

<b>PRODUCT</b>	IEEE 802.11a/g Wireless LAN Access Point
<b>MODEL NO.</b>	AS-1250-ABG-INT, AS-1250-ABG-EXT
<b>POWER SUPPLY</b>	DC 48V from power adapter or POE
<b>MODULATION</b>	DSSS, OFDM
<b>TRANSFER RATE</b>	802.11b and draft 802.11g: 1/2/5.5/6/9/11/12/18/24/36/48/54Mbps 802.11a:6 to 54Mbps
<b>FREQUENCY RANGE</b>	802.11b and draft 802.11g: 2400MHz ~ 2483.5MHz 802.11a: 5.15~5.35GHz and 5.725~5.850GHz
<b>NUMBER OF CHANNEL</b>	802.11b and draft 802.11g: 11 802.11a: 13 for Normal mode
<b>CHANNEL SPACING</b>	802.11b and draft 802.11g: 5MHz 802.11a: 20MHz for Normal mode
<b>Max. OUTPUT POWER</b>	802.11b: 21.17dBm / draft 802.11g: 20.97dBm 802.11a: 21.30dBm
<b>DATA CABLE</b>	NA
<b>ANTENNA TYPE</b>	Patch Antenna (Please see note 2)
<b>I/O PORTS</b>	Ethernet port x 1
<b>ASSOCIATED DEVICES</b>	NA

**NOTE:**

- The EUT is an IEEE 802.11a/g Wireless LAN Access Point, which contains two radios capable of simultaneous 802.11b/g (2.4GHz) and 802.11a (5GHz) operations.
- There are two antennas provided to this EUT, please refer to the following table:

<b>For 2.4GHz</b>		
No.	Gain (dBi)	Antenna Type
1	7.8dBi	Patch Antenna
<b>For 5GHz</b>		
No.	Gain (dBi)	Antenna Type
1	7.4dBi	Patch Antenna



3. The EUT was powered by the following power adapter or POE:

Adapter	
<b>Brand:</b>	Bothhand Enterprise Inc.
<b>Model No.:</b>	SA06L48-V
<b>Input power :</b>	100-240V~0.6A 50-60Hz,
<b>Output power :</b>	48V / 0.4A DC input cable, unshielded, 1.7m, with one core

POE:	
<b>Brand:</b>	3COM
<b>Model No.:</b>	PW130
<b>Input power :</b>	100-250Vac, 50-60Hz, 500mA
<b>Output power :</b>	48Vdc 420mA
*The POE supplied power to EUT via POE port, only used on testing.	

4. The EUT has two model names which are identical to each other in all aspects except for the followings:

Brand	Model Name	Difference
Airespace	AS-1250-ABG-INT	Patch Antenna (Ethernet port x 1, DC input port x 1)
	AS-1250-ABG-EXT	Patch Antenna with outerly connectors (Ethernet port x 1, DC input port x 1 reverse-TNC connectors x 3)

From the above models, model: **AS-1250-ABG-EXT** was selected as representative model for the test and its data were recorded in this report.

5. For model: **AS-1250-ABG-EXT**, it has been designed to operate with antenna having maximum gains of 7.8 dBi (2.4GHz) and 7.4 dBi (5GHz). Use only the supplied internal antenna, or external antennas supplied by the manufacturer, please refer to the user's manual.
6. The EUT (model: AS-1250-ABG-EXT) was not tested with external antennas because: 1. The internal and external antennas will be of the same type (Patch antenna) 2. The external antennas will be of equal or lower net effective gain than the internal antennas.
7. The above EUT information was declared by the manufacturer and for more detailed features description, please refer to the manufacturer's specifications or User's Manual.



## DESCRIPTION OF TEST MODES

For 802.11b: Eleven channels are provided to this EUT.

Channel	Frequency	Channel	Frequency
1	2412 MHz	7	2442 MHz
2	2417 MHz	8	2447 MHz
3	2422 MHz	9	2452 MHz
4	2427 MHz	10	2457 MHz
5	2432 MHz	11	2462 MHz
6	2437 MHz		

**NOTE:**

1. Below 1 GHz, the channel 1, 6, and 11 were pre-tested in chamber. The channel 11, worst case one, was chosen for final test.
2. Above 1 GHz, the channel 1, 6, and 11 were tested individually.
3. Transfer rate, 11Mbps with CCK technique and 6Mbps with OFDM technique, the worst case, were chosen for final test.

For 802.11a: Thirteen Channels are provided to this EUT for Normal mode.

Channel	Frequency	Channel	Frequency
1	5180 MHz	8	5320 MHz
2	5200 MHz	9	5745MHz
3	5220 MHz	10	5765MHz
4	5240 MHz	11	5785MHz
5	5260 MHz	12	5805MHz
6	5280 MHz	13	5825MHz
7	5300 MHz		

**NOTE:**

- 1..The EUT was tested in normal mode (channel bandwidth of approximately 20MHz).
2. "Normal Mode" allows data rates of up to 54Mbps. The device was, therefore, tested in Normal mode at the data rate that produced the highest output power for normal mode (6Mbps).
3. Channel 1, 4, 5, 8, 9, 11 and 13 are the closest frequencies to the band edge, were chosen for final test of Normal Mode.



### **3.2 GENERAL DESCRIPTION OF APPLIED STANDARDS**

The EUT is an IEEE 802.11a/g Wireless LAN Access Point. According to the specifications of the manufacturer; it must comply with the requirements of the following standards:

**FCC Part 15, Subpart C (15.247)**

**Subpart E (15.407)**

**ANSI C63.4-2003**

All tests have been performed and recorded as per the above standards.

**NOTE:** The EUT is also considered as a kind of computer peripheral, because the connection to computer is necessary for typical use. It has been verified to comply with the requirements of 47CFR Part 15, Subpart B, Class B (DoC). The test report has been issued separately.



### 3.3 DESCRIPTION OF SUPPORT UNITS

The EUT has been tested as an independent unit together with other necessary accessories or support units. The following support units or accessories were used to form a representative test configuration during the tests.

No.	Product	Brand	Model No.	Serial No.	FCC ID
1	NOTEBOOK COMPUTER	DELL	C600	6DRV601	FCC DoC

No.	Signal cable description
1	NA

Note: 1. All power cords of the above support units are unshielded (1.8m).



### 3.4 CONFIGURATION OF SYSTEM UNDER TEST

**For Adapter Mode:**

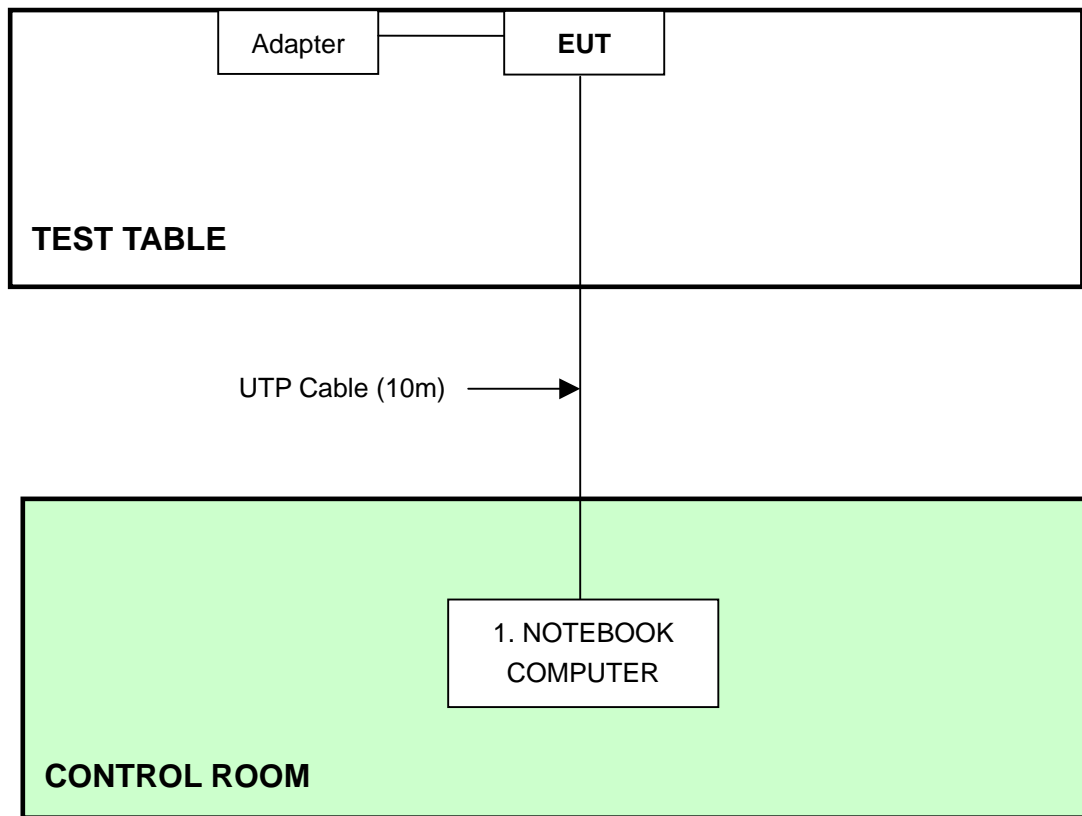

- NOTE:**
1. Support unit 1 was kept in the control room during the test.
  2. Please refer to the photos of test configuration in Item 6 also.



**For POE Mode: (Conducted Emission)**

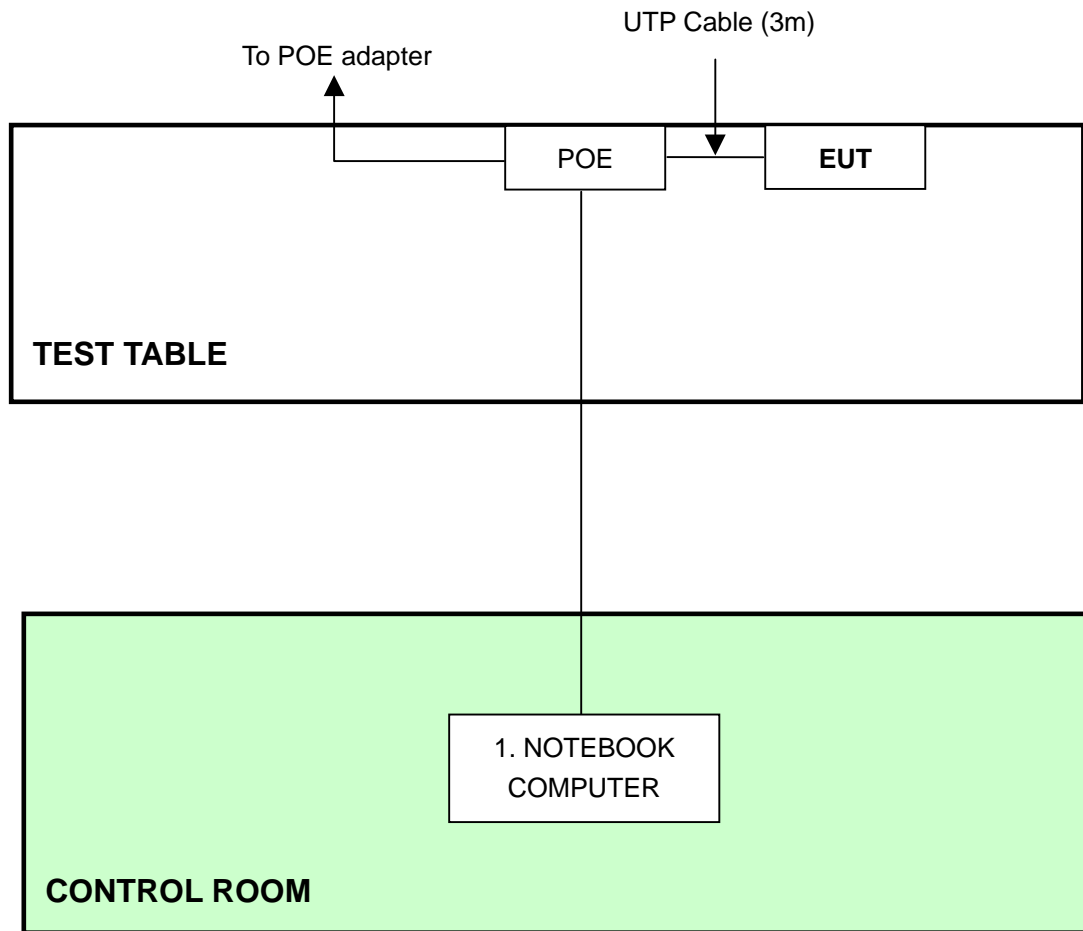

- NOTE:** 1. Support unit 1 was kept in the control room during the test.  
2. Please refer to the photos of test configuration in Item 6 also.





**For POE Mode: (Radiated Emissions)**

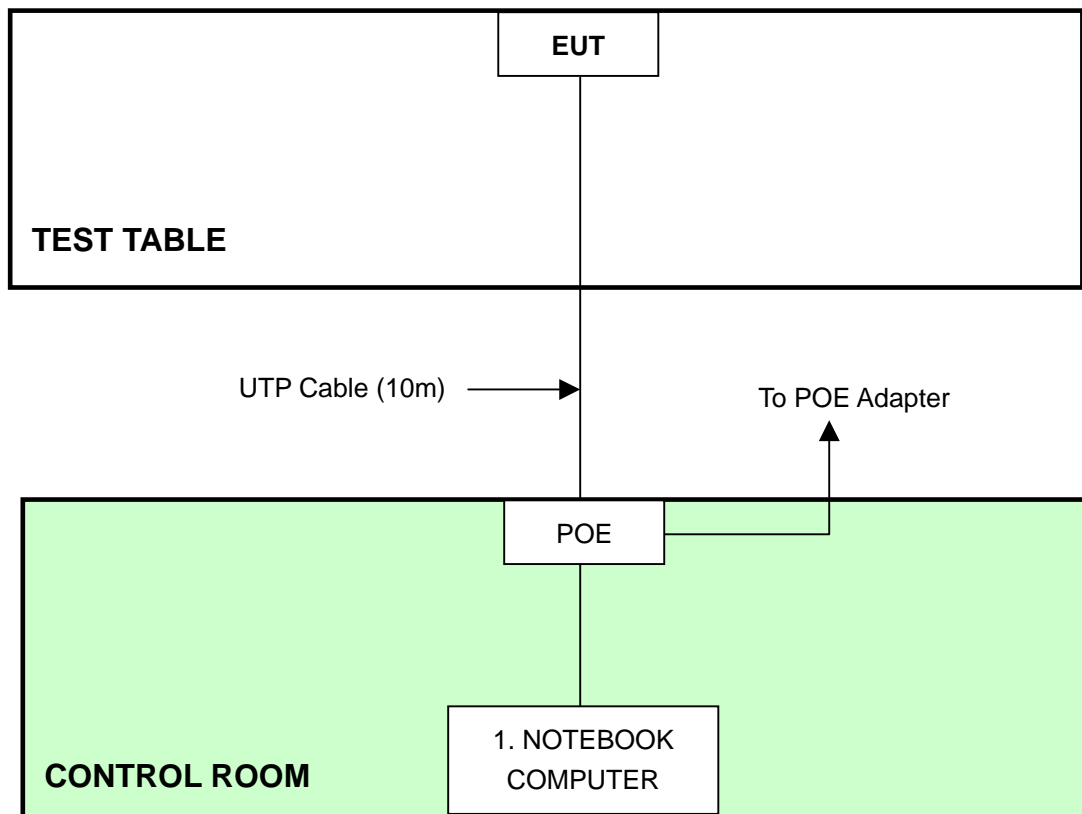

- NOTE:**
1. Support unit 1 was kept in the control room during the test.
  2. Please refer to the photos of test configuration in Item 6 also.



## 4. TEST TYPES AND RESULTS (FOR PART 802.11g)

### 4.1 CONDUCTED EMISSION MEASUREMENT

#### 4.1.1 LIMITS OF CONDUCTED EMISSION MEASUREMENT

FREQUENCY (MHz)	Class A (dBuV)		Class B (dBuV)	
	Quasi-peak	Average	Quasi-peak	Average
0.15 - 0.5	79	66	66 - 56	56 - 46
0.50 - 5.0	73	60	56	46
5.0 - 30.0	73	60	60	50

- NOTES:**
- (1) The lower limit shall apply at the transition frequencies.
  - (2) The limit decreases in line with the logarithm of the frequency in the range of 0.15 to 0.50 MHz.
  - (3) All emanations from a class A/B digital device or system, including any network of conductors and apparatus connected thereto, shall not exceed the level of field strengths specified above.

#### 4.1.2 TEST INSTRUMENTS

DESCRIPTION & MANUFACTURER	MODEL NO.	SERIAL NO.	CALIBRATED UNTIL
ROHDE & SCHWARZ Test Receiver	ESCS 30	847124/029	Dec. 04, 2004
ROHDE & SCHWARZ LISN (for EUT)	ESHS-Z5	848773/004	Nov. 04, 2004
KYORITSU LISN (for peripheral)	KNW-407	8/1395/12	Jul. 23, 2005
RF Cable (JETBAO)	RG233/U	Cable_CA_01	Jul. 02, 2005
Terminator(for KYORITSU)	50	3	May 10, 2005
Software	Cond-V2e	NA	NA

**NOTE:**

1. The calibration interval of the above test instruments is 12 months and the calibrations are traceable to NML/ROC and NIST/USA.
2. The test was performed in ADT Shielded Room No. A.
- 3 The VCCI Con A Registration No. is C-817.
- 4 \* = These equipment are used for the final measurement.
- 5 The measurement uncertainty is 2.53 dB, which is calculated as per the document CISPR 16-4



#### 4.1.3 TEST PROCEDURES

- a. The EUT was placed 0.4 meters from the conducting wall of the shielded room with EUT being connected to the power mains through a line impedance stabilization network (LISN). Other support units were connected to the power mains through another LISN. The two LISNs provide 50 ohm/ 50uH of coupling impedance for the measuring instrument.
- b. Both lines of the power mains connected to the EUT were checked for maximum conducted interference.
- c. The frequency range from 150 kHz to 30 MHz was searched. Emission levels over 10dB under the prescribed limits could not be reported

#### 4.1.4 DEVIATION FROM TEST STANDARD

No deviation

#### 4.1.5 TEST SETUP

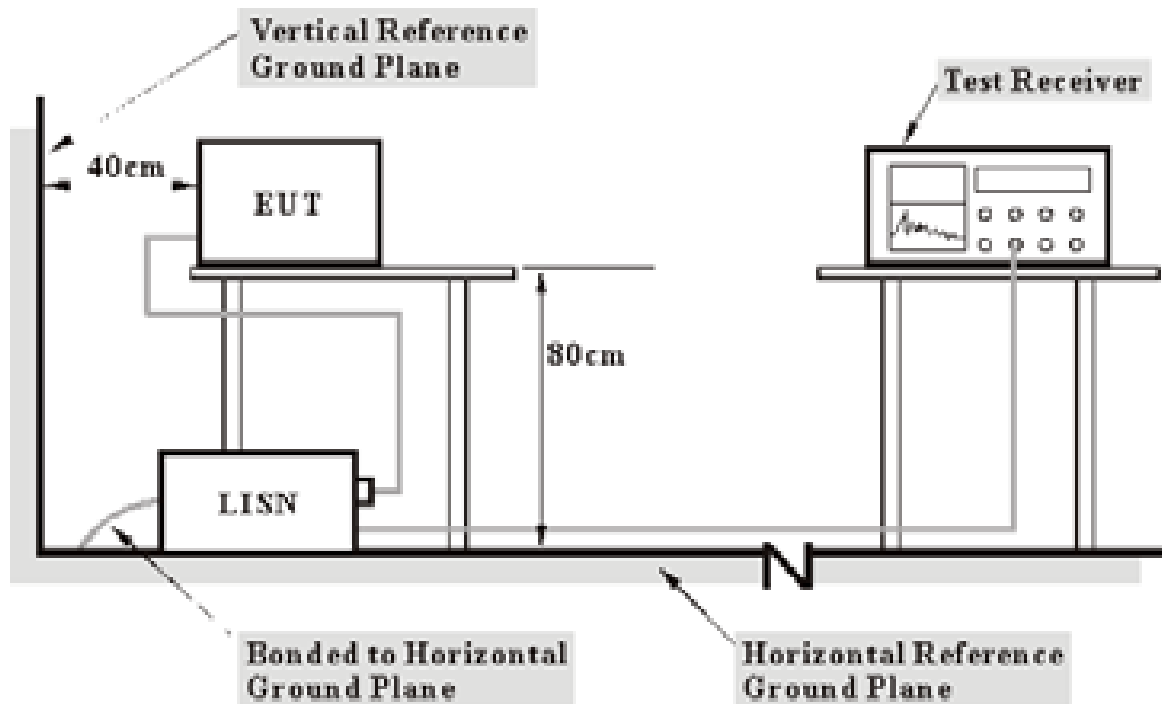

- Note:**
1. Support units were connected to second LISN.
  2. Both of LISNs (AMN) 80 cm from EUT and at the least 80 cm from other units and other metal planes support units.

For the actual test configuration, please refer to the related item – Photographs of the Test Configuration.

#### 4.1.6 EUT OPERATING CONDITIONS

- a. Placed the EUT on the testing table.
- b. Prepared another computer system to act as a communication partner and placed it outside of testing area.
- c. The communication partner run test program “ART\_V48\_build 13\_Alpha” to enable EUT under transmission/receiving condition continuously at specific channel frequency via UTP cable.



4.1.7 TEST RESULTS

<b>EUT</b>	IEEE 802.11a/g Wireless LAN Access Point		
<b>MODEL</b>	AS-1250-ABG-EXT		
<b>TEST MODE</b>	Channel 11, With Adapter	<b>6dB BANDWIDTH</b>	9 kHz
<b>INPUT POWER (SYSTEM)</b>	120Vac, 60Hz	<b>PHASE</b>	Line (L)
<b>ENVIRONMENTAL CONDITIONS</b>	27deg. C, 65%RH, 979 hPa	<b>TESTED BY</b>	Sky Liao

No	Freq. [MHz]	Corr. Factor (dB)	Reading Value		Emission Level		Limit		Margin	
			[dB (uV)]		[dB (uV)]		[dB (uV)]		(dB)	
			Q.P.	AV.	Q.P.	AV.	Q.P.	AV.	Q.P.	AV.
1	0.154	0.31	50.58	-	50.89	-	65.79	55.79	-14.90	-
2	0.228	0.31	43.54	-	43.85	-	62.52	52.52	-18.67	-
3	0.534	0.35	37.98	-	38.33	-	56.00	46.00	-17.67	-
4	1.064	0.43	37.47	-	37.90	-	56.00	46.00	-18.10	-
5	7.602	1.12	37.13	-	38.25	-	60.00	50.00	-21.75	-
6	26.641	1.92	37.62	-	39.54	-	60.00	50.00	-20.46	-

- REMARKS:**
1. Q.P. and AV. are abbreviations of quasi-peak and average individually.
  2. "-": The Quasi-peak reading value also meets average limit and measurement with the average detector is unnecessary.
  3. The emission levels of other frequencies were very low against the limit.
  4. Margin value = Emission level - Limit value
  5. Correction factor = Insertion loss + Cable loss
  6. Emission Level = Correction Factor + Reading Value.

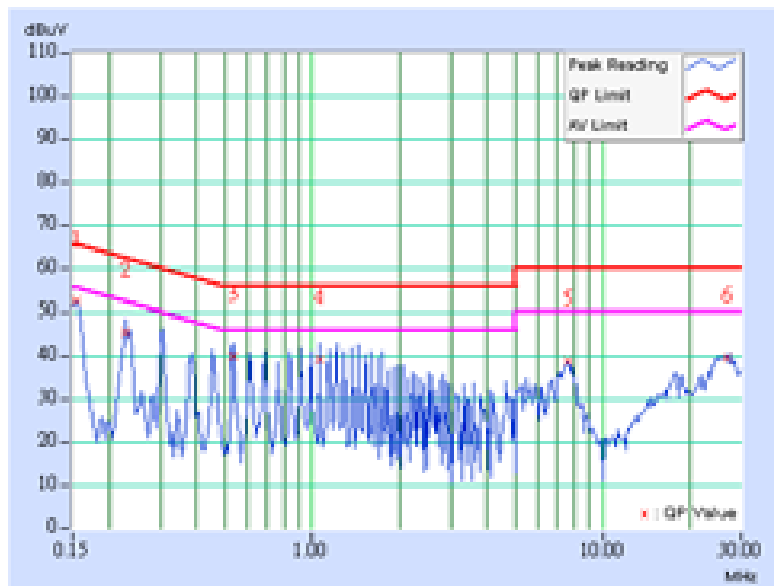



<b>EUT</b>	IEEE 802.11a/g Wireless LAN Access Point		
<b>MODEL</b>	AS-1250-ABG-EXT		
<b>TEST MODE</b>	Channel 11, with Adapter	<b>6dB BANDWIDTH</b>	9 kHz
<b>INPUT POWER (SYSTEM)</b>	120Vac, 60Hz	<b>PHASE</b>	Neutral (N)
<b>ENVIRONMENTAL CONDITIONS</b>	27deg. C, 65%RH, 979 hPa	<b>TESTED BY</b>	Sky Liao

No	Freq. [MHz]	Corr. Factor (dB)	Reading Value [dB (uV)]		Emission Level [dB (uV)]		Limit [dB (uV)]		Margin (dB)	
			Q.P.	AV.	Q.P.	AV.	Q.P.	AV.	Q.P.	AV.
	1	0.154	0.31	50.48	-	50.79	-	65.79	55.79	-15.00
2	0.228	0.31	43.16	-	43.47	-	62.52	52.52	-19.05	-
3	0.380	0.33	43.50	-	43.83	-	58.27	48.27	-14.44	-
<b>4</b>	<b>1.064</b>	<b>0.43</b>	<b>41.77</b>	-	<b>42.20</b>	-	<b>56.00</b>	<b>46.00</b>	<b>-13.80</b>	-
5	5.770	0.97	40.62	-	41.59	-	60.00	50.00	-18.41	-
6	25.516	1.69	37.54	-	39.23	-	60.00	50.00	-20.77	-

- REMARKS:**
1. Q.P. and AV. are abbreviations of quasi-peak and average individually.
  2. "-": The Quasi-peak reading value also meets average limit and measurement with the average detector is unnecessary.
  3. The emission levels of other frequencies were very low against the limit.
  4. Margin value = Emission level - Limit value
  5. Correction factor = Insertion loss + Cable loss
  6. Emission Level = Correction Factor + Reading Value.

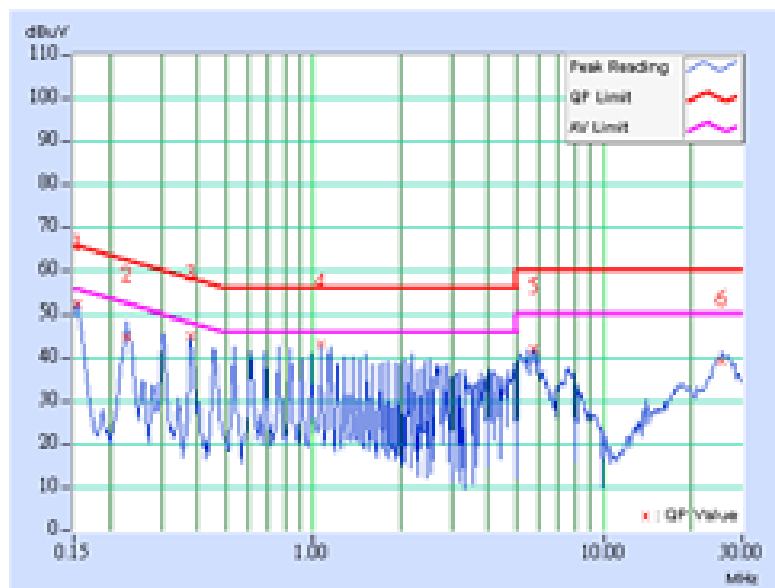



<b>EUT</b>	IEEE 802.11a/g Wireless LAN Access Point		
<b>MODEL</b>	AS-1250-ABG-EXT		
<b>TEST MODE</b>	Channel 11, With POE	<b>6dB BANDWIDTH</b>	9 kHz
<b>INPUT POWER (SYSTEM)</b>	120Vac, 60Hz	<b>PHASE</b>	Line (L)
<b>ENVIRONMENTAL CONDITIONS</b>	27deg. C, 67%RH, 979 hPa	<b>TESTED BY</b>	Sky Liao

No	Freq. [MHz]	Corr. Factor (dB)	Reading Value [dB (uV)]		Emission Level [dB (uV)]		Limit [dB (uV)]		Margin (dB)	
			Q.P.	AV.	Q.P.	AV.	Q.P.	AV.	Q.P.	AV.
			1	0.158	0.31	40.06	-	40.37	-	65.56
2	0.466	0.34	33.64	-	33.98	-	56.58	46.58	-22.60	-
3	2.192	0.56	32.01	-	32.57	-	56.00	46.00	-23.43	-
4	18.242	1.70	40.09	-	41.79	-	60.00	50.00	-18.21	-
5	23.129	1.86	43.01	-	44.87	-	60.00	50.00	-15.13	-
6	28.287	1.93	39.78	-	41.71	-	60.00	50.00	-18.29	-

- REMARKS:**
1. Q.P. and AV. are abbreviations of quasi-peak and average individually.
  2. "-": The Quasi-peak reading value also meets average limit and measurement with the average detector is unnecessary.
  3. The emission levels of other frequencies were very low against the limit.
  4. Margin value = Emission level - Limit value
  5. Correction factor = Insertion loss + Cable loss
  6. Emission Level = Correction Factor + Reading Value.

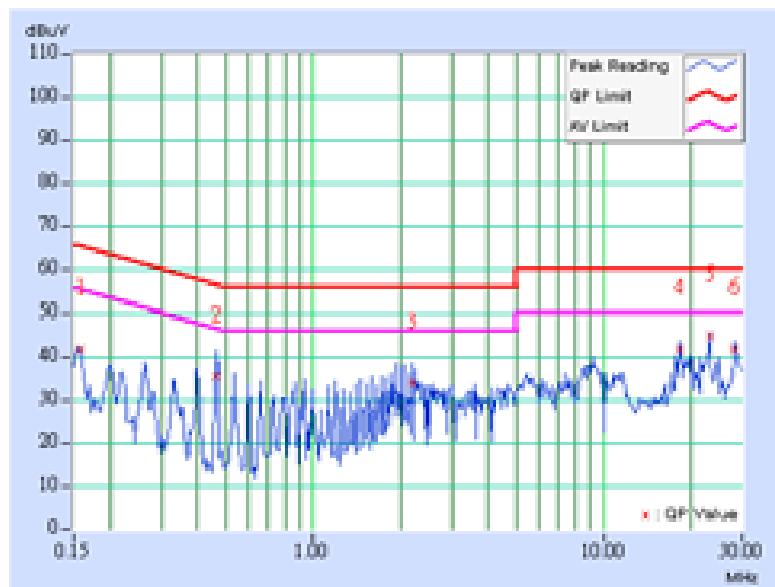



<b>EUT</b>	IEEE 802.11a/g Wireless LAN Access Point		
<b>MODEL</b>	AS-1250-ABG-EXT		
<b>TEST MODE</b>	Channel 11, with POE	<b>6dB BANDWIDTH</b>	9 kHz
<b>INPUT POWER (SYSTEM)</b>	120Vac, 60Hz	<b>PHASE</b>	Neutral (N)
<b>ENVIRONMENTAL CONDITIONS</b>	27deg. C, 67%RH, 979 hPa	<b>TESTED BY</b>	Sky Liao

No	Freq. [MHz]	Corr. Factor (dB)	Reading Value [dB (uV)]		Emission Level [dB (uV)]		Limit [dB (uV)]		Margin (dB)	
			Q.P.	AV.	Q.P.	AV.	Q.P.	AV.	Q.P.	AV.
	1	0.154	0.31	38.35	-	38.66	-	65.79	55.79	-27.13
2	0.396	0.33	34.71	-	35.04	-	57.93	47.93	-22.90	-
3	0.466	0.34	35.05	-	35.39	-	56.58	46.58	-21.19	-
4	1.994	0.53	33.70	-	34.23	-	56.00	46.00	-21.77	-
5	9.500	1.15	34.38	-	35.53	-	60.00	50.00	-24.47	-
6	23.129	1.66	42.47	-	44.13	-	60.00	50.00	-15.87	-

- REMARKS:**
1. Q.P. and AV. are abbreviations of quasi-peak and average individually.
  2. "-": The Quasi-peak reading value also meets average limit and measurement with the average detector is unnecessary.
  3. The emission levels of other frequencies were very low against the limit.
  4. Margin value = Emission level - Limit value
  5. Correction factor = Insertion loss + Cable loss
  6. Emission Level = Correction Factor + Reading Value.

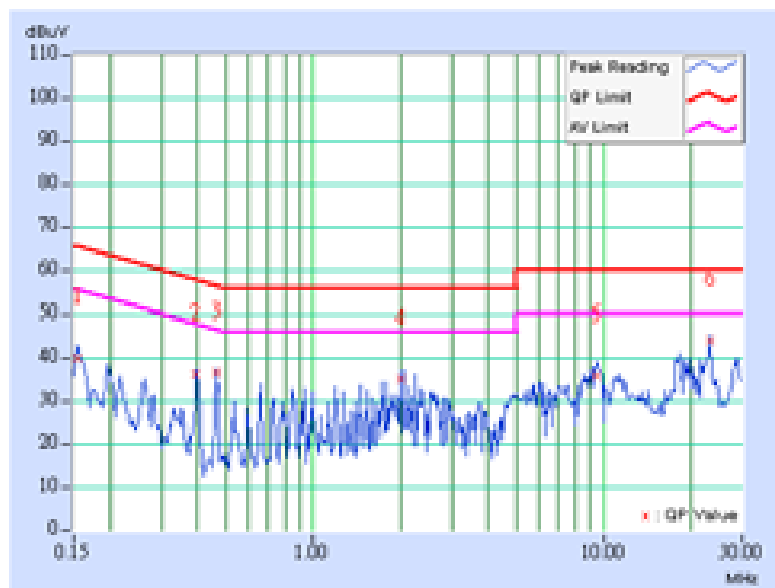





## 4.2 RADIATED EMISSION MEASUREMENT

### 4.2.1 LIMITS OF RADIATED EMISSION MEASUREMENT

Field strength limits are at the distance of 3 meters, emissions radiated outside of the specified bands, shall be according to the general radiated limits in 15.209 as following:

Frequencies (MHz)	Field strength (microvolts/meter)	Measurement distance (meters)
0.009-0.490	2400/F(kHz)	300
0.490-1.705	24000/F(kHz)	30
1.705-30.0	30	30
30-88	100	3
88-216	150	3
216-960	200	3
Above 960	500	3

**NOTE:**

1. The lower limit shall apply at the transition frequencies.
2. Emission level (dBuV/m) = 20 log Emission level (uV/m).
3. As shown in 15.35(b), for frequencies above 1000MHz, the field strength limits are based on average detector, however, the peak field strength of any emission shall not exceed the maximum permitted average limits, specified above by more than 20dB under any condition of modulation.



## 4.2.2 TEST INSTRUMENTS

DESCRIPTION & MANUFACTURER	MODEL NO.	SERIAL NO.	CALIBRATED UNTIL
HP Spectrum Analyzer	8594E	3710A04861	Sep. 23, 2005
ADVANTEST Spectrum Analyzer	R3271A	85060311	Jun. 29, 2005
CHASE RF Pre_Amplifier	CPA9232	1057	Aug. 06, 2005
HP Pre_Amplifier	8449B	3008A01922	Oct. 13, 2005
ROHDE & SCHWARZ Test Receiver	ESCS30	100287	Dec. 11, 2004
CHASE Broadband Antenna	VULB9168	138	May 22, 2005
Schwarzbeck Horn_Antenna	BBHA9120	D124	Jun. 16, 2005
Schwarzbeck Horn_Antenna	BBHA 9170	BBHA9170192	Feb. 16, 2005
SCHWARZBECK Tunable Dipole Antenna	UHAP	897	Mar. 07, 2005
SCHWARZBECK Tunable Dipole Antenna	VHAP	880	Mar. 07, 2005
RF Switches (ARNITSU)	CS-201	1565157	Dec. 01, 2004
RF CABLE (Chaintek) 1GHz-20GHz	SF102	22054-2	Feb. 10. 2005
RF Cable(RICHTEC)	9913-30M	STCCAB-30M- 1GHz-021	Dec. 01, 2004
Software	AS60P8	NA	NA
CHANCE MOST Antenna Tower	AT-100	0203	NA
CHANCE MOST Turn Table	TT-100	0203	NA

Note: 1. The calibration interval of the above test instruments is 12 months (36 months for Tunable Dipole Antenna) and the calibrations are traceable to NML/ROC and NIST/USA.

2. The horn antenna and HP preamplifier (model: 8449B) are used only for the measurement of emission frequency above 1GHz if tested.
3. The test was performed in ADT Open Site No. C.
4. The FCC Site Registration No. is 656396.
5. The VCCI Site Registration No. is R-1626.
6. The CANADA Site Registration No. is IC 4824-3.
7. The measurement uncertainty is 3.56 dB, which is calculated as per the document CISPR 16-4



#### 4.2.3 TEST PROCEDURES

- a. The EUT was placed on the top of a rotating table 0.8 meters above the ground at a 10 meter open area test site. The table was rotated 360 degrees to determine the position of the highest radiation.
- b. The EUT was set 3 meters away from the interference-receiving antenna, which was mounted on the top of a variable-height antenna tower.
- c. The antenna is a broadband antenna, and its height is varied from one meter to four meters above the ground to determine the maximum value of the field strength. Both horizontal and vertical polarizations of the antenna are set to make the measurement.
- d. For each suspected emission, the EUT was arranged to its worst case and then the antenna was tuned to heights from 1 meter to 4 meters and the rotatable table was turned from 0 degrees to 360 degrees to find the maximum reading.
- e. The test-receiver system was set to Peak Detect Function and Specified Bandwidth with Maximum Hold Mode.
- f. If the emission level of the EUT in peak mode was 10 dB lower than the limit specified, then testing could be stopped and the peak values of the EUT would be reported. Otherwise the emissions that did not have 10 dB margin would be re-tested one by one using the quasi-peak method or average method as specified and then reported in Data sheet peak mode and QP mode.

**NOTE:**

1. The resolution bandwidth and video bandwidth of test receiver/spectrum analyzer is 120kHz for Quasi-peak detection at frequency below 1GHz.
2. The resolution bandwidth and video bandwidth of test receiver/spectrum analyzer is 1 MHz for Peak detection (PK) at frequency above 1GHz.
3. The resolution bandwidth of test receiver/spectrum analyzer is 1 MHz and the video bandwidth is 300 Hz for Average detection (AV) at frequency above 1GHz.

#### 4.2.4 DEVIATION FROM TEST STANDARD

No deviation

#### 4.2.5 TEST SETUP

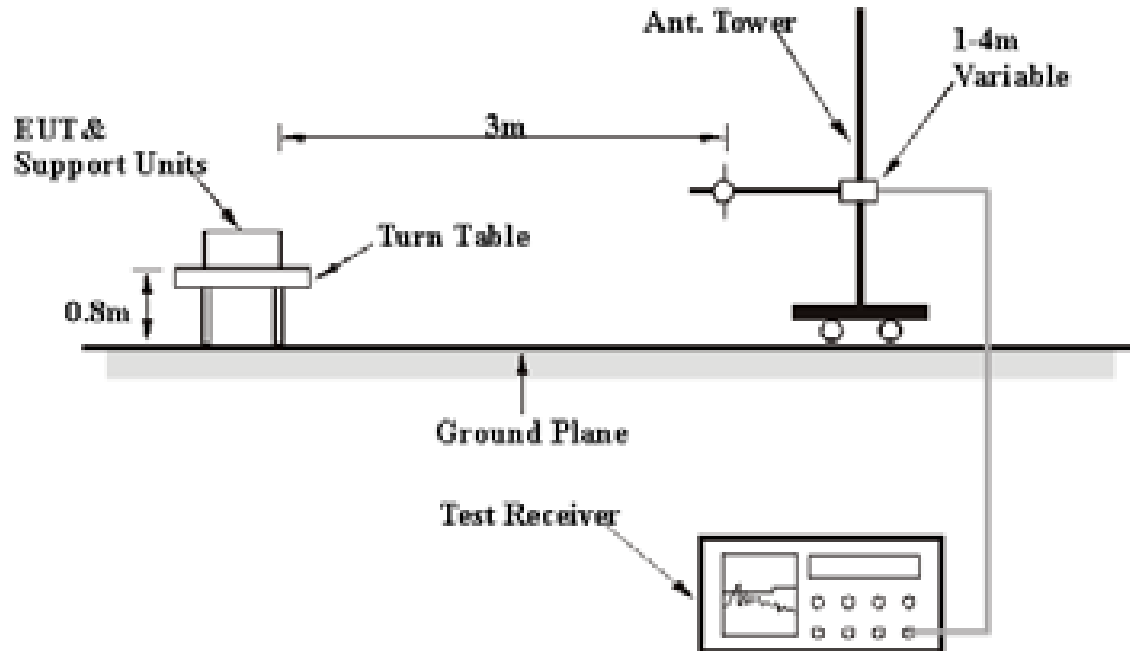

For the actual test configuration, please refer to the related item – Photographs of the Test Configuration.

#### 4.2.6 EUT OPERATING CONDITIONS

Same as 4.1.6



## 4.2.7 TEST RESULTS

<b>EUT</b>	IEEE 802.11a/g Wireless LAN Access Point	<b>MODEL</b>	AS-1250-ABG-EXT
<b>TEST MODE</b>	Channel 11, with Adapter	<b>FREQUENCY RANGE</b>	30-1000 MHz
<b>INPUT POWER (SYSTEM)</b>	120Vac, 60Hz	<b>DETECTOR FUNCTION &amp; BANDWIDTH</b>	Quasi-Peak, 120kHz
<b>ENVIRONMENTAL CONDITIONS</b>	25deg. C, 70%RH, 979 hPa	<b>TESTED BY</b>	Wen Yu

**ANTENNA POLARITY & TEST DISTANCE: HORIZONTAL AT 3 M**

No.	Freq. (MHz)	Emission Level (dBuV/m)	Limit (dBuV/m)	Margin (dB)	Antenna Height (m)	Table Angle (Degree)	Raw Value (dBuV)	Correction Factor (dB/m)
1	125.00	28.50 QP	43.50	-15.00	2.65 H	30	16.00	12.50
2	250.01	34.90 QP	46.00	-11.10	2.00 H	130	20.90	14.00
3	280.00	36.20 QP	46.00	-9.80	1.16 H	123	21.60	14.60
4	330.00	36.60 QP	46.00	-9.40	1.05 H	85	20.40	16.10
5	360.00	33.40 QP	46.00	-12.60	1.00 H	232	16.30	17.10
6	440.00	40.50 QP	46.00	-5.50	1.28 H	290	21.20	19.30
7	499.98	37.40 QP	46.00	-8.60	2.00 H	303	16.70	20.70
8	624.99	36.90 QP	46.00	-9.10	1.72 H	118	14.00	22.90
9	770.00	34.80 QP	46.00	-11.20	1.67 H	3	8.90	25.90
10	959.99	38.60 QP	46.00	-7.40	1.89 H	110	9.20	29.50

**ANTENNA POLARITY & TEST DISTANCE: VERTICAL AT 3 M**

No.	Freq. (MHz)	Emission Level (dBuV/m)	Limit (dBuV/m)	Margin (dB)	Antenna Height (m)	Table Angle (Degree)	Raw Value (dBuV)	Correction Factor (dB/m)
1	50.00	37.80 QP	40.00	-2.20	1.02 V	41	28.90	8.90
2	124.99	35.20 QP	43.50	-8.30	1.15 V	245	22.80	12.50
3	360.00	34.40 QP	46.00	-11.60	1.43 V	3	17.30	17.10
4	440.00	43.60 QP	46.00	-2.40	1.00 V	77	24.30	19.30
5	500.03	39.80 QP	46.00	-6.20	1.05 V	145	19.10	20.70
6	624.98	37.00 QP	46.00	-9.00	1.00 V	19	14.10	22.90
7	770.00	38.90 QP	46.00	-7.10	1.29 V	357	13.00	25.90
8	875.05	36.20 QP	46.00	-9.80	1.00 V	149	8.90	27.30
9	880.00	37.80 QP	46.00	-8.20	1.07 V	0	10.40	27.40
10	960.00	36.50 QP	46.00	-9.50	1.57 V	4	7.00	29.50

- REMARKS:**
1. Emission level(dBuV/m)=Raw Value(dBuV) + Correction Factor(dB)
  2. Correction Factor(dB/m) = Antenna Factor (dB/m) + Cable Factor (dB)
  3. The other emission levels were very low against the limit.
  4. Margin value = Emission level – Limit value.



<b>EUT</b>	IEEE 802.11a/g Wireless LAN Access Point	<b>MODEL</b>	AS-1250-ABG-EXT
<b>TEST MODE</b>	Channel 11, with POE	<b>FREQUENCY RANGE</b>	30-1000 MHz
<b>INPUT POWER (SYSTEM)</b>	120Vac, 60Hz	<b>DETECTOR FUNCTION &amp; BANDWIDTH</b>	Quasi-Peak, 120kHz
<b>ENVIRONMENTAL CONDITIONS</b>	28deg. C, 65%RH, 979 hPa	<b>TESTED BY</b>	Sky Liao

#### ANTENNA POLARITY & TEST DISTANCE: HORIZONTAL AT 3 M

No.	Freq. (MHz)	Emission Level (dBuV/m)	Limit (dBuV/m)	Margin (dB)	Antenna Height (m)	Table Angle (Degree)	Raw Value (dBuV)	Correction Factor (dB/m)
1	125.00	27.50 QP	43.50	-16.00	1.66 H	270	15.00	12.50
2	200.00	30.60 QP	43.50	-12.90	1.73 H	257	21.10	9.60
3	250.02	35.10 QP	46.00	-10.90	1.72 H	22	21.10	14.00
4	280.00	27.30 QP	46.00	-18.70	1.19 H	19	12.60	14.60
5	360.00	25.80 QP	46.00	-20.20	1.12 H	236	8.70	17.10
6	440.00	29.50 QP	46.00	-16.50	1.00 H	192	10.20	19.30
7	500.04	31.70 QP	46.00	-14.30	1.35 H	17	11.00	20.70
8	624.97	31.40 QP	46.00	-14.60	1.12 H	6	8.50	22.90
9	770.00	34.80 QP	46.00	-11.20	1.13 H	224	8.80	25.90
10	879.99	36.80 QP	46.00	-9.20	2.31 H	91	9.40	27.40
11	959.99	32.40 QP	46.00	-13.60	1.00 H	94	2.90	29.50

#### ANTENNA POLARITY & TEST DISTANCE: VERTICAL AT 3 M

No.	Freq. (MHz)	Emission Level (dBuV/m)	Limit (dBuV/m)	Margin (dB)	Antenna Height (m)	Table Angle (Degree)	Raw Value (dBuV)	Correction Factor (dB/m)
1	125.00	39.50 QP	43.50	-4.00	1.03 V	204	27.10	12.50
2	360.00	27.10 QP	46.00	-18.90	1.58 V	303	10.10	17.10
3	439.99	39.30 QP	46.00	-6.70	1.23 V	319	20.00	19.30
4	499.98	35.10 QP	46.00	-10.90	1.04 V	71	14.40	20.70
5	624.98	32.30 QP	46.00	-13.70	1.73 V	1	9.40	22.90
6	640.00	32.00 QP	46.00	-14.00	1.66 V	11	8.70	23.20
7	769.99	36.20 QP	46.00	-9.80	1.52 V	144	10.20	25.90
8	875.07	33.10 QP	46.00	-12.90	1.74 V	6	5.80	27.30
9	879.99	35.10 QP	46.00	-10.90	1.84 V	358	7.70	27.40
10	960.00	31.70 QP	54.00	-22.30	1.66 V	65	2.20	29.50

- REMARKS:**
1. Emission level(dBuV/m)=Raw Value(dBuV) + Correction Factor(dB)
  2. Correction Factor(dB/m) = Antenna Factor (dB/m) + Cable Factor (dB)
  3. The other emission levels were very low against the limit.
  4. Margin value = Emission level – Limit value.



## 4.2.8 TEST RESULTS - DSSS

<b>EUT</b>	IEEE 802.11a/g Wireless LAN Access Point	<b>Model</b>	AS-1250-ABG-EXT
<b>MODE</b>	Channel 1	<b>FREQUENCY RANGE</b>	1000MHz~25000MHz
<b>INPUT POWER (SYSTEM)</b>	120Vac, 60Hz	<b>DETECTOR FUNCTION &amp; BANDWIDTH</b>	Peak (PK) Average (AV) 1 MHz
<b>ENVIRONMENTAL CONDITIONS</b>	28deg. C, 65%RH, 979 hPa	<b>TESTED BY</b>	Sky Liao

**ANTENNA POLARITY & TEST DISTANCE: HORIZONTAL AT 3 M**

No.	Freq. (MHz)	Emission Level (dBuV/m)	Limit (dBuV/m)	Margin (dB)	Antenna Height (m)	Table Angle (Degree)	Raw Value (dBuV)	Correction Factor (dB/m)
1	2373.00	62.60 PK	74.00	-11.40	1.02 H	328	31.90	30.70
1	2373.00	43.50 AV	54.00	-10.50	1.02 H	328	12.80	30.70
2	2390.00	54.00 PK	74.00	-20.00	1.83 H	238	20.20	33.80
2	2390.00	45.80 AV	54.00	-8.20	1.83 H	238	12.00	33.80
3	*2412.00	110.50 PK			1.83 H	238	80.60	29.90
3	*2412.00	103.40 AV			1.83 H	238	73.50	29.90
4	4824.00	51.30 PK	74.00	-22.70	1.19 H	230	15.10	36.20
4	4824.00	39.00 AV	54.00	-15.00	1.19 H	230	2.70	36.20
5	7236.00	50.40 PK	74.00	-23.60	1.12 H	267	8.80	41.70
6	9648.00	53.30 PK	74.00	-20.70	1.09 H	12	8.40	44.90
6	9648.00	45.20 AV	54.00	-8.80	1.09 H	12	0.30	44.90

**ANTENNA POLARITY & TEST DISTANCE: VERTICAL AT 3 M**

No.	Freq. (MHz)	Emission Level (dBuV/m)	Limit (dBuV/m)	Margin (dB)	Antenna Height (m)	Table Angle (Degree)	Raw Value (dBuV)	Correction Factor (dB/m)
1	2373.00	63.80 PK	74.00	-10.20	1.10 V	298	33.10	30.70
1	2373.00	47.90 AV	54.00	-6.10	1.10 V	298	17.20	30.70
2	2390.00	62.40 PK	74.00	-11.60	1.58 V	237	28.60	33.80
2	2390.00	50.10 AV	54.00	-3.90	1.58 V	237	16.30	33.80
3	*2412.00	115.10 PK			1.58 V	237	85.20	29.90
3	*2412.00	107.70 AV			1.58 V	237	77.80	29.90
4	4824.00	51.60 PK	74.00	-22.40	1.22 V	251	15.30	36.20
4	4824.00	40.10 AV	54.00	-13.90	1.22 V	251	3.80	36.20
5	7236.00	49.90 PK	74.00	-24.10	1.32 V	219	8.20	41.70
6	9648.00	52.00 PK	74.00	-22.00	1.67 V	111	7.10	44.90
6	9648.00	42.40 AV	54.00	-11.60	1.67 V	111	-2.50	44.90

- NOTE:**
1. Emission level(dBuV/m)=Raw Value(dBuV) + Correction Factor(dB)
  2. Correction Factor(dB/m) = Antenna Factor (dB/m) + Cable Factor (dB)
  3. The other emission levels were very low against the limit.
  4. Margin value = Emission level – Limit value.
  5. The limit value is defined as per 15.247
  6. “ \* “ : Fundamental frequency



<b>EUT</b>	IEEE 802.11a/g Wireless LAN Access Point	<b>MODEL</b>	AS-1250-ABG-EXT
<b>MODE</b>	Channel 6	<b>FREQUENCY RANGE</b>	1000MHz~25000MHz
<b>INPUT POWER (SYSTEM)</b>	120Vac, 60Hz	<b>DETECTOR FUNCTION &amp; BANDWIDTH</b>	Peak (PK) Average (AV) 1 MHz
<b>ENVIRONMENTAL CONDITIONS</b>	28deg. C, 65%RH, 979 hPa	<b>TESTED BY</b>	Sky Liao

#### ANTENNA POLARITY & TEST DISTANCE: HORIZONTAL AT 3 M

No.	Freq. (MHz)	Emission Level (dBuV/m)	Limit (dBuV/m)	Margin (dB)	Antenna Height (m)	Table Angle (Degree)	Raw Value (dBuV)	Correction Factor (dB/m)
1	*2437.00	111.00 PK			1.78 H	236	81.00	30.00
1	*2437.00	104.30 AV			1.78 H	236	74.30	30.00
2	4874.00	50.60 PK	74.00	-23.40	1.35 H	236	14.10	36.50
3	7311.00	49.60 PK	74.00	-24.40	1.41 H	290	7.80	41.80
4	9748.00	52.90 PK	74.00	-21.10	1.49 H	113	8.30	44.60
4	9748.00	42.60 AV	54.00	-11.40	1.49 H	113	-2.10	44.60

#### ANTENNA POLARITY & TEST DISTANCE: VERTICAL AT 3 M

No.	Freq. (MHz)	Emission Level (dBuV/m)	Limit (dBuV/m)	Margin (dB)	Antenna Height (m)	Table Angle (Degree)	Raw Value (dBuV)	Correction Factor (dB/m)
1	*2437.00	115.30 PK			1.58 V	262	85.30	30.00
1	*2437.00	106.90 AV			1.58 V	262	76.90	30.00
2	4874.00	51.10 PK	74.00	-22.90	1.21 V	246	14.60	36.50
2	4874.00	41.50 AV	54.00	-12.50	1.21 V	246	5.00	36.50
3	7311.00	49.80 PK	74.00	-24.20	1.40 V	229	8.00	41.80
4	9748.00	53.00 PK	74.00	-21.00	1.47 V	111	8.40	44.60
4	9748.00	42.80 AV	54.00	-11.20	1.47 V	111	-1.80	44.60

- NOTE:**
1. Emission level(dBuV/m)=Raw Value(dBuV) + Correction Factor(dB)
  2. Correction Factor(dB/m) = Antenna Factor (dB/m) + Cable Factor (dB)
  3. The other emission levels were very low against the limit.
  4. Margin value = Emission level – Limit value.
  5. The limit value is defined as per 15.247
  6. “ \* “ : Fundamental frequency





<b>EUT</b>	IEEE 802.11a/g Wireless LAN Access Point	<b>MODEL</b>	AS-1250-ABG-EXT
<b>MODE</b>	Channel 11	<b>FREQUENCY RANGE</b>	1000MHz~25000MHz
<b>INPUT POWER (SYSTEM)</b>	120Vac, 60Hz	<b>DETECTOR FUNCTION &amp; BANDWIDTH</b>	Peak (PK) Average (AV) 1 MHz
<b>ENVIRONMENTAL CONDITIONS</b>	28deg. C, 65%RH, 979 hPa	<b>TESTED BY</b>	Sky Liao

#### ANTENNA POLARITY & TEST DISTANCE: HORIZONTAL AT 3M

No.	Freq. (MHz)	Emission Level (dBuV/m)	Limit (dBuV/m)	Margin (dB)	Antenna Height (m)	Table Angle (Degree)	Raw Value (dBuV)	Correction Factor (dB/m)
1	*2462.00	111.90 PK			1.75 H	233	81.80	30.10
1	*2462.00	104.50 AV			1.75 H	233	74.40	30.10
2	2483.50	54.60 PK	74.00	-19.40	1.75 H	233	24.40	30.10
2	2483.50	46.30 AV	54.00	-7.70	1.75 H	233	16.10	30.10
3	2500.00	55.50 PK	74.00	-18.50	1.56 H	264	25.00	30.50
3	2500.00	46.80 AV	54.00	-7.20	1.56 H	264	16.30	30.50
4	4924.00	50.20 PK	74.00	-23.80	1.31 H	289	13.50	36.70
5	7386.00	51.10 PK	74.00	-22.90	1.03 H	236	9.30	41.80
5	7386.00	40.60 AV	54.00	-13.40	1.03 H	236	-1.20	41.80
6	9848.00	55.10 PK	74.00	-18.90	1.51 H	207	10.70	44.40
6	9848.00	48.00 AV	54.00	-6.00	1.51 H	207	3.60	44.40

#### ANTENNA POLARITY & TEST DISTANCE: VERTICAL AT 3M

No.	Freq. (MHz)	Emission Level (dBuV/m)	Limit (dBuV/m)	Margin (dB)	Antenna Height (m)	Table Angle (Degree)	Raw Value (dBuV)	Correction Factor (dB/m)
1	*2462.00	115.80 PK			1.44 V	260	85.70	30.10
1	*2462.00	108.20 AV			1.44 V	260	78.20	30.10
2	2483.50	58.30 PK	74.00	-15.70	1.44 V	260	28.10	30.10
2	2483.50	50.00 AV	54.00	-4.00	1.44 V	260	19.80	30.10
3	2500.00	63.50 PK	74.00	-10.50	1.34 V	283	33.00	30.50
3	2500.00	50.90 AV	54.00	-3.10	1.34 V	283	20.40	30.50
4	4924.00	52.80 PK	74.00	-21.20	1.22 V	225	16.10	36.70
4	4924.00	41.10 AV	54.00	-12.90	1.22 V	225	4.40	36.70
5	7386.00	51.20 PK	74.00	-22.80	1.30 V	256	9.40	41.80
5	7386.00	40.20 AV	54.00	-13.80	1.30 V	256	-1.70	41.80
6	9848.00	54.70 PK	74.00	-19.30	1.36 V	295	10.30	44.40
6	9848.00	46.00 AV	54.00	-8.00	1.36 V	295	1.60	44.40

- NOTE:**
1. Emission level(dBuV/m)=Raw Value(dBuV) + Correction Factor(dB)
  2. Correction Factor(dB/m) = Antenna Factor (dB/m) + Cable Factor (dB)
  3. The other emission levels were very low against the limit.
  4. Margin value = Emission level – Limit value.
  5. The limit value is defined as per 15.247
  6. " \* " : Fundamental frequency



## 4.2.9 TEST RESULTS - OFDM

<b>EUT</b>	IEEE 802.11a/g Wireless LAN Access Point	<b>MODEL</b>	AS-1250-ABG-EXT
<b>MODE</b>	Channel 1	<b>FREQUENCY RANGE</b>	1000MHz~25000MHz
<b>INPUT POWER (SYSTEM)</b>	120Vac, 60Hz	<b>DETECTOR FUNCTION &amp; BANDWIDTH</b>	Peak (PK) Average (AV) 1 MHz
<b>ENVIRONMENTAL CONDITIONS</b>	28deg. C, 65%RH, 979 hPa	<b>TESTED BY</b>	Sky Liao

**ANTENNA POLARITY & TEST DISTANCE: HORIZONTAL AT 3 M**

No.	Freq. (MHz)	Emission Level (dBuV/m)	Limit (dBuV/m)	Margin (dB)	Antenna Height (m)	Table Angle (Degree)	Raw Value (dBuV)	Correction Factor (dB/m)
1	2378.00	49.50 PK	74.00	-24.50	1.00 H	342	18.80	30.70
2	2390.00	48.80 PK	74.00	-25.20	1.46 H	14	15.00	33.80
3	*2412.00	97.40 PK			1.46 H	14	67.50	29.90
3	*2412.00	89.40 AV			1.46 H	14	59.50	29.90
4	4824.00	50.30 PK	74.00	-23.70	1.33 H	343	14.10	36.20
5	7236.00	50.10 PK	74.00	-23.90	1.52 H	264	8.40	41.70
6	9648.00	52.40 PK	74.00	-21.60	1.24 H	340	7.50	44.90
6	9648.00	41.00 AV	54.00	-13.00	1.24 H	340	-3.90	44.90

**ANTENNA POLARITY & TEST DISTANCE: VERTICAL AT 3 M**

No.	Freq. (MHz)	Emission Level (dBuV/m)	Limit (dBuV/m)	Margin (dB)	Antenna Height (m)	Table Angle (Degree)	Raw Value (dBuV)	Correction Factor (dB/m)
1	2378.00	59.30 PK	74.00	-14.70	1.57 V	109	28.60	30.70
1	2378.00	44.80 AV	54.00	-9.20	1.57 V	109	14.10	30.70
2	2390.00	61.20 PK	74.00	-12.80	1.34 V	81	27.40	33.80
2	<b>2390.00</b>	<b>53.00 AV</b>	<b>54.00</b>	<b>-1.00</b>	<b>1.34 V</b>	<b>81</b>	<b>19.20</b>	<b>33.80</b>
3	*2412.00	110.10 PK			1.34 V	81	80.20	29.90
3	*2412.00	101.90 AV			1.34 V	81	72.00	29.90
4	4824.00	49.20 PK	74.00	-24.80	1.22 V	235	13.00	36.20
5	7236.00	49.60 PK	74.00	-24.40	1.36 V	252	7.90	41.70
6	9648.00	52.60 PK	74.00	-21.40	1.32 V	33	7.70	44.90
6	9648.00	39.90 AV	54.00	-14.10	1.32 V	33	-5.00	44.90

- NOTE:**
1. Emission level(dBuV/m)=Raw Value(dBuV) + Correction Factor(dB)
  2. Correction Factor(dB/m) = Antenna Factor (dB/m) + Cable Factor (dB)
  3. The other emission levels were very low against the limit.
  4. Margin value = Emission level – Limit value.
  5. The limit value is defined as per 15.247
  6. “ \* “ : Fundamental frequency



<b>EUT</b>	IEEE 802.11a/g Wireless LAN Access Point	<b>MODEL</b>	AS-1250-ABG-EXT
<b>MODE</b>	Channel 6	<b>FREQUENCY RANGE</b>	1000MHz~25000MHz
<b>INPUT POWER (SYSTEM)</b>	120Vac, 60Hz	<b>DETECTOR FUNCTION &amp; BANDWIDTH</b>	Peak (PK) Average (AV) 1 MHz
<b>ENVIRONMENTAL CONDITIONS</b>	28deg. C, 65%RH, 979 hPa	<b>TESTED BY</b>	Sky Liao

#### ANTENNA POLARITY & TEST DISTANCE: HORIZONTAL AT 3 M

No.	Freq. (MHz)	Emission Level (dBuV/m)	Limit (dBuV/m)	Margin (dB)	Antenna Height (m)	Table Angle (Degree)	Raw Value (dBuV)	Correction Factor (dB/m)
1	*2437.00	98.70 PK			1.00 H	23	68.80	30.00
1	*2437.00	90.80 AV			1.00 H	23	60.80	30.00
2	4874.00	47.50 PK	74.00	-26.50	1.17 H	336	11.00	36.50
3	7311.00	49.50 PK	74.00	-24.50	1.31 H	216	7.70	41.80
4	9748.00	52.60 PK	74.00	-21.40	1.45 H	302	8.00	44.60
4	9748.00	41.60 AV	54.00	-12.40	1.45 H	302	-3.00	44.60

#### ANTENNA POLARITY & TEST DISTANCE: VERTICAL AT 3 M

No.	Freq. (MHz)	Emission Level (dBuV/m)	Limit (dBuV/m)	Margin (dB)	Antenna Height (m)	Table Angle (Degree)	Raw Value (dBuV)	Correction Factor (dB/m)
1	*2437.00	111.50 PK			1.06 V	76	81.50	30.00
1	*2437.00	103.00 AV			1.06 V	76	73.10	30.00
2	4874.00	50.60 PK	74.00	-23.40	1.20 V	228	14.20	36.50
3	7311.00	49.90 PK	74.00	-24.10	1.73 V	286	8.20	41.80
4	9748.00	51.70 PK	74.00	-22.30	1.29 V	242	7.00	44.60
4	9748.00	40.80 AV	54.00	-13.20	1.29 V	242	-3.90	44.60

- NOTE:**
1. Emission level(dBuV/m)=Raw Value(dBuV) + Correction Factor(dB)
  2. Correction Factor(dB/m) = Antenna Factor (dB/m) + Cable Factor (dB)
  3. The other emission levels were very low against the limit.
  4. Margin value = Emission level – Limit value.
  5. The limit value is defined as per 15.247
  6. “ \* ” : Fundamental frequency



<b>EUT</b>	IEEE 802.11a/g Wireless LAN Access Point	<b>MODEL</b>	AS-1250-ABG-EXT
<b>MODE</b>	Channel 11	<b>FREQUENCY RANGE</b>	1000MHz~25000MHz
<b>INPUT POWER (SYSTEM)</b>	120Vac, 60Hz	<b>DETECTOR FUNCTION &amp; BANDWIDTH</b>	Peak (PK) Average (AV) 1 MHz
<b>ENVIRONMENTAL CONDITIONS</b>	28deg. C, 65%RH, 979 hPa	<b>TESTED BY</b>	Sky Liao

#### ANTENNA POLARITY & TEST DISTANCE: HORIZONTAL AT 3M

No.	Freq. (MHz)	Emission Level (dBuV/m)	Limit (dBuV/m)	Margin (dB)	Antenna Height (m)	Table Angle (Degree)	Raw Value (dBuV)	Correction Factor (dB/m)
1	*2462.00	96.40 PK			1.46 H	28	66.30	30.10
1	*2462.00	89.00 AV			1.46 H	28	59.00	30.10
2	2483.50	47.90 PK	74.00	-26.10	1.46 H	28	17.70	30.10
3	2495.00	47.50 PK	74.00	-26.50	1.58 H	5	14.10	33.30
4	2500.00	46.70 PK	74.00	-27.30	1.27 H	67	16.20	30.50
5	4924.00	45.30 PK	74.00	-28.70	1.33 H	172	8.60	36.70
6	7386.00	49.50 PK	74.00	-24.50	1.26 H	216	7.70	41.80
7	9848.00	51.40 PK	74.00	-22.60	1.45 H	330	7.10	44.40
7	9848.00	40.90 AV	54.00	-13.10	1.45 H	330	-3.40	44.40

#### ANTENNA POLARITY & TEST DISTANCE: VERTICAL AT 3M

No.	Freq. (MHz)	Emission Level (dBuV/m)	Limit (dBuV/m)	Margin (dB)	Antenna Height (m)	Table Angle (Degree)	Raw Value (dBuV)	Correction Factor (dB/m)
1	*2462.00	110.20 PK			1.32 V	78	80.10	30.10
1	*2462.00	102.00 AV			1.32 V	78	71.90	30.10
2	2483.50	60.70 PK	74.00	-13.30	1.32 V	78	30.50	30.10
2	2483.50	52.50 AV	54.00	-1.50	1.32 V	78	22.40	30.10
3	2495.00	59.30 PK	74.00	-14.70	1.26 V	48	26.00	33.30
3	2495.00	50.50 AV	54.00	-3.50	1.26 V	48	17.20	33.30
4	2500.00	60.00 PK	74.00	-14.00	1.35 V	64	29.50	30.50
4	2500.00	51.80 AV	54.00	-2.20	1.35 V	64	21.30	30.50
5	4924.00	46.70 PK	74.00	-27.30	1.32 V	236	10.00	36.70
6	7386.00	50.00 PK	74.00	-24.00	1.53 V	247	8.10	41.80
7	9848.00	52.10 PK	74.00	-21.90	1.33 V	286	7.80	44.40
7	9848.00	40.80 AV	54.00	-13.20	1.33 V	286	-3.50	44.40

- NOTE:**
1. Emission level(dBuV/m)=Raw Value(dBuV) + Correction Factor(dB)
  2. Correction Factor(dB/m) = Antenna Factor (dB/m) + Cable Factor (dB)
  3. The other emission levels were very low against the limit.
  4. Margin value = Emission level – Limit value.
  5. The limit value is defined as per 15.247
  6. “ \* “ : Fundamental frequency



### 4.3 6dB BANDWIDTH MEASUREMENT

#### 4.3.1 LIMITS OF 6dB BANDWIDTH MEASUREMENT

The minimum of 6dB Bandwidth Measurement is 0.5 MHz.

#### 4.3.2 TEST INSTRUMENTS

Description & Manufacturer	Model No.	Serial No.	Calibrated Until
R&S SPECTRUM ANALYZER	FSP40	100037	May. 06, 2005

**Note:**

1. The measurement uncertainty is 226Hz, which is calculated as per the document ETSI TR 100 028.
2. The calibration interval of the above test instruments is 12 months and the calibrations are traceable to NML/ROC and NIST/USA.



### 4.3.3 TEST PROCEDURE

The transmitter output was connected to the spectrum analyzer through an attenuator. The bandwidth of the fundamental frequency was measured by spectrum analyzer with 100kHz RBW and 100kHz VBW. The 6dB bandwidth is defined as the total spectrum the power of which is higher than peak power minus 6 dB.

### 4.3.4 DEVIATION FROM TEST STANDARD

No deviation

### 4.3.5 TEST SETUP

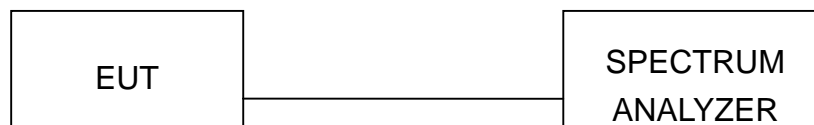

### 4.3.6 EUT OPERATING CONDITIONS

The software provided by client to enable the EUT under transmission condition continuously at lowest, middle and highest channel frequencies individually.



## 4.3.7 TEST RESULTS -DSSS

<b>EUT</b>	IEEE 802.11a/g Wireless LAN Access Point		
<b>MODEL</b>	AS-1250-ABG-EXT	<b>ENVIRONMENTAL CONDITIONS</b>	28deg. C, 65%RH, 979 hPa
<b>INPUT POWER (SYSTEM)</b>	120Vac, 60Hz	<b>TESTED BY</b>	Sky Liao

<b>CHANNEL</b>	<b>CHANNEL FREQUENCY (MHz)</b>	<b>6dB BANDWIDTH (MHz)</b>	<b>MINIMUM LIMIT (MHz)</b>	<b>PASS/FAIL</b>
1	2412	11.55	0.5	PASS
6	2437	11.69	0.5	PASS
11	2462	12.04	0.5	PASS



CH1

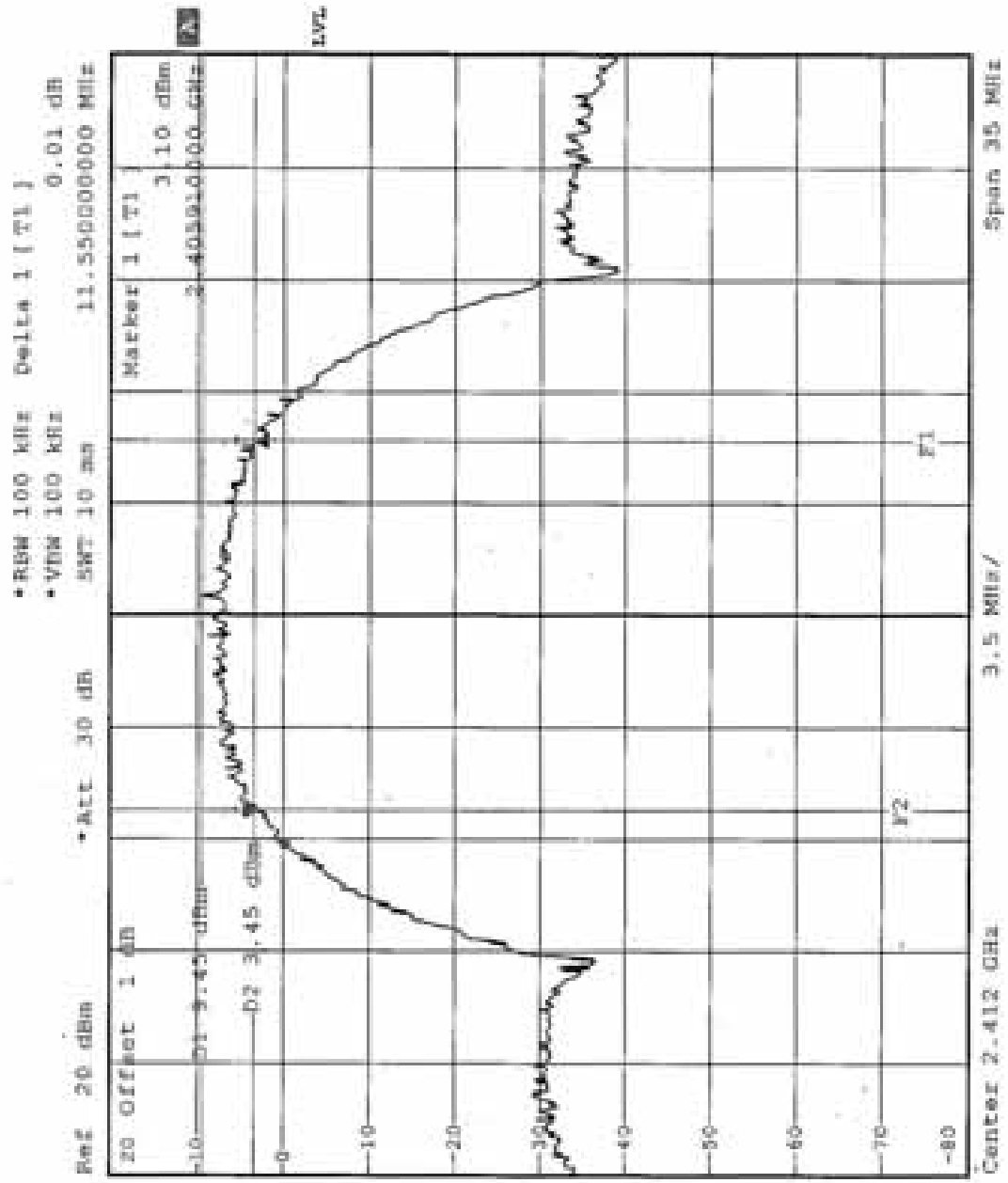





CH6

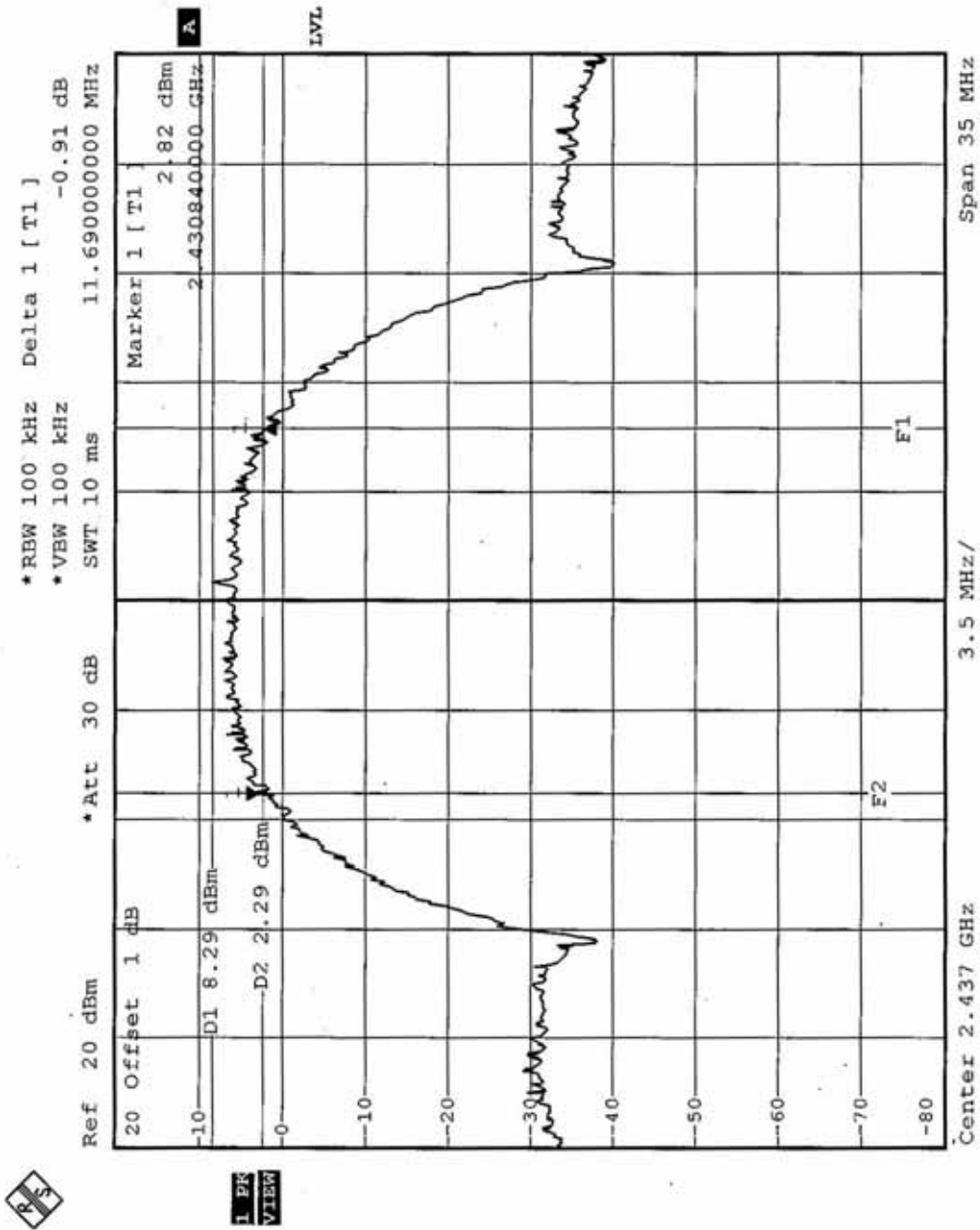



CH11

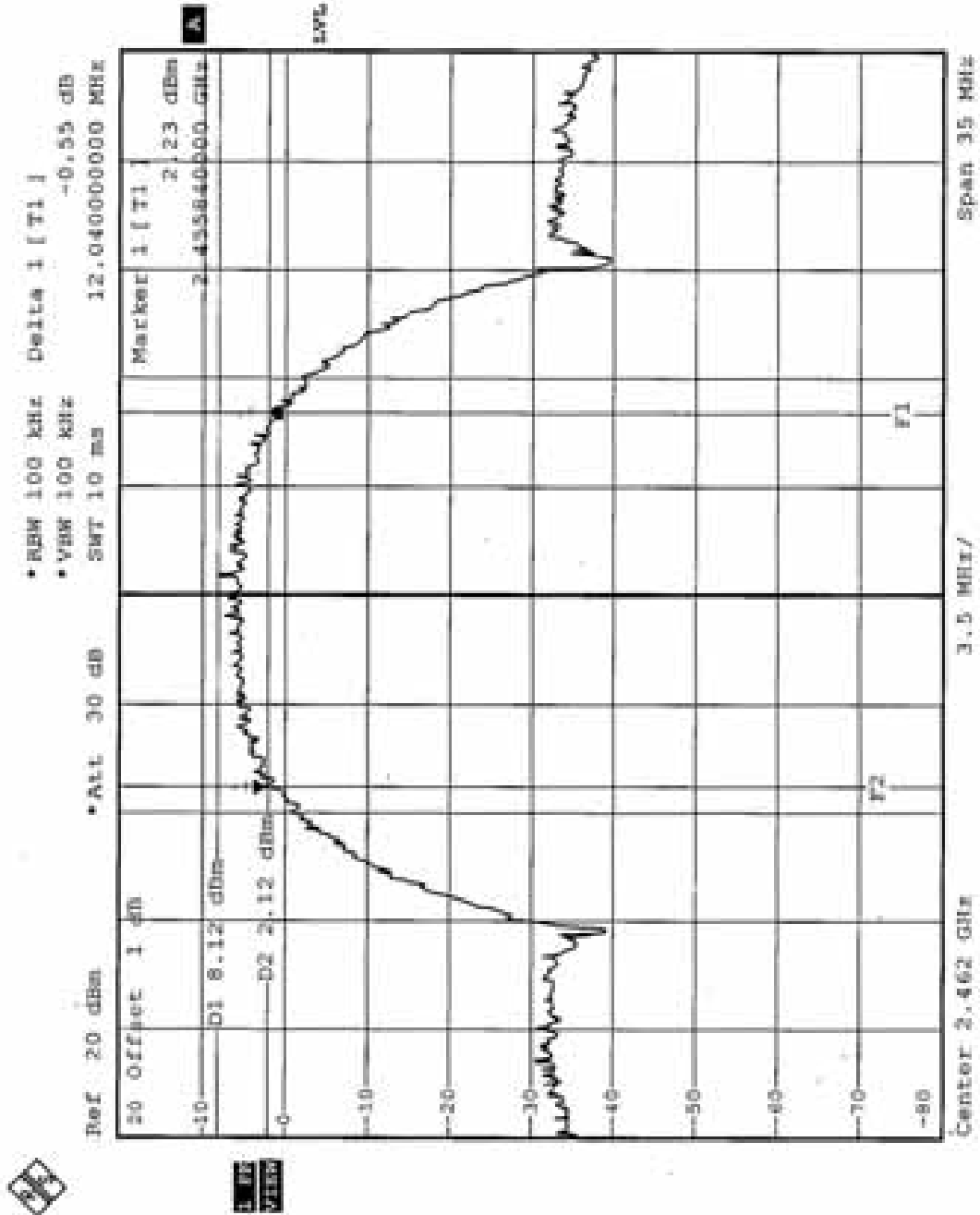



## 4.3.8 TEST RESULTS -OFDM

<b>EUT</b>	IEEE 802.11a/g Wireless LAN Access Point		
<b>MODEL</b>	AS-1250-ABG-EXT	<b>ENVIRONMENTAL CONDITIONS</b>	28deg. C, 65%RH, 979 hPa
<b>INPUT POWER (SYSTEM)</b>	120Vac, 60Hz	<b>TESTED BY</b>	Sky Liao

<b>CHANNEL</b>	<b>CHANNEL FREQUENCY (MHz)</b>	<b>6dB BANDWIDTH (MHz)</b>	<b>MINIMUM LIMIT (MHz)</b>	<b>PASS/FAIL</b>
1	2412	16.50	0.5	PASS
6	2437	16.50	0.5	PASS
11	2462	16.55	0.5	PASS



CH1

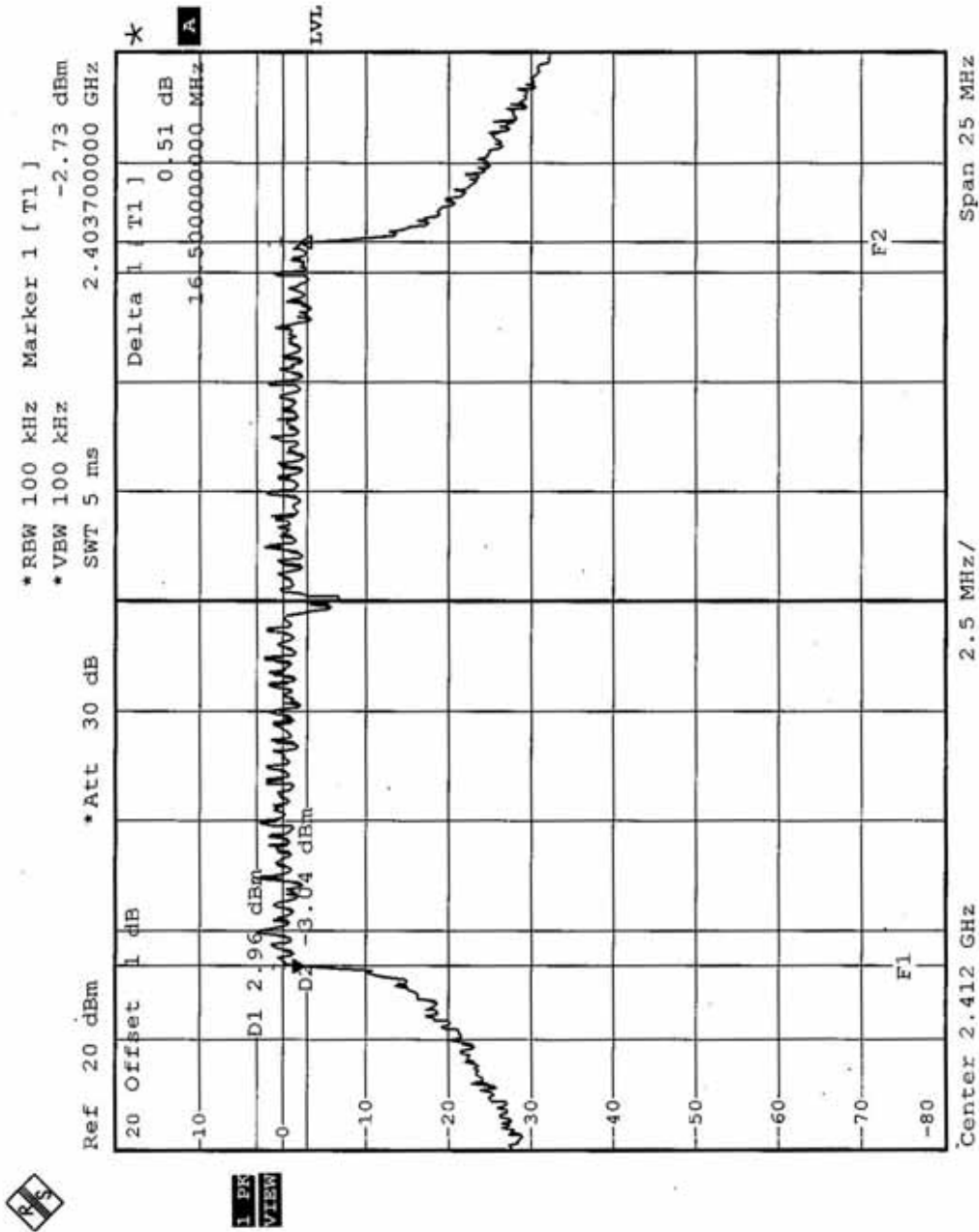



CH6

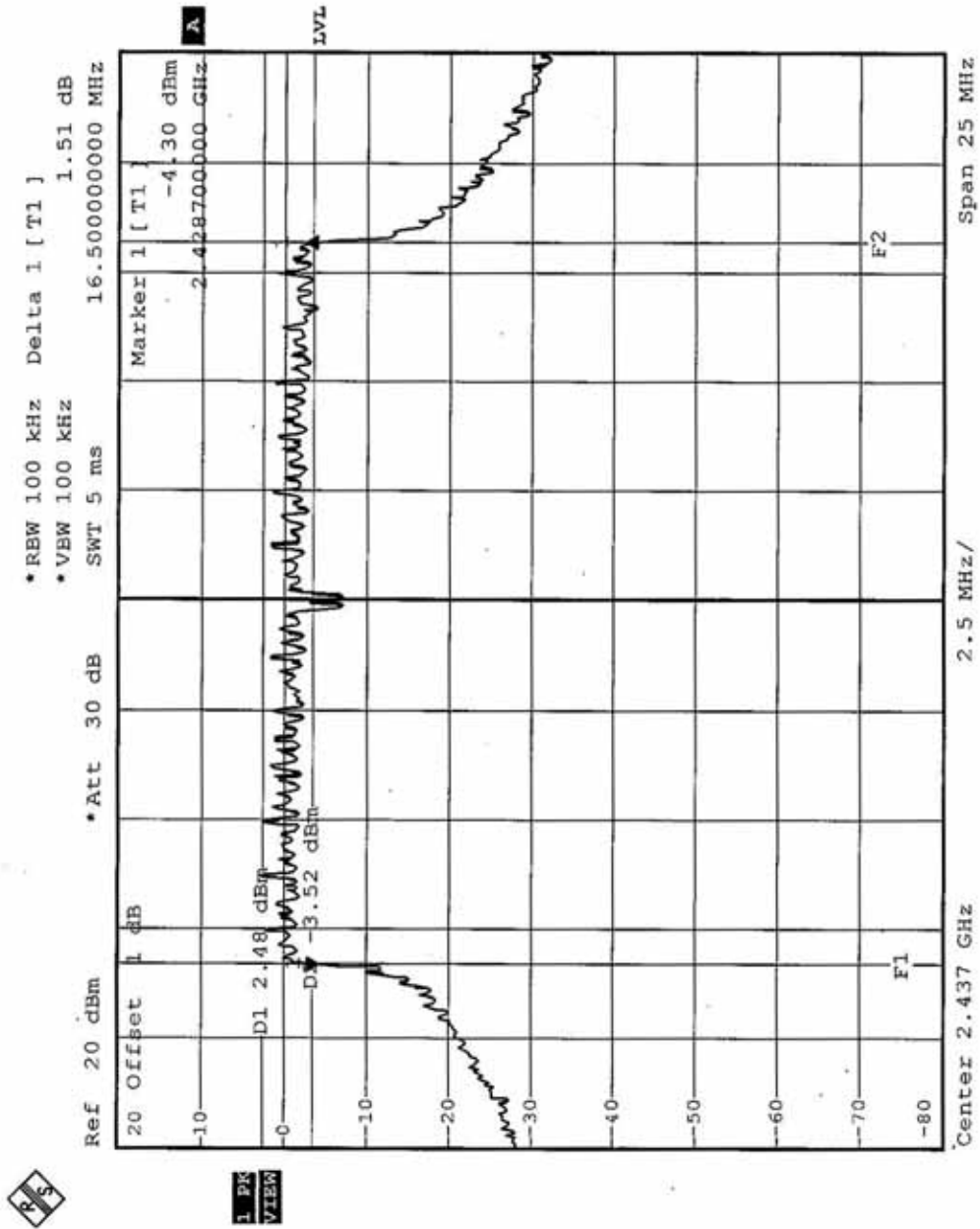



CH11

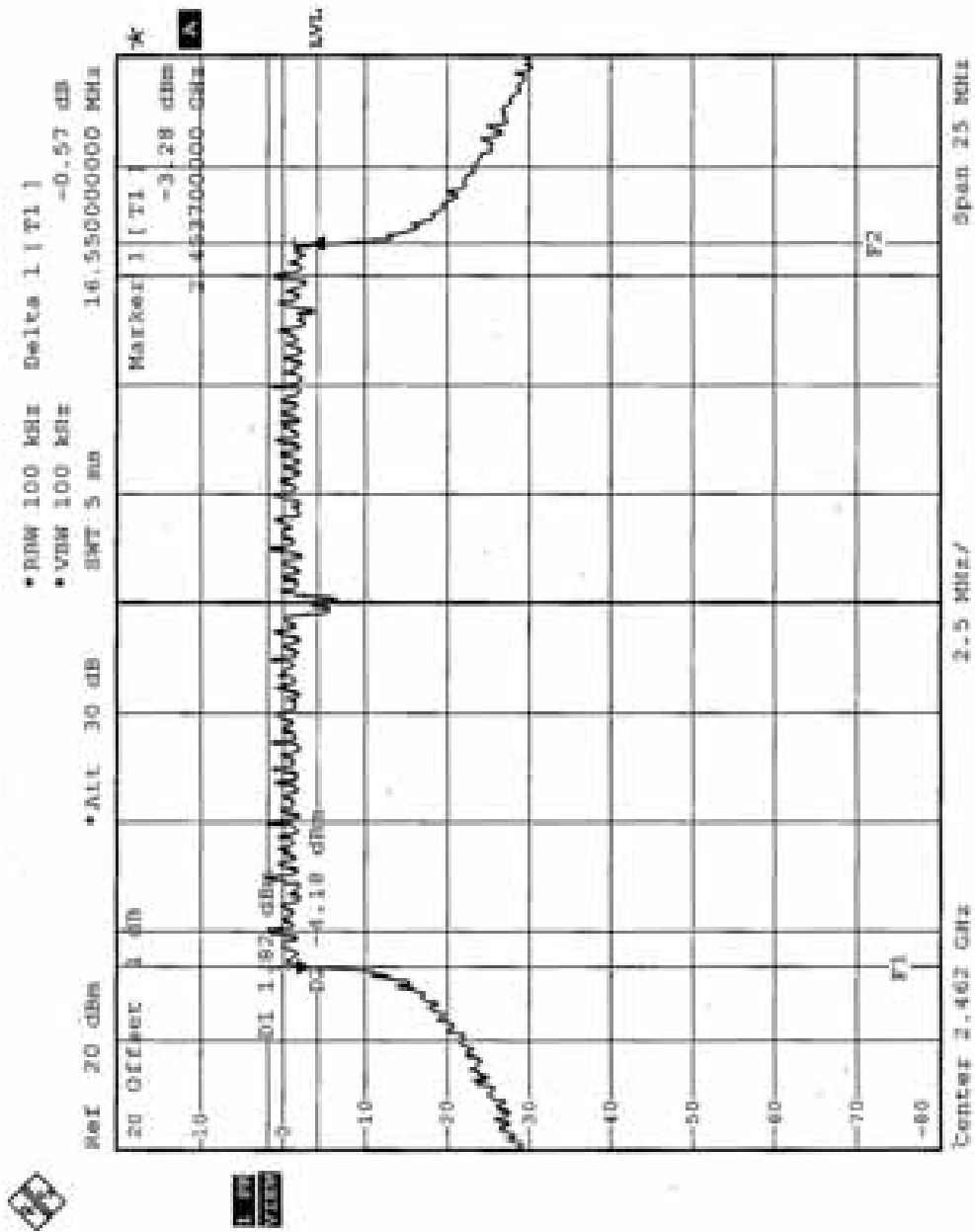



## 4.4 MAXIMUM PEAK OUTPUT POWER

### 4.4.1 LIMITS OF MAXIMUM PEAK OUTPUT POWER MEASUREMENT

The Maximum Peak Output Power Measurement is 30dBm.

**Note:**

1. If transmitting antennas of directional gain greater than 6 dBi are used, the peak output power from the intentional radiator shall be reduced below the stated values as appropriate, by the amount in dB that the directional gain of the antenna exceeds 6 dBi.
2. Systems operating in the 2400-2483.5 MHz band that are used exclusively for fixed, point-to-point operations may employ transmitting antennas with directional gain greater than 6 dBi provided the maximum peak output power of the intentional radiator is reduced by 1 dB for every 3 dB that the directional gain of the antenna exceeds 6 dBi.

### 4.4.2 INSTRUMENTS

Description & Manufacturer	Model No.	Serial No.	Calibrated Until
R&S SPECTRUM ANALYZER	FSP40	100037	May 06, 2005
R&S SIGNAL GENERATOR	SMP04	100011	May 28, 2005
TEKTRONIX OSCILLOSCOPE	TDS 220	B027241	Jun. 29, 2005
NARDA DETECTOR	4503A	FSCM99899	NA

**Note:**

1. The measurement uncertainty is 1.25dB, which is calculated as per the document ETSI TR 100 028.
2. The calibration interval of the above test instruments is 12 months and the calibrations are traceable to NML/ROC and NIST/USA.



#### 4.4.3 TEST PROCEDURES

1. A detector was used on the output port of the EUT. An oscilloscope was used to read the peak response of the detector.
2. Replaced the EUT by the signal generator. The center frequency of the S.G was adjusted to the center frequency of the measured channel.
3. Adjusted the power to have the same peak reading on oscilloscope. Record the power level.

#### 4.4.4 TEST SETUP

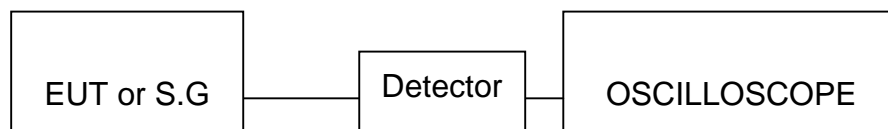

#### 4.4.5 EUT OPERATING CONDITIONS

Same as Item 4.3.6





## 4.4.6 TEST RESULTS -DSSS

<b>EUT</b>	IEEE 802.11a/g Wireless LAN Access Point		
<b>INPUT POWER (SYSTEM)</b>	120Vac, 60Hz	<b>MODEL</b>	AS-1250-ABG-EXT
<b>TESTED BY</b>	Sky Liao	<b>ENVIRONMENTAL CONDITIONS</b>	28deg. C, 65%RH, 979 hPa

**Antenna Gain 7.8 dBi**

<b>CHANNEL</b>	<b>CHANNEL FREQUENCY (MHz)</b>	<b>PEAK POWER OUTPUT (dBm)</b>	<b>PEAK POWER LIMIT (dBm)</b>	<b>PASS/FAIL</b>
1	2412	21.17	28.2	PASS
6	2437	20.66	28.2	PASS
11	2462	20.41	28.2	PASS



## 4.4.7 TEST RESULTS -OFDM

<b>EUT</b>	IEEE 802.11a/g Wireless LAN Access Point		
<b>INPUT POWER (SYSTEM)</b>	120Vac, 60Hz	<b>MODEL</b>	AS-1250-ABG-EXT
<b>TESTED BY</b>	Sky Liao	<b>ENVIRONMENTAL CONDITIONS</b>	28deg. C, 65%RH, 979 hPa

**Antenna Gain 7.8 dBi**

<b>CHANNEL</b>	<b>CHANNEL FREQUENCY (MHz)</b>	<b>PEAK POWER OUTPUT (dBm)</b>	<b>PEAK POWER LIMIT (dBm)</b>	<b>PASS/FAIL</b>
1	2412	20.97	28.2	PASS
6	2437	20.55	28.2	PASS
11	2462	20.47	28.2	PASS



## 4.5 POWER SPECTRAL DENSITY MEASUREMENT

### 4.5.1 LIMITS OF POWER SPECTRAL DENSITY MEASUREMENT

The Maximum of Power Spectral Density Measurement is 8dBm.

### 4.5.2 TEST INSTRUMENTS

Description & Manufacturer	Model No.	Serial No.	Calibrated Until
R&S SPECTRUM ANALYZER	FSP40	100037	May. 06, 2005

**Note:**

1. The measurement uncertainty is 1.02dB, which is calculated as per the document ETSI TR 100 028.
2. The calibration interval of the above test instruments is 12 months and the calibrations are traceable to NML/ROC and NIST/USA.



#### 4.5.3 TEST PROCEDURE

The transmitter output was connected to the spectrum analyzer through an attenuator, the bandwidth of the fundamental frequency was measured with the spectrum analyzer using 3 kHz RBW and 30 kHz VBW, set sweep time = span/3 kHz. The power spectral density was measured and recorded.

The sweep time is allowed to be longer than span/3 kHz for a full response of the mixer in the spectrum analyzer.

#### 4.5.4 DEVIATION FROM TEST STANDARD

No deviation

#### 4.5.5 TEST SETUP

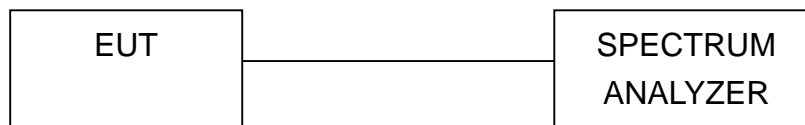

#### 4.5.6 EUT OPERATING CONDITION

Same as Item 4.3.6



## 4.5.7 TEST RESULTS-DSSS

<b>EUT</b>	IEEE 802.11a/g Wireless LAN Access Point		
<b>INPUT POWER (SYSTEM)</b>	120Vac, 60Hz	<b>MODEL</b>	AS-1250-ABG-EXT
<b>TESTED BY</b>	Sky Liao	<b>ENVIRONMENTAL CONDITIONS</b>	28deg. C, 65%RH, 979 hPa

<b>CHANNEL NUMBER</b>	<b>CHANNEL FREQUENCY (MHz )</b>	<b>RF POWER LEVEL IN 3 kHz BW (dBm)</b>	<b>MAXIMUM LIMIT (dBm)</b>	<b>PASS/FAIL</b>
1	2412	-2.29	8	PASS
6	2437	-2.51	8	PASS
11	2462	-4.26	8	PASS



CH1

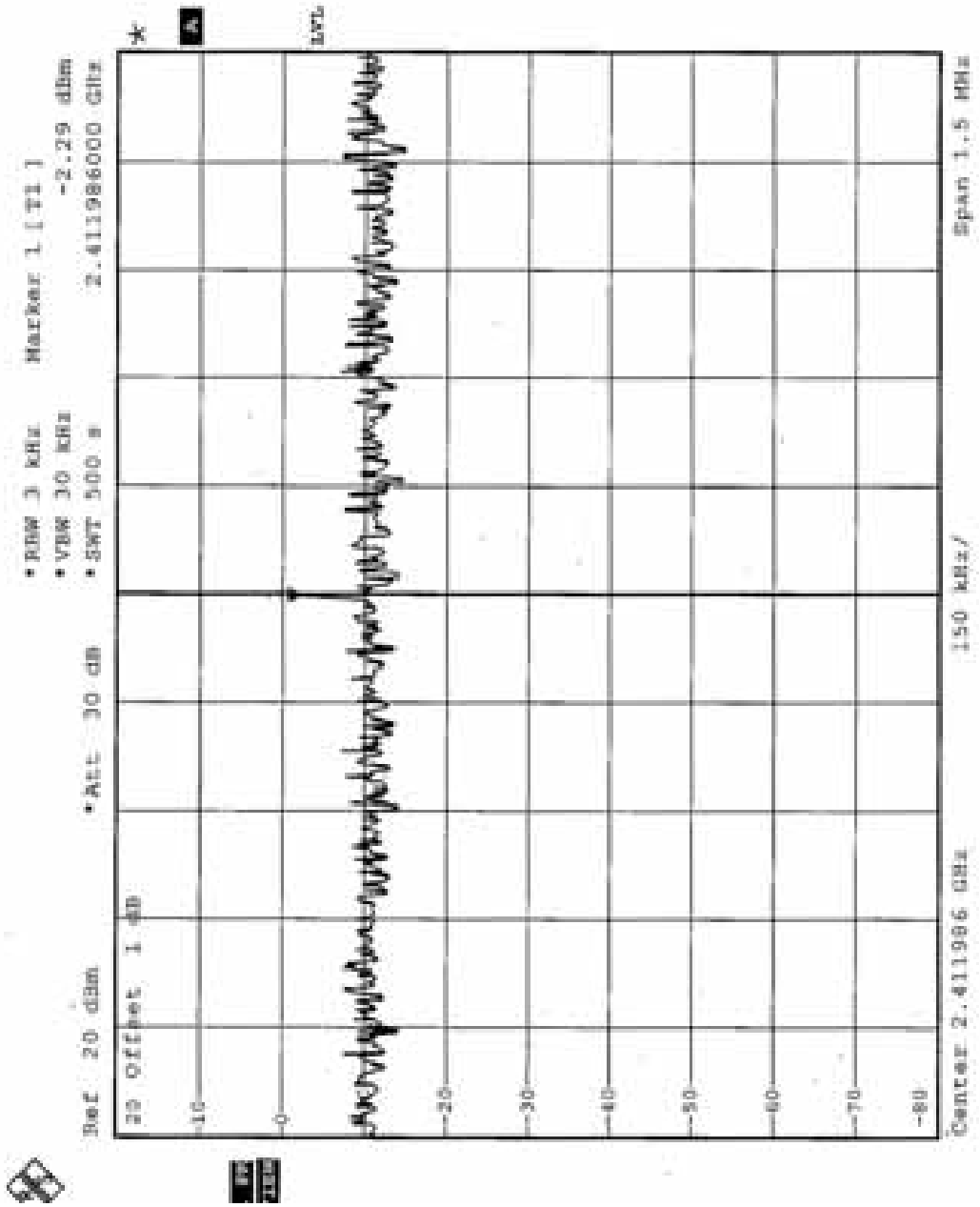



CH6

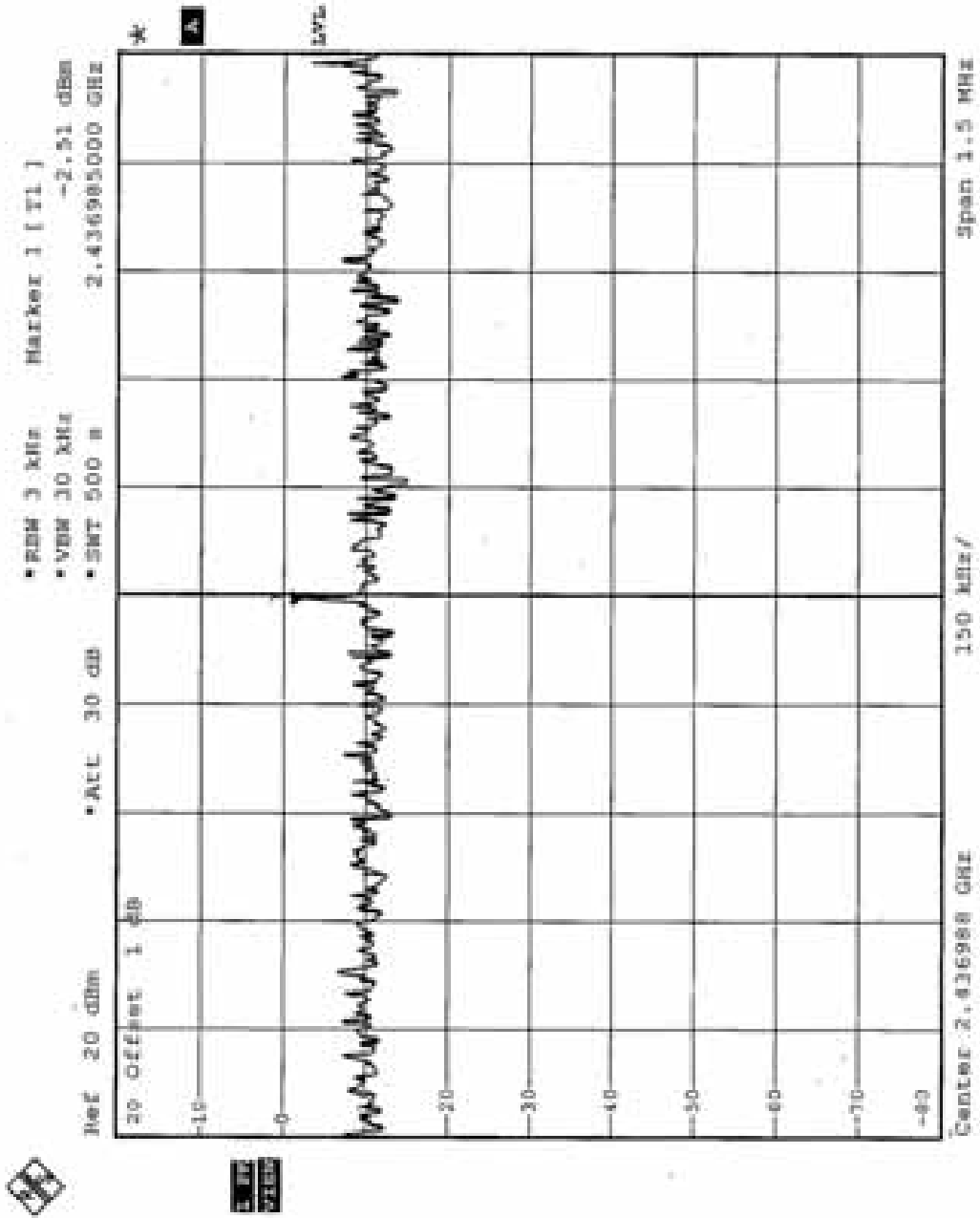



CH11

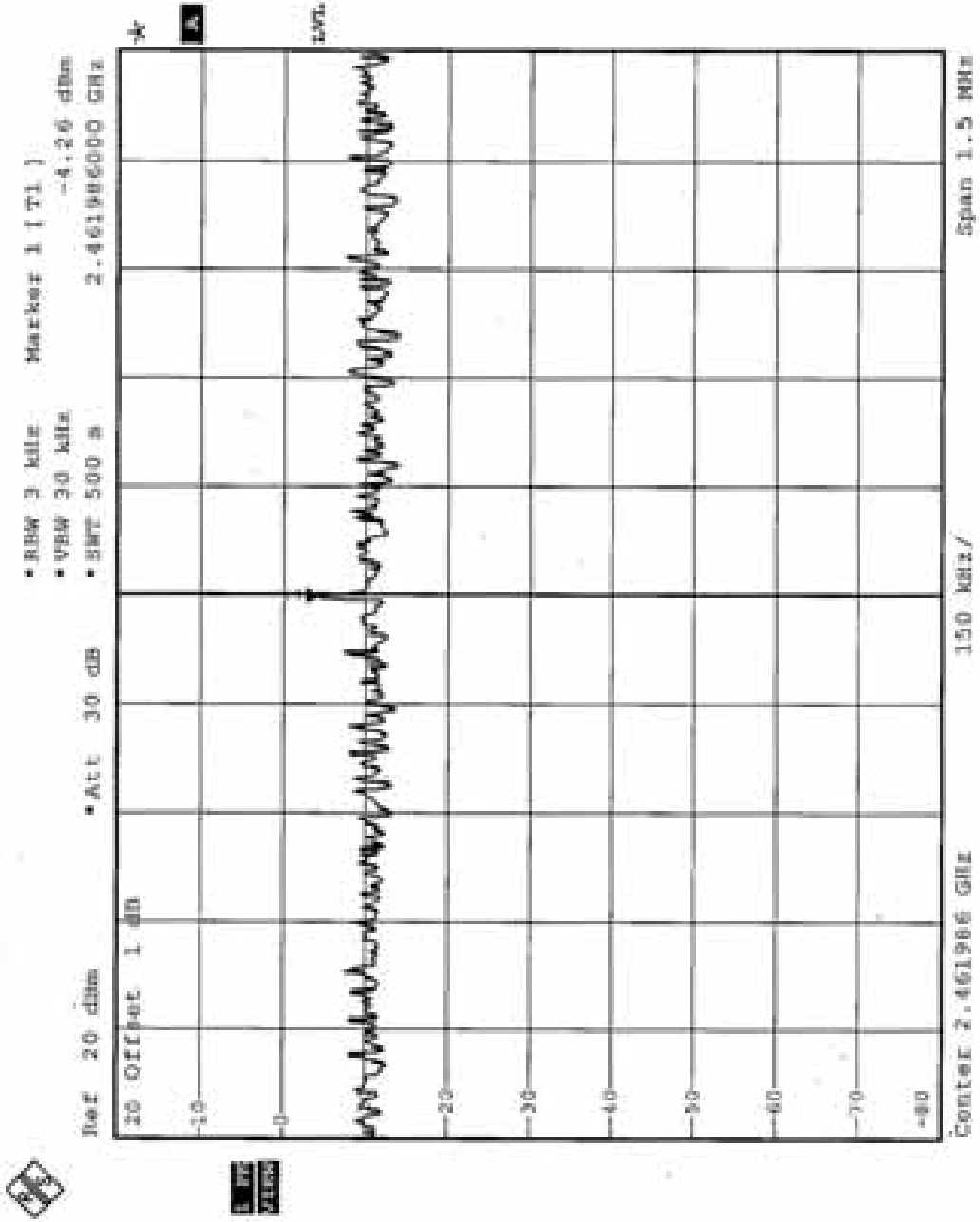





## 4.5.8 TEST RESULTS-OFDM

<b>EUT</b>	IEEE 802.11a/g Wireless LAN Access Point		
<b>INPUT POWER (SYSTEM)</b>	120Vac, 60Hz	<b>MODEL</b>	AS-1250-ABG-EXT
<b>TESTED BY</b>	Sky Liao	<b>ENVIRONMENTAL CONDITIONS</b>	28deg. C, 65%RH, 979 hPa

<b>CHANNEL NUMBER</b>	<b>CHANNEL FREQUENCY (MHz )</b>	<b>RF POWER LEVEL IN 3 kHz BW (dBm)</b>	<b>MAXIMUM LIMIT (dBm)</b>	<b>PASS/FAIL</b>
1	2412	-8.32	8	PASS
6	2437	-8.49	8	PASS
11	2462	-8.88	8	PASS



CH1

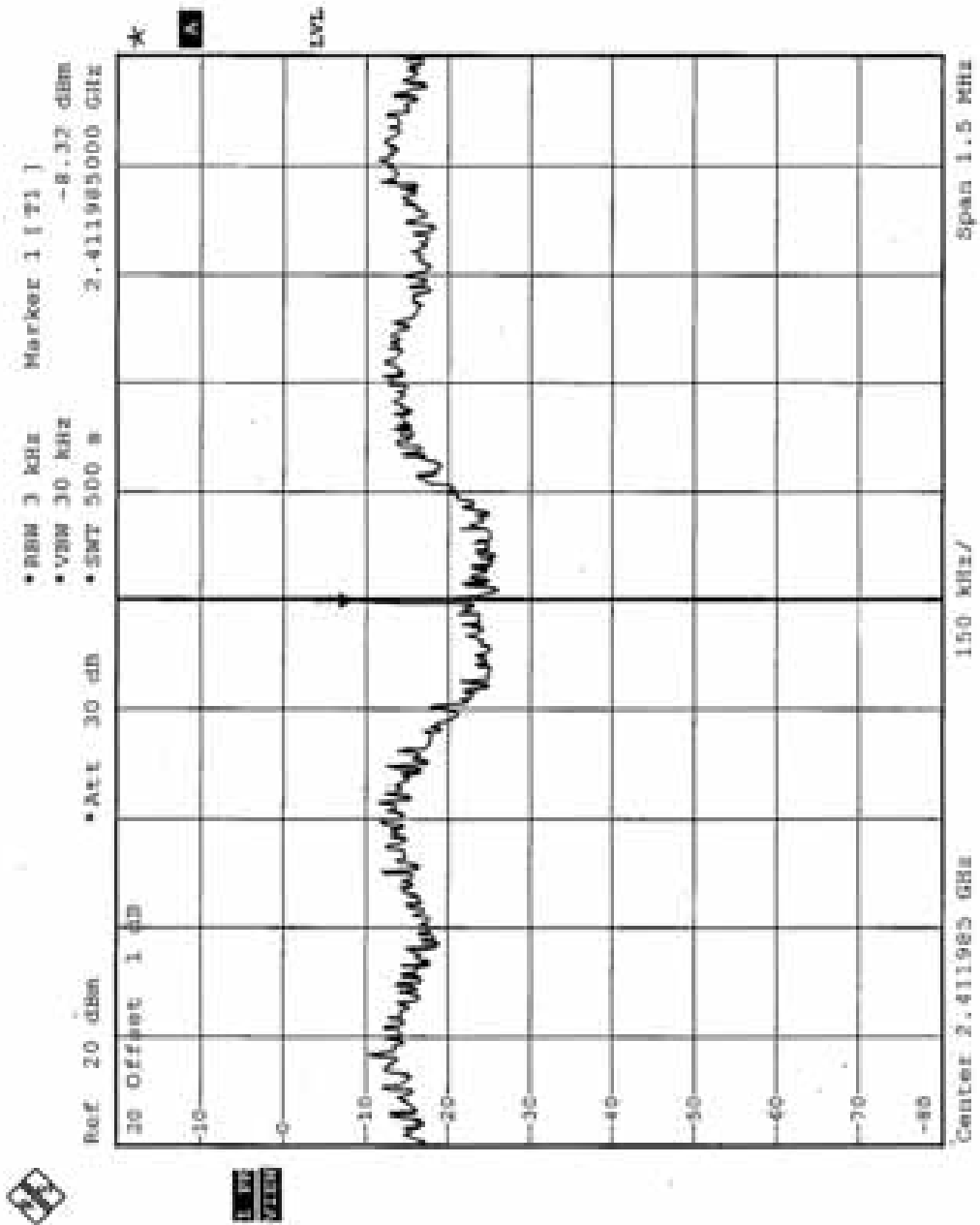



CH6

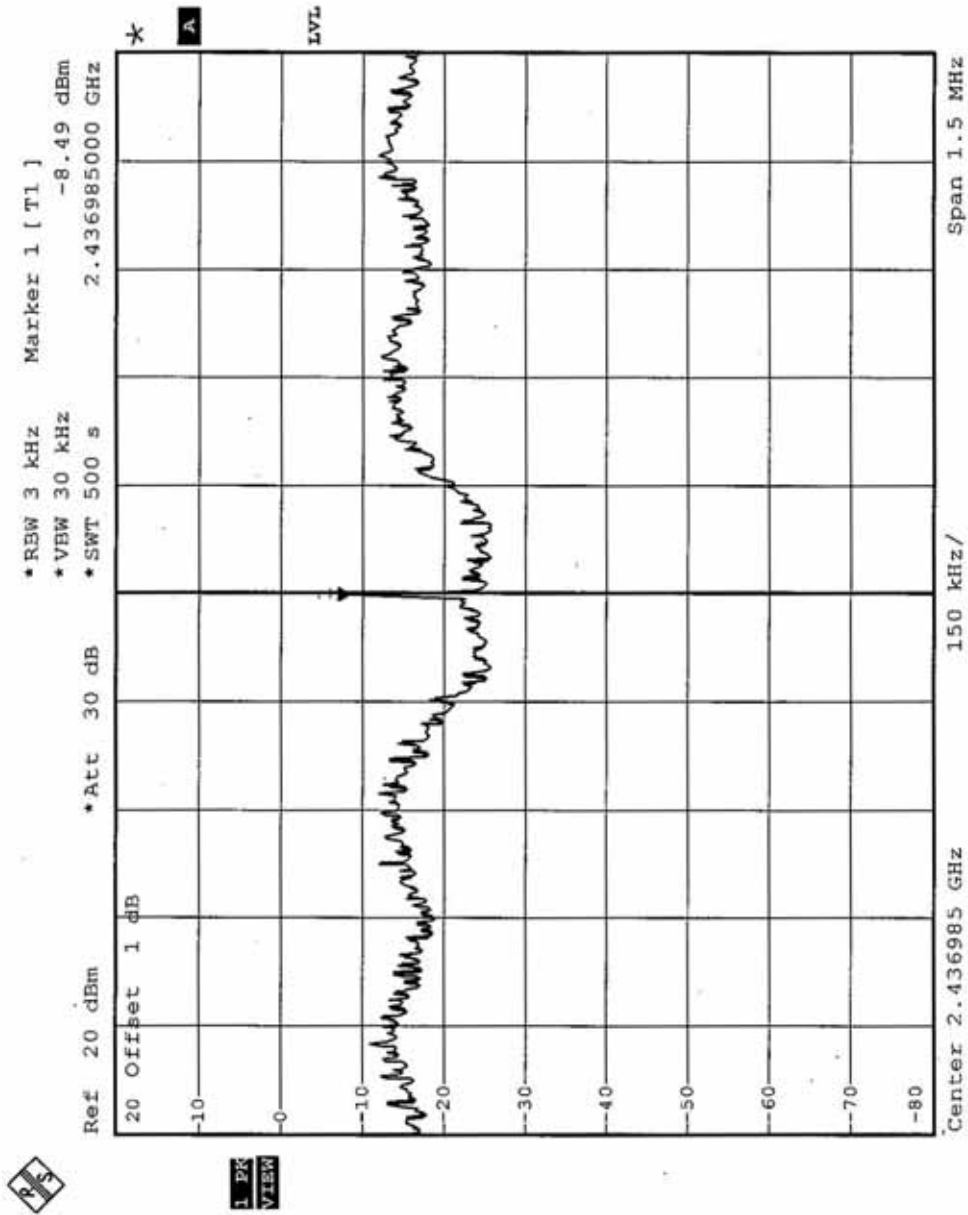



CH11

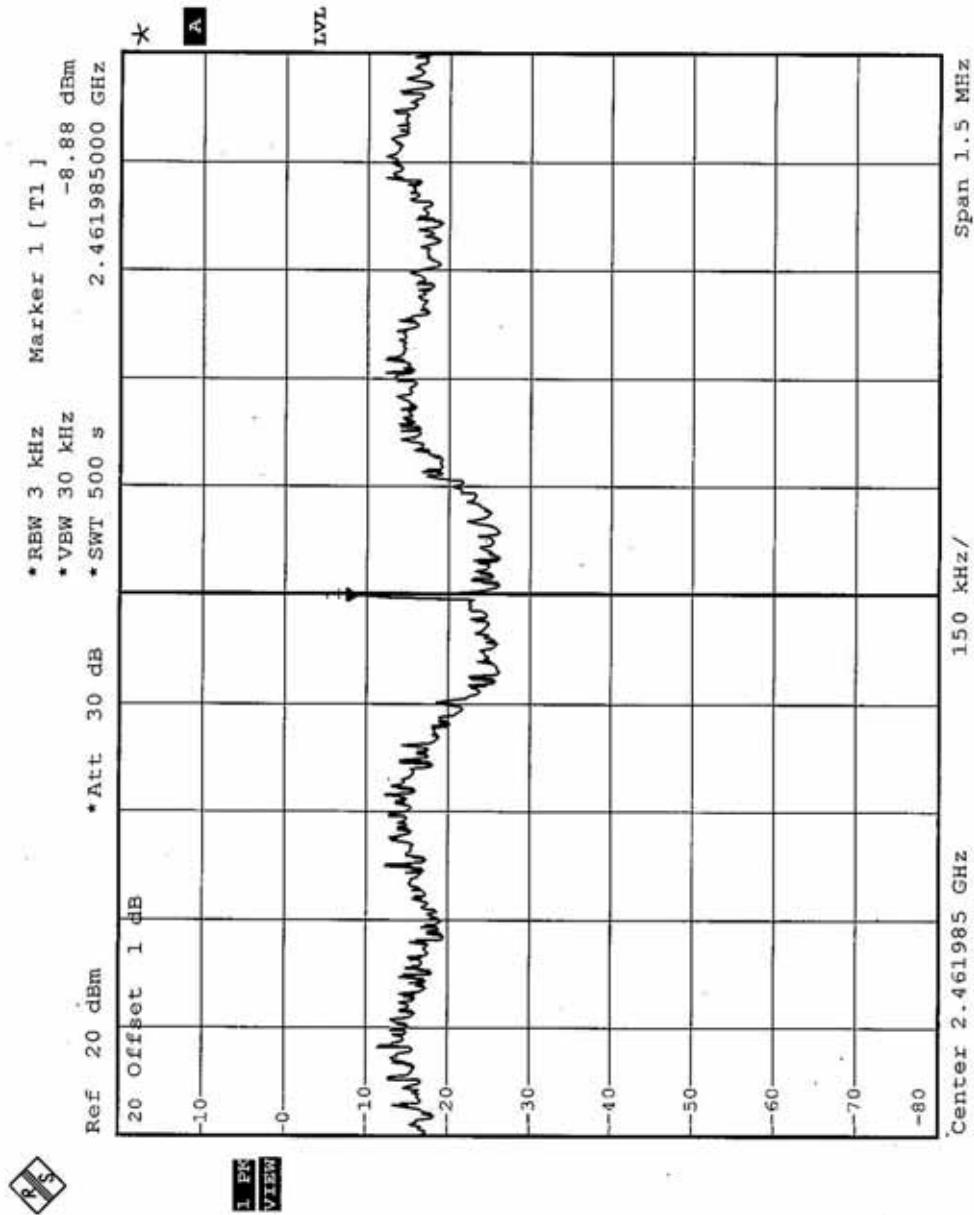



## 4.6 BAND EDGES MEASUREMENT

### 4.6.1 LIMITS OF BAND EDGES MEASUREMENT

Below  $-20\text{dB}$  of the highest emission level of operating band (in 1MHz Resolution Bandwidth).

### 4.6.2 TEST INSTRUMENTS

Description & Manufacturer	Model No.	Serial No.	Calibrated Until
R&S SPECTRUM ANALYZER	FSP40	100037	May. 06, 2005

**Note:**

1. The measurement uncertainty is 2.79dB, which is calculated as per the document ETSI TR 100 028
2. The calibration interval of the above test instruments is 12 months and the calibrations are traceable to NML/ROC and NIST/USA.

### 4.6.3 TEST PROCEDURE

The transmitter output was connected to the spectrum analyzer via a low lose cable. Set RBW spectrum analyzer to 1 MHz and set VBW spectrum analyzer to 10 Hz with suitable frequency span including 1 MHz bandwidth from band edge. The band edges was measured and recorded.

### 4.6.4 DEVIATION FROM TEST STANDARD

No deviation

### 4.6.5 EUT OPERATING CONDITION

Same as Item 4.3.6



#### 4.6.6 TEST RESULTS –DSSS

The spectrum plots are attached on the following 2 pages. D1 line indicates the highest level, and D2 line indicates the 20dB offset below D2. It shows compliance with the requirement in part 15.247(C).

Note - The delta method is only used up to 2 MHz away from the restricted bandage, The radiated emissions which located in other restricted frequency band, the result, please refer to 4.2.

**NOTE (1):** The band edge emission plot on the following first page shows 57.59dB delta between carrier maximum power and local maximum emission in restrict band (2.3900GHz). The emission of carrier strength list in the test result of channel 1 at the item 4.2 is 107.7dBuV/m, so the maximum field strength in restrict band is  $107.7-57.59=50.11$ dBuV/m which is under 54 dBuV/m limit.

**NOTE (2):** The band edge emission plot on the following second page shows 58.23 dB delta between carrier maximum power and local maximum emission in restrict band (2.4835GHz). The emission of carrier strength list in the test result of channel 11 at the item 4.2 is 108.2dBuV/m, so the maximum field strength in restrict band is  $108.2-58.23=49.97$ dBuV/m which is under 54 dBuV/m limit.

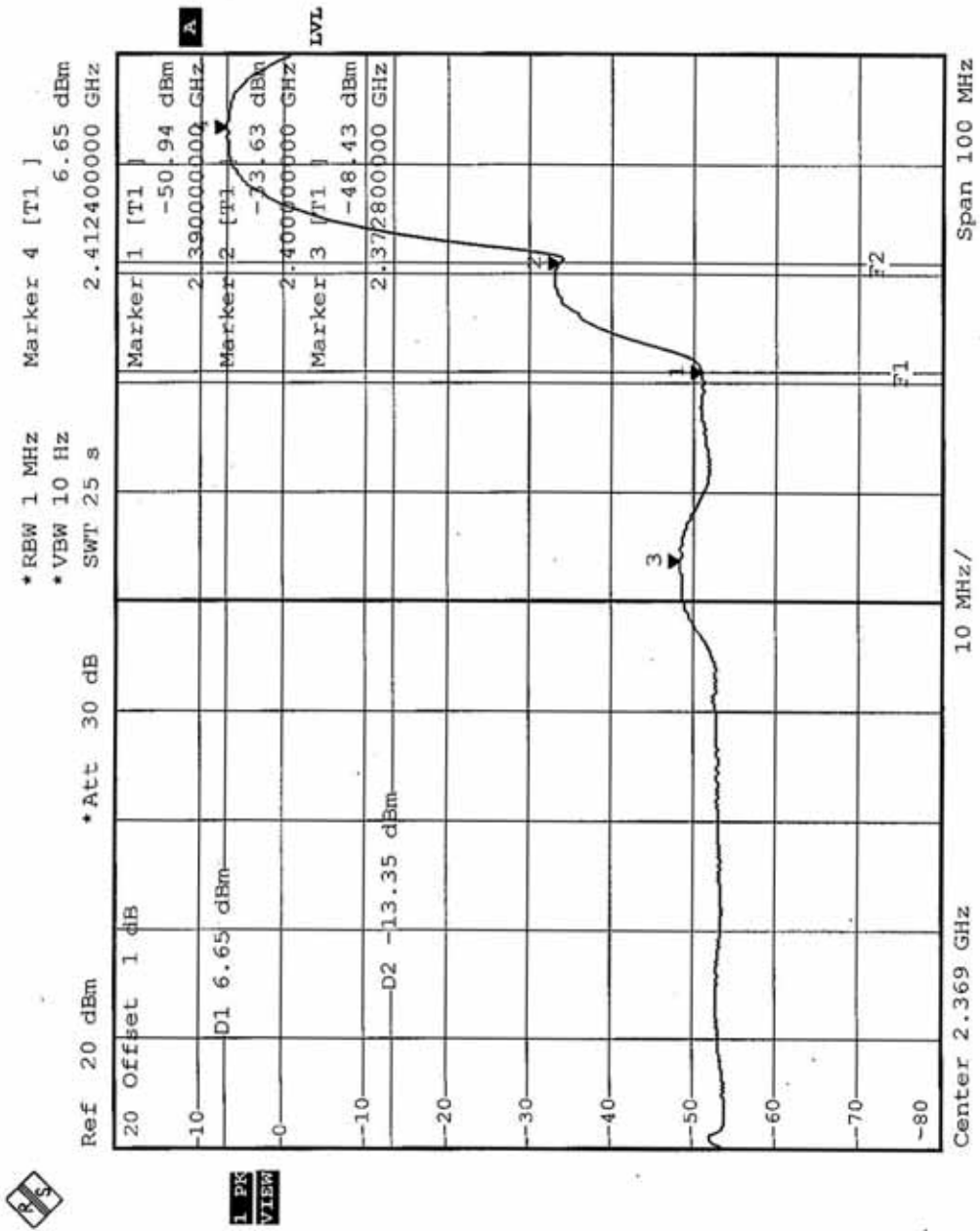

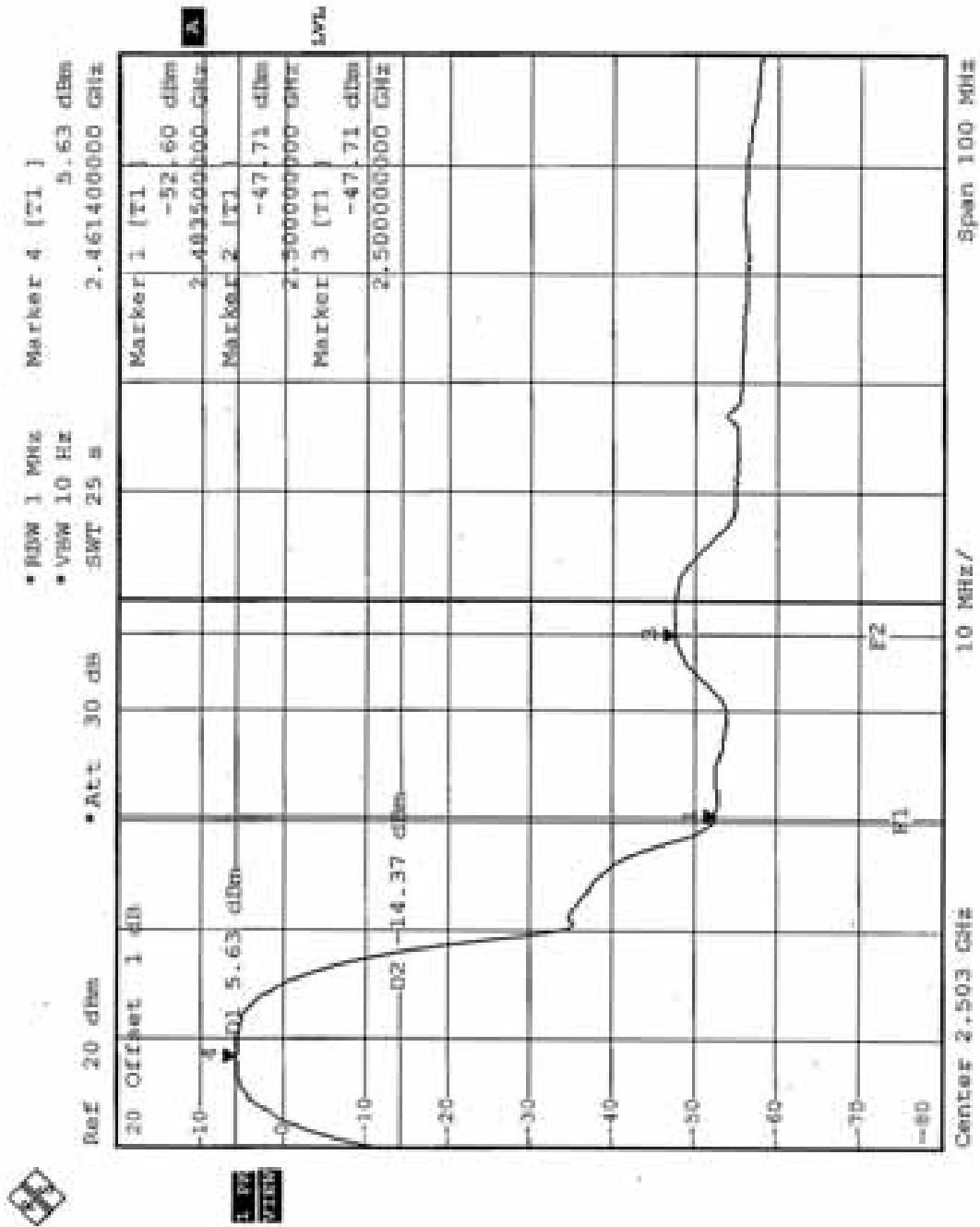





#### 4.6.7 TEST RESULTS –OFDM

The spectrum plots are attached on the following 2 pages. D1 line indicates the highest level, and D2 line indicates the 20dB offset below D2. It shows compliance with the requirement in part 15.247(C).

Note - The delta method is only used up to 2 MHz away from the restricted bandage, The radiated emissions which located in other restricted frequency band, the result, please refer to 4.2.

**NOTE (1):** The band edge emission plot on the following first page shows 48.92dB delta between carrier maximum power and local maximum emission in restrict band (2.3900GHz). The emission of carrier strength list in the test result of channel 1 at the item 4.2 is 101.9dBuV/m, so the maximum field strength in restrict band is  $101.9-48.92=52.98$ dBuV/m which is under 54 dBuV/m limit.

**NOTE (2):** The band edge emission plot on the following second page shows 49.48 dB delta between carrier maximum power and local maximum emission in restrict band (2.4835GHz). The emission of carrier strength list in the test result of channel 11 at the item 4.2 is 102.0dBuV/m, so the maximum field strength in restrict band is  $102.0-49.48=52.52$  dBuV/m which is under 54 dBuV/m limit.

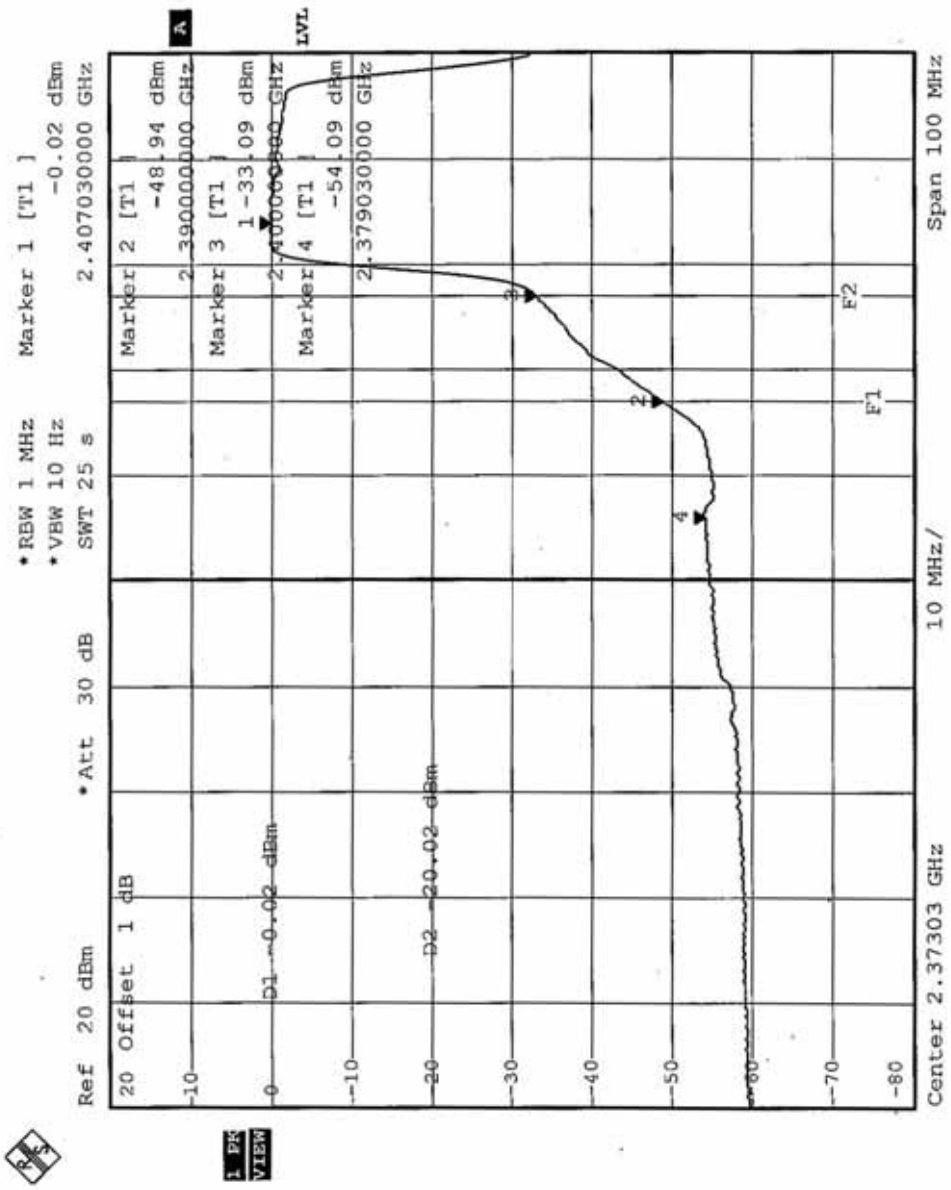

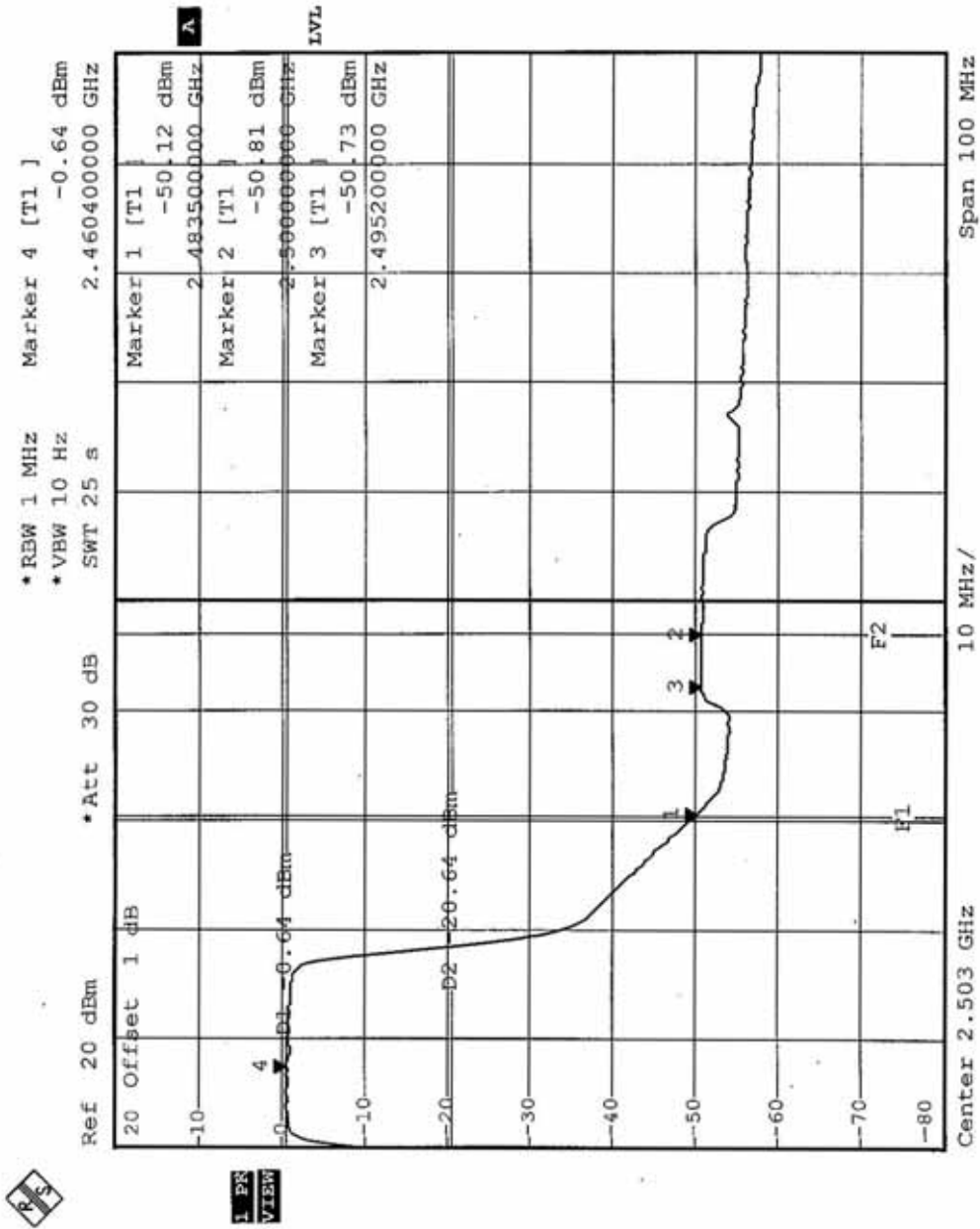



## **4.7 ANTENNA REQUIREMENT**

### **4.7.1 STANDARD APPLICABLE**

For intentional device, according to FCC 47 CFR Section 15.203, an intentional radiator shall be designed to ensure that no antenna other than that furnished by the responsible party shall be used with the device.

And according to FCC 47 CFR Section 15.247 (b), if transmitting antennas of directional gain greater than 6dBi are used, the power shall be reduced by the amount in dB that the directional gain of the antenna exceeds 6dBi.

### **4.7.2 ANTENNA CONNECTED CONSTRUCTION**

The antenna used in this product is Patch Antenna without connector. The maximum Gain of the antenna is 7.8dBi.



## 5. TEST TYPES AND RESULTS (FOR PART 802.11a)

### 5.1 CONDUCTED EMISSION MEASUREMENT

#### 5.1.1 LIMITS OF CONDUCTED EMISSION MEASUREMENT

FREQUENCY OF EMISSION (MHz)	CONDUCTED LIMIT (dB $\mu$ V)	
	Quasi-peak	Average
0.15-0.5	66 to 56	56 to 46
0.5-5	56	46
5-30	60	50

- NOTE:**
1. The lower limit shall apply at the transition frequencies.
  2. The limit decreases in line with the logarithm of the frequency in the range of 0.15 to 0.50 MHz.
  3. All emanations from a class A/B digital device or system, including any network of conductors and apparatus connected thereto, shall not exceed the level of field strengths specified above.

#### 5.1.2 TEST INSTRUMENTS

DESCRIPTION & MANUFACTURER	MODEL NO.	SERIAL NO.	CALIBRATED UNTIL
*ROHDE & SCHWARZ Test Receiver	ESCS 30	847124/029	Dec. 04, 2004
*ROHDE & SCHWARZ LISN (for EUT)	ESHS-Z5	848773/004	Nov. 04, 2004
*KYORITSU LISN (for peripheral)	KNW-407	8/1395/12	Jul. 23, 2005
*RF Cable (JETBAO)	RG233/U	Cable_CA_01	Jul. 02, 2005
*Terminator(for KYORITSU)	50	3	May 10, 2005
*Software	Cond-V2e	NA	NA

**Note:**

1. The calibration interval of the above test instruments is 12 months and the calibrations are traceable to NML/ROC and NIST/USA.
2. The test was performed in ADT Shielded Room No. A.
3. The VCCI Con A Registration No. is C-817.
4. \* = These equipment are used for the final measurement.
5. The measurement uncertainty is 2.53 dB, which is calculated as per the document CISPR 16-4



### 5.1.3 TEST PROCEDURES

- a. The EUT was placed 0.4 meters from the conducting wall of the shielded room with EUT being connected to the power mains through a line impedance stabilization network (LISN). Other support units were connected to the power mains through another LISN. The two LISNs provide 50 ohm/ 50uH of coupling impedance for the measuring instrument.
- b. Both lines of the power mains connected to the EUT were checked for maximum conducted interference.
- c. The frequency range from 150 kHz to 30 MHz was searched. Emission levels over 10dB under the prescribed limits could not be reported

### 5.1.4 DEVIATION FROM TEST STANDARD

No deviation

### 5.1.5 TEST SETUP

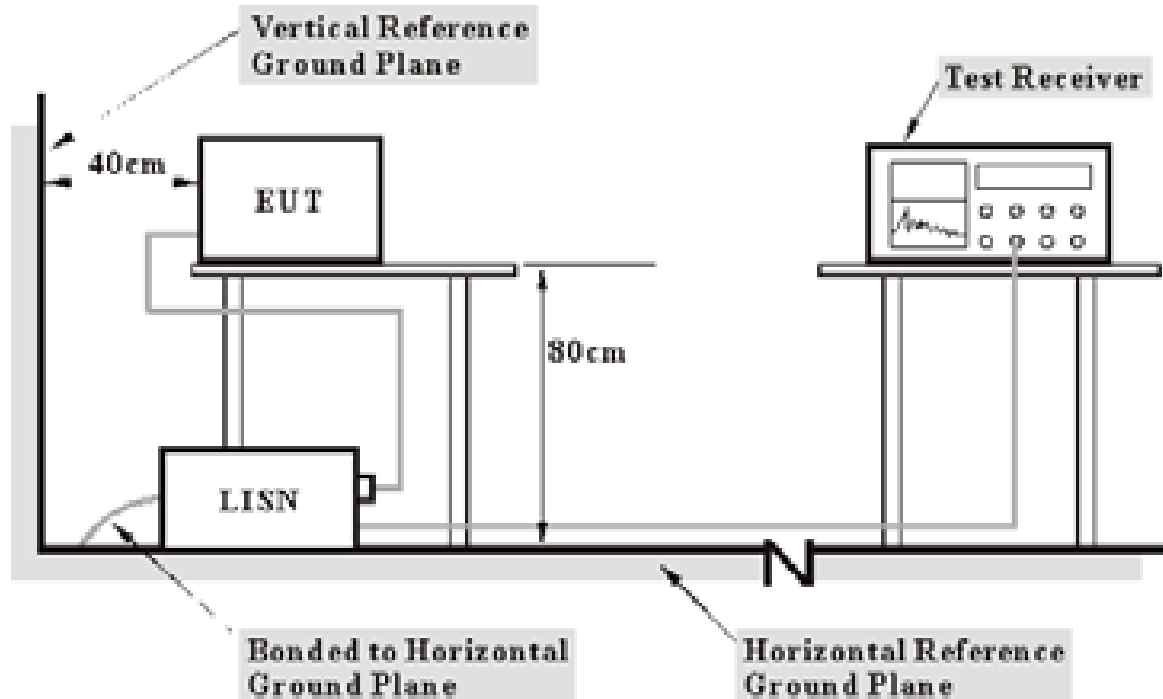

- Note:**
1. Support units were connected to second LISN.
  2. Both of LISNs (AMN) 80 cm from EUT and at the least 80 cm from other units and other metal planes support units.

For the actual test configuration, please refer to the related item – Photographs of the Test Configuration.

### 5.1.6 EUT OPERATING CONDITIONS

- a. Placed the EUT on the testing table.
- b. Prepared another computer system to act as a communication partner and placed it outside of testing area.
- c. The communication partner run test program “ART\_V48\_build 13\_Alpha” to enable EUT under transmission/receiving condition continuously at specific channel frequency via UTP cable.



### 5.1.7 TEST RESULTS

<b>EUT</b>	IEEE 802.11a/g Wireless LAN Access Point		
<b>MODEL</b>	AS-1250-ABG-EXT	<b>6dB BANDWIDTH</b>	9 kHz
<b>INPUT POWER (SYSTEM)</b>	120Vac, 60 Hz	<b>PHASE</b>	Line (L)
<b>ENVIRONMENTAL CONDITIONS</b>	27deg. C, 65%RH, 979 hPa	<b>TESTED BY</b>	Sky Liao
<b>TEST MODE</b>	802.11a, With Adapter		

No	Freq. [MHz]	Corr. Factor (dB)	Reading Value		Emission Level		Limit		Margin	
			[dB (uV)]		[dB (uV)]		[dB (uV)]		(dB)	
			Q.P.	AV.	Q.P.	AV.	Q.P.	AV.	Q.P.	AV.
1	0.154	0.31	50.68	-	50.99	-	65.79	55.79	-14.80	-
2	0.306	0.32	40.59	-	40.91	-	60.07	50.07	-19.16	-
3	0.534	0.35	37.98	-	38.33	-	56.00	46.00	-17.67	-
4	1.064	0.43	37.67	-	38.10	-	56.00	46.00	-17.90	-
5	7.602	1.12	37.13	-	38.25	-	60.00	50.00	-21.75	-
6	26.641	1.92	37.82	-	39.74	-	60.00	50.00	-20.26	-

- REMARKS:**
1. Q.P. and AV. are abbreviations of quasi-peak and average individually.
  2. "-": The Quasi-peak reading value also meets average limit and measurement with the average detector is unnecessary.
  3. The emission levels of other frequencies were very low against the limit.
  4. Margin value = Emission level - Limit value
  5. Correction factor = Insertion loss + Cable loss
  6. Emission Level = Correction Factor + Reading Value.

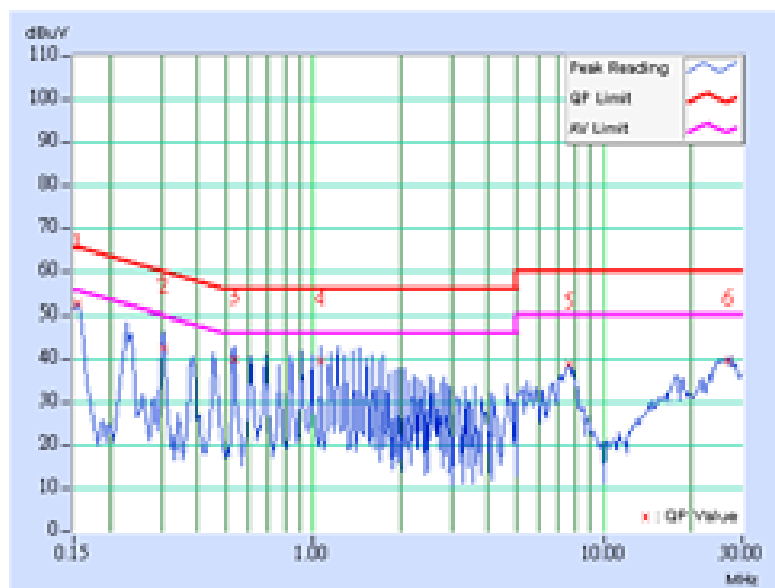





<b>EUT</b>	IEEE 802.11a/g Wireless LAN Access Point		
<b>MODEL</b>	AS-1250-ABG-EXT	<b>6dB BANDWIDTH</b>	9 kHz
<b>INPUT POWER (SYSTEM)</b>	120Vac, 60 Hz	<b>PHASE</b>	Neutral (N)
<b>ENVIRONMENTAL CONDITIONS</b>	27deg. C, 65%RH, 979 hPa	<b>TESTED BY</b>	Sky Liao
<b>TEST MODE</b>	802.11a, With Adapter		

No	Freq. [MHz]	Corr. Factor (dB)	Reading Value [dB (uV)]		Emission Level [dB (uV)]		Limit [dB (uV)]		Margin (dB)	
			Q.P.	AV.	Q.P.	AV.	Q.P.	AV.	Q.P.	AV.
	1	0.154	0.31	50.37	-	50.68	-	65.79	55.79	-15.11
2	0.228	0.31	43.16	-	43.47	-	62.52	52.52	-19.05	-
3	0.306	0.32	40.11	-	40.43	-	60.07	50.07	-19.64	-
<b>4</b>	<b>1.064</b>	<b>0.43</b>	<b>41.77</b>	-	<b>42.20</b>	-	<b>56.00</b>	<b>46.00</b>	<b>-13.80</b>	-
5	5.770	0.97	40.72	-	41.69	-	60.00	50.00	-18.31	-
6	25.516	1.69	37.34	-	39.03	-	60.00	50.00	-20.97	-

- REMARKS:**
1. Q.P. and AV. are abbreviations of quasi-peak and average individually.
  2. "-": The Quasi-peak reading value also meets average limit and measurement with the average detector is unnecessary.
  3. The emission levels of other frequencies were very low against the limit.
  4. Margin value = Emission level - Limit value
  5. Correction factor = Insertion loss + Cable loss
  6. Emission Level = Correction Factor + Reading Value.

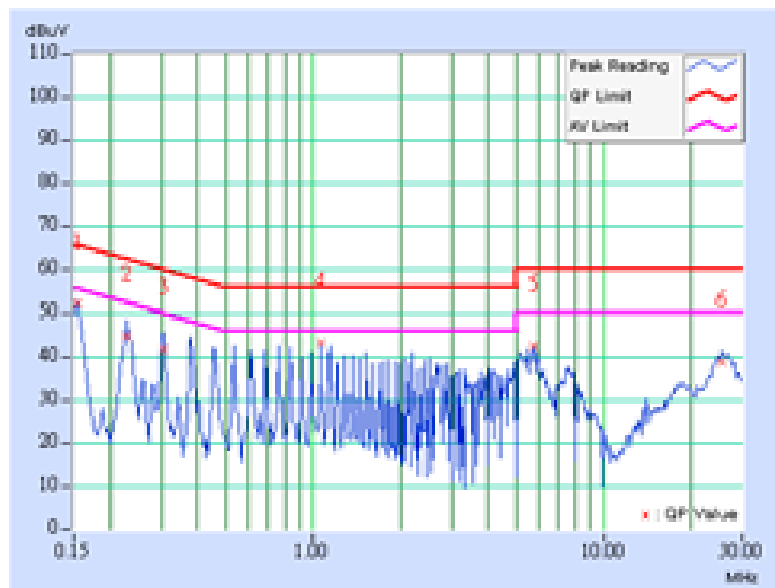



<b>EUT</b>	IEEE 802.11a/g Wireless LAN Access Point		
<b>MODEL</b>	AS-1250-ABG-EXT	<b>6dB BANDWIDTH</b>	9 kHz
<b>INPUT POWER (SYSTEM)</b>	120Vac, 60 Hz	<b>PHASE</b>	Line (L)
<b>ENVIRONMENTAL CONDITIONS</b>	27deg. C, 67%RH, 979 hPa	<b>TESTED BY</b>	Sky Liao
<b>TEST MODE</b>	802.11a, With POE		

No	Freq. [MHz]	Corr. Factor (dB)	Reading Value [dB (uV)]		Emission Level [dB (uV)]		Limit [dB (uV)]		Margin (dB)	
			Q.P.	AV.	Q.P.	AV.	Q.P.	AV.	Q.P.	AV.
	1	0.154	0.31	40.13	-	40.44	-	65.79	55.79	-25.35
2	0.466	0.34	34.75	-	35.09	-	56.58	46.58	-21.49	-
3	1.994	0.53	35.47	-	36.00	-	56.00	46.00	-20.00	-
4	5.117	0.96	34.18	-	35.14	-	60.00	50.00	-24.86	-
5	9.242	1.22	36.62	-	37.84	-	60.00	50.00	-22.16	-
6	23.129	1.86	43.55	-	45.41	-	60.00	50.00	-14.59	-

- REMARKS:**
1. Q.P. and AV. are abbreviations of quasi-peak and average individually.
  2. "-": The Quasi-peak reading value also meets average limit and measurement with the average detector is unnecessary.
  3. The emission levels of other frequencies were very low against the limit.
  4. Margin value = Emission level - Limit value
  5. Correction factor = Insertion loss + Cable loss
  6. Emission Level = Correction Factor + Reading Value.

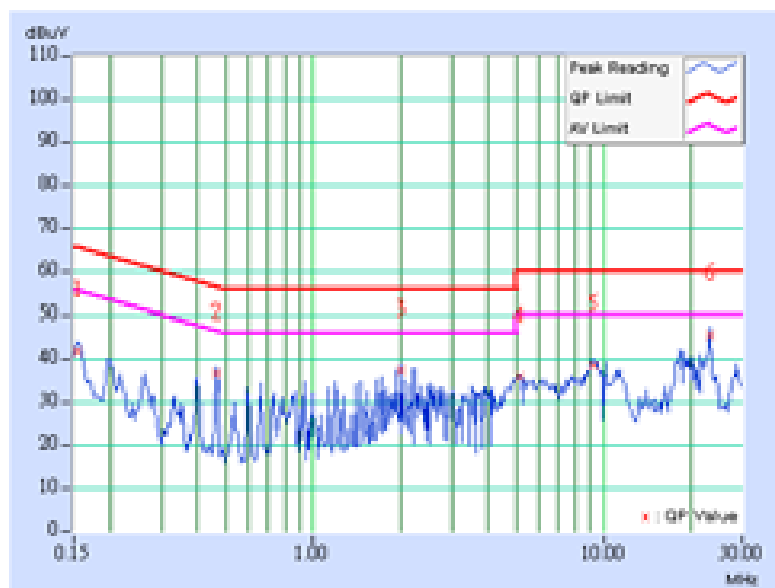



<b>EUT</b>	IEEE 802.11a/g Wireless LAN Access Point		
<b>MODEL</b>	AS-1250-ABG-EXT	<b>6dB BANDWIDTH</b>	9 kHz
<b>INPUT POWER (SYSTEM)</b>	120Vac, 60 Hz	<b>PHASE</b>	Neutral (N)
<b>ENVIRONMENTAL CONDITIONS</b>	27deg. C, 67%RH, 979 hPa	<b>TESTED BY</b>	Sky Liao
<b>TEST MODE</b>	802.11a, With POE		

No	Freq. [MHz]	Corr. Factor (dB)	Reading Value [dB (uV)]		Emission Level [dB (uV)]		Limit [dB (uV)]		Margin (dB)	
			Q.P.	AV.	Q.P.	AV.	Q.P.	AV.	Q.P.	AV.
			1	0.154	0.31	39.67	-	39.98	-	65.79
2	0.466	0.34	35.15	-	35.49	-	56.58	46.58	-21.09	-
3	2.056	0.54	33.83	-	34.37	-	56.00	46.00	-21.63	-
4	19.707	1.57	37.37	-	38.94	-	60.00	50.00	-21.06	-
5	23.129	1.66	42.36	-	44.02	-	60.00	50.00	-15.98	-
6	28.625	1.66	37.03	-	38.69	-	60.00	50.00	-21.31	-

- REMARKS:**
1. Q.P. and AV. are abbreviations of quasi-peak and average individually.
  2. "-": The Quasi-peak reading value also meets average limit and measurement with the average detector is unnecessary.
  3. The emission levels of other frequencies were very low against the limit.
  4. Margin value = Emission level - Limit value
  5. Correction factor = Insertion loss + Cable loss
  6. Emission Level = Correction Factor + Reading Value.

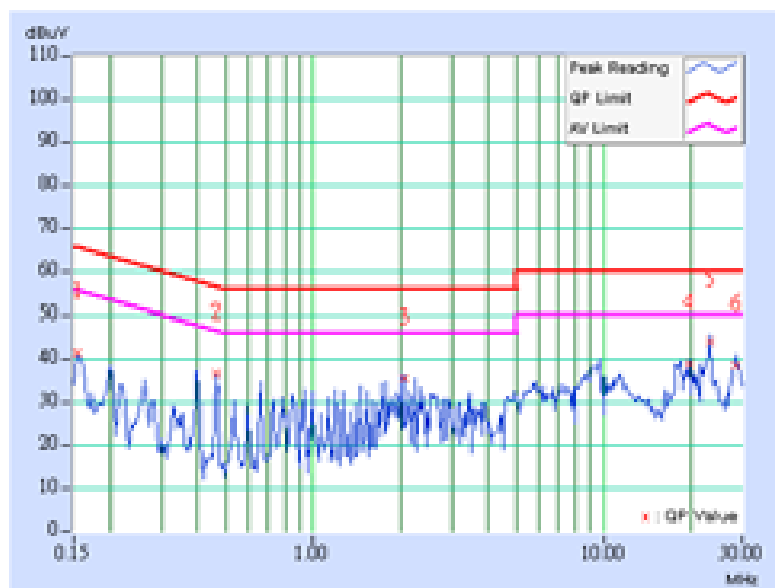



## 5.2 RADIATED EMISSION MEASUREMENT

### 5.2.1 LIMITS OF RADIATED EMISSION MEASUREMENT

Emissions radiated outside of the specified bands, shall be according to the general radiated limits in 15.209 as following:

Frequencies (MHz)	Field strength (microvolts/meter)	Measurement distance (meters)
0.009-0.490	2400/F(kHz)	300
0.490-1.705	24000/F(kHz)	30
1.705-30.0	30	30
30-88	100	3
88-216	150	3
216-960	200	3
Above 960	500	3

**NOTE:**

1. The lower limit shall apply at the transition frequencies.
2. Emission level (dBuV/m) = 20 log Emission level (uV/m).
3. As shown in 15.35(b), for frequencies above 1000MHz, the field strength limits are based on average detector, however, the peak field strength of any emission shall not exceed the maximum permitted average limits, specified above by more than 20dB under any condition of modulation.



## 5.2.2 LIMITS OF UNWANTED EMISSION OUT OF THE RESTRICTED BANDS

Frequencies (MHz)	EIRP Limit (dBm)	Equivalent Field Strength at 3m (dB $\mu$ V/m) *note 3
5150~5250	-27	68.3
5250~5350	-27	68.3
5725~5825	-27 *note 1	68.3
	-17 *note 2	78.3

### NOTE:

1. For frequencies 10MHz or greater above or below the band edge.
2. All emissions within the frequency range from the band edge to 10MHz above or below the band edge.
3. The following formula is used to convert the equipment isotropic radiated power (eirp) to field strength

$$E = \frac{1000000\sqrt{30P}}{3} \mu\text{V/m}, \quad \text{where } P \text{ is the eirp (Watts)}$$



### 5.2.3 TEST INSTRUMENTS

DESCRIPTION & MANUFACTURER	MODEL NO.	SERIAL NO.	CALIBRATED UNTIL
HP Spectrum Analyzer	8594E	3710A04861	Sep. 23, 2005
ADVANTEST Spectrum Analyzer	R3271A	85060311	Jun. 29, 2005
CHASE RF Pre_Amplifier	CPA9232	1057	Aug. 06, 2005
HP Pre_Amplifier	8449B	3008A01922	Oct. 13, 2005
ROHDE & SCHWARZ Test Receiver	ESCS30	100287	Dec. 11, 2004
CHASE Broadband Antenna	VULB9168	138	May 22, 2005
Schwarzbeck Horn_Antenna	BBHA9120	D124	Jun. 16, 2005
Schwarzbeck Horn_Antenna	BBHA 9170	BBHA9170192	Feb. 16, 2005
SCHWARZBECK Tunable Dipole Antenna	UHAP	897	Mar. 07, 2005
SCHWARZBECK Tunable Dipole Antenna	VHAP	880	Mar. 07, 2005
RF Switches (ARNITSU)	CS-201	1565157	Dec. 01, 2004
RF CABLE (Chaintek) 1GHz-20GHz	SF102	22054-2	Feb. 10, 2005
RF Cable(RICHTEC)	9913-30M	STCCAB-30M- 1GHz-021	Dec. 01, 2004
Software	AS60P8	NA	NA
CHANCE MOST Antenna Tower	AT-100	0203	NA
CHANCE MOST Turn Table	TT-100	0203	NA

Note: 1. The calibration interval of the above test instruments is 12 months (36 months for Tunable Dipole Antenna) and the calibrations are traceable to NML/ROC and NIST/USA.

2. The horn antenna and HP preamplifier (model: 8449B) are used only for the measurement of emission frequency above 1GHz if tested.
3. The test was performed in ADT Open Site No. C.
4. The FCC Site Registration No. is 656396.
5. The VCCI Site Registration No. is R-1626.
6. The CANADA Site Registration No. is IC 4824-3.
7. The measurement uncertainty is 3.56 dB, which is calculated as per the document CISPR 16-4



#### 5.2.4 TEST PROCEDURES

- a. The EUT was placed on the top of a rotating table 0.8 meters above the ground at a 10 meter open area test site. The table was rotated 360 degrees to determine the position of the highest radiation.
- b. The EUT was set 3 meters away from the interference-receiving antenna, which was mounted on the top of a variable-height antenna tower.
- c. The antenna is a broadband antenna, and its height is varied from one meter to four meters above the ground to determine the maximum value of the field strength. Both horizontal and vertical polarizations of the antenna are set to make the measurement.
- d. For each suspected emission, the EUT was arranged to its worst case and then the antenna was tuned to heights from 1 meter to 4 meters and the rotatable table was turned from 0 degrees to 360 degrees to find the maximum reading.
- e. The test-receiver system was set to Peak Detect Function and Specified Bandwidth with Maximum Hold Mode.
- f. If the emission level of the EUT in peak mode was 10dB lower than the limit specified, then testing could be stopped and the peak values of the EUT would be reported. Otherwise the emissions that did not have 10dB margin would be re-tested one by one using peak, quasi-peak or average method as specified and then reported in a data sheet.

**NOTE:**

1. The resolution bandwidth and video bandwidth of test receiver/spectrum analyzer is 120kHz for Peak detection (PK) and Quasi-peak detection (QP) at frequency below 1GHz.
2. The resolution bandwidth and video bandwidth of test receiver/spectrum analyzer is 1 MHz for Peak detection at frequency above 1GHz.
3. The resolution bandwidth of test receiver/spectrum analyzer is 1 MHz and the video bandwidth is 300 Hz for Average detection (AV) at frequency above 1GHz.

#### 5.2.5 DEVIATION FROM TEST STANDARD

No deviation

## 5.2.6 TEST SETUP

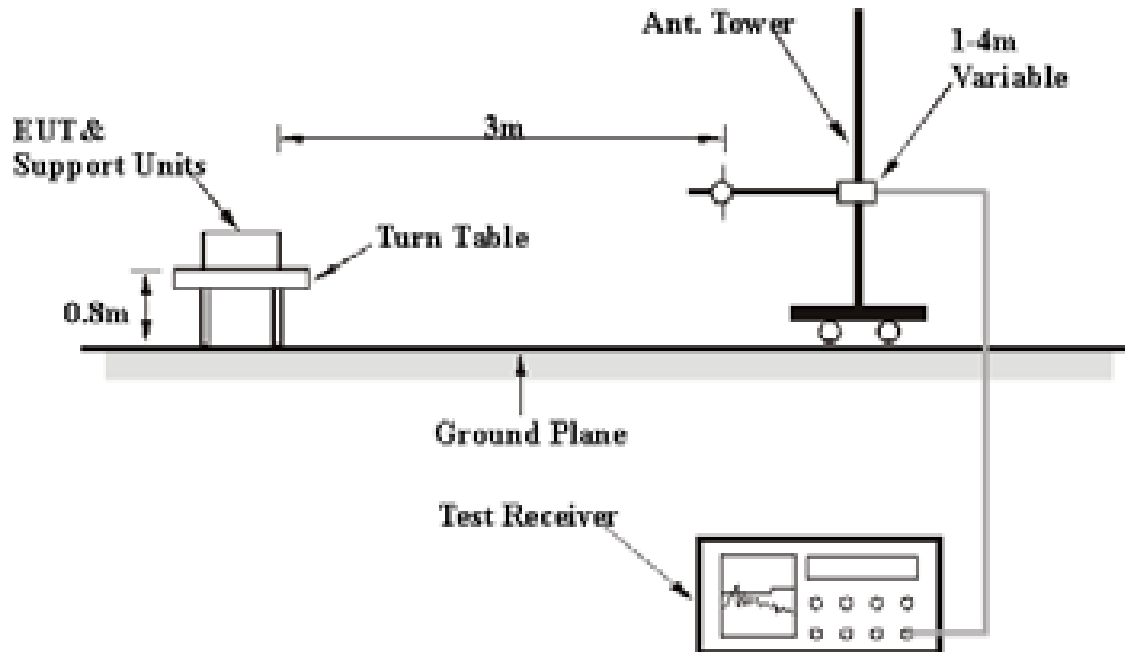

For the actual test configuration, please refer to the related item – Photographs of the Test Configuration.

## 5.2.7 EUT OPERATING CONDITIONS

Same as 4.1.6.





## 5.2.8 TEST RESULTS

<b>EUT</b>	IEEE 802.11a/g Wireless LAN Access Point		
<b>MODEL</b>	AS-1250-ABG-EXT	<b>DETECTOR FUNCTION</b>	Quasi-Peak
<b>FREQUENCY RANGE</b>	30 - 1000MHz	<b>DETECTOR FUNCTION &amp; BANDWIDTH</b>	Quasi-Peak, 120kHz
<b>ENVIRONMENTAL CONDITIONS</b>	28deg. C, 70%RH, 979 hPa	<b>TEST MODE</b>	With Adapter
<b>TESTED BY</b>	Sky Liao		

**ANTENNA POLARITY & TEST DISTANCE: HORIZONTAL AT 3 M**

No.	Freq. (MHz)	Emission Level (dBuV/m)	Limit (dBuV/m)	Margin (dB)	Antenna Height (m)	Table Angle (Degree)	Raw Value (dBuV)	Correction Factor (dB/m)
1	125.00	28.20 QP	43.50	-15.30	1.52 H	4	15.80	12.50
2	250.01	34.90 QP	46.00	-11.10	2.00 H	130	20.90	14.00
3	279.99	35.40 QP	46.00	-10.60	1.34 H	96	20.80	14.60
4	330.00	41.20 QP	46.00	-4.80	1.00 H	121	25.10	16.10
5	360.00	33.90 QP	46.00	-12.10	1.00 H	272	16.80	17.10
6	440.00	40.60 QP	46.00	-5.40	1.20 H	139	21.40	19.30
7	499.99	36.00 QP	46.00	-10.00	1.08 H	0	15.40	20.70
8	624.98	39.80 QP	46.00	-6.20	1.72 H	246	16.90	22.90
9	770.00	35.10 QP	46.00	-10.90	1.67 H	23	9.20	25.90
10	960.00	36.40 QP	46.00	-9.60	1.94 H	101	7.00	29.50

**ANTENNA POLARITY & TEST DISTANCE: VERTICAL AT 3 M**

No.	Freq. (MHz)	Emission Level (dBuV/m)	Limit (dBuV/m)	Margin (dB)	Antenna Height (m)	Table Angle (Degree)	Raw Value (dBuV)	Correction Factor (dB/m)
1	124.99	35.20 QP	43.50	-8.30	1.15 V	245	22.80	12.50
2	250.00	37.00 QP	46.00	-9.00	1.68 V	13	23.00	14.00
3	360.00	35.00 QP	46.00	-11.00	1.36 V	15	17.90	17.10
4	440.00	40.50 QP	46.00	-5.50	1.68 V	170	21.20	19.30
5	499.98	40.60 QP	46.00	-5.40	1.17 V	188	19.90	20.70
6	624.98	37.00 QP	46.00	-9.00	1.00 V	19	14.10	22.90
7	770.00	40.10 QP	46.00	-5.90	1.52 V	14	14.20	25.90
8	875.05	36.20 QP	46.00	-9.80	1.00 V	149	8.90	27.30
9	880.00	37.80 QP	46.00	-8.20	1.40 V	13	10.50	27.40
10	960.00	36.50 QP	46.00	-9.50	1.57 V	4	7.00	29.50

- REMARKS:**
1. Emission level(dBuV/m)=Raw Value(dBuV) + Correction Factor(dB)
  2. Correction Factor(dB/m) = Antenna Factor (dB/m) + Cable Factor (dB)
  3. The other emission levels were very low against the limit.
  4. Margin value = Emission level – Limit value.



<b>EUT</b>	IEEE 802.11a/g Wireless LAN Access Point		
<b>MODEL</b>	AS-1250-ABG-EXT	<b>DETECTOR FUNCTION</b>	Quasi-Peak
<b>FREQUENCY RANGE</b>	30 - 1000MHz	<b>DETECTOR FUNCTION &amp; BANDWIDTH</b>	Quasi-Peak, 120kHz
<b>ENVIRONMENTAL CONDITIONS</b>	28deg. C, 65%RH, 979 hPa	<b>TEST MODE</b>	With POE
<b>TESTED BY</b>	Sky Liao		

#### ANTENNA POLARITY & TEST DISTANCE: HORIZONTAL AT 3 M

No.	Freq. (MHz)	Emission Level (dBuV/m)	Limit (dBuV/m)	Margin (dB)	Antenna Height (m)	Table Angle (Degree)	Raw Value (dBuV)	Correction Factor (dB/m)
1	125.00	28.30 QP	43.50	-15.20	1.66 H	270	15.80	12.50
2	200.00	30.10 QP	43.50	-13.40	1.04 H	224	20.60	9.60
3	250.02	35.70 QP	46.00	-10.30	1.62 H	21	21.70	14.00
4	280.00	27.60 QP	46.00	-18.40	1.00 H	41	13.00	14.60
5	360.00	26.60 QP	46.00	-19.40	1.28 H	217	9.50	17.10
6	440.00	28.50 QP	46.00	-17.50	1.97 H	281	9.20	19.30
7	500.04	32.30 QP	46.00	-13.70	1.31 H	27	11.60	20.70
8	624.97	31.60 QP	46.00	-14.40	1.22 H	17	8.70	22.90
9	770.00	35.60 QP	46.00	-10.40	1.19 H	217	9.60	25.90
10	880.00	37.10 QP	46.00	-8.90	2.45 H	105	9.70	27.40
11	959.99	32.90 QP	46.00	-13.10	1.05 H	112	3.40	29.50

#### ANTENNA POLARITY & TEST DISTANCE: VERTICAL AT 3 M

No.	Freq. (MHz)	Emission Level (dBuV/m)	Limit (dBuV/m)	Margin (dB)	Antenna Height (m)	Table Angle (Degree)	Raw Value (dBuV)	Correction Factor (dB/m)
1	125.00	39.10 QP	43.50	-4.40	1.08 V	217	26.70	12.50
2	199.99	36.50 QP	43.50	-7.00	1.00 V	193	27.00	9.60
3	250.02	34.10 QP	46.00	-11.90	1.00 V	202	20.10	14.00
4	439.99	39.60 QP	46.00	-6.40	1.28 V	288	20.30	19.30
5	499.98	36.20 QP	46.00	-9.80	1.15 V	82	15.50	20.70
6	624.98	33.00 QP	46.00	-13.00	1.63 V	354	10.10	22.90
7	769.99	36.70 QP	46.00	-9.30	1.34 V	149	10.70	25.90
8	879.99	35.90 QP	46.00	-10.10	1.64 V	12	8.50	27.40
9	960.00	32.90 QP	54.00	-21.10	1.73 V	51	3.40	29.50

- REMARKS:**
1. Emission level(dBuV/m)=Raw Value(dBuV) + Correction Factor(dB)
  2. Correction Factor(dB/m) = Antenna Factor (dB/m) + Cable Factor (dB)
  3. The other emission levels were very low against the limit.
  4. Margin value = Emission level – Limit value.



## STANDARD SECTION 15.407

<b>EUT</b>	IEEE 802.11a/g Wireless LAN Access Point	<b>MODEL</b>	AS-1250-ABG-EXT
<b>MODE</b>	Normal Mode	<b>CHANNEL</b>	1
<b>FREQUENCY RANGE</b>	1000MHz~40000MHz	<b>DETECTOR FUNCTION &amp; BANDWIDTH</b>	Peak (PK) Average (AV) 1 MHz
<b>ENVIRONMENTAL CONDITIONS</b>	28 deg. C, 52%RH, 979 hPa	<b>INPUT POWER (SYSTEM)</b>	120Vac, 60Hz
<b>TESTED BY</b>	Wen Yu		

**ANTENNA POLARITY & TEST DISTANCE: HORIZONTAL AT 3 M**

No.	Freq. (MHz)	Emission Level (dBuV/m)	Limit (dBuV/m)	Margin (dB)	Antenna Height (m)	Table Angle (Degree)	Raw Value (dBuV)	Correction Factor (dB/m)
1	#5150.00	54.20 PK	74.00	-19.80	1.39 H	308	17.20	37.00
1	#5150.00	45.00 AV	54.00	-9.00	1.39 H	308	7.90	37.00
2	*5180.00	103.20 PK			1.39 H	308	66.20	37.00
2	*5180.00	93.90 AV			1.39 H	308	56.90	37.00
3	10360.00	58.00 PK	68.30	-10.30	1.69 H	173	13.30	44.70

**ANTENNA POLARITY & TEST DISTANCE: VERTICAL AT 3 M**

No.	Freq. (MHz)	Emission Level (dBuV/m)	Limit (dBuV/m)	Margin (dB)	Antenna Height (m)	Table Angle (Degree)	Raw Value (dBuV)	Correction Factor (dB/m)
1	#5150.00	56.10 PK	74.00	-17.90	1.07 V	70	19.00	37.00
1	#5150.00	46.40 AV	54.00	-7.60	1.07 V	70	9.40	37.00
2	*5180.00	105.10 PK			1.07 V	70	68.00	37.00
2	*5180.00	95.40 AV			1.07 V	70	58.30	37.00
3	10360.00	59.30 PK	68.30	-9.00	1.99 V	87	14.60	44.70

**NOTE:**

1. Emission level = Raw value + Correction Factor
2. Correction Factor(dB/m) = Antenna Factor (dB/m) + Cable Factor (dB)
3. Margin value = Emission level - Limit value
4. The other emission levels were very low against the limit.
5. "\*" : Fundamental frequency
6. "# " : The radiated frequency falling in the restricted band.



## STANDARD SECTION 15.407

<b>EUT</b>	IEEE 802.11a/g Wireless LAN Access Point	<b>MODEL</b>	AS-1250-ABG-EXT
<b>MODE</b>	Normal Mode	<b>CHANNEL</b>	4
<b>FREQUENCY RANGE</b>	1000MHz~40000MHz	<b>DETECTOR FUNCTION &amp; BANDWIDTH</b>	Peak (PK) Average (AV) 1 MHz
<b>ENVIRONMENTAL CONDITIONS</b>	28 deg. C, 52%RH, 979 hPa	<b>INPUT POWER (SYSTEM)</b>	120Vac, 60Hz
<b>TESTED BY</b>	Wen Yu		

**ANTENNA POLARITY & TEST DISTANCE: HORIZONTAL AT 3 M**

No.	Freq. (MHz)	Emission Level (dBuV/m)	Limit (dBuV/m)	Margin (dB)	Antenna Height (m)	Table Angle (Degree)	Raw Value (dBuV)	Correction Factor (dB/m)
1	*5240.00	100.80 PK			1.48 H	232	63.80	37.00
1	*5240.00	92.00 AV			1.48 H	232	55.00	37.00
2	10480.00	52.00 PK	68.30	-16.30	1.48 H	21	7.00	45.00

**ANTENNA POLARITY & TEST DISTANCE: VERTICAL AT 3 M**

No.	Freq. (MHz)	Emission Level (dBuV/m)	Limit (dBuV/m)	Margin (dB)	Antenna Height (m)	Table Angle (Degree)	Raw Value (dBuV)	Correction Factor (dB/m)
1	*5240.00	104.40 PK			1.06 V	70	67.40	37.00
1	*5240.00	95.70 AV			1.06 V	70	58.70	37.00
2	10480.00	54.20 PK	68.30	-14.10	1.49 V	289	9.20	45.00

**NOTE:**

1. Emission level = Raw value + Correction Factor
2. Correction Factor(dB/m) = Antenna Factor (dB/m) + Cable Factor (dB)
3. Margin value = Emission level - Limit value
4. The other emission levels were very low against the limit.
5. "\*" : Fundamental frequency
6. "# " : The radiated frequency falling in the restricted band.



## STANDARD SECTION 15.407

<b>EUT</b>	IEEE 802.11a/g Wireless LAN Access Point	<b>MODEL</b>	AS-1250-ABG-EXT
<b>MODE</b>	Normal Mode	<b>CHANNEL</b>	5
<b>FREQUENCY RANGE</b>	1000MHz~40000MHz	<b>DETECTOR FUNCTION &amp; BANDWIDTH</b>	Peak (PK) Average (AV) 1 MHz
<b>ENVIRONMENTAL CONDITIONS</b>	28 deg. C, 52%RH, 979 hPa	<b>INPUT POWER (SYSTEM)</b>	120Vac, 60Hz
<b>TESTED BY</b>	Wen Yu		

**ANTENNA POLARITY & TEST DISTANCE: HORIZONTAL AT 3 M**

No.	Freq. (MHz)	Emission Level (dBuV/m)	Limit (dBuV/m)	Margin (dB)	Antenna Height (m)	Table Angle (Degree)	Raw Value (dBuV)	Correction Factor (dB/m)
1	*5260.00	100.10 PK			1.68 H	290	63.10	37.00
1	*5260.00	91.60 AV			1.68 H	290	54.60	37.00
2	10520.00	57.30 PK	68.30	-11.00	1.69 H	87	12.20	45.20

**ANTENNA POLARITY & TEST DISTANCE: VERTICAL AT 3 M**

No.	Freq. (MHz)	Emission Level (dBuV/m)	Limit (dBuV/m)	Margin (dB)	Antenna Height (m)	Table Angle (Degree)	Raw Value (dBuV)	Correction Factor (dB/m)
1	*5260.00	109.90 PK			1.21 V	81	72.90	37.00
1	*5260.00	101.80 AV			1.21 V	81	64.80	37.00
2	10520.00	61.30 PK	68.30	-7.00	1.16 V	97	16.10	45.20

**NOTE:**

1. Emission level = Raw value + Correction Factor
2. Correction Factor(dB/m) = Antenna Factor (dB/m) + Cable Factor (dB)
3. Margin value = Emission level - Limit value
4. The other emission levels were very low against the limit.
5. "\*" : Fundamental frequency
6. "# " : The radiated frequency falling in the restricted band.



## STANDARD SECTION 15.407

<b>EUT</b>	IEEE 802.11a/g Wireless LAN Access Point	<b>MODEL</b>	AS-1250-ABG-EXT
<b>MODE</b>	Normal Mode	<b>CHANNEL</b>	8
<b>FREQUENCY RANGE</b>	1000MHz~40000MHz	<b>DETECTOR FUNCTION &amp; BANDWIDTH</b>	Peak (PK) Average (AV) 1 MHz
<b>ENVIRONMENTAL CONDITIONS</b>	28 deg. C, 52%RH, 979 hPa	<b>INPUT POWER (SYSTEM)</b>	120Vac, 60Hz
<b>TESTED BY</b>	Wen Yu		

**ANTENNA POLARITY & TEST DISTANCE: HORIZONTAL AT 3 M**

No.	Freq. (MHz)	Emission Level (dBuV/m)	Limit (dBuV/m)	Margin (dB)	Antenna Height (m)	Table Angle (Degree)	Raw Value (dBuV)	Correction Factor (dB/m)
1	*5320.00	100.30 PK			1.83 H	275	63.30	37.00
1	*5320.00	92.70 AV			1.83 H	275	55.70	37.00
2	#5350.00	49.90 PK	74.00	-24.10	1.83 H	275	12.90	37.00
3	#10640.00	55.80 PK	74.00	-18.20	1.55 H	137	9.60	46.30
3	#10640.00	45.40 AV	54.00	-8.60	1.55 H	137	-0.90	46.30

**ANTENNA POLARITY & TEST DISTANCE: VERTICAL AT 3 M**

No.	Freq. (MHz)	Emission Level (dBuV/m)	Limit (dBuV/m)	Margin (dB)	Antenna Height (m)	Table Angle (Degree)	Raw Value (dBuV)	Correction Factor (dB/m)
1	*5320.00	109.10 PK			1.06 V	73	72.00	37.00
1	*5320.00	100.50 AV			1.06 V	73	63.50	37.00
2	#5350.00	58.70 PK	74.00	-15.30	1.06 V	73	21.70	37.00
<b>2</b>	<b>#5350.00</b>	<b>50.10 AV</b>	<b>54.00</b>	<b>-3.90</b>	<b>1.06 V</b>	<b>73</b>	<b>13.10</b>	<b>37.00</b>
3	#10640.00	60.90 PK	74.00	-13.10	1.32 V	97	14.60	46.30
3	#10640.00	49.20 AV	54.00	-4.80	1.32 V	97	3.00	46.30

**NOTE:**

1. Emission level = Raw value + Correction Factor
2. Correction Factor(dB/m) = Antenna Factor (dB/m) + Cable Factor (dB)
3. Margin value = Emission level - Limit value
4. The other emission levels were very low against the limit.
5. "\*" : Fundamental frequency
6. "# " : The radiated frequency falling in the restricted band.



## STANDARD SECTION 15.247

<b>EUT</b>	IEEE 802.11a/g Wireless LAN Access Point	<b>MODEL</b>	AS-1250-ABG-EXT
<b>MODE</b>	Normal Mode	<b>CHANNEL</b>	9
<b>FREQUENCY RANGE</b>	1000MHz~40000MHz	<b>DETECTOR FUNCTION &amp; BANDWIDTH</b>	Peak (PK) Average (AV) 1 MHz
<b>ENVIRONMENTAL CONDITIONS</b>	25 deg. C, 77%RH, 979 hPa	<b>INPUT POWER (SYSTEM)</b>	120Vac, 60Hz
<b>TESTED BY</b>	Wen Yu		

**ANTENNA POLARITY & TEST DISTANCE: HORIZONTAL AT 3 M**

No.	Freq. (MHz)	Emission Level (dBuV/m)	Limit (dBuV/m)	Margin (dB)	Antenna Height (m)	Table Angle (Degree)	Raw Value (dBuV)	Correction Factor (dB/m)
1	*5745.00	100.50 PK			1.04 H	22	62.90	37.60
1	*5745.00	92.30 AV			1.04 H	22	54.70	37.60
2	#11490.00	62.60 PK	74.00	-11.40	1.37 H	93	11.30	51.30
2	#11490.00	50.60 AV	54.00	-3.40	1.37 H	93	-0.70	51.30

**ANTENNA POLARITY & TEST DISTANCE: VERTICAL AT 3 M**

No.	Freq. (MHz)	Emission Level (dBuV/m)	Limit (dBuV/m)	Margin (dB)	Antenna Height (m)	Table Angle (Degree)	Raw Value (dBuV)	Correction Factor (dB/m)
1	*5745.00	105.20 PK			1.29 V	63	67.60	37.60
1	*5745.00	96.80 AV			1.29 V	63	59.20	37.60
2	#11490.00	63.90 PK	74.00	-10.10	1.32 V	301	12.60	51.30
2	#11490.00	52.90 AV	54.00	-1.10	1.32 V	301	1.60	51.30

**NOTE:**

- Emission level = Raw value + Correction Factor
- Correction Factor(dB/m) = Antenna Factor (dB/m) + Cable Factor (dB)
- Margin value = Emission level - Limit value
- The other emission levels were very low against the limit.
- "\*": Fundamental frequency
- "#": The radiated frequency falling in the restricted band.



## STANDARD SECTION 15.247

<b>EUT</b>	IEEE 802.11a/g Wireless LAN Access Point	<b>MODEL</b>	AS-1250-ABG-EXT
<b>MODE</b>	Normal Mode	<b>CHANNEL</b>	11
<b>FREQUENCY RANGE</b>	1000MHz~40000MHz	<b>DETECTOR FUNCTION &amp; BANDWIDTH</b>	Peak (PK) Average (AV) 1 MHz
<b>ENVIRONMENTAL CONDITIONS</b>	24 deg. C, 54%RH, 979 hPa	<b>INPUT POWER (SYSTEM)</b>	120Vac, 60Hz
<b>TESTED BY</b>	Wen Yu		

**ANTENNA POLARITY & TEST DISTANCE: HORIZONTAL AT 3 M**

No.	Freq. (MHz)	Emission Level (dBuV/m)	Limit (dBuV/m)	Margin (dB)	Antenna Height (m)	Table Angle (Degree)	Raw Value (dBuV)	Correction Factor (dB/m)
1	*5785.00	100.00 PK			1.19 H	316	62.40	37.60
1	*5785.00	91.80 AV			1.19 H	316	54.20	37.60
2	#11570.00	62.20 PK	74.00	-11.80	1.27 H	302	11.00	51.10
2	#11570.00	50.10 AV	54.00	-3.90	1.27 H	302	-1.00	51.10

**ANTENNA POLARITY & TEST DISTANCE: VERTICAL AT 3 M**

No.	Freq. (MHz)	Emission Level (dBuV/m)	Limit (dBuV/m)	Margin (dB)	Antenna Height (m)	Table Angle (Degree)	Raw Value (dBuV)	Correction Factor (dB/m)
1	*5785.00	105.50 PK			1.06 V	274	67.90	37.60
1	*5785.00	96.90 AV			1.06 V	274	59.30	37.60
2	#11570.00	63.60 PK	74.00	-10.40	1.45 V	221	12.50	51.10
2	#11570.00	52.70 AV	54.00	-1.30	1.45 V	221	1.60	51.10

**NOTE:**

1. Emission level = Raw value + Correction Factor
2. Correction Factor(dB/m) = Antenna Factor (dB/m) + Cable Factor (dB)
3. Margin value = Emission level - Limit value
4. The other emission levels were very low against the limit.
5. "\*" : Fundamental frequency
6. "# " : The radiated frequency falling in the restricted band.





## .STANDARD SECTION 15.247

<b>EUT</b>	IEEE 802.11a/g Wireless LAN Access Point	<b>MODEL</b>	AS-1250-ABG-EXT
<b>MODE</b>	Normal Mode	<b>CHANNEL</b>	13
<b>FREQUENCY RANGE</b>	1000MHz~40000MHz	<b>DETECTOR FUNCTION &amp; BANDWIDTH</b>	Peak (PK) Average (AV) 1 MHz
<b>ENVIRONMENTAL CONDITIONS</b>	25 deg. C, 77%RH, 979 hPa	<b>INPUT POWER (SYSTEM)</b>	120Vac, 60Hz
<b>TESTED BY</b>	Wen Yu		

**ANTENNA POLARITY & TEST DISTANCE: HORIZONTAL AT 3 M**

No.	Freq. (MHz)	Emission Level (dBuV/m)	Limit (dBuV/m)	Margin (dB)	Antenna Height (m)	Table Angle (Degree)	Raw Value (dBuV)	Correction Factor (dB/m)
1	*5825.00	100.40 PK			1.00 H	25	62.70	37.70
1	*5825.00	91.10 AV			1.00 H	25	53.40	37.70
2	#11650.00	62.60 PK	74.00	-11.40	1.48 H	3	11.80	50.80
2	#11650.00	51.30 AV	54.00	-2.70	1.48 H	3	0.50	50.80

**ANTENNA POLARITY & TEST DISTANCE: VERTICAL AT 3 M**

No.	Freq. (MHz)	Emission Level (dBuV/m)	Limit (dBuV/m)	Margin (dB)	Antenna Height (m)	Table Angle (Degree)	Raw Value (dBuV)	Correction Factor (dB/m)
1	*5825.00	105.20 PK			1.17 V	270	67.50	37.70
1	*5825.00	96.70 AV			1.17 V	270	58.90	37.70
2	#11650.00	64.30 PK	74.00	-9.70	1.29 V	304	13.50	50.80
<b>2</b>	<b>#11650.00</b>	<b>52.90 AV</b>	<b>54.00</b>	<b>-1.10</b>	<b>1.29 V</b>	<b>304</b>	<b>2.10</b>	<b>50.80</b>

**NOTE:**

1. Emission level = Raw value + Correction Factor
2. Correction Factor(dB/m) = Antenna Factor (dB/m) + Cable Factor (dB)
3. Margin value = Emission level - Limit value
4. The other emission levels were very low against the limit.
5. "\*" : Fundamental frequency
6. "# " : The radiated frequency falling in the restricted band.



## FOR FREQUENCY 5.15~5.35GHZ

### 5.3 PEAK TRANSMIT POWER MEASUREMENT

#### 5.3.1 LIMITS OF PEAK TRANSMIT POWER MEASUREMENT

Frequency Band	Limit
5.15 – 5.25 GHz	The lesser of 50mW (17dBm) or 4dBm + 10logB
5.25 – 5.35 GHz	The lesser of 250mW (24dBm) or 11dBm + 10logB

**Note:**

1. Where B is the 26dB emission bandwidth in MHz.
2. Limit follows whichever is lower.
3. 5.15-5.25GHz: In addition, the peak power spectral density shall not exceed 4 dBm in any 1-MHz band. If transmitting antennas of directional gain greater than 6 dBi are used, both the peak transmit power and the peak power spectral density shall be reduced by the amount in dB that the directional gain of the antenna exceeds 6 dBi.
4. 5.25-5.35GHz: In addition, the peak power spectral density shall not exceed 11 dBm in any 1-MHz band. If transmitting antennas of directional gain greater than 6 dBi are used, both the peak transmit power and the peak power spectral density shall be reduced by the amount in dB that the directional gain of the antenna exceeds 6 dBi.

#### 5.3.2 TEST INSTRUMENTS

Description & Manufacturer	Model No.	Serial No.	Calibrated Until
R&S SPECTRUM ANALYZER	FSP30	100019	Dec. 19, 2004

**NOTE:**

The calibration interval of the above test instruments is 12 months and the calibrations are traceable to NML/ROC and NIST/USA.



### 5.3.3 TEST PROCEDURE

1. The transmitter output was connected to the spectrum analyzer.
2. Set span to encompass the entire emission bandwidth of the signal.
3. Set RBW to 1MHz, VBW to 300kHz.
4. Using the spectrum analyzer's channel power measurement function to measure the output power.

### 5.3.4 TEST SETUP

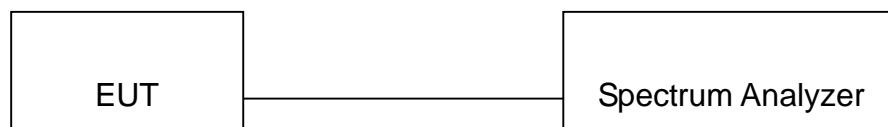

### 5.3.5 EUT OPERATING CONDITIONS

The software provided by client to enable the EUT under transmission condition continuously at specific channel frequencies individually.



## 5.3.6 TEST RESULTS

<b>EUT</b>	IEEE 802.11a/g Wireless LAN Access Point	<b>MODEL</b>	AS-1250-ABG-EXT
<b>MODE</b>	Normal	<b>INPUT POWER (SYSTEM)</b>	120Vac, 60 Hz
<b>ENVIRONMENTAL CONDITIONS</b>	25 deg. C, 65%RH, 979 hPa	<b>TESTED BY</b>	Sky Liao

**Antenna Gain 7.4 dBi**

<b>CHANNEL</b>	<b>CHANNEL FREQUENCY (MHz)</b>	<b>PEAK POWER OUTPUT (dBm)</b>	<b>PEAK POWER LIMIT (dBm)</b>	<b>26dBc Occupied Bandwidth (MHz)</b>	<b>PASS/FAIL</b>
1	5180	15.05	15.60	24.16	PASS
4	5240	15.32	15.60	25.28	PASS
5	5260	21.00	22.60	30.16	PASS
8	5320	20.48	22.60	27.44	PASS



CHANNEL 1

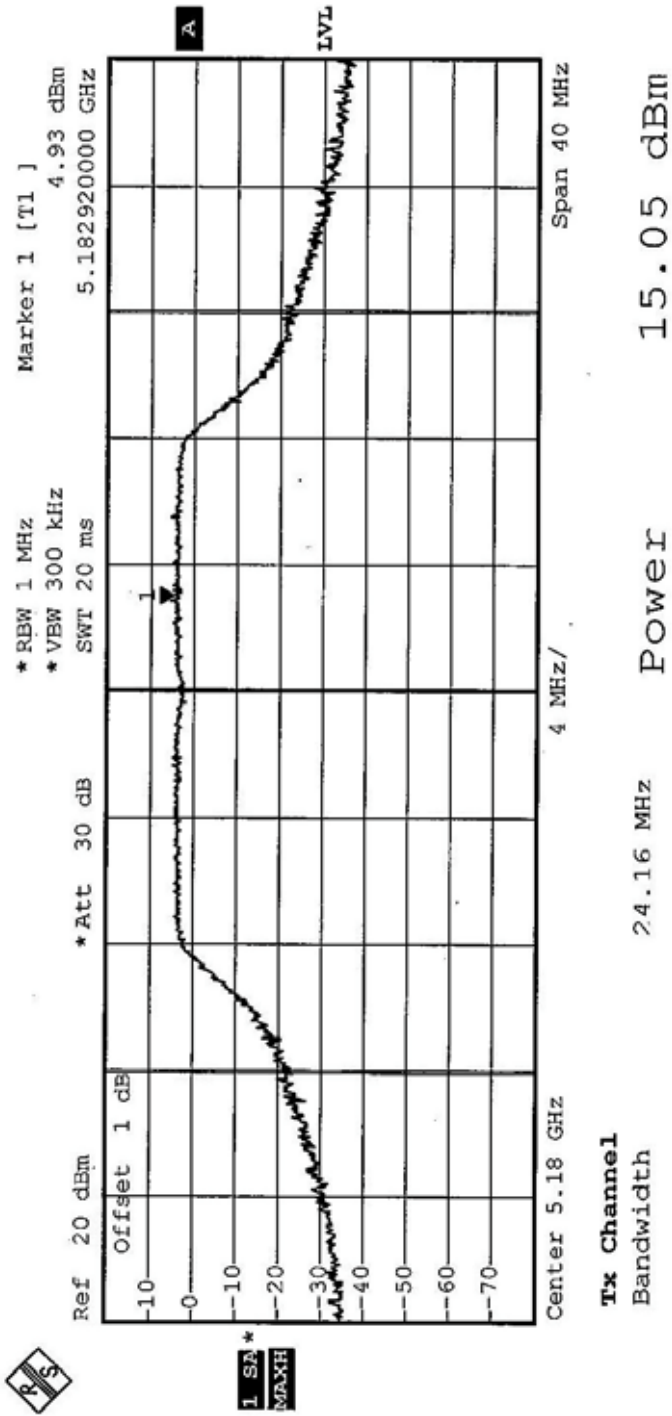



CHANNEL 4

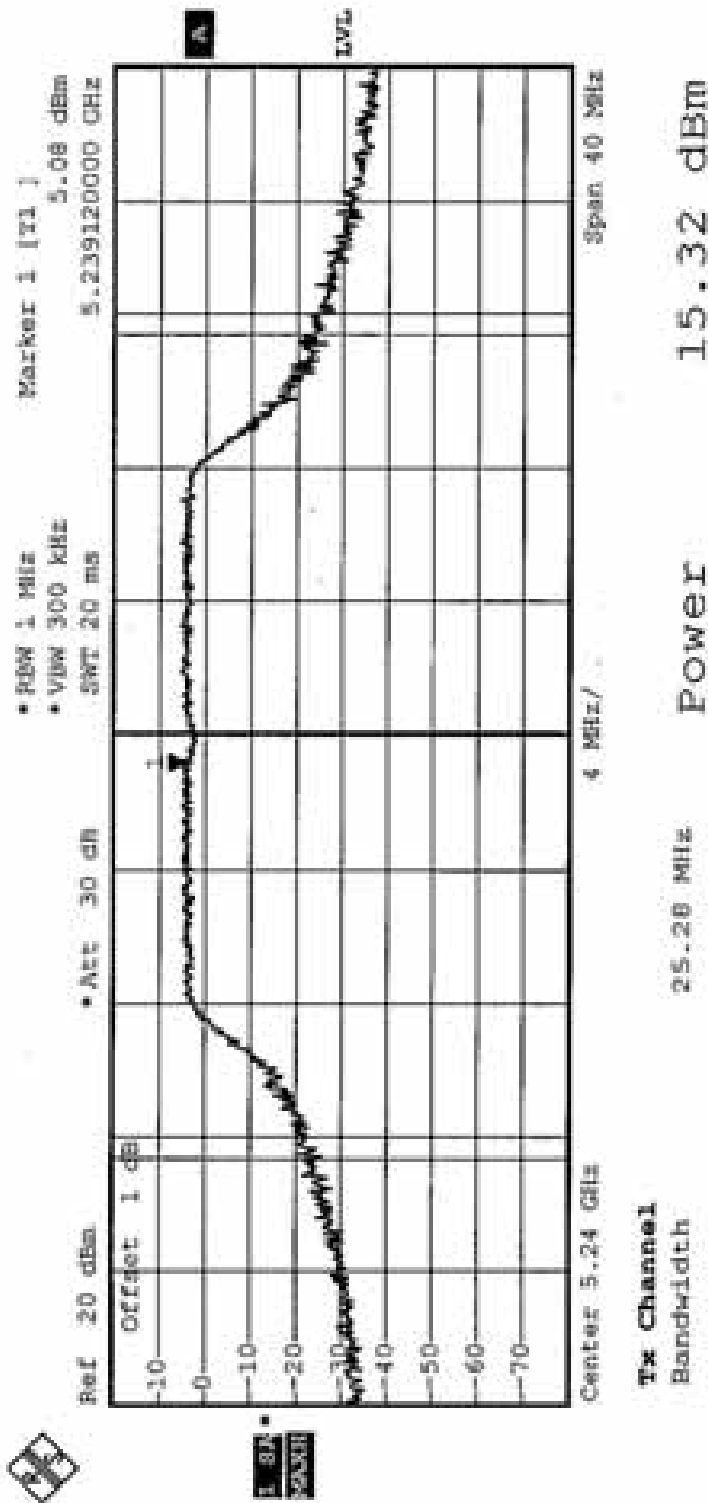



CHANNEL 5

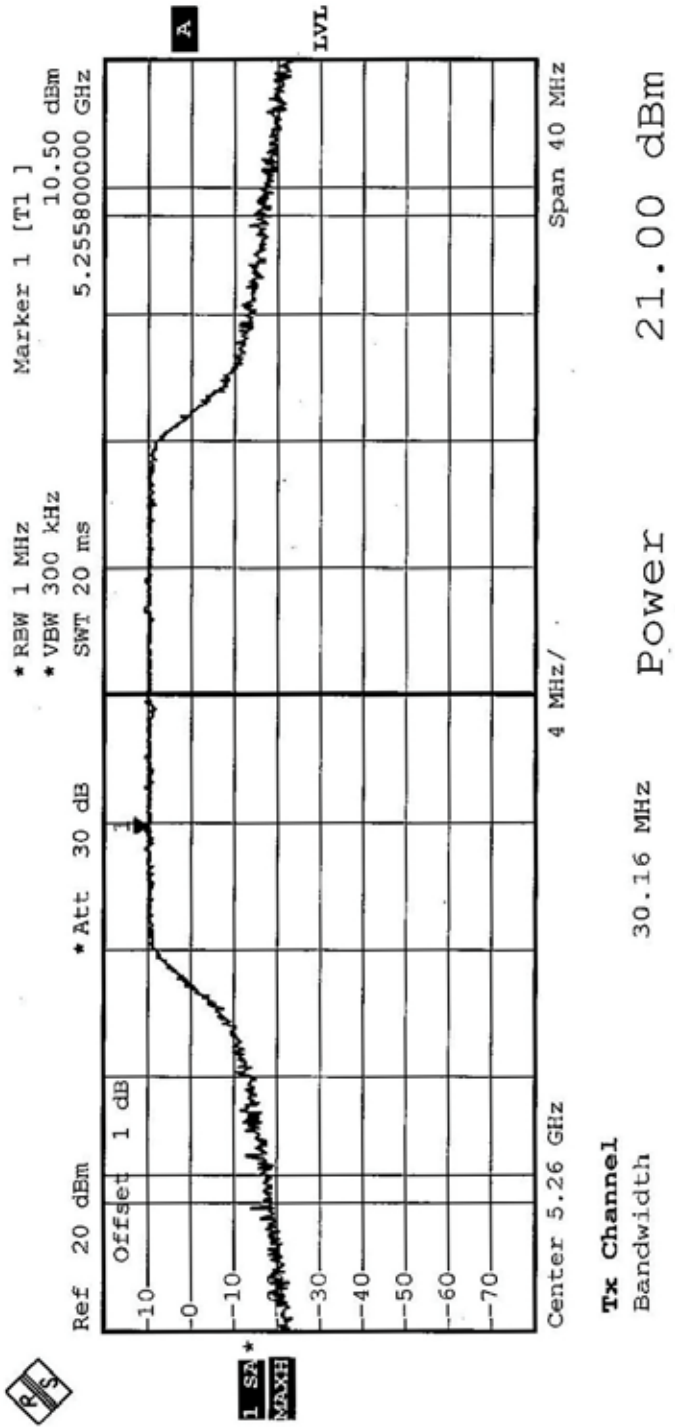



CHANNEL 8

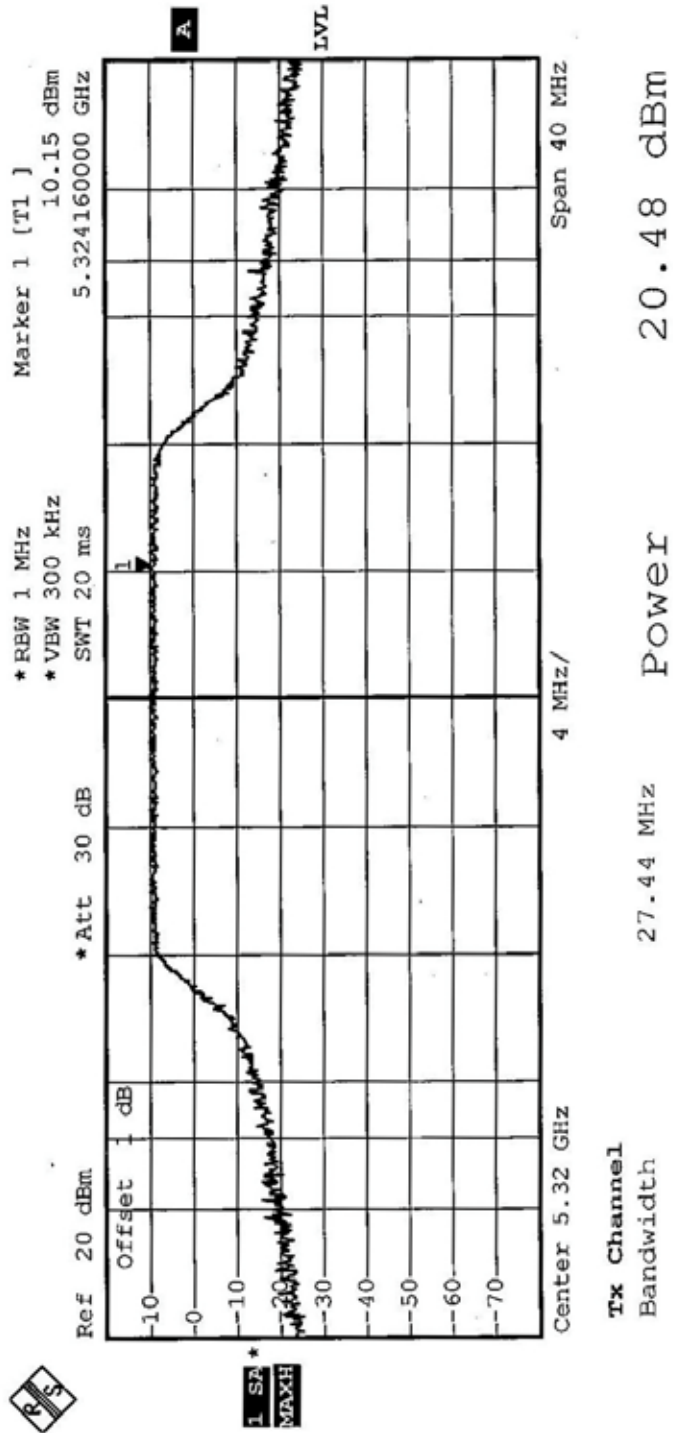





CHANNEL 1

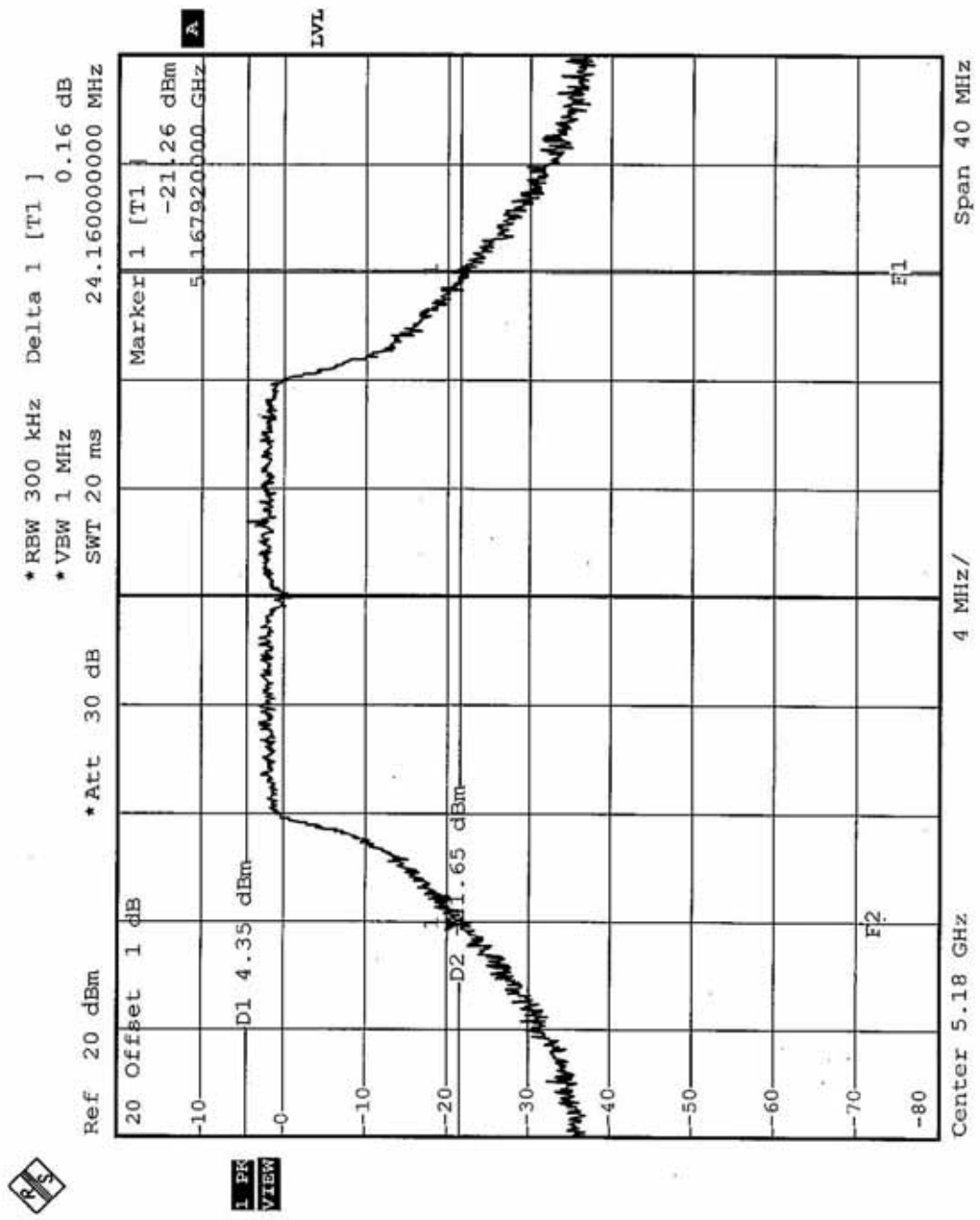



CHANNEL 4

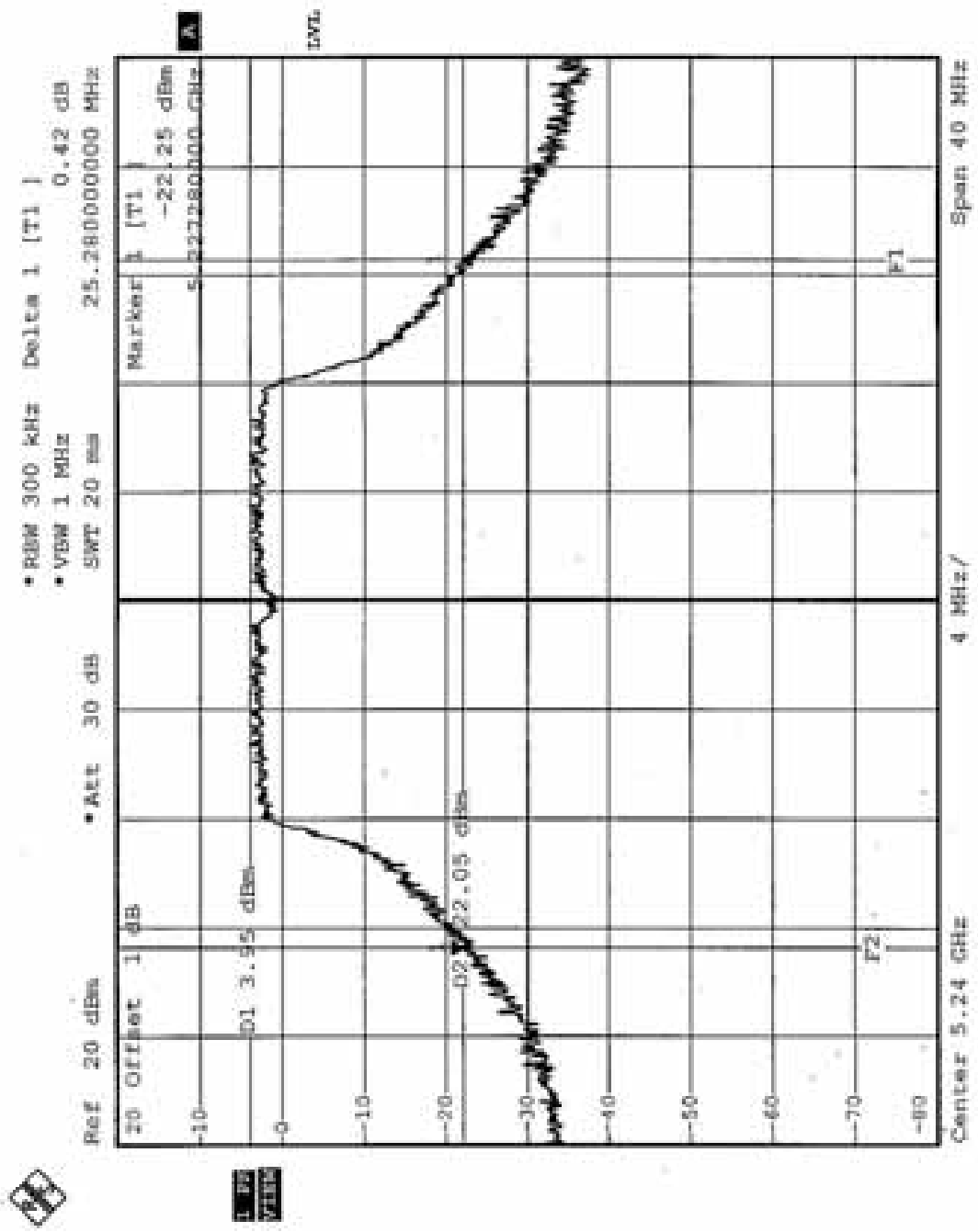



CHANNEL 5

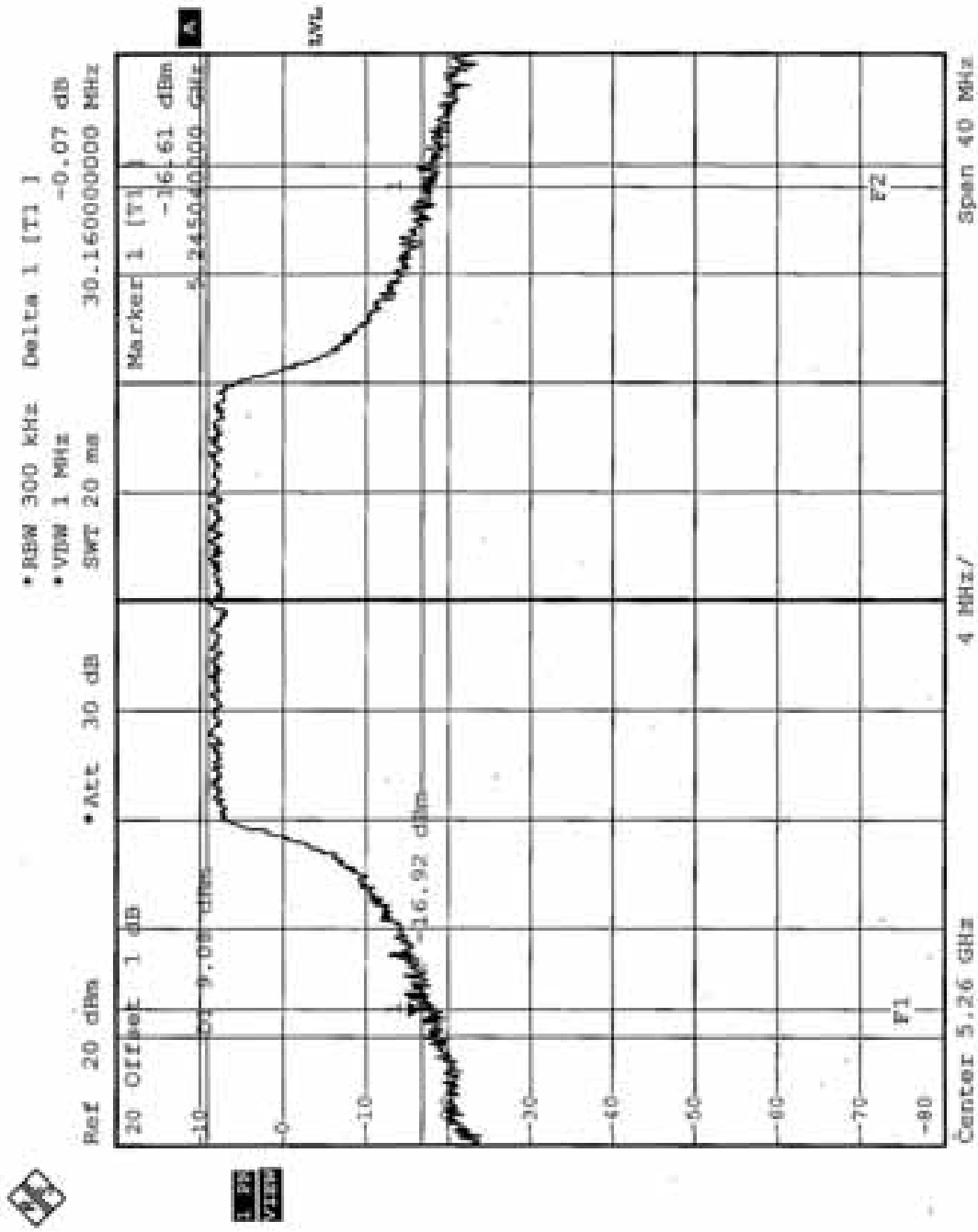



CHANNEL 8

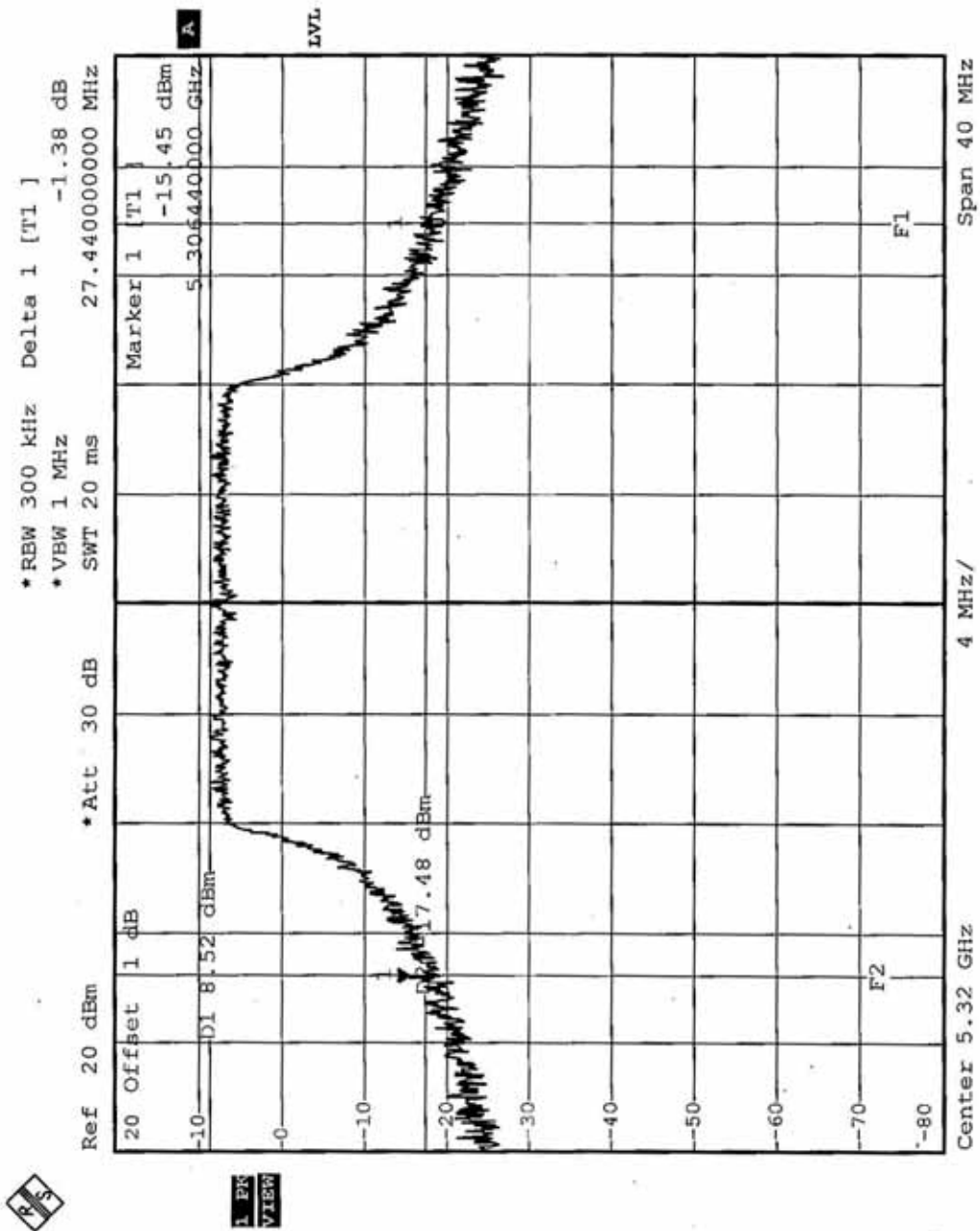



## 5.4 PEAK POWER EXCURSION MEASUREMENT

### 5.4.1 LIMITS OF PEAK POWER EXCURSION MEASUREMENT

Frequency Band	Limit
5.15 – 5.25 GHz	13dB
5.25 – 5.35 GHz	13dB
5.725 – 5.825 GHz	13dB

### 5.4.2 TEST INSTRUMENTS

Description & Manufacturer	Model No.	Serial No.	Calibrated Until
R&S SPECTRUM ANALYZER	FSP30	100019	Dec. 19, 2004

**NOTE:**

The calibration interval of the above test instruments is 12 months and the calibrations are traceable to NML/ROC and NIST/USA.



### 5.4.3 TEST PROCEDURE

1. The transmitter output was connected to the spectrum analyzer.
2. Set span to encompass the entire emission bandwidth of the signal.
3. Set spectrum analyzer to following condition:

	RBW	VBW	Detector
Trace 1	1MHz	3MHz	Peak Mode
Trace 2	1MHz	300KHz	Sample Mode

4. Using the spectrum analyzer's channel power measurement function to measure the output power.

### 5.4.4 DEVIATION FROM TEST STANDARD

No deviation

### 5.4.5 TEST SETUP

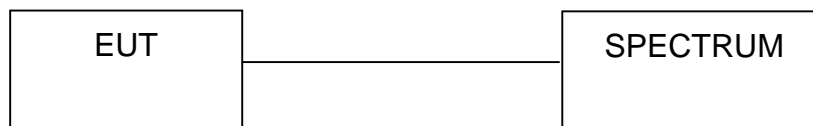

### 5.4.6 EUT OPERATING CONDITIONS

The software provided by client to enable the EUT under transmission condition continuously at specific channel frequencies individually.



## 5.4.7 TEST RESULTS

<b>EUT</b>	IEEE 802.11a/g Wireless LAN Access Point	<b>MODEL</b>	AS-1250-ABG-EXT
<b>MODE</b>	Normal	<b>INPUT POWER (SYSTEM)</b>	120Vac, 60 Hz
<b>ENVIRONMENTAL CONDITIONS</b>	25 deg. C, 65%RH, 979 hPa	<b>TESTED BY</b>	Sky Liao

<b>CHANNEL</b>	<b>CHANNEL FREQUENCY (MHz)</b>	<b>PEAK POWER EXCURSION (dB)</b>	<b>PEAK to AVERAGE EXCURSION LIMIT (dB)</b>	<b>PASS/FAIL</b>
1	5180	5.42	13	PASS
4	5240	6.72	13	PASS
5	5260	8.18	13	PASS
8	5320	4.53	13	PASS



CHANNEL 1

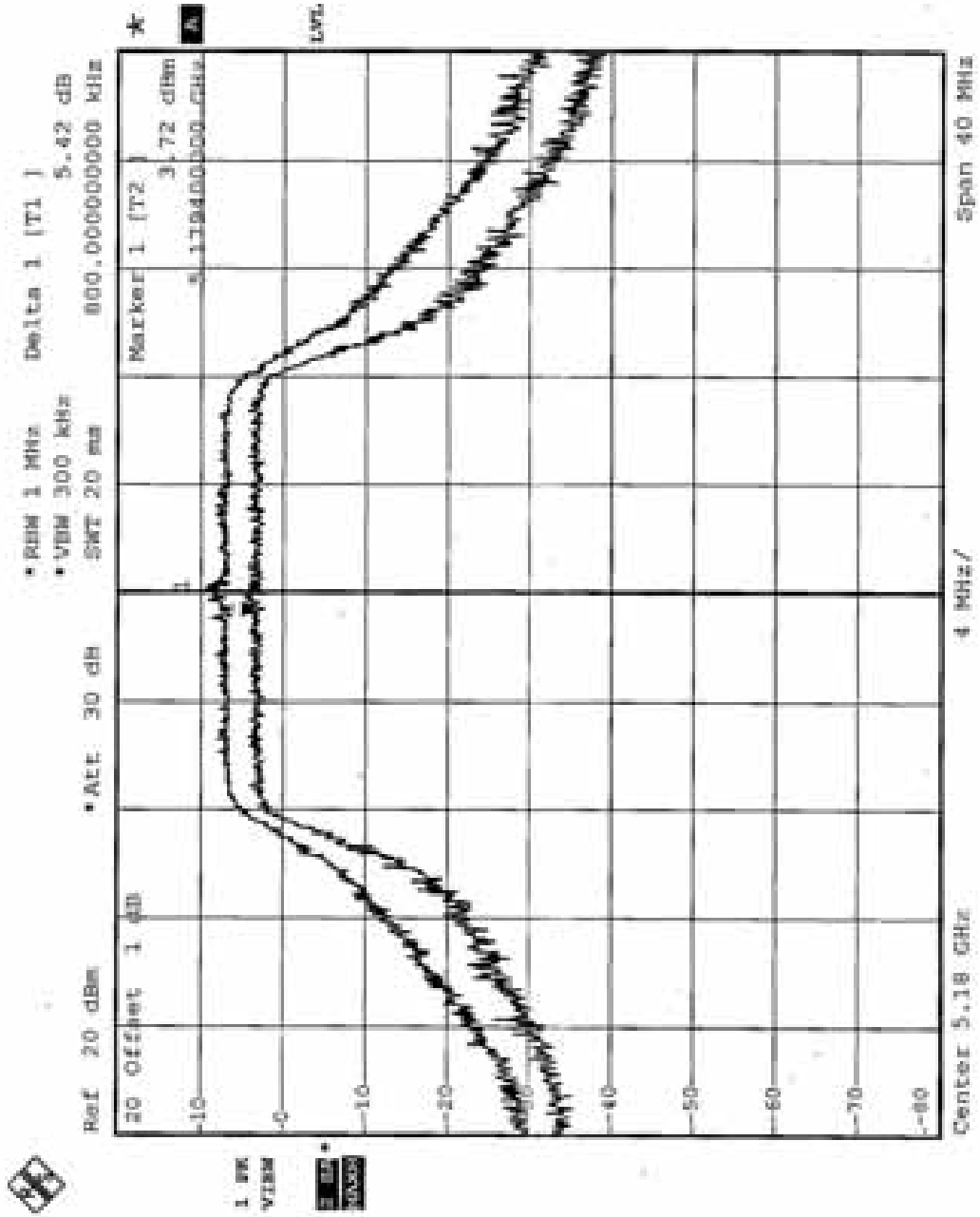





CHANNEL 4

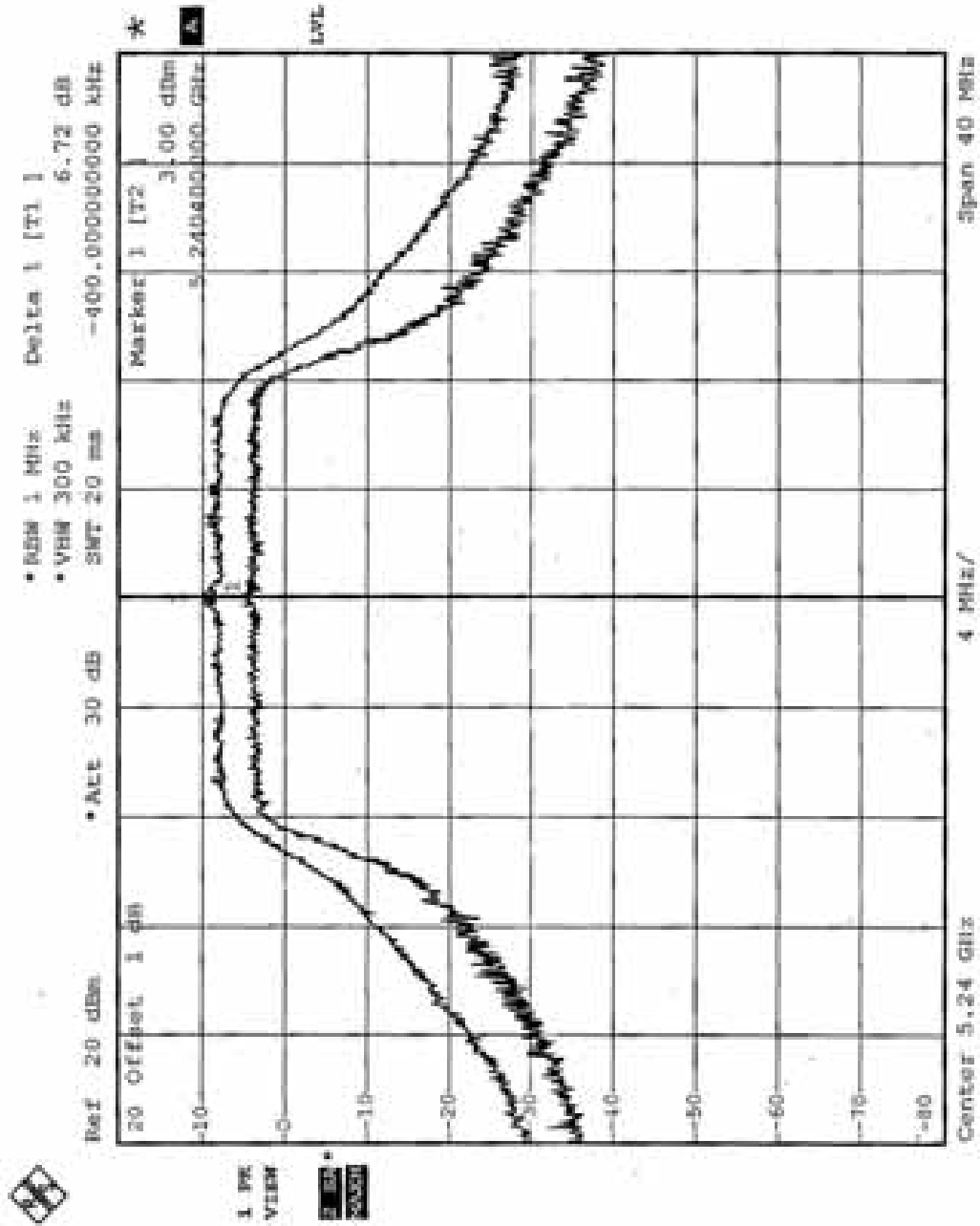



CHANNEL 5

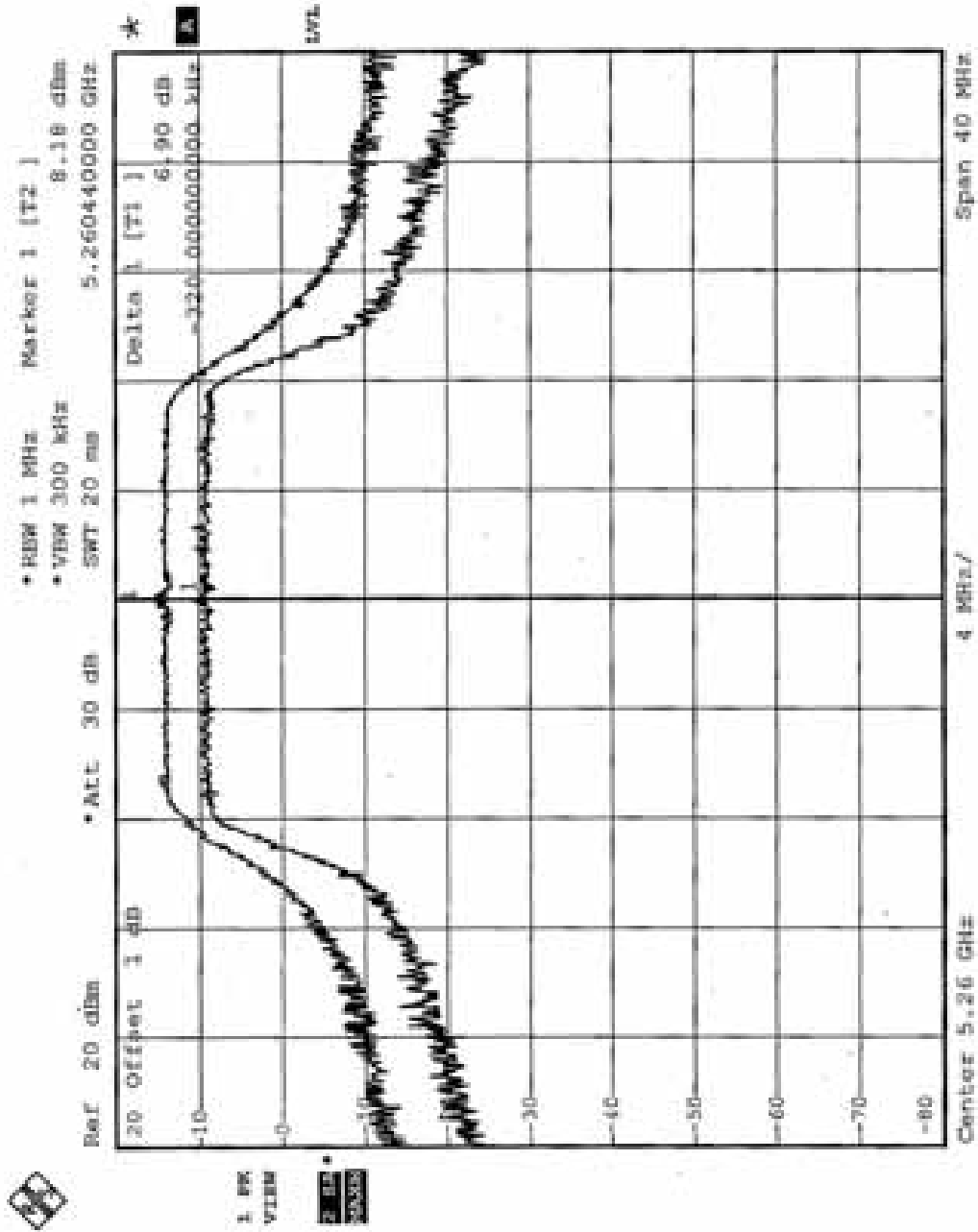



CHANNEL 8

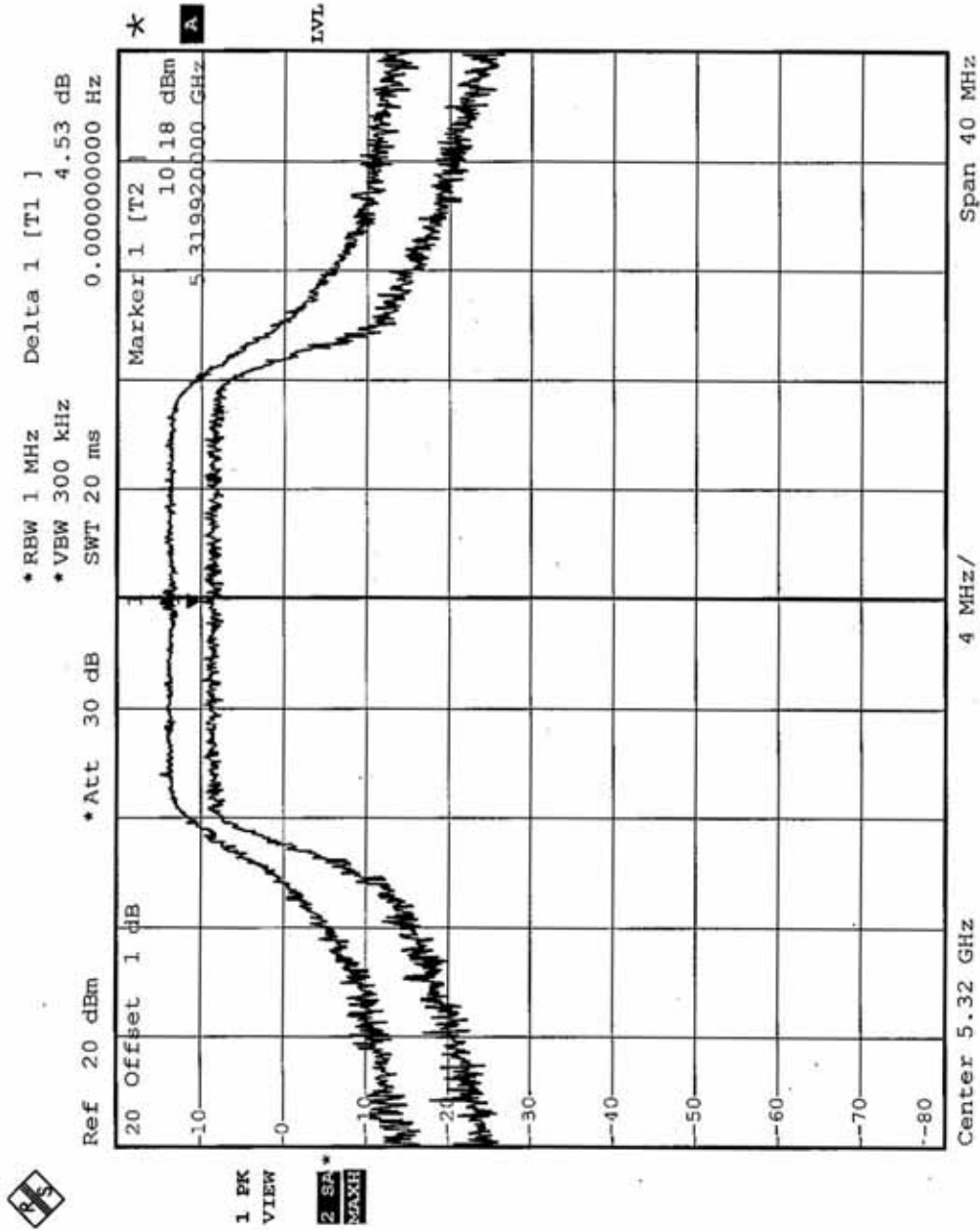



## 5.5 PEAK POWER SPECTRAL DENSITY MEASUREMENT

### 5.5.1 LIMITS OF PEAK POWER SPECTRAL DENSITY MEASUREMENT

Frequency Band	Limit
5.15 – 5.25 GHz	4dBm
5.25 – 5.35 GHz	11dBm
5.725 – 5.825 GHz	17dBm

### 5.5.2 TEST INSTRUMENTS

Description & Manufacturer	Model No.	Serial No.	Calibrated Until
R&S SPECTRUM ANALYZER	FSP30	100019	Dec. 19, 2004

**NOTE:**

The calibration interval of the above test instruments is 12 months and the calibrations are traceable to NML/ROC and NIST/USA.



### 5.5.3 TEST PROCEDURES

The transmitter output was connected to the spectrum analyzer.  
Set RBW=1MHz, VBW=3MHz. The PPSD is the highest level found across the emission in any 1MHz band.

### 5.5.4 DEVIATION FROM TEST STANDARD

No deviation

### 5.5.5 TEST SETUP



### 5.5.6 EUT OPERATING CONDITIONS

Same as 5.3.6



## 5.5.7 TEST RESULTS

<b>EUT</b>	IEEE 802.11a/g Wireless LAN Access Point	<b>MODEL</b>	AS-1250-ABG-EXT
<b>MODE</b>	Normal	<b>INPUT POWER (SYSTEM)</b>	120Vac, 60 Hz
<b>ENVIRONMENTAL CONDITIONS</b>	25 deg. C, 65%RH, 979 hPa	<b>TESTED BY</b>	Sky Liao

## Antenna Gain 7.4 dBi

CHANNEL NUMBER	CHANNEL FREQUENCY (MHz)	RF POWER LEVEL IN 1 MHz BW (dBm)	MAXIMUM LIMIT (dBm)	PASS/FAIL
1	5180	-1.72	2.6	PASS
4	5240	-1.05	2.6	PASS
5	5260	3.97	9.6	PASS
8	5320	3.84	9.6	PASS



CHANNEL 1

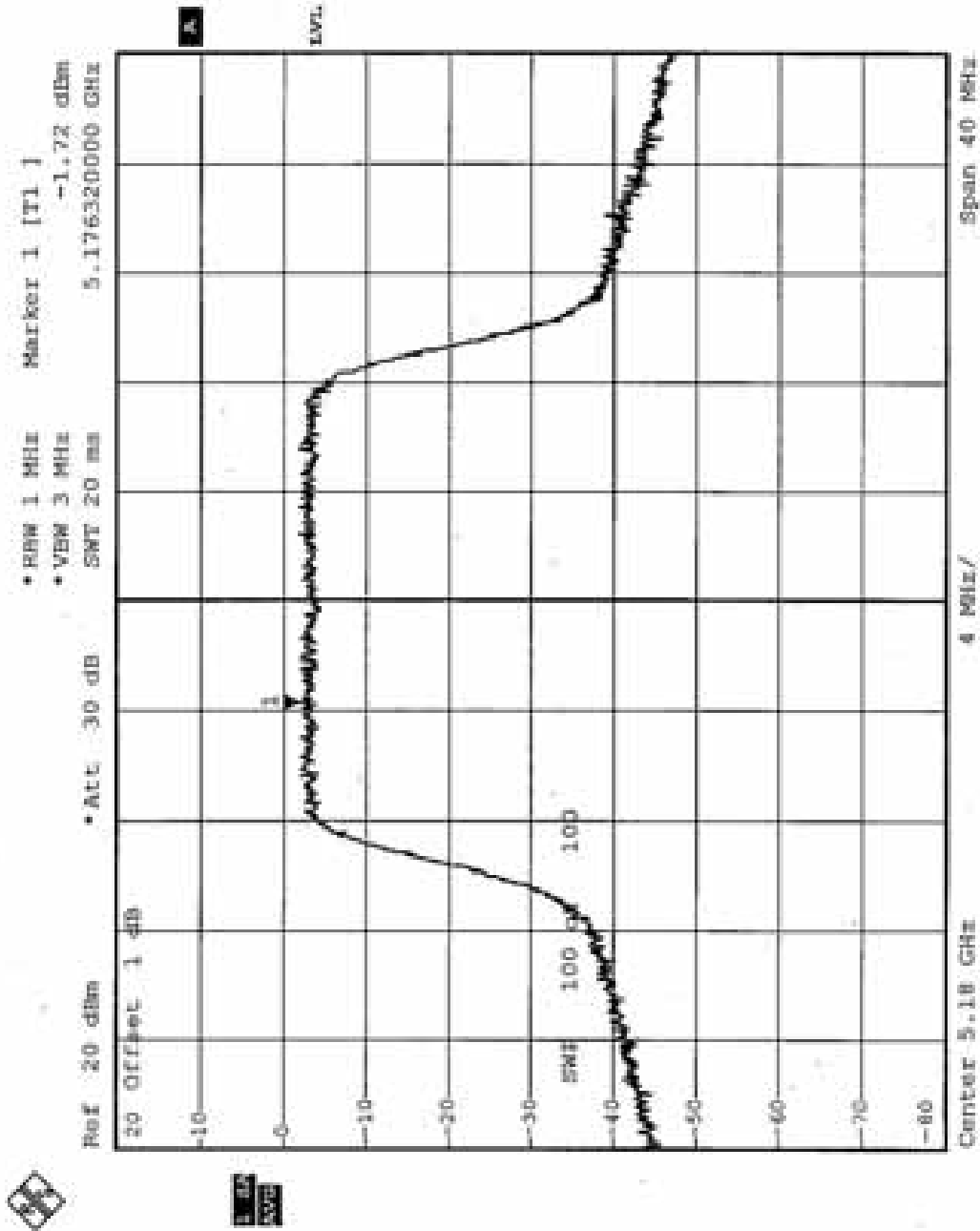



CHANNEL 4

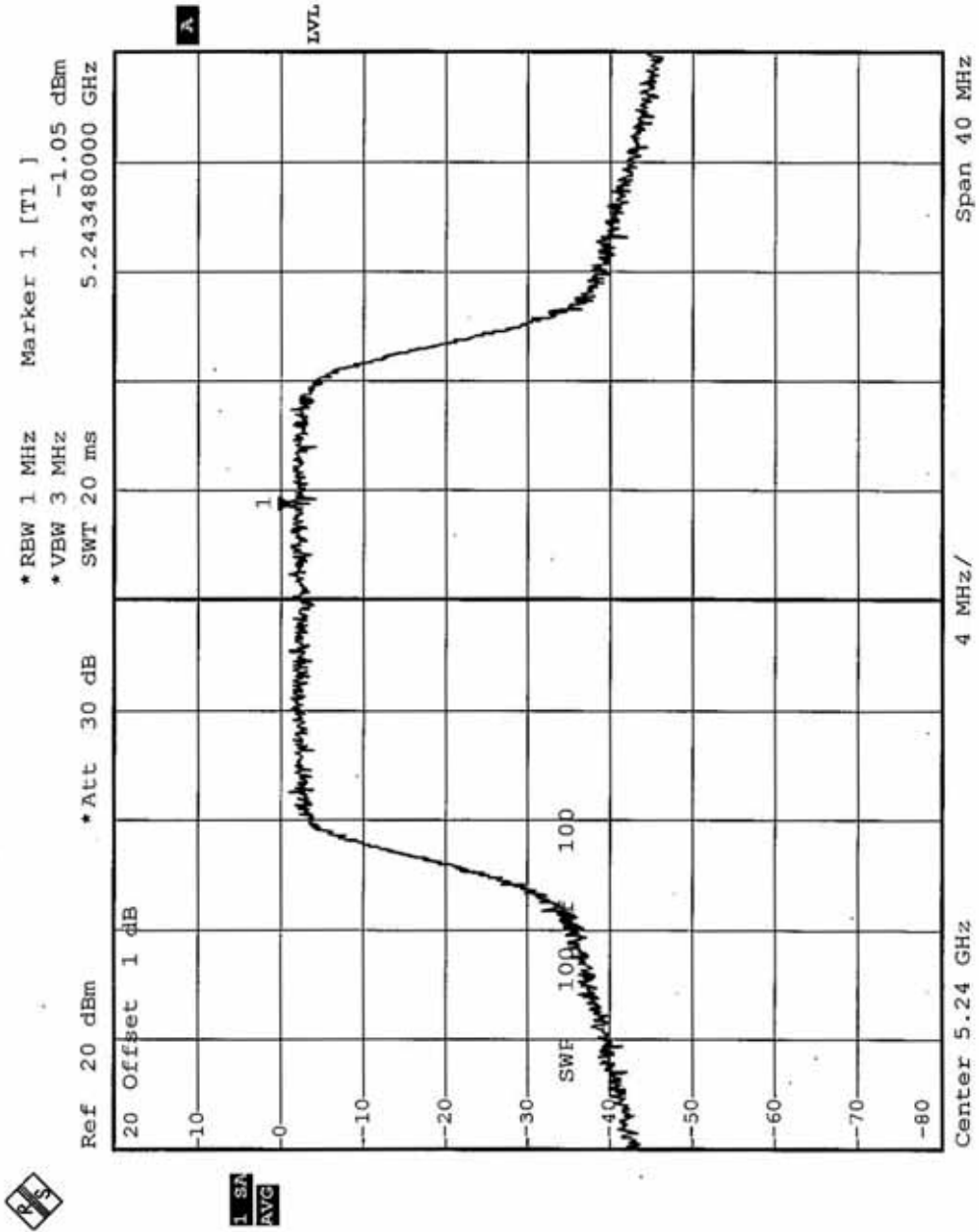





CHANNEL 5

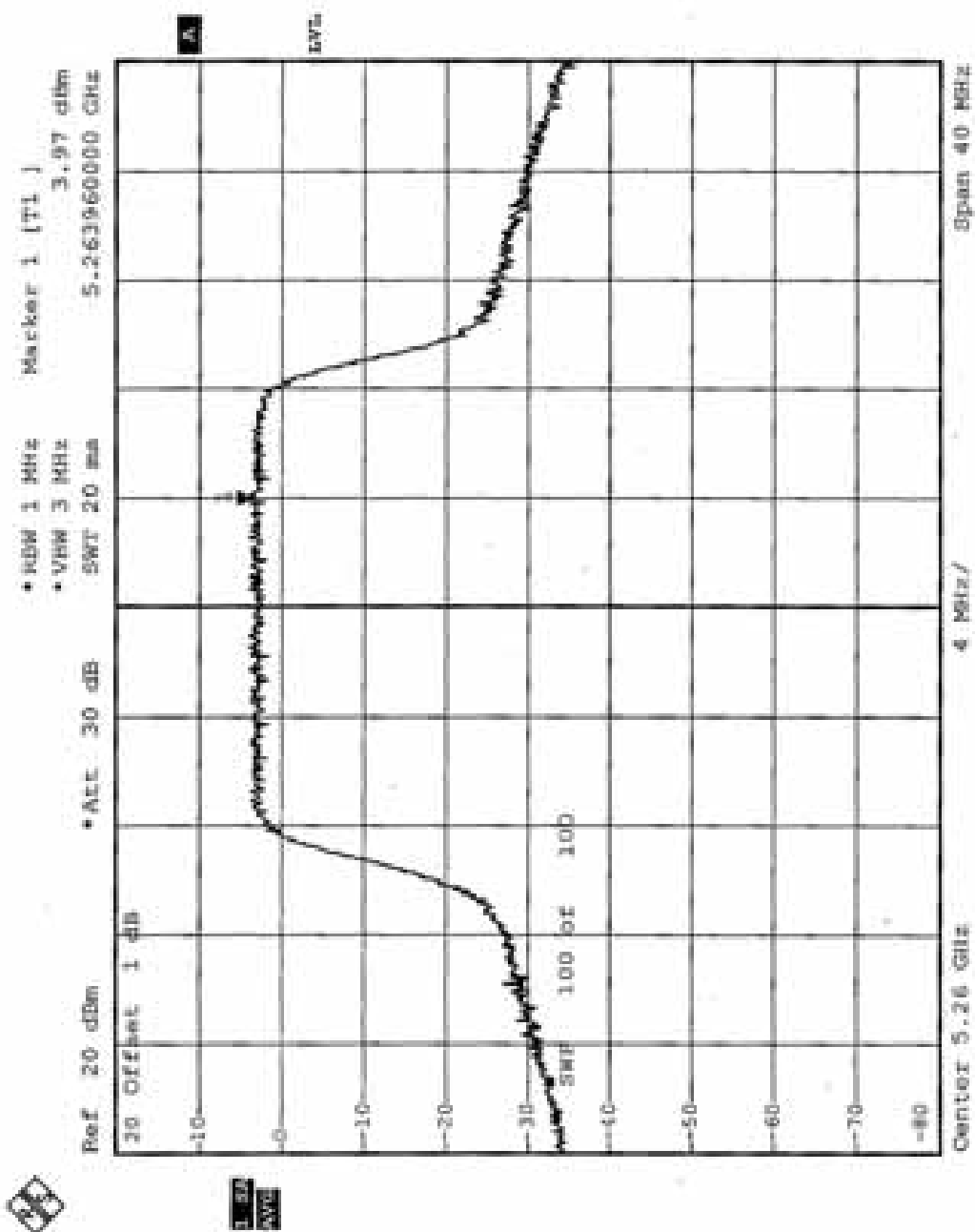



CHANNEL 8

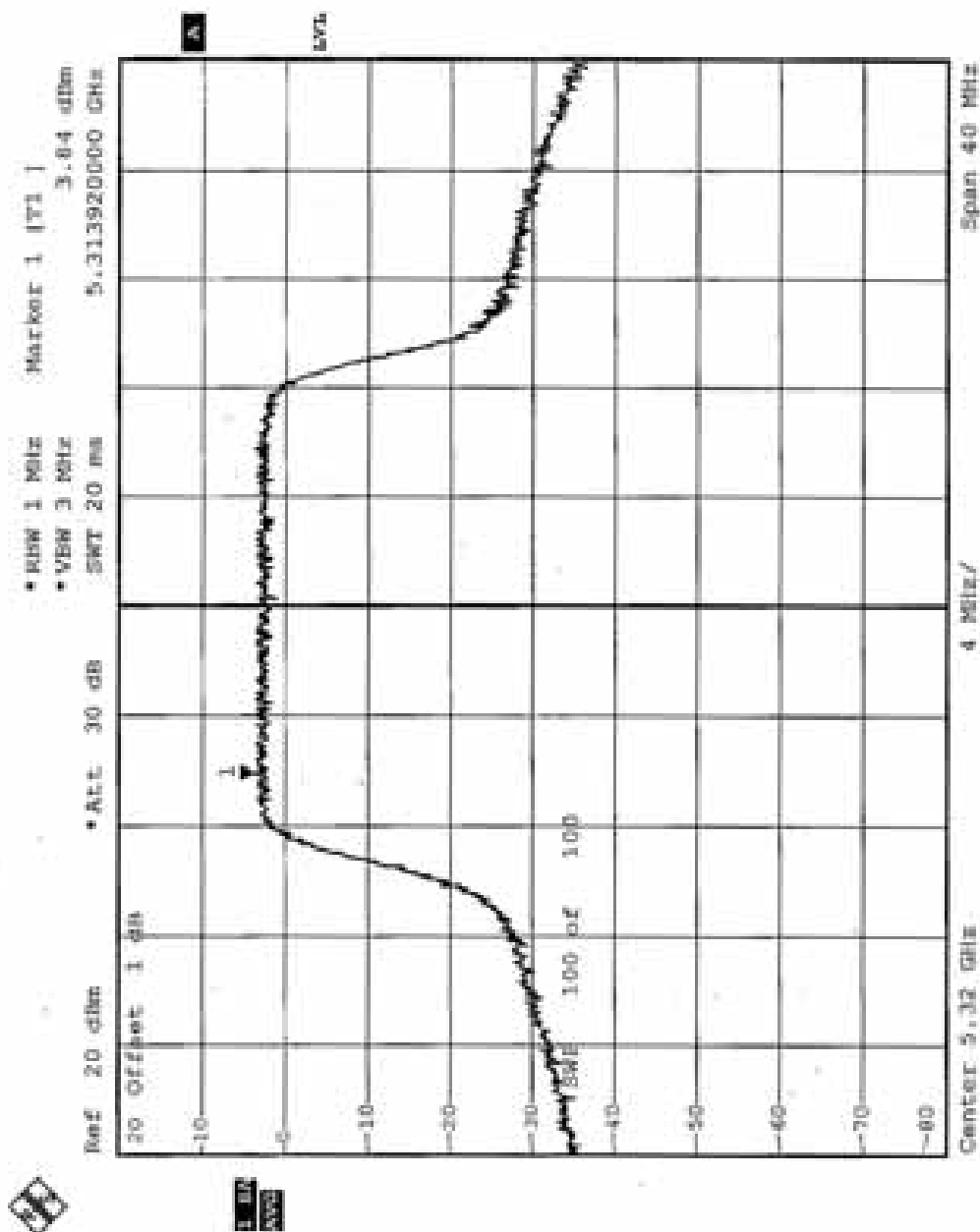



## 5.6 FREQUENCY STABILITY

### 5.6.1 LIMITS OF FREQUENCY STABILITY MEASUREMENT

The frequency tolerance of the carrier signal shall be maintained within +/- 0.02% of the operating frequency over a temperature variation of -30 degrees to 50 degrees C at normal supply voltage, and for a variation in the primary supply voltage from 85% to 115% of the rated supply voltage at a temperature of 20 degrees C.

### 5.6.2 TEST INSTRUMENTS

Description & Manufacturer	Model No.	Serial No.	Calibrated Until
R&S SPECTRUM ANALYZER	FSP30	100019	Dec. 19, 2004

**NOTE:**

The calibration interval of the above test instruments is 12 months and the calibrations are traceable to NML/ROC and NIST/USA.

### 5.6.3 TEST PROCEDURE

1. The EUT was placed inside the environmental test chamber and powered by nominal AC voltage.
2. Turn the EUT on and couple its output to a spectrum analyzer.
3. Turn the EUT off and set the chamber to the highest temperature specified.
4. Allow sufficient time (approximately 30 min) for the temperature of the chamber to stabilize, turn the EUT on and measure the operating frequency after 2, 5, and 10 minutes.
5. Repeat step 2 and 3 with the temperature chamber set to the lowest temperature.
6. The test chamber was allowed to stabilize at +20 degree C for a minimum of 30 minutes. The supply voltage was then adjusted on the EUT from 85% to 115% and the frequency record.

### 5.6.4 DEVIATION FROM TEST STANDARD

No deviation

### 5.6.5 TEST SETUP

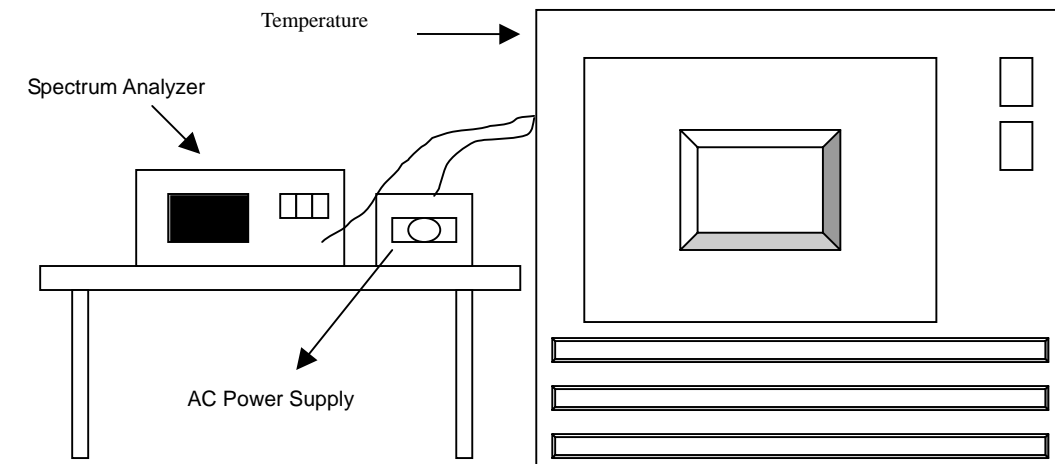

### 5.6.6 EUT OPERATING CONDITION

Same as Item 4.1.6



## 5.6.7 TEST RESULTS

		Operating frequency: 5320MHz				Limit : $\pm 0.02\%$	
Temp. ( )	Power supply (VAC)	2 minute		5 minute		10 minute	
		(MHz)	(%)	(MHz)	(%)	(MHz)	(%)
50	126.5	5319.9637	-0.000682%	5319.9529	-0.000885%	5319.9582	-0.000786%
	110	5319.9664	-0.000632%	5319.9556	-0.000835%	5319.9593	-0.000765%
	93.5	5319.968	-0.000602%	5319.9571	-0.000806%	5319.9589	-0.000773%
40	126.5	5319.9654	-0.000650%	5319.9543	-0.000859%	5319.9569	-0.000810%
	110	5319.9569	-0.000810%	5319.9545	-0.000855%	5319.9573	-0.000802%
	93.5	5319.9578	-0.000793%	5319.9541	-0.000863%	5319.9548	-0.000850%
30	126.5	5319.9599	-0.000754%	5319.9593	-0.000765%	5319.9574	-0.000801%
	110	5319.9588	-0.000774%	5319.9587	-0.000776%	5319.9588	-0.000774%
	93.5	5319.9589	-0.000773%	5319.98965	-0.000195%	5319.9586	-0.000778%
20	126.5	5319.98765	-0.000232%	5319.9857	-0.000269%	5319.9810	-0.000357%
	110	5319.98791	-0.000227%	5319.9891	-0.000205%	5319.9790	-0.000395%
	93.5	5319.98769	-0.000231%	5319.989	-0.000207%	5319.9786	-0.000402%
10	126.5	5319.9657	-0.000645%	5319.9647	-0.000664%	5319.9659	-0.000641%
	110	5319.9667	-0.000626%	5319.9657	-0.000645%	5319.9640	-0.000677%
	93.5	5319.9653	-0.000652%	5319.9662	-0.000635%	5319.9660	-0.000639%
0	126.5	5319.971	-0.000545%	5319.9269	-0.001374%	5319.9707	-0.000551%
	110	5319.9722	-0.000523%	5319.9720	-0.000526%	5319.9736	-0.000496%
	93.5	5319.9715	-0.000536%	5319.9732	-0.000503%	5319.9709	-0.000547%
-10	126.5	5319.9858	-0.000267%	5319.9750	-0.000470%	5319.9725	-0.000517%
	110	5319.983	-0.000320%	5319.9760	-0.000451%	5319.9721	-0.000524%
	93.5	5319.9821	-0.000336%	5319.9755	-0.000461%	5319.9754	-0.000462%
-20	126.5	5319.9763	-0.000445%	5319.9760	-0.000451%	5319.9747	-0.000476%
	110	5319.9780	-0.000414%	5319.9766	-0.000440%	5319.9744	-0.000481%
	93.5	5319.9759	-0.000453%	5319.9762	-0.000447%	5319.9738	-0.000492%
-30	126.5	5319.9621	-0.000712%	5319.9649	-0.000660%	5319.9740	-0.000489%
	110	5319.9639	-0.000679%	5319.9464	-0.001008%	5319.9746	-0.000477%
	93.5	5319.963	-0.000695%	5319.9639	-0.000679%	5319.9754	-0.000462%



## 5.7 BAND EDGES MEASUREMENT

### 5.7.1 TEST INSTRUMENTS

Description & Manufacturer	Model No.	Serial No.	Calibrated Until
R&S SPECTRUM ANALYZER	FSP	1093.4495.30	Dec. 19, 2004

**NOTE:**

- 1.The measurement uncertainty is less than +/- 2.6dB, which is calculated as per the NAMAS document NIS81.
- 2.The calibration interval of the above test instruments is 12 months and the calibrations are traceable to NML/ROC and NIST/USA.

### 5.7.2 TEST PROCEDURE

The transmitter output was connected to the spectrum analyzer via a low lose cable. Set RBW of spectrum analyzer to 1MHz and VBW of spectrum analyzer to 10Hz with suitable frequency span including 100 MHz bandwidth from band edge. The band edges was measured and recorded.

### 5.7.3 EUT OPERATING CONDITION

The software provided by client to enable the EUT under transmission condition continuously at specific channel frequencies individually.



#### 5.7.4 TEST RESULTS

For signals in the restricted bands above and below the 5.15 to 5.35 GHz allocated band a measurement was made of the amplitude of the spurious emissions with respect to the intentional signals. The relative amplitude, in dBc, was applied to the average and peak field strength of the intentional signal made on the OATS to calculate the field strength of the unintentional signals.

The spectrum plots (Average RBW=1MHz, VBW=100Hz) are attached on the following 2 pages.



Normal Mode: Channel 1 (5180 MHz)

The band edge emission plot on the following page shows 47.7dBc (Average) between carrier maximum power and local maximum emission in restrict band. The emission of carrier strength list in the test result of channel 8 (normal mode) is 95.4dBuV/m, so the maximum field strength in restrict band is  $95.4 - 47.7 = 47.7$  dBuV/m which is under 54dBuV/m limit.

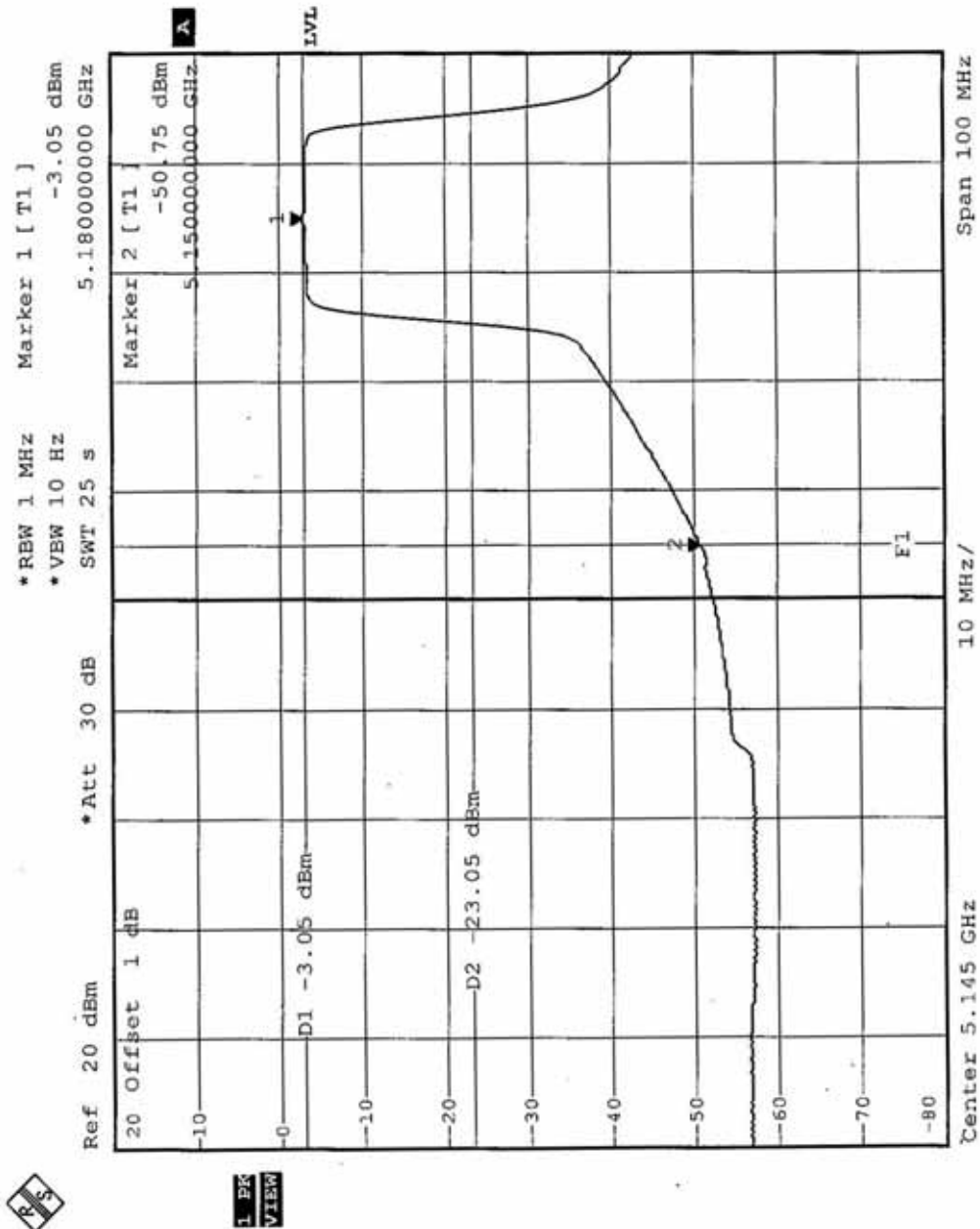





Normal Mode: Channel 8 (5320 MHz)

The band edge emission plot on the following page shows 50.38dBc (Average) between carrier maximum power and local maximum emission in restrict band. The emission of carrier strength list in the test result of channel 8 (normal mode) is 100.5dBuV/m, so the maximum field strength in restrict band is  $100.5 - 50.38 = 50.12$  dBuV/m which is under 54 dBuV/m limit.

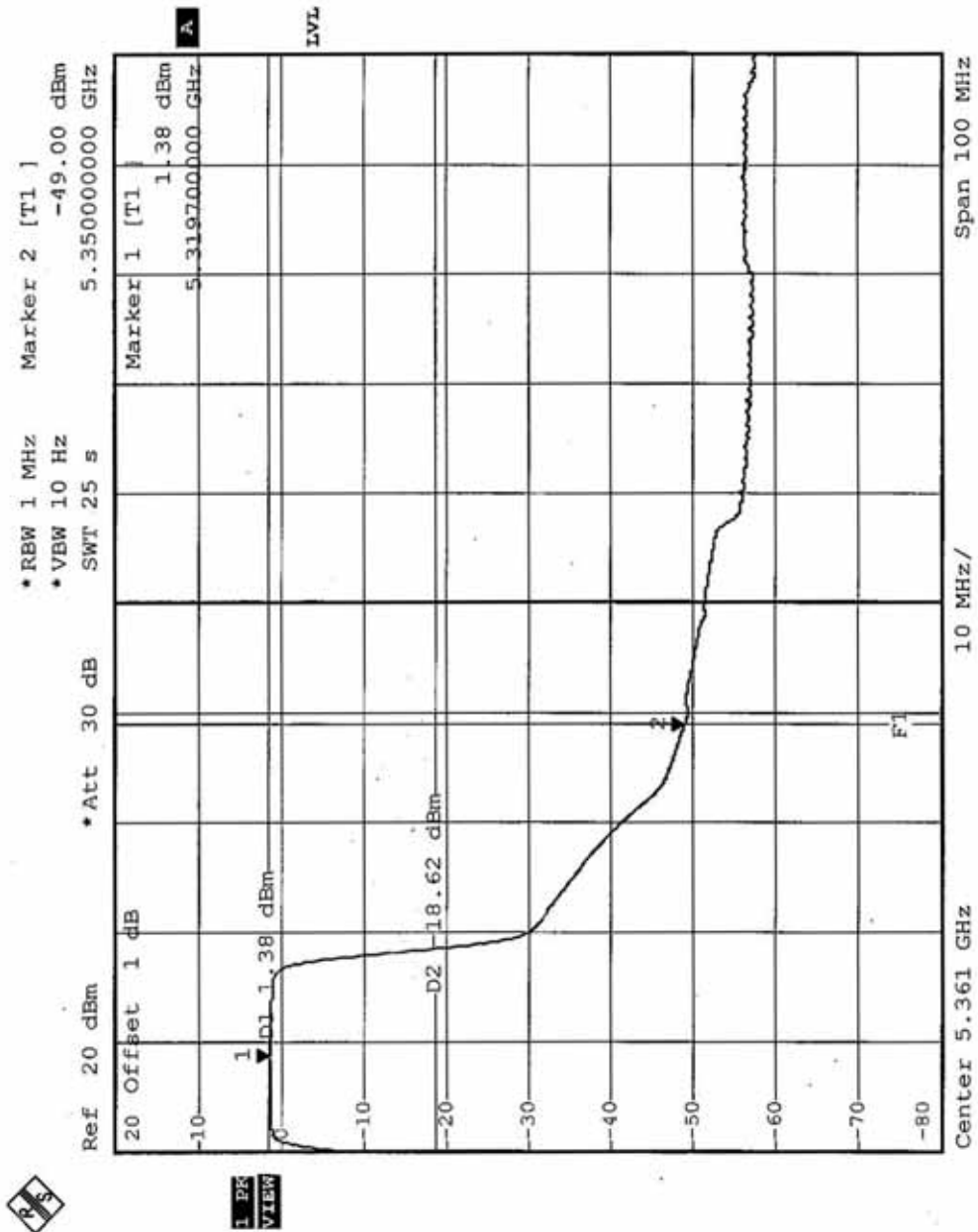

**FOR FREQUENCY 5.725~5.850GHZ****5.8 6DB BANDWIDTH MEASUREMENT****5.8.1 LIMITS OF 6DB BANDWIDTH MEASUREMENT**

The minimum of 6dB Bandwidth Measurement is 0.5 MHz.

**5.8.2 TEST INSTRUMENTS**

Description & Manufacturer	Model No.	Serial No.	Calibrated Until
R&S SPECTRUM ANALYZER	FSP	1093.4495.30	Dec. 19, 2004

**NOTE:**

- 1.The measurement uncertainty is less than +/- 2.6dB, which is calculated as per the NAMAS document NIS81.
- 2.The calibration interval of the above test instruments is 12 months and the calibrations are traceable to NML/ROC and NIST/USA.



### 5.8.3 TEST PROCEDURE

The transmitter output was connected to the spectrum analyzer through an attenuator. The bandwidth of the fundamental frequency was measured by spectrum analyzer with 100 kHz RBW and 100 kHz VBW. The 6 dB bandwidth is defined as the total spectrum the power of which is higher than peak power minus 6 dB.

### 5.8.4 DEVIATION FROM TEST STANDARD

No deviation

### 5.8.5 TEST SETUP



### 5.8.6 EUT OPERATING CONDITIONS

The software provided by client to enable the EUT under transmission condition continuously at lowest, middle and highest channel frequencies individually.



## 5.8.7 TEST RESULTS

<b>EUT</b>	IEEE 802.11a/g Wireless LAN Access Point	<b>MODEL</b>	AS-1250-ABG-EXT
<b>INPUT POWER (SYSTEM)</b>	120Vac, 60Hz	<b>ENVIRONMENTAL CONDITIONS</b>	25 deg. C, 65%RH, 979 hPa
<b>TEST MODE</b>	Normal	<b>TEST BY</b>	Sky Liao

<b>CHANNEL</b>	<b>CHANNEL FREQUENCY (MHz)</b>	<b>6 dB BANDWIDTH (MHz)</b>	<b>MINIMUM LIMIT (MHz)</b>	<b>PASS/FAIL</b>
9	5745	16.5	0.5	PASS
11	5785	16.55	0.5	PASS
13	5825	16.5	0.5	PASS



CH9

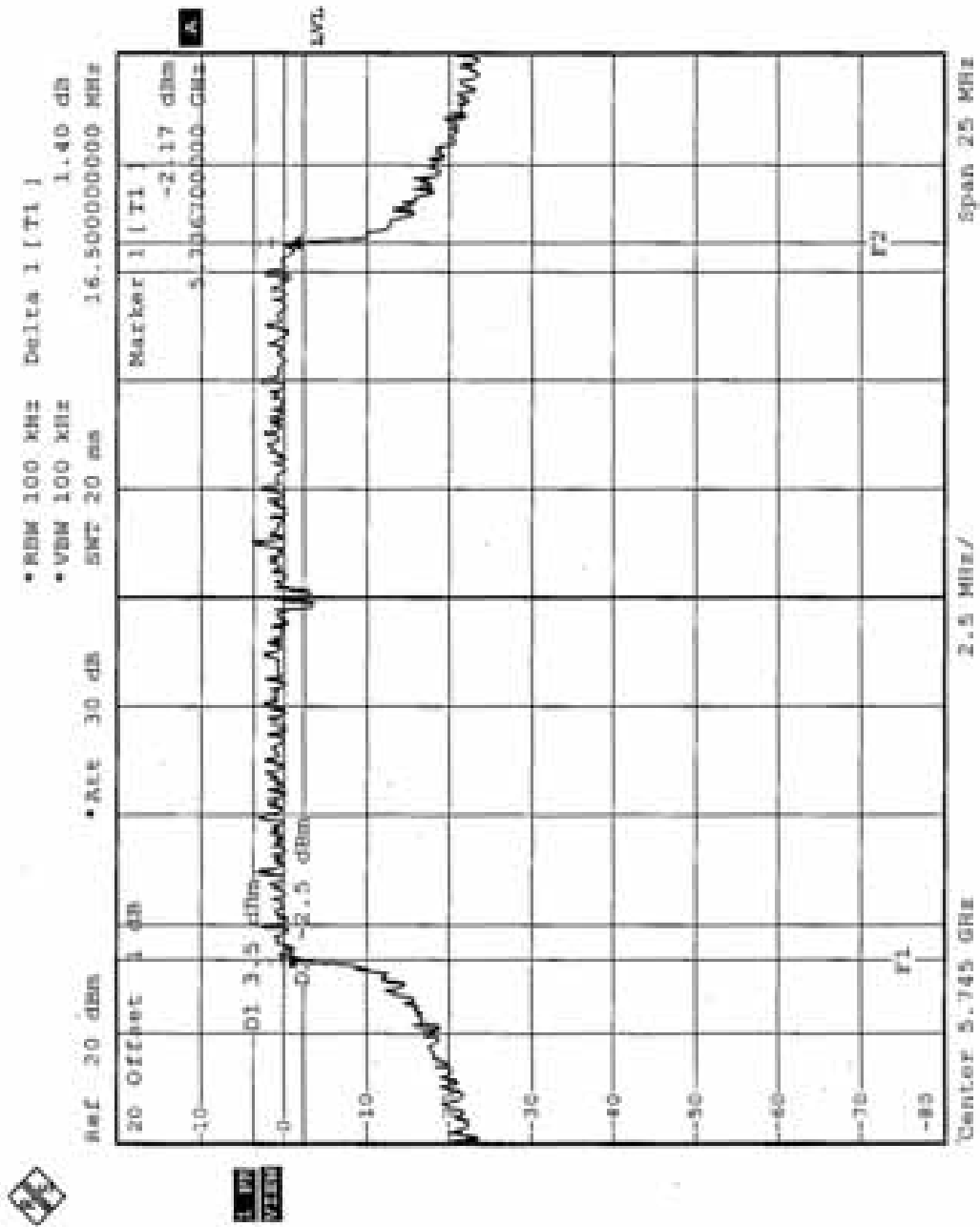



CH11

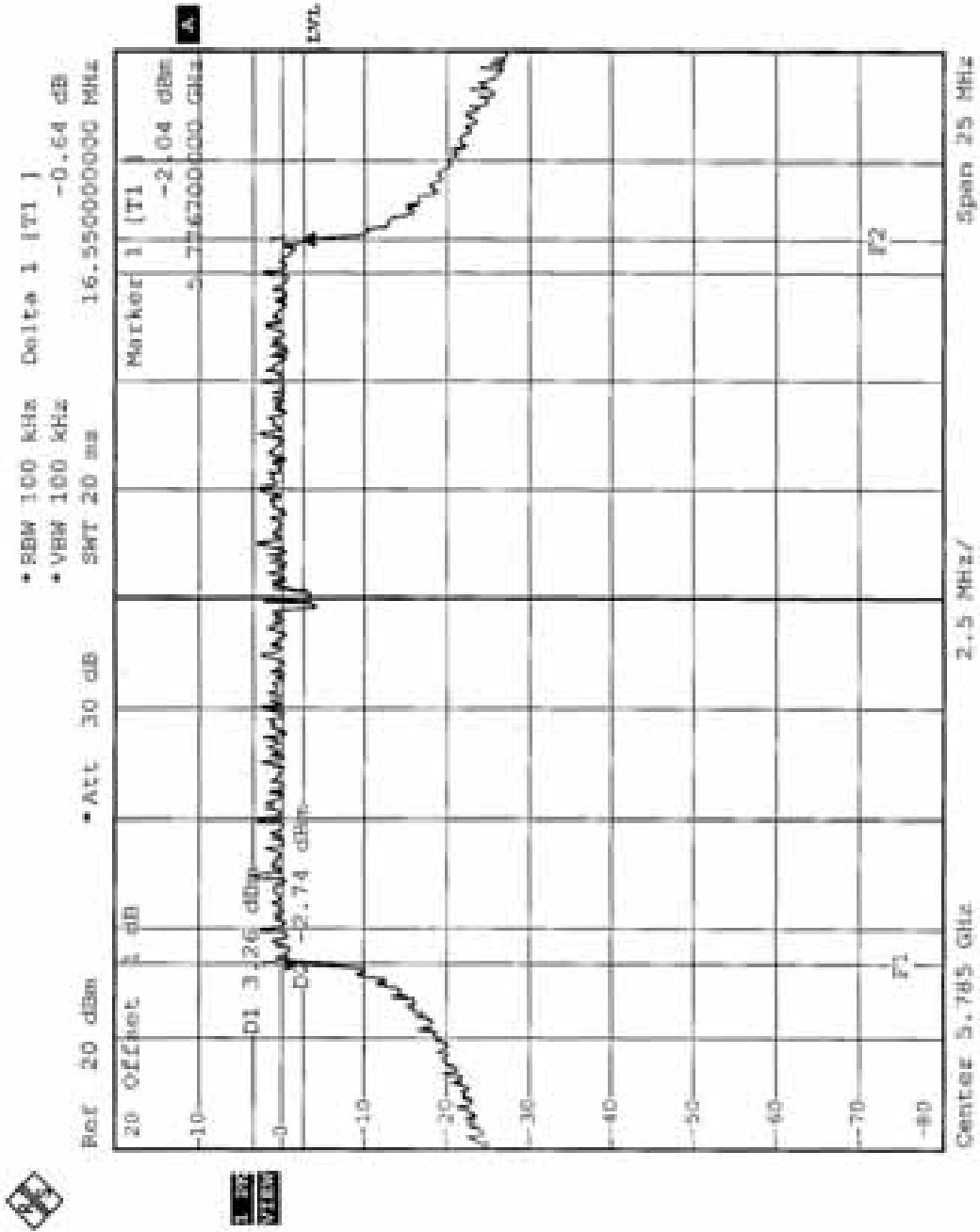



CH13

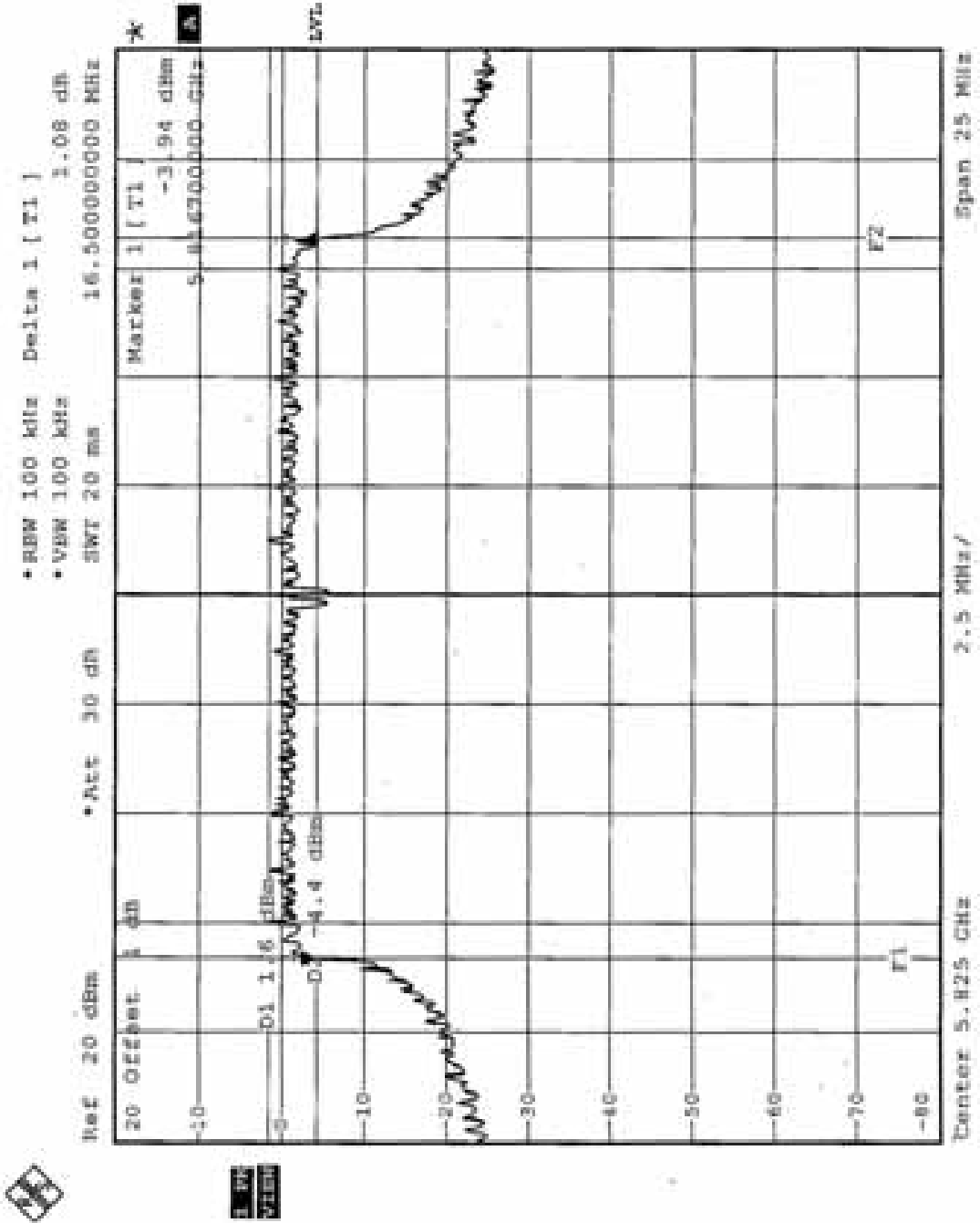



## 5.9 MAXIMUM PEAK OUTPUT POWER

### 5.9.1 LIMITS OF PEAK TRANSMIT POWER MEASUREMENT

The Maximum Peak Output Power Measurement is 30dBm.

**Note:**

1. Systems operating in the 5725-5850 MHz band that are used exclusively for fixed, point-to-point operations may employ transmitting antennas with directional gain greater than 6 dBi without any corresponding reduction in transmitter peak output power.

### 5.9.2 TEST INSTRUMENTS

Description & Manufacturer	Model No.	Serial No.	Calibrated Until
R&S SPECTRUM ANALYZER	FSP30	100019	Dec. 19, 2004

**NOTE:**

The calibration interval of the above test instruments is 12 months and the calibrations are traceable to NML/ROC and NIST/USA.





### 5.9.3 TEST PROCEDURE

The transmitter output was connected to the spectrum analyzer.

Set the spectrum bandwidth span to view the entire spectrum.

Using peak detector and Max-hold function for Trace 1 (RB=1MHz, VB=3MHz) and 2 (RB=1MHz, VB=30KHz).

The largest difference between Trace 1 and Trace 2 in any 1MHz band on any frequency was recorded.

### 5.9.4 TEST SETUP

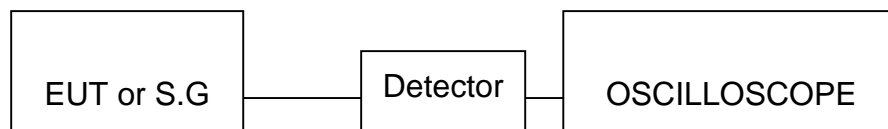

### 5.9.5 EUT OPERATING CONDITIONS

The software provided by client to enable the EUT under transmission condition continuously at specific channel frequencies individually.



## 5.9.6 TEST RESULTS

<b>EUT</b>	IEEE 802.11a/g Wireless LAN Access Point	<b>MODEL</b>	AS-1250-ABG-EXT
<b>INPUT POWER (SYSTEM)</b>	120Vac, 60Hz	<b>ENVIRONMENTAL CONDITIONS</b>	25 deg. C, 65%RH, 979 hPa
<b>TEST MODE</b>	Normal	<b>TEST BY</b>	Sky Liao

**Antenna Gain 7.4dBi**

<b>CHANNEL</b>	<b>CHANNEL FREQUENCY (MHz)</b>	<b>PEAK POWER OUTPUT (dBm)</b>	<b>PEAK POWER LIMIT (dBm)</b>	<b>PASS/FAIL</b>
9	5745	21.30	28.6	PASS
11	5785	21.10	28.6	PASS
13	5825	21.06	28.6	PASS



## 5.10 POWER SPECTRAL DENSITY MEASUREMENT

### 5.10.1 LIMITS OF POWER SPECTRAL DENSITY MEASUREMENT

The Maximum of Power Spectral Density Measurement is 8dBm.

### 5.10.2 TEST INSTRUMENTS

Description & Manufacturer	Model No.	Serial No.	Calibrated Until
R&S SPECTRUM ANALYZER	FSP	1093.4495.30	Dec. 19, 2004

**NOTE:**

- 1.The measurement uncertainty is less than +/- 2.6dB, which is calculated as per the NAMAS document NIS81.
- 2.The calibration interval of the above test instruments is 12 months and the calibrations are traceable to NML/ROC and NIST/USA.



### 5.10.3 TEST PROCEDURE

The transmitter output was connected to the spectrum analyzer through an attenuator, the bandwidth of the fundamental frequency was measured with the spectrum analyzer using 3 kHz RBW and 30 kHz VBW, set sweep time = span/3 kHz. The power spectral density was measured and recorded.

The sweep time is allowed to be longer than span/3 kHz for a full response of the mixer in the spectrum analyzer.

### 5.10.4 DEVIATION FROM TEST STANDARD

No deviation

### 5.10.5 TEST SETUP



### 5.10.6 EUT OPERATING CONDITION

Same as Item 4.3.6



## 5.10.7 TEST RESULTS

<b>EUT</b>	IEEE 802.11a/g Wireless LAN Access Point	<b>MODEL</b>	AS-1250-ABG-EXT
<b>INPUT POWER (SYSTEM)</b>	120Vac, 60Hz	<b>ENVIRONMENTAL CONDITIONS</b>	25 deg. C, 65%RH, 979 hPa
<b>TEST MODE</b>	Normal	<b>TEST BY</b>	Sky Liao

<b>CHANNEL NUMBER</b>	<b>CHANNEL FREQUENCY (MHz )</b>	<b>RF POWER LEVEL IN 3 kHz BW (dBm)</b>	<b>MAXIMUM LIMIT (dBm)</b>	<b>PASS/FAIL</b>
9	5745	-0.82	8	PASS
11	5785	-0.36	8	PASS
13	5825	-2.77	8	PASS



CH9

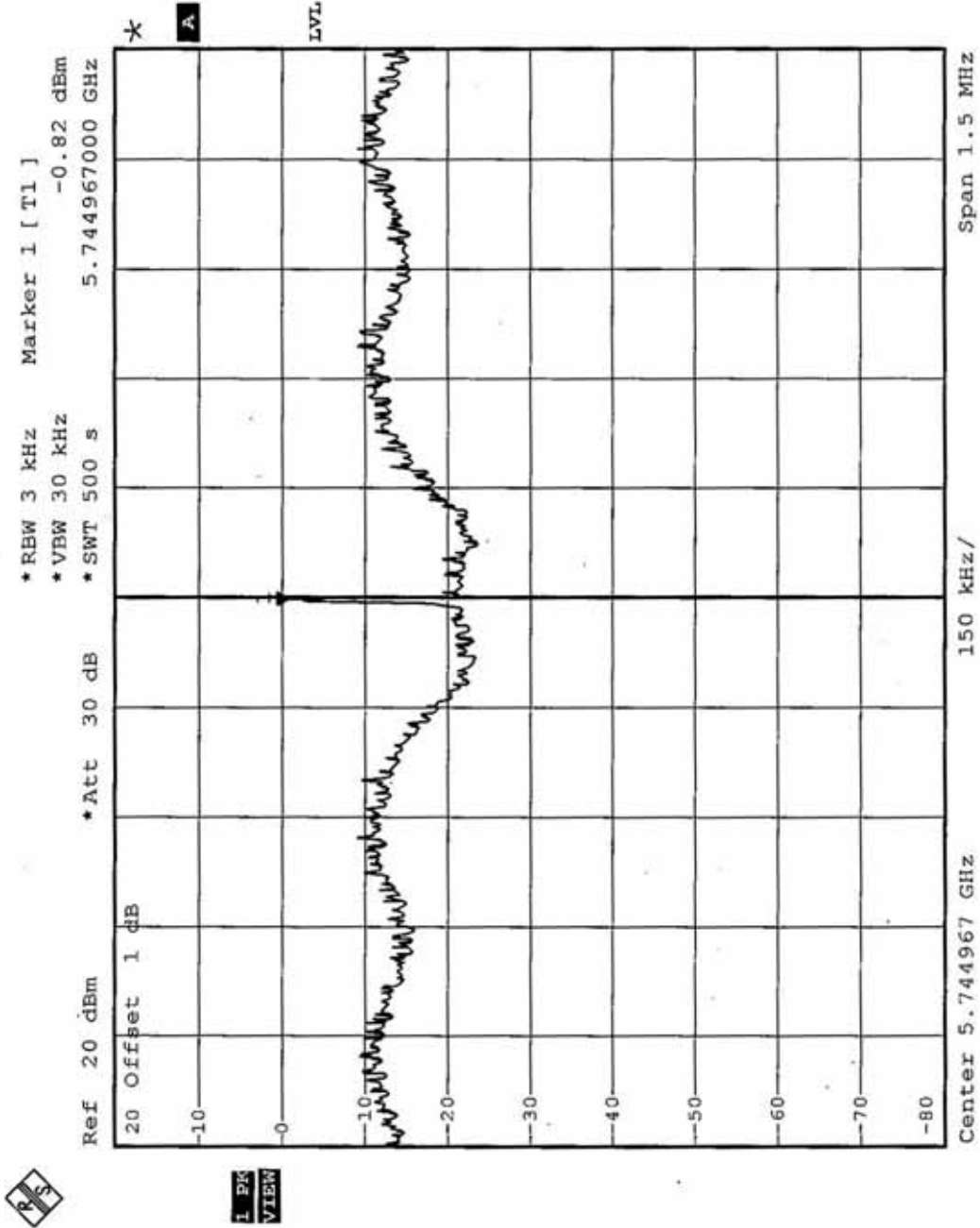



CH11

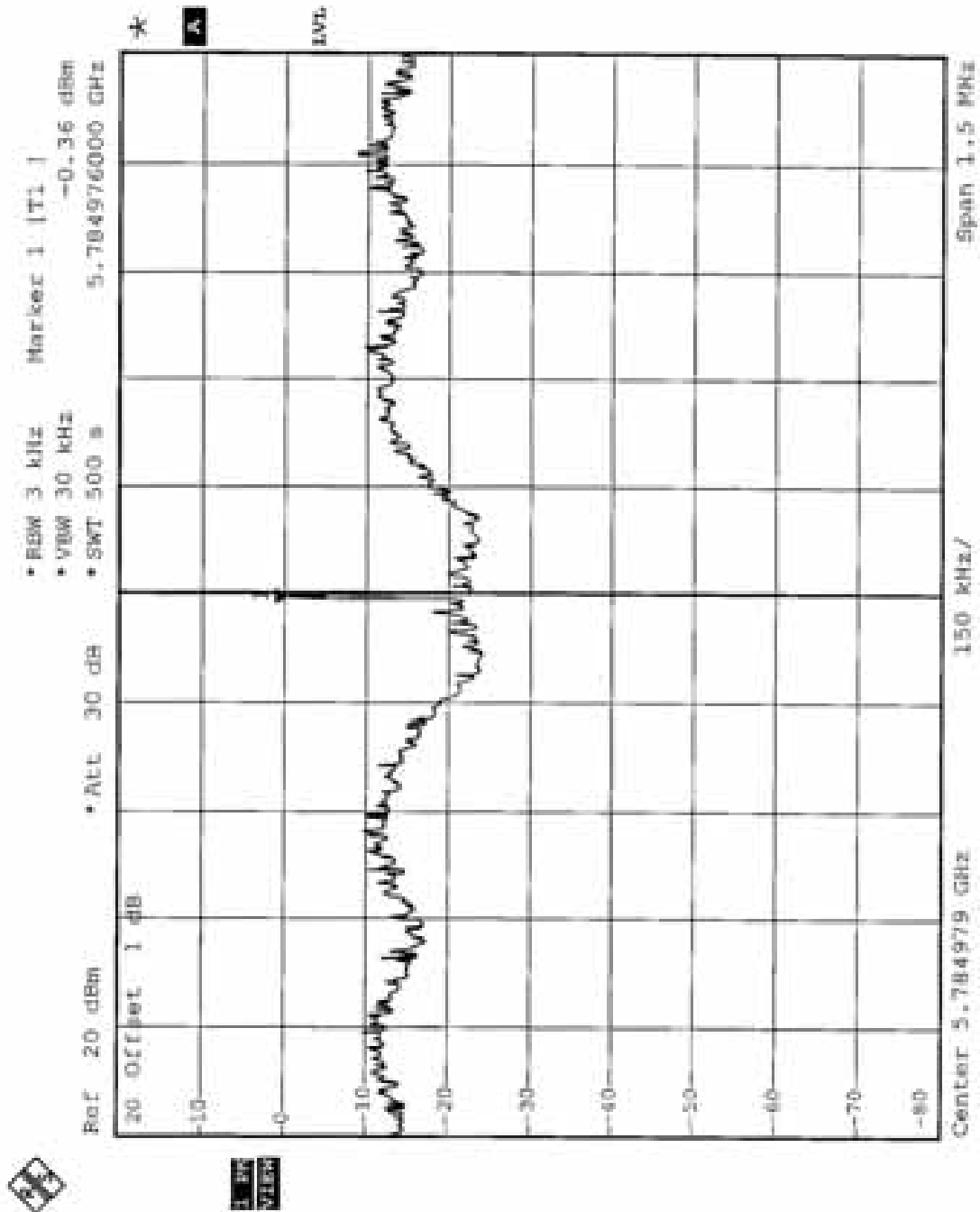



CH13

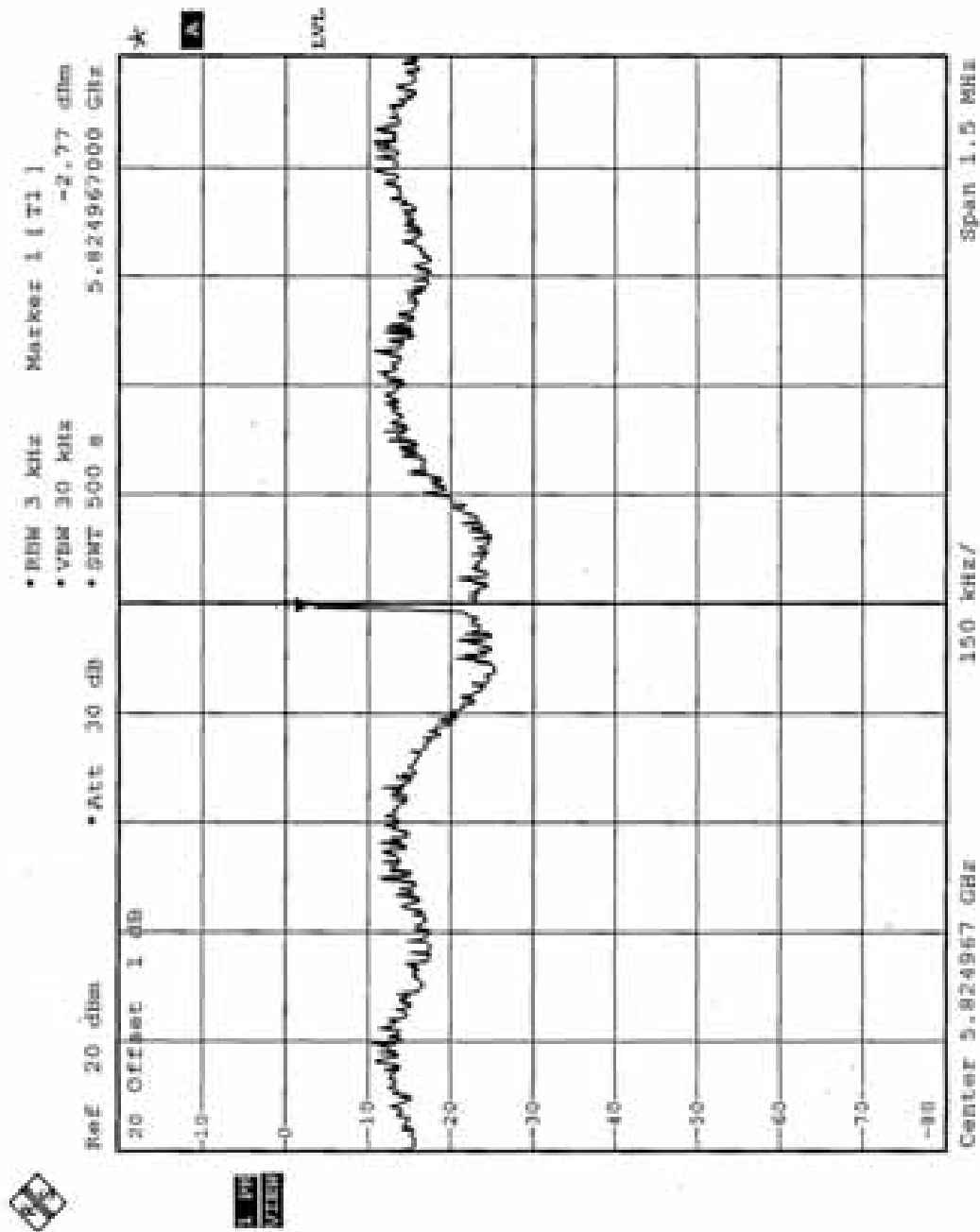





## 5.11 BAND EDGES MEASUREMENT

### 5.11.1 LIMITS OF BAND EDGES MEASUREMENT

Below  $-20\text{dB}$  of the highest emission level of operating band (in 100KHz Resolution Bandwidth).

### 5.11.2 TEST INSTRUMENTS

Description & Manufacturer	Model No.	Serial No.	Calibrated Until
R&S SPECTRUM ANALYZER	FSP	1093.4495.30	Dec. 19, 2004

**NOTE:**

- 1.The measurement uncertainty is less than  $\pm 2.6\text{dB}$ , which is calculated as per the NAMAS document NIS81.
- 2.The calibration interval of the above test instruments is 12 months and the calibrations are traceable to NML/ROC and NIST/USA.

### 5.11.3 TEST PROCEDURE

The transmitter output was connected to the spectrum analyzer via a low lose cable. Set both RBW and VBW of spectrum analyzer to 100 kHz with suitable frequency span including 100 kHz bandwidth from band edge. The band edges was measured and recorded.

### 5.11.4 DEVIATION FROM TEST STANDARD

No deviation



### 5.11.5 EUT OPERATING CONDITION

Same as Item 4.3.6

### 5.11.6 TEST RESULTS

The spectrum plots are attached on the following pages. D1 line indicates the highest level, D2 line indicates the 20dB offset below D1. It shows compliance with the requirement in part 15.247(C).



Normal Mode

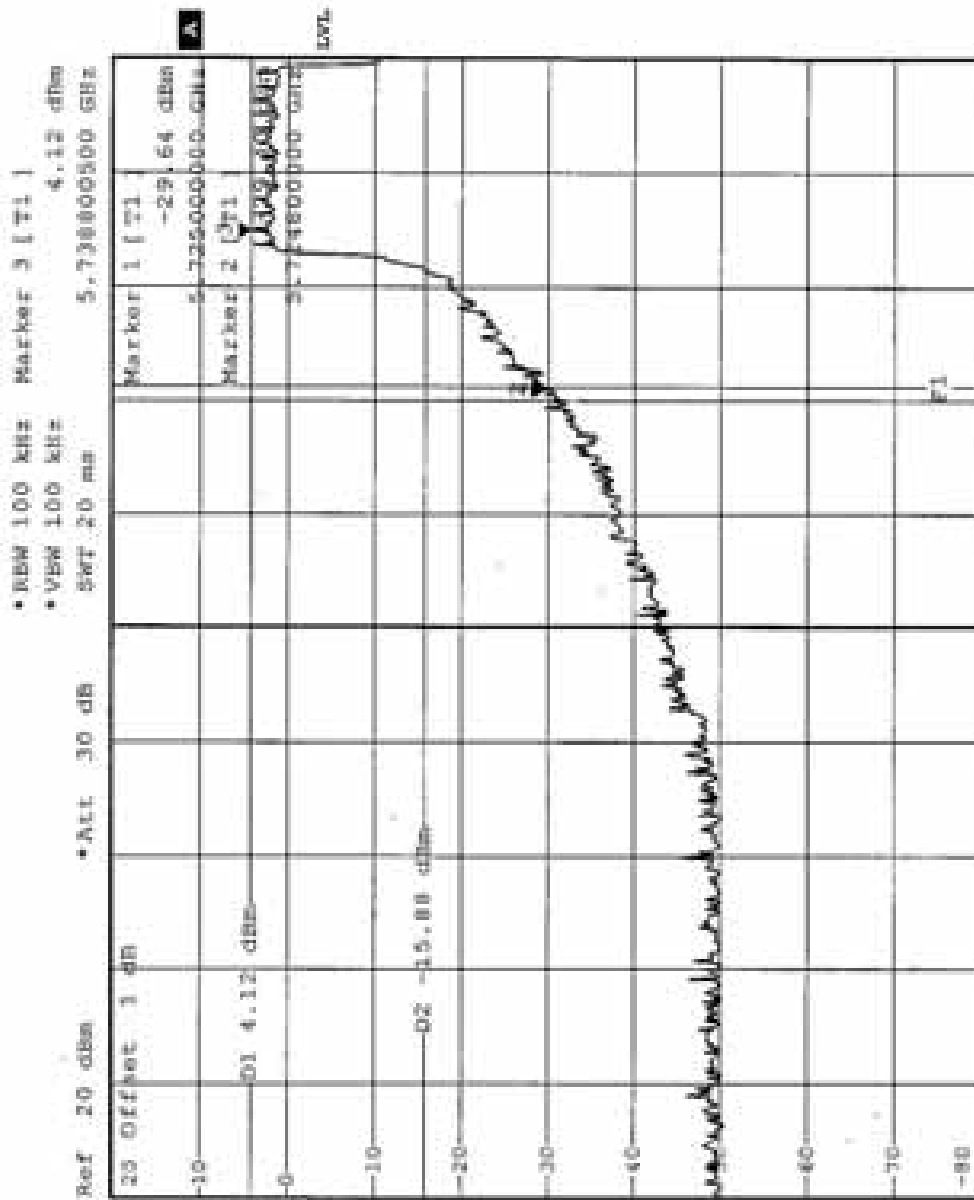

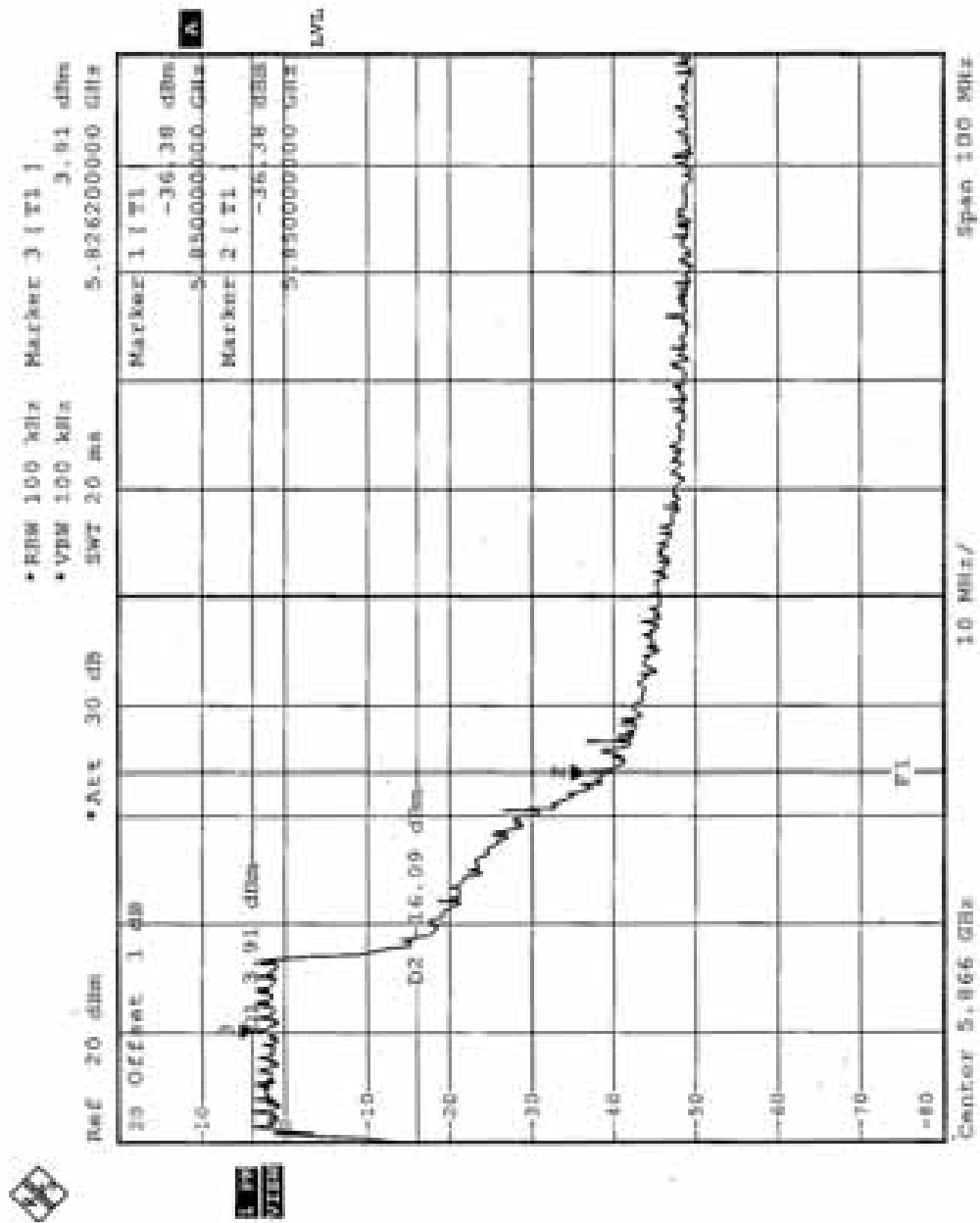



## **5.12 ANTENNA REQUIREMENT**

### **5.12.1 STANDARD APPLICABLE**

For intentional device, according to FCC 47 CFR Section 15.203, an intentional radiator shall be designed to ensure that no antenna other than that furnished by the responsible party shall be used with the device.

And according to FCC 47 CFR Section 15.407(a), if transmitting antennas of directional gain greater than 6dBi are used, the power shall be reduced by the amount in dB that the directional gain of the antenna exceeds 6dBi.

### **5.12.2 ANTENNA CONNECTED CONSTRUCTION**

The antenna used in this product is Patch Antenna without connector. The maximum Gain of the antenna is 7.4dBi.

## 6. PHOTOGRAPHS OF THE TEST CONFIGURATION CONDUCTED EMISSION TEST (With Adapter)



**CONDUCTED EMISSION TEST (With POE)**



### RADIATED EMISSION TEST (With Adapter)





### RADIATED EMISSION TEST (With POE)





## 7. INFORMATION ON THE TESTING LABORATORIES

We, ADT Corp., were founded in 1988 to provide our best service in EMC, Radio, Telecom and Safety consultation. Our laboratories are accredited and approved by the following approval agencies according to ISO/IEC 17025, Guide 25 or EN 45001:

<b>USA</b>	FCC, NVLAP, UL, A2LA
<b>Germany</b>	TUV Rheinland
<b>Japan</b>	VCCI
<b>Norway</b>	NEMKO
<b>Canada</b>	INDUSTRY CANADA, CSA
<b>R.O.C.</b>	CNLA, BSMI, DGT
<b>Netherlands</b>	Telefication
<b>Singapore</b>	PSB, GOST-ASIA (MOU)
<b>Russia</b>	CERTIS (MOU)

Copies of accreditation certificates of our laboratories obtained from approval agencies can be downloaded from our web site: [www.adt.com.tw/index.5/phtml](http://www.adt.com.tw/index.5/phtml).

If you have any comments, please feel free to contact us at the following:

**Linko EMC/RF Lab:**

Tel: 886-2-26052180

Fax: 886-2-26052943

**Hsin Chu EMC/RF Lab:**

Tel: 886-3-5935343

Fax: 886-3-5935342

**Hwa Ya EMC/RF/Safety/Telecom Lab:**

Tel: 886-3-3183232

Fax: 886-3-3185050

**Email:** [service@adt.com.tw](mailto:service@adt.com.tw)

**Web Site:** [www.adt.com.tw](http://www.adt.com.tw)

The address and road map of all our labs can be found in our web site also.