

# TEST REPORT

Report No.: BCTC2306669781E

---

Applicant: ZAGG Inc.

---

Product Name: Bluetooth Keyboard

---

Model/Type Ref.: ZKB109RBB35

---

Tested Date: 2023-06-05 to 2023-06-05

---

Issued Date: 2023-06-06

---

**Shenzhen BCTC Testing Co., Ltd.**



# FCC ID: QTG-ZKPRB

Product Name: Bluetooth Keyboard  
Trademark: ZAGG  
Model/Type Ref.: ZKB109RBB35  
Prepared For: ZAGG Inc.  
Address: 910 West Legacy Center Way, Midvale Utah 84047, United States  
Manufacturer: ZAGG Inc.  
Address: 910 West Legacy Center Way, Midvale Utah 84047, United States  
Prepared By: Shenzhen BCTC Testing Co., Ltd.  
Address: 1-2/F., Building B, Pengzhou Industrial Park, No.158, Fuyuan 1st Road, Tangwei, Fuhai Subdistrict, Bao'an District, Shenzhen, Guangdong, China  
Sample Received Date: 2023-06-05  
Sample tested Date: 2023-06-05 to 2023-06-05  
Issue Date: 2023-06-06  
Report No.: BCTC2306669781E  
Test Standards: FCC Part15.247  
ANSI C63.10-2013  
Test Results: PASS  
Remark: This is Bluetooth BLE radio test report.

Tested by:

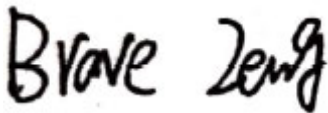

Brave Zeng/ Project Handler

Approved by:



Zero Zhou/Reviewer

*The test report is effective only with both signature and specialized stamp. This result(s) shown in this report refer only to the sample(s) tested. Without written approval of Shenzhen BCTC Testing Co., Ltd, this report can't be reproduced except in full. The tested sample(s) and the sample information are provided by the client.*

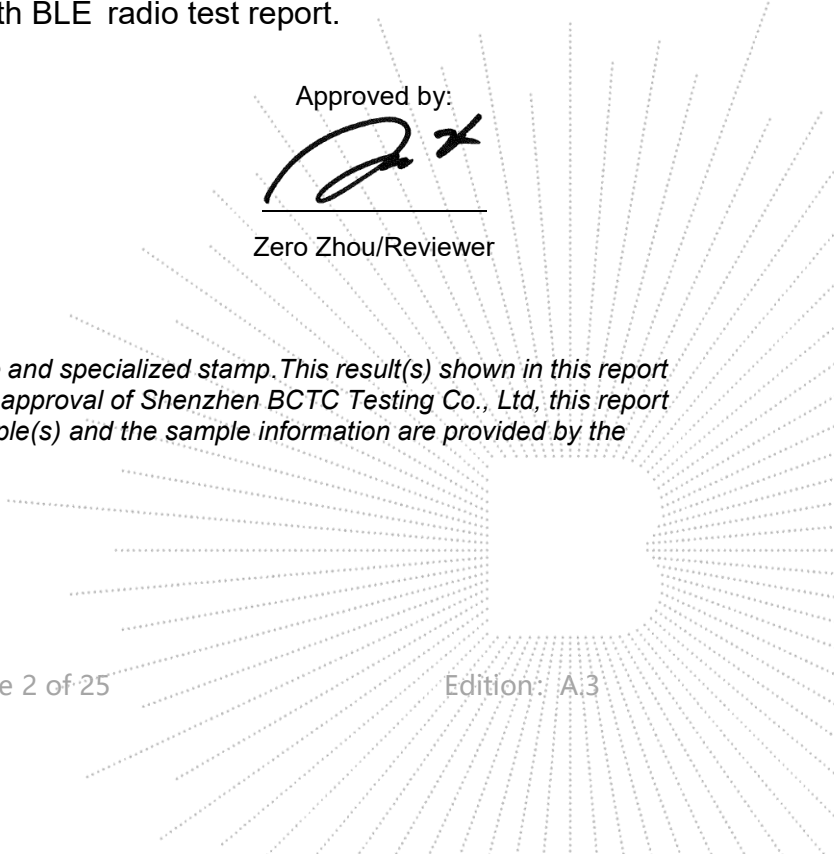

## TABLE OF CONTENT

Test Report Declaration	Page
<b>1. VERSION</b> .....	4
<b>2. TEST SUMMARY</b> .....	5
<b>3. MEASUREMENT UNCERTAINTY</b> .....	6
<b>4. PRODUCT INFORMATION AND TEST SETUP</b> .....	7
4.1 Product Information .....	7
4.2 Test Setup Configuration .....	7
4.3 Support Equipment .....	7
4.4 Channel List .....	8
4.5 Test Mode .....	8
4.6 Copy of marking plate .....	8
<b>5. TEST FACILITY AND TEST INSTRUMENT USED</b> .....	9
5.1 Test Facility .....	9
5.2 Test Instrument Used .....	9
<b>6. CONDUCTED EMISSIONS</b> .....	10
6.1 Block Diagram Of Test Setup .....	10
6.2 Limit .....	10
6.3 Test procedure .....	10
6.4 EUT operating Conditions .....	10
6.5 Test Result .....	11
<b>7. RADIATED EMISSIONS</b> .....	13
7.1 Block Diagram Of Test Setup .....	13
7.2 Limit .....	14
7.3 Test procedure .....	15
7.4 EUT operating Conditions .....	17
7.5 Test Result .....	18
<b>8. EUT PHOTOGRAPHS</b> .....	21
<b>9. EUT TEST SETUP PHOTOGRAPHS</b> .....	23

*(Note: N/A means not applicable)*

## 1. VERSION

Report No.	Issue Date	Description	Approved
BCTC2103457592E	2021-03-15	Original	Valid
BCTC2306669781E	2023-06-06	updates the appearance and model of the product	Valid

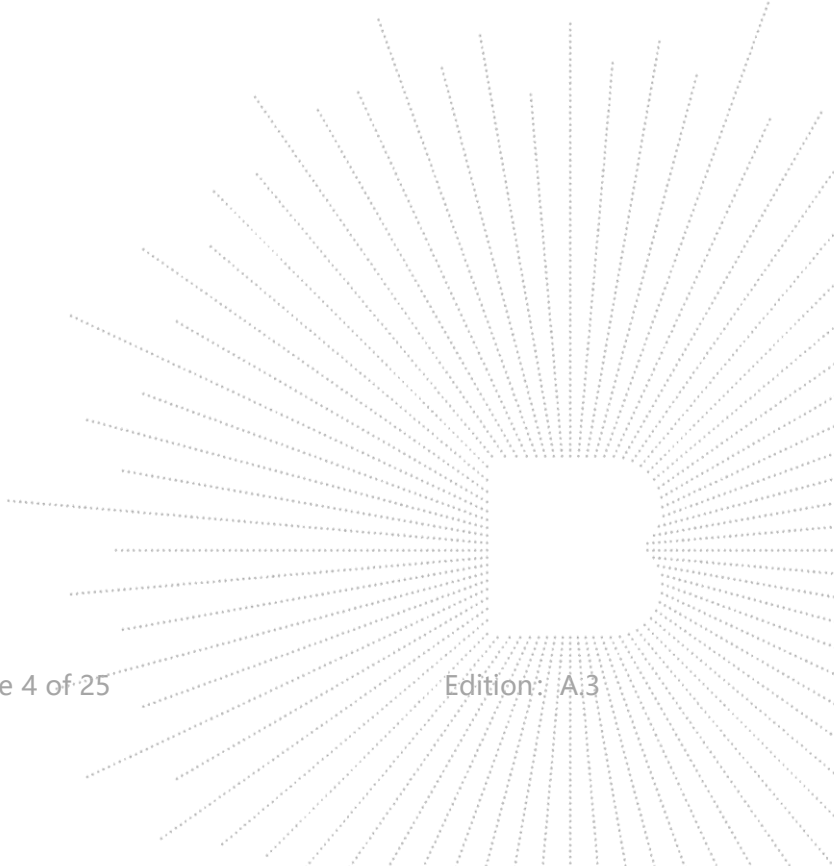

## 2. TEST SUMMARY

The Product has been tested according to the following specifications:

No.	Test Parameter	Clause No	Results
1	Conducted emissions	15.207	PASS
2	Radiated Emissions	15.209	PASS

Remark: Based on the following changes in the product, the RF chip remains unchanged. So the report is only updated Conducted emissions and Radiated Emissions for the original report (BCTC2103457592E) .

Changes : 1. The new product changes the appearance of the case, as well as increasing the storage space of the pen hole.

Original:



new



Remark: Based on the following changes in the original test report (BCTC2103457592E), No changes were made to the product. Only changes Model/Type Ref., Test Instrument Used, Conducted emissions, Radiated emissions, EUT Photographs.

### 3. MEASUREMENT UNCERTAINTY

Where relevant, the following measurement uncertainty levels have been estimated for tests performed on the Product as specified in CISPR 16-4-2. This uncertainty represents an expanded uncertainty expressed at approximately the 95% confidence level using a coverage factor of k=2.

No.	Item	Uncertainty
1	humidity uncertainty	U=5.3%
2	Temperature uncertainty	U=0.59°C
3	Conducted Emission (150kHz-30MHz)	U=3.2dB
4	Radiated disturbance(30MHz-1000MHz)	U=4.8dB
5	Radiated disturbance(1GHz-6GHz)	U=4.9dB
6	Radiated disturbance(1GHz-18GHz)	U=5.0dB

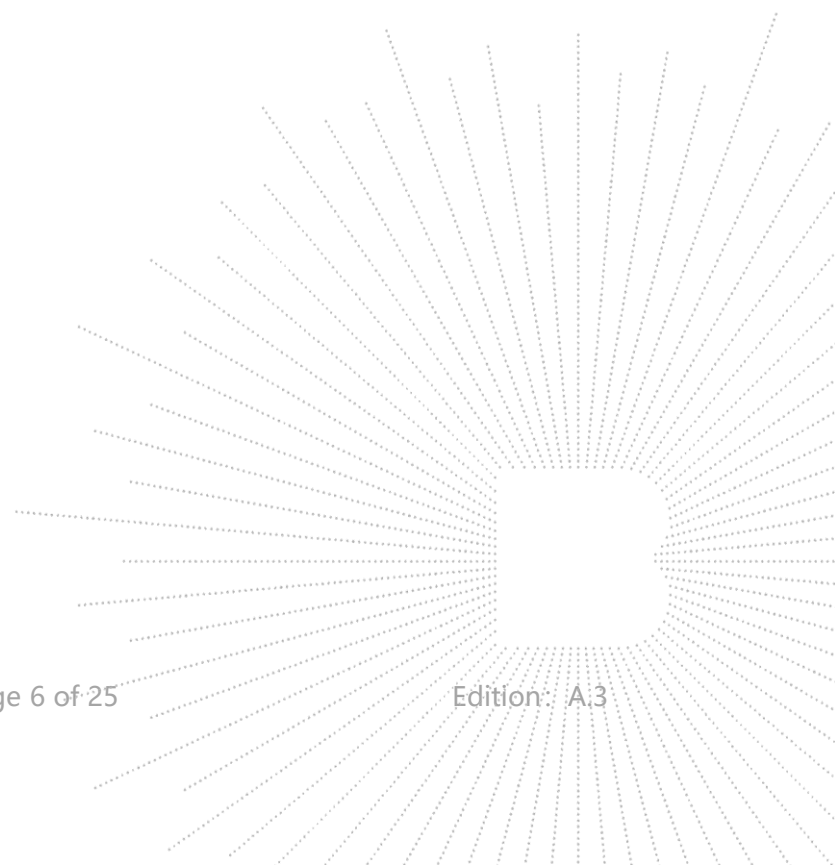
## 4. PRODUCT INFORMATION AND TEST SETUP

### 4.1 Product Information

Model/Type Ref.:	ZKB109RBB35
Model differences:	N/A
Bluetooth Version:	BT 5.0
Hardware Version:	V2.1
Software Version:	V1.0
Operation Frequency:	Bluetooth: 2402-2480MHz
Type of Modulation:	Bluetooth: GFSK
Antenna installation:	Bluetooth: PCB antenna
Antenna Gain:	Bluetooth:1.87dBi
Ratings:	DC 3.7V from Battery DC 5V from Adapter

### 4.2 Test Setup Configuration

See test photographs attached in *EUT TEST SETUP PHOTOGRAPHS* for the actual connections between Product and support equipment.

Conducted Emission:

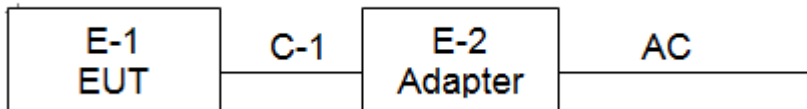

Radiated Spurious Emission

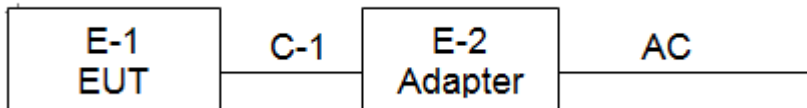

### 4.3 Support Equipment

No.	Device Type	Brand	Model	Series No.	Data Cable	Power Cord
E-1	Bluetooth Keyboard	ZAGG	ZKB109RB B35	N/A	EUT	E-1
E-2	Adapter	N/A	BCTC001	N/A	Auxiliary	E-2



Item	Shielded Type	Ferrite Core	Length	Note
C-1	NO	NO	0.4M	DC cable unshielded

**Notes:**

1. All the equipment/cables were placed in the worst-case configuration to maximize the emission during the test.
2. Grounding was established in accordance with the manufacturer's requirements and conditions for the intended use.

#### 4.4 Channel List

Channel List					
Channel	Frequency (MHz)	Channel	Frequency (MHz)	Channel	Frequency (MHz)
01	2402	11	2422	21	2442
02	2404	12	2424	22	2444
03	2406	13	2426	23	2446
~	~	~	~	~	~
09	2418	19	2438	39	2478
10	2420	20	2440	40	2480

#### 4.5 Test Mode

Test mode	Test mode	Low channel	Middle channel	High channel
1	Link mode(conducted emission and Radiated emission)			

#### 4.6 Copy of marking plate

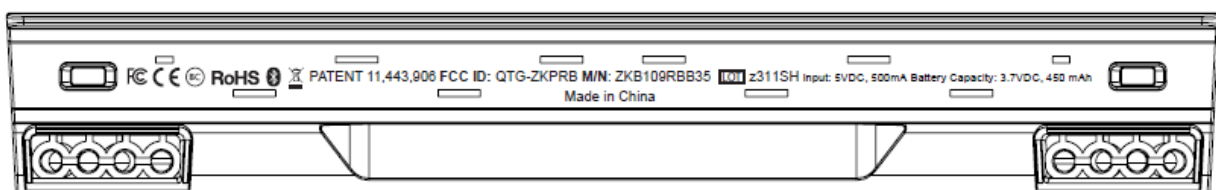



## 5. TEST FACILITY AND TEST INSTRUMENT USED

### 5.1 Test Facility

All measurement facilities used to collect the measurement data are located at Shenzhen BCTC Testing Co., Ltd. Address: 1-2/F., Building B, Pengzhou Industrial Park, No.158, Fuyuan 1st Road, Zhancheng, Fuhai Subdistrict, Bao'an District, Shenzhen, Guangdong, China. The site and apparatus are constructed in conformance with the requirements of ANSI C63.4 and CISPR 16-1-1 other equivalent standards.

### 5.2 Test Instrument Used

Conducted emissions Test					
Equipment	Manufacturer	Model#	Serial#	Last Cal.	Next Cal.
Receiver	R&S	ESR3	102075	May 15, 2023	May 14, 2024
LISN	R&S	ENV216	101375	May 15, 2023	May 14, 2024
Software	Frad	EZ-EMC	EMC-CON 3A1	\	\
Attenuator	\	10dB DC-6GHz	1650	May 15, 2023	May 14, 2024

Radiated emissions Test (966 chamber)					
Equipment	Manufacturer	Model#	Serial#	Last Cal.	Next Cal.
Power Metter	Keysight	E4419	\	May 15, 2023	May 14, 2024
Power Sensor (AV)	Keysight	E9300A	\	May 15, 2023	May 14, 2024
Signal Analyzer20k Hz-26.5GHz	Keysight	N9020A	MY491000 60	May 15, 2023	May 14, 2024
Spectrum Analyzer9k Hz-40GHz	R&S	FSP40	100363	May 15, 2023	May 14, 2024
Radio frequency control box	MAIWEI	MW100-RF CB	\	\	\
Software	MAIWEI	MTS 8310	\	\	\
Power Metter	Keysight	E4419	\	May 15, 2023	May 14, 2024
Power Sensor (AV)	Keysight	E9300A	\	May 15, 2023	May 14, 2024

## 6. CONDUCTED EMISSIONS

### 6.1 Block Diagram Of Test Setup

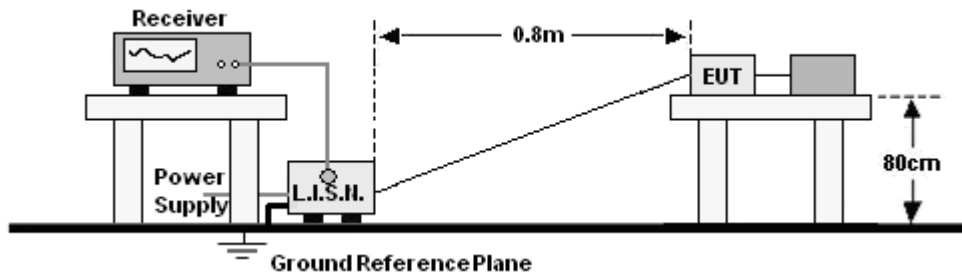

### 6.2 Limit

FREQUENCY (MHz)	Limit (dBuV)	
	Quas-peak	Average
0.15 -0.5	66 - 56 *	56 - 46 *
0.50 -5.0	56.00	46.00
5.0 -30.0	60.00	50.00

Notes:  
 1. \*Decreasing linearly with logarithm of frequency.  
 2. The lower limit shall apply at the transition frequencies.

### 6.3 Test procedure

Receiver Parameters	Setting
Attenuation	10 dB
Start Frequency	0.15 MHz
Stop Frequency	30 MHz
IF Bandwidth	9 kHz

a. The Product was placed on a nonconductive table 0.8 m above the horizontal ground reference plane, and 0.4 m from the vertical ground reference plane, and connected to the main through Line Impedance Stability Network (L.I.S.N).

b. The RBW of the receiver was set at 9 kHz in 150 kHz ~ 30MHz with Peak and AVG detector in Max Hold mode. Run the receiver's pre-scan to record the maximum disturbance generated from Product in all power lines in the full band.

c. For each frequency whose maximum record was higher or close to limit, measure its QP and AVG values and record.

### 6.4 EUT operating Conditions

The EUT was configured for testing in a typical fashion (as a customer would normally use it). The EUT has been programmed to continuously transmit during test. This operating condition was tested and used to collect the included data.

## 6.5 Test Result

Temperature :	26 °C	Relative Humidity :	54%
Pressure :	101kPa	Phase :	L
Test Voltage :	AC 120V/60Hz	Test Mode :	Mode 1

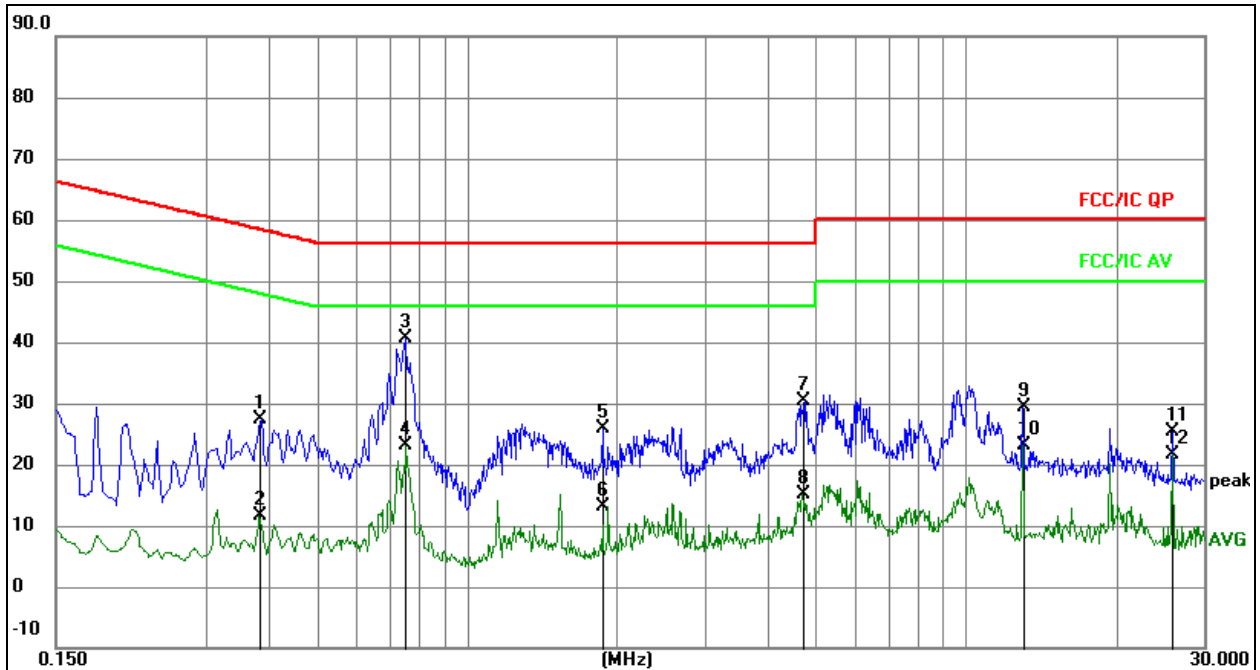

### Remark:

1. All readings are Quasi-Peak and Average values.
2. Factor = Insertion Loss + Cable Loss.
3. Measurement=Reading Level+ Correct Factor
4. Over=Measurement-Limit

No.	Mk.	Freq. MHz	Reading Level	Correct Factor dB	Measure- ment dBuV	Limit dBuV	Over dB	Detector
1		0.3840	7.70	19.75	27.45	58.19	-30.74	QP
2		0.3840	-8.13	19.75	11.62	48.19	-36.57	AVG
3	*	0.7529	20.78	19.74	40.52	56.00	-15.48	QP
4		0.7529	3.31	19.74	23.05	46.00	-22.95	AVG
5		1.8733	5.91	19.86	25.77	56.00	-30.23	QP
6		1.8733	-6.65	19.86	13.21	46.00	-32.79	AVG
7		4.7130	10.15	20.12	30.27	56.00	-25.73	QP
8		4.7130	-4.90	20.12	15.22	46.00	-30.78	AVG
9		13.0020	9.00	20.28	29.28	60.00	-30.72	QP
10		13.0020	2.88	20.28	23.16	50.00	-26.84	AVG
11		25.9980	4.87	20.52	25.39	60.00	-34.61	QP
12		25.9980	1.11	20.52	21.63	50.00	-28.37	AVG

Temperature :	26 °C	Relative Humidity :	54%
Pressure :	101kPa	Phase :	N
Test Voltage :	AC 120V/60Hz	Test Mode :	Mode 1

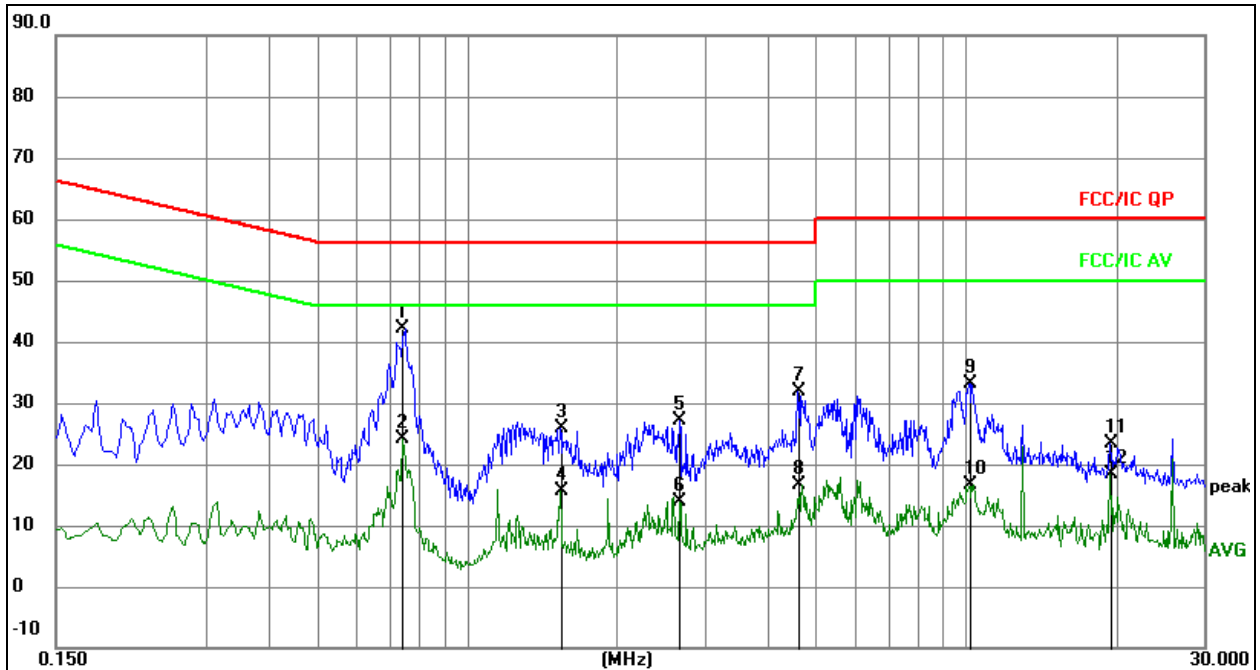
**Remark:**

1. All readings are Quasi-Peak and Average values.
2. Factor = Insertion Loss + Cable Loss.
3. Measurement=Reading Level+ Correct Factor
4. Over=Measurement-Limit

No.	Mk.	Freq. MHz	Reading Level	Correct Factor dB	Measure- ment dBuV	Limit dBuV	Over dB	Detector
1	*	0.7430	22.35	19.74	42.09	56.00	-13.91	QP
2		0.7430	4.44	19.74	24.18	46.00	-21.82	AVG
3		1.5355	6.00	19.82	25.82	56.00	-30.18	QP
4		1.5355	-4.16	19.82	15.66	46.00	-30.34	AVG
5		2.6641	7.25	19.95	27.20	56.00	-28.80	QP
6		2.6641	-6.01	19.95	13.94	46.00	-32.06	AVG
7		4.5979	11.80	20.12	31.92	56.00	-24.08	QP
8		4.5979	-3.54	20.12	16.58	46.00	-29.42	AVG
9		10.1254	12.86	20.28	33.14	60.00	-26.86	QP
10		10.1254	-3.73	20.28	16.55	50.00	-33.45	AVG
11		19.4284	2.85	20.48	23.33	60.00	-36.67	QP
12		19.4284	-2.07	20.48	18.41	50.00	-31.59	AVG

## 7. RADIATED EMISSIONS

### 7.1 Block Diagram Of Test Setup

#### (A) Radiated Emission Test-Up Frequency Below 30MHz

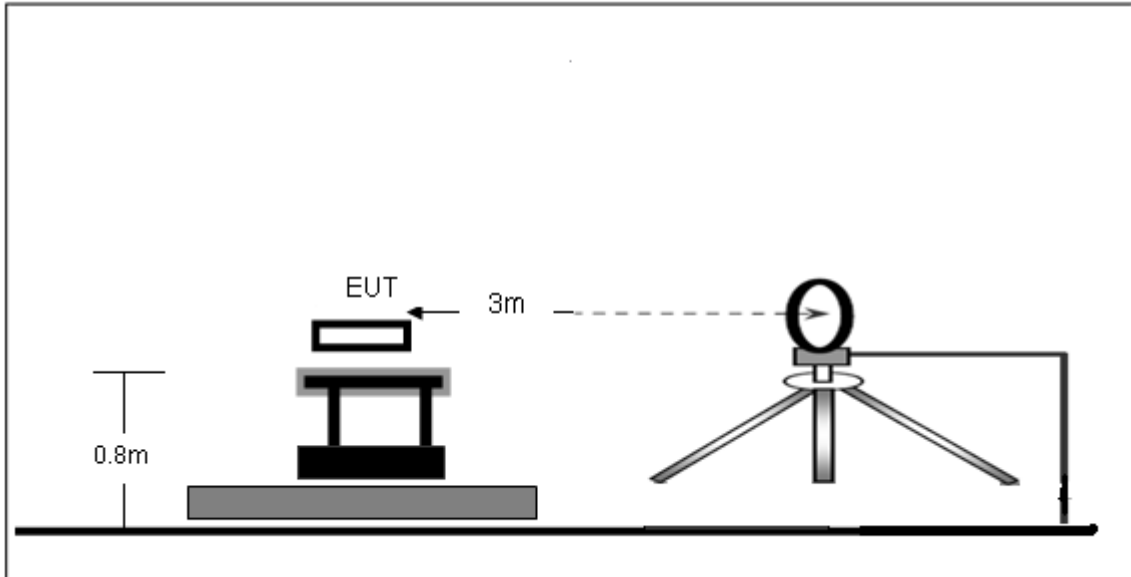

#### (B) Radiated Emission Test-Up Frequency 30MHz~1GHz

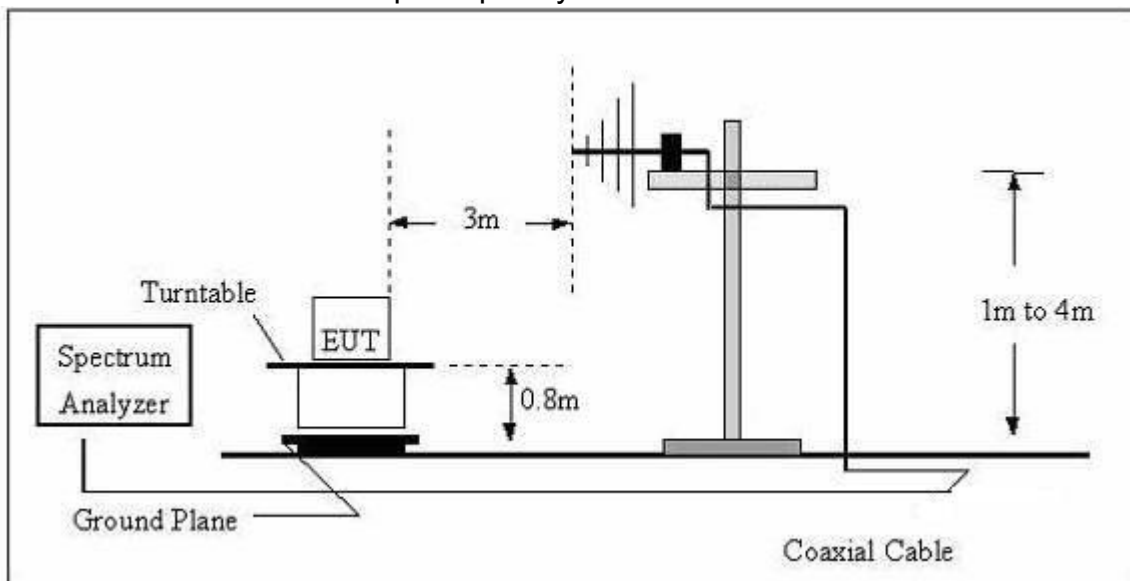

## (C) Radiated Emission Test-Up Frequency Above 1GHz

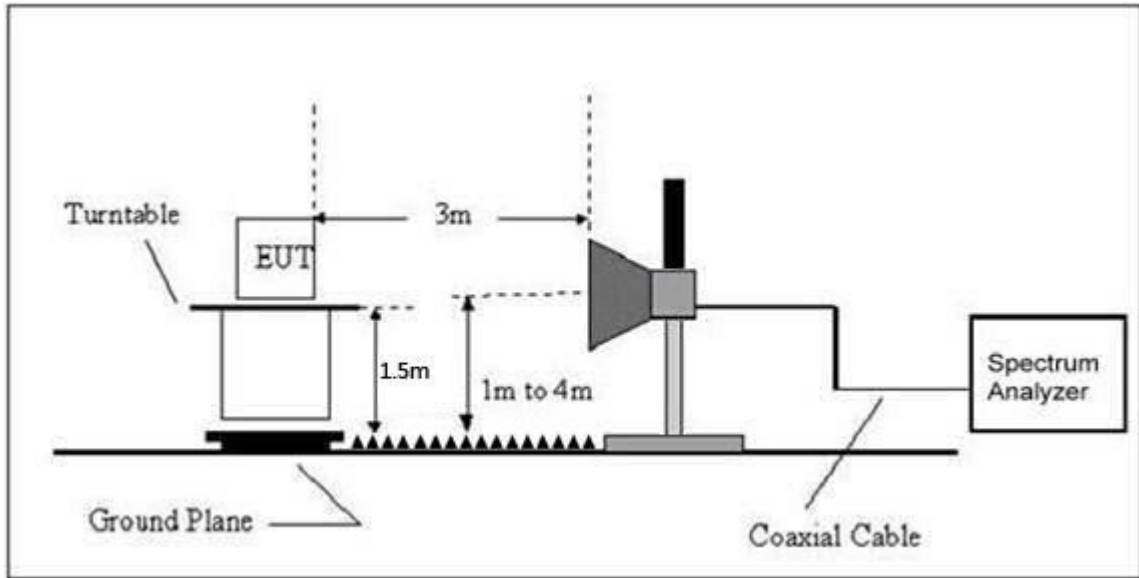

## 7.2 Limit

20dBc in any 100 kHz bandwidth outside the operating frequency band. In case the emission fall within the restricted band specified on 15.205(a), then the 15.209(a) limit in the table below has to be followed.

Frequency (MHz)	Field Strength uV/m	Distance (m)	Field Strength Limit at 3m Distance	
			uV/m	dBuV/m
0.009 ~ 0.490	2400/F(kHz)	300	$10000 * 2400/F(kHz)$	$20\log^{(2400/F(kHz))} + 80$
0.490 ~ 1.705	24000/F(kHz)	30	$100 * 24000/F(kHz)$	$20\log^{(24000/F(kHz))} + 40$
1.705 ~ 30	30	30	$100 * 30$	$20\log^{(30)} + 40$
30 ~ 88	100	3	100	$20\log^{(100)}$
88 ~ 216	150	3	150	$20\log^{(150)}$
216 ~ 960	200	3	200	$20\log^{(200)}$
Above 960	500	3	500	$20\log^{(500)}$

### LIMITS OF RADIATED EMISSION MEASUREMENT (Above 1000MHz)

FREQUENC Y (MHz)	Limit (dBuV/m) (at 3M)	
	PEAK	AVERAGE
Above 1000	74	54

Notes:

- (1)The limit for radiated test was performed according to FCC PART 15C.
- (2)The tighter limit applies at the band edges.
- (3) Emission level (dBuV/m)=20log Emission level (uV/m).



**FREQUENCY RANGE OF RADIATED MEASUREMENT (For unintentional radiators)**

Highest frequency generated or Upper frequency of measurement used in the device or on which the device operates or tunes (MHz)	Range (MHz)
Below 1.705	30
1.705 – 108	1000
108 – 500	2000
500 – 1000	5000
Above 1000	5 <sup>th</sup> harmonic of the highest frequency or 40 GHz, whichever is lower

**7.3 Test procedure**

Receiver Parameter	Setting
Attenuation	Auto
9kHz~150kHz	RBW 200Hz for QP
150kHz~30MHz	RBW 9kHz for QP
30MHz~1000MHz	RBW 120kHz for QP

Spectrum Parameter	Setting
1-25GHz	RBW 1 MHz /VBW 1 MHz for Peak, RBW 1 MHz / VBW 10Hz for Average

Below 1GHz test procedure as below:

- The EUT was placed on the top of a rotating table 0.8 meters above the ground at a 3 meter semi-anechoic chamber. The table was rotated 360 degrees to determine the position of the highest radiation.
- The EUT was set 3 meters away from the interference-receiving antenna, which was mounted on the top of a variable-height antenna tower.
- The antenna height is varied from one meter to four meters above the ground to determine the maximum value of the field strength. Both horizontal and vertical polarizations of the antenna are set to make the measurement.
- For each suspected emission, the EUT was arranged to its worst case and then the antenna was tuned to heights from 1 meter to 4 meters (for the test frequency of below 30MHz, the antenna was tuned to heights 1 meter) and the rotatable table was turned from 0 degrees to 360 degrees to find the maximum reading.
- The test-receiver system was set to Peak Detect Function and Specified Bandwidth with Maximum Hold Mode.

BCTC  
 3C  
 PPR  
 检测



f. If the emission level of the EUT in peak mode was 10dB lower than the limit specified, then testing could be stopped and the peak values of the EUT would be reported. Otherwise the emissions that did not have 10dB margin would be re-tested one by one using peak, quasi-peak or average method as specified and then reported in a data sheet.

Above 1GHz test procedure as below:

g. Different between above is the test site, change from Semi- Anechoic Chamber to fully Anechoic Chamber and change form table 0.8 metre to 1.5 metre( Above 18GHz the distance is 1 meter and table is 1.5 metre).

h. Test the EUT in the lowest channel, the middle channel, the Highest channel.

Note:

Both horizontal and vertical antenna polarities were tested and performed pretest to three orthogonal axis. The worst case emissions were reported.

Above 1GHz test procedure as below:

a.The EUT was placed on the top of a rotating table 1.5 meters above the ground at a 3 meter camber. The table was rotated 360 degrees to determine the position of the highest radiation.

b.The EUT was set 3 meters away from the interference-receiving antenna, which was mounted on the top of a variable-height antenna tower.

c.The antenna height is varied from one meter to four meters above the ground to determine the maximum value of the field strength. Both horizontal and vertical polarizations of the antenna are set to make the measurement.

d.For each suspected emission, the EUT was arranged to its worst case and then the antenna was tuned to heights from 1 meter to 4 meters and the rota table was turned from 0 degrees to 360 degrees to find the maximum reading.

e.The test-receiver system was set to Peak Detect Function and Specified Bandwidth with Maximum Hold Mode.

f. If the emission level of the EUT in peak mode was 10dB lower than the limit specified, then testing could be stopped and the peak values of the EUT would be reported. Otherwise the emissions that did not have 10dB margin would be re-tested one by one using peak, quasi-peak or average method as specified and then reported in a data sheet.

g.Test the EUT in the lowest channel, the Highest channel.

Note:

Both horizontal and vertical antenna polarities were tested and performed pretest to three orthogonal axis. The worst case emissions were reported.

## 7.4 EUT operating Conditions

The EUT was configured for testing in a typical fashion (as a customer would normally use it). The EUT has been programmed to continuously transmit during test. This operating condition was tested and used to collect the included data.

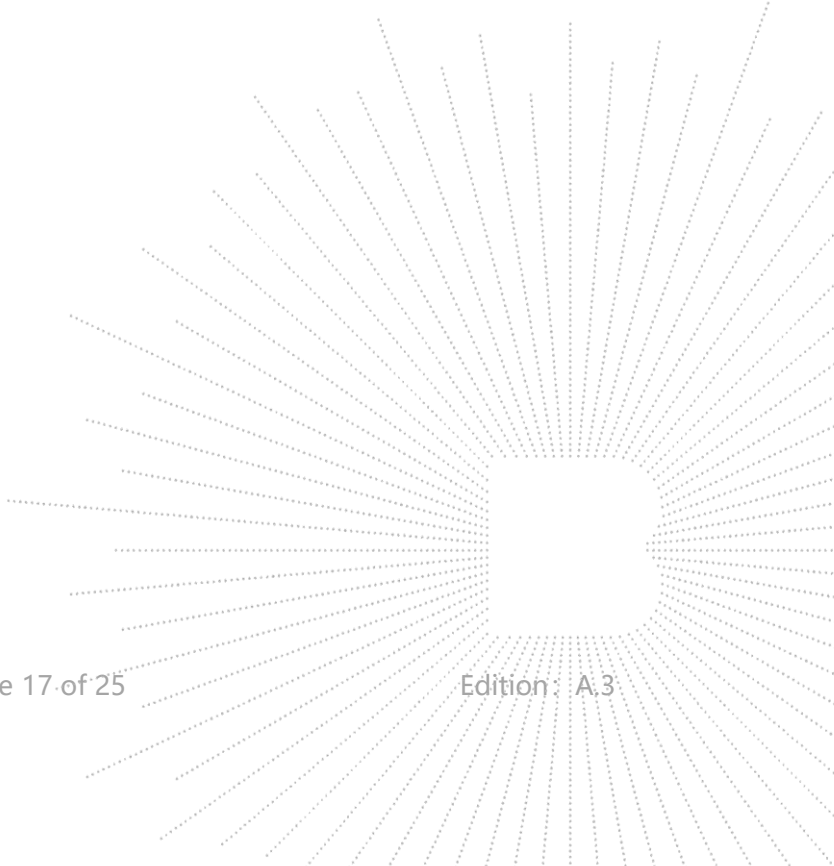

## 7.5 Test Result

Below 30MHz

Temperature:	26°C	Relative Humidity:	54%
Pressure:	101 kPa	Test Voltage :	DC 3.7V
Test Mode :	Mode 1	Polarization :	--

Freq. (MHz)	Reading (dBuV/m)	Limit (dBuV/m)	Margin (dB)	State P/F
--	--	--	--	PASS
--	--	--	--	PASS

**Note:**

The amplitude of spurious emissions which are attenuated by more than 20dB below the permissible value has no need to be reported.

Distance extrapolation factor =  $40 \log(\text{specific distance}/\text{test distance})$ (dB);

Limit line = specific limits(dBuv) + distance extrapolation factor.

S. CO., LTD.

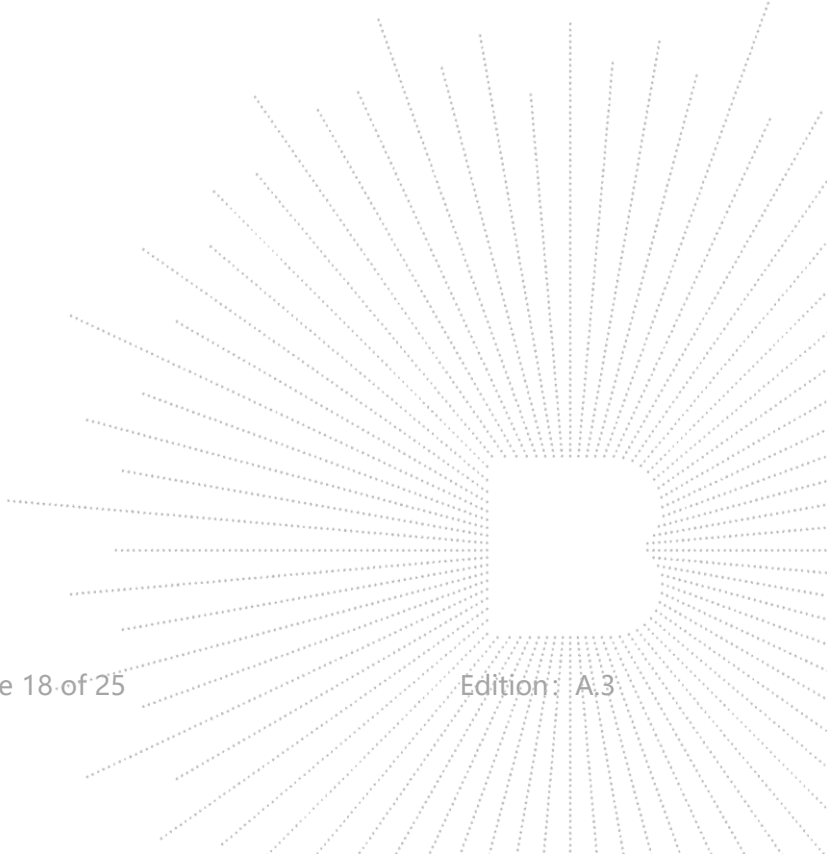

## Between 30MHz – 1GHz

Temperature:	26°C	Relative Humidity:	54%
Pressure:	101 kPa	Test Voltage :	DC 3.7V
Test Mode :	Mode 1	Polarization :	Horizontal

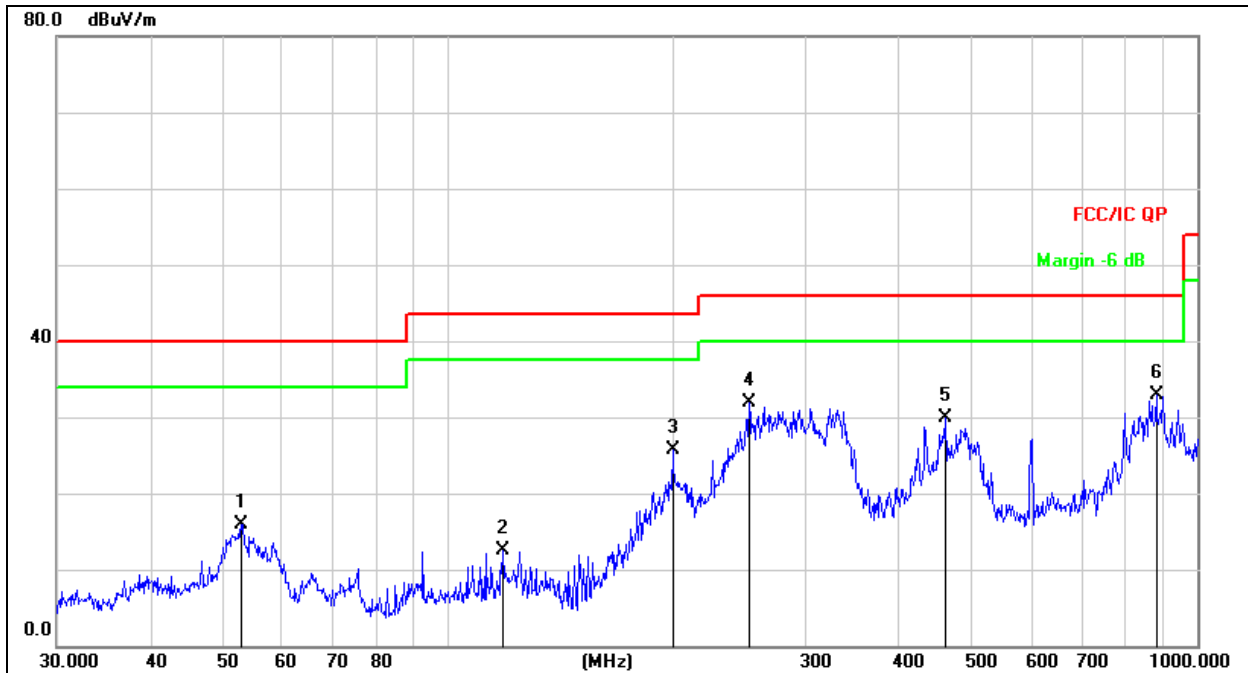

## Remark:

- Factor = Antenna Factor + Cable Loss – Pre-amplifier.
- Measurement=Reading Level+ Correct Factor
- Over=Measurement-Limit

No.	Mk.	Freq. MHz	Reading Level dBuV	Correct Factor dB	Measure- ment dBuV/m	Limit dB/m	Over dB	Detector
1		52.9453	32.03	-16.03	16.00	40.00	-24.00	QP
2		118.1862	31.49	-18.96	12.53	43.50	-30.97	QP
3		199.2855	43.14	-17.42	25.72	43.50	-17.78	QP
4		252.0627	47.73	-15.78	31.95	46.00	-14.05	QP
5		460.7271	41.09	-11.22	29.87	46.00	-16.13	QP
6	*	881.4067	37.65	-4.80	32.85	46.00	-13.15	QP

Temperature:	26°C	Relative Humidity:	54%
Pressure:	101 hPa	Test Voltage :	DC 3.7V
Test Mode :	Mode 1	Polarization :	Vertical

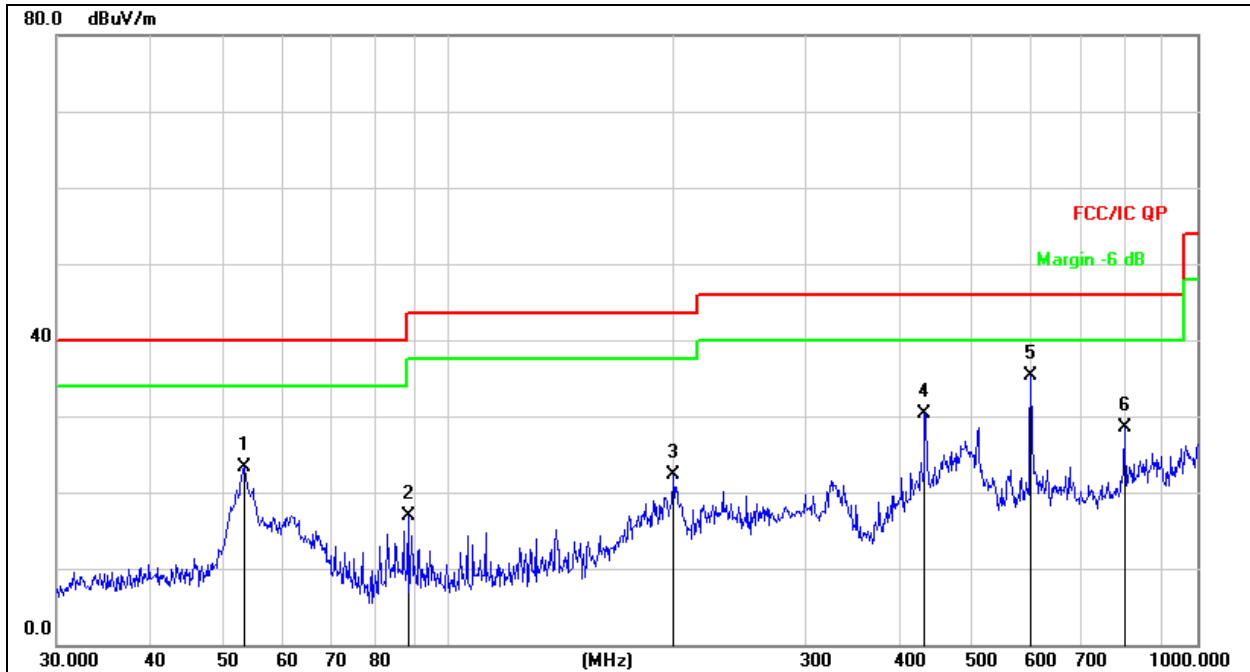
**Remark:**

1. Factor = Antenna Factor + Cable Loss – Pre-amplifier.
2. Measurement=Reading Level+ Correct Factor
3. Over=Measurement-Limit

No.	Mk.	Freq. MHz	Reading Level dBuV	Correct Factor dB	Measure- ment dBuV/m	Limit dB/m	Over dB	Detector
1		53.3179	39.49	-16.09	23.40	40.00	-16.60	QP
2		88.3421	36.55	-19.62	16.93	43.50	-26.57	QP
3		199.9856	39.65	-17.37	22.28	43.50	-21.22	QP
4		432.5457	42.07	-11.74	30.33	46.00	-15.67	QP
5	*	599.3212	43.77	-8.42	35.35	46.00	-10.65	QP
6		798.9797	34.13	-5.59	28.54	46.00	-17.46	QP



## 8. EUT PHOTOGRAPHS

EUT Photo 1



EUT Photo 2



BCTC  
BC  
APP  
停止





**EUT Photo 3**



**EUT Photo 4**

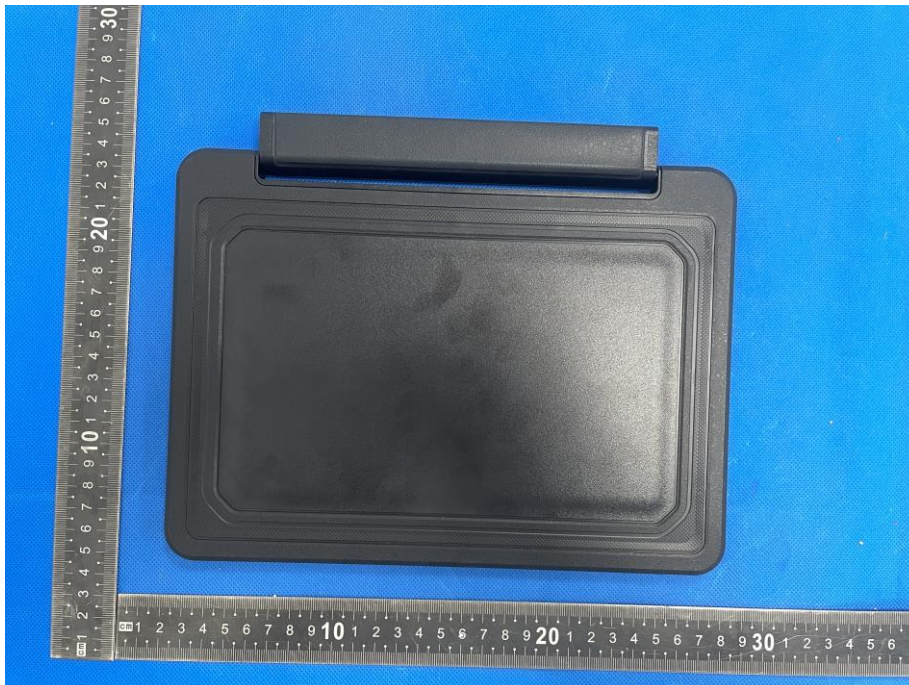

CT  
CT  
PROC  
則本

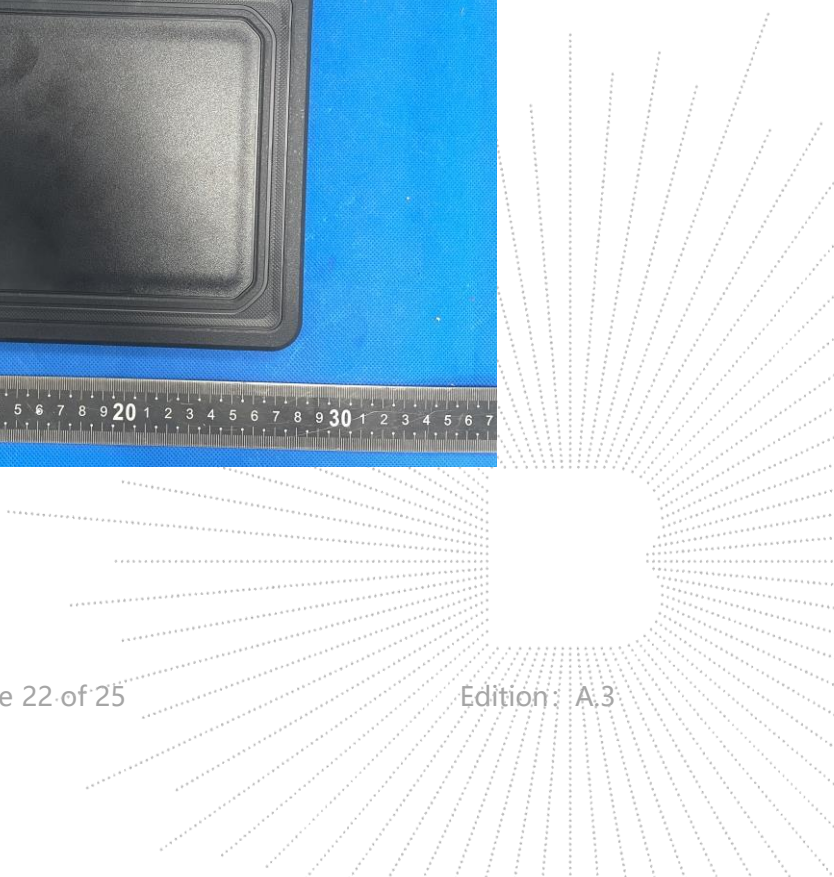



## 9. EUT TEST SETUP PHOTOGRAPHS

### Conducted emissions



### Radiated emission

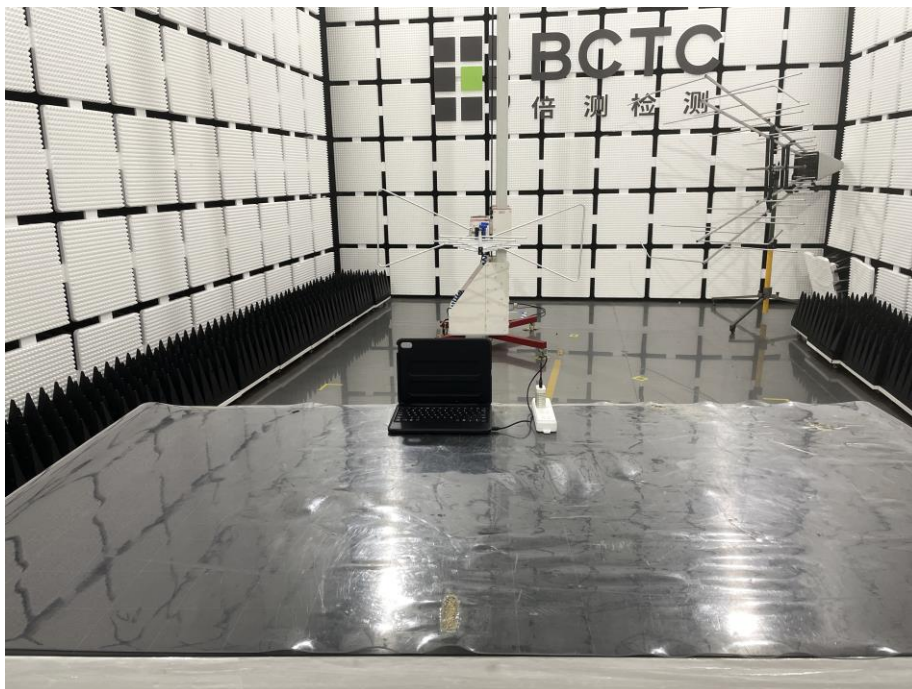

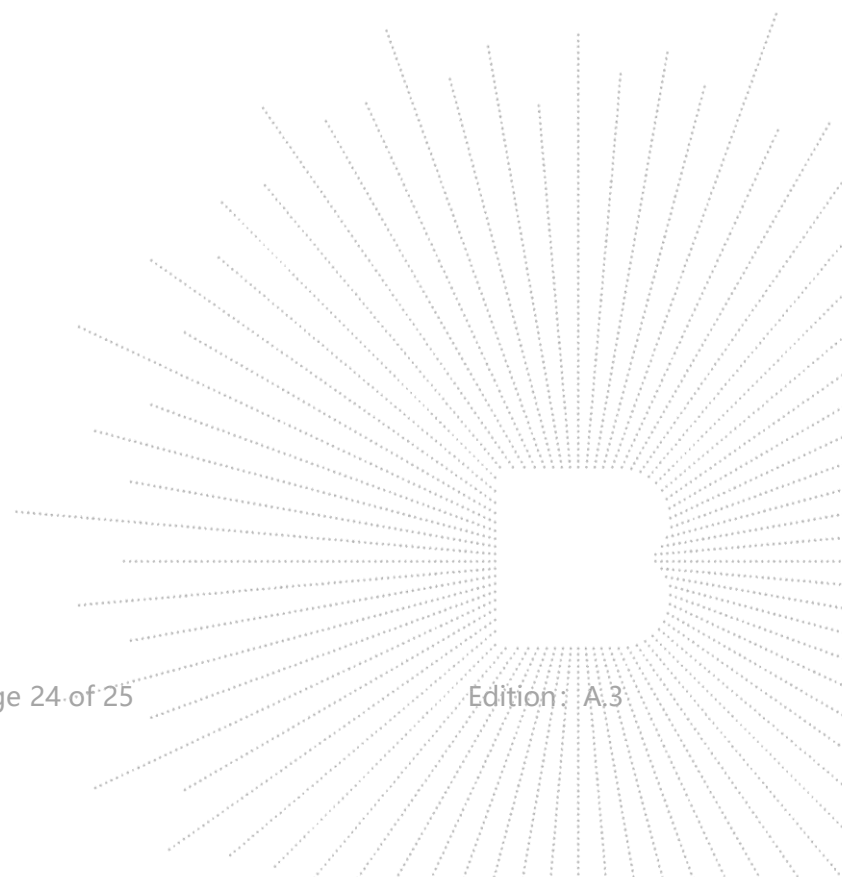

**STATEMENT**

1. The equipment lists are traceable to the national reference standards.
2. The test report can not be partially copied unless prior written approval is issued from our lab.
3. The test report is invalid without the "special seal for inspection and testing".
4. The test report is invalid without the signature of the approver.
5. The test process and test result is only related to the Unit Under Test.
6. Sample information is provided by the client and the laboratory is not responsible for its authenticity.
7. The quality system of our laboratory is in accordance with ISO/IEC17025.
8. If there is any objection to this test report, the client should inform issuing laboratory within 15 days from the date of receiving test report.

**Address:**

1-2/F., Building B, Pengzhou Industrial Park, No.158, Fuyuan 1st Road, Zhancheng, Fuhai Subdistrict, Bao'an District, Shenzhen, Guangdong, China

TEL: 400-788-9558

P.C.: 518103

FAX: 0755-33229357

Website: <http://www.chnbctc.com>

E-Mail: [bctc@bctc-lab.com.cn](mailto:bctc@bctc-lab.com.cn)

**\*\*\*\*\* END \*\*\*\*\***

CO., LTD.

