

TEST REPORT

Report No.: BCTC2208392892E

Applicant: ZAGG Inc.

Product Name: Bluetooth Keyboard

Model/Type Ref.: RuggedBook-I-A97RGK-BB0

Tested Date: 2022-08-25 to 2022-08-30

Issued Date: 2022-09-23

Shenzhen BCTC Testing Co., Ltd.



FCC ID: QTG-ZKPRB

Product Name: Bluetooth Keyboard
Trademark: ZAGG
Model/Type Ref.: RuggedBook-I-A97RGK-BB0
Prepared For: ZAGG Inc.
Address: 910 West Legacy Center Way, Midvale Utah 84047, United States
Manufacturer: ZAGG Inc.
Address: 910 West Legacy Center Way, Midvale Utah 84047, United States
Prepared By: Shenzhen BCTC Testing Co., Ltd.
Address: 1-2/F., Building B, Pengzhou Industrial Park, No.158, Fuyuan 1st Road, Zhancheng, Fuhai Subdistrict, Bao'an District, Shenzhen, Guangdong, China
Sample Received Date: 2022-08-25
Sample tested Date: 2022-08-25 to 2022-08-30
Issue Date: 2022-09-23
Report No.: BCTC2208392892E
Test Standards: FCC Part15.247
ANSI C63.10-2013
Test Results: PASS
Remark: This is Bluetooth BLE radio test report.

Tested by:

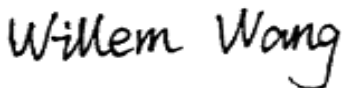
Willem Wang/Project Handler

Approved by:

Zero Zhou/Reviewer

The test report is effective only with both signature and specialized stamp. This result(s) shown in this report refer only to the sample(s) tested. Without written approval of Shenzhen BCTC Testing Co., Ltd, this report can't be reproduced except in full. The tested sample(s) and the sample information are provided by the client.

Table Of Content

	Page
Test Report Declaration	
1. Version	4
2. Test Summary	5
3. Measurement Uncertainty	6
4. Product Information And Test Setup	7
4.1 Product Information.....	7
4.2 Test Setup Configuration	8
4.3 Support Equipment	8
4.4 Channel List	9
4.5 Test Mode	9
4.6 Copy of marking plate	9
5. Test Facility And Test Instrument Used.....	10
5.1 Test Facility.....	10
5.2 Test Instrument Used.....	10
6. Conducted emissions	11
6.1 Block Diagram Of Test Setup.....	11
6.2 Limit	11
6.3 Test procedure.....	11
6.4 EUT operating Conditions	11
6.5 Test Result.....	12
7. Radiated emissions	14
7.1 Block Diagram Of Test Setup.....	14
7.2 Limit	15
7.3 Test procedure.....	16
7.4 EUT operating Conditions	17
7.5 Test Result.....	18
8. EUT Photographs.....	23
9. EUT TEST SETUP Photographs.....	25

(Note: N/A Means Not Applicable)

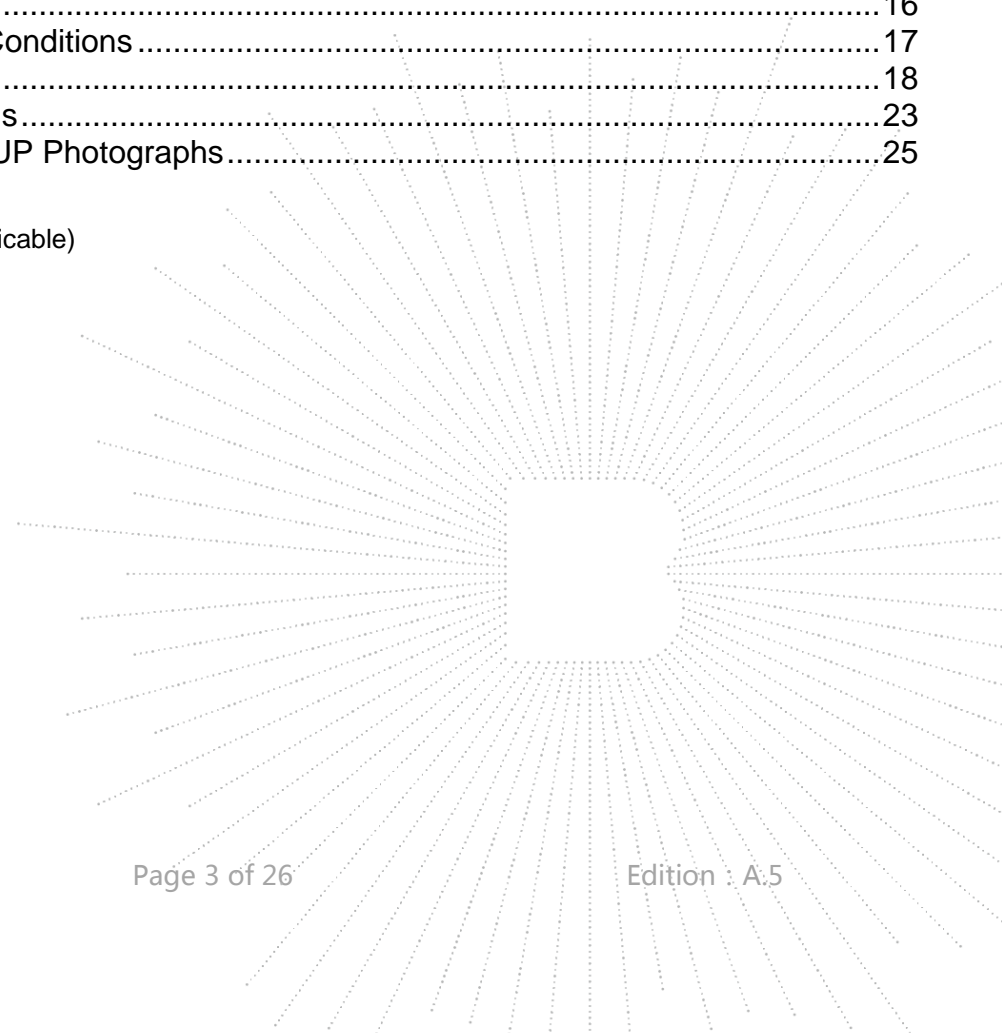

1. Version

Report No.	Issue Date	Description	Approved
BCTC2208392892E	2022-09-23	Original	Valid

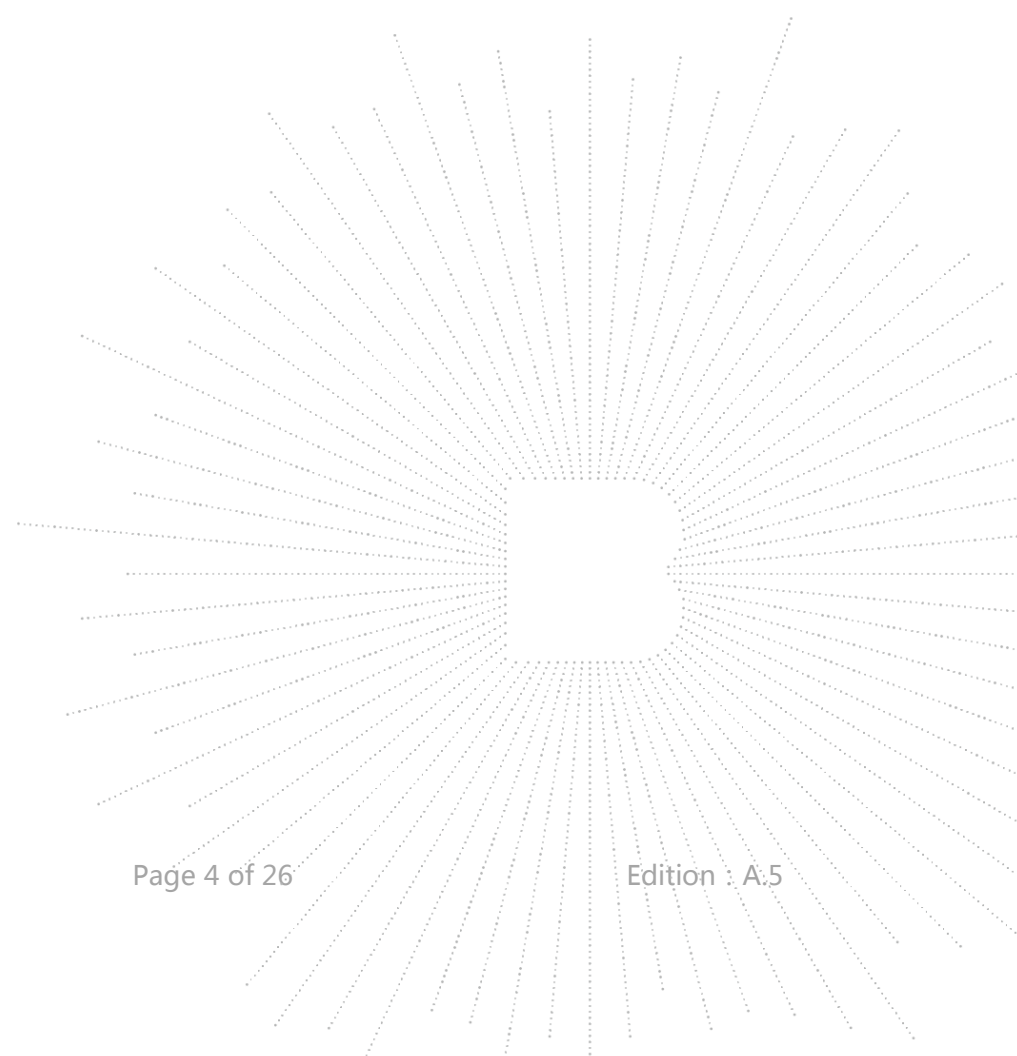

2. Test Summary

The Product has been tested according to the following specifications:

No.	Test Parameter	Clause No	Results
1	Conducted emissions	15.207	PASS
2	Radiated Emissions	15.209	PASS

Remark: Based on the following changes in the product, the RF chip remains unchanged.
So the report is only updated Conducted emissions and Radiated Emissions for the original report (BCTC2105219408E) .

Changes : 1. The new product cappearance changes;

Original:

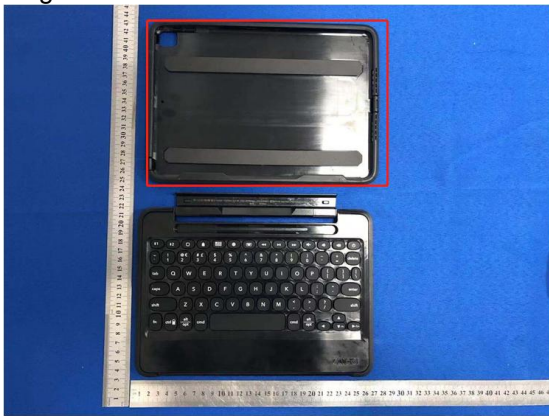

new



3. Measurement Uncertainty

Where relevant, the following measurement uncertainty levels have been estimated for tests performed on the Product as specified in CISPR 16-4-2. This uncertainty represents an expanded uncertainty expressed at approximately the 95% confidence level using a coverage factor of k=2.

No.	Item	Uncertainty
1	humidity uncertainty	U=5.3%
2	Temperature uncertainty	U=0.59°C
3	Conducted Emission (150kHz-30MHz)	U=3.2dB
4	Radiated disturbance(30MHz-1000MHz)	U=4.8dB
5	Radiated disturbance(1GHz-6GHz)	U=4.9dB
6	Radiated disturbance(1GHz-18GHz)	U=5.0dB

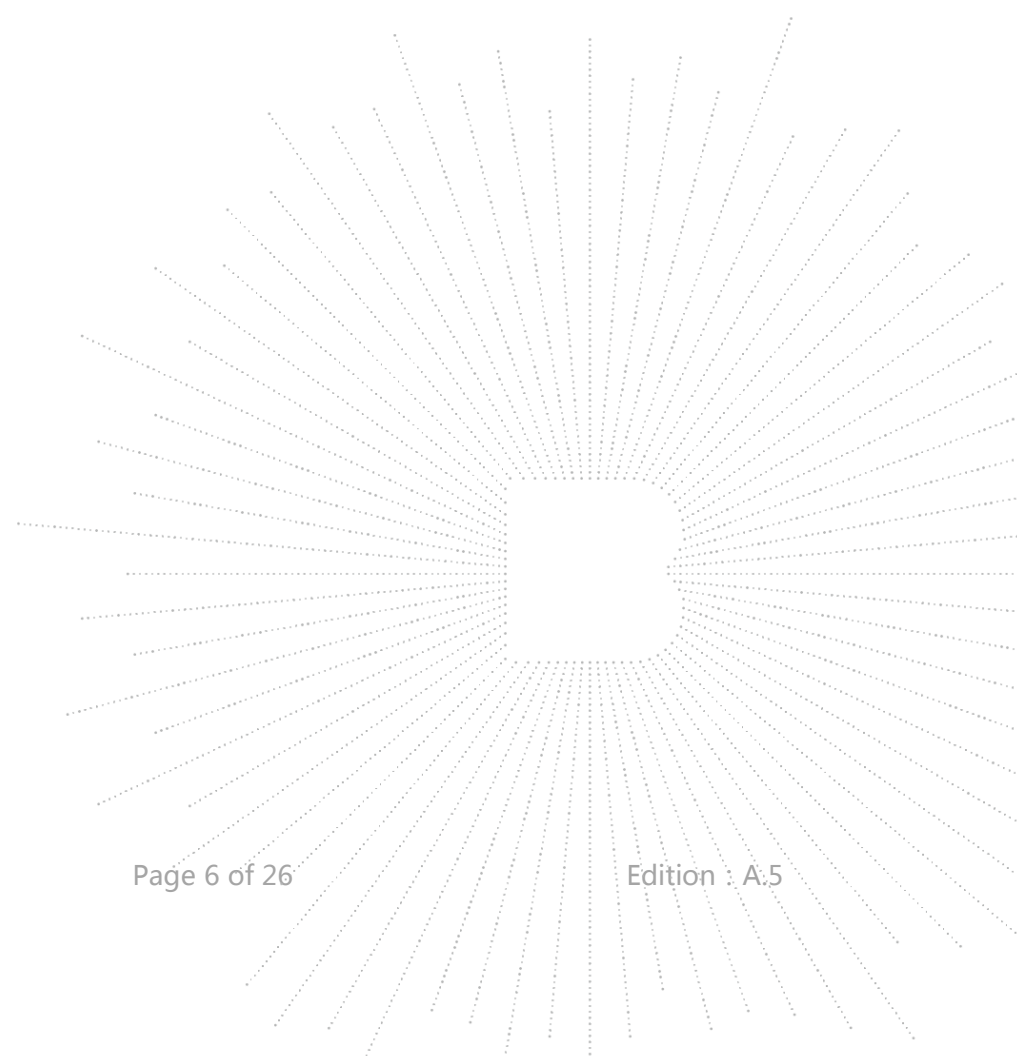

4. Product Information And Test Setup

4.1 Product Information

Model/Type Ref.:	RuggedBook-I-A97RGK-BB0
Model differences:	N/A
Bluetooth Version:	BT 5.0
Hardware Version:	V1.0
Software Version:	V1.0
Operation Frequency:	Bluetooth: 2402-2480MHz
Type of Modulation:	Bluetooth: GFSK
Antenna installation:	Bluetooth: PCB antenna
Antenna Gain:	Bluetooth:1.87dBi
Ratings:	DC 3.7V from Battery DC 5V from Adapter

4.2 Test Setup Configuration

See test photographs attached in *EUT TEST SETUP PHOTOGRAPHS* for the actual connections between Product and support equipment.

Conducted Emission:

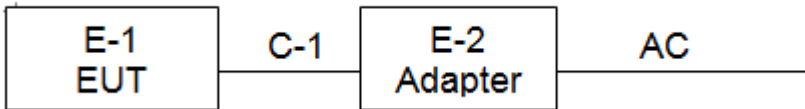

Radiated Spurious Emission

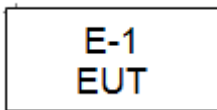

4.3 Support Equipment

No.	Device Type	Brand	Model	Series No.	Data Cable	Power Cord
E-1	Bluetooth Keyboard	ZAGG	RuggedBook-I-A9 7RGK-BB0	N/A	EUT	E-1
E-2	Adapter	N/A	BCTC001	N/A	Auxiliary	E-2

Item	Shielded Type	Ferrite Core	Length	Note
C-1	NO	NO	0.4M	DC cable unshielded

Notes:

1. All the equipment/cables were placed in the worst-case configuration to maximize the emission during the test.
2. Grounding was established in accordance with the manufacturer's requirements and conditions for the intended use.

4.4 Channel List

Channel List					
Channel	Frequency (MHz)	Channel	Frequency (MHz)	Channel	Frequency (MHz)
01	2402	11	2422	21	2442
02	2404	12	2424	22	2444
03	2406	13	2426	23	2446
~	~	~	~	~	~
09	2418	19	2438	39	2478
10	2420	20	2440	40	2480

4.5 Test Mode

Test mode	Test mode	Low channel	Middle channel	High channel
1	Link mode(conducted emission and Radiated emission)			

4.6 Copy of marking plate

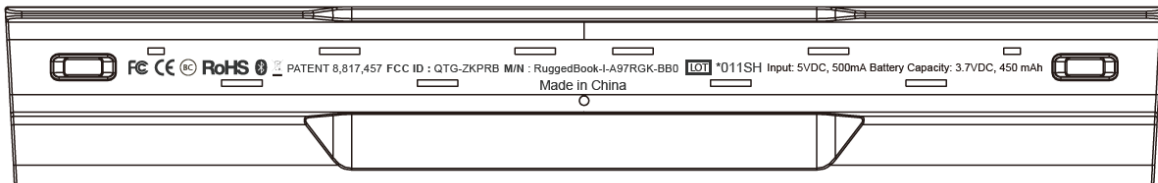

5. Test Facility And Test Instrument Used

5.1 Test Facility

All measurement facilities used to collect the measurement data are located at Shenzhen BCTC Testing Co., Ltd. Address: 1-2/F., Building B, Pengzhou Industrial Park, No.158, Fuyuan 1st Road, Zhancheng, Fuhai Subdistrict, Bao'an District, Shenzhen, Guangdong, China. The site and apparatus are constructed in conformance with the requirements of ANSI C63.4 and CISPR 16-1-1 other equivalent standards.

5.2 Test Instrument Used

Conducted Emissions Test					
Equipment	Manufacturer	Model#	Serial#	Last Cal.	Next Cal.
Receiver	R&S	ESR3	102075	May 24, 2022	May 23, 2023
LISN	R&S	ENV216	101375	May 24, 2022	May 23, 2023
Software	Frad	EZ-EMC	EMC-CON 3A1	\	\
Attenuator	\	10dB DC-6GHz	1650	May 24, 2022	May 23, 2023

Radiated Emissions Test (966 Chamber#01)					
Equipment	Manufacturer	Model#	Serial#	Last Cal.	Next Cal.
966 chamber	ChengYu	966 Room	966	Jun. 06. 2020	Jun. 05, 2023
Receiver	R&S	ESRP	101154	May 24, 2022	May 23, 2023
Receiver	R&S	ESR3	102075	May 24, 2022	May 23, 2023
Amplifier	SKET	LAPA_01G18 G-45dB	\	May 24, 2022	May 23, 2023
Amplifier	Schwarzbeck	BBV9744	9744-0037	May 24, 2022	May 23, 2023
TRILOG Broadband Antenna	schwarzbeck	VULB9163	942	May 26, 2022	May 25, 2023
Horn Antenna	schwarzbeck	BBHA9120D	1541	Jun. 06, 2022	Jun. 06, 2023
Software	Frad	EZ-EMC	FA-03A2 RE	\	\

6. Conducted emissions

6.1 Block Diagram Of Test Setup

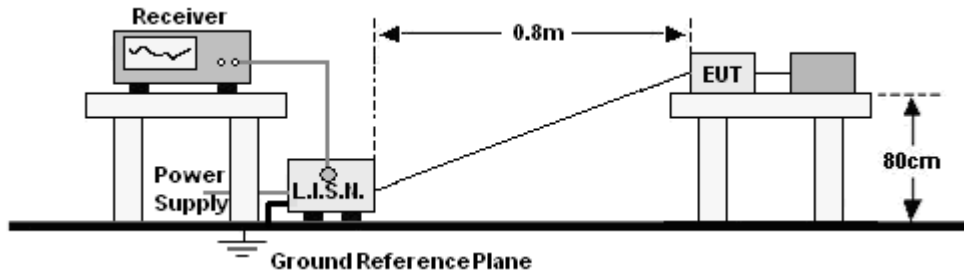

6.2 Limit

FREQUENCY (MHz)	Limit (dBuV)	
	Quas-peak	Average
0.15 -0.5	66 - 56 *	56 - 46 *
0.50 -5.0	56.00	46.00
5.0 -30.0	60.00	50.00

Notes:
 1. *Decreasing linearly with logarithm of frequency.
 2. The lower limit shall apply at the transition frequencies.

6.3 Test procedure

Receiver Parameters	Setting
Attenuation	10 dB
Start Frequency	0.15 MHz
Stop Frequency	30 MHz
IF Bandwidth	9 kHz

- The Product was placed on a nonconductive table 0.8 m above the horizontal ground reference plane, and 0.4 m from the vertical ground reference plane, and connected to the main through Line Impedance Stability Network (L.I.S.N).
- The RBW of the receiver was set at 9 kHz in 150 kHz ~ 30MHz with Peak and AVG detector in Max Hold mode. Run the receiver's pre-scan to record the maximum disturbance generated from Product in all power lines in the full band.
- For each frequency whose maximum record was higher or close to limit, measure its QP and AVG values and record.

6.4 EUT operating Conditions

The EUT was configured for testing in a typical fashion (as a customer would normally use it). The EUT has been programmed to continuously transmit during test. This operating condition was tested and used to collect the included data.

6.5 Test Result

Temperature:	26 °C	Relative Humidity:	54%
Pressure:	101KPa	Test Voltage :	AC120V/60Hz
Test Mode:	Mode 1	Polarization :	L

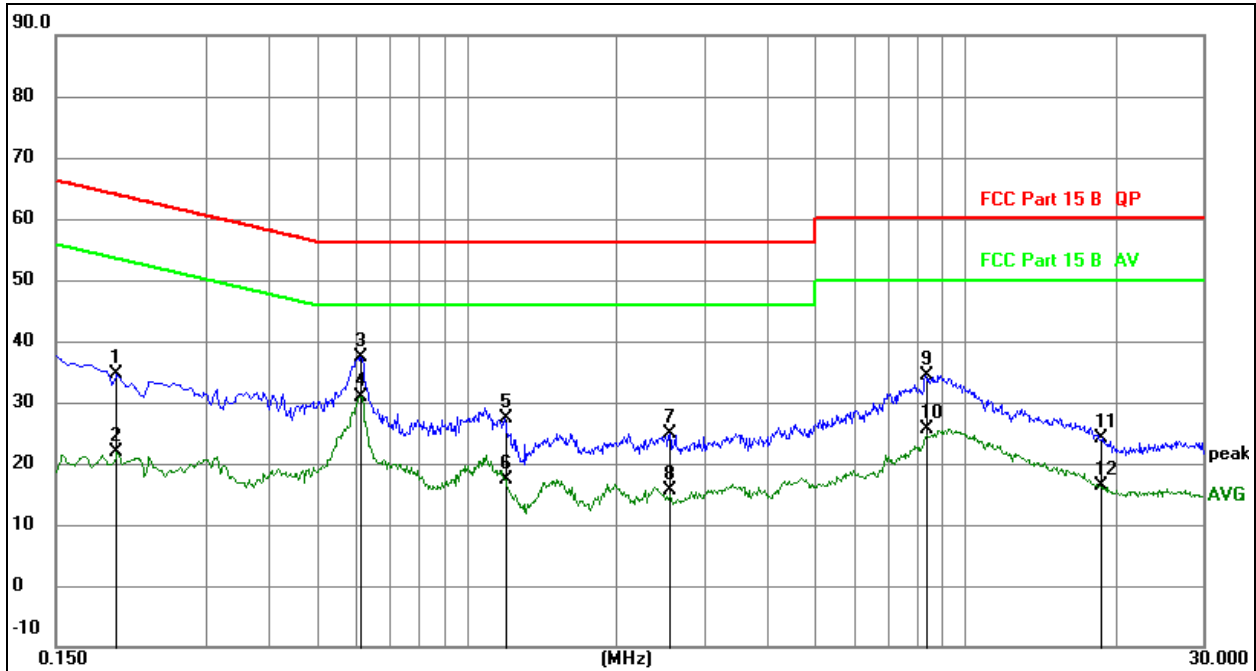

Remark:

1. All readings are Quasi-Peak and Average values.
2. Factor = Insertion Loss + Cable Loss.
3. Measurement = Reading Level + Correct Factor
4. Over = Measurement - Limit

No.	Mk.	Freq. MHz	Reading Level	Correct Factor dB	Measure- ment dBuV	Limit dBuV	Over dB	Detector
1		0.1986	14.77	19.80	34.57	63.67	-29.10	QP
2		0.1986	2.00	19.80	21.80	53.67	-31.87	AVG
3		0.6108	17.74	19.73	37.47	56.00	-18.53	QP
4	*	0.6108	11.22	19.73	30.95	46.00	-15.05	AVG
5		1.1940	7.68	19.78	27.46	56.00	-28.54	QP
6		1.1940	-2.34	19.78	17.44	46.00	-28.56	AVG
7		2.5535	4.91	19.94	24.85	56.00	-31.15	QP
8		2.5535	-4.23	19.94	15.71	46.00	-30.29	AVG
9		8.3580	14.19	20.23	34.42	60.00	-25.58	QP
10		8.3580	5.41	20.23	25.64	50.00	-24.36	AVG
11		18.6221	3.59	20.45	24.04	60.00	-35.96	QP
12		18.6221	-4.07	20.45	16.38	50.00	-33.62	AVG

Temperature:	26 °C	Relative Humidity:	54%
Pressure:	101KPa	Test Voltage :	AC120V/60Hz
Test Mode:	Mode 1	Polarization :	N

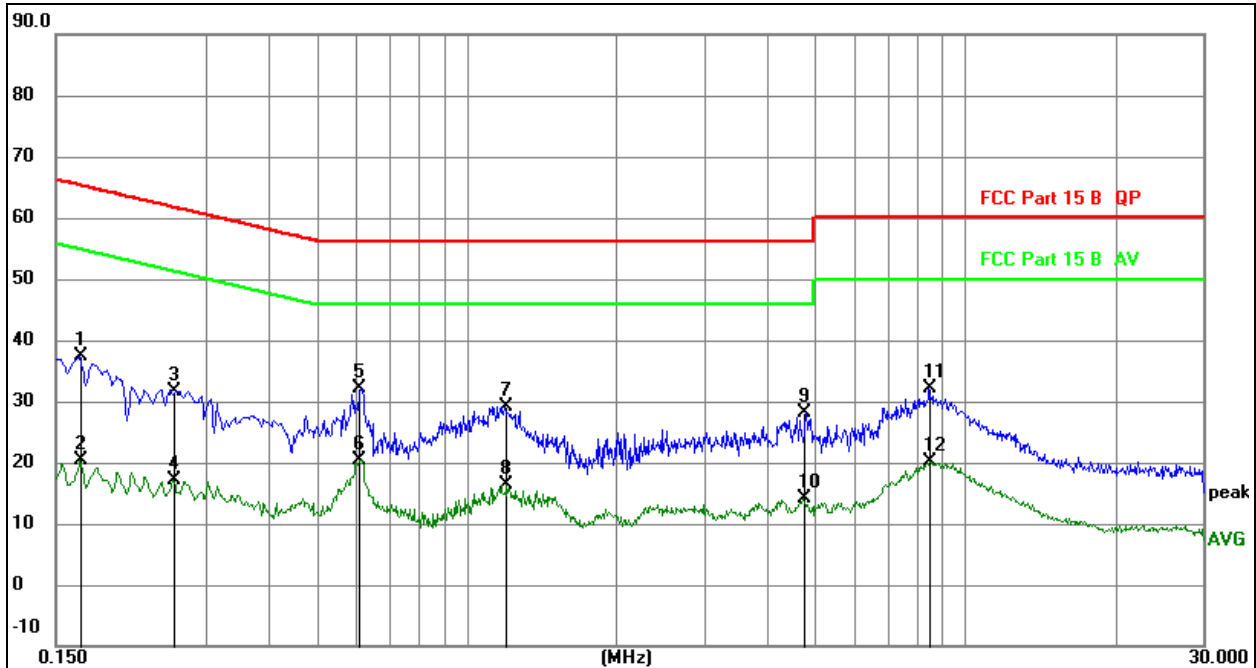
Remark:

1. All readings are Quasi-Peak and Average values.
2. Factor = Insertion Loss + Cable Loss.
3. Measurement = Reading Level + Correct Factor
4. Over = Measurement - Limit

No. Mk.	Freq. MHz	Reading Level	Correct Factor dB	Measure- ment dBuV	Limit dBuV	Over dB	Detector
1	0.1680	17.62	19.72	37.34	65.06	-27.72	QP
2	0.1680	0.54	19.72	20.26	55.06	-34.80	AVG
3	0.2580	11.86	19.78	31.64	61.50	-29.86	QP
4	0.2580	-2.61	19.78	17.17	51.50	-34.33	AVG
5 *	0.6090	12.36	19.73	32.09	56.00	-23.91	QP
6	0.6090	0.70	19.73	20.43	46.00	-25.57	AVG
7	1.1940	9.39	19.78	29.17	56.00	-26.83	QP
8	1.1940	-3.33	19.78	16.45	46.00	-29.55	AVG
9	4.7220	8.02	20.12	28.14	56.00	-27.86	QP
10	4.7220	-5.89	20.12	14.23	46.00	-31.77	AVG
11	8.4885	11.98	20.23	32.21	60.00	-27.79	QP
12	8.4885	-0.05	20.23	20.18	50.00	-29.82	AVG

7. Radiated emissions

7.1 Block Diagram Of Test Setup

(A) Radiated Emission Test-Up Frequency Below 30MHz

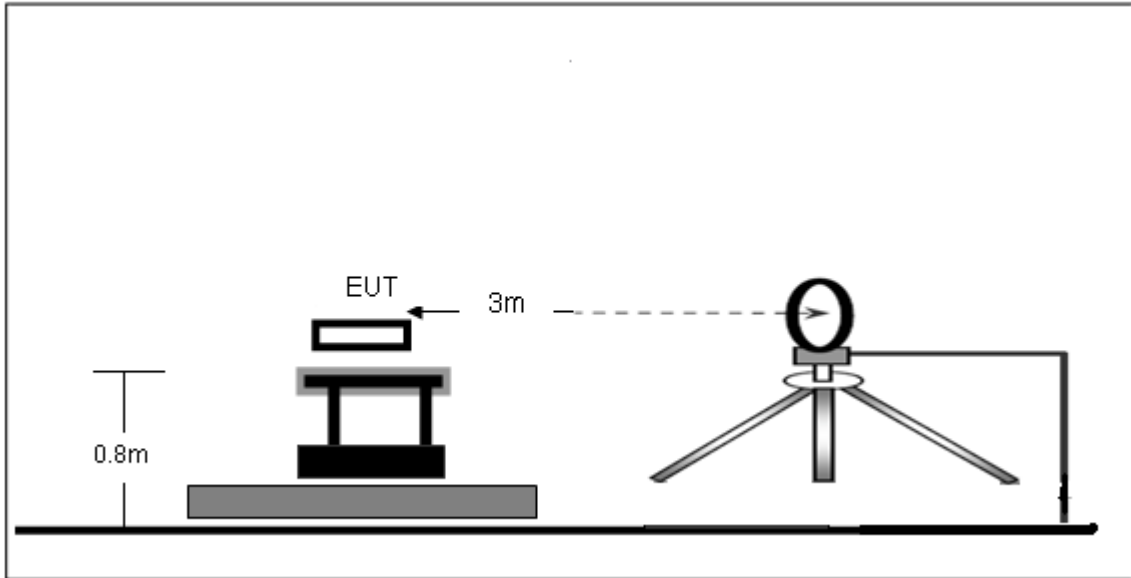

(B) Radiated Emission Test-Up Frequency 30MHz~1GHz

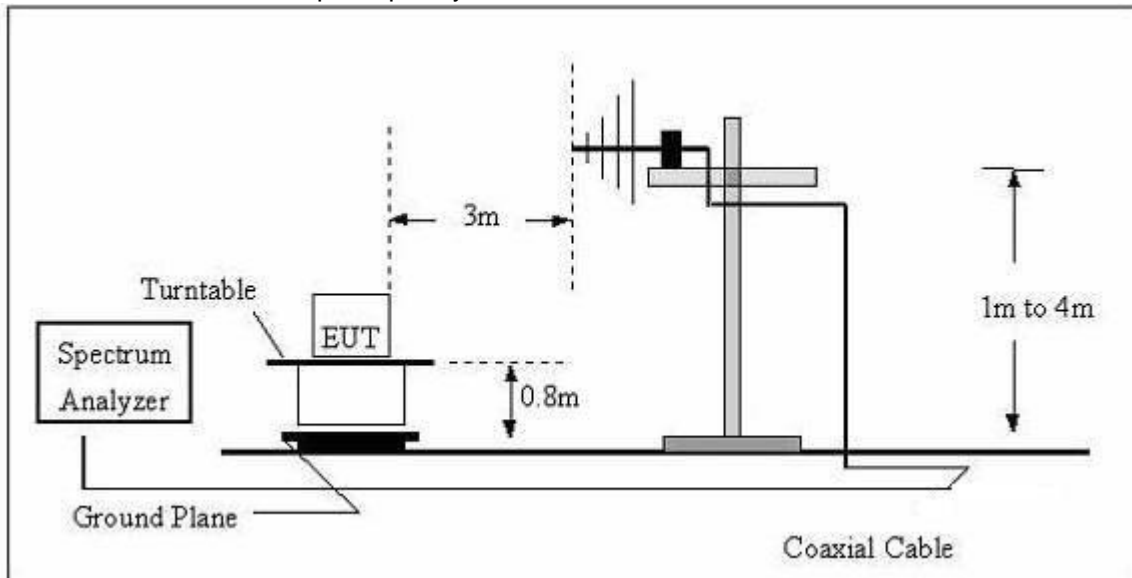

(C) Radiated Emission Test-Up Frequency Above 1GHz

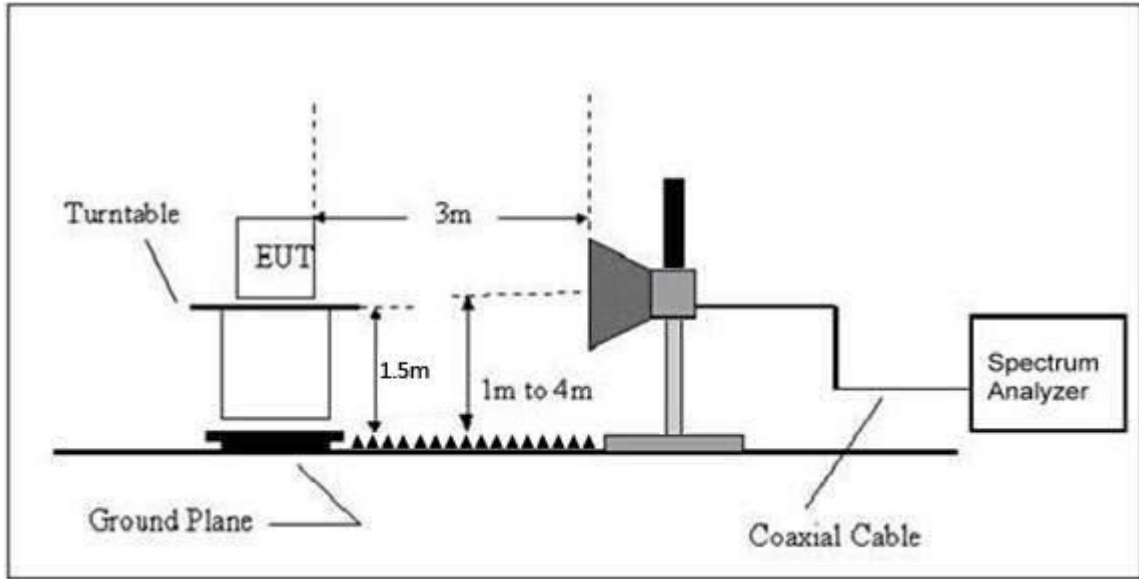
7.2 Limit

20dBc in any 100 kHz bandwidth outside the operating frequency band. In case the emission fall within the restricted band specified on 15.205(a), then the 15.209(a) limit in the table below has to be followed.

Frequency (MHz)	Field Strength uV/m	Distance (m)	Field Strength Limit at 3m Distance	
			uV/m	dBuV/m
0.009 ~ 0.490	$2400/F(\text{kHz})$	300	$10000 * 2400/F(\text{kHz})$	$20\log^{(2400/F(\text{kHz}))} + 80$
0.490 ~ 1.705	$24000/F(\text{kHz})$	30	$100 * 24000/F(\text{kHz})$	$20\log^{(24000/F(\text{kHz}))} + 40$
1.705 ~ 30	30	30	$100 * 30$	$20\log^{(30)} + 40$
30 ~ 88	100	3	100	$20\log^{(100)}$
88 ~ 216	150	3	150	$20\log^{(150)}$
216 ~ 960	200	3	200	$20\log^{(200)}$
Above 960	500	3	500	$20\log^{(500)}$

LIMITS OF RADIATED EMISSION MEASUREMENT (Above 1000MHz)

FREQUENCY (MHz)	Limit (dBuV/m) (at 3M)	
	PEAK	AVERAGE
Above 1000	74	54

Notes:

- (1)The limit for radiated test was performed according to FCC PART 15C.
- (2)The tighter limit applies at the band edges.
- (3) Emission level (dBuV/m)=20log Emission level (uV/m).

Frequency Range Of Radiated Measurement

(a) For an intentional radiator the spectrum shall be investigated from the lowest radio frequency signal generated in the device, without going below 9 kHz, up to at least the frequency shown in this paragraph:

(1) If the intentional radiator operates below 10 GHz: to the tenth harmonic of the highest fundamental frequency or to 40 GHz, whichever is lower.

(2) If the intentional radiator operates at or above 10 GHz and below 30 GHz: to the fifth harmonic of the highest fundamental frequency or to 100 GHz, whichever is lower.

(3) If the intentional radiator operates at or above 30 GHz: to the fifth harmonic of the highest fundamental frequency or to 200 GHz, whichever is lower, unless specified otherwise elsewhere in the rules.

(4) If the intentional radiator operates at or above 95 GHz: To the third harmonic of the highest fundamental frequency or to 750 GHz, whichever is lower, unless specified otherwise elsewhere in the rules.

(5) If the intentional radiator contains a digital device, regardless of whether this digital device controls the functions of the intentional radiator or the digital device is used for additional control or function purposes other than to enable the operation of the intentional radiator, the frequency range shall be investigated up to the range specified in paragraphs (a) (1)through (4) of this section or the range applicable to the digital device, as shown in paragraph (b)(1) of this section, whichever is the higher frequency range of investigation.

7.3 Test procedure

Receiver Parameter	Setting
Attenuation	Auto
9kHz~150kHz	RBW 200Hz for QP
150kHz~30MHz	RBW 9kHz for QP
30MHz~1000MHz	RBW 120kHz for QP

Spectrum Parameter	Setting
1-25GHz	RBW 1 MHz /VBW 1 MHz for Peak, RBW 1 MHz / VBW 10Hz for Average

Below 1GHz test procedure as below:

- a. The EUT was placed on the top of a rotating table 0.8 meters above the ground at a 3 meter semi-anechoic chamber. The table was rotated 360 degrees to determine the position of the highest radiation.
- b. The EUT was set 3 meters away from the interference-receiving antenna, which was mounted on the top of a variable-height antenna tower.
- c. The antenna height is varied from one meter to four meters above the ground to determine the maximum value of the field strength. Both horizontal and vertical polarizations of the antenna are set to make the measurement.

- d. For each suspected emission, the EUT was arranged to its worst case and then the antenna was tuned to heights from 1 meter to 4 meters (for the test frequency of below 30MHz, the antenna was tuned to heights 1 meter) and the rotatable table was turned from 0 degrees to 360 degrees to find the maximum reading.
- e. The test-receiver system was set to Peak Detect Function and Specified Bandwidth with Maximum Hold Mode.
- f. If the emission level of the EUT in peak mode was 10dB lower than the limit specified, then testing could be stopped and the peak values of the EUT would be reported. Otherwise the emissions that did not have 10dB margin would be re-tested one by one using peak, quasi-peak or average method as specified and then reported in a data sheet.

Above 1GHz test procedure as below:

- a.The EUT was placed on the top of a rotating table 1.5 meters above the ground at a 3 meter camber. The table was rotated 360 degrees to determine the position of the highest radiation.
- b.The EUT was set 3 meters away from the interference-receiving antenna, which was mounted on the top of a variable-height antenna tower.
- c.The antenna height is varied from one meter to four meters above the ground to determine the maximum value of the field strength. Both horizontal and vertical polarizations of the antenna are set to make the measurement.
- d.For each suspected emission, the EUT was arranged to its worst case and then the antenna was tuned to heights from 1 meter to 4 meters and the rota table was turned from 0 degrees to 360 degrees to find the maximum reading.
- e.The test-receiver system was set to Peak Detect Function and Specified Bandwidth with Maximum Hold Mode.
- f. If the emission level of the EUT in peak mode was 10dB lower than the limit specified, then testing could be stopped and the peak values of the EUT would be reported. Otherwise the emissions that did not have 10dB margin would be re-tested one by one using peak, quasi-peak or average method as specified and then reported in a data sheet.
- g. Test the EUT in the lowest channel, the middlest channel, the Highest channel.

Note:

Both horizontal and vertical antenna polarities were tested and performed pretest to three orthogonal axis. The worst case emissions were reported.

7.4 EUT operating Conditions

The EUT was configured for testing in a typical fashion (as a customer would normally use it). The EUT has been programmed to continuously transmit during test. This operating condition was tested and used to collect the included data.

7.5 Test Result

Below 30MHz

Temperature:	26°C	Relative Humidity:	54%
Pressure:	101 kPa	Test Voltage :	DC 3.7V
Test Mode :	Mode 1	Polarization :	--

Freq.	Reading	Limit	Margin	State
(MHz)	(dBuV/m)	(dBuV/m)	(dB)	P/F
--	--	--	--	PASS
--	--	--	--	PASS

Note:

The amplitude of spurious emissions which are attenuated by more than 20dB below the permissible value has no need to be reported.

Distance extrapolation factor = $40 \log(\text{specific distance/test distance})(\text{dB})$;

Limit line = specific limits(dBuv) + distance extrapolation factor.

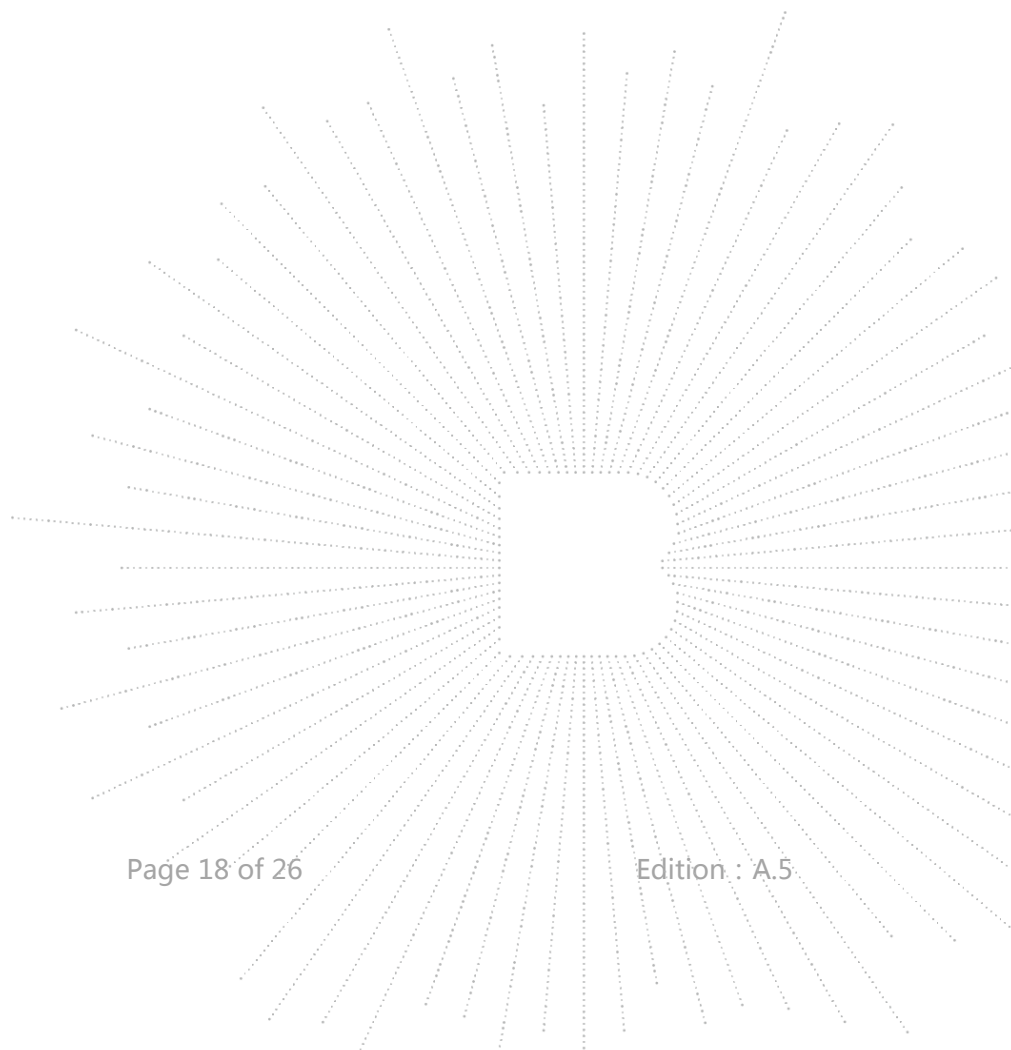

Between 30MHz – 1GHz

Temperature:	26 °C	Relative Humidity:	54%
Pressure:	101KPa	Phase :	Horizontal
Test Mode:	Mode 1	Test Voltage :	AC120V/60Hz

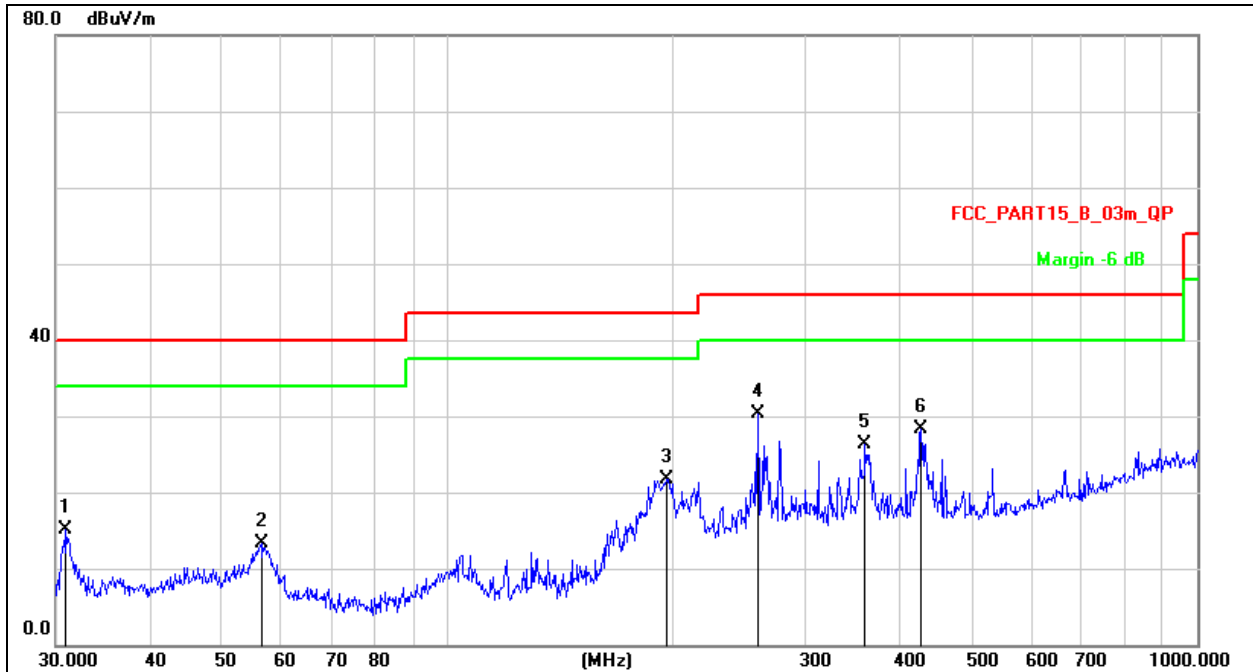

Remark:

1. Factor = Antenna Factor + Cable Loss – Pre-amplifier.
2. Measurement = Reading Level + Correct Factor
3. Over = Measurement - Limit

No.	Mk.	Freq.	Reading Level	Correct Factor	Measurement	Limit	Over	Detector
		MHz	dBuV	dB	dBuV/m	dB/m	dB	
1		30.9618	33.12	-17.98	15.14	40.00	-24.86	QP
2		56.3948	29.36	-16.12	13.24	40.00	-26.76	QP
3		195.8220	38.05	-16.28	21.77	43.50	-21.73	QP
4	*	259.2338	44.08	-13.78	30.30	46.00	-15.70	QP
5		360.4476	37.11	-10.76	26.35	46.00	-19.65	QP
6		428.0193	37.97	-9.61	28.36	46.00	-17.64	QP

Temperature:	26 °C	Relative Humidity:	54%
Pressure:	101KPa	Phase :	Vertical
Test Mode:	Mode 1	Test Voltage :	AC120V/60Hz

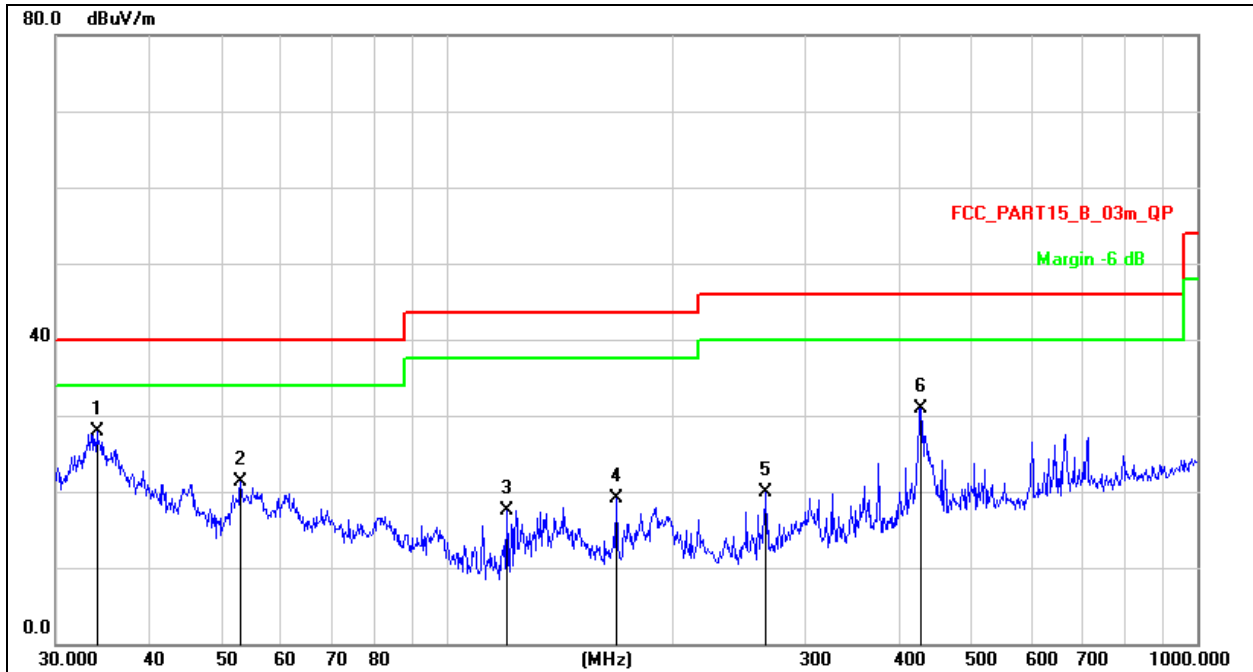

Remark:
 1. Factor = Antenna Factor + Cable Loss – Pre-amplifier.
 2. Measurement = Reading Level + Correct Factor
 3. Over = Measurement - Limit

No.	Mk.	Freq. MHz	Reading Level dBuV	Correct Factor dB	Measure- ment dBuV/m	Limit dB/m	Over dB	Detector
1	*	34.0365	45.35	-17.39	27.96	40.00	-12.04	QP
2		52.9453	36.88	-15.54	21.34	40.00	-18.66	QP
3		119.8556	35.50	-17.97	17.53	43.50	-25.97	QP
4		167.8243	37.49	-18.47	19.02	43.50	-24.48	QP
5		265.6757	33.39	-13.49	19.90	46.00	-26.10	QP
6		428.0193	40.56	-9.61	30.95	46.00	-15.05	QP

Temperature:	26 °C	Relative Humidity:	54%
Pressure:	101KPa	Phase :	Horizontal
Test Mode:	Mode 1	Test Voltage :	DC 3.7V

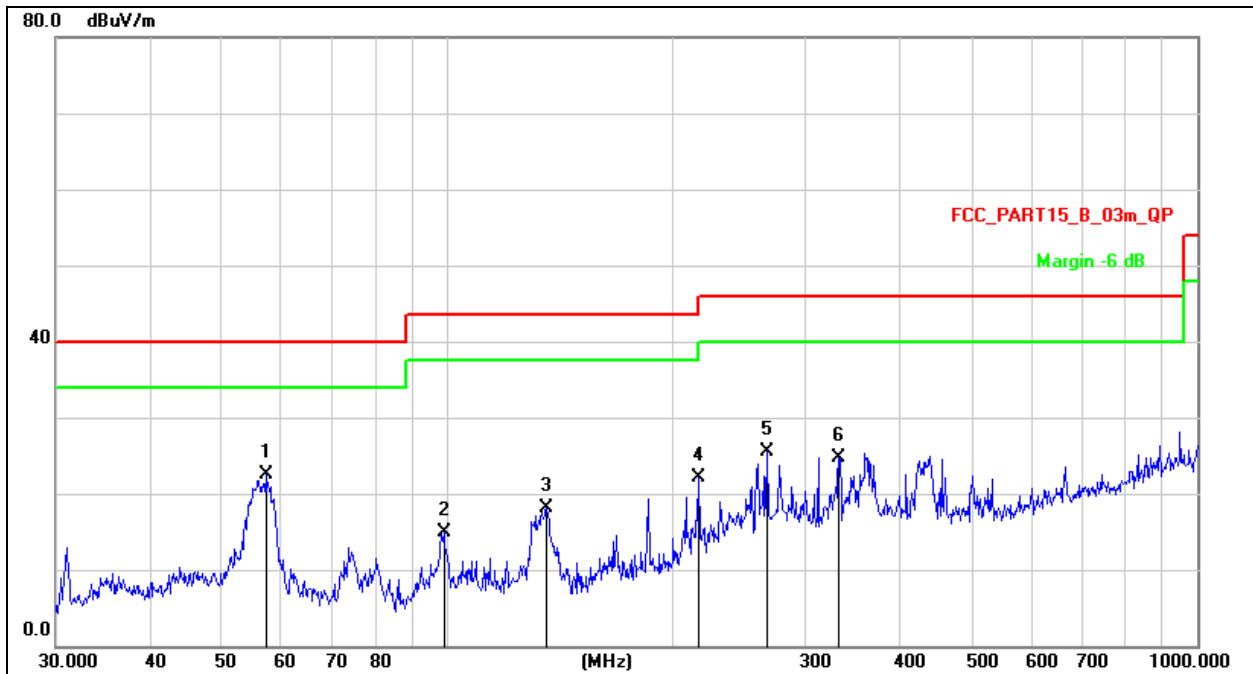

Remark:
 1. Factor = Antenna Factor + Cable Loss – Pre-amplifier.
 2. Measurement = Reading Level + Correct Factor
 3. Over = Measurement - Limit

No.	Mk.	Freq. MHz	Reading Level dBuV	Correct Factor dB	Measure- ment dBuV/m	Limit dB/m	Over dB	Detector
1	*	57.1914	38.74	-16.26	22.48	40.00	-17.52	QP
2		98.8326	31.73	-16.92	14.81	43.50	-28.69	QP
3		135.5062	37.10	-18.95	18.15	43.50	-25.35	QP
4		216.0240	37.44	-15.39	22.05	46.00	-23.95	QP
5		266.6089	38.95	-13.45	25.50	46.00	-20.50	QP
6		332.5187	36.05	-11.30	24.75	46.00	-21.25	QP

Temperature:	26 °C	Relative Humidity:	54%
Pressure:	101KPa	Phase :	Vertical
Test Mode:	Mode 1	Test Voltage :	DC 3.7V

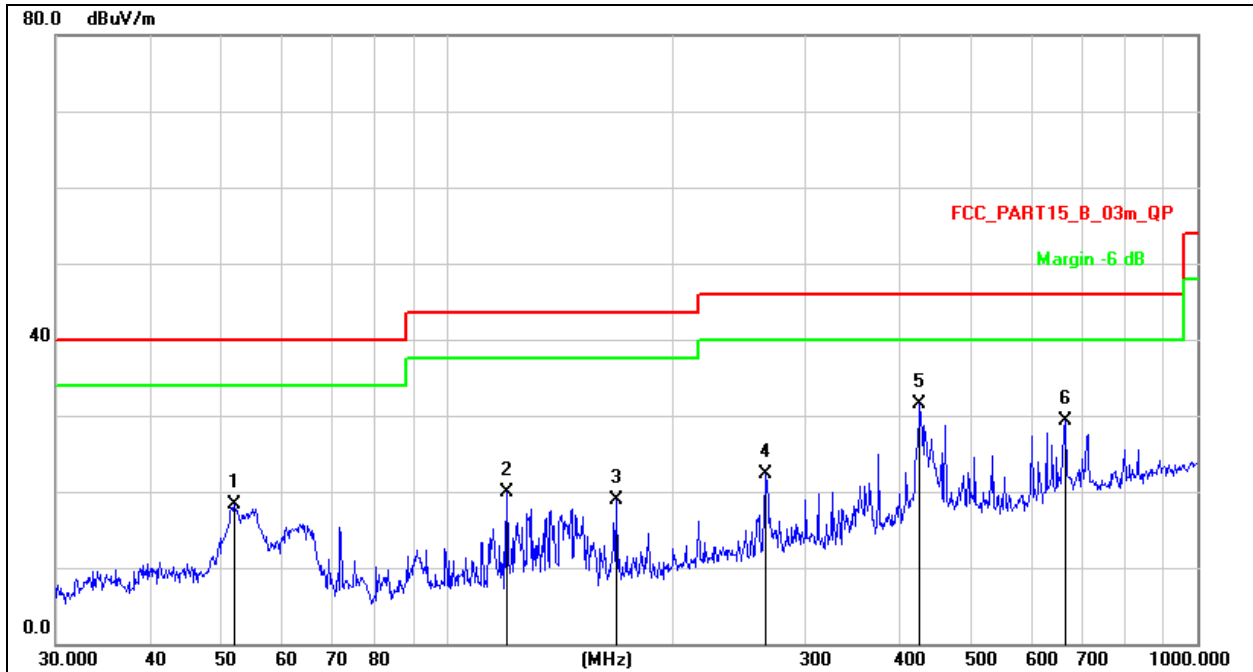
Remark:

1. Factor = Antenna Factor + Cable Loss – Pre-amplifier.
2. Measurement = Reading Level + Correct Factor
3. Over = Measurement - Limit

No.	Mk.	Freq.	Reading Level	Correct Factor	Measurement	Limit	Over	Detector
		MHz	dBuV	dB	dBuV/m	dB/m	dB	
1		51.8430	33.71	-15.35	18.36	40.00	-21.64	QP
2		119.8556	37.92	-17.97	19.95	43.50	-23.55	QP
3		167.8243	37.28	-18.47	18.81	43.50	-24.69	QP
4		265.6757	35.70	-13.49	22.21	46.00	-23.79	QP
5	*	426.5210	41.14	-9.64	31.50	46.00	-14.50	QP
6		665.8035	33.81	-4.50	29.31	46.00	-16.69	QP

8. EUT Photographs

Model: ZKB102RBB41
EUT Photo 1



EUT Photo 2



EUT Photo 3

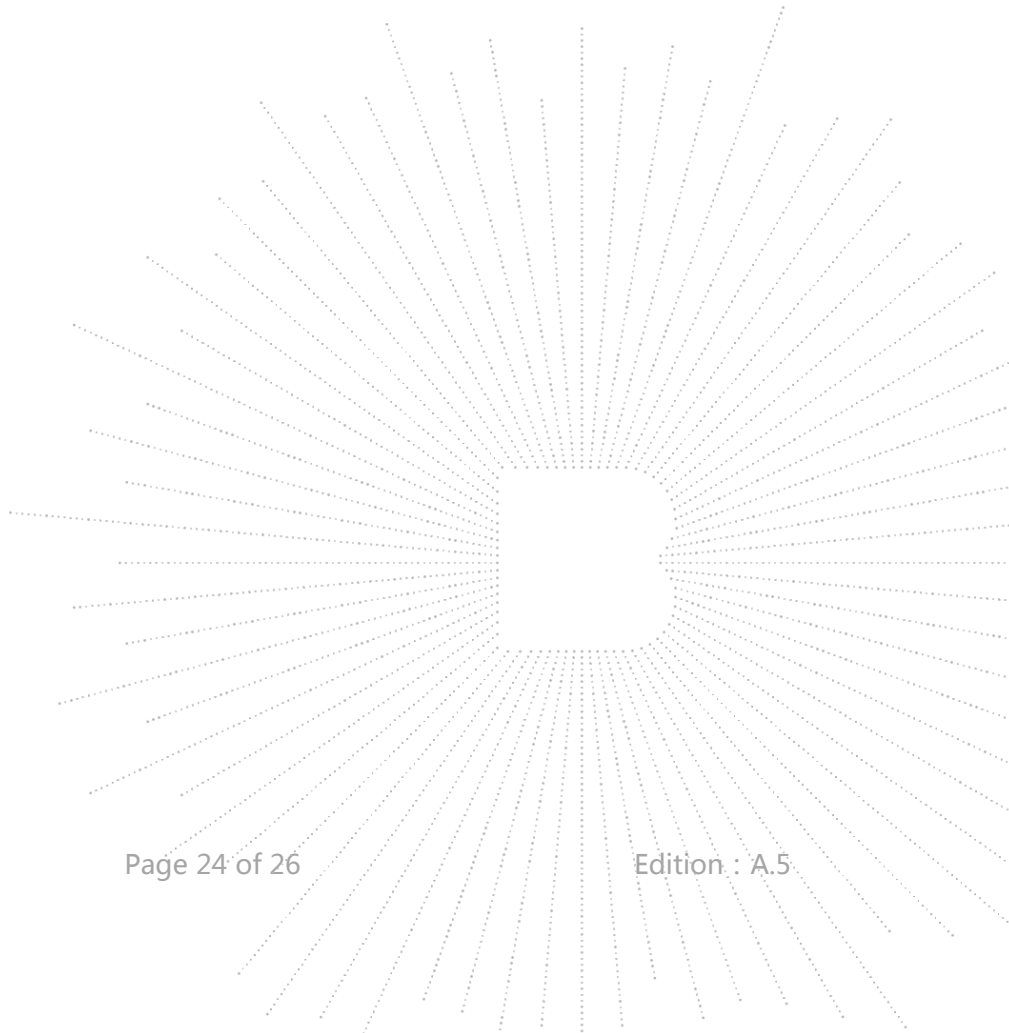
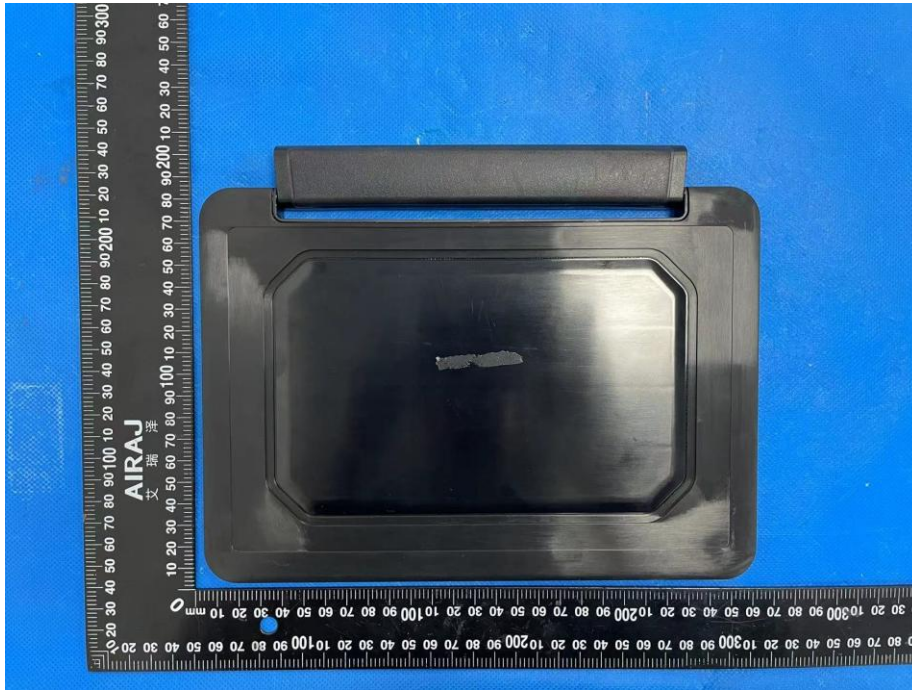

9. EUT TEST SETUP Photographs

Conducted emissions



Radiated emission

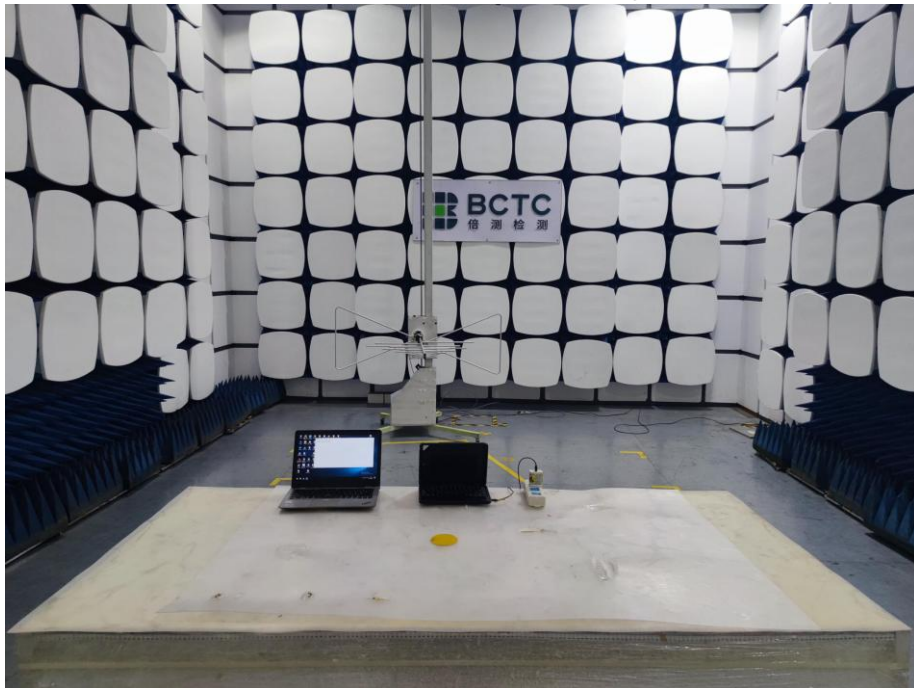

STATEMENT

1. The equipment lists are traceable to the national reference standards.
2. The test report can not be partially copied unless prior written approval is issued from our lab.
3. The test report is invalid without the "special seal for inspection and testing".
4. The test report is invalid without the signature of the approver.
5. The test process and test result is only related to the Unit Under Test.
6. Sample information is provided by the client and the laboratory is not responsible for its authenticity.
7. The test report without CMA mark is only used for scientific research, teaching, enterprise product development and internal quality control purposes.
8. The quality system of our laboratory is in accordance with ISO/IEC17025.
9. If there is any objection to this test report, the client should inform issuing laboratory within 15 days from the date of receiving test report.

Address:

1-2/F., Building B, Pengzhou Industrial Park, No.158, Fuyuan 1st Road, Zhancheng, Fuhai Subdistrict, Bao'an District, Shenzhen, Guangdong, China

TEL : 400-788-9558

P.C.: 518103

FAX : 0755-33229357

Website : <http://www.chnbctc.com>

E-Mail : bctc@bctc-lab.com.cn

***** END *****