

TEST REPORT

Report No.: BCTC2105219408E

Applicant: ZAGG Inc.

Product Name: Bluetooth Keyboard

Model/Type Ref.: ZKB102RBB41

Tested Date: 2021-05-19 to 2021-05-26

Issued Date: 2021-05-26



Shenzhen BCTC Testing Co., Ltd.



FCC ID: QTG-ZKPRB

Product Name: Bluetooth Keyboard
Trademark: ZAGG
Model/Type Ref.: ZKB102RBB41
ZKB109RBB41
Prepared For: ZAGG Inc.
Address: 910 West Legacy Center Way, Midvale Utah 84047, United States
Manufacturer: ZAGG Inc.
Address: 910 West Legacy Center Way, Midvale Utah 84047, United States
Prepared By: Shenzhen BCTC Testing Co., Ltd.
Address: 1-2/F., Building B, Pengzhou Industrial Park, No.158, Fuyuan 1st Road, Tangwei, Fuhai Subdistrict, Bao'an District, Shenzhen, Guangdong, China
Sample Received Date: 2021-05-19
Sample tested Date: 2021-05-19 to 2021-05-26
Issue Date: 2021-05-26
Report No.: BCTC2105219408E
Test Standards: FCC Part15.247
ANSI C63.10-2013
Test Results: PASS
Remark: This is Bluetooth BLE radio test report.

Tested by:

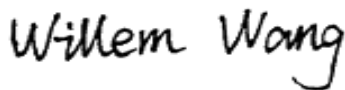

Willem Wang/Project Handler

Approved by:



Zero Zhou/Reviewer

The test report is effective only with both signature and specialized stamp. This result(s) shown in this report refer only to the sample(s) tested. Without written approval of Shenzhen BCTC Testing Co., Ltd, this report can't be reproduced except in full. The tested sample(s) and the sample information are provided by the client.

TABLE OF CONTENT

Test Report Declaration	Page
1. VERSION	4
2. TEST SUMMARY	5
3. MEASUREMENT UNCERTAINTY	7
4. PRODUCT INFORMATION AND TEST SETUP	8
4.1 Product Information	8
4.2 Test Setup Configuration	9
4.3 Support Equipment	9
4.4 Channel List	10
4.5 Test Mode	10
4.6 Copy of marking plate	10
5. TEST FACILITY AND TEST INSTRUMENT USED	11
5.1 Test Facility	11
5.2 Test Instrument Used	11
6. CONDUCTED EMISSIONS	12
6.1 Block Diagram Of Test Setup	12
6.2 Limit	12
6.3 Test procedure	12
6.4 EUT operating Conditions	12
6.5 Test Result	13
7. RADIATED EMISSIONS	17
7.1 Block Diagram Of Test Setup	17
7.2 Limit	18
7.3 Test procedure	19
7.4 EUT operating Conditions	21
7.5 Test Result	22
8. EUT PHOTOGRAPHS	27
9. EUT TEST SETUP PHOTOGRAPHS	29

(Note: N/A means not applicable)

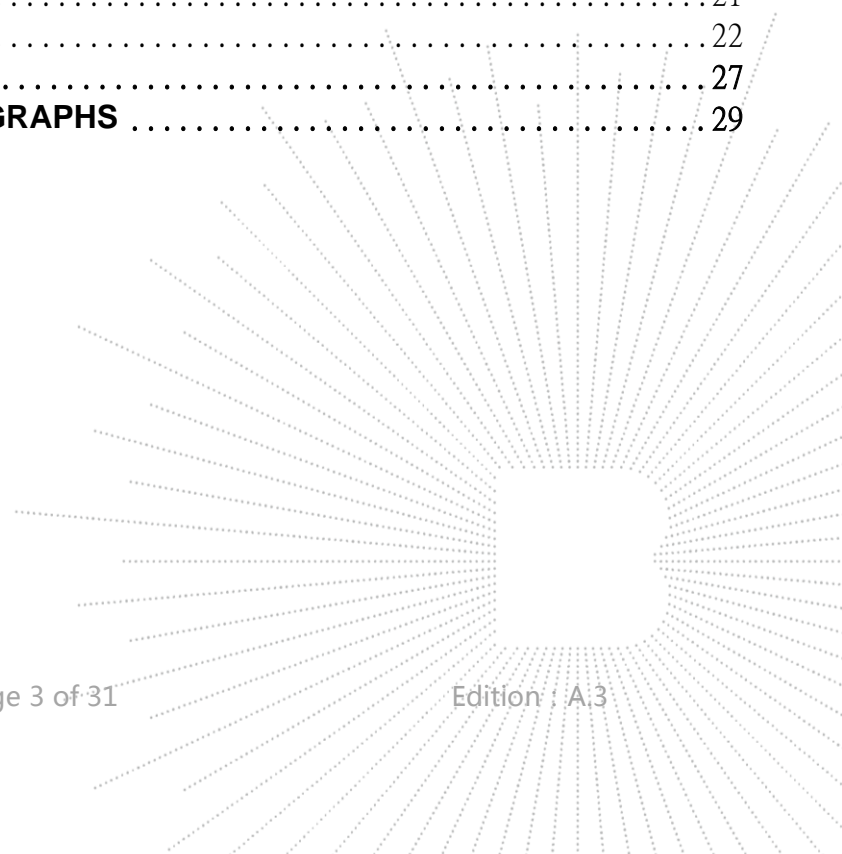

1. VERSION

Report No.	Issue Date	Description	Approved
BCTC2105219408E	2021-05-26	Original	Valid

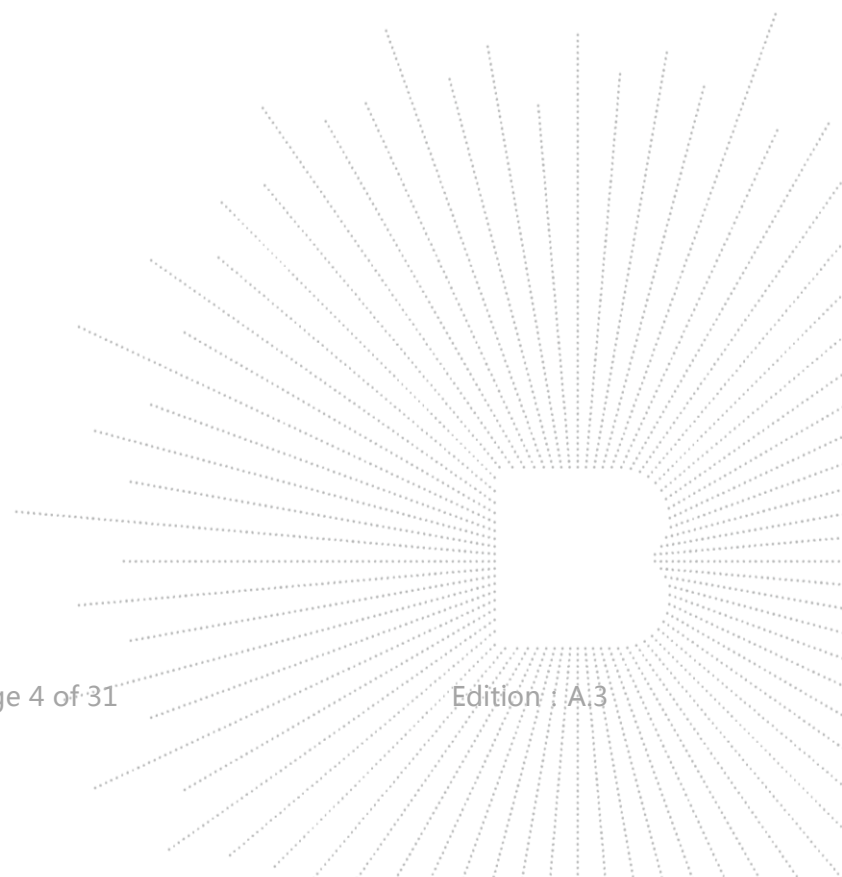

2. TEST SUMMARY

The Product has been tested according to the following specifications:

No.	Test Parameter	Clause No	Results
1	Conducted emissions	15.207	PASS
2	Radiated Emissions	15.209	PASS

Remark: Based on the following changes in the product, the RF chip remains unchanged. So the report is only updated Conducted emissions and Radiated Emissions for the original report (BCTC2004001065E) .

Changes : 1. The new product charging IC adds battery temperature monitoring function.

Original:

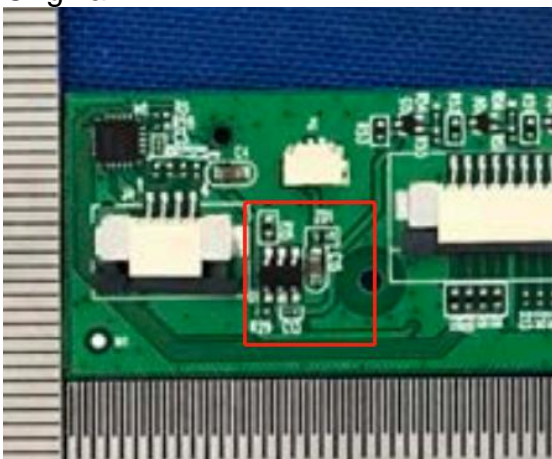

new

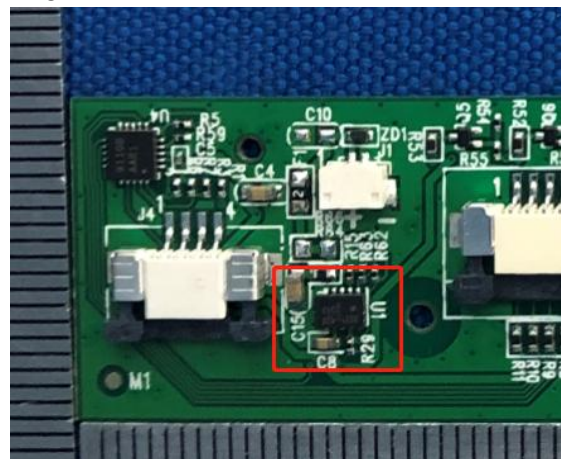

2. The new product delete AW IC (The AW IC only controls the brightness of the indicator LED)

Original:

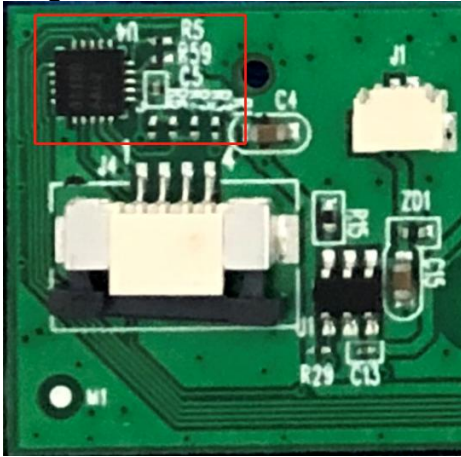

new

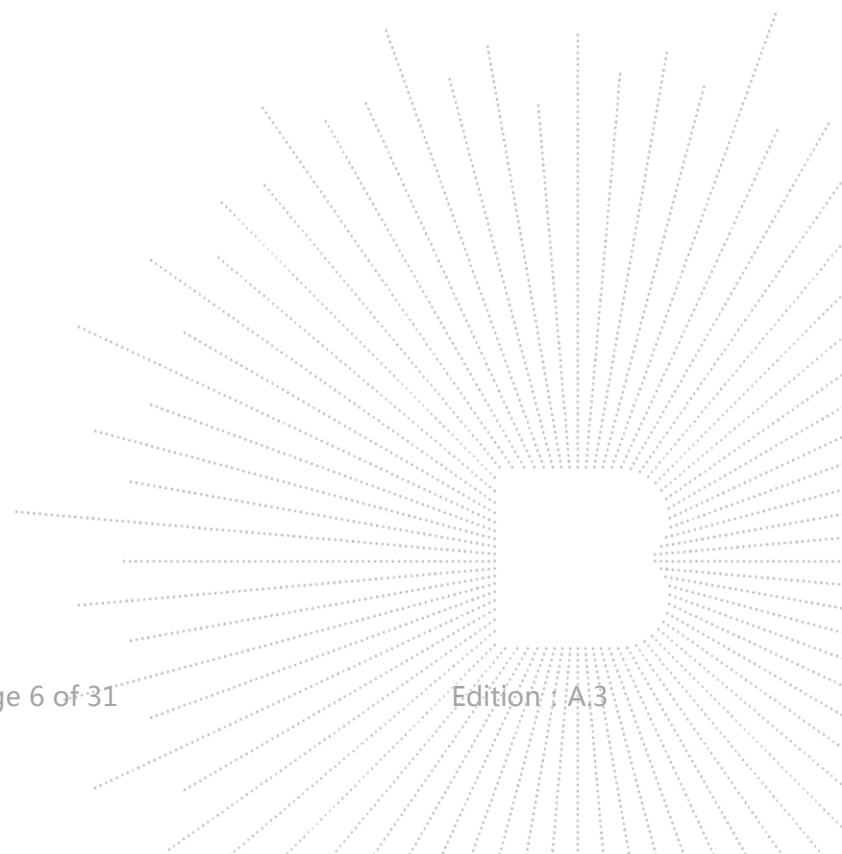
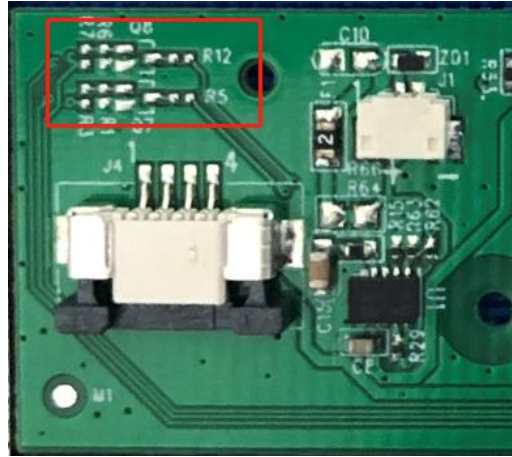

3. MEASUREMENT UNCERTAINTY

Where relevant, the following measurement uncertainty levels have been estimated for tests performed on the Product as specified in CISPR 16-4-2. This uncertainty represents an expanded uncertainty expressed at approximately the 95% confidence level using a coverage factor of $k=2$.

No.	Item	Uncertainty
1	humidity uncertainty	U=5.3%
2	Temperature uncertainty	U=0.59°C
3	Conducted Emission (150kHz-30MHz)	U=3.2dB
4	Radiated disturbance(30MHz-1000MHz)	U=4.8dB
5	Radiated disturbance(1GHz-6GHz)	U=4.9dB
6	Radiated disturbance(1GHz-18GHz)	U=5.0dB

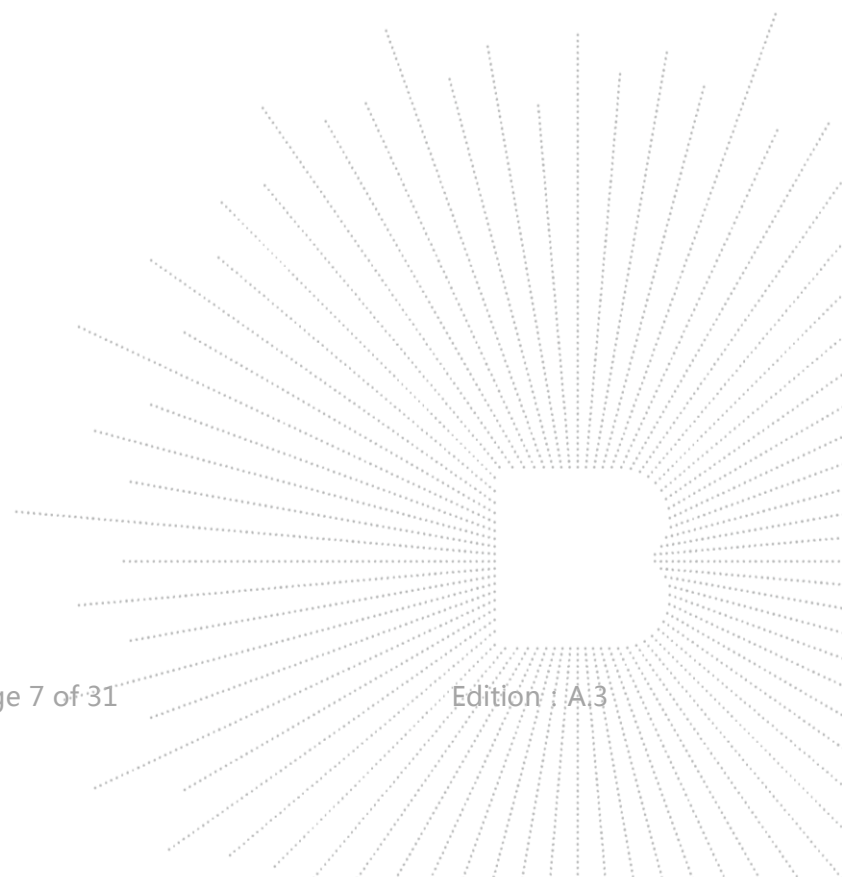

4. PRODUCT INFORMATION AND TEST SETUP

4.1 Product Information

Model/Type Ref.:	ZKB102RBB41 ZKB109RBB41
Model differences:	All the model are the same circuit and RF module, except model names and appearance. See the Note 1.
Bluetooth Version:	BT 5.0
Hardware Version:	V1.0
Software Version:	V1.0
Operation Frequency:	Bluetooth: 2402-2480MHz
Type of Modulation:	Bluetooth: GFSK
Antenna installation:	Bluetooth: PCB antenna
Antenna Gain:	Bluetooth:1.87dBi
Ratings:	DC 3.7V from Battery DC 5V from Adapter

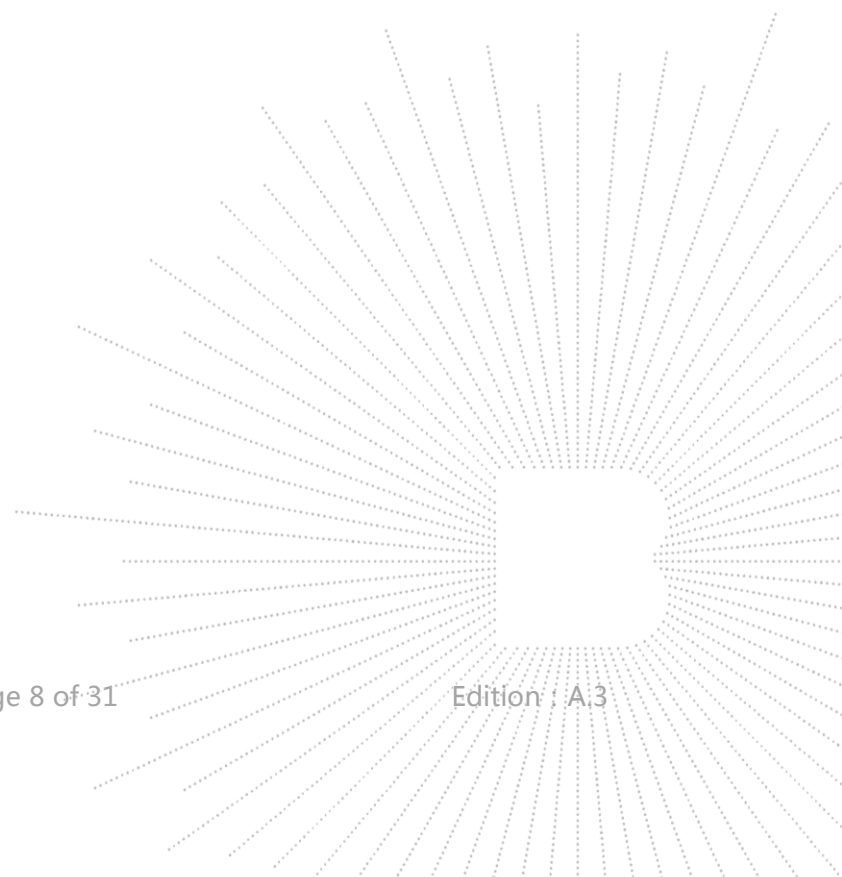

Note 1:

Model: ZKB102RBB41



Model: ZKB109RBB41



4.2 Test Setup Configuration

See test photographs attached in *EUT TEST SETUP PHOTOGRAPHS* for the actual connections between Product and support equipment.

Conducted Emission:

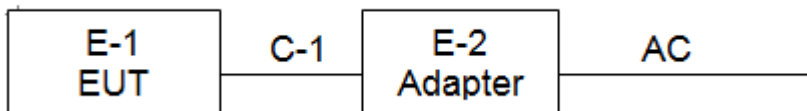

Radiated Spurious Emission

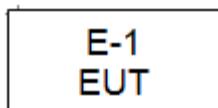

4.3 Support Equipment

No.	Device Type	Brand	Model	Series No.	Data Cable	Power Cord
E-1	Bluetooth Keyboard	ZAGG	ZKB102RBB41	N/A	EUT	E-1
E-2	Adapter	N/A	BCTC001	N/A	Auxiliary	E-2

Item	Shielded Type	Ferrite Core	Length	Note
C-1	NO	NO	0.4M	DC cable unshielded

Notes:

1. All the equipment/cables were placed in the worst-case configuration to maximize the emission during the test.
2. Grounding was established in accordance with the manufacturer's requirements and conditions for the intended use.

4.4 Channel List

Channel List					
Channel	Frequency (MHz)	Channel	Frequency (MHz)	Channel	Frequency (MHz)
01	2402	11	2422	21	2442
02	2404	12	2424	22	2444
03	2406	13	2426	23	2446
~	~	~	~	~	~
09	2418	19	2438	39	2478
10	2420	20	2440	40	2480

4.5 Test Mode

Test mode	Test mode	Low channel	Middle channel	High channel
1	Link mode(conducted emission and Radiated emission)			

4.6 Copy of marking plate

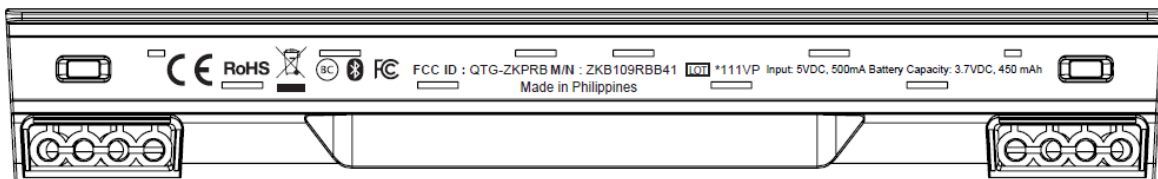
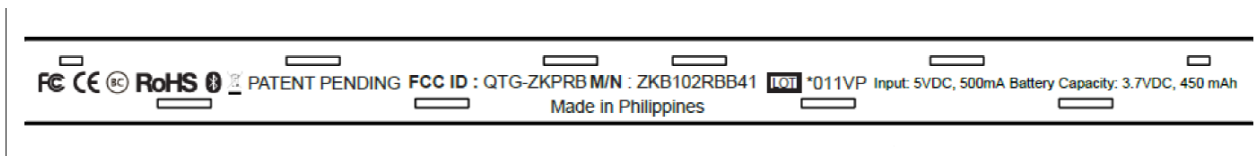

5. TEST FACILITY AND TEST INSTRUMENT USED

5.1 Test Facility

All measurement facilities used to collect the measurement data are located at Shenzhen BCTC Testing Co., Ltd. Address: 1-2/F., Building B, Pengzhou Industrial Park, No.158, Fuyuan 1st Road, Tangwei, Fuhai Subdistrict, Bao'an District, Shenzhen, Guangdong, China. The site and apparatus are constructed in conformance with the requirements of ANSI C63.4 and CISPR 16-1-1 other equivalent standards.

5.2 Test Instrument Used

Conducted emissions Test					
Equipment	Manufacturer	Model#	Serial#	Last Cal.	Next Cal.
Receiver	R&S	ESR3	102075	Jun. 08, 2020	Jun. 07, 2021
LISN	R&S	ENV216	101375	Jun. 04, 2020	Jun. 03, 2021
ISN	HPX	ISN T800	S1509001	Jun. 04, 2020	Jun. 03, 2021
Software	Frad	EZ-EMC	EMC-CON 3A1	\	\

Radiated emissions Test (966 chamber)					
Equipment	Manufacturer	Model#	Serial#	Last Cal.	Next Cal.
966 chamber	ChengYu	966 Room	966	Jun. 06. 2020	Jun. 05, 2023
Receiver	R&S	ESR3	102075	Jun. 08, 2020	Jun. 07, 2021
Receiver	R&S	ESRP	101154	Jun. 08, 2020	Jun. 07, 2021
Amplifier	Schwarzbeck	BBV9718	9718-309	Jun. 04, 2020	Jun. 03, 2021
Amplifier	Schwarzbeck	BBV9744	9744-0037	Jun. 04, 2020	Jun. 03, 2021
TRILOG Broadband Antenna	schwarzbeck	VULB 9163	VULB9163-942	Jun. 08, 2020	Jun. 07, 2021
Horn Antenna	SCHWARZBECK	BBHA9120 D	1201	Jun. 10, 2020	Jun. 09, 2021
Software	Frad	EZ-EMC	FA-03A2 RE	\	\

6. CONDUCTED EMISSIONS

6.1 Block Diagram Of Test Setup

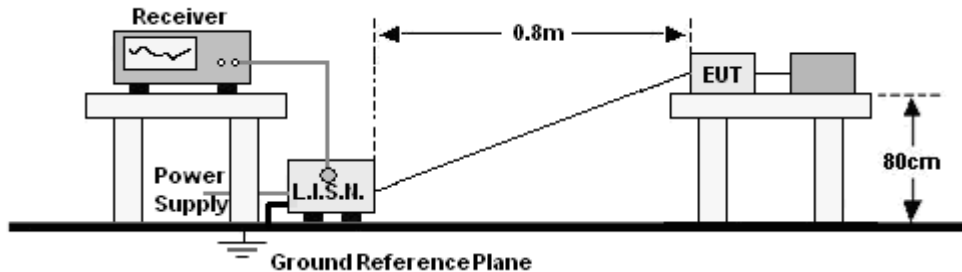

6.2 Limit

FREQUENCY (MHz)	Limit (dBuV)	
	Quas-peak	Average
0.15 -0.5	66 - 56 *	56 - 46 *
0.50 -5.0	56.00	46.00
5.0 -30.0	60.00	50.00

Notes:
 1. *Decreasing linearly with logarithm of frequency.
 2. The lower limit shall apply at the transition frequencies.

6.3 Test procedure

Receiver Parameters	Setting
Attenuation	10 dB
Start Frequency	0.15 MHz
Stop Frequency	30 MHz
IF Bandwidth	9 kHz

a. The Product was placed on a nonconductive table 0.8 m above the horizontal ground reference plane, and 0.4 m from the vertical ground reference plane, and connected to the main through Line Impedance Stability Network (L.I.S.N).

b. The RBW of the receiver was set at 9 kHz in 150 kHz ~ 30MHz with Peak and AVG detector in Max Hold mode. Run the receiver's pre-scan to record the maximum disturbance generated from Product in all power lines in the full band.

c. For each frequency whose maximum record was higher or close to limit, measure its QP and AVG values and record.

6.4 EUT operating Conditions

The EUT was configured for testing in a typical fashion (as a customer would normally use it). The EUT has been programmed to continuously transmit during test. This operating condition was tested and used to collect the included data.

6.5 Test Result

Temperature :	26 °C	Relative Humidity :	54%
Pressure :	101kPa	Phase :	L
Test Voltage :	AC 120V/60Hz	Test Mode :	Mode 1
Test Model	ZKB102RBB41		

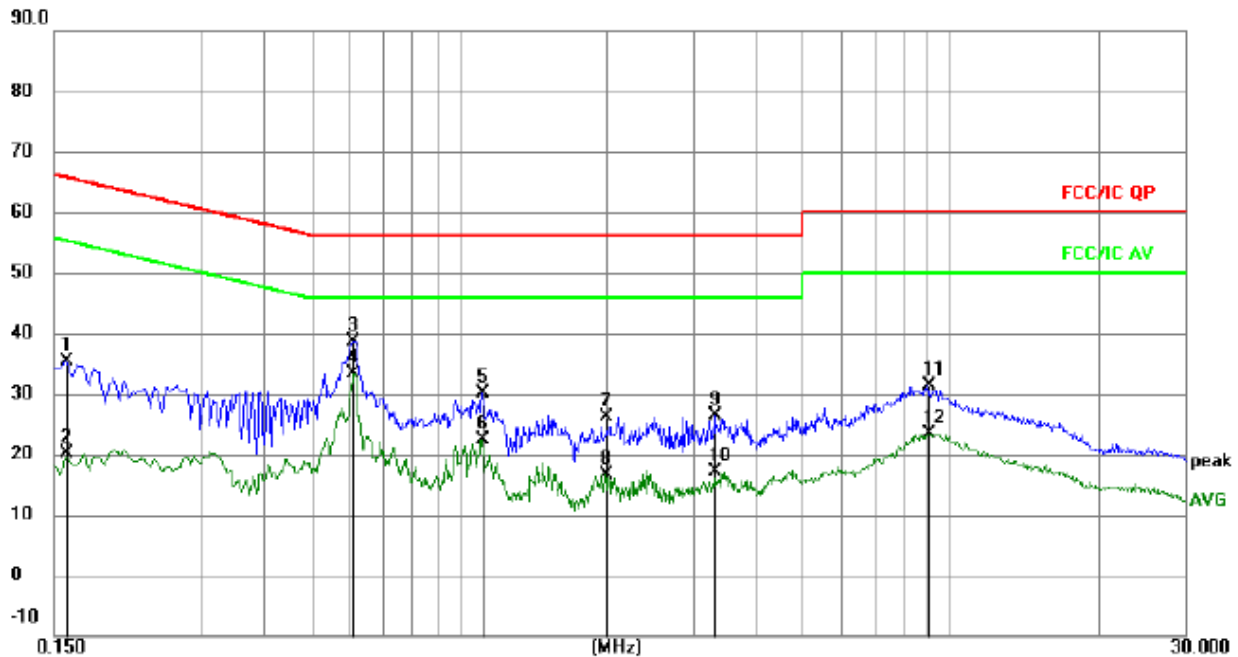

Remark:

1. All readings are Quasi-Peak and Average values.
2. Factor = Insertion Loss + Cable Loss.

No.	Mk.	Freq. MHz	Reading Level	Correct Factor dB	Measure- ment dBuV	Limit dBuV	Over dB	Detector
1		0.1590	25.92	9.51	35.43	65.52	-30.09	QP
2		0.1590	10.57	9.51	20.08	55.52	-35.44	AVG
3		0.6090	28.73	9.97	38.70	56.00	-17.30	QP
4	*	0.6090	23.36	9.97	33.33	46.00	-12.67	AVG
5		1.1130	20.55	9.57	30.12	56.00	-25.88	QP
6		1.1130	12.85	9.57	22.42	46.00	-23.58	AVG
7		1.9860	16.48	9.59	26.07	56.00	-29.93	QP
8		1.9860	7.15	9.59	16.74	46.00	-29.26	AVG
9		3.3225	16.67	9.68	26.35	56.00	-29.65	QP
10		3.3225	7.42	9.68	17.10	46.00	-28.90	AVG
11		9.0510	21.59	9.70	31.29	60.00	-28.71	QP
12		9.0510	13.76	9.70	23.46	50.00	-26.54	AVG

Temperature :	26 °C	Relative Humidity :	54%
Pressure :	101kPa	Phase :	N
Test Voltage :	AC 120V/60Hz	Test Mode :	Mode 1
Test Model	ZKB102RBB41		

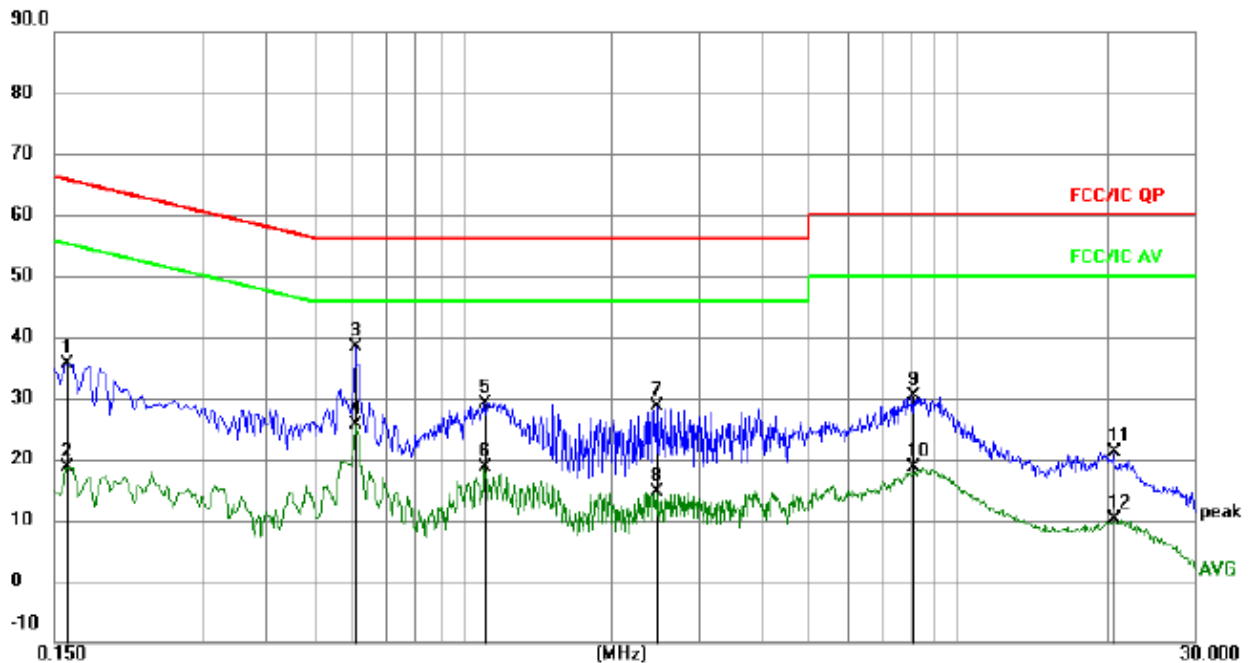

Remark:

1. All readings are Quasi-Peak and Average values.
2. Factor = Insertion Loss + Cable Loss.

No.	Mk.	Freq. MHz	Reading Level	Correct Factor dB	Measure- ment dBuV	Limit dBuV	Over dB	Detector
1		0.1582	26.16	9.51	35.67	65.56	-29.89	QP
2		0.1582	9.15	9.51	18.66	55.56	-36.90	AVG
3	*	0.6075	28.43	9.97	38.40	56.00	-17.60	QP
4		0.6075	15.66	9.97	25.63	46.00	-20.37	AVG
5		1.1056	19.63	9.57	29.20	56.00	-26.80	QP
6		1.1056	9.15	9.57	18.72	46.00	-27.28	AVG
7		2.4736	19.05	9.62	28.67	56.00	-27.33	QP
8		2.4736	4.99	9.62	14.61	46.00	-31.39	AVG
9		8.1053	20.73	9.71	30.44	60.00	-29.56	QP
10		8.1053	8.86	9.71	18.57	50.00	-31.43	AVG
11		20.5944	11.33	9.78	21.11	60.00	-38.89	QP
12		20.5944	0.34	9.78	10.12	50.00	-39.88	AVG

Temperature :	26 °C	Relative Humidity :	54%
Pressure :	101kPa	Phase :	L
Test Voltage :	AC 120V/60Hz	Test Mode :	Mode 1
Test Model	ZKB109RBB41		

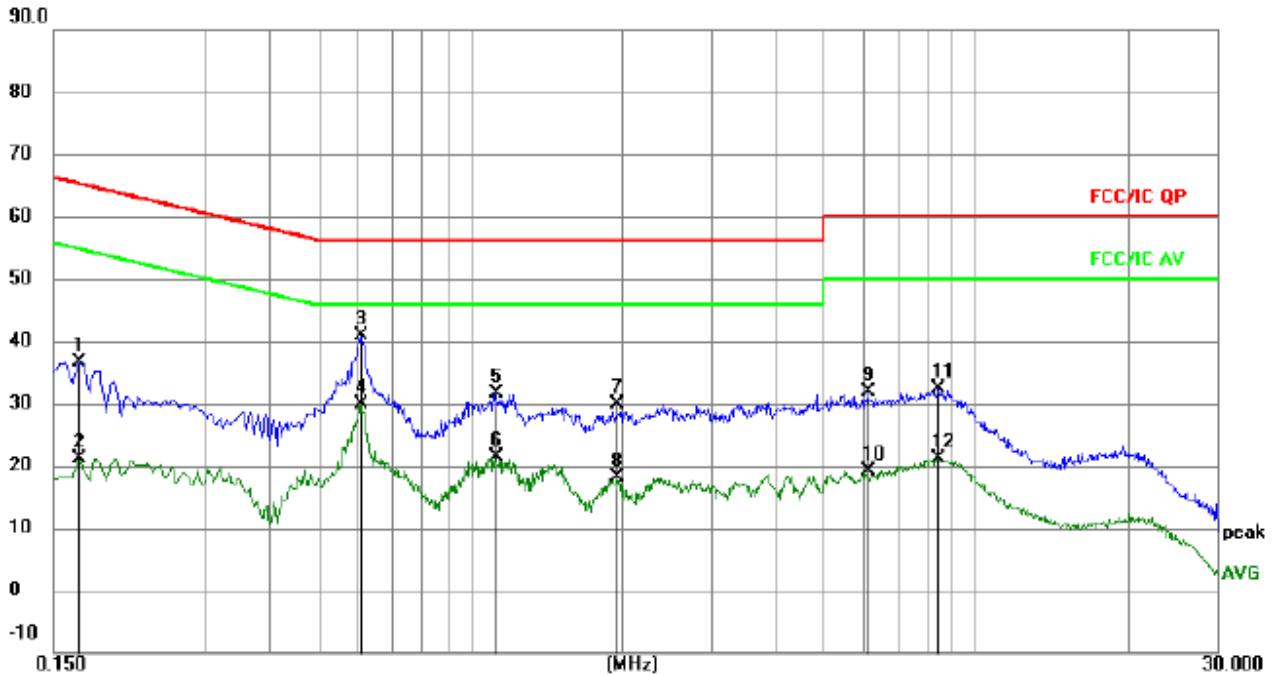

Remark:

1. All readings are Quasi-Peak and Average values.
2. Factor = Insertion Loss + Cable Loss.

No.	Mk.	Freq. MHz	Reading Level	Correct Factor dB	Measure- ment dBuV	Limit dBuV	Over dB	Detector
1		0.1680	27.07	9.50	36.57	65.06	-28.49	QP
2		0.1680	11.71	9.50	21.21	55.06	-33.85	AVG
3	*	0.6090	30.85	9.97	40.82	56.00	-15.18	QP
4		0.6090	19.84	9.97	29.81	46.00	-16.19	AVG
5		1.1174	22.07	9.57	31.64	56.00	-24.36	QP
6		1.1174	11.91	9.57	21.48	46.00	-24.52	AVG
7		1.9590	20.20	9.59	29.79	56.00	-26.21	QP
8		1.9590	8.42	9.59	18.01	46.00	-27.99	AVG
9		6.1485	22.08	9.75	31.83	60.00	-28.17	QP
10		6.1485	9.34	9.75	19.09	50.00	-30.91	AVG
11		8.4075	22.64	9.71	32.35	60.00	-27.65	QP
12		8.4075	11.49	9.71	21.20	50.00	-28.80	AVG

Temperature :	26 °C	Relative Humidity :	54%
Pressure :	101kPa	Phase :	N
Test Voltage :	AC 120V/60Hz	Test Mode :	Mode 1
Test Model	ZKB109RBB41		

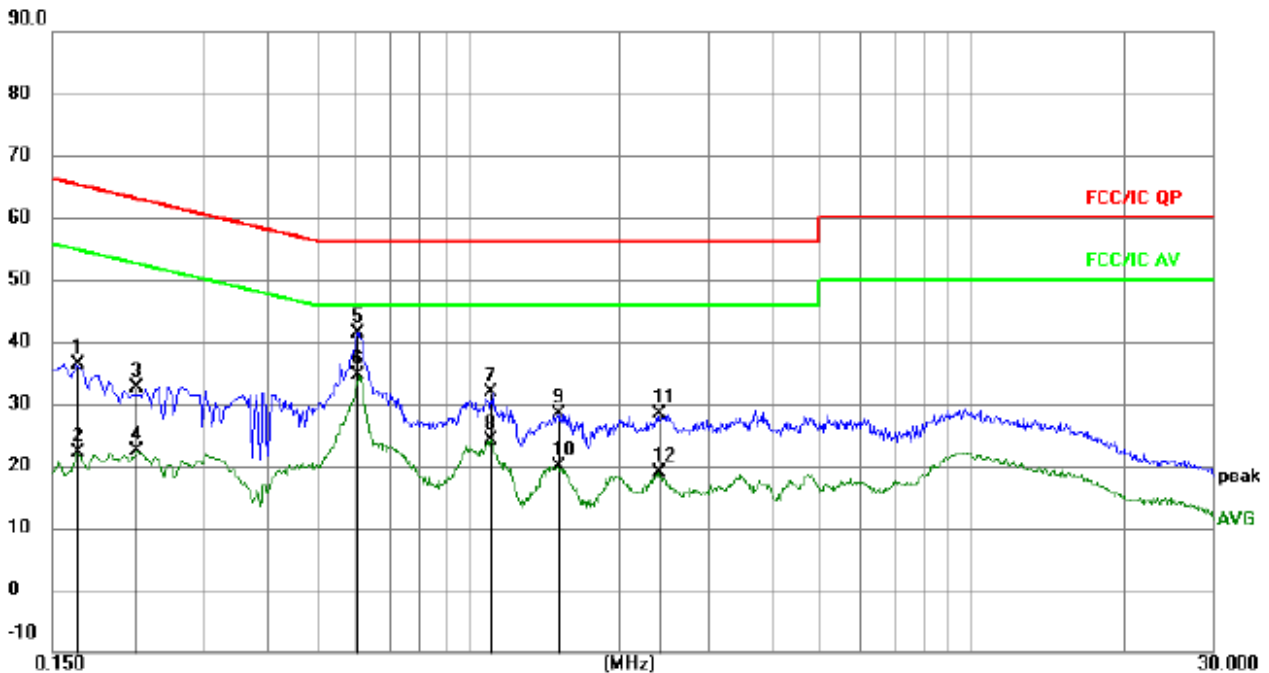

Remark:

1. All readings are Quasi-Peak and Average values.
2. Factor = Insertion Loss + Cable Loss.

No.	Mk.	Freq. MHz	Reading Level	Correct Factor dB	Measure- ment dBuV	Limit dBuV	Over dB	Detector
1		0.1677	26.77	9.50	36.27	65.07	-28.80	QP
2		0.1677	12.67	9.50	22.17	55.07	-32.90	AVG
3		0.2208	23.25	9.48	32.73	62.79	-30.06	QP
4		0.2208	12.82	9.48	22.30	52.79	-30.49	AVG
5		0.6043	31.48	9.98	41.46	56.00	-14.54	QP
6	*	0.6043	24.58	9.98	34.56	46.00	-11.44	AVG
7		1.1114	22.30	9.57	31.87	56.00	-24.13	QP
8		1.1114	14.52	9.57	24.09	46.00	-21.91	AVG
9		1.5033	18.91	9.58	28.49	56.00	-27.51	QP
10		1.5033	10.31	9.58	19.89	46.00	-26.11	AVG
11		2.3836	18.74	9.62	28.36	56.00	-27.64	QP
12		2.3836	9.36	9.62	18.98	46.00	-27.02	AVG

7. RADIATED EMISSIONS

7.1 Block Diagram Of Test Setup

(A) Radiated Emission Test-Up Frequency Below 30MHz

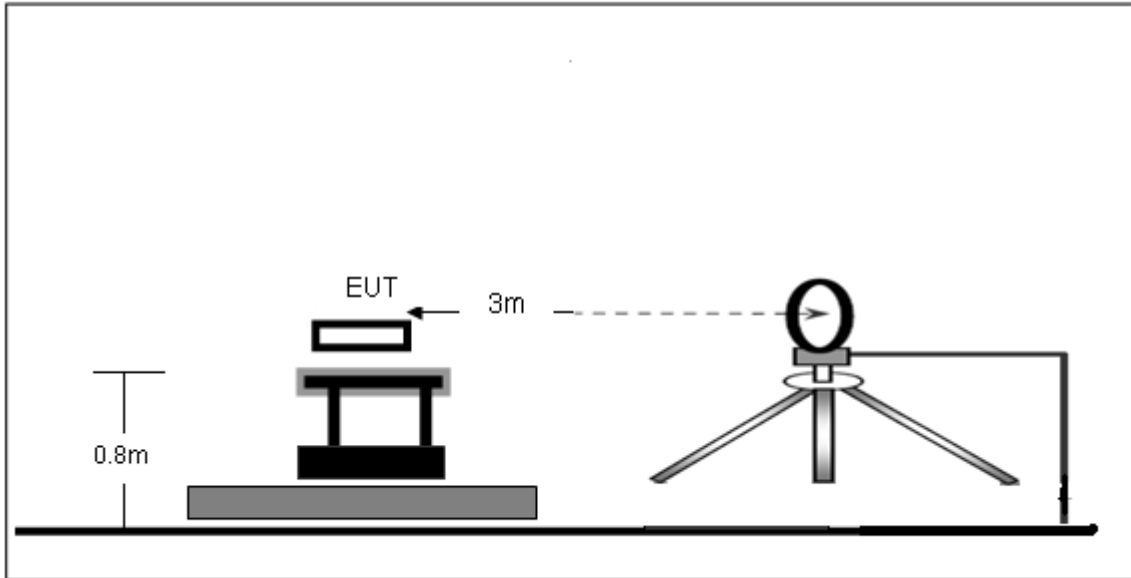

(B) Radiated Emission Test-Up Frequency 30MHz~1GHz

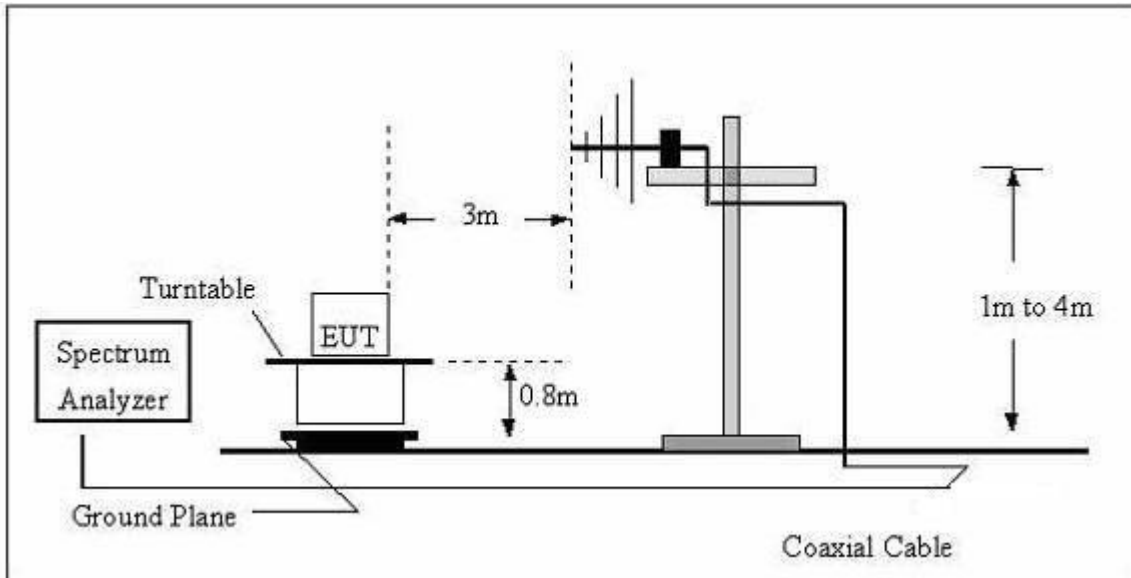

(C) Radiated Emission Test-Up Frequency Above 1GHz

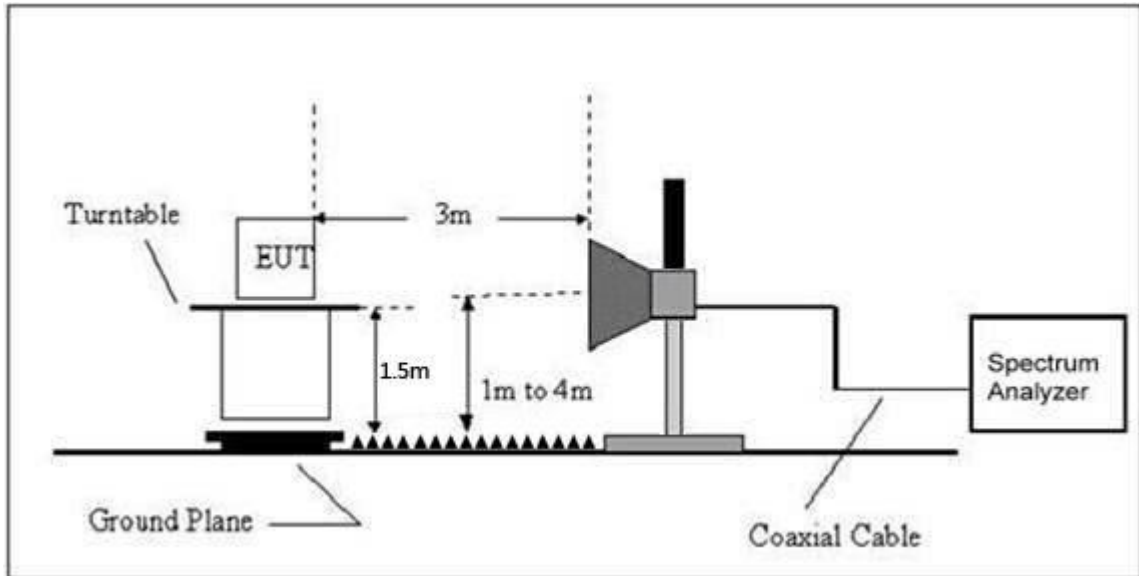

7.2 Limit

20dBc in any 100 kHz bandwidth outside the operating frequency band. In case the emission fall within the restricted band specified on 15.205(a), then the 15.209(a) limit in the table below has to be followed.

Frequency (MHz)	Field Strength uV/m	Distance (m)	Field Strength Limit at 3m Distance	
			uV/m	dBuV/m
0.009 ~ 0.490	2400/F(kHz)	300	$10000 * 2400/F(\text{kHz})$	$20\log^{(2400/F(\text{kHz}))} + 80$
0.490 ~ 1.705	24000/F(kHz)	30	$100 * 24000/F(\text{kHz})$	$20\log^{(24000/F(\text{kHz}))} + 40$
1.705 ~ 30	30	30	$100 * 30$	$20\log^{(30)} + 40$
30 ~ 88	100	3	100	$20\log^{(100)}$
88 ~ 216	150	3	150	$20\log^{(150)}$
216 ~ 960	200	3	200	$20\log^{(200)}$
Above 960	500	3	500	$20\log^{(500)}$

LIMITS OF RADIATED EMISSION MEASUREMENT (Above 1000MHz)

FREQUENCY Y (MHz)	Limit (dBuV/m) (at 3M)	
	PEAK	AVERAGE
Above 1000	74	54

Notes:

- (1)The limit for radiated test was performed according to FCC PART 15C.
- (2)The tighter limit applies at the band edges.
- (3) Emission level (dBuV/m)=20log Emission level (uV/m).

FREQUENCY RANGE OF RADIATED MEASUREMENT (For unintentional radiators)

Highest frequency generated or Upper frequency of measurement used in the device or on which the device operates or tunes (MHz)	Range (MHz)
Below 1.705	30
1.705 – 108	1000
108 – 500	2000
500 – 1000	5000
Above 1000	5 th harmonic of the highest frequency or 40 GHz, whichever is lower

7.3 Test procedure

Receiver Parameter	Setting
Attenuation	Auto
9kHz~150kHz	RBW 200Hz for QP
150kHz~30MHz	RBW 9kHz for QP
30MHz~1000MHz	RBW 120kHz for QP

Spectrum Parameter	Setting
1-25GHz	RBW 1 MHz /VBW 1 MHz for Peak, RBW 1 MHz / VBW 10Hz for Average

Below 1GHz test procedure as below:

- a. The EUT was placed on the top of a rotating table 0.8 meters above the ground at a 3 meter semi-anechoic chamber. The table was rotated 360 degrees to determine the position of the highest radiation.
- b. The EUT was set 3 meters away from the interference-receiving antenna, which was mounted on the top of a variable-height antenna tower.
- c. The antenna height is varied from one meter to four meters above the ground to determine the maximum value of the field strength. Both horizontal and vertical polarizations of the antenna are set to make the measurement.
- d. For each suspected emission, the EUT was arranged to its worst case and then the antenna was tuned to heights from 1 meter to 4 meters (for the test frequency of below 30MHz, the antenna was tuned to heights 1 meter) and the rotatable table was turned from 0 degrees to 360 degrees to find the maximum reading.
- e. The test-receiver system was set to Peak Detect Function and Specified Bandwidth with Maximum Hold Mode.

f. If the emission level of the EUT in peak mode was 10dB lower than the limit specified, then testing could be stopped and the peak values of the EUT would be reported. Otherwise the emissions that did not have 10dB margin would be re-tested one by one using peak, quasi-peak or average method as specified and then reported in a data sheet.

Above 1GHz test procedure as below:

g. Different between above is the test site, change from Semi- Anechoic Chamber to fully Anechoic Chamber and change form table 0.8 metre to 1.5 metre(Above 18GHz the distance is 1 meter and table is 1.5 metre).

h. Test the EUT in the lowest channel, the middle channel, the Highest channel.

Note:

Both horizontal and vertical antenna polarities were tested and performed pretest to three orthogonal axis. The worst case emissions were reported.

Above 1GHz test procedure as below:

a.The EUT was placed on the top of a rotating table 1.5 meters above the ground at a 3 meter camber. The table was rotated 360 degrees to determine the position of the highest radiation.

b.The EUT was set 3 meters away from the interference-receiving antenna, which was mounted on the top of a variable-height antenna tower.

c.The antenna height is varied from one meter to four meters above the ground to determine the maximum value of the field strength. Both horizontal and vertical polarizations of the antenna are set to make the measurement.

d.For each suspected emission, the EUT was arranged to its worst case and then the antenna was tuned to heights from 1 meter to 4 meters and the rota table was turned from 0 degrees to 360 degrees to find the maximum reading.

e.The test-receiver system was set to Peak Detect Function and Specified Bandwidth with Maximum Hold Mode.

f. If the emission level of the EUT in peak mode was 10dB lower than the limit specified, then testing could be stopped and the peak values of the EUT would be reported. Otherwise the emissions that did not have 10dB margin would be re-tested one by one using peak, quasi-peak or average method as specified and then reported in a data sheet.

g.Test the EUT in the lowest channel, the Highest channel.

Note:

Both horizontal and vertical antenna polarities were tested and performed pretest to three orthogonal axis. The worst case emissions were reported.

7.4 EUT operating Conditions

The EUT was configured for testing in a typical fashion (as a customer would normally use it). The EUT has been programmed to continuously transmit during test. This operating condition was tested and used to collect the included data.

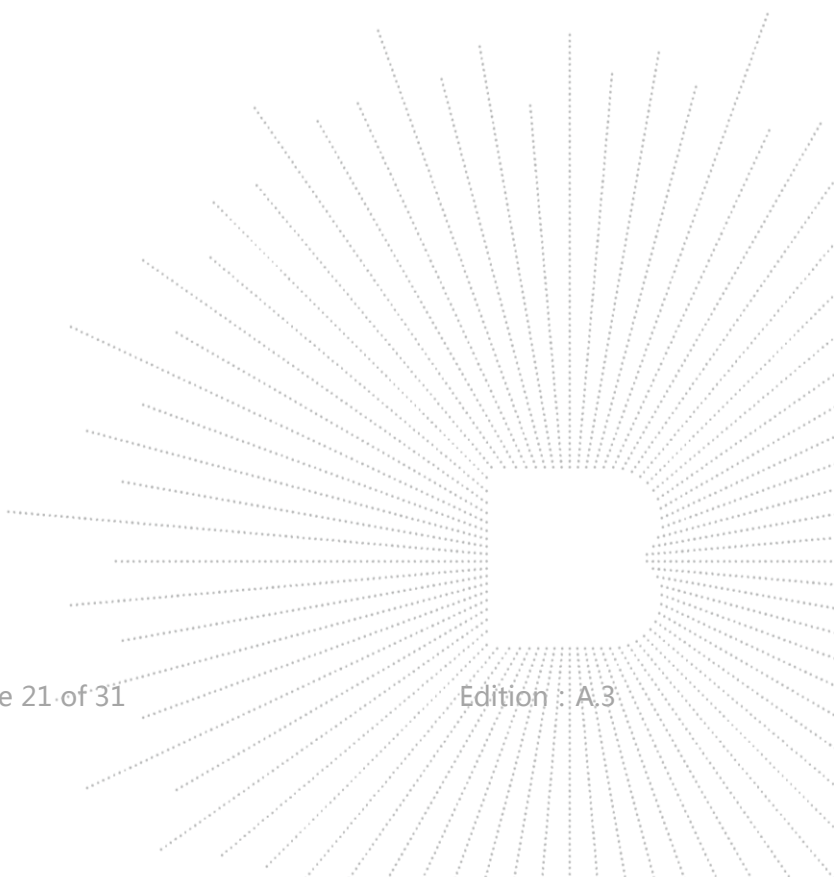

7.5 Test Result

Below 30MHz

Temperature:	26°C	Relative Humidity:	54%
Pressure:	101 kPa	Test Voltage :	DC 3.7V
Test Mode :	Mode 1	Polarization :	--

Freq.	Reading	Limit	Margin	State
(MHz)	(dBuV/m)	(dBuV/m)	(dB)	P/F
--	--	--	--	PASS
--	--	--	--	PASS

Note:

The amplitude of spurious emissions which are attenuated by more than 20dB below the permissible value has no need to be reported.

Distance extrapolation factor = $40 \log(\text{specific distance}/\text{test distance})$ (dB);

Limit line = specific limits(dBuv) + distance extrapolation factor.

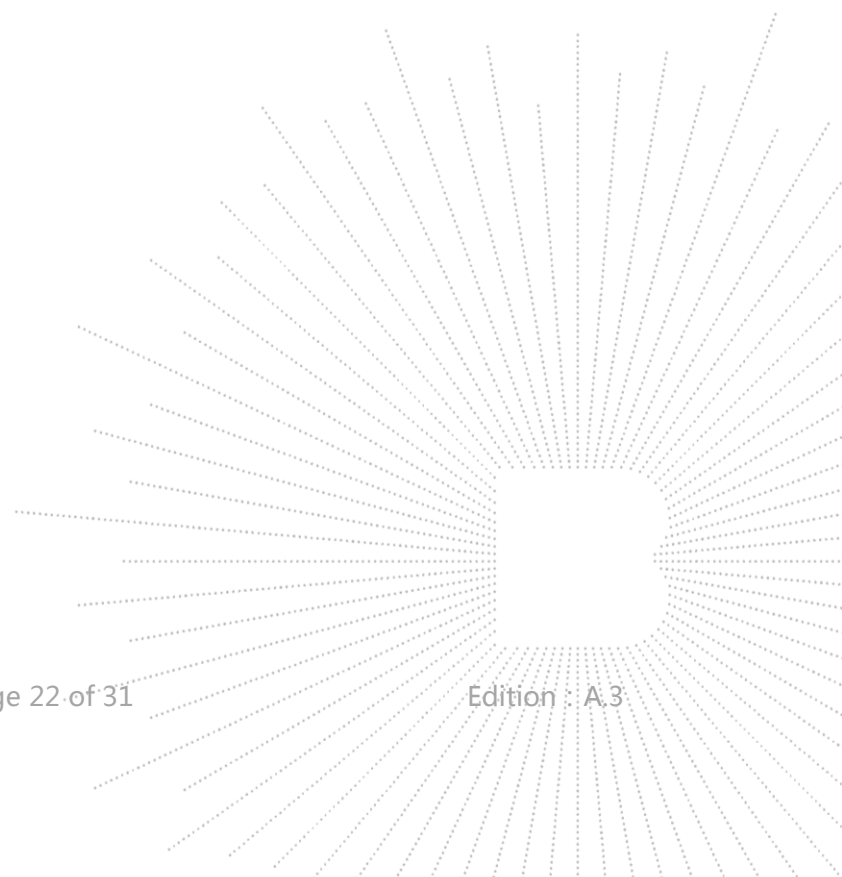

Between 30MHz – 1GHz

Temperature:	26°C	Relative Humidity:	54%
Pressure:	101 kPa	Test Voltage :	DC 3.7V
Test Mode :	Mode 1	Polarization :	Horizontal
Test Model :	ZKB102RBB41		

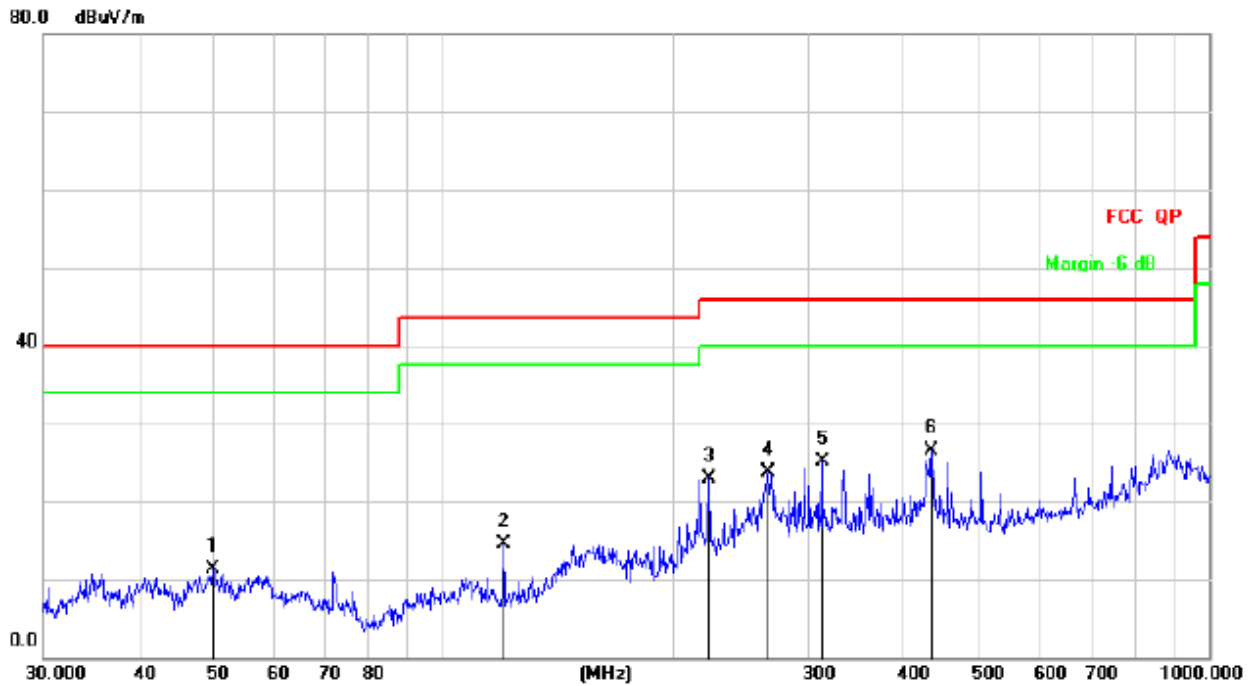

Remark:

Factor = Antenna Factor + Cable Loss – Pre-amplifier.

No.	Mk.	Freq.	Reading Level	Correct Factor	Measurement	Limit	Over	Detector
		MHz	dBuV	dB	dBuV/m	dB/m	dB	
1		50.0566	25.40	-14.08	11.32	40.00	-28.68	QP
2		119.8556	31.35	-16.76	14.59	43.50	-28.91	QP
3		222.1698	37.66	-14.80	22.86	46.00	-23.14	QP
4		265.6757	37.46	-13.66	23.80	46.00	-22.20	QP
5		312.1794	37.16	-12.08	25.08	46.00	-20.92	QP
6	*	434.0651	35.39	-8.96	26.43	46.00	-19.57	QP

Temperature:	26°C	Relative Humidity:	54%
Pressure:	101 hPa	Test Voltage :	DC 3.7V
Test Mode :	Mode 1	Polarization :	Vertical
Test Model :	ZKB102RBB41		

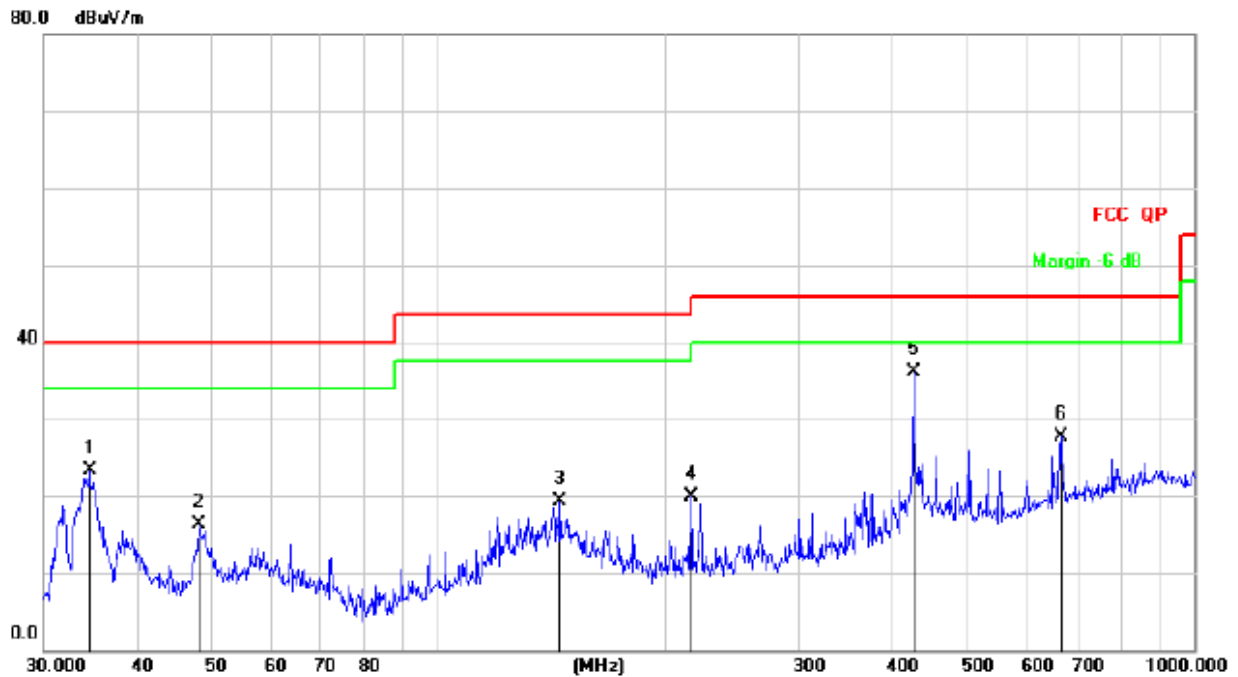

Remark:

Factor = Antenna Factor + Cable Loss – Pre-amplifier.

No.	Mk.	Freq. MHz	Reading Level dBuV	Correct Factor dB	Measure- ment dBuV/m	Limit dB/m	Over dB	Detector
1		34.5173	38.83	-15.58	23.25	40.00	-16.75	QP
2		48.1626	30.60	-14.24	16.36	40.00	-23.64	QP
3		144.8418	37.67	-18.38	19.29	43.50	-24.21	QP
4		216.0240	34.78	-14.93	19.85	46.00	-26.15	QP
5	*	425.0280	45.21	-9.15	36.06	46.00	-9.94	QP
6		668.1423	31.71	-4.07	27.64	46.00	-18.36	QP

Temperature:	26°C	Relative Humidity:	54%
Pressure:	101 kPa	Test Voltage :	DC 3.7V
Test Mode :	Mode 1	Polarization :	Horizontal
Test Model :	ZKB109RBB41		

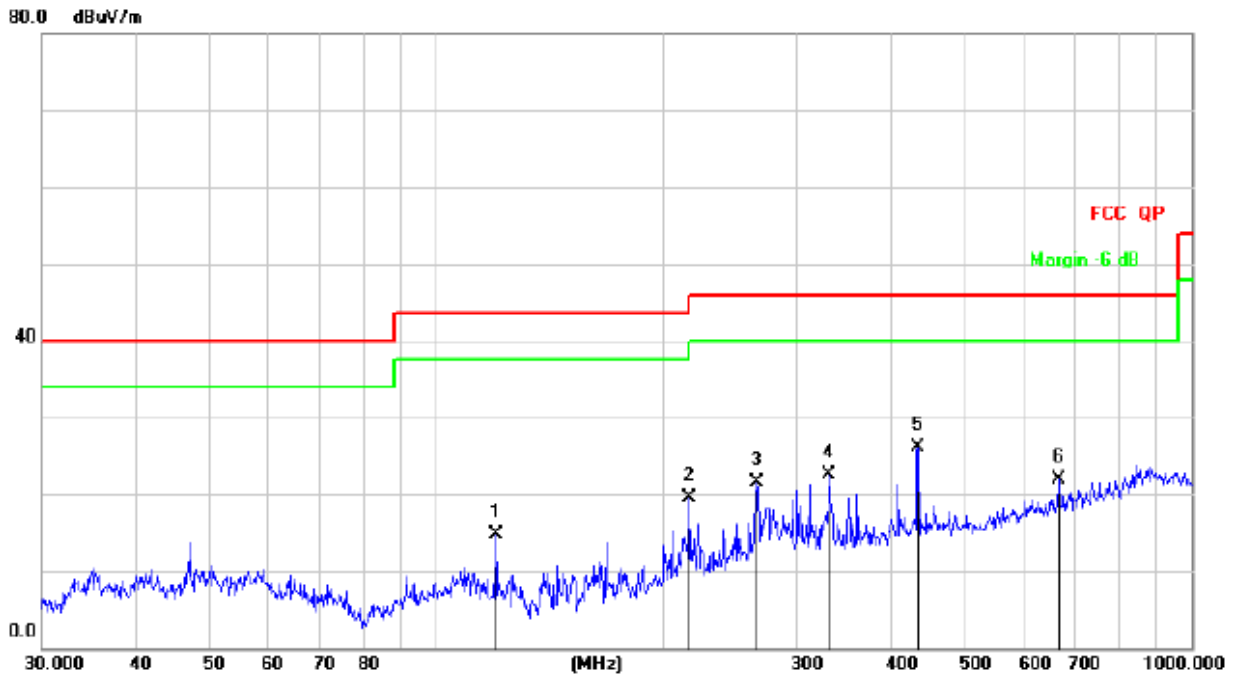

Remark:

Factor = Antenna Factor + Cable Loss – Pre-amplifier.

No.	Mk.	Freq. MHz	Reading Level dBuV	Correct Factor dB	Measure- ment dBuV/m	Limit dB/m	Over dB	Detector
1		119.8556	31.37	-16.76	14.61	43.50	-28.89	QP
2		216.0240	34.34	-14.93	19.41	46.00	-26.59	QP
3		265.6757	35.08	-13.66	21.42	46.00	-24.58	QP
4		331.3546	34.00	-11.57	22.43	46.00	-23.57	QP
5	*	434.0651	35.16	-8.96	26.20	46.00	-19.80	QP
6		668.1423	25.97	-4.07	21.90	46.00	-24.10	QP

Temperature:	26°C	Relative Humidity:	54%
Pressure:	101 hPa	Test Voltage :	DC 3.7V
Test Mode :	Mode 1	Polarization :	Vertical
Test Model :	ZKB109RBB41		

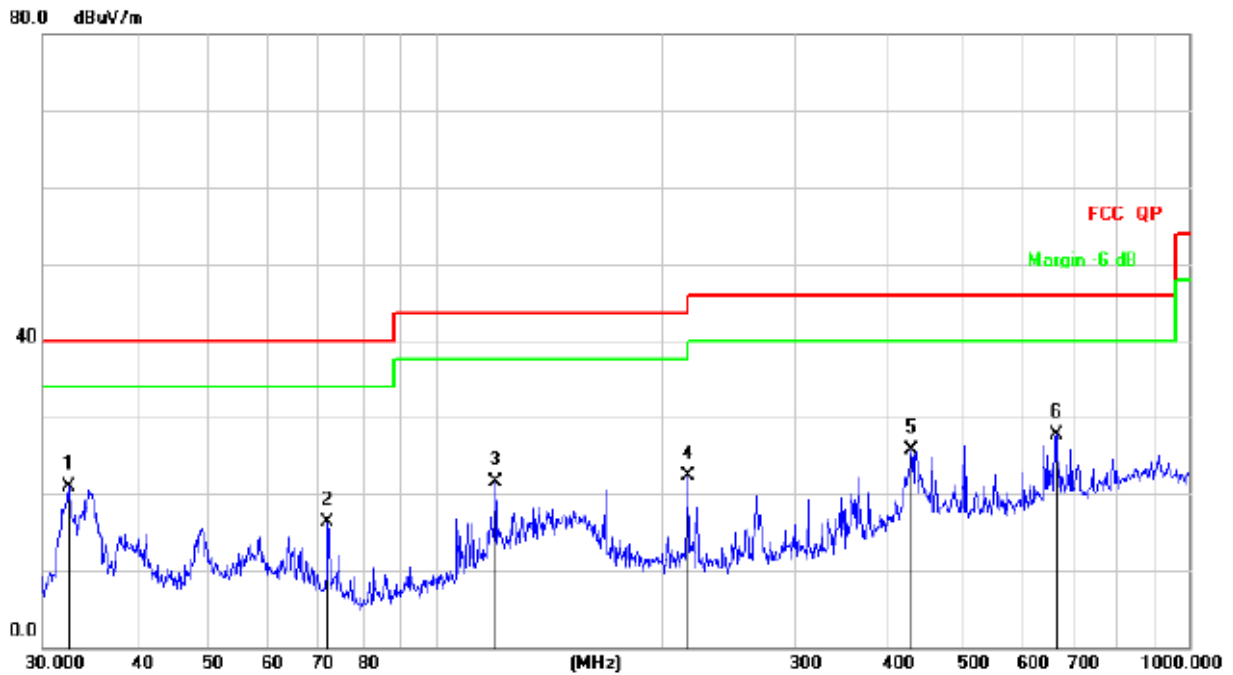

Remark:

Factor = Antenna Factor + Cable Loss – Pre-amplifier.

No.	Mk.	Freq. MHz	Reading Level dBuV	Correct Factor dB	Measure- ment dBuV/m	Limit dB/m	Over dB	Detector
1		32.5198	36.74	-15.81	20.93	40.00	-19.07	QP
2		71.8320	33.98	-17.66	16.32	40.00	-23.68	QP
3		119.8556	38.26	-16.76	21.50	43.50	-22.00	QP
4		216.0240	37.29	-14.93	22.36	46.00	-23.64	QP
5		428.0193	34.80	-9.09	25.71	46.00	-20.29	QP
6	*	668.1423	31.86	-4.07	27.79	46.00	-18.21	QP

8. EUT PHOTOGRAPHS

Model: ZKB102RBB41
EUT Photo 1



EUT Photo 2



EUT Photo 3

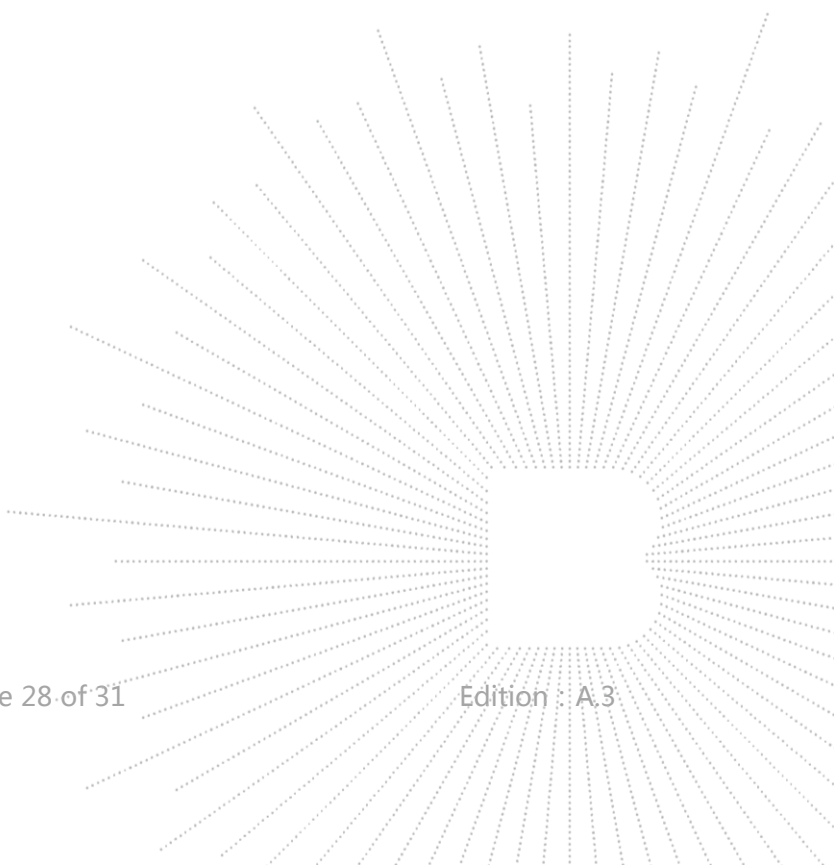

9. EUT TEST SETUP PHOTOGRAPHS

Conducted emissions

Model: ZKB102RBB41

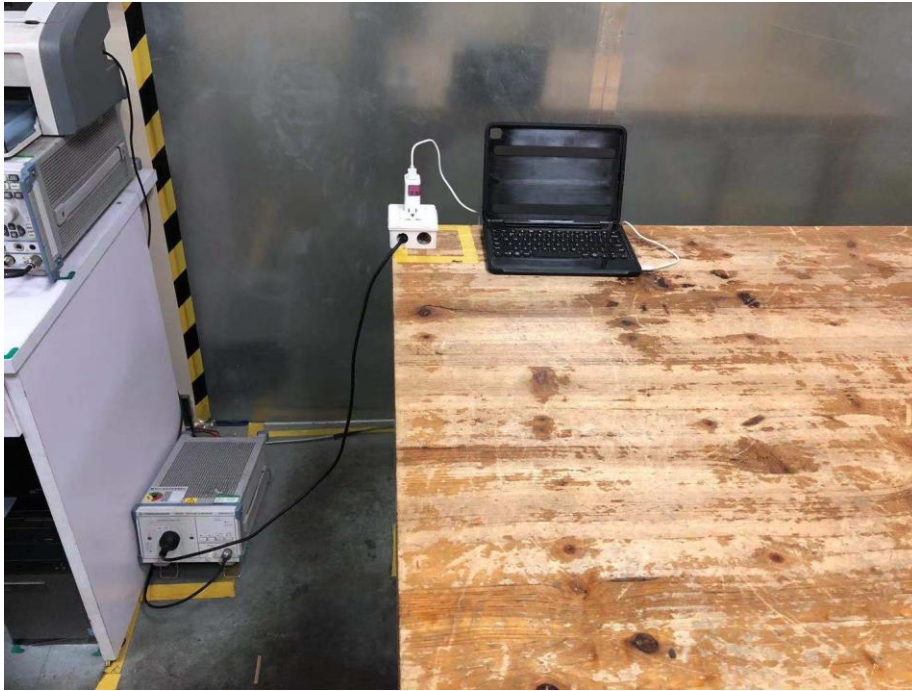

Model: ZKB109RBB41



Radiated emission

Model: ZKB102RBB41

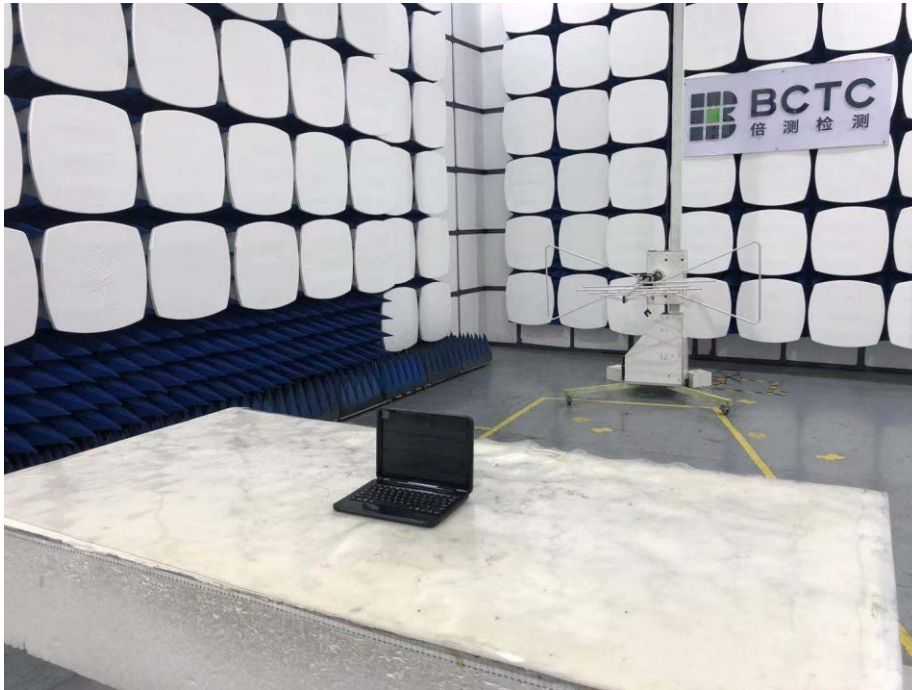

Model: ZKB109RBB41

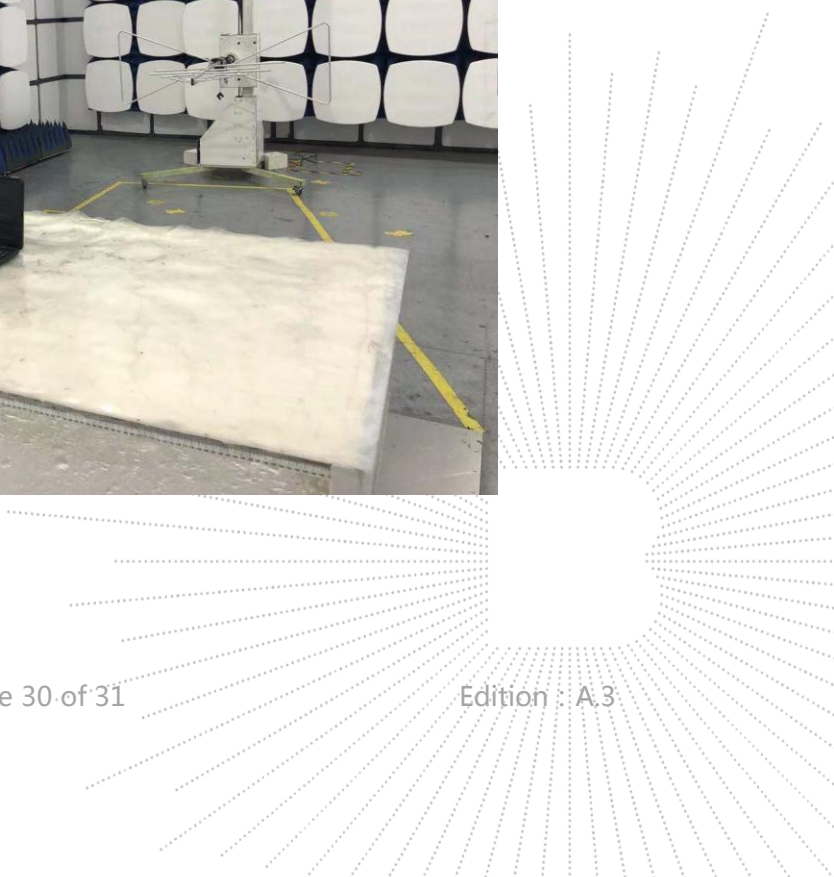

STATEMENT

- 1.The equipment lists are traceable to the national reference standards.
- 2.The test report can not be partially copied unless prior written approval is issued from our lab.
- 3.The test report is invalid without stamp of laboratory.
- 4.The test report is invalid without signature of person(s) testing and authorizing.
- 5.The test process and test result is only related to the Unit Under Test.
- 6.The quality system of our laboratory is in accordance with ISO/IEC17025.
- 7.If there is any objection to report, the client should inform issuing laboratory within 15 days from the date of receiving test report.

Address:

1-2/F., Building B, Pengzhou Industrial Park, No.158, Fuyuan 1st Road, Tangwei, Fuhai Subdistrict, Bao'an District, Shenzhen, Guangdong, China

TEL : 400-788-9558

P.C.: 518103

FAX : 0755-33229357

Website : <http://www.chnbctc.com>

E-Mail : bctc@bctc-lab.com.cn

***** END *****

