

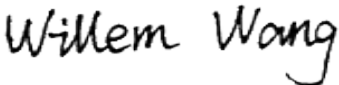



TEST REPORT

FCC ID: QTG-ZKPRB

Product Name: Bluetooth Keyboard
 Trademark: ZAGG
 Model Number: ZKB102RBB41
 Prepared For: ZAGG Inc.
 Address: 910 West Legacy Center Way, Suite 500 Midvale, Utah 84047, USA.
 Manufacturer: ZAGG Inc.
 Address: 910 West Legacy Center Way, Suite 500 Midvale, Utah 84047, USA.
 Prepared By: Shenzhen BCTC Testing Co., Ltd.
 Address: BCTC Building & 1-2F, East of B Building, Pengzhou Industrial, Fuyuan 1st Road, Qiaotou Community, Fuyong Street, Bao'an District, Shenzhen, China
 Sample Received Date: Apr. 13, 2020
 Sample tested Date: Apr. 13, 2020 to Apr. 29, 2020
 Issue Date: Apr. 29, 2020
 Report No.: BCTC2004001065E
 Test Standards: FCC Part15.247
 ANSI C63.10-2013
 Test Results: PASS
 Remark: This is Bluetooth BLE radio test report.

Compiled by:

 Willem Wang

Reviewed by:

 Eric Yang

Approved by:

 Zero Zhou/Manager



The test report is effective only with both signature and specialized stamp. This result(s) shown in this report refer only to the sample(s) tested. Without written approval of Shenzhen BCTC Testing Co., Ltd, this report can't be reproduced except in full. The tested sample(s) and the sample information are provided by the client.



TABLE OF CONTENT

Test Report Declaration	Page
1. VERSION	4
2. TEST SUMMARY	5
3. MEASUREMENT UNCERTAINTY	6
4. PRODUCT INFORMATION AND TEST SETUP	7
4.1 Product Information	7
4.2 Test Setup Configuration	7
4.3 Support Equipment	8
4.4 Channel List	8
4.5 Test Mode	8
4.6 table of parameters of text software setting	9
4.7 Copy of marking plate	9
5. TEST FACILITY AND TEST INSTRUMENT USED	10
5.1 Test Facility	10
5.2 Test Instrument Used	10
6. CONDUCTED EMISSIONS	12
6.1 Block Diagram Of Test Setup	12
6.2 Limit	12
6.3 Test procedure	12
6.4 EUT operating Conditions	12
6.5 Test Result	13
7. RADIATED EMISSIONS	15
7.1 Block Diagram Of Test Setup	15
7.2 Limit	16
7.3 Test procedure	17
7.4 EUT operating Conditions	18
7.5 Test Result	19
8. RADIATED BAND EMISSION MEASUREMENT AND RESTRICTED BANDS OF OPERATION	23
8.1 Block Diagram Of Test Setup	23
8.2 Limit	23
8.3 Test procedure	24
8.4 EUT operating Conditions	24
8.5 Test Result	25
9. POWER SPECTRAL DENSITY TEST	26
9.1 Block Diagram Of Test Setup	26
9.2 Limit	26
9.3 Test procedure	26
9.4 EUT operating Conditions	26
9.5 Test Result	27
10. BANDWIDTH TEST	29
10.1 Block Diagram Of Test Setup	29



10.2	Limit	29
10.3	Test procedure	29
10.4	EUT operating Conditions	29
10.5	Test Result	30
11.	PEAK OUTPUT POWER TEST	32
11.1	Block Diagram Of Test Setup	32
11.2	Limit	32
11.3	Test procedure	32
11.4	EUT operating Conditions	32
11.5	Test Result	33
12.	100 KHZ BANDWIDTH OF FREQUENCY BAND EDGE	34
12.1	Block Diagram Of Test Setup	34
12.2	Limit	34
12.3	Test procedure	34
12.4	EUT operating Conditions	34
12.5	Test Result	35
13.	ANTENNA REQUIREMENT	37
13.2	Limit	37
13.5	Test Result	37
14.	EUT PHOTOGRAPHS	38
15.	EUT TEST SETUP PHOTOGRAPHS	40

(Note: N/A means not applicable)



1. VERSION

Report No.	Issue Date	Description	Approved
BCTC2004001065E	Apr. 29, 2020	Original	Valid



2. TEST SUMMARY

The Product has been tested according to the following specifications:

No.	Test Parameter	Clause No	Results
1	Conducted Emission	15.207	PASS
2	6dB Bandwidth	15.247 (a)(2)	PASS
3	Peak Output Power	15.247 (b)	PASS
4	Radiated Spurious Emission	15.247 (d), 15.205	PASS
5	Power Spectral Density	15.247 (e)	PASS
6	Restricted Band of Operation	15.205	PASS
7	Band Edge (Out of Band Emissions)	15.247(d)	PASS
8	Antenna Requirement	15.203	PASS



3. MEASUREMENT UNCERTAINTY

Where relevant, the following measurement uncertainty levels have been estimated for tests performed on the Product as specified in CISPR 16-4-2. This uncertainty represents an expanded uncertainty expressed at approximately the 95% confidence level using a coverage factor of $k=2$.

No.	Item	Uncertainty
1	3m chamber Radiated spurious emission(30MHz-1GHz)	U=4.3dB
2	3m chamber Radiated spurious emission(1GHz-18GHz)	U=4.5dB
3	3m chamber Radiated spurious emission(18GHz-40GHz)	U=3.34dB
4	Conducted Adjacent channel power	U=1.38dB
5	Conducted output power uncertainty Above 1G	U=1.576dB
6	Conducted output power uncertainty below 1G	U=1.28dB
7	humidity uncertainty	U=5.3%
8	Temperature uncertainty	U=0.59°C



4. PRODUCT INFORMATION AND TEST SETUP

4.1 Product Information

Model(s):	ZKB102RBB41
Model Description:	N/A
Bluetooth Version:	BT 5.2
Hardware Version:	V1.3
Software Version:	V1.0
Operation Frequency:	Bluetooth: 2402-2480MHz
Type of Modulation:	Bluetooth: GFSK
Number Of Channel	40CH
Antenna installation:	Bluetooth: PCB antenna
Antenna Gain:	Bluetooth: 2dBi
Ratings:	Input : DC 5V 500mA Battery Capacity: DC3.7V, 450mAh, 1.67Wh)

4.2 Test Setup Configuration

See test photographs attached in *EUT TEST SETUP PHOTOGRAPHS* for the actual connections between Product and support equipment.

Conducted Emission:

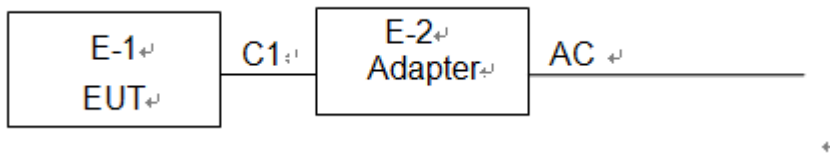

Radiated Spurious Emission

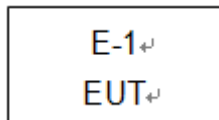



4.3 Support Equipment

No.	Device Type	Brand	Model	Series No.	Data Cable	Power Cord
E-1	Bluetooth Keyboard	ZAGG	ZKB102RB B41	N/A	EUT	E-1
E-2	Adapter	N/A	BCTC001	N/A	Auxiliary	E-2

Item	Shielded Type	Ferrite Core	Length	Note
C-1	NO	NO	0.3M	DC cable unshielded

Notes:

1. All the equipment/cables were placed in the worst-case configuration to maximize the emission during the test.
2. Grounding was established in accordance with the manufacturer's requirements and conditions for the intended use.

4.4 Channel List

Channel List					
Channel	Frequency (MHz)	Channel	Frequency (MHz)	Channel	Frequency (MHz)
01	2402	11	2422	21	2442
02	2404	12	2424	22	2444
03	2406	13	2426	23	2446
~	~	~	~	~	~
09	2418	19	2438	39	2478
10	2420	20	2440	40	2480

4.5 Test Mode

To investigate the maximum EMI emission characteristics generates from EUT, the test system was pre-scanning tested base on the consideration of following EUT operation mode or test configuration mode which possible have effect on EMI emission level. Each of these EUT operation mode(s) or test configuration mode(s) mentioned above was evaluated respectively.

For All Mode	Description	Modulation Type
Mode 1	CH01	GFSK
Mode 2	CH20	
Mode 3	CH40	
Mode 4	Charging +Link mode(Conducted emission)	
Mode 5	Link mode(Radiated emission)	

Note:

- (1) The measurements are performed at the highest, middle, lowest available channels.
- (2) Fully-charged battery is used during the test



4.6 table of parameters of text software setting

During testing channel & power controlling software provided by the customer was used to control the operating channel as well as the output power level. The RF output power selection is for the setting of RF output power expected by the customer and is going to be fixed on the firmware of the final end product power parameters

Test software Version	Pixart BLE Utility		
Frequency	2402 MHz	2440 MHz	2480 MHz
Parameters	DEF	DEF	DEF

4.7 Copy of marking plate

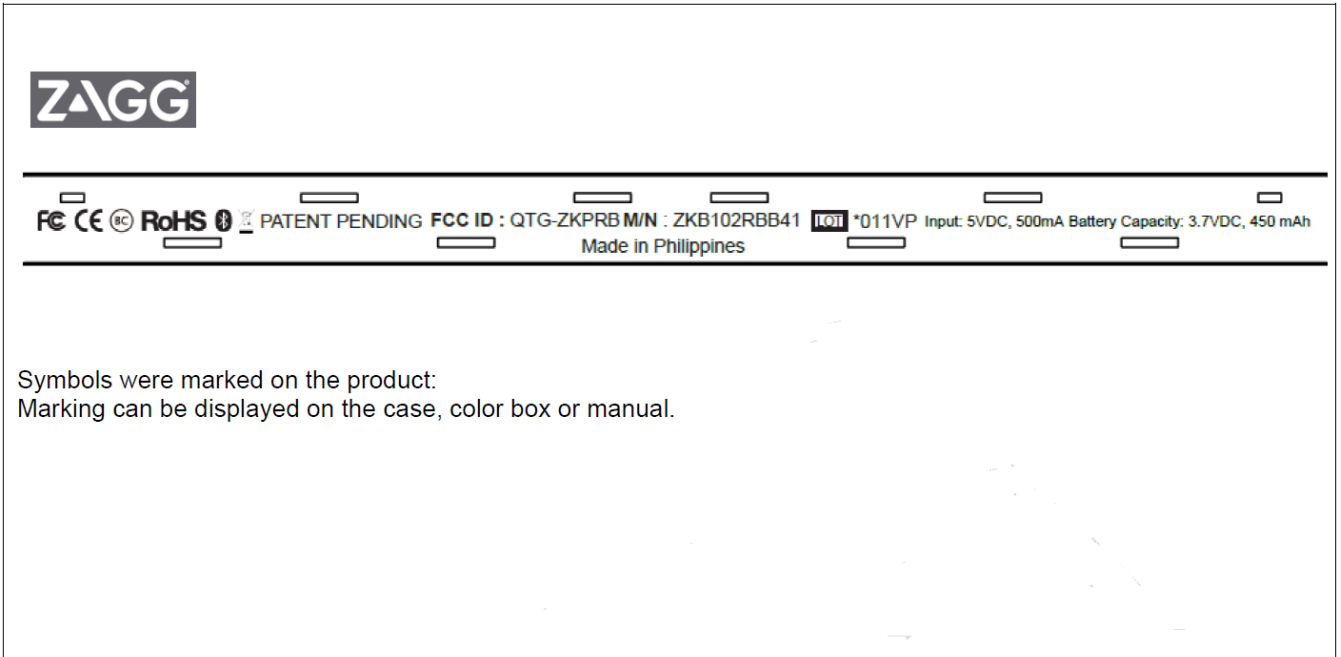



5. TEST FACILITY AND TEST INSTRUMENT USED

5.1 Test Facility

All measurement facilities used to collect the measurement data are located at BCTC Building & 1-2F, East of B Building, Pengzhou Industrial, Fuyuan 1st Road, Qiaotou Community, Fuyong Street, Bao'an District, Shenzhen, China. The site and apparatus are constructed in conformance with the requirements of ANSI C63.4 and CISPR 16-1-1 other equivalent standards.

FCC Test Firm Registration Number: 712850

IC Registered No.: 23583

5.2 Test Instrument Used

Conducted emissions Test					
Equipment	Manufacturer	Model#	Serial#	Last Cal.	Next Cal.
Receiver	R&S	ESR3	102075	Jun. 13, 2019	Jun.12, 2020
LISN	R&S	ENV216	101375	Jun. 13, 2019	Jun.12, 2020
ISN	HPX	ISN T800	S1509001	Jun. 13, 2019	Jun.12, 2020
Software	Frad	EZ-EMC	EMC-CON 3A1	\	\



Radiated emissions Test (966 chamber)					
Equipment	Manufacturer	Model#	Serial#	Last Cal.	Next Cal.
966 chamber	ChengYu	966 Room	966	Jun. 19, 2018	Jun. 18, 2021
Receiver	R&S	ESR3	102075	Jun. 13, 2019	Jun. 12, 2020
Receiver	R&S	ESRP	101154	Jun. 13, 2019	Jun. 12, 2020
Amplifier	Schwarzbeck	BBV9718	9718-309	Jun. 25, 2019	Jun. 24, 2020
Amplifier	Schwarzbeck	BBV9744	9744-0037	Jun. 25, 2019	Jun. 24, 2020
TRILOG Broadband Antenna	schwarzbeck	VULB 9163	VULB9163- 942	Jun. 22, 2019	Jun. 21, 2020
Horn Antenna	SCHWARZBEC K	BBHA9120 D	1201	Jun. 22, 2019	Jun. 21, 2020
Horn Antenna (18GHz-40 GHz)	SCHWARZBE CK	BBHA9170	822	Jun. 22, 2019	Jun. 21, 2020
Amplifier (18GHz-40 GHz)	MITEQ	TTA1840-3 5-HG	2034381	Jun. 17, 2019	Jun. 16, 2020
Loop Antenna (9KHz-30M Hz)	SCHWARZBE CK	FMZB1519 B	014	Jul. 02, 2019	Jul. 01, 2020
RF cables1 (9kHz-30MH z)	Huber+Suhnar	9kHz-30M Hz	B1702988- 0008	Jun. 25, 2019	Jun. 24, 2020
RF cables2 (30MHz-1G Hz)	Huber+Suhnar	30MHz-1G Hz	1486150	Jun. 25, 2019	Jun. 24, 2020
RF cables3 (1GHz-40G Hz)	Huber+Suhnar	1GHz-40G Hz	1607106	Jun. 25, 2019	Jun. 24, 2020
Power Metter	Keysight	E4419B	\	Jun. 17, 2019	Jun. 16, 2020
Power Sensor (AV)	Keysight	E9 300A	\	Jun. 17, 2019	Jun. 16, 2020
Signal Analyzer 20kHz-26.5 GHz	KEYSIGHT	N9020A	MY491000 60	Jun. 13, 2019	Jun. 12, 2020
Spectrum Analyzer 9kHz-40G Hz	Agilent	FSP40	100363	Jun. 13, 2019	Jun. 12, 2020
Software	Frad	EZ-EMC	FA-03A2 RE	\	\

6. CONDUCTED EMISSIONS

6.1 Block Diagram Of Test Setup

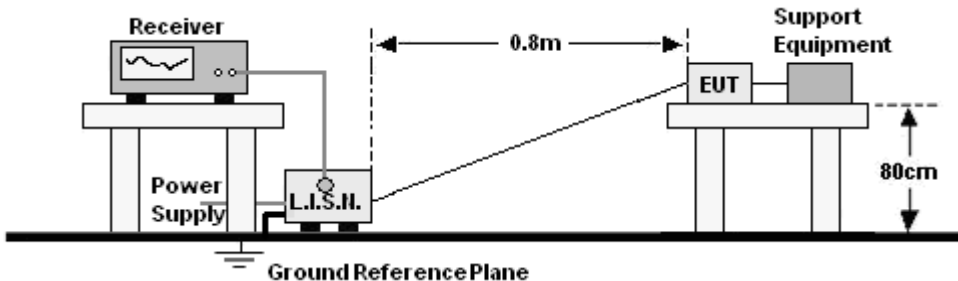

6.2 Limit

FREQUENCY (MHz)	Limit (dBuV)	
	Quas-peak	Average
0.15 -0.5	66 - 56 *	56 - 46 *
0.50 -5.0	56.00	46.00
5.0 -30.0	60.00	50.00

Notes:
 1. *Decreasing linearly with logarithm of frequency.
 2. The lower limit shall apply at the transition frequencies.

6.3 Test procedure

Receiver Parameters	Setting
Attenuation	10 dB
Start Frequency	0.15 MHz
Stop Frequency	30 MHz
IF Bandwidth	9 kHz

- The Product was placed on a nonconductive table 0.8 m above the horizontal ground reference plane, and 0.4 m from the vertical ground reference plane, and connected to the main through Line Impedance Stability Network (L.I.S.N).
- The RBW of the receiver was set at 9 kHz in 150 kHz ~ 30MHz with Peak and AVG detector in Max Hold mode. Run the receiver's pre-scan to record the maximum disturbance generated from Product in all power lines in the full band.
- For each frequency whose maximum record was higher or close to limit, measure its QP and AVG values and record.

6.4 EUT operating Conditions

The EUT was configured for testing in a typical fashion (as a customer would normally use it). The EUT has been programmed to continuously transmit during test. This operating condition was tested and used to collect the included data.



6.5 Test Result

Temperature :	26 °C	Relative Humidity :	54%
Pressure :	101kPa	Phase :	L
Test Voltage :	DC 5V From Adapter Input AC 120V/60Hz	Test Mode :	Mode 4

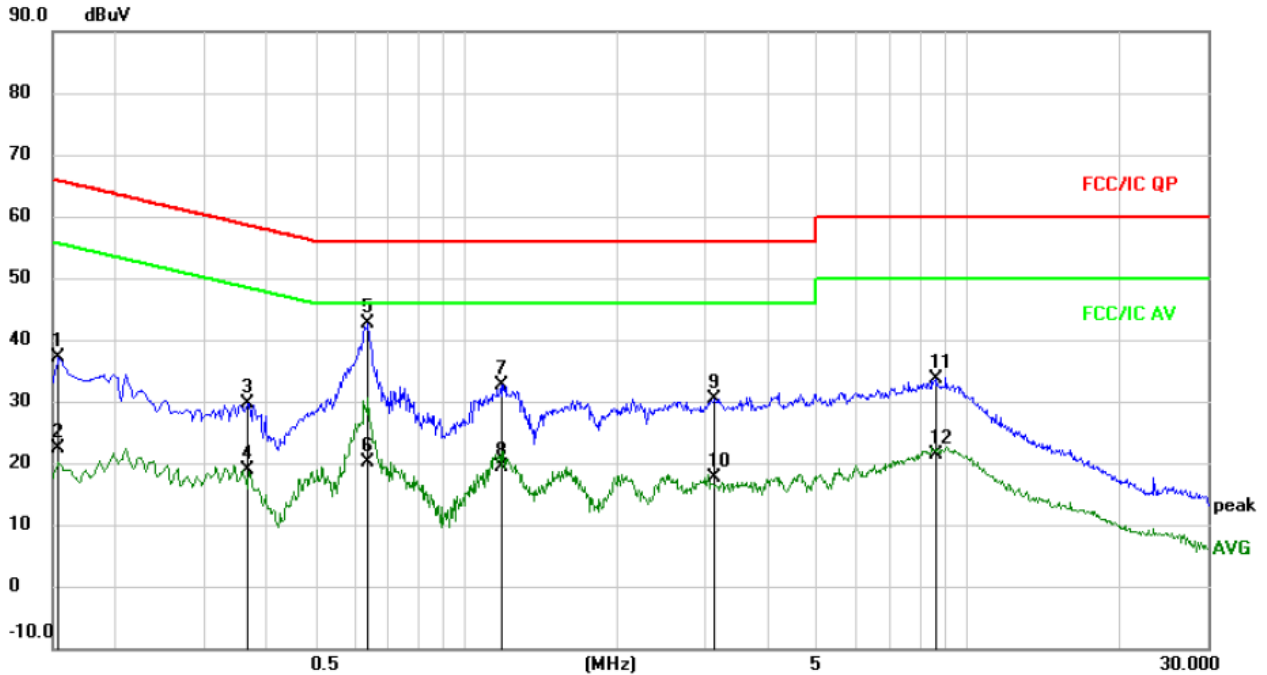

Remark:

1. All readings are Quasi-Peak and Average values.
2. Factor = Insertion Loss + Cable Loss.

No. Mk.	Freq. MHz	Reading Level dBuV	Correct Factor	Measure- ment dBuV	Limit dBuV	Over dB	Detector	Comment
1	0.1539	27.59	9.52	37.11	65.79	-28.68	QP	
2	0.1539	12.78	9.52	22.30	55.79	-33.49	AVG	
3	0.3660	20.08	9.53	29.61	58.59	-28.98	QP	
4	0.3660	9.39	9.53	18.92	48.59	-29.67	AVG	
5 *	0.6380	32.72	9.87	42.59	56.00	-13.41	QP	
6	0.6380	10.31	9.87	20.18	46.00	-25.82	AVG	
7	1.1740	23.13	9.57	32.70	56.00	-23.30	QP	
8	1.1740	9.69	9.57	19.26	46.00	-26.74	AVG	
9	3.1260	20.81	9.67	30.48	56.00	-25.52	QP	
10	3.1260	7.94	9.67	17.61	46.00	-28.39	AVG	
11	8.6140	23.88	9.70	33.58	60.00	-26.42	QP	
12	8.6140	11.76	9.70	21.46	50.00	-28.54	AVG	



Temperature :	26 °C	Relative Humidity :	54%
Pressure :	101kPa	Phase :	N
Test Voltage :	DC 5V From Adapter Input AC 120V/60Hz	Test Mode :	Mode 4

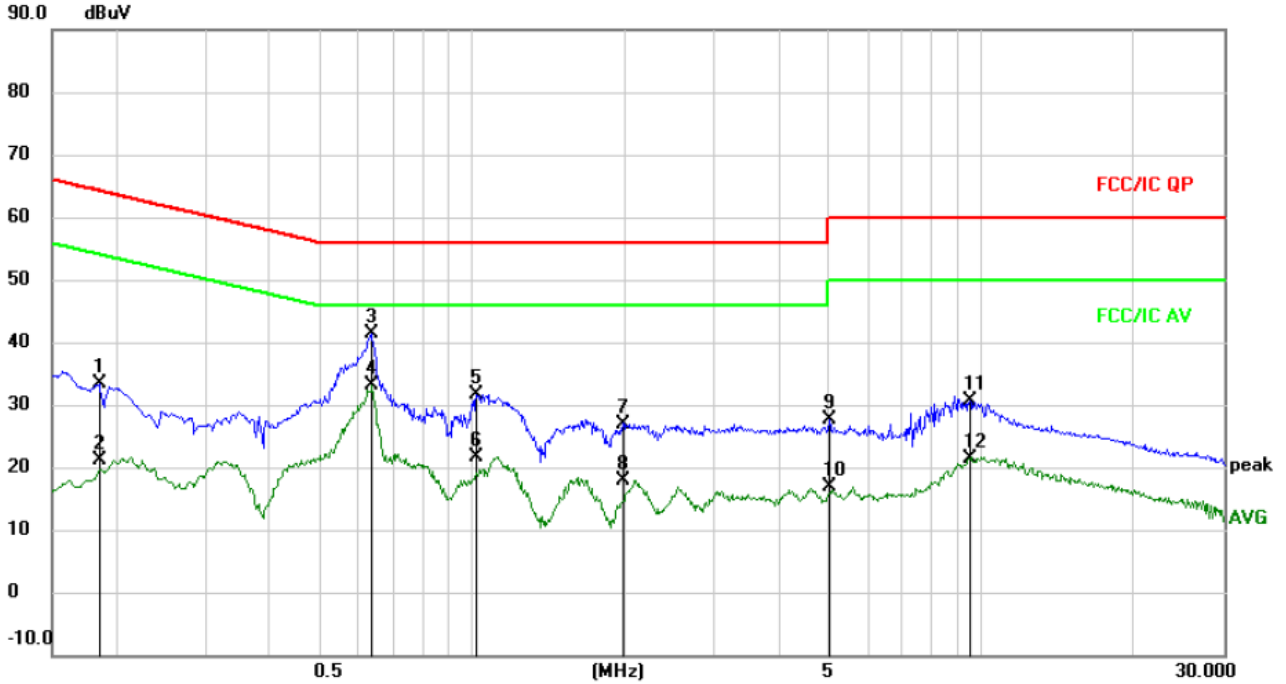

Remark:

1. All readings are Quasi-Peak and Average values.
2. Factor = Insertion Loss + Cable Loss.

No. Mk.	Freq. MHz	Reading Level dBuV	Correct Factor	Measure- ment dBuV	Limit dBuV	Over dB	Detector	Comment
1	0.1860	23.88	9.48	33.36	64.21	-30.85	QP	
2	0.1860	11.61	9.48	21.09	54.21	-33.12	AVG	
3	0.6340	31.44	9.88	41.32	56.00	-14.68	QP	
4 *	0.6340	23.18	9.88	33.06	46.00	-12.94	AVG	
5	1.0260	22.14	9.57	31.71	56.00	-24.29	QP	
6	1.0260	12.12	9.57	21.69	46.00	-24.31	AVG	
7	1.9820	17.41	9.59	27.00	56.00	-29.00	QP	
8	1.9820	8.35	9.59	17.94	46.00	-28.06	AVG	
9	5.0340	17.80	9.80	27.60	60.00	-32.40	QP	
10	5.0340	6.98	9.80	16.78	50.00	-33.22	AVG	
11	9.5260	20.95	9.69	30.64	60.00	-29.36	QP	
12	9.5260	11.66	9.69	21.35	50.00	-28.65	AVG	

7. RADIATED EMISSIONS

7.1 Block Diagram Of Test Setup

(A) Radiated Emission Test-Up Frequency Below 30MHz

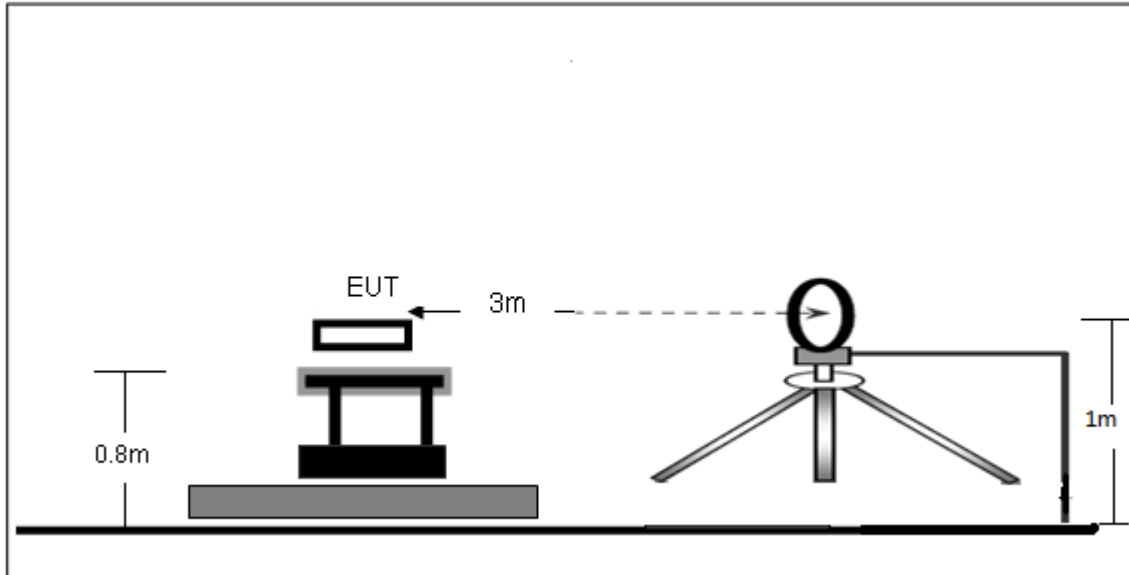

(B) Radiated Emission Test-Up Frequency 30MHz~1GHz

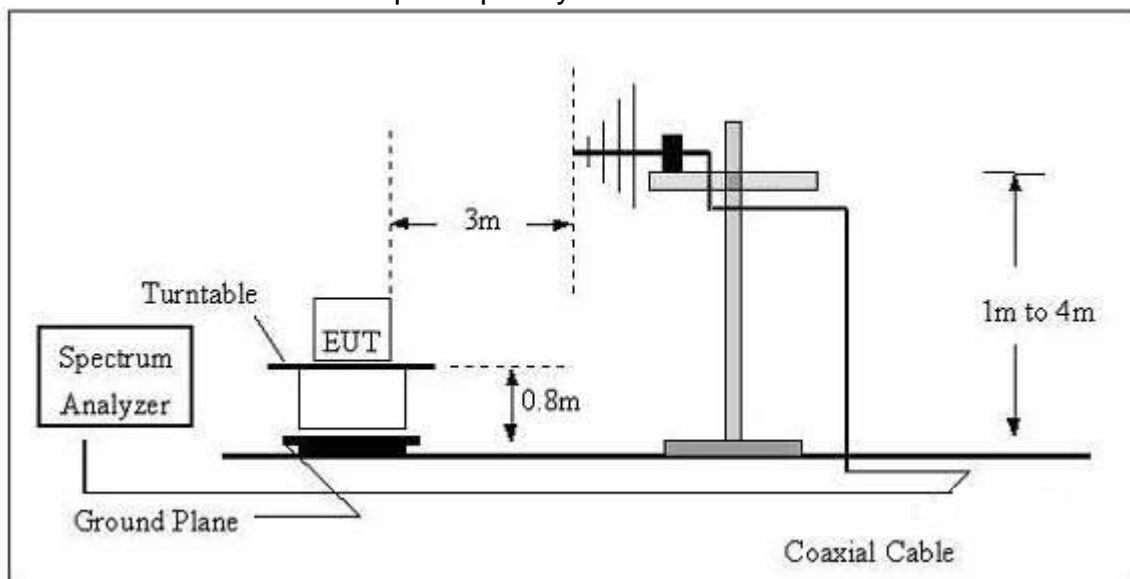

(C) Radiated Emission Test-Up Frequency Above 1GHz

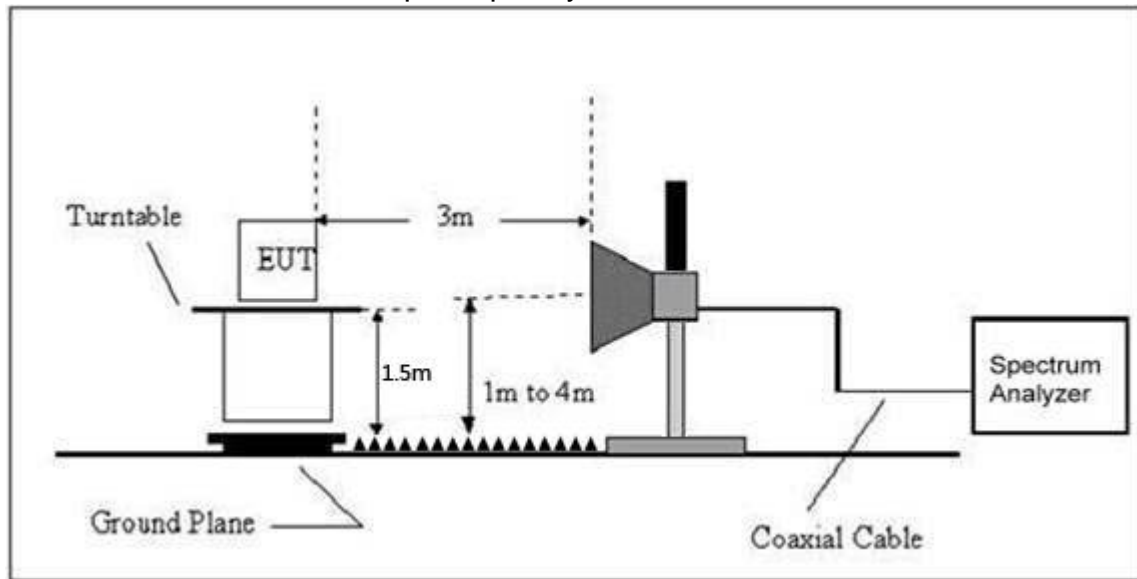

7.2 Limit

20dBc in any 100 kHz bandwidth outside the operating frequency band. In case the emission fall within the restricted band specified on 15.205(a), then the 15.209(a) limit in the table below has to be followed.

Frequency (MHz)	Field Strength uV/m	Distance (m)	Field Strength Limit at 3m Distance	
			uV/m	dBuV/m
0.009 ~ 0.490	2400/F(kHz)	300	10000 * 2400/F(kHz)	20log ^{(2400/F(kHz))} + 80
0.490 ~ 1.705	24000/F(kHz)	30	100 * 24000/F(kHz)	20log ^{(24000/F(kHz))} + 40
1.705 ~ 30	30	30	100 * 30	20log ⁽³⁰⁾ + 40
30 ~ 88	100	3	100	20log ⁽¹⁰⁰⁾
88 ~ 216	150	3	150	20log ⁽¹⁵⁰⁾
216 ~ 960	200	3	200	20log ⁽²⁰⁰⁾
Above 960	500	3	500	20log ⁽⁵⁰⁰⁾

LIMITS OF RADIATED EMISSION MEASUREMENT (Above 1000MHz)

FREQUENCY (MHz)	Limit (dBuV/m) (at 3M)	
	PEAK	AVERAGE
Above 1000	74	54

Notes:

- (1)The limit for radiated test was performed according to FCC PART 15C.
- (2)The tighter limit applies at the band edges.
- (3) Emission level (dBuV/m)=20log Emission level (uV/m).



FREQUENCY RANGE OF RADIATED MEASUREMENT (For unintentional radiators)

Highest frequency generated or Upper frequency of measurement used in the device or on which the device operates or tunes (MHz)	Range (MHz)
Below 1.705	30
1.705 – 108	1000
108 – 500	2000
500 – 1000	5000
Above 1000	5 th harmonic of the highest frequency or 40 GHz, whichever is lower

7.3 Test procedure

Receiver Parameter	Setting
Attenuation	Auto
9kHz~150kHz	RBW 200Hz for QP
150kHz~30MHz	RBW 9kHz for QP
30MHz~1000MHz	RBW 120kHz for QP

Spectrum Parameter	Setting
1-25GHz	RBW 1 MHz /VBW 1 MHz for Peak, RBW 1 MHz / VBW 10Hz for Average

Below 1GHz test procedure as below:

- a. The EUT was placed on the top of a rotating table 0.8 meters above the ground at a 3 meter semi-anechoic chamber. The table was rotated 360 degrees to determine the position of the highest radiation.
- b. The EUT was set 3 meters away from the interference-receiving antenna, which was mounted on the top of a variable-height antenna tower.
- c. The antenna height is varied from one meter to four meters above the ground to determine the maximum value of the field strength. Both horizontal and vertical polarizations of the antenna are set to make the measurement.
- d. For each suspected emission, the EUT was arranged to its worst case and then the antenna was tuned to heights from 1 meter to 4 meters (for the test frequency of below 30MHz, the antenna was tuned to heights 1 meter) and the rotatable table was turned from 0 degrees to 360 degrees to find the maximum reading.
- e. The test-receiver system was set to Peak Detect Function and Specified Bandwidth with Maximum Hold Mode.
- f. If the emission level of the EUT in peak mode was 10dB lower than the limit specified, then testing could be stopped and the peak values of the EUT would be reported. Otherwise



the emissions that did not have 10dB margin would be re-tested one by one using peak, quasi-peak or average method as specified and then reported in a data sheet.

Above 1GHz test procedure as below:

g. Different between above is the test site, change from Semi- Anechoic Chamber to fully Anechoic Chamber and change form table 0.8 metre to 1.5 metre(Above 18GHz the distance is 1 meter and table is 1.5 metre).

h. Test the EUT in the lowest channel ,the middle channel ,the Highest channel.

Note:

Both horizontal and vertical antenna polarities were tested and performed pretest to three orthogonal axis. The worst case emissions were reported.

Above 1GHz test procedure as below:

a.The EUT was placed on the top of a rotating table 1.5 meters above the ground at a 3 meter camber. The table was rotated 360 degrees to determine the position of the highest radiation.

b.The EUT was set 3 meters away from the interference-receiving antenna, which was mounted on the top of a variable-height antenna tower.

c.The antenna height is varied from one meter to four meters above the ground to determine the maximum value of the field strength. Both horizontal and vertical polarizations of the antenna are set to make the measurement.

d.For each suspected emission, the EUT was arranged to its worst case and then the antenna was tuned to heights from 1 meter to 4 meters and the rota table was turned from 0 degrees to 360 degrees to find the maximum reading.

e.The test-receiver system was set to Peak Detect Function and Specified Bandwidth with Maximum Hold Mode.

f. If the emission level of the EUT in peak mode was 10dB lower than the limit specified, then testing could be stopped and the peak values of the EUT would be reported. Otherwise the emissions that did not have 10dB margin would be re-tested one by one using peak, quasi-peak or average method as specified and then reported in a data sheet.

g.Test the EUT in the lowest channel,the Highest channel.

Note:

Both horizontal and vertical antenna polarities were tested and performed pretest to three orthogonal axis. The worst case emissions were reported.

7.4 EUT operating Conditions

The EUT was configured for testing in a typical fashion (as a customer would normally use it). The EUT has been programmed to continuously transmit during test. This operating condition was tested and used to collect the included data.



7.5 Test Result

Below 30MHz

Temperature:	26°C	Relative Humidity:	24%
Pressure:	101 kPa	Test Voltage :	DC 3.7V
Test Mode :	Mode 5	Polarization :	--

Freq.	Reading	Limit	Margin	State
(MHz)	(dBuV/m)	(dBuV/m)	(dB)	P/F
--	--	--	--	PASS
--	--	--	--	PASS

Note:

The amplitude of spurious emissions which are attenuated by more than 20dB below the permissible value has no need to be reported.

Distance extrapolation factor =40 log (specific distance/test distance)(dB);

Limit line = specific limits(dBuv) + distance extrapolation factor.



Between 30MHz – 1GHz

Temperature:	26°C	Relative Humidity:	54%
Pressure:	101 kPa	Test Voltage :	DC 3.7V
Test Mode :	Mode 5	Polarization :	Horizontal

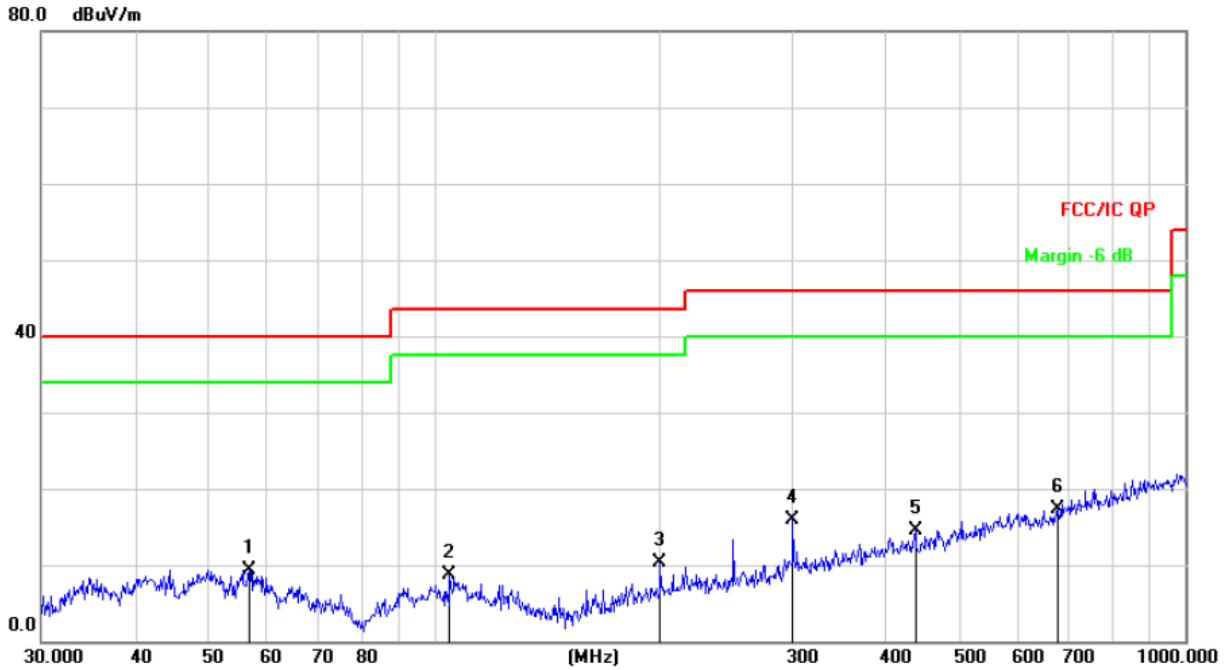

Remark:

Factor = Antenna Factor + Cable Loss – Pre-amplifier.

No.	Mk.	Freq.	Reading Level	Correct Factor	Measurement	Limit	Over	Detector
		MHz	dBuV	dB	dBuV/m	dB/m	dB	
1		56.7917	24.93	-15.57	9.36	40.00	-30.64	QP
2		104.9033	25.33	-16.60	8.73	43.50	-34.77	QP
3		199.9856	26.63	-16.30	10.33	43.50	-33.17	QP
4		300.3672	29.42	-13.59	15.83	46.00	-30.17	QP
5		437.1199	24.79	-10.26	14.53	46.00	-31.47	QP
6	*	675.2080	23.37	-5.97	17.40	46.00	-28.60	QP



Temperature:	26°C	Relative Humidity:	54%
Pressure:	101 kpa	Test Voltage :	DC 3.7V
Test Mode :	Mode 5	Polarization :	Vertical

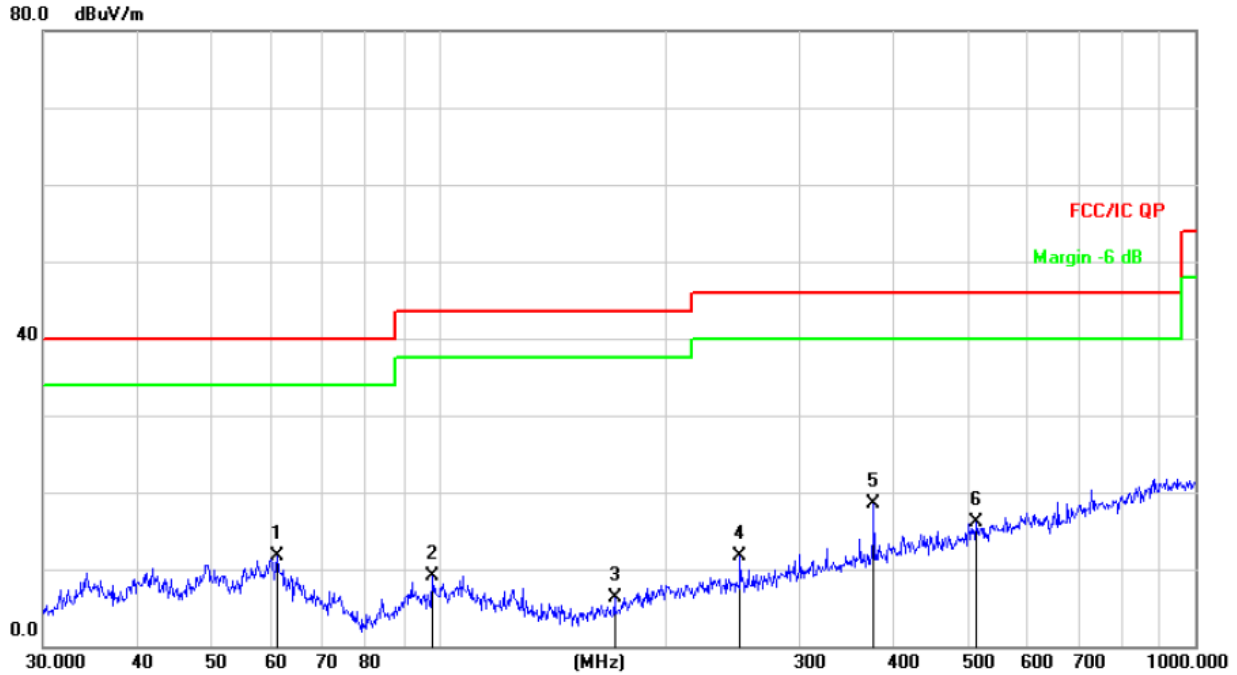

Remark:

Factor = Antenna Factor + Cable Loss – Pre-amplifier.

No.	Mk.	Freq.	Reading Level	Correct Factor	Measurement	Limit	Over	
		MHz	dBuV	dB	dBuV/m	dB/m	dB	Detector
1		61.1316	27.80	-16.17	11.63	40.00	-28.37	QP
2		98.1419	25.80	-16.62	9.18	43.50	-34.32	QP
3		170.7926	24.52	-18.17	6.35	43.50	-37.15	QP
4		250.3012	26.92	-15.14	11.78	46.00	-34.22	QP
5	*	375.9385	30.07	-11.64	18.43	46.00	-27.57	QP
6		513.6331	24.78	-8.60	16.18	46.00	-29.82	QP



Between 1GHz – 25GHz

Polar (H/V)	Frequency	Reading Level	Correct Factor	Measure- ment	Limits	Over	Detector Type
	(MHz)	(dBuV/m)	(dB)	(dBuV/m)	(dBuV/ m)	(dB)	
Low channel							
V	4804.00	50.14	-0.43	49.71	74.00	-24.29	PK
V	4804.00	40.18	-0.43	39.75	54.00	-14.25	AV
V	7206.00	44.25	8.31	52.56	74.00	-21.44	PK
V	7206.00	35.39	8.31	43.70	54.00	-10.30	AV
H	4804.00	51.37	-0.43	50.94	74.00	-23.06	PK
H	4804.00	41.74	-0.43	41.31	54.00	-12.69	AV
H	7206.00	43.36	8.31	51.67	74.00	-22.33	PK
H	7206.00	36.67	8.31	44.98	54.00	-9.02	AV
Middle channel							
V	4880.00	49.69	-0.38	49.31	74.00	-24.69	PK
V	4880.00	40.77	-0.38	40.39	54.00	-13.61	AV
V	7320.00	43.76	8.82	52.58	74.00	-21.42	PK
V	7320.00	35.63	8.82	44.45	54.00	-9.55	AV
H	4880.00	51.57	-0.38	51.19	74.00	-22.81	PK
H	4880.00	41.49	-0.38	41.11	54.00	-12.89	AV
H	7320.00	44.19	8.82	53.01	74.00	-20.99	PK
H	7320.00	35.84	8.82	44.66	54.00	-9.34	AV
High channel							
V	4960.00	50.96	-0.32	50.64	74.00	-23.36	PK
V	4960.00	41.14	-0.32	40.82	54.00	-13.18	AV
V	7440.00	44.53	9.35	53.88	74.00	-20.12	PK
V	7440.00	36.25	9.35	45.60	54.00	-8.40	AV
H	4960.00	51.60	-0.32	51.28	74.00	-22.72	PK
H	4960.00	40.80	-0.32	40.48	54.00	-13.52	AV
H	7440.00	43.87	9.35	53.22	74.00	-20.78	PK
H	7440.00	37.36	9.35	46.71	54.00	-7.29	AV

Remark:

1. Emission Level = Meter Reading + Factor,
Factor = Antenna Factor + Cable Loss – Pre-amplifier.
Over = Emission Level - Limit
2. If peak below the average limit, the average emission was no test.
3. In restricted bands of operation, The spurious emissions below the permissible value more than 20dB
4. The amplitude of spurious emissions which are attenuated by more than 20dB below the permissible value has no need to be reported.

8. RADIATED BAND EMISSION MEASUREMENT AND RESTRICTED BANDS OF OPERATION

8.1 Block Diagram Of Test Setup

Radiated Emission Test-Up Frequency Above 1GHz

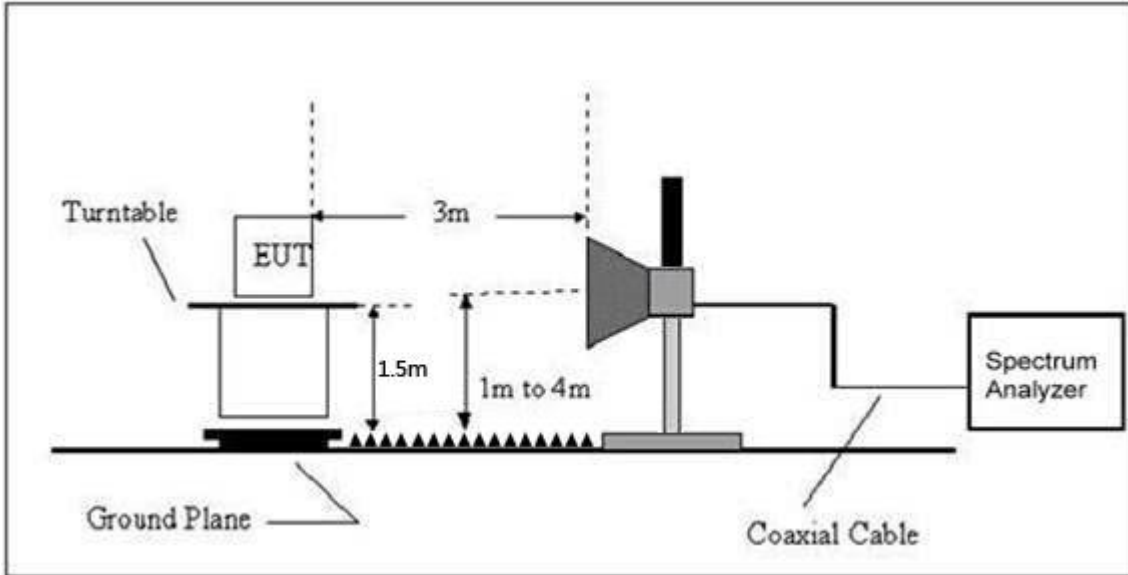

8.2 Limit

FCC Part15 C Section 15.209 and 15.205

(a) Except as shown in paragraph (d) of this section, only spurious emissions are permitted in any of the frequency bands listed below:

MHz	MHz	MHz	GHz
0.090-0.110	16.42-16.423	399.9-410	4.5-5.15
0.495-0.505	16.69475-16.69525	608-614	5.35-5.46
2.1735-2.1905	16.80425-16.80475	960-1240	7.25-7.75
4.125-4.128	25.5-25.67	1300-1427	8.025-8.5
4.17725-4.17775	37.5-38.25	1435-1626.5	9.0-9.2
4.20725-4.20775	73-74.6	1645.5-1646.5	9.3-9.5
6.215-6.218	74.8-75.2	1660-1710	10.6-12.7
6.26775-6.26825	108-121.94	1718.8-1722.2	13.25-13.4
6.31175-6.31225	123-138	2200-2300	14.47-14.5
8.291-8.294	149.9-150.05	2310-2390	15.35-16.2
8.362-8.366	156.52475-156.52525	2483.5-2500	17.7-21.4
8.37625-8.38675	156.7-156.9	2690-2900	22.01-23.12
8.41425-8.41475	162.0125-167.17	3260-3267	23.6-24.0
12.29-12.293	167.72-173.2	3332-3339	31.2-31.8
12.51975-12.52025	240-285	3345.8-3358	36.43-36.5
12.57675-12.57725	322-335.4	3600-4400	(2)
13.36-13.41			

LIMITS OF RADIATED EMISSION MEASUREMENT (Above 1000MHz)

FREQUENCY (MHz)	Limit (dBuV/m) (at 3M)	
	PEAK	AVERAGE
Above 1000	74	54

Notes:

- (1) The limit for radiated test was performed according to FCC PART 15C.
- (2) The tighter limit applies at the band edges.
- (3) Emission level (dBuV/m) = 20log Emission level (uV/m).



8.3 Test procedure

Receiver Parameter	Setting
Attenuation	Auto
Start Frequency	2300MHz
Stop Frequency	2520
RB / VB (emission in restricted band)	1 MHz / 1 MHz for Peak, 1 MHz / 10Hz for Average

Above 1GHz test procedure as below:

- a. The EUT was placed on the top of a rotating table 1.5 meters above the ground at a 3 meter camber. The table was rotated 360 degrees to determine the position of the highest radiation.
- b. The EUT was set 3 meters away from the interference-receiving antenna, which was mounted on the top of a variable-height antenna tower.
- c. The antenna height is varied from one meter to four meters above the ground to determine the maximum value of the field strength. Both horizontal and vertical polarizations of the antenna are set to make the measurement.
- d. For each suspected emission, the EUT was arranged to its worst case and then the antenna was tuned to heights from 1 meter to 4 meters and the rota table was turned from 0 degrees to 360 degrees to find the maximum reading.
- e. The test-receiver system was set to Peak Detect Function and Specified Bandwidth with Maximum Hold Mode.
- f. If the emission level of the EUT in peak mode was 10dB lower than the limit specified, then testing could be stopped and the peak values of the EUT would be reported. Otherwise the emissions that did not have 10dB margin would be re-tested one by one using peak, quasi-peak or average method as specified and then reported in a data sheet.
- g. Test the EUT in the lowest channel, the Highest channel.

Note:

Both horizontal and vertical antenna polarities were tested and performed pretest to three orthogonal axis. The worst case emissions were reported.

8.4 EUT operating Conditions

The EUT was configured for testing in a typical fashion (as a customer would normally use it). The EUT has been programmed to continuously transmit during test. This operating condition was tested and used to collect the included data.



8.5 Test Result

	Polar (H/V)	Frequency (MHz)	Reading Level (dBuV/m)	Correct Factor (dB)	Measurement (dBuV/m)	Limits (dBuV/m)		Result	
					PK	PK	AV		
Low Channel 2402MHz									
GFSK	H	2390.00	55.25	-6.7	48.55	74.00	54.00	PASS	
	H	2400.00	54.39	-6.71	47.68	74.00	54.00	PASS	
	V	2390.00	55.08	-6.7	48.38	74.00	54.00	PASS	
	V	2400.00	54.86	-6.71	48.15	74.00	54.00	PASS	
	High Channel 2480MHz								
	H	2483.50	53.25	-6.79	46.46	74.00	54.00	PASS	
	H	2500.00	55.11	-6.81	48.30	74.00	54.00	PASS	
	V	2483.50	54.14	-6.79	47.35	74.00	54.00	PASS	
V	2500.00	54.22	-6.81	47.41	74.00	54.00	PASS		

Remark:

1. Emission Level = Meter Reading + Factor,
Factor = Antenna Factor + Cable Loss – Pre-amplifier.
Over= Emission Level - Limit
2. If the PK measured levels comply with average limit, then the average level were deemed to comply with average limit.
- 3 In restricted bands of operation, The spurious emissions below the permissible value more than 20dB
4. The amplitude of spurious emissions which are attenuated by more than 20dB below the permissible value has no need to be reported.



9. POWER SPECTRAL DENSITY TEST

9.1 Block Diagram Of Test Setup

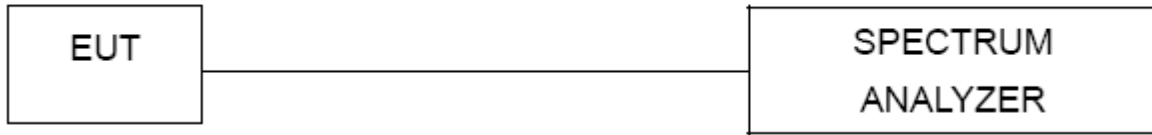

9.2 Limit

FCC Part15 (15.247) , Subpart C				
Section	Test Item	Limit	Frequency Range (MHz)	Result
15.247	Power Spectral Density	8 dBm (in any 3KHz)	2400-2483.5	PASS

LIMITS OF RADIATED EMISSION MEASUREMENT (Above 1000MHz)

9.3 Test procedure

1. Set analyzer center frequency to DTS channel center frequency.
2. Set the span to 1.5 times the DTS bandwidth.
3. Set the RBW to: 3 kHz
4. Set the VBW $\geq 3 \times$ RBW.
5. Detector = peak.
6. Sweep time = auto couple.
7. Trace mode = max hold.
8. Allow trace to fully stabilize.
9. Use the peak marker function to determine the maximum amplitude level within the RBW.
10. If measured value exceeds limit, reduce RBW (no less than 3 kHz) and repeat.

9.4 EUT operating Conditions

The EUT tested system was configured as the statements of 4.6 Unless otherwise a special operating condition is specified in the follows during the testing.

Note: Power Spectral Density(dBm)=Reading+Cable Loss



9.5 Test Result

Temperature :	26°C	Relative Humidity :	54%
Test Mode :	GFSK	Test Voltage :	DC 3.7V

Frequency	Power Spectral Density(dBm/3kHz)	Limit (dBm/3kHz)	Result
2402 MHz	-14.895	8	PASS
2440 MHz	-15.629	8	PASS
2480 MHz	-16.649	8	PASS

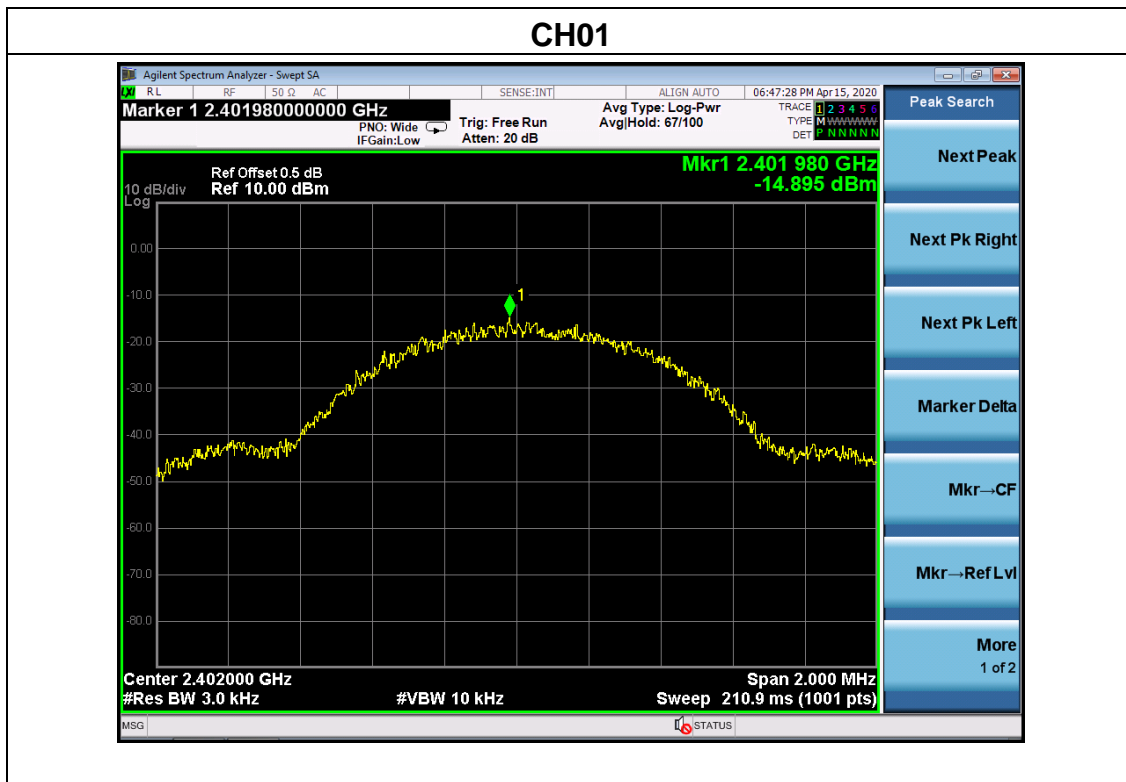



CH20



CH40





10. BANDWIDTH TEST

10.1 Block Diagram Of Test Setup

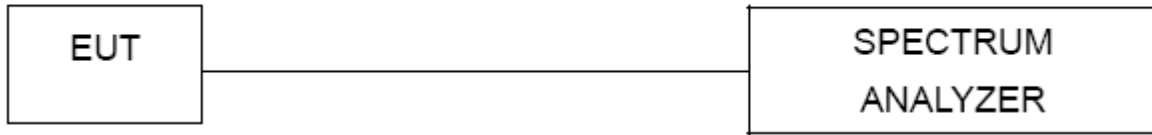

10.2 Limit

FCC Part15 (15.247) , Subpart C				
Section	Test Item	Limit	Frequency Range (MHz)	Result
15.247(a)(2)	Bandwidth	$\geq 500\text{KHz}$ (6dB bandwidth)	2400-2483.5	PASS

10.3 Test procedure

1. Set RBW = 100 kHz.
2. Set the video bandwidth (VBW) $\geq 3 \times$ RBW.
3. Detector = Peak.
4. Trace mode = max hold.
5. Sweep = auto couple.
6. Allow the trace to stabilize.
7. Measure the maximum width of the emission that is constrained by the frequencies associated with the two outermost amplitude points (upper and lower frequencies) that are attenuated by 6 dB relative to the maximum level measured in the fundamental emission.

10.4 EUT operating Conditions

The EUT tested system was configured as the statements of 4.6 Unless otherwise a special operating condition is specified in the follows during the testing.

Note: Power Spectral Density(dBm)=Reading+Cable Loss



10.5 Test Result

Temperature :	26°C	Relative Humidity :	54%
Test Mode :	GFSK	Test Voltage :	DC 3.7V

Frequency (MHz)	6dB bandwidth (MHz)	Limit (kHz)	Result
2402	0.698	500	Pass
2440	0.699	500	Pass
2480	0.695	500	Pass

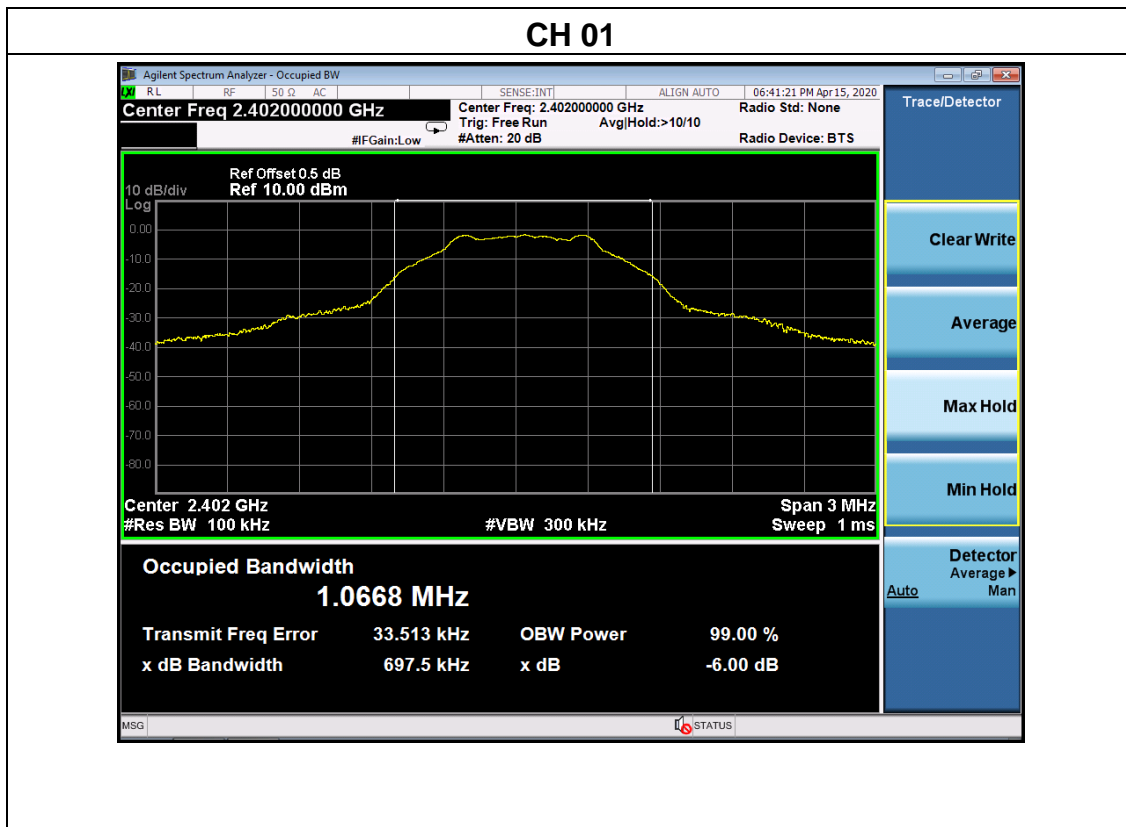



CH20

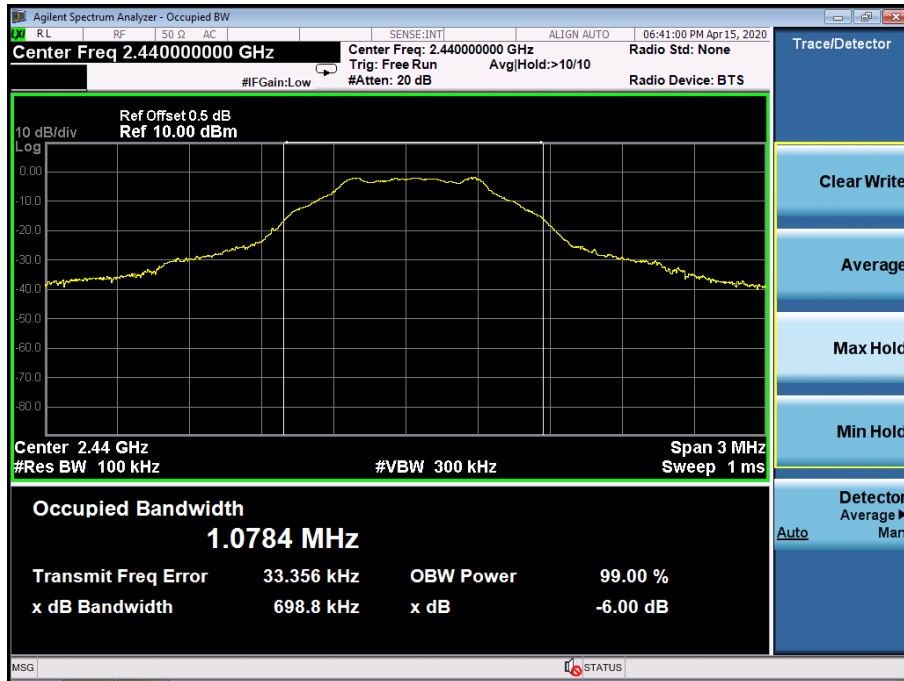

CH40

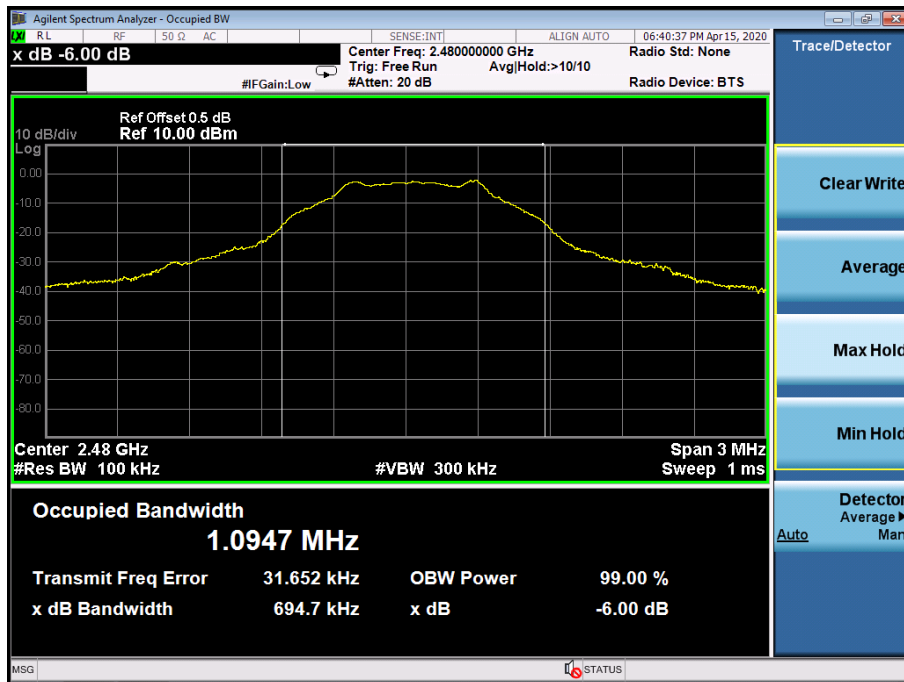



11. PEAK OUTPUT POWER TEST

11.1 Block Diagram Of Test Setup



11.2 Limit

FCC Part15 (15.247) , Subpart C				
Section	Test Item	Limit	Frequency Range (MHz)	Result
15.247(b)(3)	Peak Output Power	1 watt or 30dBm	2400-2483.5	PASS

11.3 Test procedure

- a. The EUT was directly connected to the Power meter

11.4 EUT operating Conditions

The EUT tested system was configured as the statements of 4.6 Unless otherwise a special operating condition is specified in the follows during the testing.

Note: Power Spectral Density(dBm)=Reading+Cable Loss



11.5 Test Result

Temperature :	26°C	Relative Humidity :	54%
Test Mode :	GFSK	Test Voltage :	DC 3.7V

	Frequency	<input type="checkbox"/> Maximum Conducted Output Power(PK)	Conducted Output Power Limit
	(MHz)	(dBm)	dBm
GFSK	2402	-0.42	30
	2440	-0.66	30
	2480	-1.23	30

12. 100 KHZ BANDWIDTH OF FREQUENCY BAND EDGE

12.1 Block Diagram Of Test Setup



12.2 Limit

In any 100 kHz bandwidth outside the frequency band in which the spread spectrum intentional radiator is operating, the radio frequency power that is produced by the intentional radiator shall be at least 20 dB below that in the 100 kHz bandwidth within the band that contains the highest level of the desired power, based on either an RF conducted or a radiated measurement.

12.3 Test procedure

Using the following spectrum analyzer setting:

- a) Set the RBW = 100KHz.
- b) Set the VBW = 300KHz.
- c) Sweep time = auto couple.
- d) Detector function = peak.
- e) Trace mode = max hold.
- f) Allow trace to fully stabilize..

12.4 EUT operating Conditions

The EUT tested system was configured as the statements of 4.6 Unless otherwise a special operating condition is specified in the follows during the testing.

Note: Power Spectral Density(dBm)=Reading+Cable Loss



12.5 Test Result

Temperature :	26°C	Relative Humidity :	54%
Test Mode :	GFSK	Test Voltage :	DC 3.7V

GFSK: Band Edge, Left Side

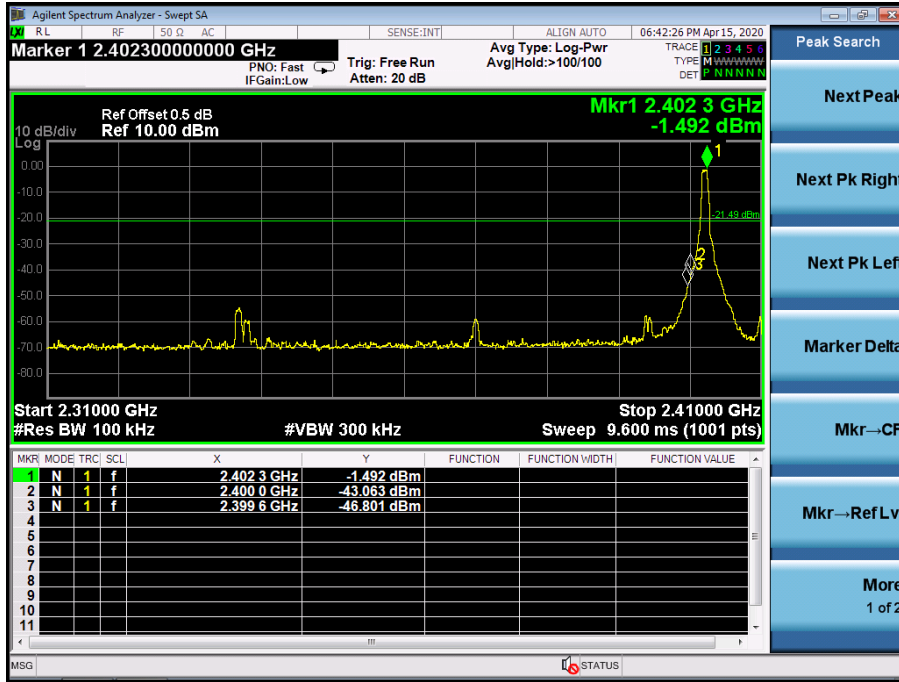

GFSK: Band Edge, Right Side

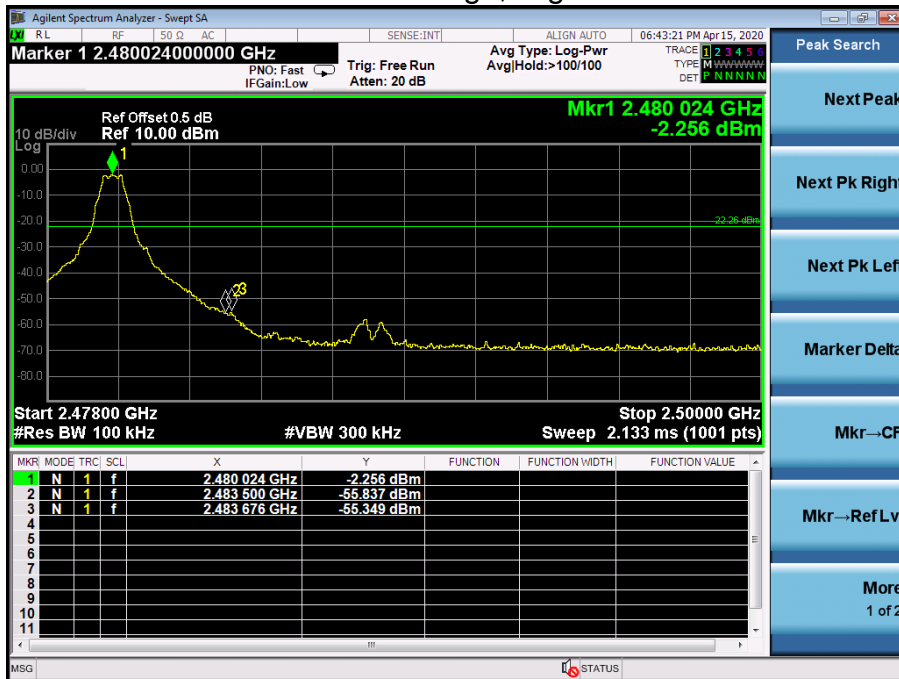



CONDUCTED EMISSION MEASUREMENT

GFSK Low Channel 2402MHz

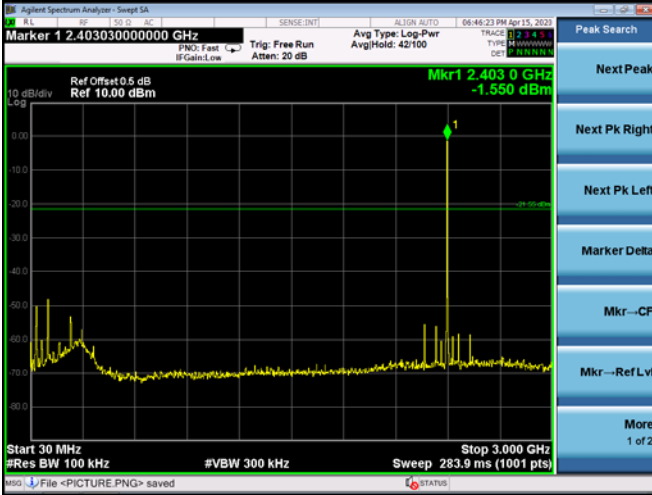

Middle Channel 2440MHz

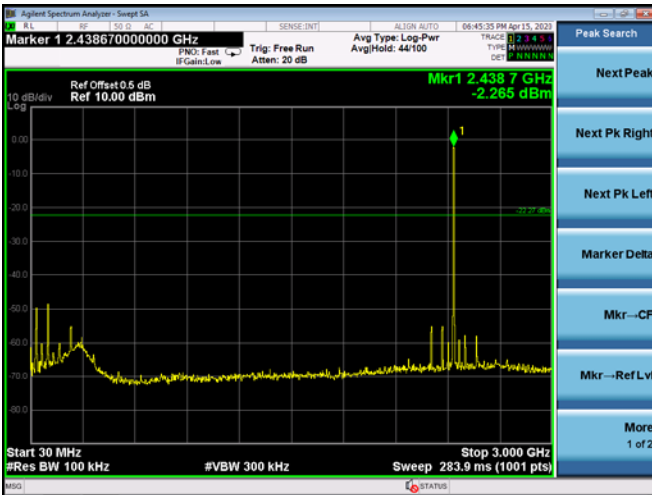

High Channel 2480MHz

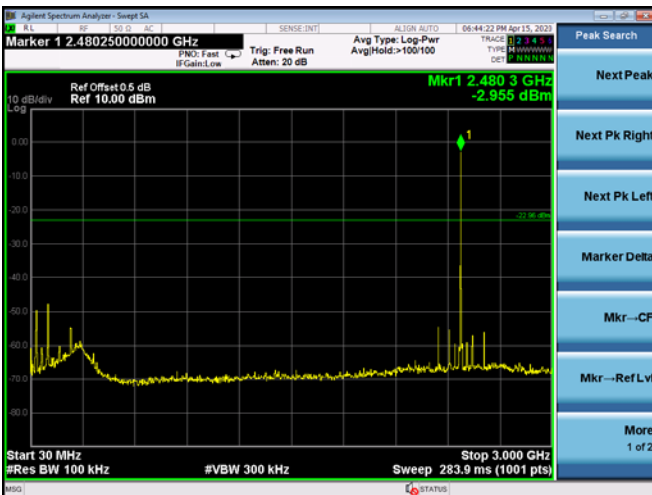



13. ANTENNA REQUIREMENT

13.2 Limit

15.203 requirement: For intentional device, according to 15.203: an intentional radiator shall be designed to ensure that no antenna other than that furnished by the responsible party shall be used with the device.

13.5 Test Result

The EUT antenna is PCB antenna, fulfill the requirement of this section.

14. EUT PHOTOGRAPHS

EUT Photo 1



EUT Photo 2



EUT Photo 3



EUT Photo 4





15. EUT TEST SETUP PHOTOGRAPHS

Conducted emissions





Radiated Measurement Photos

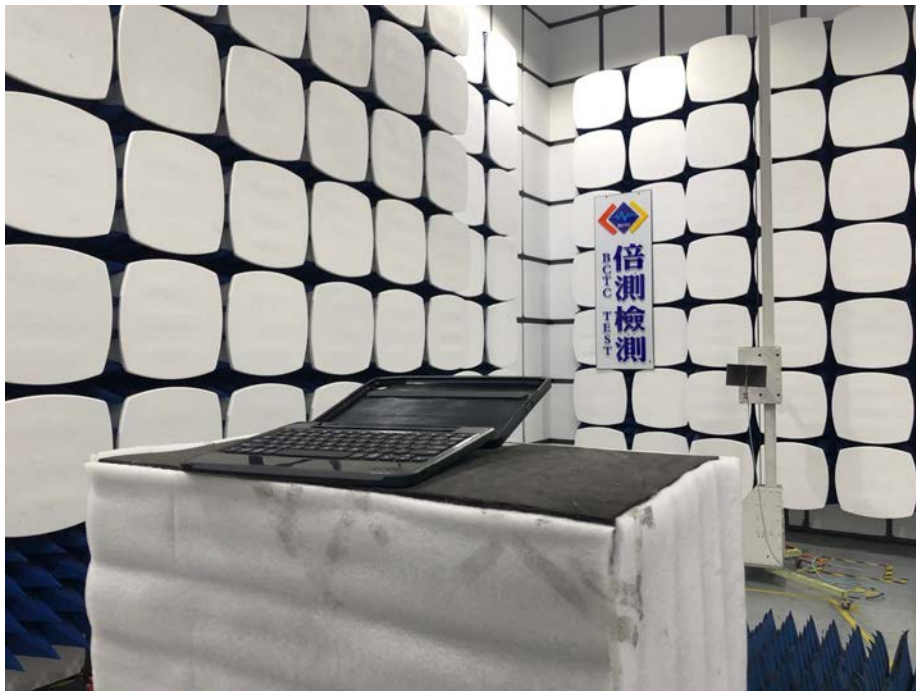

※※※※※ END OF REPORT ※※※※※