

# TEST REPORT

Report No.: BCTC2209869403E

---

Applicant: ZAGG Inc.

---

Product Name: Bluetooth Keyboard

---

Model/Type Ref.: ZKB105PKB34

---

Tested Date: 2022-09-16 to 2022-09-21

---

Issued Date: 2022-09-21

---

**Shenzhen BCTC Testing Co., Ltd.**



# FCC ID: QTG-ZKPIH

Product Name: Bluetooth Keyboard  
Trademark: ZAGG  
Model/Type Ref.: ZKB105PKB34  
Prepared For: ZAGG Inc.  
Address: 910 West Legacy Center Way, Midvale Utah 84047, United States  
Manufacturer: ZAGG Inc.  
Address: 910 West Legacy Center Way, Midvale Utah 84047, United States  
Prepared By: Shenzhen BCTC Testing Co., Ltd.  
Address: 1-2/F., Building B, Pengzhou Industrial Park, No.158, Fuyuan 1st Road, Zhancheng, Fuhai Subdistrict, Bao'an District, Shenzhen, Guangdong, China  
Sample Received Date: 2022-09-16  
Sample tested Date: 2022-09-16 to 2022-09-21  
Issue Date: 2022-09-21  
Report No.: BCTC2209869403E  
Test Standards: FCC Part15.247  
ANSI C63.10-2013  
Test Results: PASS  
Remark: This is Bluetooth BLE radio test report.

Tested by:



Lei Chen/Project Handler

Approved by:



Zero Zhou/Reviewer

*The test report is effective only with both signature and specialized stamp. This result(s) shown in this report refer only to the sample(s) tested. Without written approval of Shenzhen BCTC Testing Co., Ltd, this report can't be reproduced except in full. The tested sample(s) and the sample information are provided by the client.*

**TABLE OF CONTENT**

| Test Report Declaration                                | Page      |
|--|-----------|
| <b>1. VERSION</b> .....                                | <b>4</b>  |
| <b>2. TEST SUMMARY</b> .....                           | <b>5</b>  |
| <b>3. MEASUREMENT UNCERTAINTY</b> .....                | <b>6</b>  |
| <b>4. PRODUCT INFORMATION AND TEST SETUP</b> .....     | <b>7</b>  |
| 4.1 Product Information .....                          | 7         |
| 4.2 Test Setup Configuration .....                     | 8         |
| 4.3 Support Equipment .....                            | 8         |
| 4.4 Channel List .....                                 | 8         |
| 4.5 Test Mode .....                                    | 9         |
| 4.6 Copy of marking plate .....                        | 9         |
| <b>5. TEST FACILITY AND TEST INSTRUMENT USED</b> ..... | <b>10</b> |
| 5.1 Test Facility .....                                | 10        |
| 5.2 Test Instrument Used .....                         | 10        |
| <b>6. CONDUCTED EMISSIONS</b> .....                    | <b>11</b> |
| 6.1 Block Diagram Of Test Setup .....                  | 11        |
| 6.2 Limit .....  | 11        |
| 6.3 Test procedure .....                               | 11        |
| 6.4 EUT operating Conditions .....                     | 11        |
| 6.5 Test Result .....                                  | 12        |
| <b>7. RADIATED EMISSIONS</b> .....                     | <b>14</b> |
| 7.1 Block Diagram Of Test Setup .....                  | 14        |
| 7.2 Limit .....  | 15        |
| 7.3 Test procedure .....                               | 16        |
| 7.4 EUT operating Conditions .....                     | 18        |
| 7.5 Test Result .....                                  | 19        |
| <b>8. EUT PHOTOGRAPHS</b> .....                        | <b>22</b> |
| <b>9. EUT TEST SETUP PHOTOGRAPHS</b> .....             | <b>23</b> |

*(Note: N/A means not applicable)*

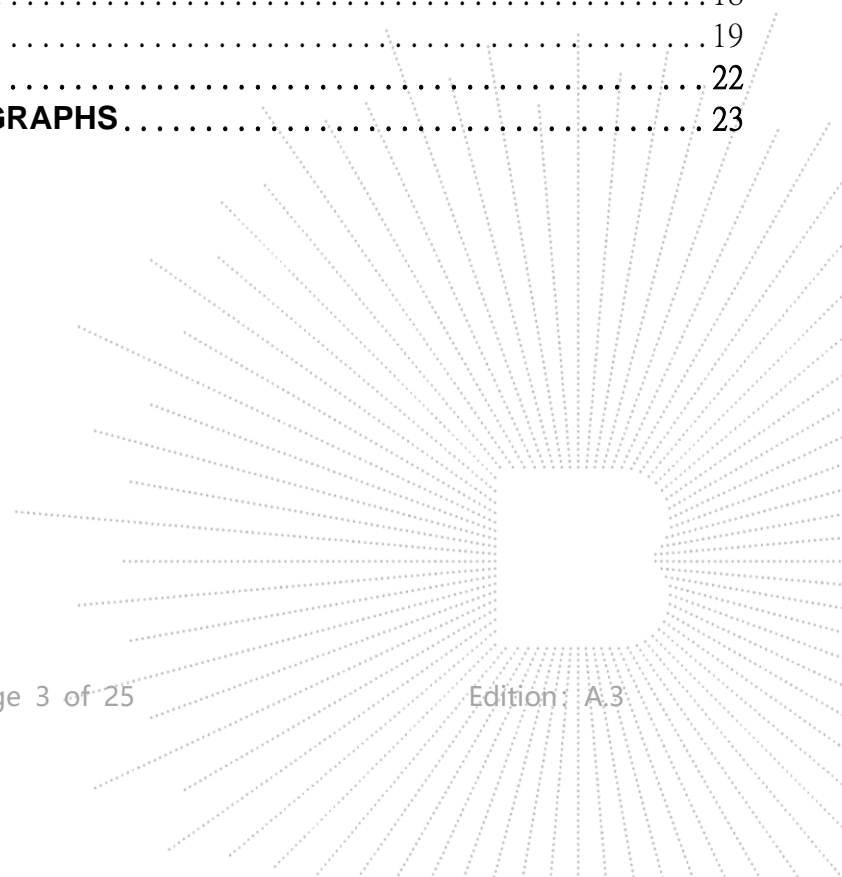

## 1. VERSION

| Report No.      | Issue Date | Description | Approved |
|-----------------|------------|-------------|----------|
| BCTC2209869403E | 2022-09-21 | Original    | Valid    |
|                 |            |             |          |

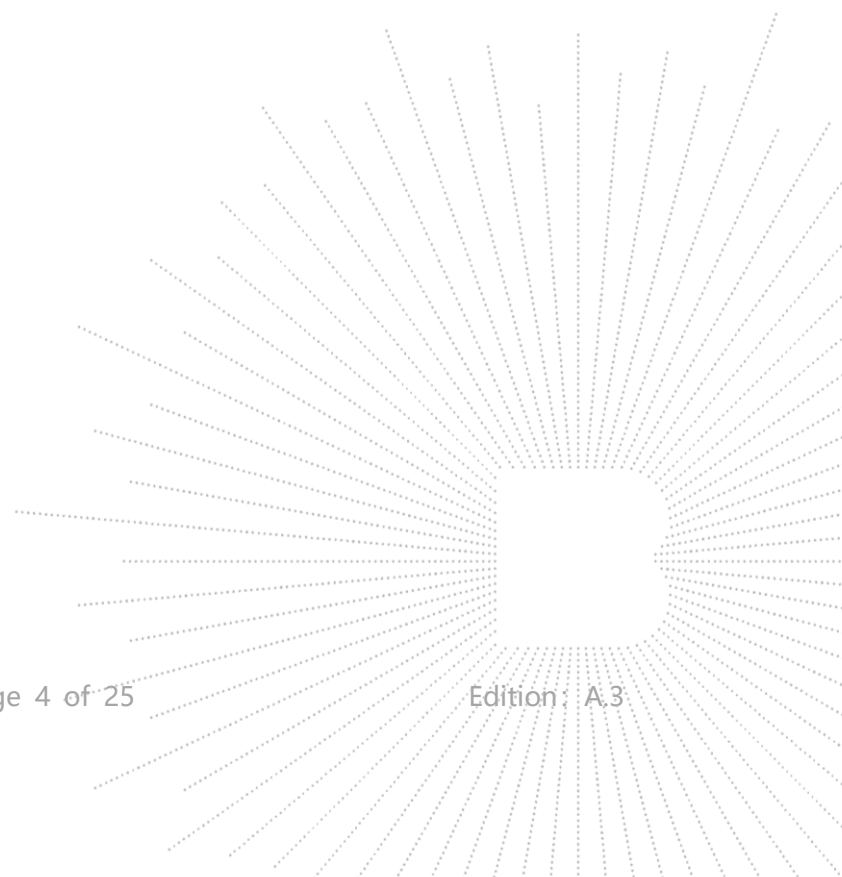

## 2. TEST SUMMARY

The Product has been tested according to the following specifications:

| No. | Test Parameter      | Clause No | Results |
|-----|---------------------|-----------|---------|
| 1   | Conducted emissions | 15.207    | PASS    |
| 2   | Radiated Emissions  | 15.209    | PASS    |

Remark: Only the appearance size is different, the RF chip remains unchanged.  
So the report is only updated Conducted emissions and Radiated Emissions for the original report (BCTC2105422625E)

Changes : 1. The new product size changes;

Original:

Model: ZKB102FBB34

Product size: 256.99\*187.52\*21.76mm

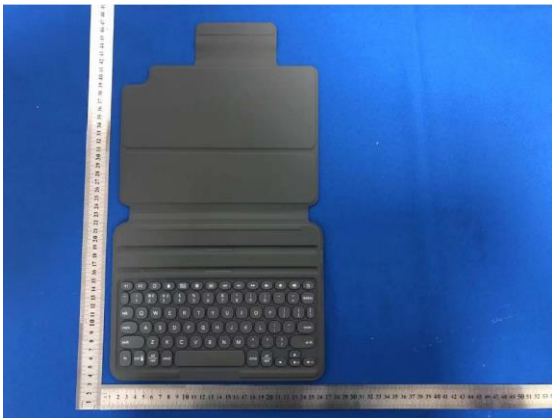

New:

Model: ZKB105PKB34

Product size: 254.99\*198.54\*21.76mm



### 3. MEASUREMENT UNCERTAINTY

Where relevant, the following measurement uncertainty levels have been estimated for tests performed on the Product as specified in CISPR 16-4-2. This uncertainty represents an expanded uncertainty expressed at approximately the 95% confidence level using a coverage factor of k=2.

| No. | Item                                | Uncertainty |
|-----|-------------------------------------|-------------|
| 1   | humidity uncertainty                | U=5.3%      |
| 2   | Temperature uncertainty             | U=0.59°C    |
| 3   | Conducted Emission (150kHz-30MHz)   | U=3.2dB     |
| 4   | Radiated disturbance(30MHz-1000MHz) | U=4.8dB     |
| 5   | Radiated disturbance(1GHz-6GHz)     | U=4.9dB     |
| 6   | Radiated disturbance(1GHz-18GHz)    | U=5.0dB     |

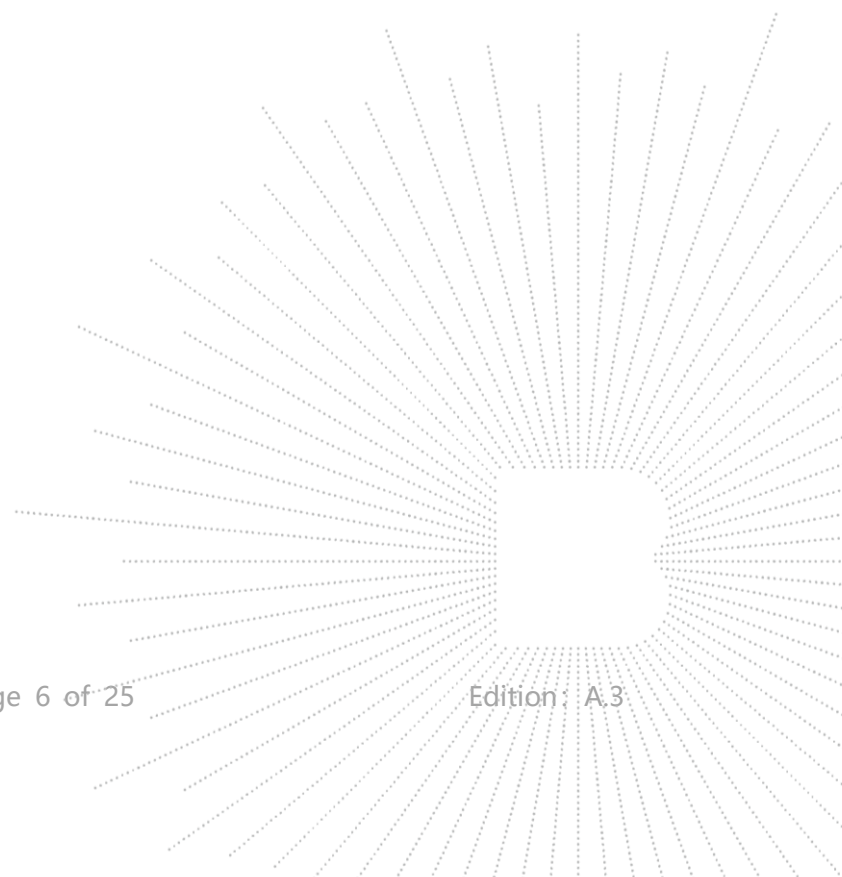

## 4. PRODUCT INFORMATION AND TEST SETUP

### 4.1 Product Information

|                       |  |
|-----------------------|--|
| Model/Type Ref.:      | ZKB105PKB34                                |
| Model differences:    | N/A  |
| Bluetooth Version:    | BT 5.0                                     |
| Hardware Version:     | V1.0                                       |
| Software Version:     | V1.0                                       |
| Operation Frequency:  | Bluetooth: 2402-2480MHz                    |
| Type of Modulation:   | Bluetooth: GFSK                            |
| Antenna installation: | Bluetooth: PCB antenna                     |
| Antenna Gain:         | Bluetooth:1.87dBi                          |
| Ratings:              | DC 3.7V from Battery<br>DC 5V from Adapter |

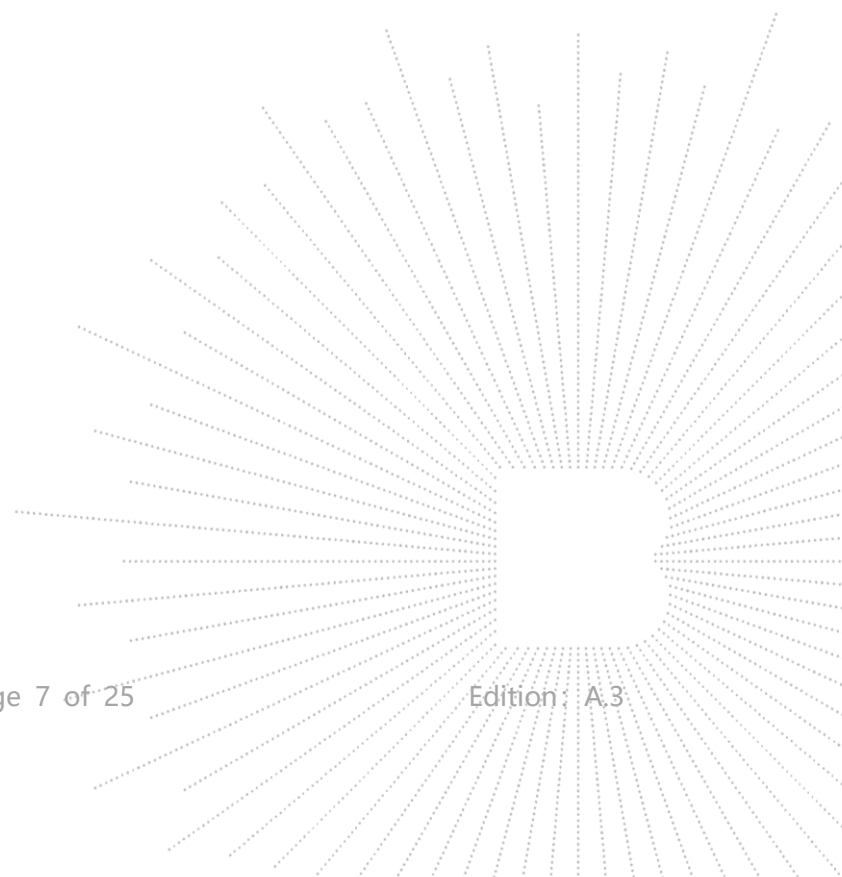

## 4.2 Test Setup Configuration

See test photographs attached in *EUT TEST SETUP PHOTOGRAPHS* for the actual connections between Product and support equipment.

Conducted Emission:

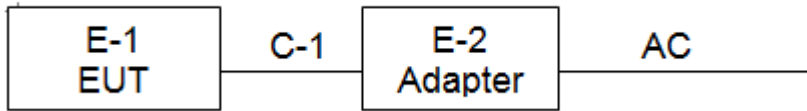

Radiated Spurious Emission

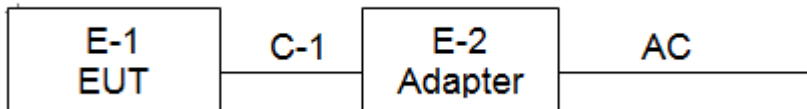

## 4.3 Support Equipment

| No. | Device Type        | Brand | Model       | Series No. | Data Cable | Power Cord |
|-----|--------------------|-------|-------------|------------|------------|------------|
| E-1 | Bluetooth Keyboard | ZAGG  | ZKB105PKB34 | N/A        | EUT        | E-1        |
| E-2 | Adapter            | N/A   | BCTC001     | N/A        | Auxiliary  | E-2        |

| Item | Shielded Type | Ferrite Core | Length | Note                |
|------|---------------|--------------|--------|---------------------|
| C-1  | NO            | NO           | 0.5M   | DC cable unshielded |

### Notes:

1. All the equipment/cables were placed in the worst-case configuration to maximize the emission during the test.
2. Grounding was established in accordance with the manufacturer's requirements and conditions for the intended use.

## 4.4 Channel List

| Channel List |                 |         |                 |         |                 |
|--------------|-----------------|---------|-----------------|---------|-----------------|
| Channel      | Frequency (MHz) | Channel | Frequency (MHz) | Channel | Frequency (MHz) |
| 01           | 2402            | 11      | 2422            | 21      | 2442            |
| 02           | 2404            | 12      | 2424            | 22      | 2444            |
| 03           | 2406            | 13      | 2426            | 23      | 2446            |
| ~            | ~               | ~       | ~               | ~       | ~               |
| 09           | 2418            | 19      | 2438            | 39      | 2478            |
| 10           | 2420            | 20      | 2440            | 40      | 2480            |



#### 4.5 Test Mode

| Test mode | Test mode   | Low channel | Middle channel | High channel |
|-----------|---|-------------|----------------|--------------|
| 1         | Link mode(conducted emission and Radiated emission) |             |                |              |

#### 4.6 Copy of marking plate

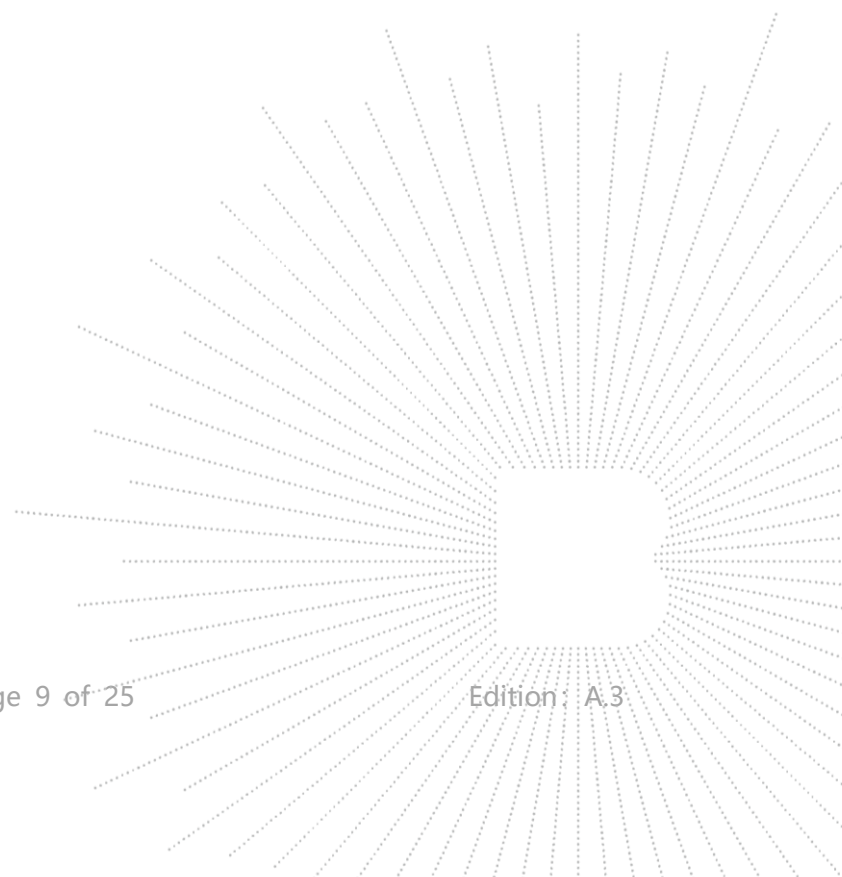
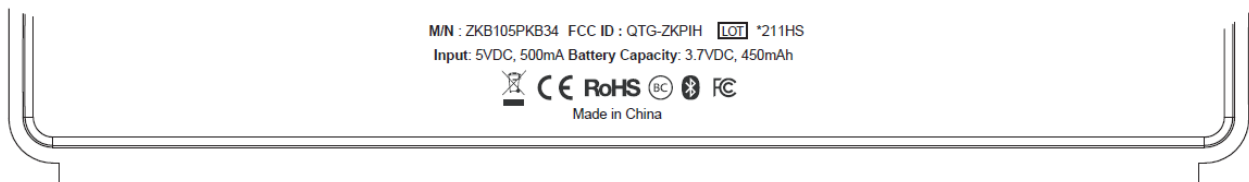

## 5. TEST FACILITY AND TEST INSTRUMENT USED

### 5.1 Test Facility

All measurement facilities used to collect the measurement data are located at Shenzhen BCTC Testing Co., Ltd. Address: 1-2/F., Building B, Pengzhou Industrial Park, No.158, Fuyuan 1st Road, Zhancheng, Fuhai Subdistrict, Bao'an District, Shenzhen, Guangdong, China. The site and apparatus are constructed in conformance with the requirements of ANSI C63.4 and CISPR 16-1-1 other equivalent standards.

### 5.2 Test Instrument Used

| Conducted Emissions Test |              |                 |                |              |              |
|--------------------------|--------------|-----------------|----------------|--------------|--------------|
| Equipment                | Manufacturer | Model#          | Serial#        | Last Cal.    | Next Cal.    |
| Receiver                 | R&S          | ESR3            | 102075         | May 24, 2022 | May 23, 2023 |
| LISN                     | R&S          | ENV216          | 101375         | May 24, 2022 | May 23, 2023 |
| Software                 | Frad         | EZ-EMC          | EMC-CON<br>3A1 | \            | \            |
| Attenuator               | \            | 10dB<br>DC-6GHz | 1650           | May 24, 2022 | May 23, 2023 |

| Radiated Emissions Test (966 Chamber#01) |              |                      |            |               |               |
|--|--------------|----------------------|------------|---------------|---------------|
| Equipment                                | Manufacturer | Model#               | Serial#    | Last Cal.     | Next Cal.     |
| 966 chamber                              | ChengYu      | 966 Room             | 966        | Jun. 06. 2020 | Jun. 05, 2023 |
| Receiver                                 | R&S          | ESRP                 | 101154     | May 24, 2022  | May 23, 2023  |
| Receiver                                 | R&S          | ESR3                 | 102075     | May 24, 2022  | May 23, 2023  |
| Amplifier                                | SKET         | LAPA_01G18<br>G-45dB | \          | May 24, 2022  | May 23, 2023  |
| Amplifier                                | Schwarzbeck  | BBV9744              | 9744-0037  | May 24, 2022  | May 23, 2023  |
| TRILOG<br>Broadband<br>Antenna           | schwarzbeck  | VULB9163             | 942        | May 26, 2022  | May 25, 2023  |
| Horn Antenna                             | schwarzbeck  | BBHA9120D            | 1541       | Jun. 06, 2022 | Jun. 06, 2023 |
| Software                                 | Frad         | EZ-EMC               | FA-03A2 RE | \             | \             |

## 6. CONDUCTED EMISSIONS

### 6.1 Block Diagram Of Test Setup

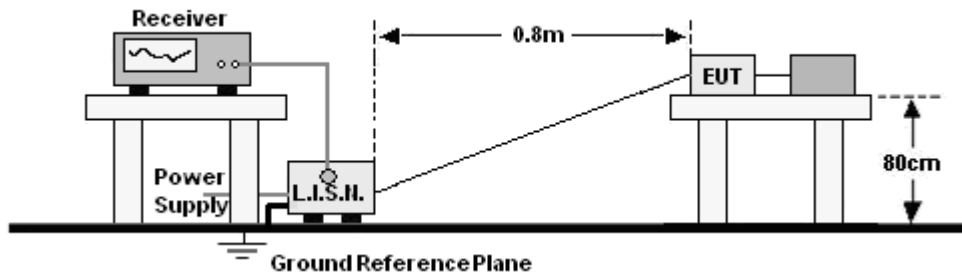

### 6.2 Limit

| FREQUENCY (MHz) | Limit (dBuV) |           |
|-----------------|--------------|-----------|
|                 | Quas-peak    | Average   |
| 0.15 -0.5       | 66 - 56 *    | 56 - 46 * |
| 0.50 -5.0       | 56.00        | 46.00     |
| 5.0 -30.0       | 60.00        | 50.00     |

Notes:  
 1. \*Decreasing linearly with logarithm of frequency.  
 2. The lower limit shall apply at the transition frequencies.

### 6.3 Test procedure

| Receiver Parameters | Setting  |
|---------------------|----------|
| Attenuation         | 10 dB    |
| Start Frequency     | 0.15 MHz |
| Stop Frequency      | 30 MHz   |
| IF Bandwidth        | 9 kHz    |

a. The Product was placed on a nonconductive table 0.8 m above the horizontal ground reference plane, and 0.4 m from the vertical ground reference plane, and connected to the main through Line Impedance Stability Network (L.I.S.N).

b. The RBW of the receiver was set at 9 kHz in 150 kHz ~ 30MHz with Peak and AVG detector in Max Hold mode. Run the receiver's pre-scan to record the maximum disturbance generated from Product in all power lines in the full band.

c. For each frequency whose maximum record was higher or close to limit, measure its QP and AVG values and record.

### 6.4 EUT operating Conditions

The EUT was configured for testing in a typical fashion (as a customer would normally use it). The EUT has been programmed to continuously transmit during test. This operating condition was tested and used to collect the included data.

## 6.5 Test Result

|                |             |                    |        |
|----------------|-------------|--------------------|--------|
| Temperature:   | 26 °C       | Relative Humidity: | 54%    |
| Pressure:      | 101kPa      | Phase :            | Line   |
| Test Voltage : | AC120V/60Hz | Test Mode:         | Mode 1 |

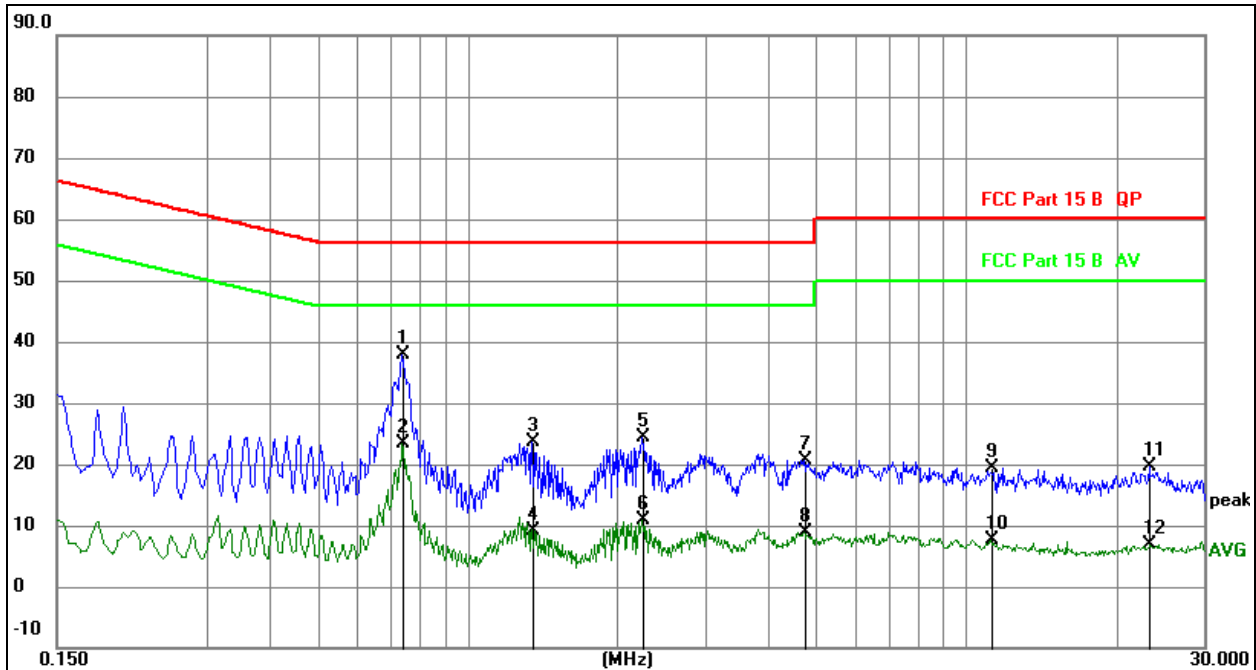

### Remark:

1. All readings are Quasi-Peak and Average values.
2. Factor = Insertion Loss + Cable Loss.
3. Measurement = Reading Level + Correct Factor
4. Over = Measurement - Limit

| No. | Mk. | Freq.<br>MHz | Reading<br>Level<br>dB | Correct<br>Factor<br>dB | Measure-<br>ment<br>dBuV | Limit<br>dBuV | Over<br>dB | Detector |
|-----|-----|--------------|------------------------|-------------------------|--------------------------|---------------|------------|----------|
| 1   | *   | 0.7395       | 18.07                  | 19.74                   | 37.81                    | 56.00         | -18.19     | QP       |
| 2   |     | 0.7395       | 3.59                   | 19.74                   | 23.33                    | 46.00         | -22.67     | AVG      |
| 3   |     | 1.3470       | 3.83                   | 19.80                   | 23.63                    | 56.00         | -32.37     | QP       |
| 4   |     | 1.3470       | -10.57                 | 19.80                   | 9.23                     | 46.00         | -36.77     | AVG      |
| 5   |     | 2.2380       | 4.51                   | 19.91                   | 24.42                    | 56.00         | -31.58     | QP       |
| 6   |     | 2.2380       | -9.01                  | 19.91                   | 10.90                    | 46.00         | -35.10     | AVG      |
| 7   |     | 4.7265       | 0.58                   | 20.12                   | 20.70                    | 56.00         | -35.30     | QP       |
| 8   |     | 4.7265       | -11.12                 | 20.12                   | 9.00                     | 46.00         | -37.00     | AVG      |
| 9   |     | 11.2290      | -0.99                  | 20.28                   | 19.29                    | 60.00         | -40.71     | QP       |
| 10  |     | 11.2290      | -12.60                 | 20.28                   | 7.68                     | 50.00         | -42.32     | AVG      |
| 11  |     | 23.2665      | -0.80                  | 20.52                   | 19.72                    | 60.00         | -40.28     | QP       |
| 12  |     | 23.2665      | -13.53                 | 20.52                   | 6.99                     | 50.00         | -43.01     | AVG      |

|                |             |                    |         |
|----------------|-------------|--------------------|---------|
| Temperature:   | 26 °C       | Relative Humidity: | 54%     |
| Pressure:      | 101kPa      | Phase :            | Neutral |
| Test Voltage : | AC120V/60Hz | Test Mode:         | Mode 1  |

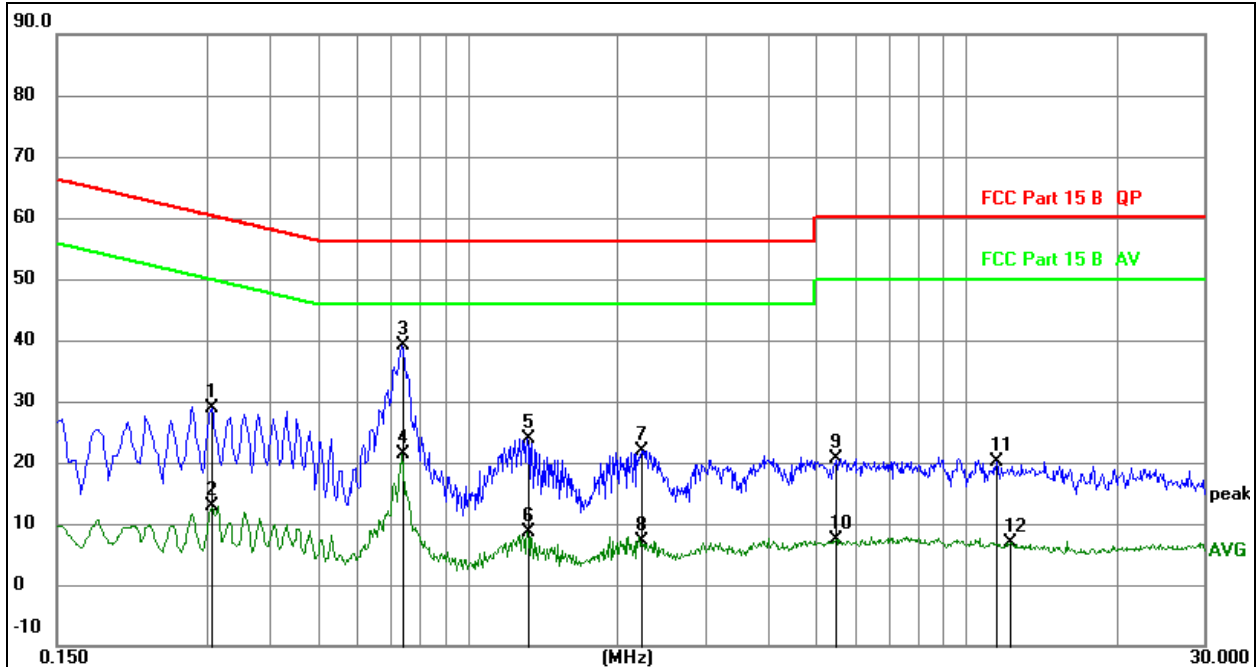
**Remark:**

1. All readings are Quasi-Peak and Average values.
2. Factor = Insertion Loss + Cable Loss.
3. Measurement = Reading Level + Correct Factor
4. Over = Measurement - Limit

| No. | Mk. | Freq.<br>MHz | Reading<br>Level | Correct<br>Factor<br>dB | Measure-<br>ment<br>dBuV | Limit<br>dBuV | Over<br>dB | Detector |
|-----|-----|--------------|------------------|-------------------------|--------------------------|---------------|------------|----------|
| 1   |     | 0.3067       | 9.16             | 19.77                   | 28.93                    | 60.06         | -31.13     | QP       |
| 2   |     | 0.3067       | -6.86            | 19.77                   | 12.91                    | 50.06         | -37.15     | AVG      |
| 3   | *   | 0.7391       | 19.45            | 19.74                   | 39.19                    | 56.00         | -16.81     | QP       |
| 4   |     | 0.7391       | 1.65             | 19.74                   | 21.39                    | 46.00         | -24.61     | AVG      |
| 5   |     | 1.3168       | 4.02             | 19.80                   | 23.82                    | 56.00         | -32.18     | QP       |
| 6   |     | 1.3168       | -11.17           | 19.80                   | 8.63                     | 46.00         | -37.37     | AVG      |
| 7   |     | 2.2367       | 2.07             | 19.91                   | 21.98                    | 56.00         | -34.02     | QP       |
| 8   |     | 2.2367       | -12.90           | 19.91                   | 7.01                     | 46.00         | -38.99     | AVG      |
| 9   |     | 5.4763       | 0.57             | 20.14                   | 20.71                    | 60.00         | -39.29     | QP       |
| 10  |     | 5.4763       | -12.68           | 20.14                   | 7.46                     | 50.00         | -42.54     | AVG      |
| 11  |     | 11.4983      | -0.23            | 20.28                   | 20.05                    | 60.00         | -39.95     | QP       |
| 12  |     | 12.2531      | -13.45           | 20.28                   | 6.83                     | 50.00         | -43.17     | AVG      |

## 7. RADIATED EMISSIONS

### 7.1 Block Diagram Of Test Setup

#### (A) Radiated Emission Test-Up Frequency Below 30MHz

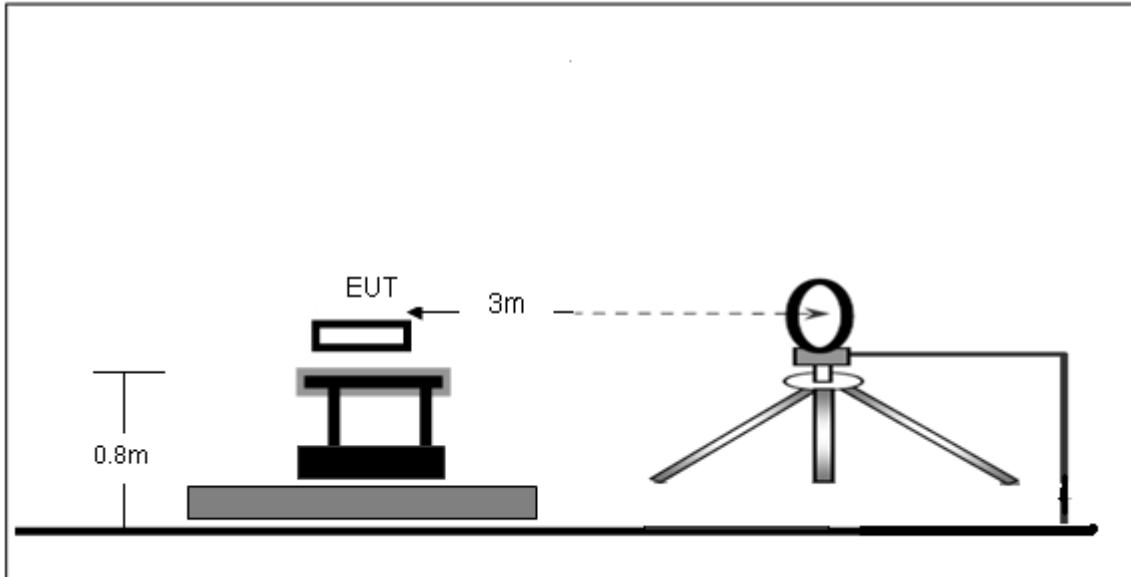

#### (B) Radiated Emission Test-Up Frequency 30MHz~1GHz

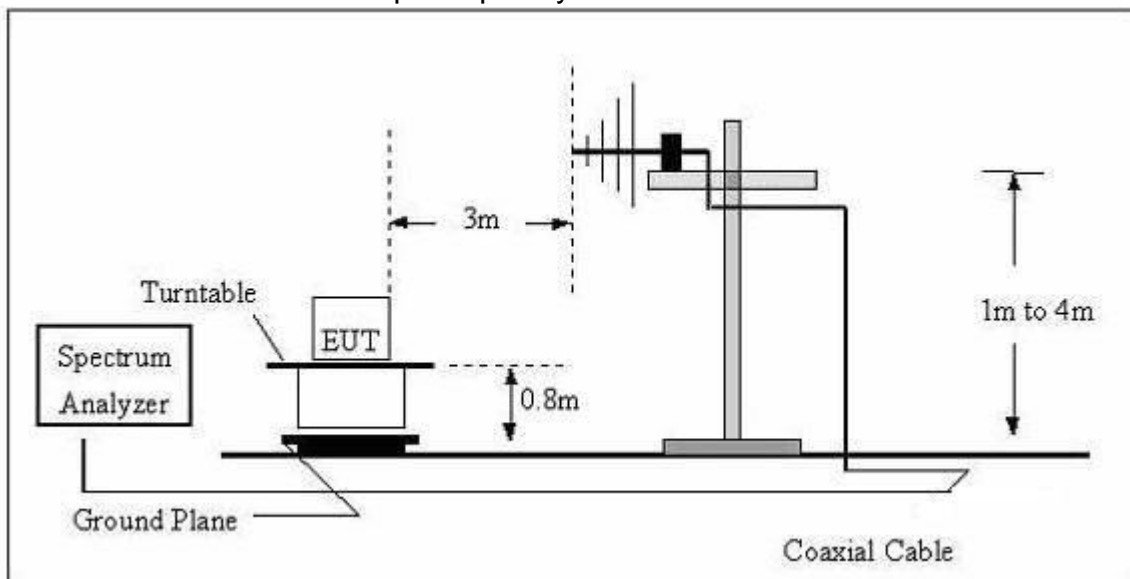

## (C) Radiated Emission Test-Up Frequency Above 1GHz

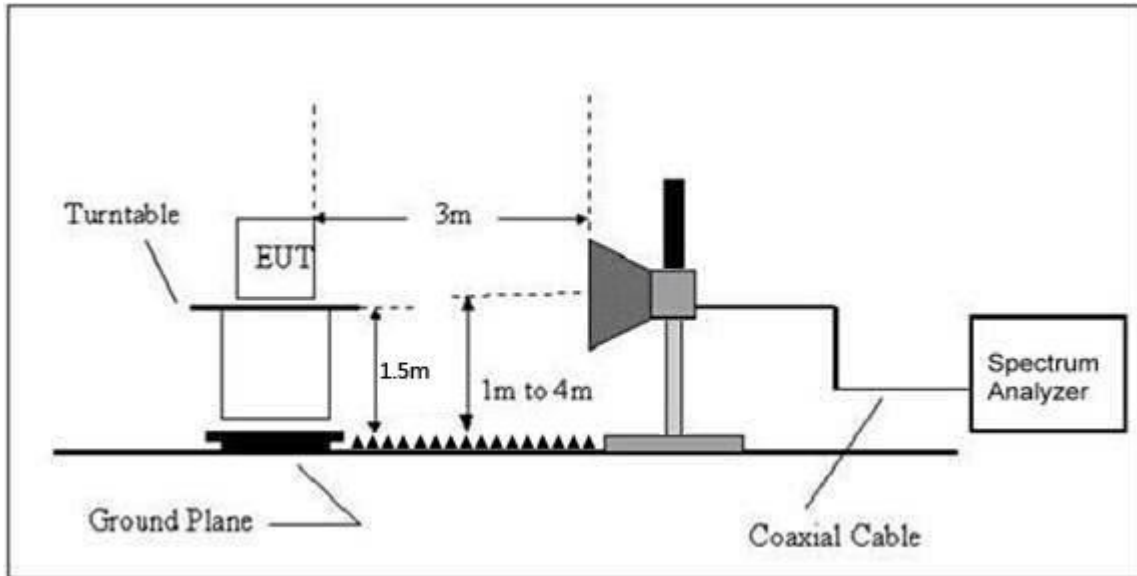

## 7.2 Limit

20dBc in any 100 kHz bandwidth outside the operating frequency band. In case the emission fall within the restricted band specified on 15.205(a), then the 15.209(a) limit in the table below has to be followed.

| Frequency<br>(MHz) | Field Strength<br>uV/m | Distance<br>(m) | Field Strength Limit at 3m Distance |                                       |
|--------------------|------------------------|-----------------|-------------------------------------|---------------------------------------|
|                    |                        |                 | uV/m                                | dBuV/m                                |
| 0.009 ~ 0.490      | 2400/F(kHz)            | 300             | $10000 * 2400/F(\text{kHz})$        | $20\log^{(2400/F(\text{kHz}))} + 80$  |
| 0.490 ~ 1.705      | 24000/F(kHz)           | 30              | $100 * 24000/F(\text{kHz})$         | $20\log^{(24000/F(\text{kHz}))} + 40$ |
| 1.705 ~ 30         | 30                     | 30              | $100 * 30$                          | $20\log^{(30)} + 40$                  |
| 30 ~ 88            | 100                    | 3               | 100                                 | $20\log^{(100)}$                      |
| 88 ~ 216           | 150                    | 3               | 150                                 | $20\log^{(150)}$                      |
| 216 ~ 960          | 200                    | 3               | 200                                 | $20\log^{(200)}$                      |
| Above 960          | 500                    | 3               | 500                                 | $20\log^{(500)}$                      |

### LIMITS OF RADIATED EMISSION MEASUREMENT (Above 1000MHz)

| FREQUENCY<br>Y (MHz) | Limit (dBuV/m) (at 3M) |         |
|----------------------|------------------------|---------|
|                      | PEAK                   | AVERAGE |
| Above 1000           | 74                     | 54      |

#### Notes:

- (1)The limit for radiated test was performed according to FCC PART 15C.
- (2)The tighter limit applies at the band edges.
- (3) Emission level (dBuV/m)=20log Emission level (uV/m).



**FREQUENCY RANGE OF RADIATED MEASUREMENT (For unintentional radiators)**

| Highest frequency generated or Upper frequency of measurement used in the device or on which the device operates or tunes (MHz) | Range (MHz)   |
|---|---|
| Below 1.705   | 30  |
| 1.705 – 108   | 1000  |
| 108 – 500   | 2000  |
| 500 – 1000  | 5000  |
| Above 1000  | 5 <sup>th</sup> harmonic of the highest frequency or 40 GHz, whichever is lower |

**7.3 Test procedure**

| Receiver Parameter | Setting           |
|--------------------|-------------------|
| Attenuation        | Auto              |
| 9kHz~150kHz        | RBW 200Hz for QP  |
| 150kHz~30MHz       | RBW 9kHz for QP   |
| 30MHz~1000MHz      | RBW 120kHz for QP |

| Spectrum Parameter | Setting  |
|--------------------|--|
| 1-25GHz            | RBW 1 MHz /VBW 1 MHz for Peak,<br>RBW 1 MHz / VBW 10Hz for Average |

Below 1GHz test procedure as below:

- a. The EUT was placed on the top of a rotating table 0.8 meters above the ground at a 3 meter semi-anechoic chamber. The table was rotated 360 degrees to determine the position of the highest radiation.
- b. The EUT was set 3 meters away from the interference-receiving antenna, which was mounted on the top of a variable-height antenna tower.
- c. The antenna height is varied from one meter to four meters above the ground to determine the maximum value of the field strength. Both horizontal and vertical polarizations of the antenna are set to make the measurement.
- d. For each suspected emission, the EUT was arranged to its worst case and then the antenna was tuned to heights from 1 meter to 4 meters (for the test frequency of below 30MHz, the antenna was tuned to heights 1 meter) and the rotatable table was turned from 0 degrees to 360 degrees to find the maximum reading.
- e. The test-receiver system was set to Peak Detect Function and Specified Bandwidth with Maximum Hold Mode.



f. If the emission level of the EUT in peak mode was 10dB lower than the limit specified, then testing could be stopped and the peak values of the EUT would be reported. Otherwise the emissions that did not have 10dB margin would be re-tested one by one using peak, quasi-peak or average method as specified and then reported in a data sheet.

Above 1GHz test procedure as below:

g. Different between above is the test site, change from Semi- Anechoic Chamber to fully Anechoic Chamber and change form table 0.8 metre to 1.5 metre( Above 18GHz the distance is 1 meter and table is 1.5 metre).

h. Test the EUT in the lowest channel, the middle channel, the Highest channel.

Note:

Both horizontal and vertical antenna polarities were tested and performed pretest to three orthogonal axis. The worst case emissions were reported.

Above 1GHz test procedure as below:

a.The EUT was placed on the top of a rotating table 1.5 meters above the ground at a 3 meter camber. The table was rotated 360 degrees to determine the position of the highest radiation.

b.The EUT was set 3 meters away from the interference-receiving antenna, which was mounted on the top of a variable-height antenna tower.

c.The antenna height is varied from one meter to four meters above the ground to determine the maximum value of the field strength. Both horizontal and vertical polarizations of the antenna are set to make the measurement.

d.For each suspected emission, the EUT was arranged to its worst case and then the antenna was tuned to heights from 1 meter to 4 meters and the rota table was turned from 0 degrees to 360 degrees to find the maximum reading.

e.The test-receiver system was set to Peak Detect Function and Specified Bandwidth with Maximum Hold Mode.

f. If the emission level of the EUT in peak mode was 10dB lower than the limit specified, then testing could be stopped and the peak values of the EUT would be reported. Otherwise the emissions that did not have 10dB margin would be re-tested one by one using peak, quasi-peak or average method as specified and then reported in a data sheet.

g.Test the EUT in the lowest channel, the Highest channel.

Note:

Both horizontal and vertical antenna polarities were tested and performed pretest to three orthogonal axis. The worst case emissions were reported.

## 7.4 EUT operating Conditions

The EUT was configured for testing in a typical fashion (as a customer would normally use it). The EUT has been programmed to continuously transmit during test. This operating condition was tested and used to collect the included data.

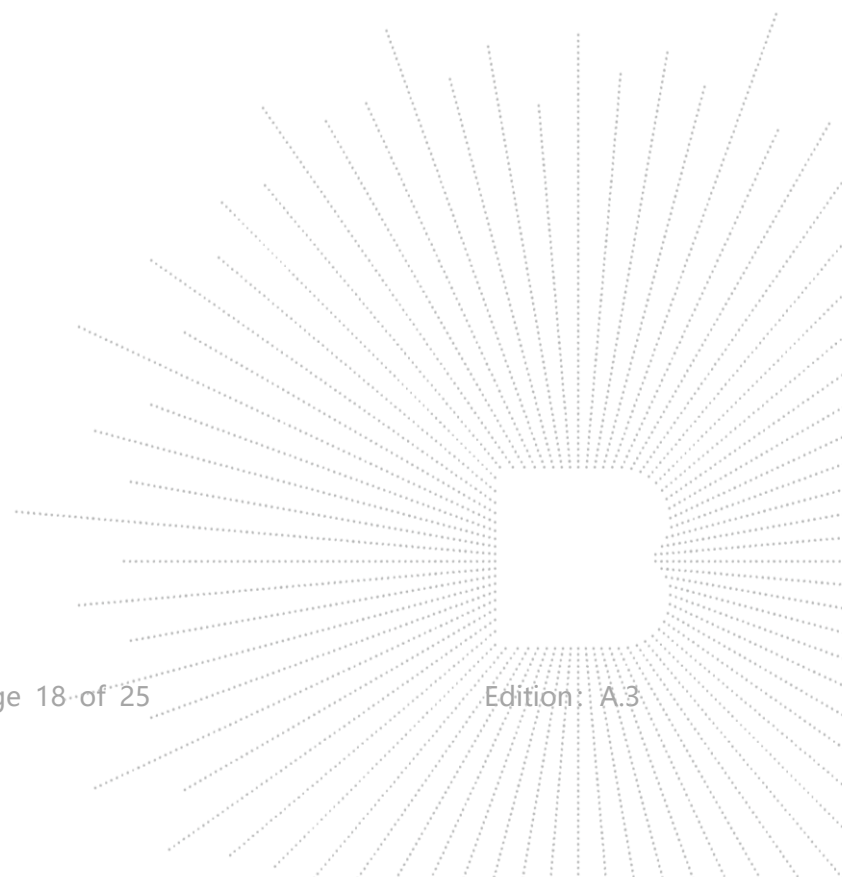

## 7.5 Test Result

Below 30MHz

|              |         |                    |              |
|--------------|---------|--------------------|--------------|
| Temperature: | 26°C    | Relative Humidity: | 54%          |
| Pressure:    | 101 kPa | Test Voltage :     | AC 120V/60Hz |
| Test Mode :  | Mode 1  | Polarization :     | --           |

| Freq. | Reading  | Limit    | Margin | State |
|-------|----------|----------|--------|-------|
| (MHz) | (dBuV/m) | (dBuV/m) | (dB)   | P/F   |
| --    | --       | --       | --     | PASS  |
| --    | --       | --       | --     | PASS  |

**Note:**

The amplitude of spurious emissions which are attenuated by more than 20dB below the permissible value has no need to be reported.

Distance extrapolation factor =  $40 \log(\text{specific distance}/\text{test distance})$ (dB);

Limit line = specific limits(dBuv) + distance extrapolation factor.

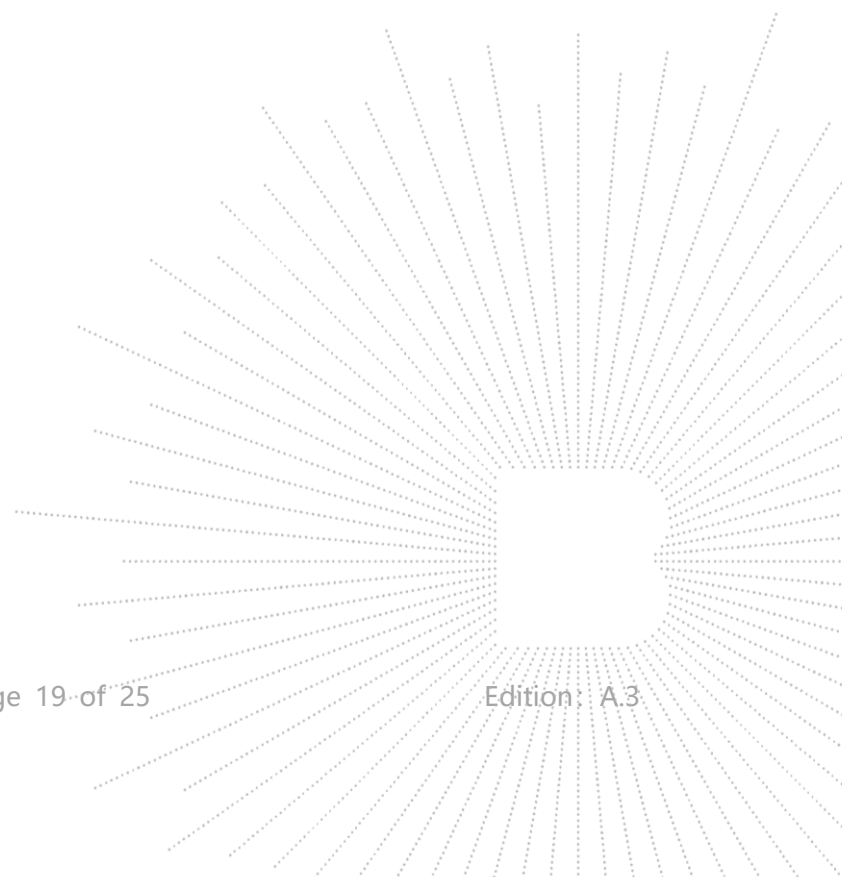

## Between 30MHz – 1GHz

|                |              |                    |            |
|----------------|--------------|--------------------|------------|
| Temperature:   | 26 °C        | Relative Humidity: | 54%        |
| Pressure:      | 101KPa       | Phase :            | Horizontal |
| Test Voltage : | AC 120V/60Hz | Test Mode:         | Mode 1     |

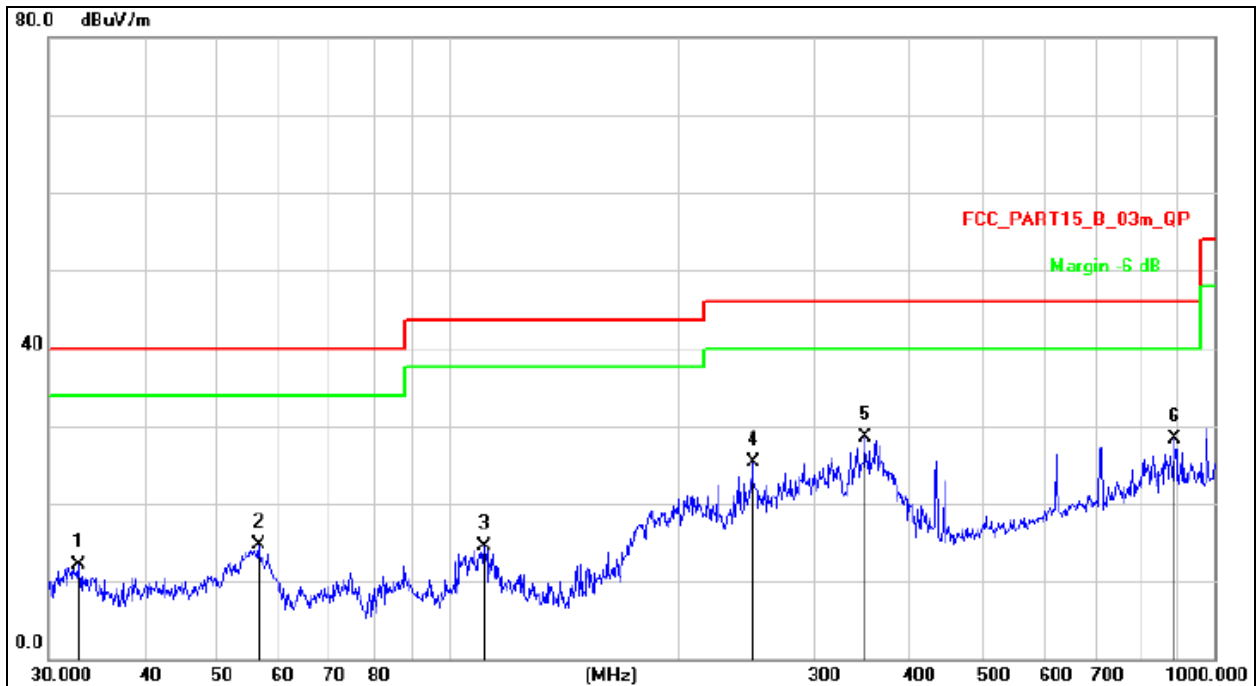

## Remark:

1. Factor = Antenna Factor + Cable Loss – Pre-amplifier.
2. Measurement = Reading Level + Correct Factor
3. Over = Measurement - Limit

| No. | Mk. | Freq.<br>MHz | Reading<br>Level<br>dBuV | Correct<br>Factor<br>dB | Measure-<br>ment<br>dBuV/m | Limit<br>dB/m | Over<br>dB | Detector |
|-----|-----|--------------|--------------------------|-------------------------|----------------------------|---------------|------------|----------|
| 1   |     | 32.8637      | 29.74                    | -17.61                  | 12.13                      | 40.00         | -27.87     | QP       |
| 2   |     | 56.3948      | 30.77                    | -16.12                  | 14.65                      | 40.00         | -25.35     | QP       |
| 3   |     | 111.3468     | 32.00                    | -17.44                  | 14.56                      | 43.50         | -28.94     | QP       |
| 4   |     | 249.4250     | 39.53                    | -14.21                  | 25.32                      | 46.00         | -20.68     | QP       |
| 5   | *   | 349.2500     | 39.37                    | -10.96                  | 28.41                      | 46.00         | -17.59     | QP       |
| 6   |     | 887.6099     | 29.45                    | -1.05                   | 28.40                      | 46.00         | -17.60     | QP       |

|                |              |                    |          |
|----------------|--------------|--------------------|----------|
| Temperature:   | 26 °C        | Relative Humidity: | 54%      |
| Pressure:      | 101KPa       | Phase :            | Vertical |
| Test Voltage : | AC 120V/60Hz | Test Mode:         | Mode 1   |

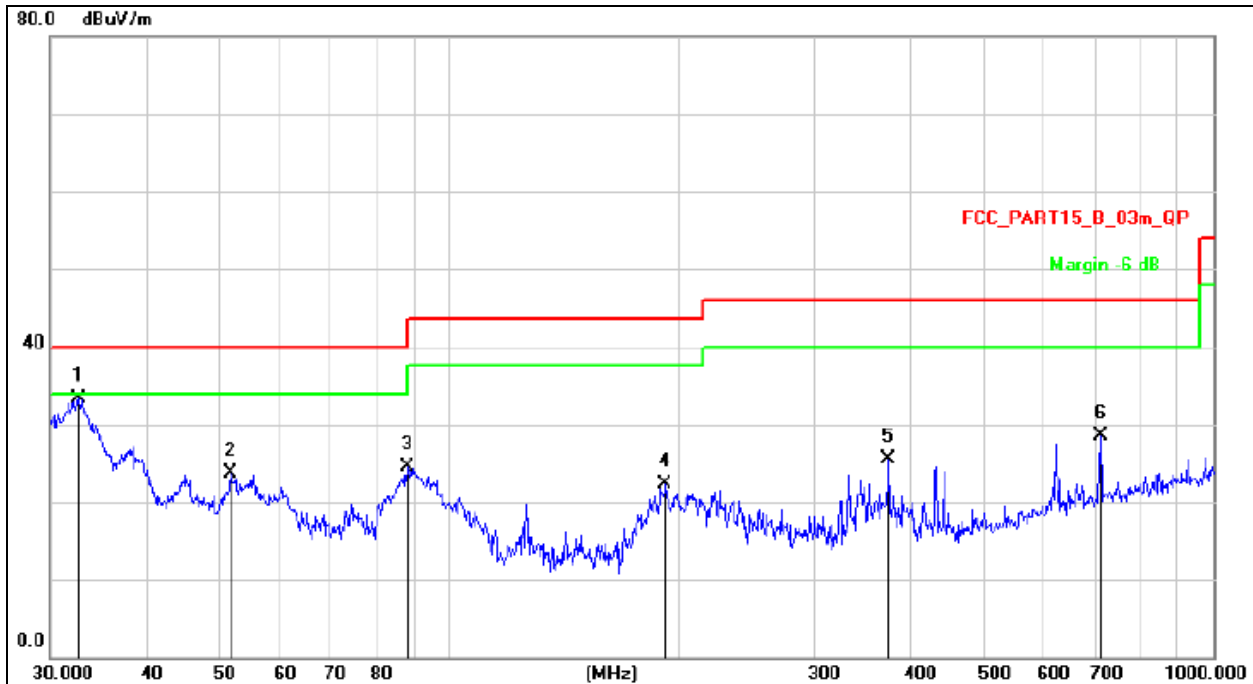

Remark:

1. Factor = Antenna Factor + Cable Loss – Pre-amplifier.
2. Measurement = Reading Level + Correct Factor
3. Over = Measurement - Limit

| No. | Mk. | Freq.    | Reading Level | Correct Factor | Measurement | Limit | Over   | Detector |
|-----|-----|----------|---------------|----------------|-------------|-------|--------|----------|
|     |     | MHz      | dBuV          | dB             | dBuV/m      | dB/m  | dB     |          |
| 1   | *   | 32.6340  | 50.99         | -17.66         | 33.33       | 40.00 | -6.67  | QP       |
| 2   |     | 51.6616  | 39.09         | -15.32         | 23.77       | 40.00 | -16.23 | QP       |
| 3   |     | 88.0329  | 43.33         | -18.81         | 24.52       | 43.50 | -18.98 | QP       |
| 4   |     | 191.7450 | 38.87         | -16.60         | 22.27       | 43.50 | -21.23 | QP       |
| 5   |     | 375.9385 | 35.91         | -10.49         | 25.42       | 46.00 | -20.58 | QP       |
| 6   |     | 711.6734 | 32.31         | -3.86          | 28.45       | 46.00 | -17.55 | QP       |

## 8. EUT PHOTOGRAPHS

EUT Photo 1



EUT Photo 2

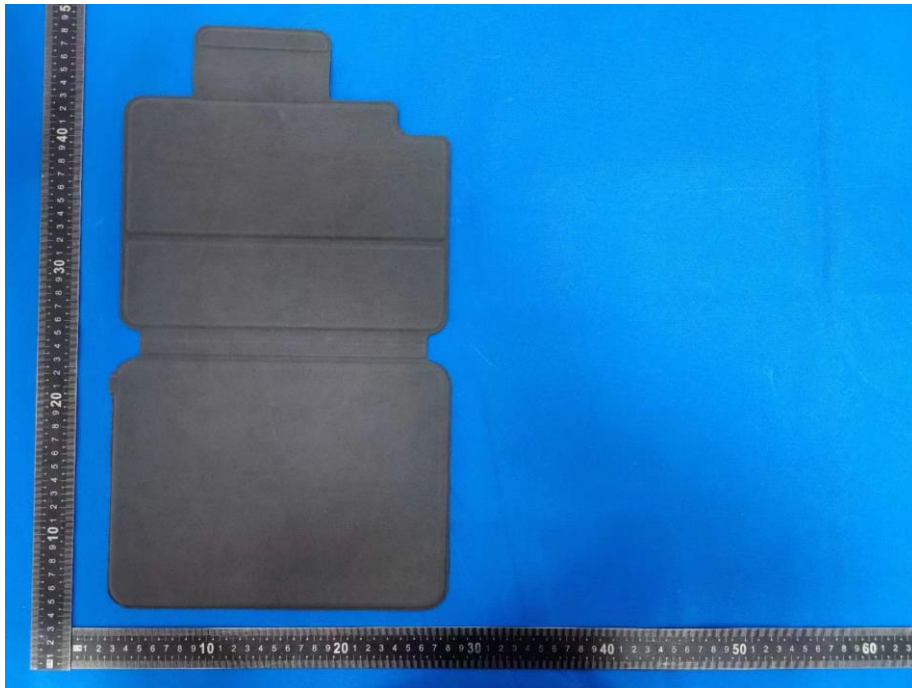



## 9. EUT TEST SETUP PHOTOGRAPHS

### Conducted emissions



### Radiated emission

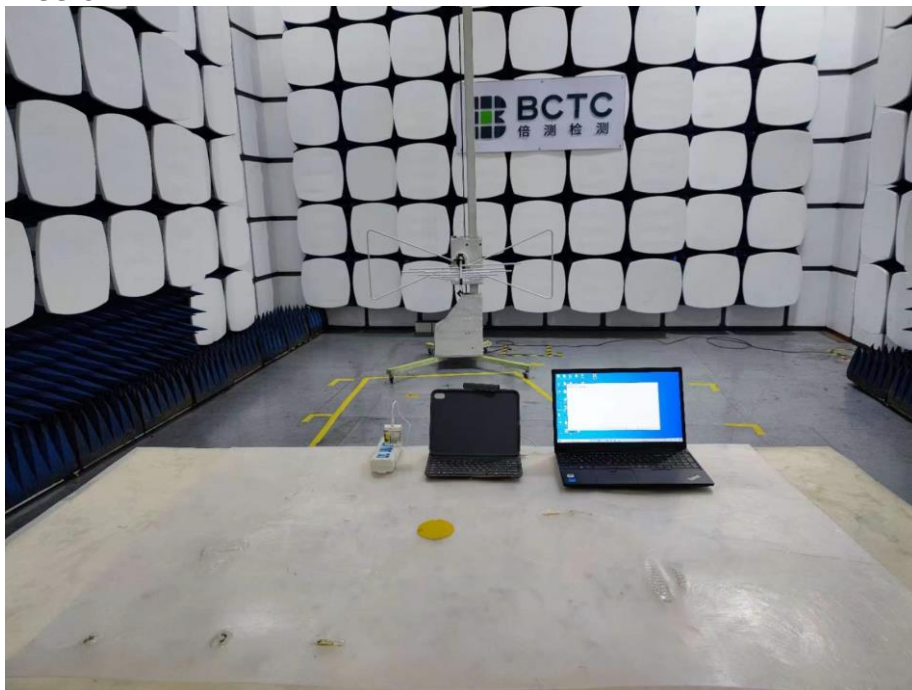

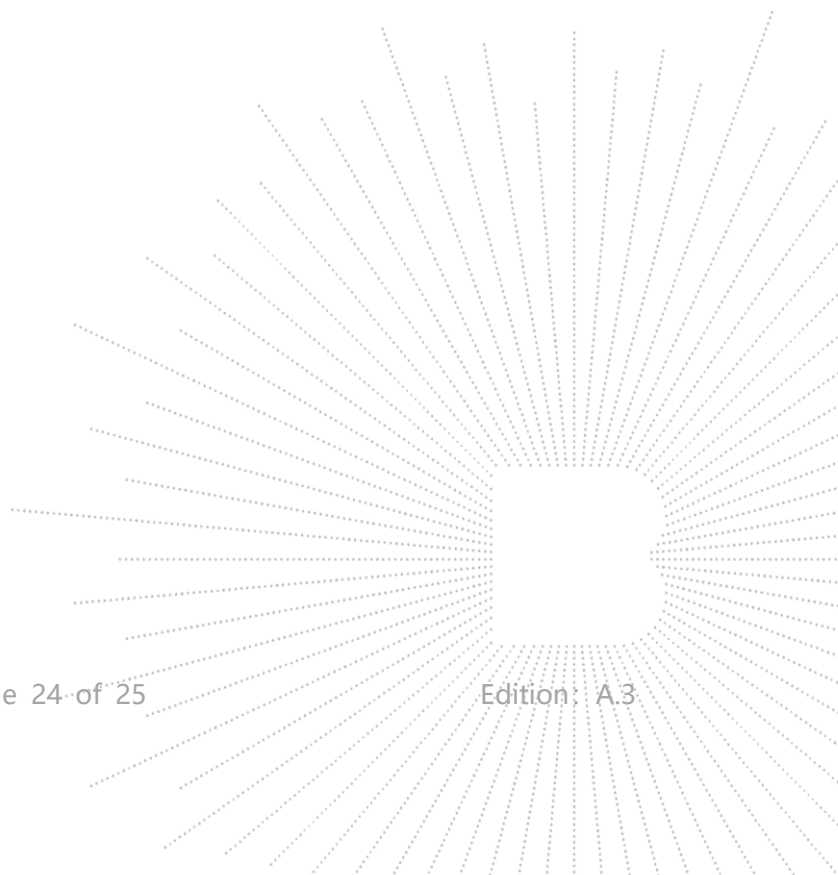



## STATEMENT

- 1.The equipment lists are traceable to the national reference standards.
- 2.The test report can not be partially copied unless prior written approval is issued from our lab.
- 3.The test report is invalid without stamp of laboratory.
- 4.The test report is invalid without signature of person(s) testing and authorizing.
- 5.The test process and test result is only related to the Unit Under Test.
- 6.The quality system of our laboratory is in accordance with ISO/IEC17025.
- 7.If there is any objection to report, the client should inform issuing laboratory within 15 days from the date of receiving test report.

Address:

1-2/F., Building B, Pengzhou Industrial Park, No.158, Fuyuan 1st Road, Zhancheng, Fuhai Subdistrict, Bao'an District, Shenzhen, Guangdong, China

TEL: 400-788-9558

P.C.: 518103

FAX: 0755-33229357

Website: <http://www.chnbctc.com>

E-Mail: [bctc@bctc-lab.com.cn](mailto:bctc@bctc-lab.com.cn)

\*\*\*\*\* END \*\*\*\*\*

