



# FCC/Canada Radio Test Report

**FCC ID: QTG-PLUTO****IC ID: 10710A-PLUTO**

**Report No.** : TB-FCC-IC125476  
**Applicant** : ZAGG Inc.  
**Equipment Under Test (EUT)**  
**EUT Name** : Zaggkeys Mini 7 (Pluto)  
**Model No.** : FOSBSL  
**Serial No.** : N/A  
**Brand Name** : N/A  
**Receipt Date** : 2012-10-22  
**Test Date** : 2012-10-23 to 2012-10-29  
**Issue Date** : 2012-10-30  
**Standards** : FCC Part 15, Subpart C(15.247)/ Canada RSS-210:2010  
**Test Method** : ANSI C63.4:2003  
**Conclusions** : **PASS**

In the configuration tested, the EUT complied with the standards specified above,  
The EUT technically complies with the FCC requirements

**Test/Witness Engineer** :   
**Approved & Authorized** : 

This report details the results of the testing carried out on one sample. The results contained in this test report do not relate to other samples of the same product. The manufacturer should ensure that all products in series production are in conformity with the product sample detailed in the report.

---

---

## Contents

<b>CONTENTS</b> .....	<b>2</b>
<b>1. GENERAL INFORMATION ABOUT EUT</b> .....	<b>4</b>
1.1 Client Information.....	4
1.2 General Description of EUT (Equipment Under Test) .....	4
1.3 Block Diagram Showing The Configuration of System Tested.....	6
1.4 Description of Support Units .....	6
1.5 Description of Test Mode.....	7
1.6 Description of Test Software Setting .....	7
1.7 Test Facility.....	8
<b>2. TEST SUMMARY</b> .....	<b>9</b>
<b>3. CONDUCTED EMISSION TEST</b> .....	<b>10</b>
3.1 Test Standard and Limit.....	10
3.2 Test Setup.....	10
3.3 Test Procedure.....	10
3.4 Test Equipment Used.....	11
3.5 EUT Operating Mode .....	11
3.6 Test Data.....	11
<b>4. RADIATED EMISSION TEST</b> .....	<b>14</b>
4.1 Test Standard and Limit.....	14
4.2 Test Setup.....	15
4.3 Test Procedure.....	16
4.4 EUT Operating Condition .....	16
4.5 Test Equipment .....	17
<b>5. RESTRICTED BANDS REQUIREMENT</b> .....	<b>26</b>
5.1 Test Standard and Limit.....	26
5.2 Test Setup.....	26
5.3 Test Procedure.....	26
5.4 EUT Operating Condition .....	27
5.5 Test Equipment .....	27
<b>6. NUMBER OF HOPPING CHANNEL</b> .....	<b>30</b>
6.1 Test Standard and Limit.....	30
6.2 Test Setup.....	30
6.3 Test Procedure.....	30
6.4 EUT Operating Condition .....	30
6.5 Test Equipment .....	30
<b>7. AVERAGE TIME OF OCCUPANCY</b> .....	<b>32</b>
7.1 Test Standard and Limit.....	32
7.2 Test Setup.....	32
7.3 Test Procedure.....	32

---

---

7.4 EUT Operating Condition .....	32
7.5 Test Equipment .....	32
<b>8. CHANNEL SEPARATION AND BANDWIDTH TEST .....</b>	<b>39</b>
8.1 Test Standard and Limit.....	39
8.2 Test Setup.....	39
8.3 Test Procedure.....	39
8.4 EUT Operating Condition .....	39
8.5 Test Equipment .....	40
8.6 Test Data.....	40
<b>9. PEAK OUTPUT POWER TEST.....</b>	<b>44</b>
9.1 Test Standard and Limit.....	44
9.2 Test Setup.....	44
9.3 Test Procedure.....	44
9.4 EUT Operating Condition .....	44
9.5 Test Equipment .....	44
8.6 Test Data.....	44
<b>10. ANTENNA CONDUCTED SPURIOUS EMISSION .....</b>	<b>47</b>
10.1 Test Standard and Limit .....	47
10.2 Test Setup.....	47
10.3 Test Procedure.....	47
10.4 EUT Operating Condition .....	48
10.5 Test Equipment.....	48
10.6 Test Data.....	48
<b>11. ANTENNA REQUIREMENT.....</b>	<b>52</b>
11.1 Standard Requirement.....	52
11.2 Antenna Connected Construction .....	52
11.2 Result.....	52

# 1. General Information About EUT

## 1.1 Client Information

<b>Applicant</b>	:	ZAGG Inc.
<b>Address</b>	:	3855 South 500 West Salt Lake City, UT 84115 USA
<b>Manufacturer</b>	:	Wagons Digital Co., Ltd.
<b>Address</b>	:	Flat/Rm.1701, 17/F., Henan Building, 90 Jaffe Road, Wanchai, Hongkong

## 1.2 General Description of EUT (Equipment Under Test)

<b>EUT Name</b>	:	Zaggkeys Mini 7 (Pluto)	
<b>Models No.</b>	:	FOSBSL	
<b>Model Difference</b>	:	N/A	
<b>Product Description</b>	:	Operation Frequency: 2402MHz~2480MHz	
	:	Number of Channel:	79Channels see note (2)
	:	Out Power	0.610 mW (max) conducted power (-2.15 dBm)
	:	Antenna Gain:	1.87 dBi
	:	Modulation Type:	GFSK 1Mbps
<b>Power Supply</b>	:	DC Voltage supplied from Host System DC Voltage supplied from Li-ion batter	
<b>Power Rating</b>	:	DC 5.0V from Host System DC 3.7V 190 mAh from Li-ion battery	
<b>Connecting I/O Port(S)</b>	:	Please refer to the User's Manual	

**Note:**

- (1) For a more detailed features description, please refer to the manufacturer's specifications or the User's Manual.
- (2) Channel List:

Channel	Frequency (MHz)	Channel	Frequency (MHz)	Channel	Frequency (MHz)
00	2402	27	2429	54	2456
01	2403	28	2430	55	2457
02	2404	29	2431	56	2458
03	2405	30	2432	57	2459
04	2406	31	2433	58	2460

05	2407	32	2434	59	2461
06	2408	33	2435	60	2462
07	2409	34	2436	61	2463
08	2410	35	2437	62	2464
09	2411	36	2438	63	2465
10	2412	37	2439	64	2466
11	2413	38	2440	65	2467
12	2414	39	2441	66	2468
13	2415	40	2442	67	2469
14	2416	41	2443	68	2470
15	2417	42	2444	69	2471
16	2418	43	2445	70	2472
17	2419	44	2446	71	2473
18	2420	45	2447	72	2474
19	2421	46	2448	73	2475
20	2422	47	2449	74	2476
21	2423	48	2450	75	2477
22	2424	49	2451	76	2478
23	2425	50	2452	77	2479
24	2426	51	2453	78	2480
25	2427	52	2454		
26	2428	53	2455		

### 1.3 Block Diagram Showing The Configuration of System Tested

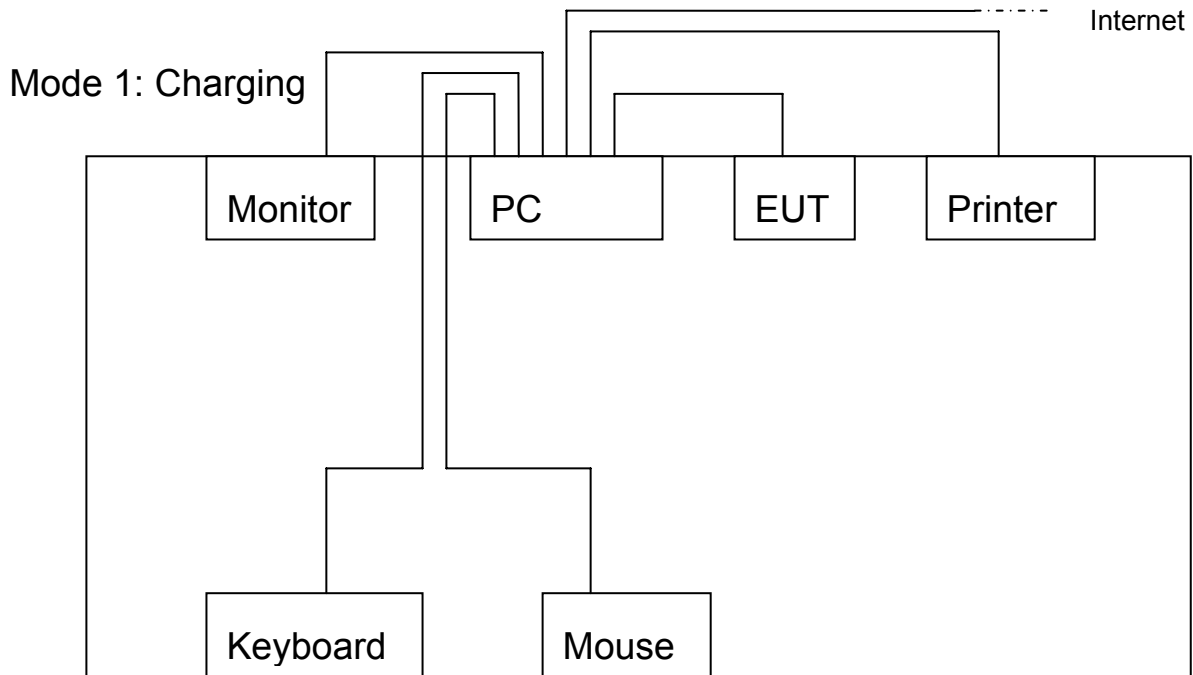

### Mode 2: TX Mode & 3: RX Mode

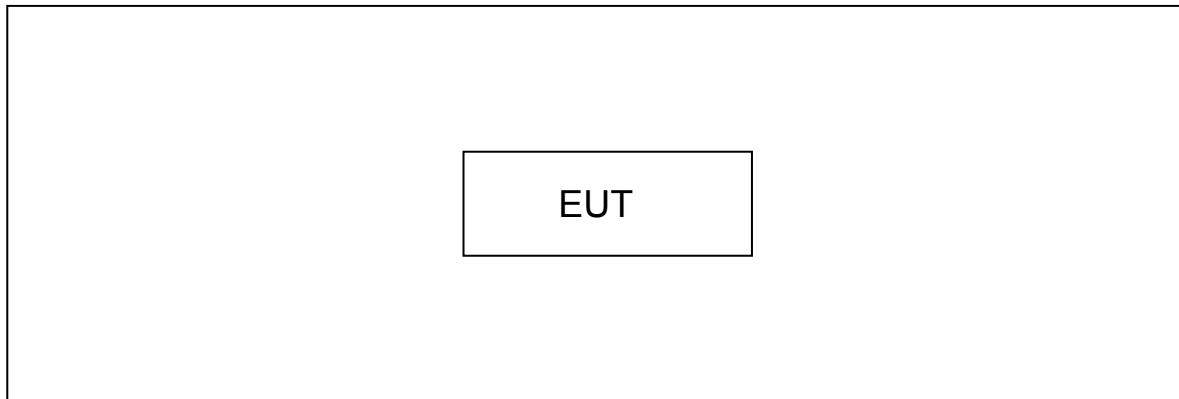

### 1.4 Description of Support Units

Name	Model	S/N	Manufacturer	Used "√"
Printer	HP1505n	VNF3G06957	HP	√
LCD Monitor	E170Sc	----	DELL	√
PC	OPTIPLEX380	----	DELL	√
Keyboard	L100	U01C	DELL	√
Mouse	M-UARDEL7	----	DELL	√

## 1.5 Description of Test Mode

To investigate the maximum EMI emission characteristics generates from EUT, the test system was pre-scanning tested base on the consideration of following EUT operation mode or test configuration mode which possible have effect on EMI emission level. Each of these EUT operation mode(s) or test configuration mode(s) mentioned follow was evaluated respectively.

For Conducted Test	
Final Test Mode	Description
Mode 1	Charging Mode

For Radiated Test	
Final Test Mode	Description
Mode 2	TX Mode Channel 00/39/78
Mode 3	RX Mode Channel 00/39/78

**Note:**

- (1) For all test, we have verified the construction and function in typical operation. And all the test modes were carried out with the EUT in transmitting operation in maximum power with all kinds of data rate.  
According to ANSI C63.4 standards, the measurements are performed at the highest, middle, lowest available channels, and the worst case data rate as follows:  
TX Mode: GFSK (1 Mbps)
- (2) During the testing procedure, the continuously transmitting with the maximum power mode was programmed by the customer.
- (3) The EUT is considered a portable unit; it was pre-tested on the positioned of each 3 axis, X-plane, Y-plane and Z-plane. The worst case was found positioned on X-plane. Therefore only the test data of this X-plane was used for radiated emission measurement test.

## 1.6 Description of Test Software Setting

During testing channel & Power controlling software provided by the customer was used to control the operating channel as well as the output power level. The RF output power selection is for the setting of RF output power expected by the customer and is going to be fixed on the firmware of the final end product power parameters of Bluetooth mode.

Test Software Version	Test Program: Bluetool 1.4.4.9		
Frequency	2402 MHz	2441MHz	2480 MHz
1 Mbps	0	0	0

## 1.7 Test Facility

The tests were performed at:

Bontek Compliance Testing Laboratory Ltd

1/F., Block East H-3, OCT Eastern Ind. Zone, Qiaocheng East Road, Nanshan, Shenzhen, 518055 China

Tel: 86-755-86337020 Fax: 86-755-86337028

At the time of testing, the Laboratory is accredited. It is listed in the United States of American Federal Communications Commission (FCC), and the registration number is 338263.

The test report was fulfilled by Shenzhen Toby Technology Co., Ltd. Shenzhen Toby Technology Co., Ltd. is assumed full responsibility for the accuracy and completeness of these measurements results.



## 2. Test Summary

Applied Standard: Part 15 Subpart C; RSS-210				
Standard Section		Test Item	Judgment	Remark
RSS-210	47 CFR Part 15			
RSS-GEN 7.2.2	15.207	AC Power Conducted Emission	Pass	/
RSS-210 Annex 8 (A8.4(2))	15.247(a)(1)(iii)	Number of Hopping Frequency	Pass	/
RSS-210 Annex 8 (A8.5)	15.247(a)(1)(iii)	Dwell Time	Pass	/
RSS-210 Annex 8 (A8.1d)	15.247(a)(1)	Hopping Channel Separation	Pass	/
RSS-210 Annex 8 (A8.1d)	15.247(d)	Antenna conducted Spurious Emission	Pass	/
RSS-210 Annex 8 (A8.1(b))	15.247(b)(1)	Peak Output Power	Pass	/
RSS-210 Annex 8 (A8.1a)	15.247(d) 15.209	Radiated Spurious Emission	Pass	/
RSS-Gen 7.2.3	15.205	Restricted Bands	Pass	/
RSS-210 Annex 8 (A8.5)	15.203	Antenna Requirement	Pass	/

**Note:** N/A is an abbreviation for Not Applicable.

### 3. Conducted Emission Test

#### 3.1 Test Standard and Limit

##### 3.1.1 Test Standard

FCC Part 15.207/ RSS-GEN7.2.2

##### 3.1.2 Test Limit

**Conducted Emission Test Limit**

Frequency	Maximum RF Line Voltage (dB $\mu$ V)	
	Quasi-peak Level	Average Level
150kHz~500kHz	66 ~ 56 *	56 ~ 46 *
500kHz~5MHz	56	46
5MHz~30MHz	60	50

Notes:

(1) \*Decreasing linearly with logarithm of the frequency.

(2) The lower limit shall apply at the transition frequencies.

(3) The limit decrease in line with the logarithm of the frequency in the range of 0.15 to 0.50MHz.

#### 3.2 Test Setup

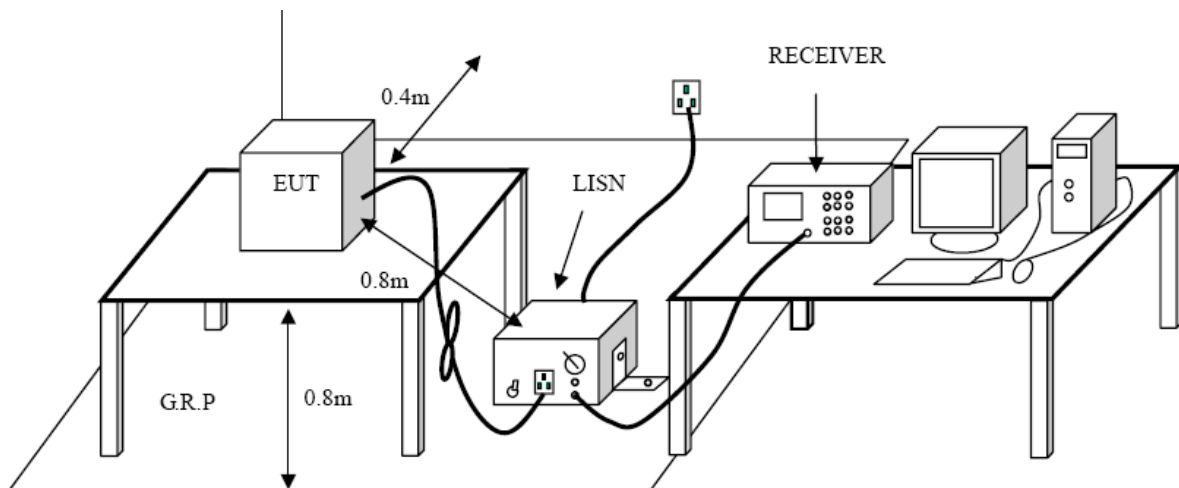

#### 3.3 Test Procedure

The EUT was placed 0.8 meters from the horizontal ground plane with EUT being connected to the power mains through a line impedance stabilization network (LISN). All other support equipments powered from additional LISN(s). The LISN provide 50 Ohm/ 50uH of coupling impedance for the measuring instrument.

Interconnecting cables that hang closer than 40 cm to the ground plane shall be folded back and forth in the center forming a bundle 30 to 40 cm long.

I/O cables that are not connected to a peripheral shall be bundled in the center. The end of the cable may be terminated, if required, using the correct terminating impedance. The overall length shall not exceed 1 m.

LISN at least 80 cm from nearest part of EUT chassis.

The bandwidth of EMI test receiver is set at 9kHz, and the test frequency band is from 0.15MHz to 30MHz.

### 3.4 Test Equipment Used

Description	Manufacturer	Model No.	Serial No.	Cal. Date	Cal. Date
EMI Test Receiver	ROHDE & SCHWARZ	ESC30	DE25181	2012-08-07	2013-08-06
50Ω Coaxial Switch	Anritsu	MP59B	X10321	2012-08-07	2013-08-06
L.I.S.N	EMCO	3624/1	00063417	2012-08-07	2013-08-06
L.I.S.N	EMCO	3624/1	00063417	2012-08-07	2013-08-06

### 3.5 EUT Operating Mode

Please refer to the description of test mode.

### 3.6 Test Data

Please see the next page.

E.U.T :	Zaggkeys Mini 7 (Pluto)	Model Name :	FOSBSL
Temperature :	25°C	Relative Humidity :	52 %
Terminal	Line		
Test Voltage :	AC 120 V / 60Hz		
Test Mode :	Charging Mode		

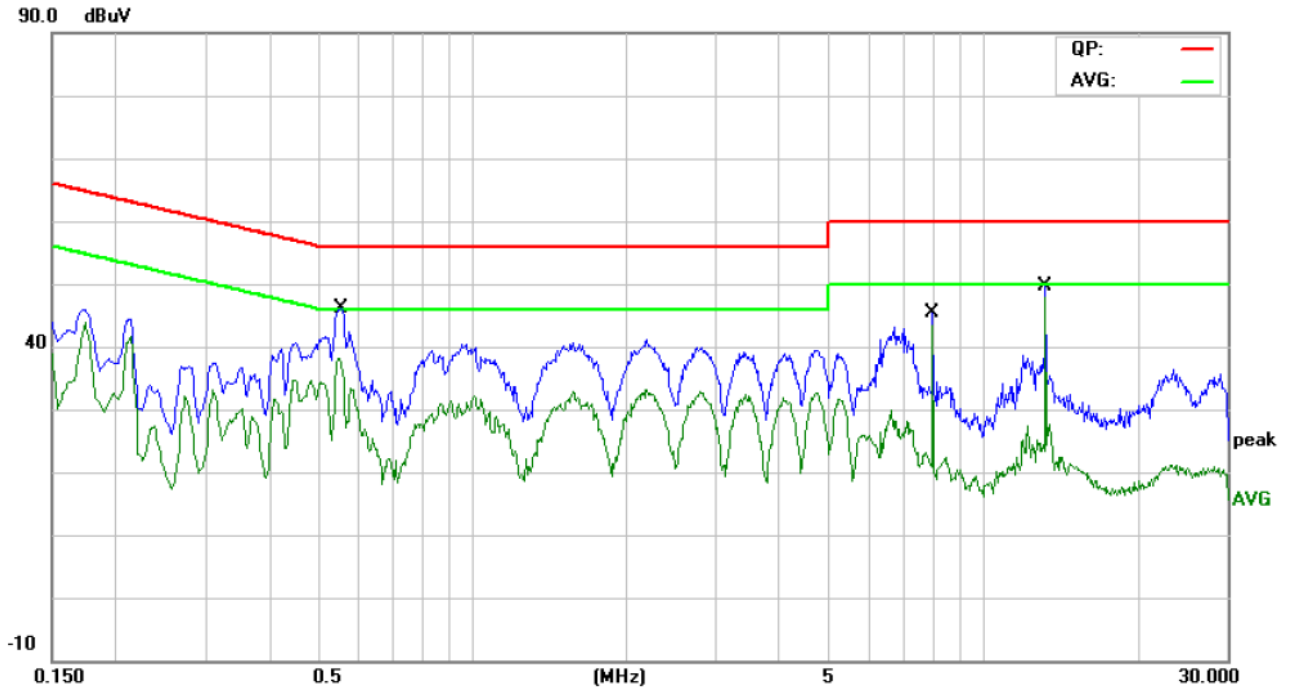

No.	Mk.	Freq.	Reading Level	Correct Factor	Measurement	Limit	Over	Detector	Comment
		MHz	dBuV	dB	dBuV	dBuV	dB		
1		0.5540	35.89	9.43	45.32	56.00	-10.68	QP	
2		0.5540	28.23	9.43	37.66	46.00	-8.34	AVG	
3		7.9500	32.79	9.80	42.59	60.00	-17.41	QP	
4		7.9500	31.60	9.80	41.40	50.00	-8.60	AVG	
5		13.2500	37.71	10.00	47.71	60.00	-12.29	QP	
6	*	13.2500	36.90	10.00	46.90	50.00	-3.10	AVG	

E.U.T :	Zaggkeys Mini 7 (Pluto)	Model Name :	FOSBSL
Temperature :	25°C	Relative Humidity :	52 %
Terminal	Neutral		
Test Voltage :	AC 120 V / 60Hz		
Test Mode :	Charging Mode		

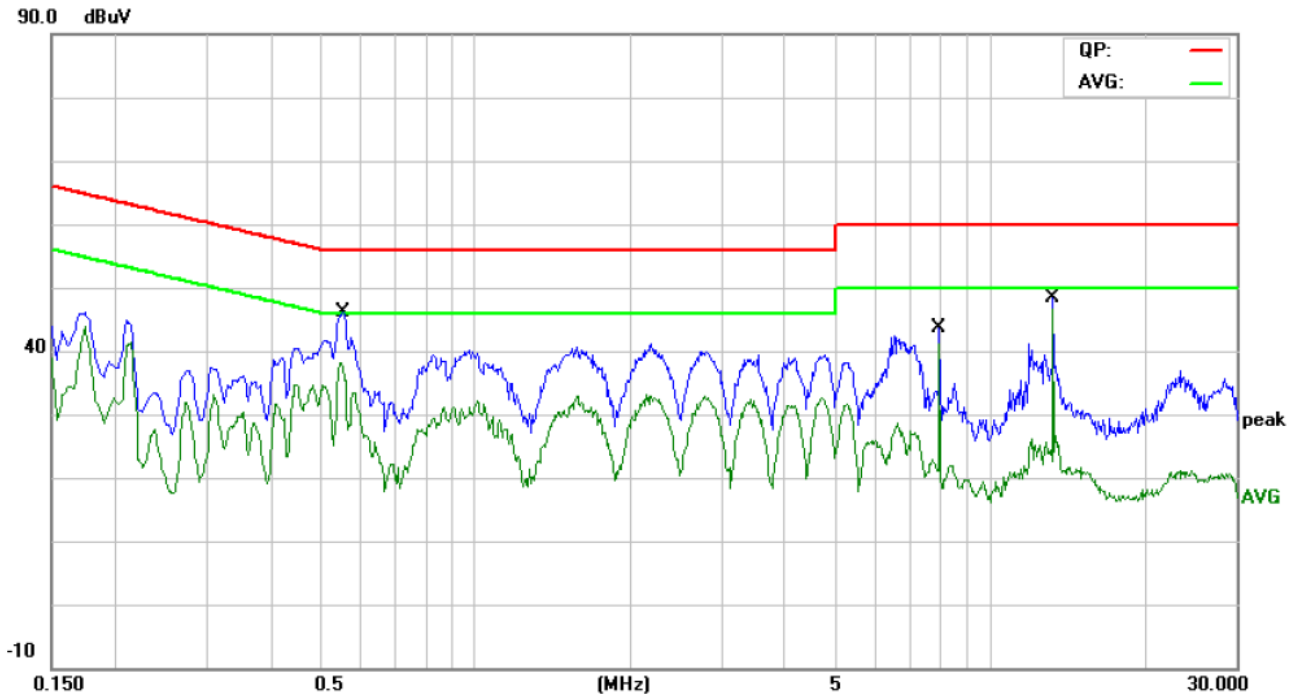

No.	Mk.	Freq.	Reading Level	Correct Factor	Measurement	Limit	Over	Detector	Comment
		MHz	dBuV	dB	dBuV	dBuV	dB		
1		0.5540	35.86	9.46	45.32	56.00	-10.68	QP	
2		0.5540	28.23	9.46	37.69	46.00	-8.31	AVG	
3		7.9500	33.07	9.83	42.90	60.00	-17.10	QP	
4		7.9500	31.87	9.83	41.70	50.00	-8.30	AVG	
5		13.2500	37.87	10.03	47.90	60.00	-12.10	QP	
6	*	13.2500	36.90	10.03	46.93	50.00	-3.07	AVG	

## 4. Radiated Emission Test

### 4.1 Test Standard and Limit

#### 4.1.1 Test Standard

FCC Part 15.209/ RSS-210 Annex 8(A8.1a)

#### 4.1.2 Test Limit

#### Radiated Emission Limit (9kHz~1000MHz)

Frequency (MHz)	Field Strength (microvolt/meter)	Measurement Distance (meters)
0.009~0.490	2400/F(KHz)	300
0.490~1.705	24000/F(KHz)	30
1.705~30.0	30	30
30~88	100	3
88~216	150	3
216~960	200	3
Above 960	500	3

#### Radiated Emission Limit (Above 1000MHz)

Frequency (MHz)	Class A (dBuV/m)(at 3m)		Class B (dBuV/m)(at 3m)	
	Peak	Average	Peak	Average
Above 1000	80	60	74	54

**Note:**

- (1) The tighter limit applies at the band edges.
- (2) Emission Level(dBuV/m)=20log Emission Level(uV/m)

4.2 Test Setup

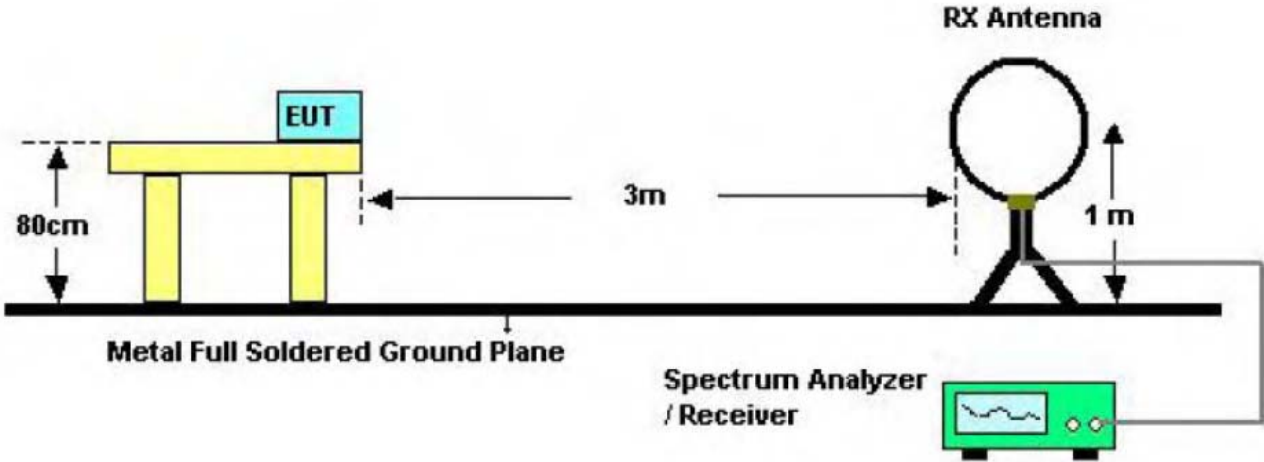

Bellow 30MHz Test Setup

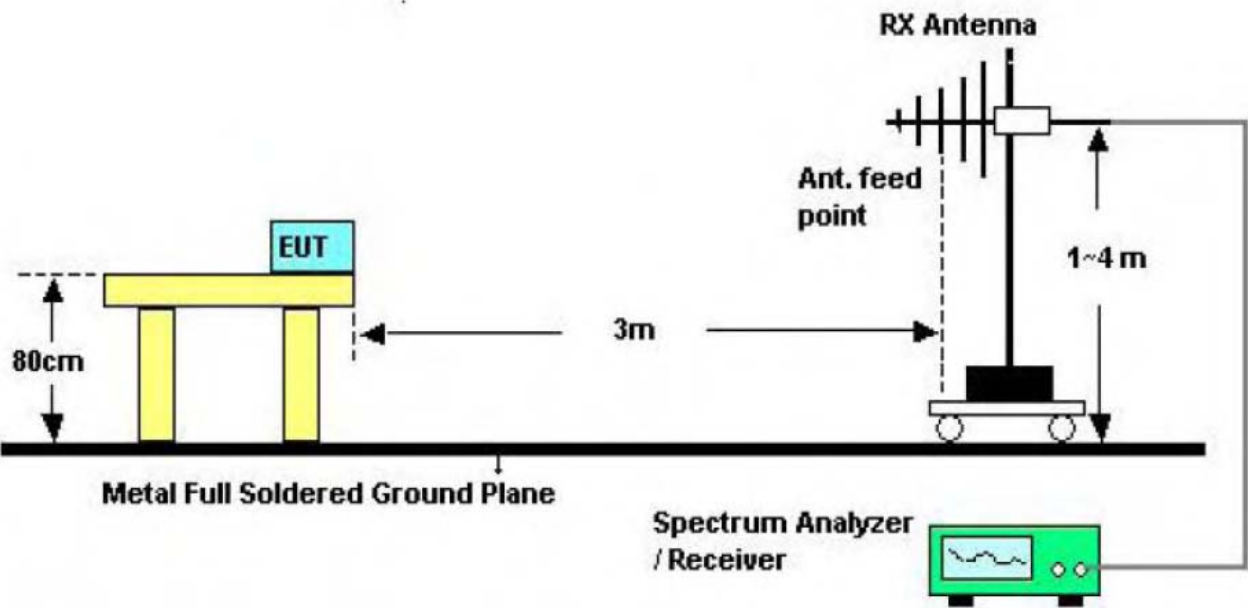

Bellow 1000MHz Test Setup

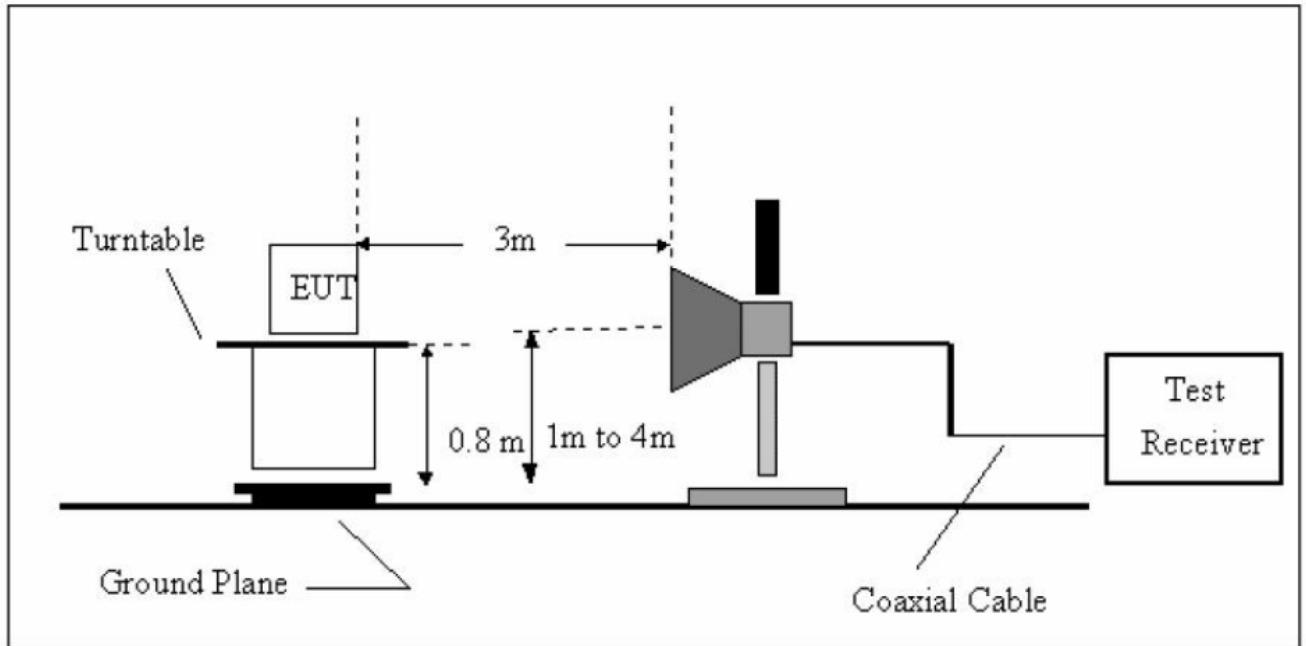

Above 1GHz Test Setup

### 4.3 Test Procedure

- (1) The measuring distance of 3m shall be used for measurements at frequency up to 1GHz and above 1 GHz. The EUT was placed on a rotating 0.8m high above ground, the table was rotated 360 degrees to determine the position of the highest radiation.
- (2) The Test antenna shall vary between 1m and 4m, Both Horizontal and Vertical antenna are set to make measurement.
- (3) The initial step in collecting conducted emission data is a spectrum analyzer peak detector mode pre-scanning the measurement frequency range. Significant peaks are then marked and then Quasi Peak detector mode re-measured.
- (4) If the Peak Mode measured value compliance with and lower than Quasi Peak Mode Limit Bellow 1 GHz, the EUT shall be deemed to meet QP Limits and then no additional QP Mode measurement performed. But the Peak Value and average value both need to comply with applicable limit above 1 GHz.
- (5) For the actual test configuration, please see the test setup photo.

### 4.4 EUT Operating Condition

The Equipment Under Test was set to Continual Transmitting in maximum power in TX mode, and the Equipment Under Test was set to Continual Receiving in RX mode.



#### 4.5 Test Equipment

Description	Manufacturer	Model No.	Serial No.	Cal. Date	Cal. Date
Spectrum Analyzer	ROHDE& SCHWARZ	FSEA20	DE25181	2012-08-07	2013-08-06
Positioning Controller	C&C	CC-C-1F	N/A	2012-08-07	2013-08-06
Trilog Broadband Antenna	SCHWARZBECK	VULB9163	9163-333	2012-07-13	2013-07-12
Horn Antenna	SCHWARZBECK	BBHX 9120	9120-426	2012-07-13	2013-07-12
RF Switch	EM	EMSW18	SW060023	2012-08-07	2013-08-06
Amplifier	Agilent	8447F	3113A06717	2012-08-07	2013-08-06
Coaxial Cable	SCHWARZBECK	AK9513	9513-10	2012-08-07	2013-08-06
EMI Test Receiver	ROHDE& SCHWARZ	ESPI	25498514	2012-08-07	2013-08-06
EMI Test Receiver	ROHDE& SCHWARZ	ESI26	838786/103	2012-08-07	2013-08-06
Receiver Horn Antenna	ROHDE& SCHWARZ	HF906	100013	2012-08-07	2013-08-06

#### 4.6 Test Data

Please see the next page.

Operation Mode: TX 2402MHz      Test Date : October 27, 2012  
 Frequency Range: 30~1000MHz      Temperature : 26 °C  
 Measured Distance: 3m      Humidity : 51 %  
 Test Voltage: DC 3.7V

Freq. (MHz)	Ant.Pol. H/V	Emission Level (dBuV/m)	Limit (3m) (dBuV/m)	Margin (dB)	Note
192.475	H	22.70	43.50	20.80	PK
216.725	H	24.37	46.00	21.63	PK
240.975	H	25.73	46.00	20.27	PK
265.225	H	27.02	46.00	18.98	PK
359.800	H	36.38	46.00	9.62	PK
408.300	H	31.43	46.00	14.57	PK
359.800	V	25.90	46.00	20.10	PK
447.100	V	26.50	46.00	19.50	PK
534.400	V	28.76	46.00	17.24	PK
565.925	V	30.27	46.00	15.73	PK
658.075	V	32.20	46.00	13.80	PK
706.575	V	31.08	46.00	14.92	PK

- Note:**
- (1) All Readings are Peak Value.
  - (2) Emission Level= Reading Level+ Probe Factor +Cable Loss
  - (3) The average measurement was not performed when the peak measured data under the limit of average detection.

Operation Mode:	RX 2402MHz	Test Date :	October 27, 2012
Frequency Range:	30~1000MHz	Temperature :	26 °C
Measured Distance:	3m	Humidity :	51 %
Test Voltage:	DC 3.7V		

Freq. (MHz)	Ant.Pol. H/V	Emission Level (dBUV/m)	Limit (3m) (dBUV/m)	Margin (dB)	Note
192.475	H	24.20	43.50	19.30	PK
216.725	H	24.37	46.00	21.63	PK
240.975	H	25.73	46.00	20.27	PK
265.225	H	26.52	46.00	19.48	PK
359.800	H	36.38	46.00	9.62	PK
408.300	H	31.43	46.00	14.57	PK
449.525	V	9.01	46.00	18.82	PK
534.400	V	7.15	46.00	16.24	PK
565.925	V	6.25	46.00	15.23	PK
624.125	V	5.09	46.00	14.82	PK
658.075	V	4.66	46.00	14.30	PK
706.575	V	4.60	46.00	14.92	PK

**Note:**

- (1) All Readings are Peak Value.
- (2) Emission Level= Reading Level+ Probe Factor +Cable Loss
- (3) The average measurement was not performed when the peak measured data under the limit of average detection.

Operation Mode:	TX 2402MHz	Test Date :	October 27, 2012
Frequency Range:	1-25GHz	Temperature :	26 °C
Measured Distance:	3m	Humidity :	51 %
Test Voltage:	DC 3.7V		

Freq. (MHz)	Ant.Pol. H/V	Emission Level (dBuV/m)		Limit3m (dBuV/m)		Margin(dB)	
		PK	AV	PK	AV	PK	AV
2402.000	V	92.35	91.99	Fundamental Frequency			
4804.000	V	53.49	44.29	74.00	54.00	20.51	9.71
7206.003	V	48.01	39.18	74.00	54.00	25.99	14.82
--	V	--	--	74.00	54.00	--	--
--	V	--	--	74.00	54.00	--	--
--	V	--	--	74.00	54.00	--	--
2402.125	H	93.87	93.50	Fundamental Frequency			
4804.000	H	52.53	43.52	74.00	54.00	21.47	10.48
7206.000	H	47.50	38.47	74.00	54.00	26.50	15.53
--	H	--	--	74.00	54.00	--	--
--	H	--	--	74.00	54.00	--	--
--	H	--	--	74.00	54.00	--	--

**Other harmonics emissions are lower than 20dB below the allowable limit.**

- Note:**
- (1) All Readings are Peak Value and AV.
  - (2) Emission Level= Reading Level + Probe Factor +Cable Loss
  - (3) Data of measurement within this frequency range shown “ -- ” in the table above means the reading of emissions are attenuated more than 20dB below the permissible limits or the field strength is too small to be measured.

Operation Mode:	TX 2441MHz	Test Date :	October 27, 2012
Frequency Range:	1-25GHz	Temperature :	26 °C
Measured Distance:	3m	Humidity :	51 %
Test Voltage:	DC 3.7V		

Freq. (MHz)	Ant.Pol. H/V	Emission Level (dBuV/m)		Limit3m (dBuV/m)		Margin(dB)	
		PK	AV	PK	AV	PK	AV
2440.875	V	90.22	89.81	Fundamental Frequency			
4822.120	V	52.58	43.67	74.00	54.00	21.42	10.33
7323.001	V	49.22	40.05	74.00	54.00	24.78	13.95
--	V	--	--	74.00	54.00	--	--
--	V	--	--	74.00	54.00	--	--
--	V	--	--	74.00	54.00	--	--
2440.875	H	91.72	91.37	Fundamental Frequency			
4822.120	H	51.58	42.68	74.00	54.00	22.42	11.32
7323.000	H	47.63	38.04	74.00	54.00	26.37	15.96
--	H	--	--	74.00	54.00	--	--
--	H	--	--	74.00	54.00	--	--
--	H	--	--	74.00	54.00	--	--

**Other harmonics emissions are lower than 20dB below the allowable limit.**

- Note:**
- (1) All Readings are Peak Value and AV.
  - (2) Emission Level= Reading Level + Probe Factor +Cable Loss
  - (3) Data of measurement within this frequency range shown “ -- ” in the table above means the reading of emissions are attenuated more than 20dB below the permissible limits or the field strength is too small to be measured.

Operation Mode:	TX 2480MHz	Test Date :	October 27, 2012
Frequency Range:	1-25GHz	Temperature :	26 °C
Measured Distance:	3m	Humidity :	51 %
Test Voltage:	DC 3.7V		

Freq. (MHz)	Ant.Pol. H/V	Emission Level (dBuV/m)		Limit3m (dBuV/m)		Margin(dB)	
		PK	AV	PK	AV	PK	AV
2480.125	V	88.61	88.22	Fundamental Frequency			
4960.020	V	53.14	44.20	74.00	54.00	20.86	9.80
7440.025	V	47.58	38.91	74.00	54.00	26.42	15.09
--	V	--	--	74.00	54.00	--	--
--	V	--	--	74.00	54.00	--	--
--	V	--	--	74.00	54.00	--	--
2479.875	H	90.20	89.79	Fundamental Frequency			
4960.020	H	52.15	43.05	74.00	54.00	21.85	10.95
7440.120	H	47.33	37.94	74.00	54.00	26.67	16.06
--	H	--	--	74.00	54.00	--	--
--	H	--	--	74.00	54.00	--	--
--	H	--	--	74.00	54.00	--	--

**Other harmonics emissions are lower than 20dB below the allowable limit.**

- Note:**
- (1) All Readings are Peak Value and AV.
  - (2) Emission Level= Reading Level + Probe Factor +Cable Loss
  - (3) Data of measurement within this frequency range shown “ -- ” in the table above means the reading of emissions are attenuated more than 20dB below the permissible limits or the field strength is too small to be measured.

---

Operation Mode: RX 2402 MHz      Test Date : October 27, 2012  
 Frequency Range: 1-25GHz      Temperature : 26 °C  
 Measured Distance: 3m      Humidity : 51 %  
 Test Voltage: DC 3.7V

Freq. (MHz)	Ant.Pol. H/V	Emission Level (dBuV/m)		Limit3m (dBuV/m)		Margin(dB)	
		PK	AV	PK	AV	PK	AV
1640.000	V	45.56	35.89	74.00	54.00	28.44	18.11
--	V	--	--	74.00	54.00	--	--
--	V	--	--	74.00	54.00	--	--
--	V	--	--	74.00	54.00	--	--
--	V	--	--	74.00	54.00	--	--
1640.000	H	45.66	36.90	74.00	54.00	28.34	17.10
--	H	--	--	74.00	54.00	--	--
--	H	--	--	74.00	54.00	--	--
--	H	--	--	74.00	54.00	--	--
--	H	--	--	74.00	54.00	--	--

**Other harmonics emissions are lower than 20dB below the allowable limit.**

- Note:**
- (1) All Readings are Peak Value and AV.
  - (2) Emission Level= Reading Level + Probe Factor +Cable Loss
  - (3) Data of measurement within this frequency range shown “ -- ” in the table above means the reading of emissions are attenuated more than 20dB below the permissible limits or the field strength is too small to be measured.

---

Operation Mode: RX 2441 MHz      Test Date : October 27, 2012  
 Frequency Range: 1-25GHz      Temperature : 26 °C  
 Measured Distance: 3m      Humidity : 51 %  
 Test Voltage: DC 3.7V

Freq. (MHz)	Ant.Pol. H/V	Emission Level (dBuV/m)		Limit3m (dBuV/m)		Margin(dB)	
		PK	AV	PK	AV	PK	AV
1640.120	V	45.55	34.90	74.00	54.00	28.45	19.10
--	V	--	--	74.00	54.00	--	--
--	V	--	--	74.00	54.00	--	--
--	V	--	--	74.00	54.00	--	--
--	V	--	--	74.00	54.00	--	--
1640.120	H	45.66	36.76	74.00	54.00	28.34	17.24
--	H	--	--	74.00	54.00	--	--
--	H	--	--	74.00	54.00	--	--
--	H	--	--	74.00	54.00	--	--
--	H	--	--	74.00	54.00	--	--

**Other harmonics emissions are lower than 20dB below the allowable limit.**

- Note:**
- (1) All Readings are Peak Value and AV.
  - (2) Emission Level= Reading Level + Probe Factor +Cable Loss
  - (3) Data of measurement within this frequency range shown “ -- ” in the table above means the reading of emissions are attenuated more than 20dB below the permissible limits or the field strength is too small to be measured.



Operation Mode: RX 2480 MHz      Test Date : October 27, 2012  
 Frequency Range: 1-25GHz      Temperature : 26 °C  
 Measured Distance: 3m      Humidity : 51 %  
 Test Voltage: DC 3.7V

Freq. (MHz)	Ant.Pol. H/V	Emission Level (dBuV/m)		Limit3m (dBuV/m)		Margin(dB)	
		PK	AV	PK	AV	PK	AV
1640.020	V	44.89	34.84	74.00	54.00	29.11	19.16
--	V	--	--	74.00	54.00	--	--
--	V	--	--	74.00	54.00	--	--
--	V	--	--	74.00	54.00	--	--
--	V	--	--	74.00	54.00	--	--
1640.020	H	45.84	36.52	74.00	54.00	28.16	17.48
--	H	--	--	74.00	54.00	--	--
--	H	--	--	74.00	54.00	--	--
--	H	--	--	74.00	54.00	--	--
--	H	--	--	74.00	54.00	--	--

**Other harmonics emissions are lower than 20dB below the allowable limit.**

- Note:**
- (1) All Readings are Peak Value and AV.
  - (2) Emission Level= Reading Level + Probe Factor +Cable Loss
  - (3) Data of measurement within this frequency range shown “ -- ” in the table above means the reading of emissions are attenuated more than 20dB below the permissible limits or the field strength is too small to be measured.

## 5. Restricted Bands Requirement

### 5.1 Test Standard and Limit

#### 5.1.1 Test Standard

FCC Part 15.209/ RSS-210 Annex 8 (A8.1a)

FCC Part 15.205/ RSS-Gen7.2.3

#### 5.1.2 Test Limit

Restricted Frequency Band (MHz)	Class B (dBuV/m)(at 3m)	
	Peak	Average
2310 ~2390	74	54
2483.5 ~2500	74	54

### 5.2 Test Setup

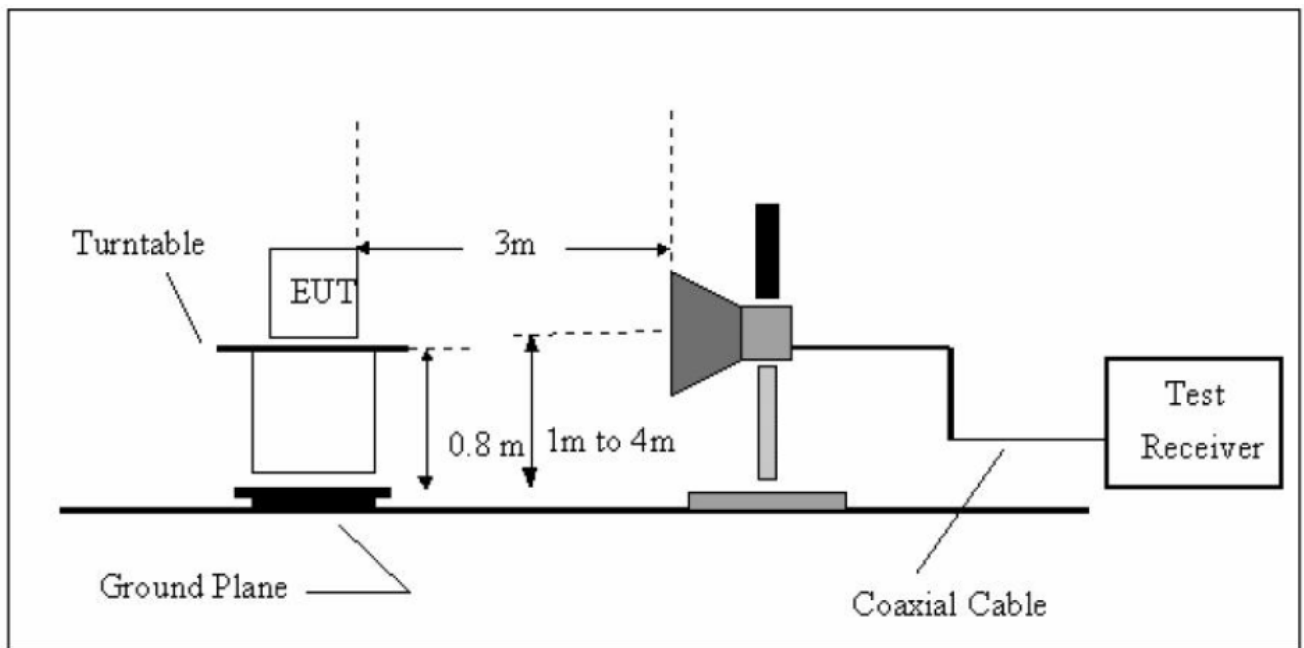

### 5.3 Test Procedure

- (1) The measuring distance of 3m shall be used for measurements at frequency up to 1GHz and above 1 GHz. The EUT was placed on a rotating 0.8m high above ground, the table was rotated 360 degrees to determine the position of the highest radiation.
- (2) The Test antenna shall vary between 1m and 4m, Both Horizontal and Vertical antenna are set to make measurement.
- (3) The initial step in collecting conducted emission data is a spectrum analyzer peak detector mode pre-scanning the measurement frequency range. Significant peaks are then marked and then Quasi Peak detector mode re-measured.

- (4) If the Peak Mode measured value compliance with and lower than Quasi Peak Mode Limit Bellow 1 GHz, the EUT shall be deemed to meet QP Limits and then no additional QP Mode measurement performed. But the Peak Value and average value both need to comply with applicable limit above 1 GHz.
- (5) For the actual test configuration, please see the test setup photo.

#### 5.4 EUT Operating Condition

The Equipment Under Test was set to Continual Transmitting in maximum power.

#### 5.5 Test Equipment

Description	Manufacturer	Model No.	Serial No.	Cal. Date	Cal. Date
Spectrum Analyzer	ROHDE& SCHWARZ	FSEA20	DE25181	2012-08-07	2013-08-06
Positioning Controller	C&C	CC-C-1F	N/A	2012-08-07	2013-08-06
Trilog Broadband Antenna	SCHWARZBEC K	VULB9163	9163-333	2012-07-13	2013-07-12
Horn Antenna	SCHWARZBEC K	BBHX 9120	9120-426	2012-07-13	2013-07-12
RF Switch	EM	EMSW18	SW060023	2012-08-07	2013-08-06
Amplifier	Agilent	8447F	3113A06717	2012-08-07	2013-08-06
Coaxial Cable	SCHWARZBEC K	AK9513	9513-10	2012-08-07	2013-08-06
EMI Test Receiver	ROHDE& SCHWARZ	ESPI	25498514	2012-08-07	2013-08-06
EMI Test Receiver	ROHDE& SCHWARZ	ESI26	838786/103	2012-08-07	2013-08-06
Receiver Horn Antenna	ROHDE& SCHWARZ	HF906	100013	2012-08-07	2013-08-06

## 5.6 Test Data

Spectrum Detector: PK                      Test Date :                      October 24, 2012  
 Temperature :                      26 °C                      Humidity :                      51 %

### 1. Conducted Test

Frequency (MHz)	Peak Power Output(dBm)	Emission Read Value(dBm)	Result of Band edge(dBc)	Band edge Limit(dBc)
<2400	-2.39	-58.05	55.66	>20dBc
>2483.5	-2.31	-58.06	55.75	>20dBc

### 2. Radiated emission test

Frequency (MHz)	Antenna polarization (H/V)	Emission (dBuV/m)		Band edge Limit (dBuV/m)	
		PEAK	AV	PEAK	AV
2390.0	H	51.98	42.43	74.00	54.00
2390.0	V	54.39	42.41	74.00	54.00
2483.5	H	53.34	49.99	74.00	54.00
2483.5	V	53.37	48.58	74.00	54.00

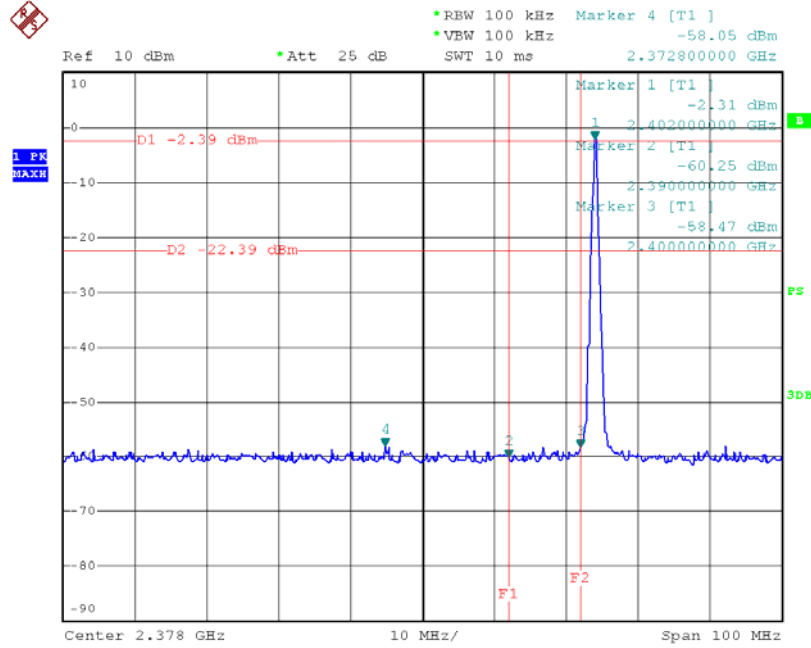

Date: 24.OCT.2012 17:33:25

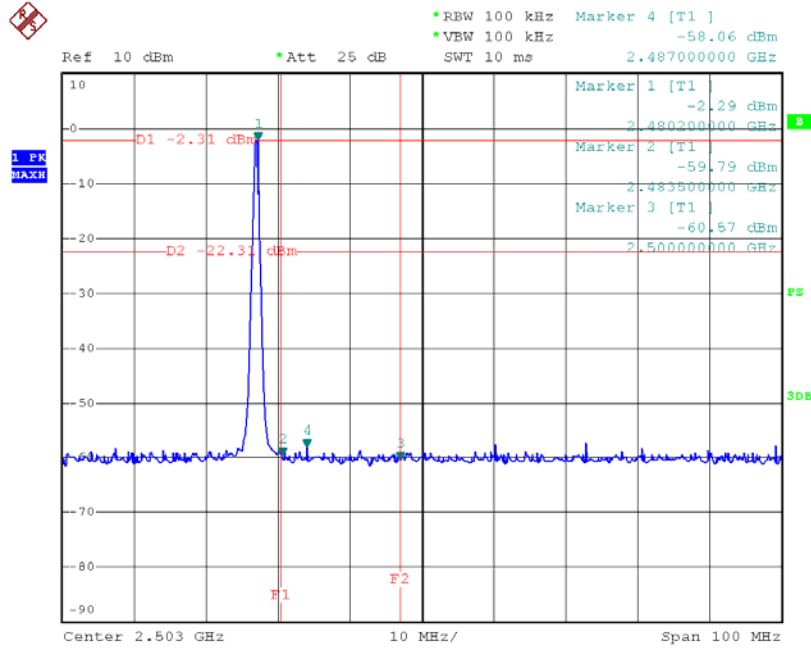

Date: 24.OCT.2012 17:36:24

## 6. Number of Hopping Channel

### 6.1 Test Standard and Limit

#### 5.1.1 Test Standard

FCC Part 15.247 (a)(1)/ RSS-210 Annex 8(A8.1d)

#### 5.1.2 Test Limit

Section	Test Item	Limit
15.247	Number of Hopping Channel	>15

### 6.2 Test Setup

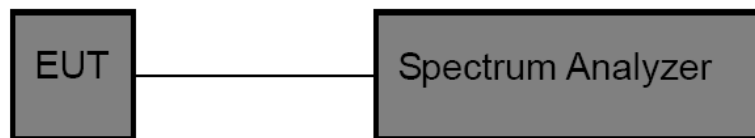

### 6.3 Test Procedure

- (1) The EUT was directly connected to the spectrum analyzer and antenna output port as show in the block diagram above.
- (2) Spectrum Setting:RBW=100 KHz, VBW=100 KHz, Sweep time= Auto.

### 6.4 EUT Operating Condition

The EUT was set to the Hopping Mode by the Customer.

### 6.5 Test Equipment

Description	Manufacturer	Model No.	Serial No.	Cal. Date	Cal. Date
Spectrum Analyzer	ROHDE& SCHWARZ	FSEA20	DE25181	2012-08-07	2013-08-06

### 6.6 Test Data

Hopping Channel Frequency Range	Quantity of Hopping Channel	Limit
2402~2480	79	>15

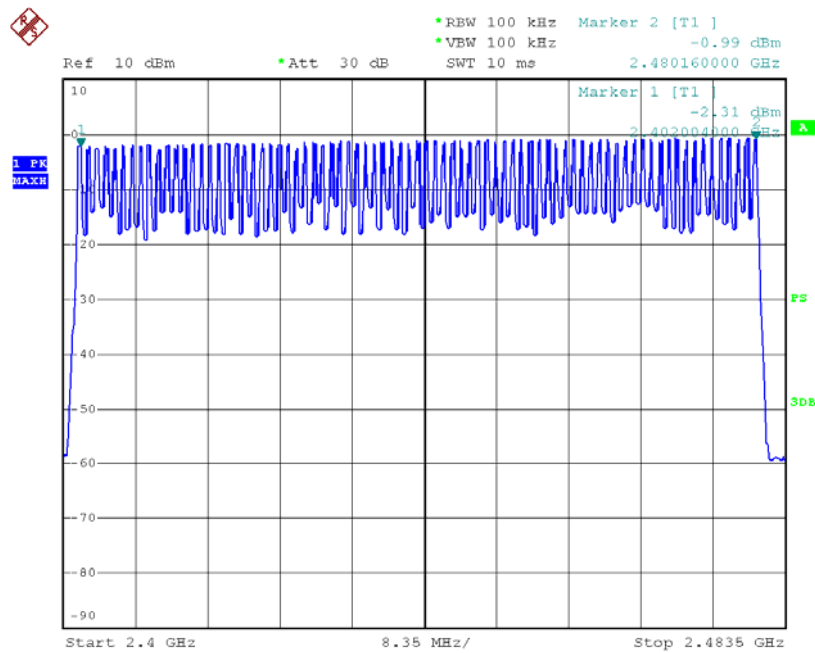

Date: 24.OCT.2012 16:03:44

## 7. Average Time of Occupancy

### 7.1 Test Standard and Limit

#### 5.1.1 Test Standard

FCC Part 15.247 (a)(1) / RSS-210 Annex 8(A8.1d)

#### 5.1.2 Test Limit

Section	Test Item	Limit
15.247(a)(1)/ RSS-210 Annex 8(A8.1d)	Average Time of Occupancy	0.4 sec

### 7.2 Test Setup

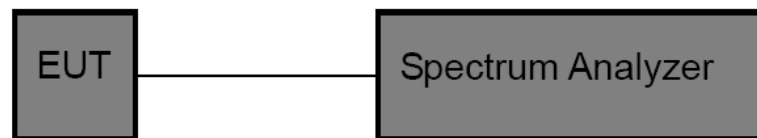

### 7.3 Test Procedure

- (1) The EUT was directly connected to the spectrum analyzer and antenna output port as show in the block diagram above.
- (2) Spectrum Setting: RBW=1MHz, VBW=1MHz.
- (3) Use video trigger with the trigger level set to enable triggering only on full pulses.
- (4) Sweep Time is more than once pulse time.
- (5) Set the center frequency on any frequency would be measure and set the frequency span to zero span.
- (6) Measure the maximum time duration of one single pulse.
- (7) Set the EUT for packet transmitting.
- (8) Measure the maximum time duration of one single pulse.

### 7.4 EUT Operating Condition

The EUT was set to the Hopping Mode by the Customer.

### 7.5 Test Equipment

Description	Manufacturer	Model No.	Serial No.	Cal. Date	Cal. Date
Spectrum Analyzer	ROHDE& SCHWARZ	FSEA20	DE25181	2012-08-07	2013-08-06



## 7.6 Test Data

### DH1

CH Low:  $0.540 \times (1600/2) / 79 \times 31.60 = 172.80(\text{ms})$

CH Mid:  $0.540 \times (1600/2) / 79 \times 31.60 = 172.80(\text{ms})$

CH High:  $0.530 \times (1600/2) / 79 \times 31.60 = 169.60(\text{ms})$

CH	Pulse Time (ms)	Total of Dwell (ms)	Period Time (s)	Limit (ms)	Result
Low	0.540	172.80	31.60	400	PASS
Mid	0.540	172.80	31.60		PASS
High	0.530	169.60	31.60		PASS

Please refer to the following data:

### CH: Low

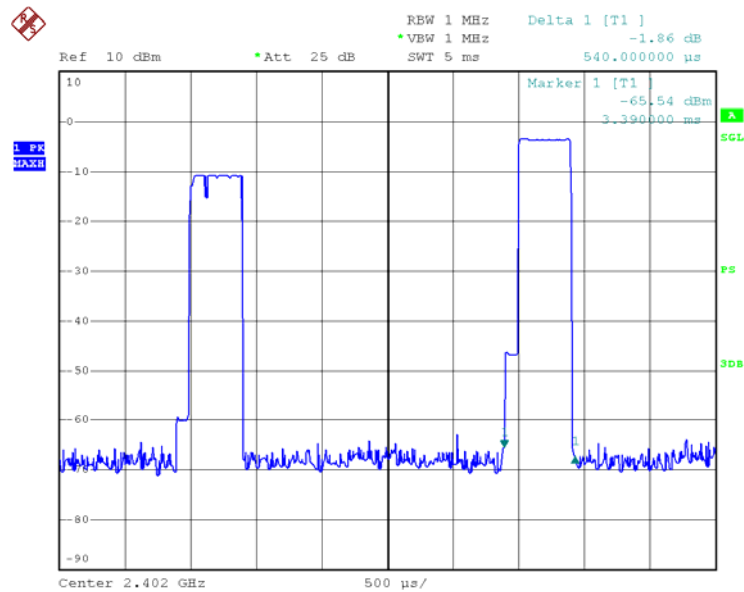

Date: 29.OCT.2012 14:27:15

**CH: Mid**

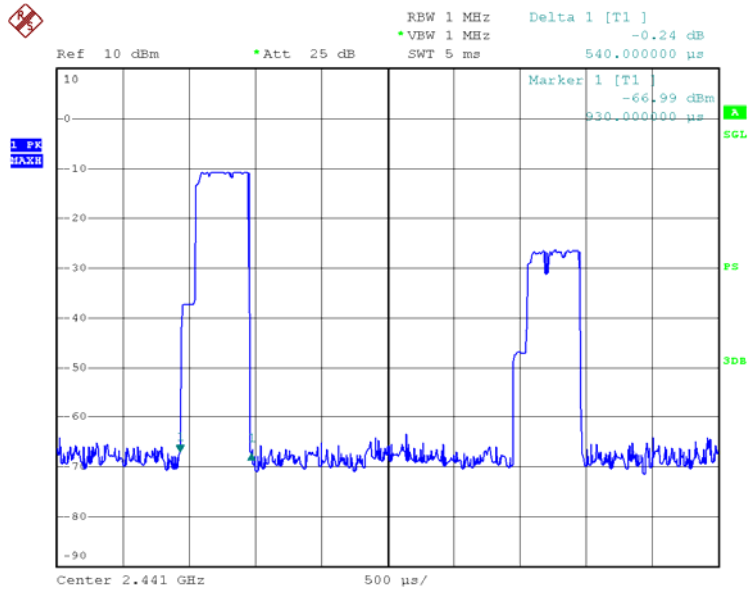

Date: 29.OCT.2012 14:27:52

**CH: High**

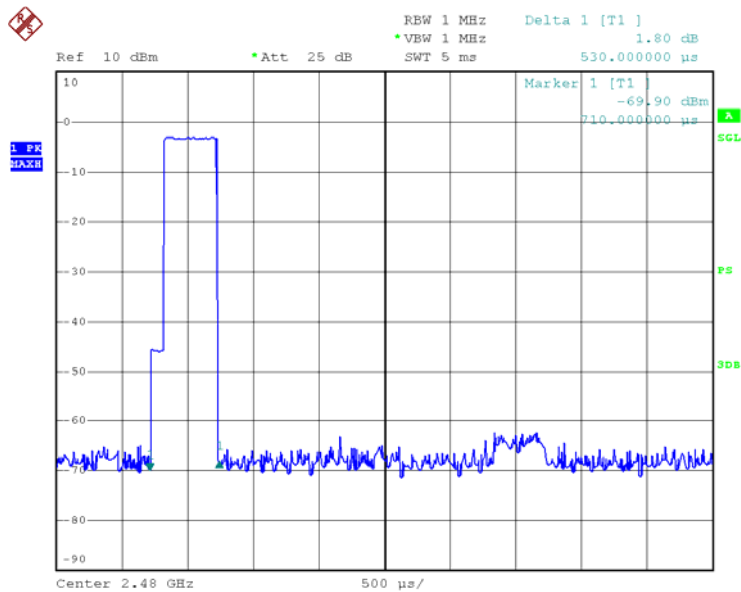

Date: 29.OCT.2012 14:29:01

**DH3**

CH Low:  $1.800 \times (1600/4) / 79 \times 31.60 = 288.00$  (ms)  
 CH Mid:  $1.800 \times (1600/4) / 79 \times 31.60 = 288.000$ (ms)  
 CH High:  $1.800 \times (1600/4) / 79 \times 31.60 = 288.00$  (ms)

CH	Pulse Time (ms)	Total of Dwell (ms)	Period Time (s)	Limit (ms)	Result
Low	1.800	288.00	31.60	400	PASS
Mid	1.800	288.00	31.60		PASS
High	1.800	288.00	31.60		PASS

Please refer to the following data:

**CH: Low**

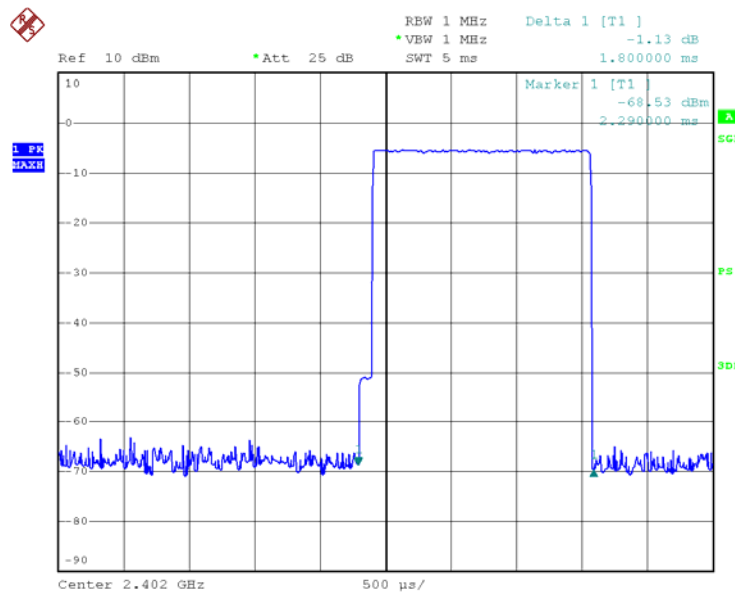

Date: 29.OCT.2012 14:37:23

**CH: Mid**

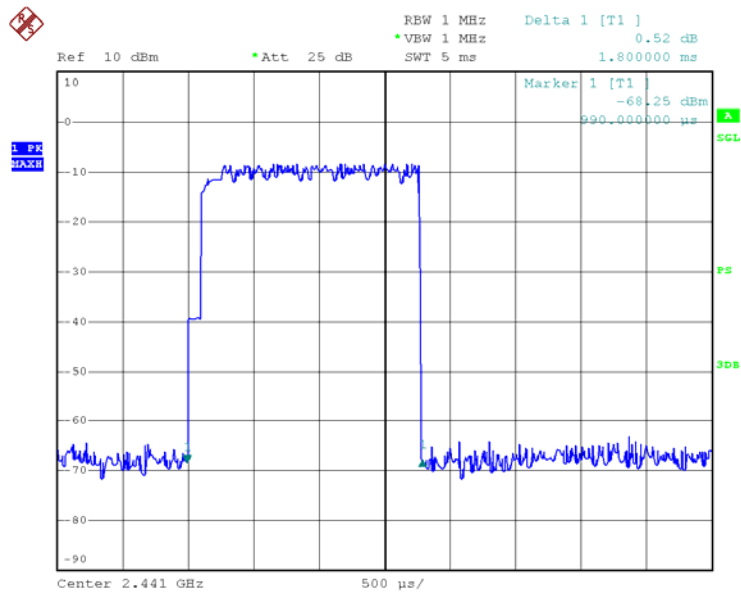

Date: 29.OCT.2012 14:34:53

**CH: High**

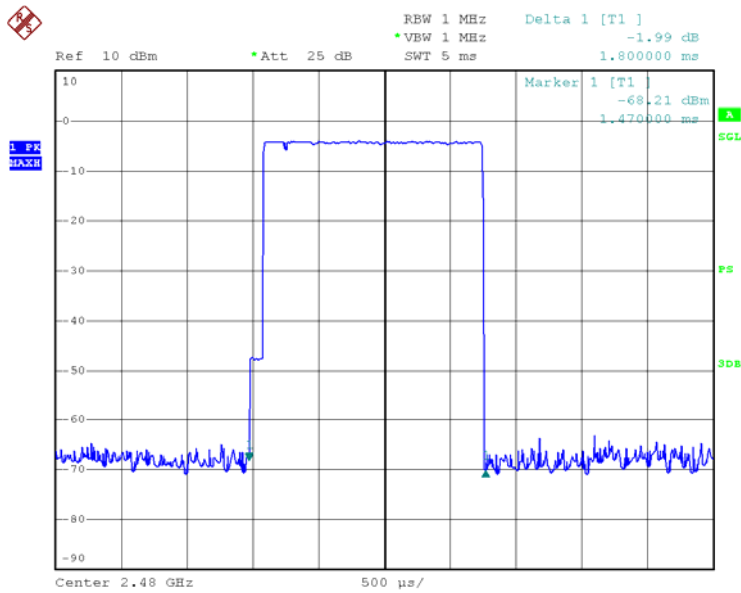

Date: 29.OCT.2012 14:33:47

**DH5**

CH Low:  $3.04 \times (1600/6) / 79 \times 31.60 = 324.27$  (ms)  
 CH Mid:  $3.06 \times (1600/6) / 79 \times 31.60 = 326.40$  (ms)  
 CH High:  $2.94 \times (1600/6) / 79 \times 31.60 = 313.60$  (ms)

CH	Pulse Time (ms)	Total of Dwell (ms)	Period Time (s)	Limit (ms)	Result
Low	3.04	324.27	31.60	400	PASS
Mid	3.06	326.40	31.60		PASS
High	2.94	313.60	31.60		PASS

Please refer to the following data:

**CH: Low**

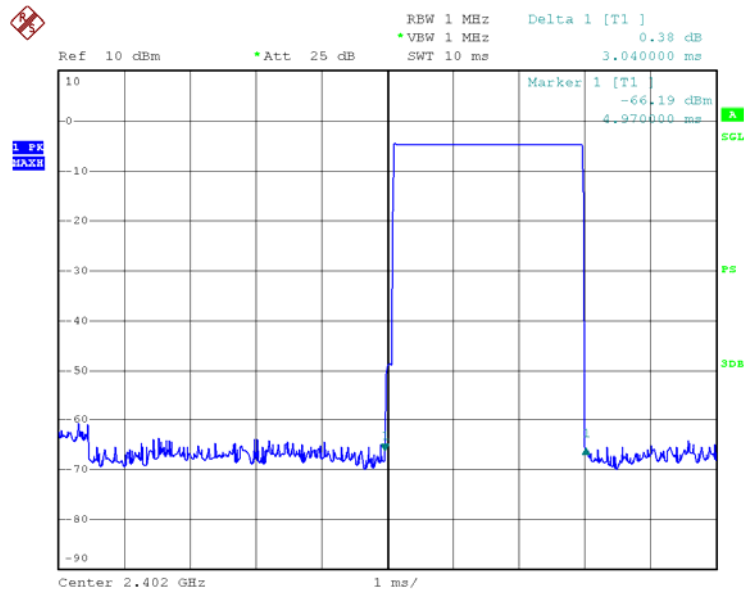

Date: 29.OCT.2012 14:38:15

## CH: Mid

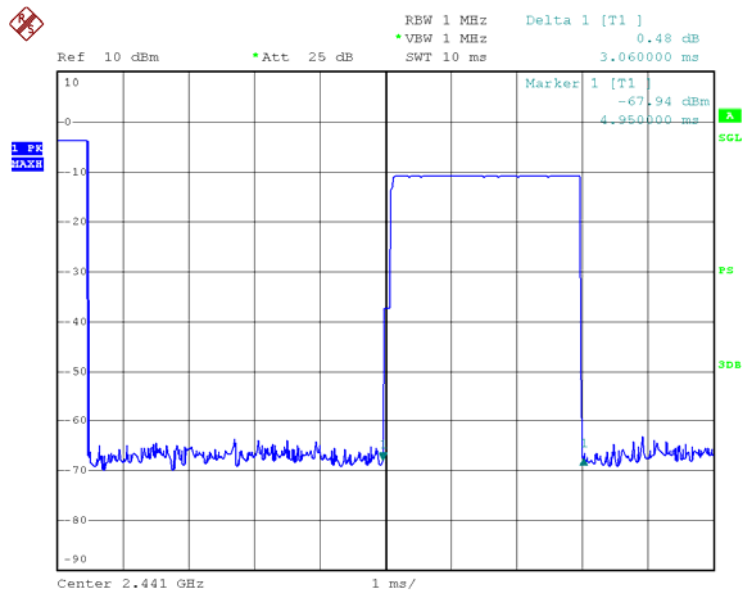

Date: 29.OCT.2012 14:39:24

## CH: High

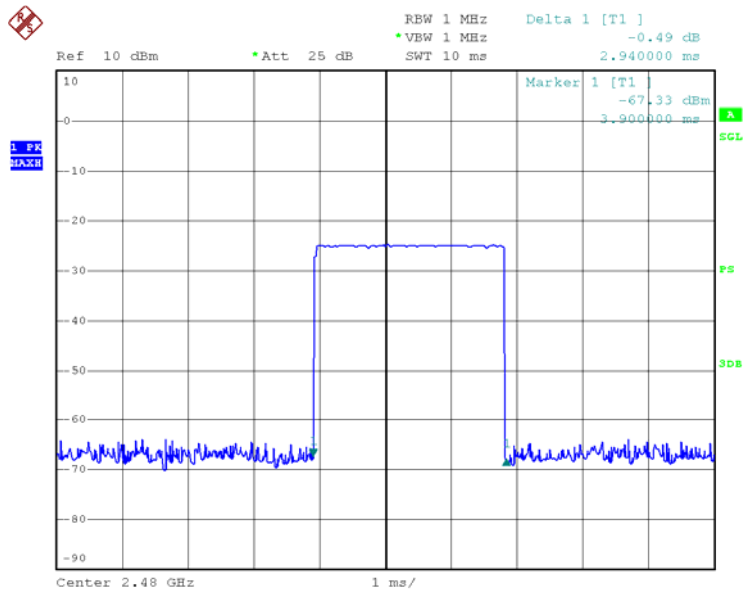

Date: 29.OCT.2012 14:41:19

## 8. Channel Separation and Bandwidth Test

### 8.1 Test Standard and Limit

#### 8.1.1 Test Standard

FCC Part 15.247/ RSS-210 Annex 8(A8.1d)

#### 8.1.2 Test Limit

Test Item	Limit	Frequency Range(MHz)
Bandwidth	$\leq 1$ MHz (20dB bandwidth)	2400~2483.5
Channel Separation	$>25$ kHz or $>$ two-thirds of the 20 dB bandwidth Which is greater	2400~2483.5

### 8.2 Test Setup

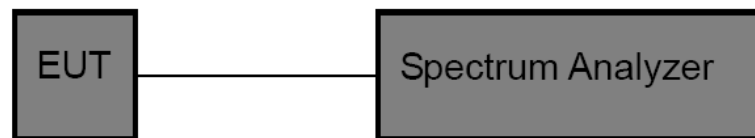

### 8.3 Test Procedure

- (1) The EUT was directly connected to the spectrum analyzer and antenna output port as show in the block diagram above.
- (2) Spectrum Setting:  
 Channel Separation: RBW=30 kHz, VBW=100 kHz.  
 Bandwidth: RBW=10 kHz, VBW=30 kHz.
- (3) The bandwidth is measured at an amplitude level reduced 20dB from the reference level. The reference level is the level of the highest amplitude signal observed from the transmitter at the fundamental frequency. Once the reference level is established, the equipment is conditioned with typical modulating signal to produce the worst –case (i.e the widest) bandwidth.
- (4) Measure the channel separation the spectrum analyzer was set to Resolution Bandwidth:30 kHz, and Video Bandwidth:100 kHz. Sweep Time set auto.

### 8.4 EUT Operating Condition

The EUT was set to the Hopping Mode for Channel Separation Test and continuously transmitting for the Bandwidth Test.

## 8.5 Test Equipment

Description	Manufacturer	Model No.	Serial No.	Cal. Date	Cal. Date
Spectrum Analyzer	ROHDE& SCHWARZ	FSEA20	DE25181	2012-08-07	2013-08-06

## 8.6 Test Data

Channel frequency (MHz)	99% OBW (kHz)	20dB Bandwidth (kHz)	Read Value*2/3 (kHz)
2402	918.00	1032.00	688.00
2441	918.00	1020.00	680.00
2480	906.00	1026.00	684.00

### 2402 MHz

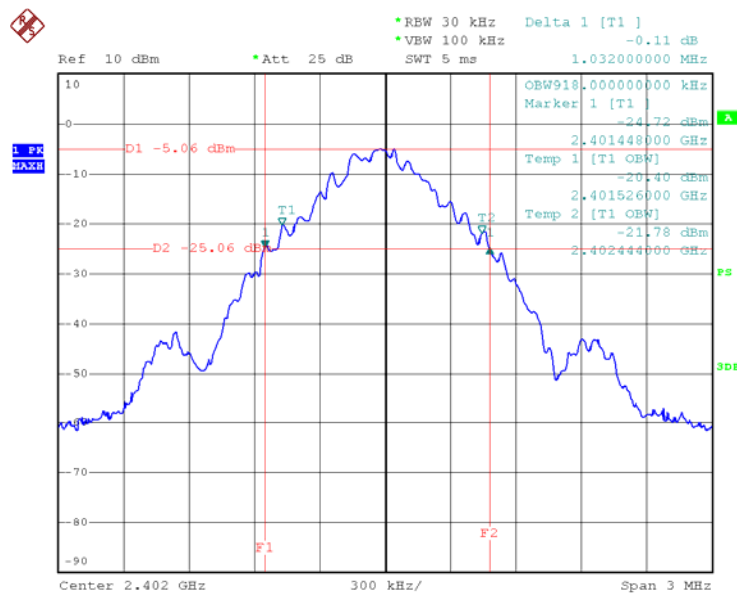

Date: 24.OCT.2012 17:32:14



## 2441 MHz

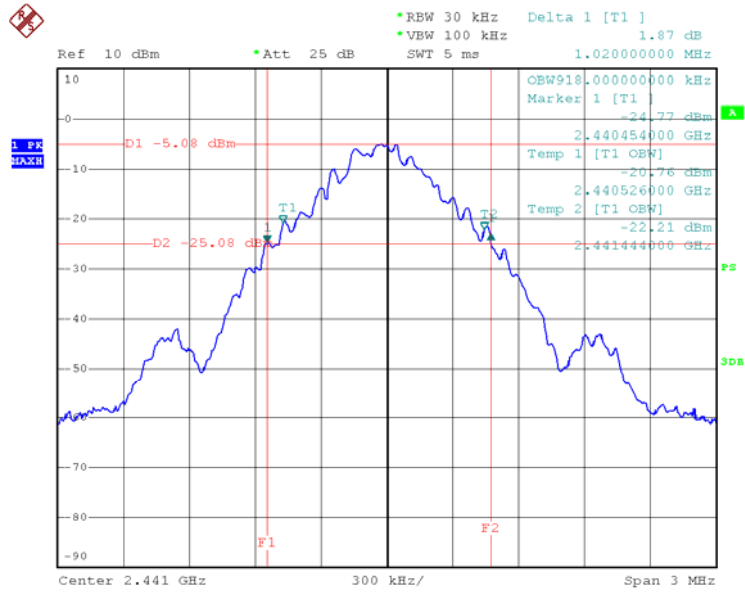

Date: 24.OCT.2012 17:54:35

## 2480 MHz

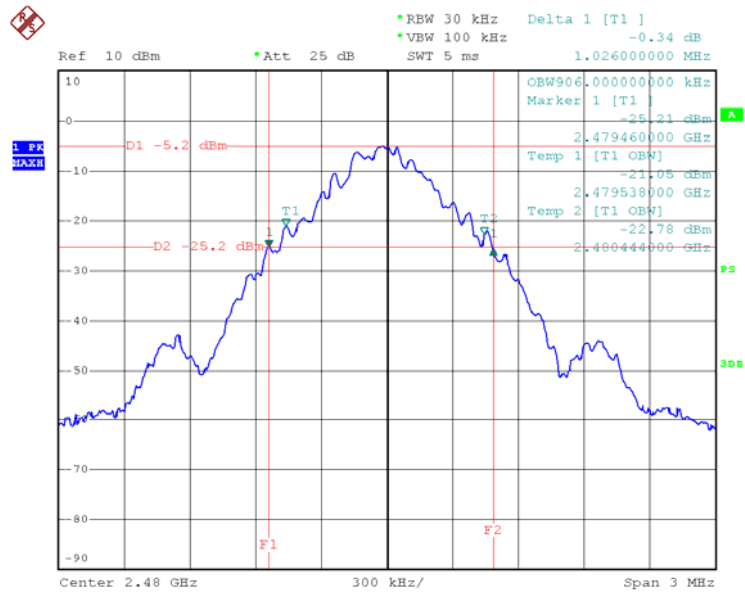

Date: 24.OCT.2012 17:37:09

Channel number	Channel frequency (MHz)	Separation Read Value (kHz)	Separation Limit (kHz)
CH 00	2402	1002.00	>688.00 kHz
CH 39	2441	1038.00	>680.00 kHz
CH 78	2480	1080.00	>684.00 kHz

**2402 MHz**

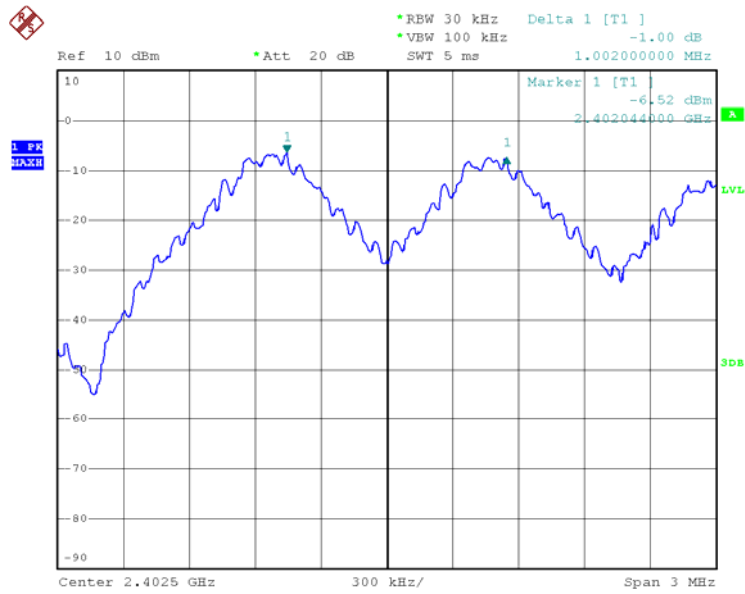

Date: 24.OCT.2012 16:01:16

### 2441 MHz

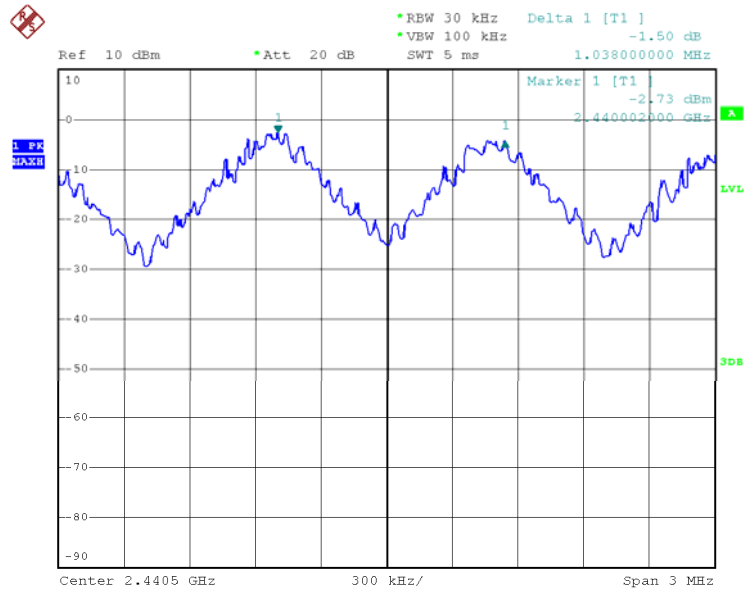

Date: 24.OCT.2012 16:12:38

### 2480 MHz

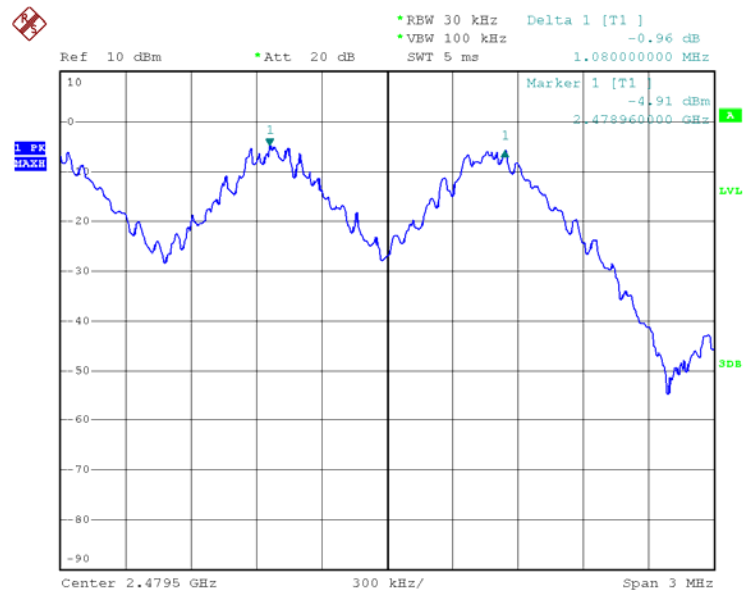

Date: 24.OCT.2012 16:17:04

## 9. Peak Output Power Test

### 9.1 Test Standard and Limit

#### 9.1.1 Test Standard

FCC Part 15.247 (b) (1)/ RSS-210 Annex 8(A8.1(b))

#### 9.1.2 Test Limit

Test Item	Limit	Frequency Range(MHz)
Peak Output Power	Hopping Channels>75 Power<1W(30dBm) Other <125 mW(21dBm)	2400~2483.5

### 9.2 Test Setup

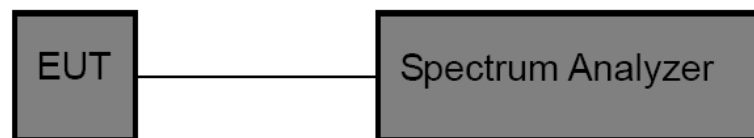

### 9.3 Test Procedure

- (1) The EUT was directly connected to the spectrum analyzer and antenna output port as show in the block diagram above.
- (2) Spectrum Setting:  
Channel Separation: RBW=1 MHz, VBW=1 MHz.

### 9.4 EUT Operating Condition

The EUT was set to continuously transmitting in the max power during the test.

### 9.5 Test Equipment

Description	Manufacturer	Model No.	Serial No.	Cal. Date	Cal. Date
Spectrum Analyzer	ROHDE& SCHWARZ	FSEA20	DE25181	2012-08-07	2013-08-06

### 8.6 Test Data

Channel number	Channel frequency (MHz)	Test Result (dBm)	Limit
CH 00	2402	-2.15	1W(30dBm)
CH 39	2441	-2.23	1W(30dBm)
CH 78	2480	-2.49	1W(30dBm))

### 2402 Power

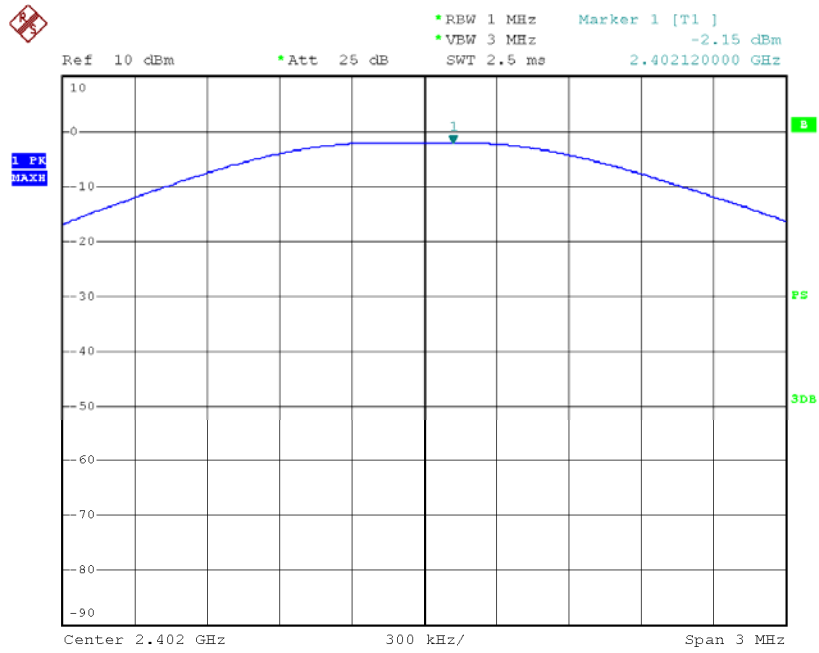

Date: 24.OCT.2012 17:31:26

### 2441 Power

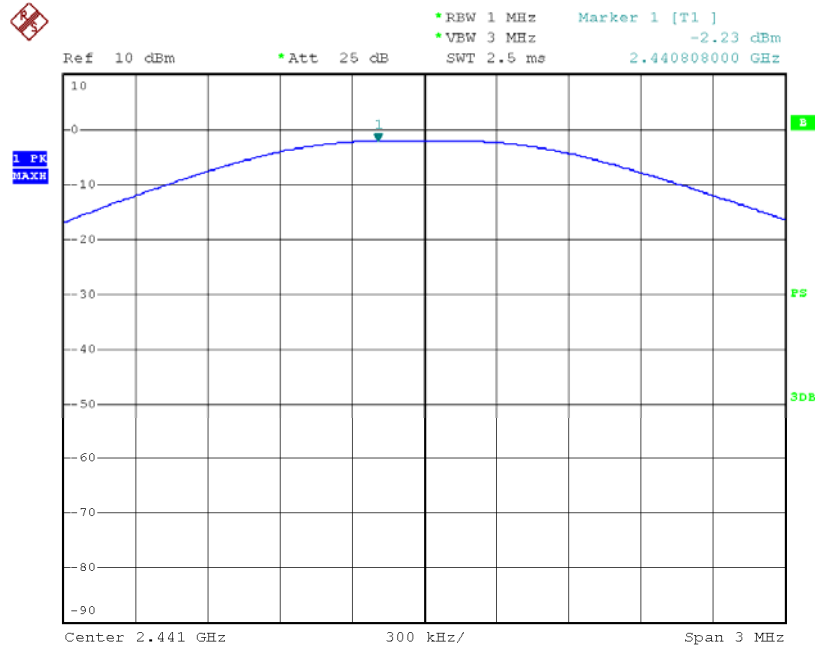

Date: 24.OCT.2012 17:53:45

### 2480 Power

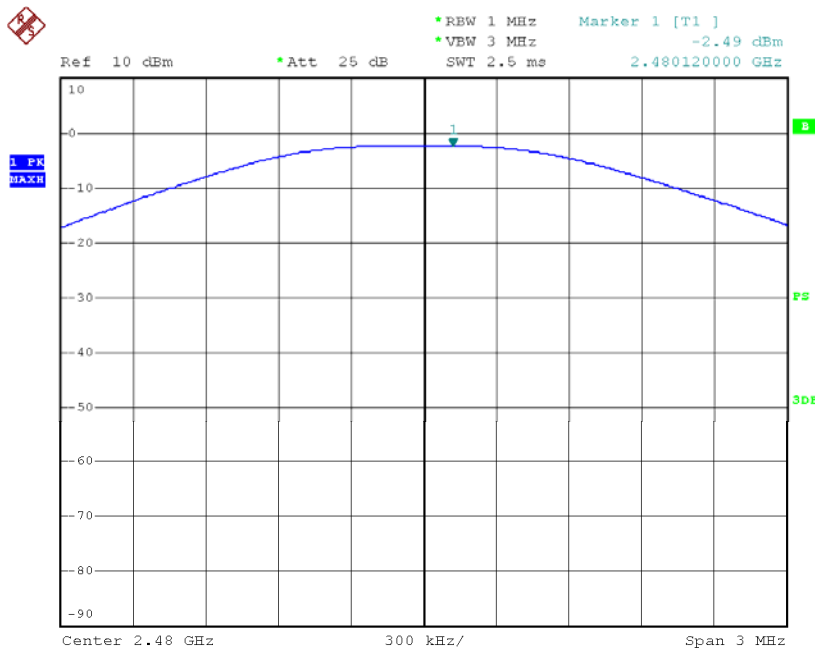

Date: 24.OCT.2012 17:37:40

## 10. Antenna Conducted Spurious Emission

### 10.1 Test Standard and Limit

#### 10.1.1 Test Standard

FCC Part 15.247 (d)/ RSS-210 Annex 8 (A8.1d)

#### 10.1.2 Test Limit

In any 100 kHz bandwidth outside the frequency band in which the spread spectrum or digitally modulated intentional radiator is operating, the radio frequency power that is produced by the intentional radiator shall be at least 20 dB below that in the 100 kHz bandwidth within the band that contains the highest level of the desired power. In case the emission fall within the restricted band specified on 15.205(a), then the 15.209(a) limit in the table below has to be followed.

Frequencies (MHz)	Field Strength (microvolt/meter)	Measurement Distance (meters)
0.009~0.490	2400/F(KHz)	300
0.490~1.705	24000/F(KHz)	30
1.705~30.0	30	30
30~88	100	3
88~216	150	3
216~960	200	3
Above~960	500	3

### 10.2 Test Setup

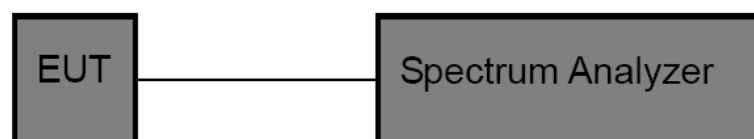

### 10.3 Test Procedure

- (1) The EUT was directly connected to the spectrum analyzer and antenna output port as show in the block diagram above.
- (2) Spectrum Setting:  
 RBW=100 KHz, VBW=100 KHz.  
 Frequency range from 30MHz to 25 GHz.

---

## 10.4 EUT Operating Condition

The EUT was set to continuously transmitting in the max power during the test.

## 10.5 Test Equipment

Description	Manufacturer	Model No.	Serial No.	Cal. Date	Cal. Date
Spectrum Analyzer	ROHDE& SCHWARZ	FSEA20	DE25181	2012-08-07	2013-08-06

## 10.6 Test Data



**TX CH 00 2402MHz**

**Above 1 GHz**

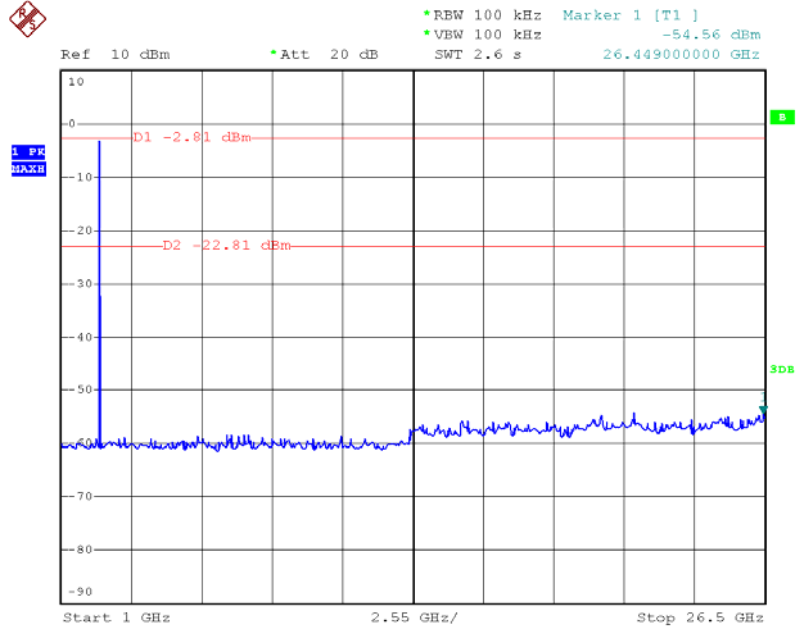

Date: 27.OCT.2012 19:25:05

**Bellow 1 GHz**

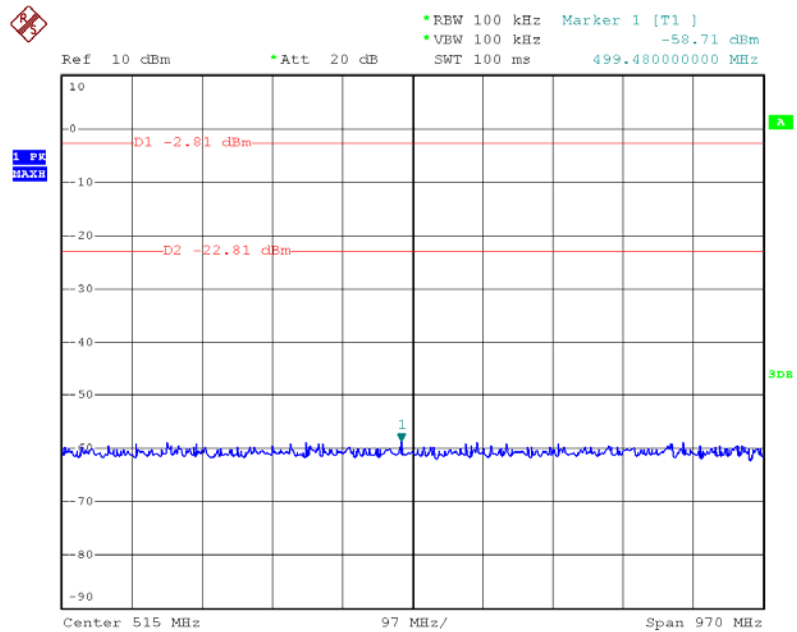

Date: 27.OCT.2012 19:25:28

**TX CH 39 2441MHz**

**Above 1 GHz**

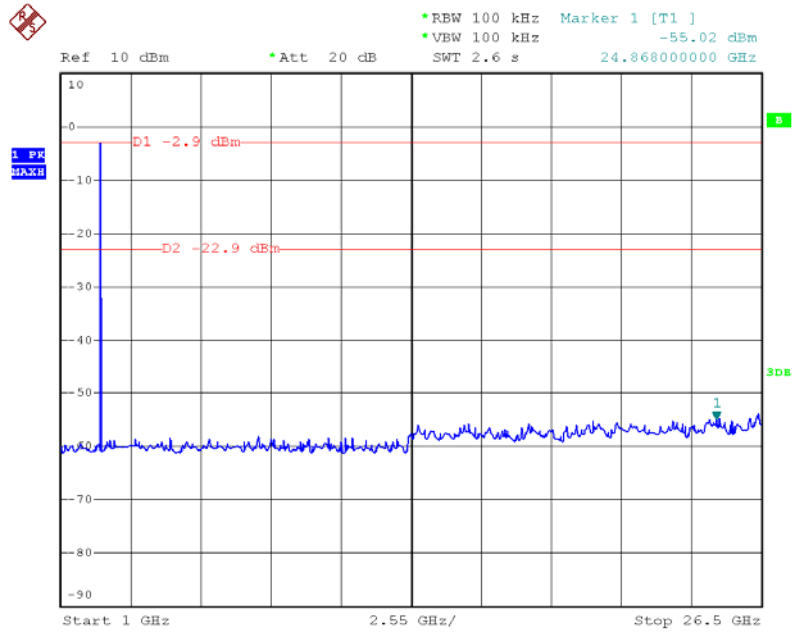

Date: 27.OCT.2012 19:18:46

**Bellow 1 GHz**

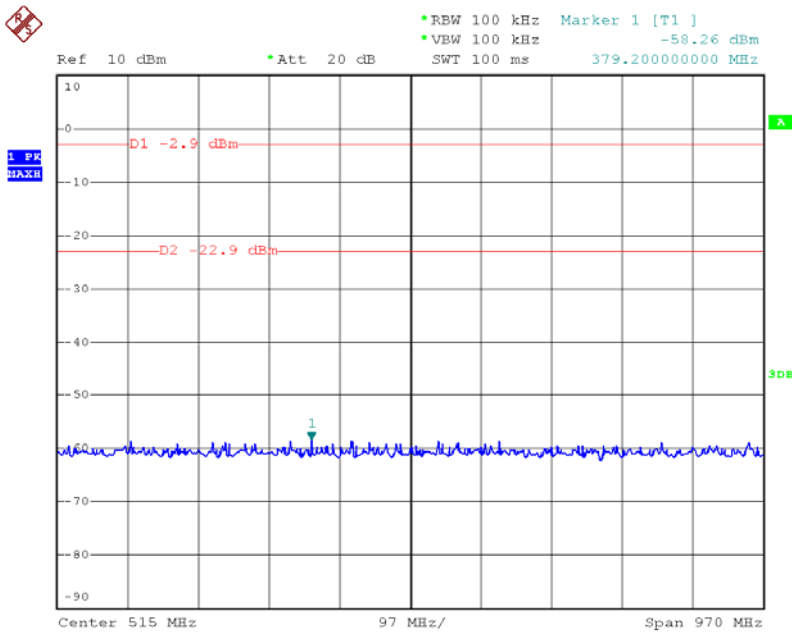

Date: 27.OCT.2012 19:19:19

TX CH 79 2480MHz

Above 1 GHz

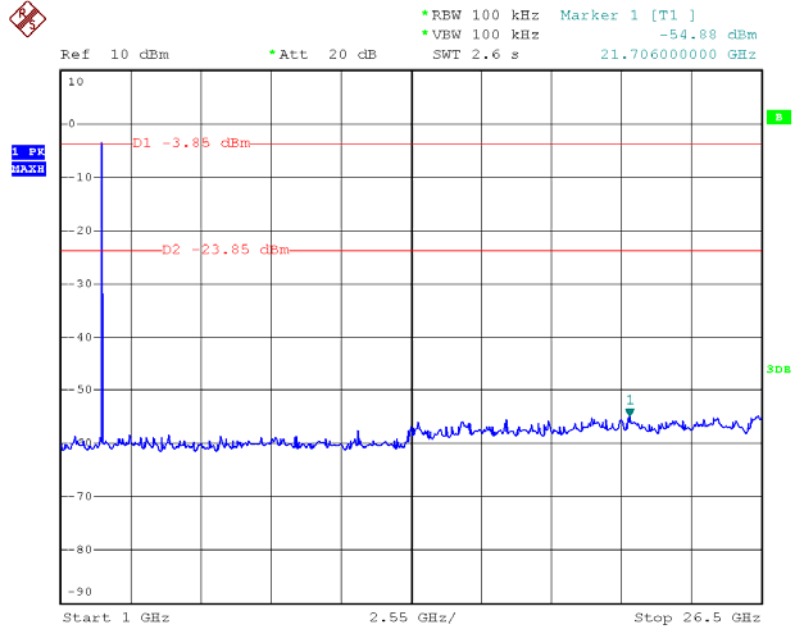

Date: 27.OCT.2012 19:17:44

Bellow 1 GHz

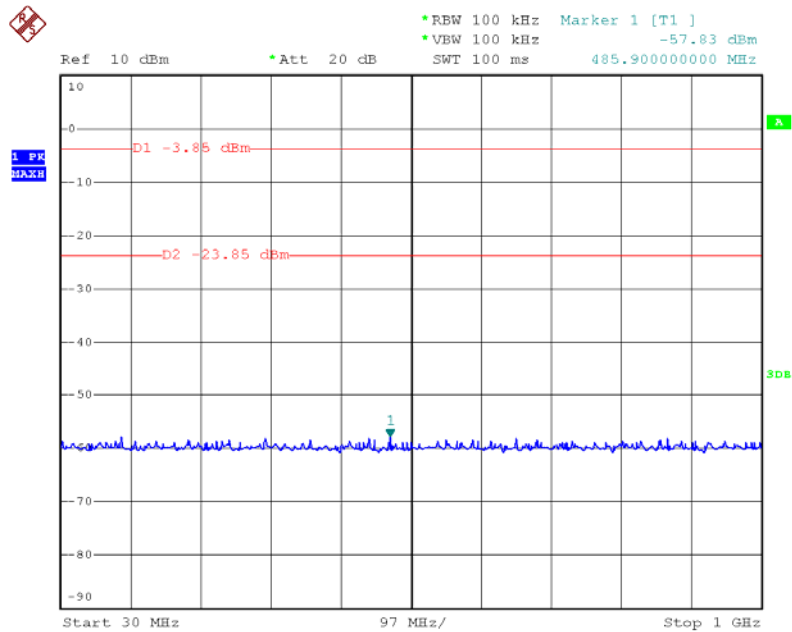

Date: 27.OCT.2012 19:16:39

## 11. Antenna Requirement

### 11.1 Standard Requirement

#### 11.1.1 Standard

FCC Part 15.203/ RSS-210 Annex 8(A8.5)

#### 11.1.2 Requirement

An intentional radiator shall be designed to ensure that no antenna other than that furnished by the responsible party shall be used with the device. The use of a permanently attached antenna or of an antenna that uses a unique coupling to the intentional radiator shall be considered sufficient to comply with the provisions of this Section. The manufacturer may design the unit so that a broken antenna can be replaced by the user, but the use of a standard antenna jack or electrical connector is prohibited.

### 11.2 Antenna Connected Construction

The directional gains of the antenna used for transmitting is 1.87 dBi, and the antenna connector is de-signed with permanent attachment and no consideration of replacement. Please see the EUT photo for details.

### 11.2 Result

The EUT antenna is a printed Antenna. It complies with the standard requirement.