



Shenzhen Huaxia Testing Technology Co., Ltd

1F., Block A of Tongsheng Technology Building, Huahui Road, Dalang Street, Longhua District, Shenzhen, China

Telephone: +86-755-26648640
Fax: +86-755-26648637
Website: www.cqa-cert.com

Report Template Version: V03
Report Template Revision Date: Mar.1st, 2017

Test Report

Report No. : CQASZ20181000025E-01
Applicant: ZAGG Inc.
Address of Applicant: 910 West Legacy Center Way, Midvale, Utah, United States, 84047
Manufacturer: ZAGG Inc.
Address of Manufacturer: 910 West Legacy Center Way, Midvale, Utah, United States, 84047
Factory: Dongguan Kailai Eletronic Co.,Ltd
Address of Factory: No 36# Industrial Main Road, 2nd District (Shahukou), Eastern Industrial Park, Changping Town, Dongguan City, Guangdong Province, China

Equipment Under Test (EUT):
Product: Little Rockerz Wireless Headphones
All Model No.: IFOEW29-I, 304101849, 304101850
Test Model No.: IFOEW29-I
Brand Name: IFROGZ
FCC ID: QTG-IFAYLR
Standards: 47 CFR Part 15, Subpart C
Date of Test: 2018-10-17 to 2018-10-23
Date of Issue: 2018-10-23
Test Result : **PASS***

Tested By:

(Daisy Qin)

Reviewed By:

(Aaron Ma)

Approved By:

(Jack Ai)



* In the configuration tested, the EUT complied with the standards specified above.

The test report is effective only with both signature and specialized stamp, The result(s) shown in this report refer only to the sample(s) tested. Without written approval of CQA, this report can't be reproduced except in full.

1 Version

Revision History Of Report

Report No.	Version	Description	Issue Date
CQASZ20181000025E-01	Rev.01	Initial report	2018-10-23

2 Test Summary

Test Item	Test Requirement	Test method	Result
Antenna Requirement	47 CFR Part 15, Subpart C Section 15.203/15.247 (c)	ANSI C63.10 (2013)	PASS
AC Power Line Conducted Emission	47 CFR Part 15, Subpart C Section 15.207	ANSI C63.10 (2013)	N/A
Conducted Peak Output Power	47 CFR Part 15, Subpart C Section 15.247 (b)(1)	ANSI C63.10 (2013)	PASS
20dB Occupied Bandwidth	47 CFR Part 15, Subpart C Section 15.247 (a)(1)	ANSI C63.10 (2013)	PASS
Carrier Frequencies Separation	47 CFR Part 15, Subpart C Section 15.247 (a)(1)	ANSI C63.10 (2013)	PASS
Hopping Channel Number	47 CFR Part 15, Subpart C Section 15.247 (a)(1)	ANSI C63.10 (2013)	PASS
Dwell Time	47 CFR Part 15, Subpart C Section 15.247 (a)(1)	ANSI C63.10 (2013)	PASS
Pseudorandom Frequency Hopping Sequence	47 CFR Part 15, Subpart C Section 15.247(b)(4)&TCB Exclusion List (7 July 2002)	ANSI C63.10 (2013)	PASS
Band-edge for RF Conducted Emissions	47 CFR Part 15, Subpart C Section 15.247(d)	ANSI C63.10 (2013)	PASS
RF Conducted Spurious Emissions	47 CFR Part 15, Subpart C Section 15.247(d)	ANSI C63.10 (2013)	PASS
Radiated Spurious emissions	47 CFR Part 15, Subpart C Section 15.205/15.209	ANSI C63.10 (2013)	PASS
Restricted bands around fundamental frequency (Radiated Emission)	47 CFR Part 15, Subpart C Section 15.205/15.209	ANSI C63.10 (2013)	PASS

N/A: Not Applicable

Note: When the EUT charging, BT will not work.

3 Contents

	Page
1 VERSION	2
2 TEST SUMMARY	3
3 CONTENTS	4
4 GENERAL INFORMATION	5
4.1 CLIENT INFORMATION.....	5
4.2 GENERAL DESCRIPTION OF EUT	5
4.3 TEST ENVIRONMENT	7
4.4 DESCRIPTION OF SUPPORT UNITS	7
4.5 STATEMENT OF THE MEASUREMENT UNCERTAINTY	7
4.6 TEST LOCATION.....	7
4.7 TEST FACILITY	8
4.8 ABNORMALITIES FROM STANDARD CONDITIONS.....	8
4.9 OTHER INFORMATION REQUESTED BY THE CUSTOMER	8
4.10 EQUIPMENT LIST.....	9
5 TEST RESULTS AND MEASUREMENT DATA	10
5.1 ANTENNA REQUIREMENT.....	10
5.2 CONDUCTED PEAK OUTPUT POWER	11
5.3 20DB OCCUPY BANDWIDTH	18
5.4 CARRIER FREQUENCIES SEPARATION	24
5.5 HOPPING CHANNEL NUMBER.....	31
5.6 DWELL TIME	34
5.7 BAND-EDGE FOR RF CONDUCTED EMISSIONS	50
5.8 SPURIOUS RF CONDUCTED EMISSIONS	58
5.9 OTHER REQUIREMENTS FREQUENCY HOPPING SPREAD SPECTRUM SYSTEM.....	86
5.10 RADIATED SPURIOUS EMISSION & RESTRICTED BANDS.....	88
5.10.1 Radiated Emission below 1GHz	91
5.10.2 Transmitter Emission above 1GHz.....	93
6 PHOTOGRAPHS - EUT TEST SETUP	94
6.1 RADIATED EMISSION	94
7 PHOTOGRAPHS - EUT CONSTRUCTIONAL DETAILS	96

4 General Information

4.1 Client Information

Applicant:	ZAGG Inc.
Address of Applicant:	910 West Legacy Center Way, Midvale, Utah, United States, 84047
Manufacturer:	ZAGG Inc.
Address of Manufacturer:	910 West Legacy Center Way, Midvale, Utah, United States, 84047
Factory:	Dongguan Kailai Eletronic Co.,Ltd
Address of Factory:	No 36# Industrial Main Road, 2nd District (Shahukou), Eastern Industrial Park, Changping Town, Dongguan City, Guangdong Province, China

4.2 General Description of EUT

Product Name:	Little Rockerz Wireless Headphones
All Model No.:	IFOEW29-I, 304101849, 304101850
Test Model No.:	IFOEW29-I
Trade Mark:	IFROGZ
Hardware Version:	V1.0
Software Version:	V1.0
Operation Frequency:	2402MHz~2480MHz
Bluetooth Version:	V4.1
Modulation Technique:	Frequency Hopping Spread Spectrum(FHSS)
Modulation Type:	GFSK, $\pi/4$ DQPSK, 8DPSK
Transfer Rate:	1Mbps/2Mbps/3Mbps
Number of Channel:	79
Hopping Channel Type:	Adaptive Frequency Hopping systems
Product Type:	<input type="checkbox"/> Mobile <input checked="" type="checkbox"/> Portable <input type="checkbox"/> Fix Location
Test Software of EUT:	Blue test (manufacturer declare)
Antenna Type:	PCB antenna
Antenna Gain:	0dBi
Power Supply:	lithium battery: DC3.7V, 180mAh, Charge by USB

Note:

All model: IFOEW29-I, 304101849, 304101850

Only the model IFOEW29-I was tested, since the electrical circuit design, layout, components used and internal wiring were identical for the above models, with difference being color of appearance and model name.

Operation Frequency each of channel							
Channel	Frequency	Channel	Frequency	Channel	Frequency	Channel	Frequency
0	2402MHz	20	2422MHz	40	2442MHz	60	2462MHz
1	2403MHz	21	2423MHz	41	2443MHz	61	2463MHz
2	2404MHz	22	2424MHz	42	2444MHz	62	2464MHz
3	2405MHz	23	2425MHz	43	2445MHz	63	2465MHz
4	2406MHz	24	2426MHz	44	2446MHz	64	2466MHz
5	2407MHz	25	2427MHz	45	2447MHz	65	2467MHz
6	2408MHz	26	2428MHz	46	2448MHz	66	2468MHz
7	2409MHz	27	2429MHz	47	2449MHz	67	2469MHz
8	2410MHz	28	2430MHz	48	2450MHz	68	2470MHz
9	2411MHz	29	2431MHz	49	2451MHz	69	2471MHz
10	2412MHz	30	2432MHz	50	2452MHz	70	2472MHz
11	2413MHz	31	2433MHz	51	2453MHz	71	2473MHz
12	2414MHz	32	2434MHz	52	2454MHz	72	2474MHz
13	2415MHz	33	2435MHz	53	2455MHz	73	2475MHz
14	2416MHz	34	2436MHz	54	2456MHz	74	2476MHz
15	2417MHz	35	2437MHz	55	2457MHz	75	2477MHz
16	2418MHz	36	2438MHz	56	2458MHz	76	2478MHz
17	2419MHz	37	2439MHz	57	2459MHz	77	2479MHz
18	2420MHz	38	2440MHz	58	2460MHz	78	2480MHz
19	2421MHz	39	2441MHz	59	2461MHz		

Note:

In section 15.31(m), regards to the operating frequency range over 10 MHz, the Lowest frequency, the middle frequency, and the highest frequency of channel were selected to perform the test, and the selected channel see below:

Channel	Frequency
The Lowest channel	2402MHz
The Middle channel	2441MHz
The Highest channel	2480MHz

4.3 Test Environment

Operating Environment:	
Temperature:	25.0 °C
Humidity:	53 % RH
Atmospheric Pressure:	995mbar
Test Mode:	Use test software to set the lowest frequency, the middle frequency and the highest frequency keep transmitting of the EUT.

4.4 Description of Support Units

The EUT has been tested with associated equipment below.

Description	Manufacturer	Model No.	Remark	FCC certification
PC	Lenovo	ThinkPad E450c	Provide by lab	ID
Adapter	Samsung	EP-TA50CBC	Provide by lab	Verification

4.5 Statement of the measurement uncertainty

The data and results referenced in this document are true and accurate.

The reader is cautioned that there may be errors within the calibration limits of the equipment and facilities.

The measurement uncertainty was calculated for all measurements listed in this test report acc. to CISPR 16 - 4 „Specification for radio disturbance and immunity measuring apparatus and methods – Part 4: Uncertainty in EMC Measurements“ and is documented in the **Shenzhen Huaxia Testing Technology Co., Ltd.** quality system acc. to DIN EN ISO/IEC 17025.

Furthermore, component and process variability of devices similar to that tested may result in additional deviation. The manufacturer has the sole responsibility of continued compliance of the device.

Hereafter the best measurement capability for CQA laboratory is reported:

Test	Range	Uncertainty	Notes
Radiated Emission	Below 1GHz	±5.12dB	(1)
Radiated Emission	Above 1GHz	±4.60dB	(1)
Conducted Disturbance	0.15~30MHz	±3.34dB	(1)

(1) This uncertainty represents an expanded uncertainty expressed at approximately the 95% confidence level using a coverage factor of k=2.

4.6 Test Location

Shenzhen Huaxia Testing Technology Co., Ltd,

1F., Block A of Tongsheng Technology Building, Huahui Road, Dalang Street, Longhua District, Shenzhen, China

4.7 Test Facility

The test facility is recognized, certified, or accredited by the following organizations:

IC Registration No.: 22984-1

The 3m Semi-anechoic chamber of Shenzhen Huaxia Testing Technology Co., Ltd. has been registered by Certification and Engineering Bureau of Industry Canada for radio equipment testing

The test facility is recognized, certified, or accredited by the following organizations:

• **CNAS (No. CNAS L5785)**

CNAS has accredited Shenzhen Huaxia Testing Technology Co., Ltd. Shenzhen Branch EMC Lab to ISO/IEC 17025:2005 General Requirements for the Competence of Testing and Calibration Laboratories (CNAS-CL01 Accreditation Criteria for the Competence of Testing and Calibration Laboratories) for the competence in the field of testing.

• **A2LA (Certificate No. 4742.01)**

Shenzhen Huaxia Testing Technology Co., Ltd., Shenzhen EMC Laboratory is accredited by the American Association for Laboratory Accreditation(A2LA). Certificate No. 4742.01.

• **FCC Registration No.: 522263**

Shenzhen Huaxia Testing Technology Co., Ltd., Shenzhen EMC Laboratory has been registered and fully described in a report filed with the (FCC) Federal Communications Commission. The acceptance letter from the FCC is maintained in our files. Registration No.:522263

4.8 Abnormalities from Standard Conditions

None.

4.9 Other Information Requested by the Customer

None.

4.10 Equipment List

Item	Test Equipment	Manufacturer	Model No.	Instrument No.	Calibration Due Date
1	EMI Test Receiver	R&S	ESR7	CQA-005	2019/9/25
2	Spectrum analyzer	R&S	FSU26	CQA-038	2019/9/25
3	Preamplifier	MITEQ	AFS4-00010300-18-10P-4	CQA-035	2019/9/25
4	Preamplifier	MITEQ	AMF-6D-02001800-29-20P	CQA-036	2019/9/25
5	Loop antenna	Schwarzbeck	FMZB1516	CQA-087	2019/9/25
6	Bilog Antenna	R&S	HL562	CQA-011	2019/9/25
7	Horn Antenna	R&S	HF906	CQA-012	2019/9/25
8	Horn Antenna	Schwarzbeck	BBHA 9170	CQA-088	2019/9/25
9	Coaxial Cable (Above 1GHz)	CQA	N/A	C019	2019/9/25
10	Coaxial Cable (Below 1GHz)	CQA	N/A	C020	2019/9/25
11	Antenna Connector	CQA	RFC-01	CQA-080	2019/9/25
12	RF cable(9KHz~40GHz)	CQA	RF-01	CQA-079	2019/9/25
13	Power Sensor	KEYSIGHT	U2021XA	CQA-30	2019/9/25
14	N1918A Power Analysis Manager Power Panel	Agilent	N1918A	CQA-074	2019/9/25
15	Power divider	MIDWEST	PWD-2533-02-SMA-79	CQA-067	2019/9/25
16	EMI Test Receiver	R&S	ESPI3	CQA-005	2019/9/25
17	LISN	R&S	ENV216	CQA-003	2019/9/25
18	Coaxial cable (9KHz~300MHz)	CQA	N/A	CQA-C009	2019/9/25

Note:

The temporary antenna connector is soldered on the PCB board in order to perform conducted tests and this temporary antenna connector is listed in the equipment list.

5 Test results and Measurement Data

5.1 Antenna Requirement

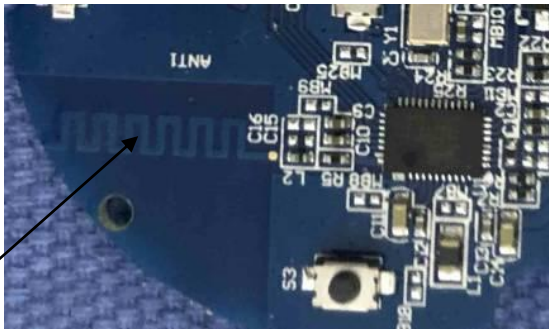
Standard requirement:	47 CFR Part 15C Section 15.203 /247(c)
<p>15.203 requirement: An intentional radiator shall be designed to ensure that no antenna other than that furnished by the responsible party shall be used with the device. The use of a permanently attached antenna or of an antenna that uses a unique coupling to the intentional radiator, the manufacturer may design the unit so that a broken antenna can be replaced by the user, but the use of a standard antenna jack or electrical connector is prohibited.</p> <p>15.247(b) (4) requirement: The conducted output power limit specified in paragraph (b) of this section is based on the use of antennas with directional gains that do not exceed 6 dBi. Except as shown in paragraph (c) of this section, if transmitting antennas of directional gain greater than 6 dBi are used, the conducted output power from the intentional radiator shall be reduced below the stated values in paragraphs (b)(1), (b)(2), and (b)(3) of this section, as appropriate, by the amount in dB that the directional gain of the antenna exceeds 6 dBi.</p>	
EUT Antenna:	
<p>The antenna is PCB antenna. The best case gain of the antenna is 0dBi.</p>	

5.2 Conducted Peak Output Power

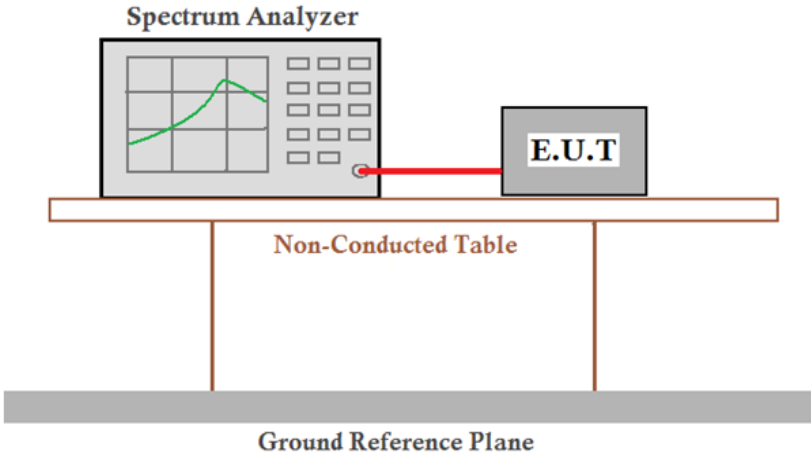
Test Requirement:	47 CFR Part 15C Section 15.247 (b)(1)
Test Method:	ANSI C63.10:2013
Test Setup:	 <p style="text-align: center;"><i>Remark: Offset=Cable loss+ attenuation factor.</i></p>
Limit:	21dBm
Exploratory Test Mode:	Non-hopping transmitting with all kind of modulation and all kind of data type
Final Test Mode:	Through Pre-scan, find the DH5 of data type is the worst case of GFSK modulation type, 2-DH5 of data type is the worst case of $\pi/4$ DQPSK modulation type, 3-DH5 of data type is the worst case of 8DPSK modulation type. Only the worst case is recorded in the report.
Test Results:	Pass

Measurement Data

GFSK mode			
Test channel	Peak Output Power (dBm)	Limit (dBm)	Result
Lowest	-0.080	21.00	Pass
Middle	-0.480	21.00	Pass
Highest	-0.890	21.00	Pass
$\pi/4$ DQPSK mode			
Test channel	Peak Output Power (dBm)	Limit (dBm)	Result
Lowest	0.140	21.00	Pass
Middle	-0.190	21.00	Pass
Highest	-0.600	21.00	Pass
8DPSK mode			
Test channel	Peak Output Power (dBm)	Limit (dBm)	Result
Lowest	0.720	21.00	Pass
Middle	0.340	21.00	Pass
Highest	-0.140	21.00	Pass

Test plot as follows:

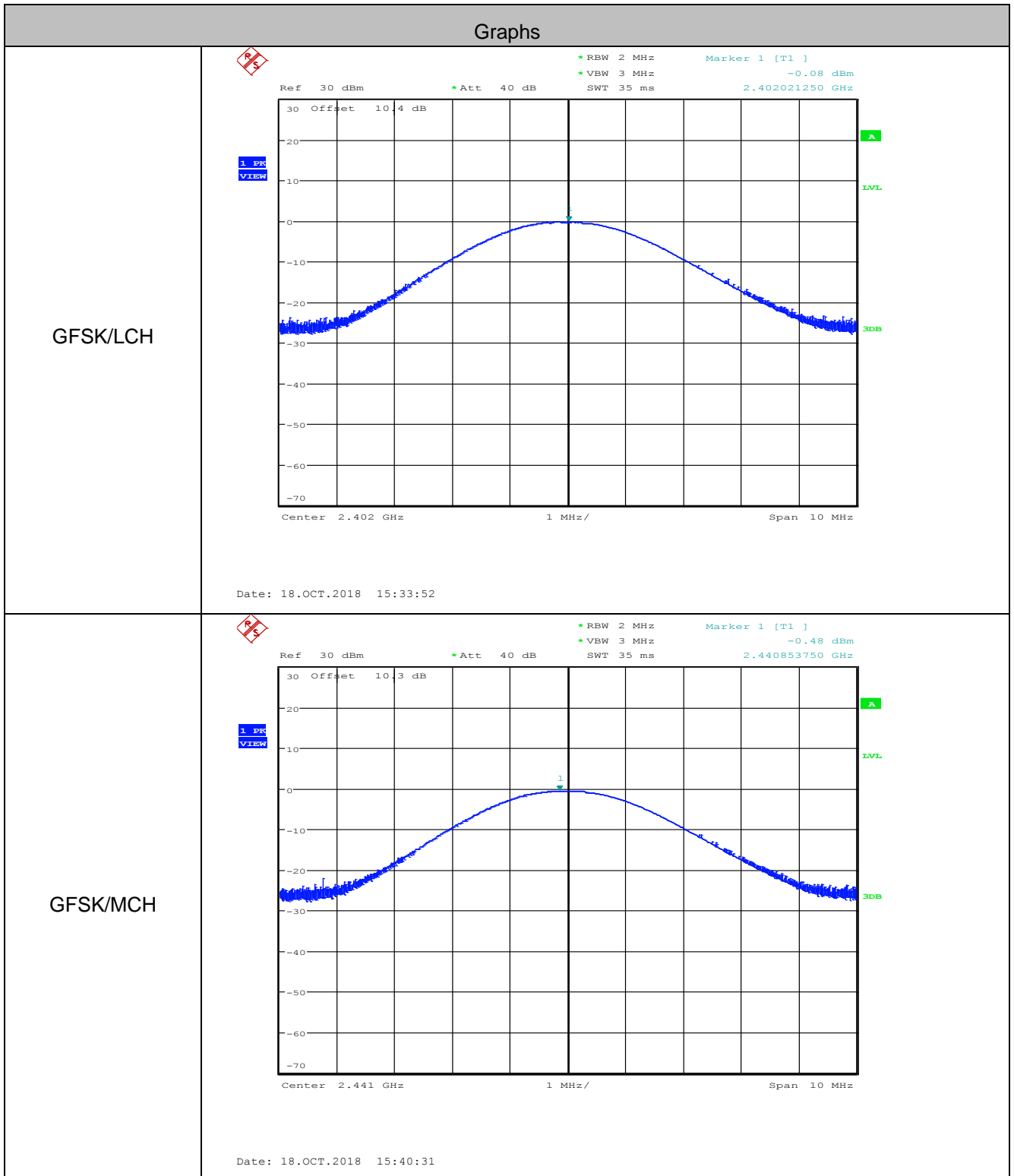

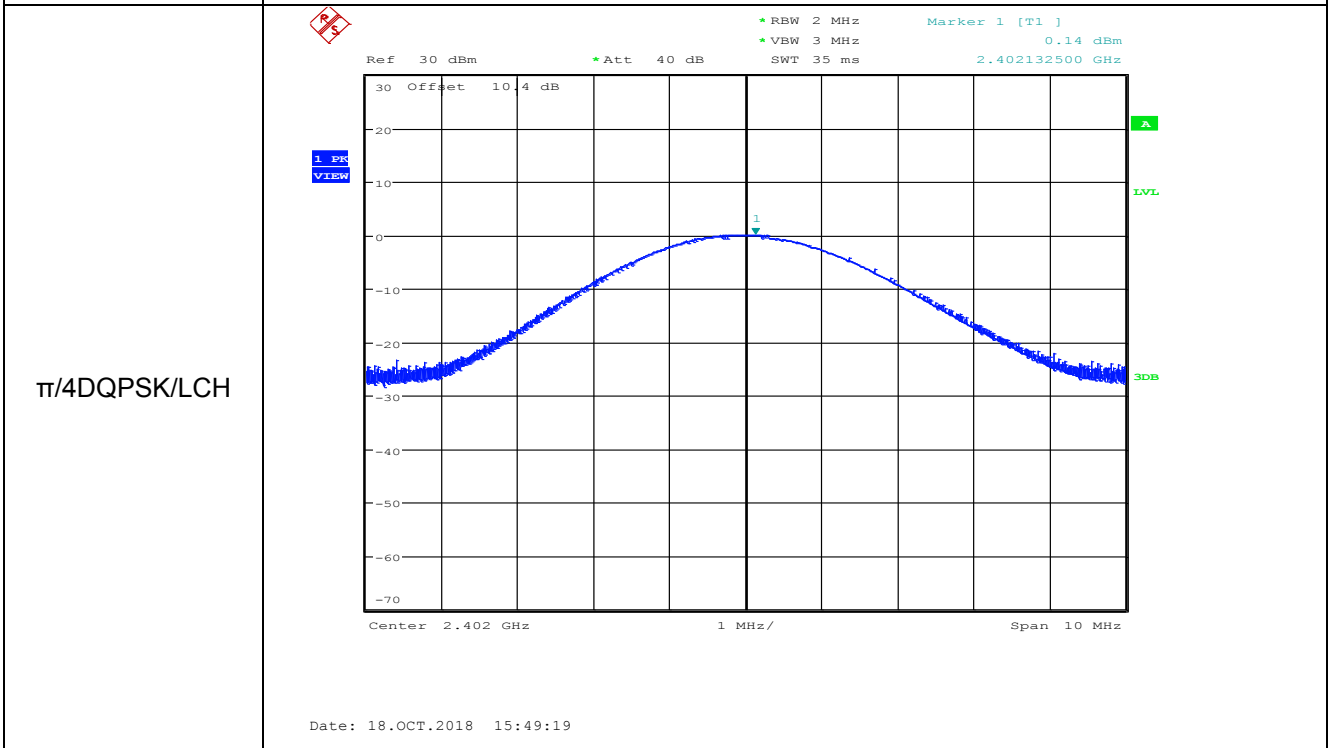
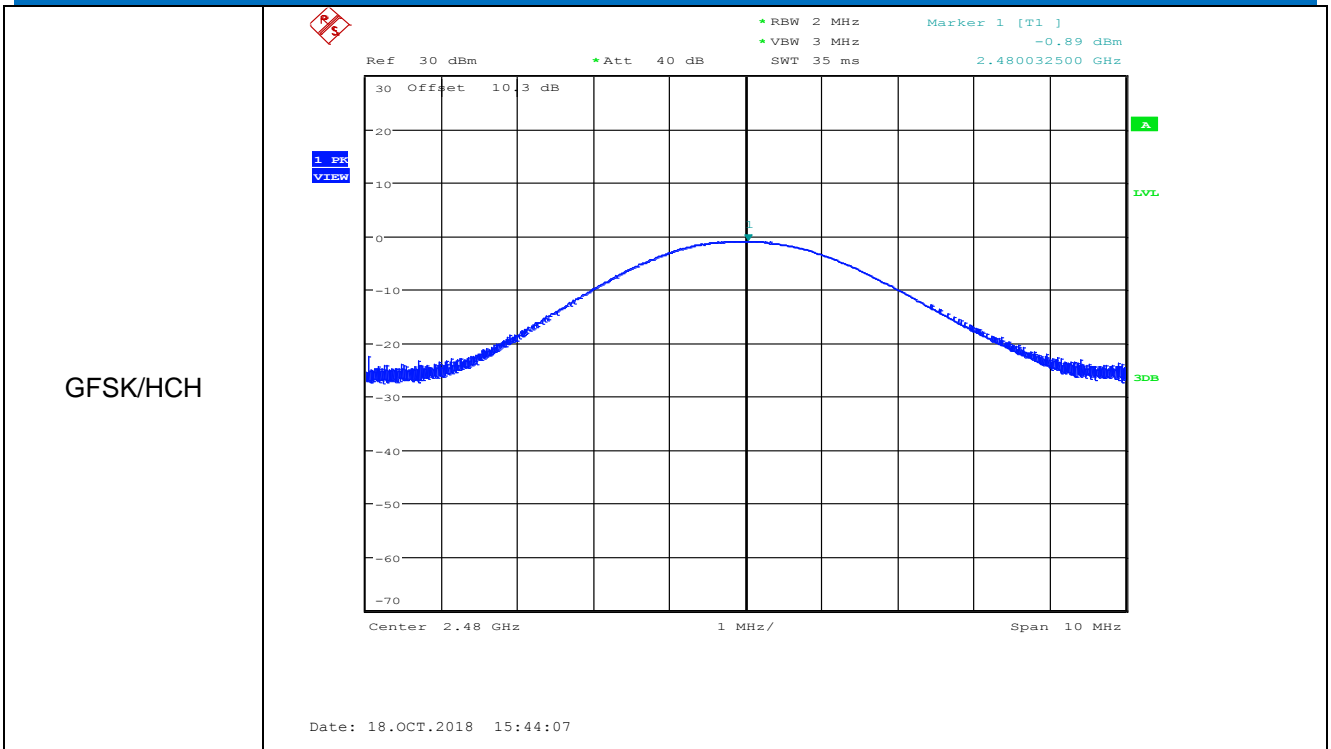

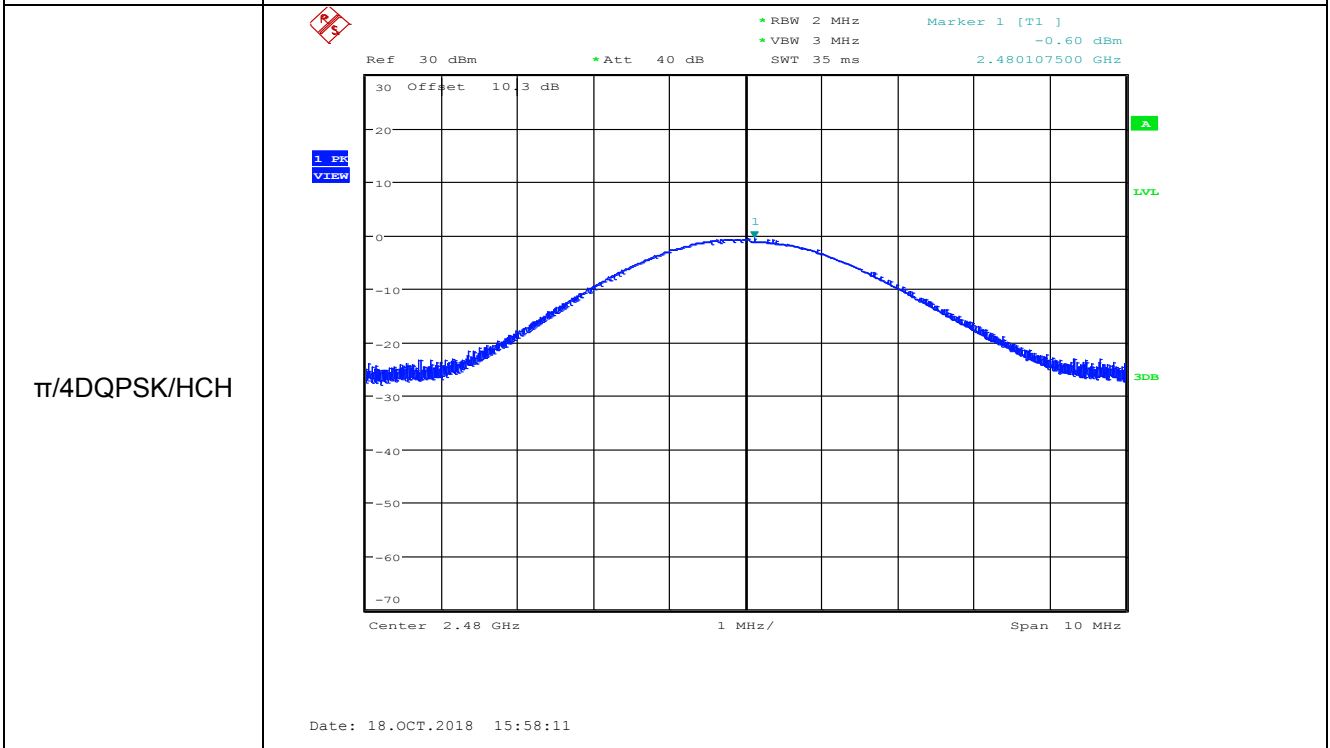
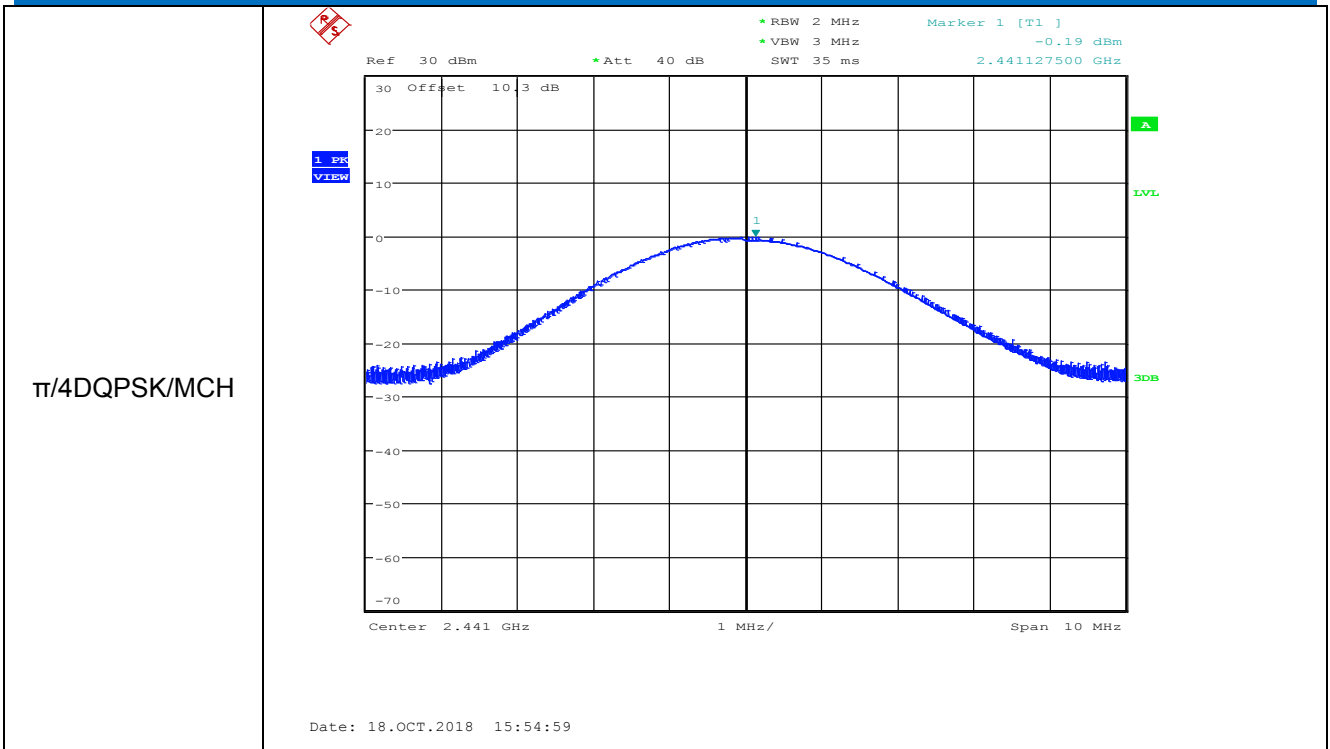

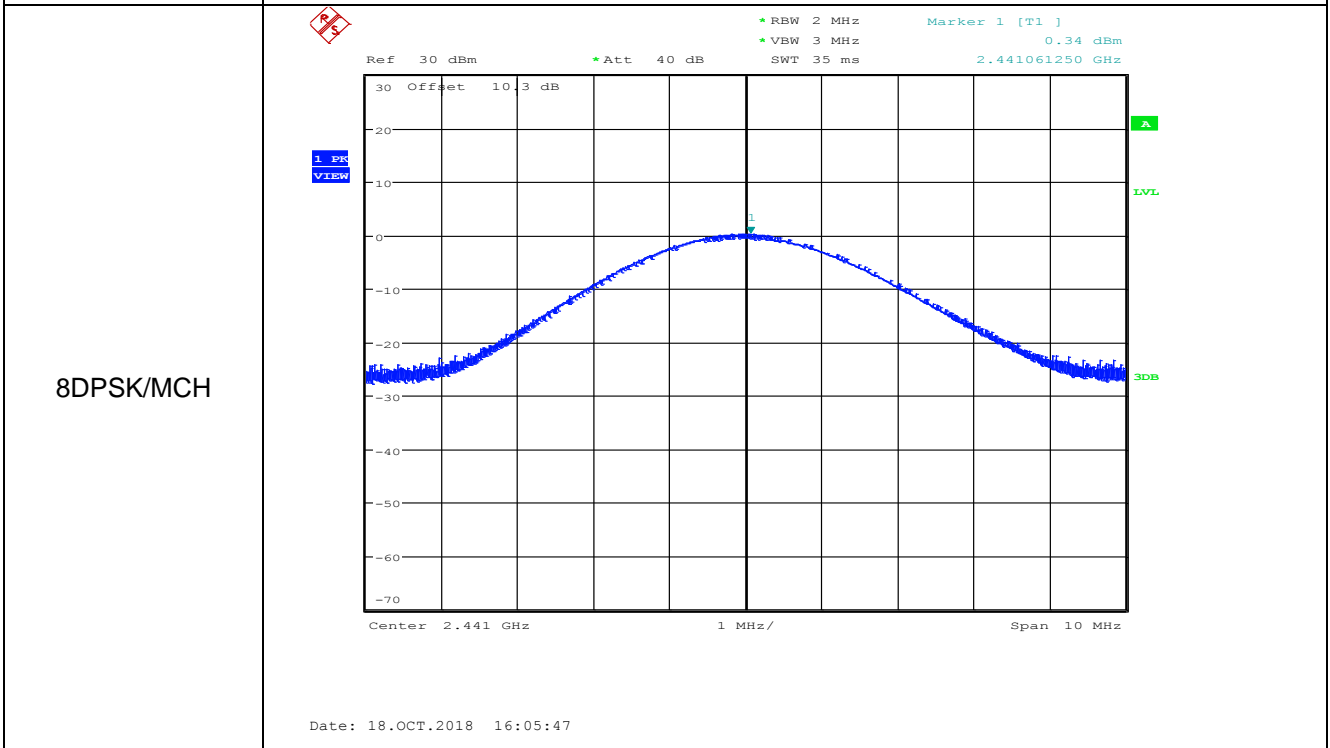
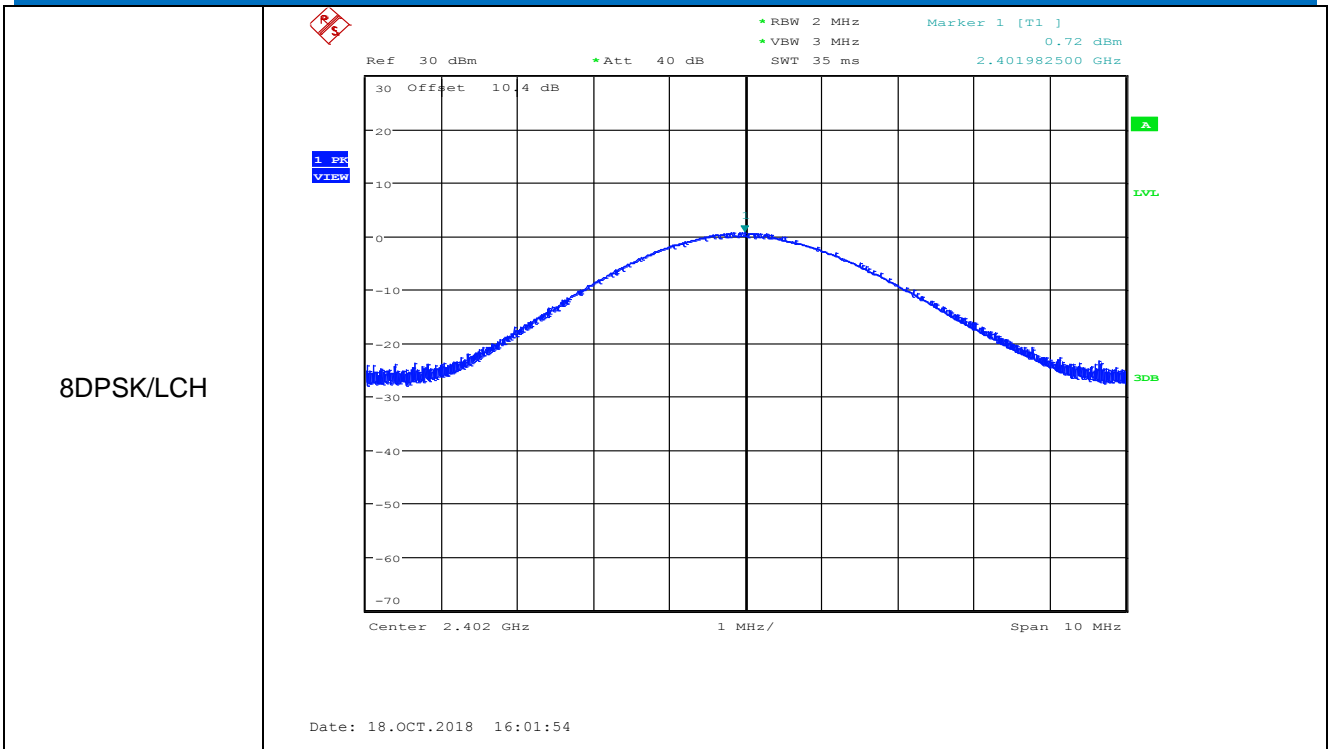

8DPSK/HCH

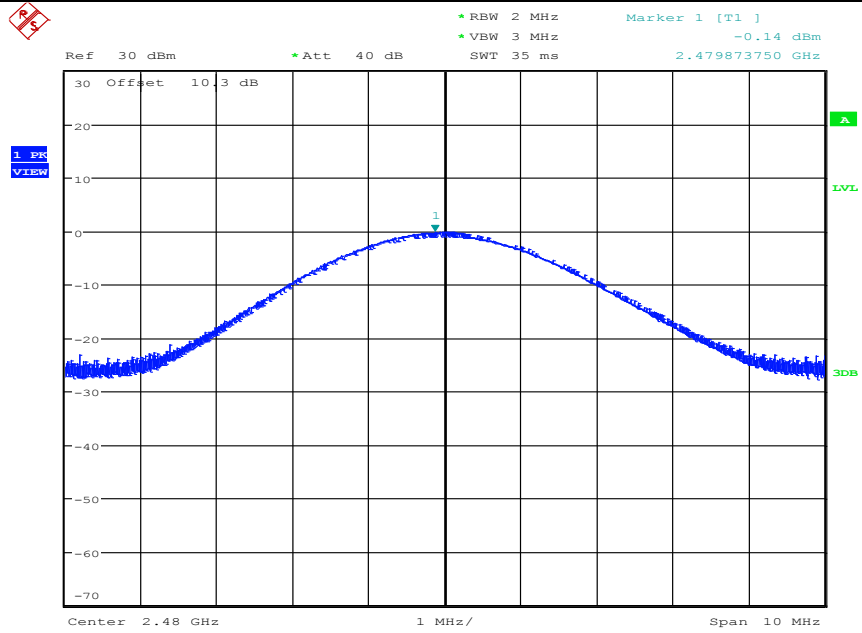

Date: 18.OCT.2018 16:09:13

5.3 20dB Occupy Bandwidth

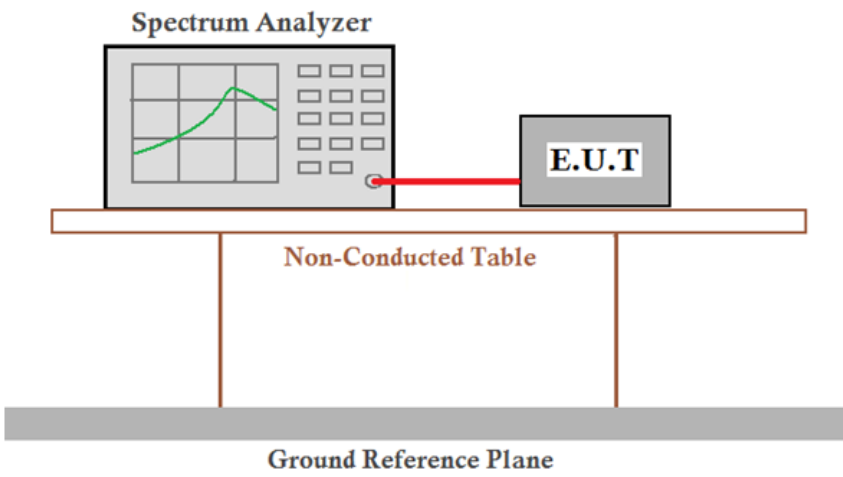
Test Requirement:	47 CFR Part 15C Section 15.247 (a)(1)
Test Method:	ANSI C63.10:2013
Test Setup:	 <p>Remark: Offset=Cable loss+ attenuation factor.</p>
Limit:	NA
Exploratory Test Mode:	Non-hopping transmitting with all kind of modulation and all kind of data type
Final Test Mode:	Through Pre-scan, find the DH5 of data type is the worst case of GFSK modulation type, 2-DH5 of data type is the worst case of $\pi/4$ DQPSK modulation type, 3-DH5 of data type is the worst case of 8DPSK modulation type. Only the worst case is recorded in the report.
Test Results:	Pass

Measurement Data

Test channel	20dB Occupy Bandwidth (MHz)		
	GFSK	$\pi/4$ DQPSK	8DPSK
Lowest	1.118	1.366	1.362
Middle	1.114	1.360	1.360
Highest	1.114	1.360	1.364

Test plot as follows:

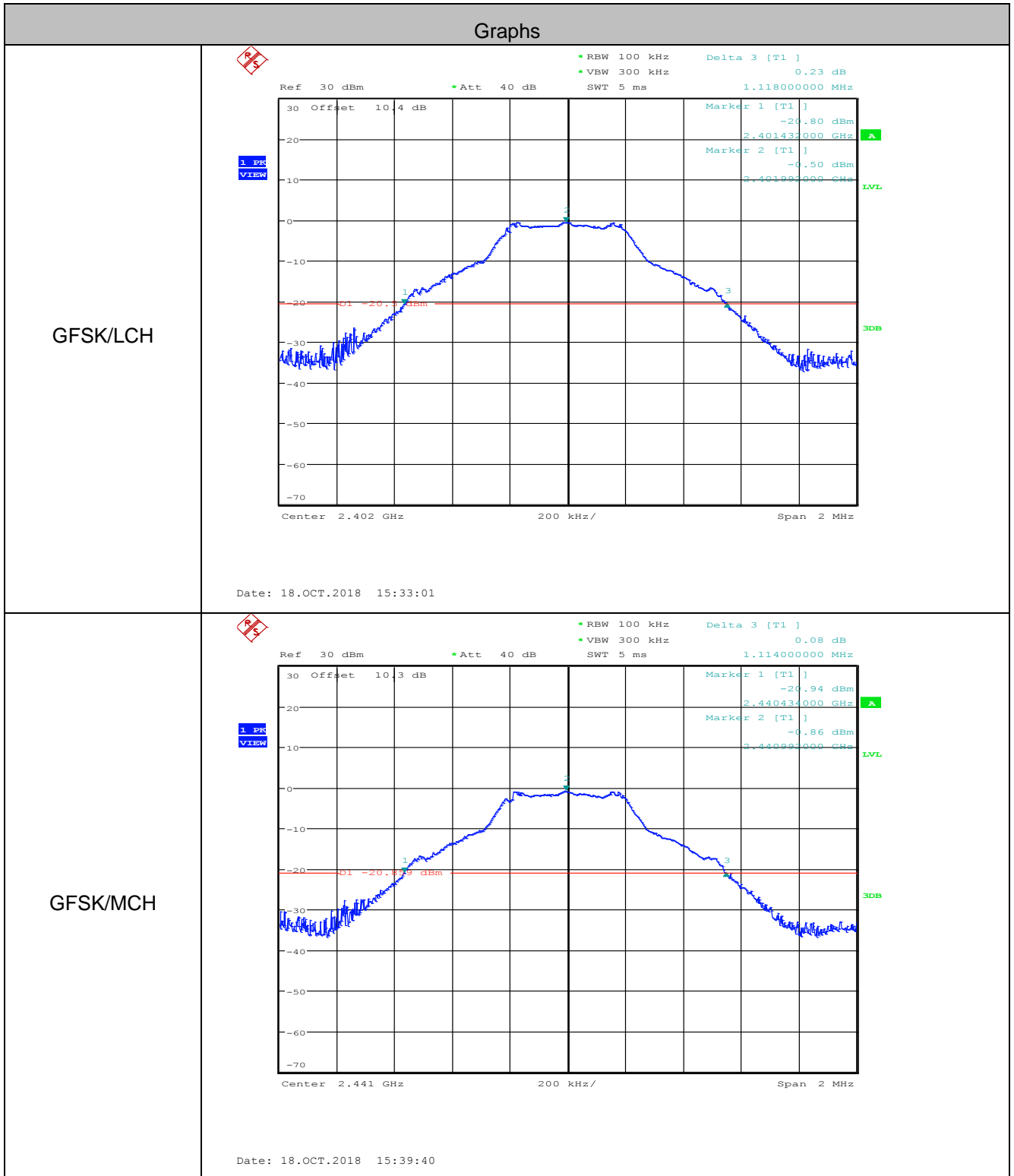

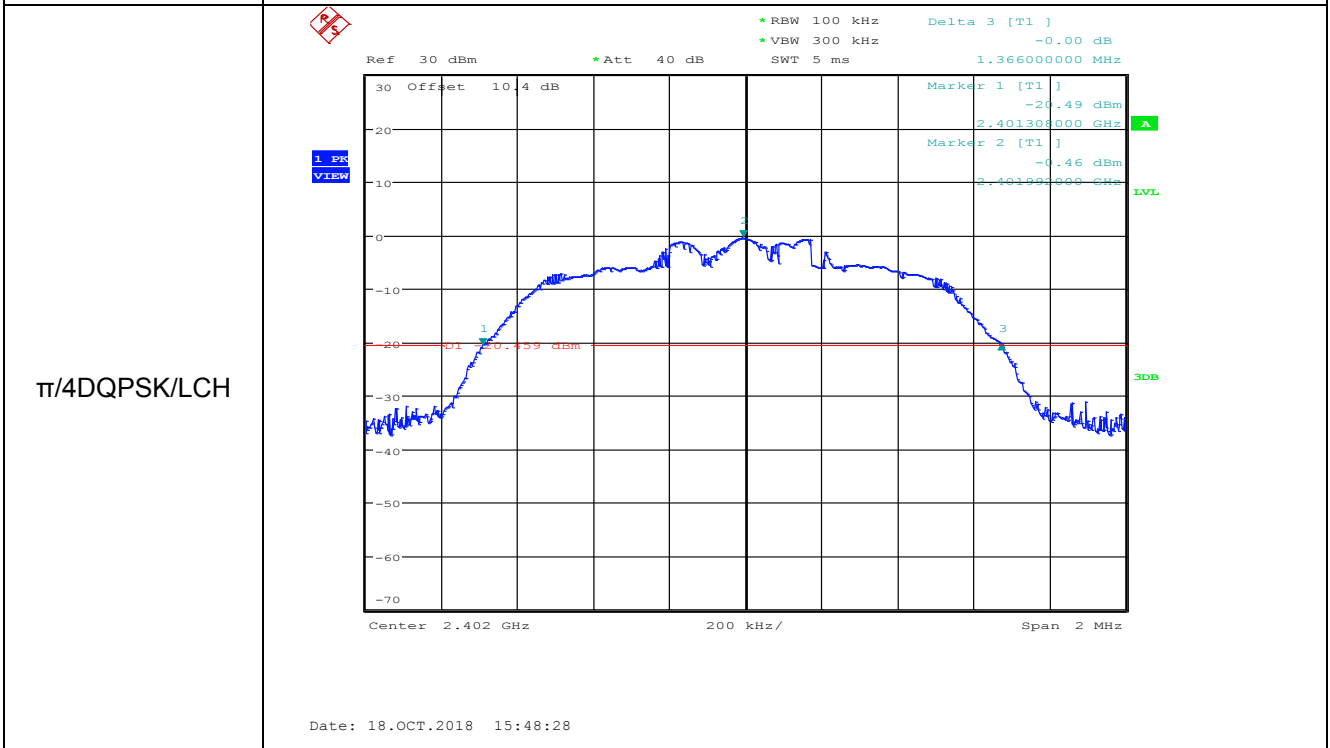

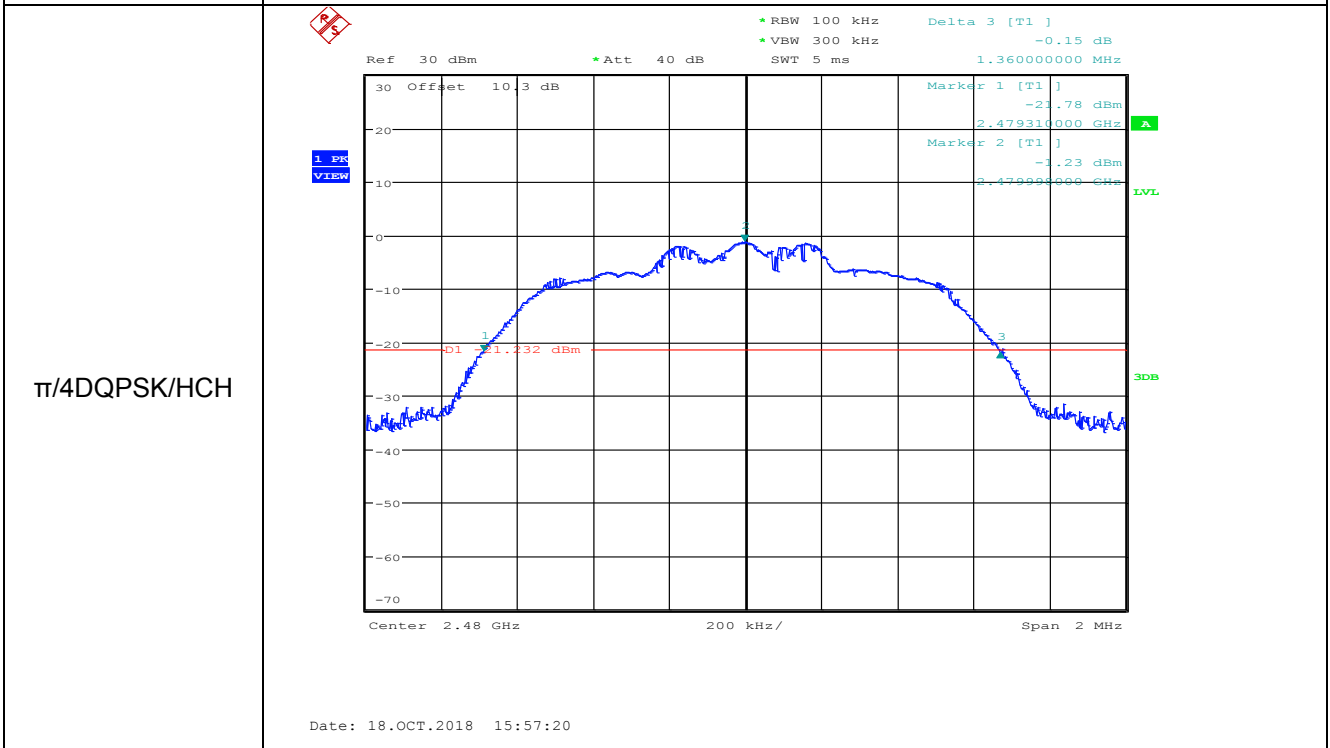
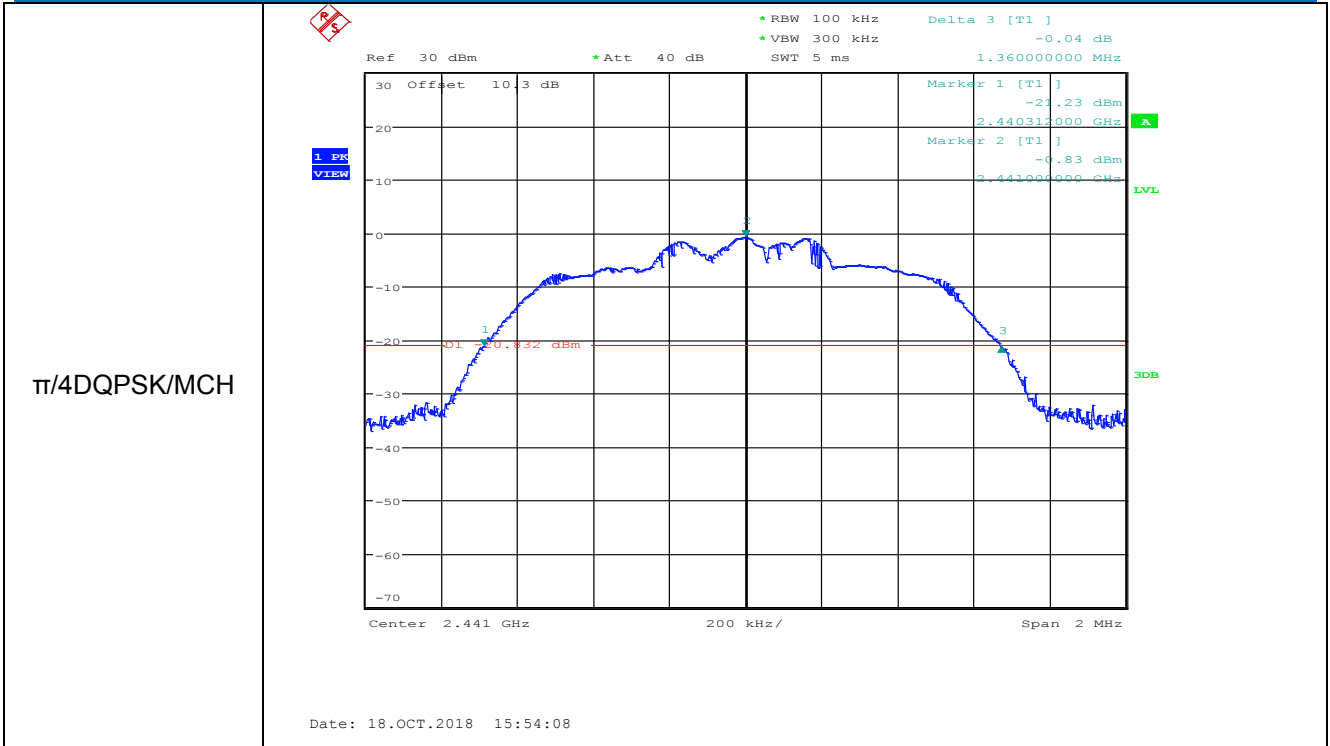

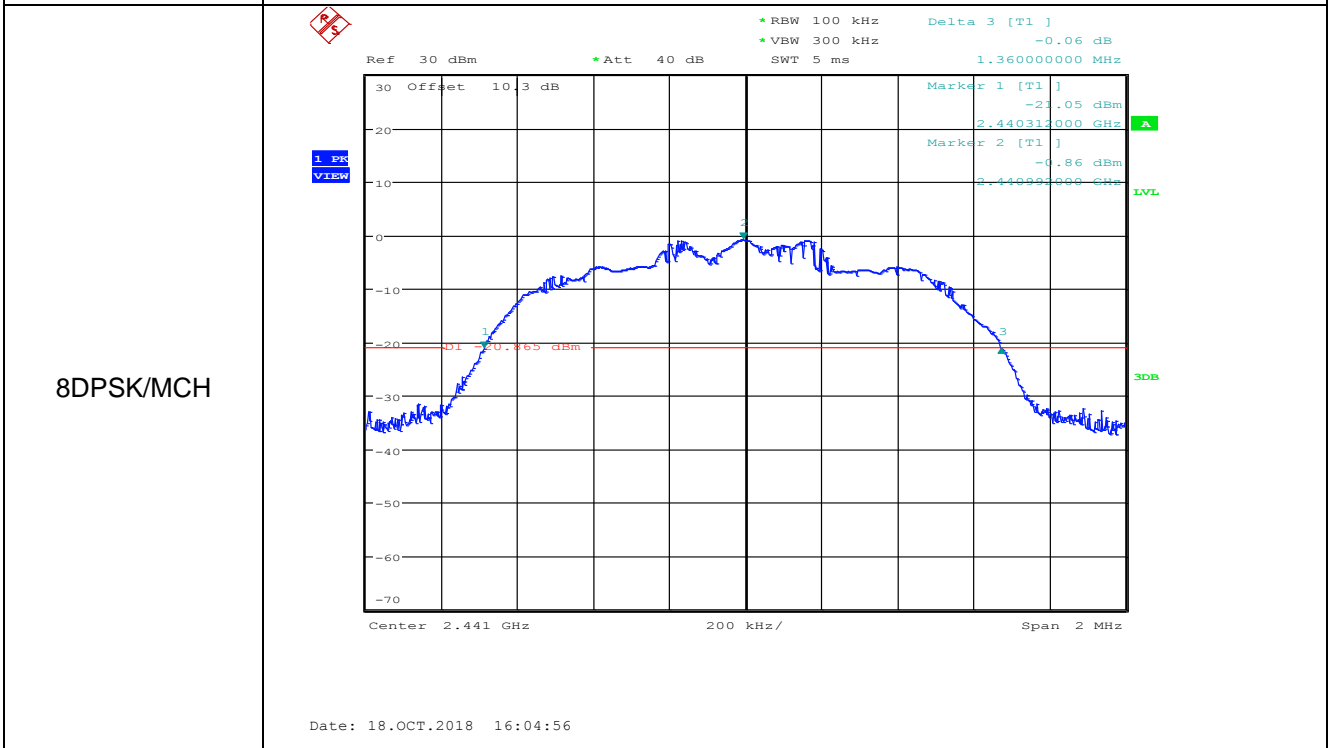
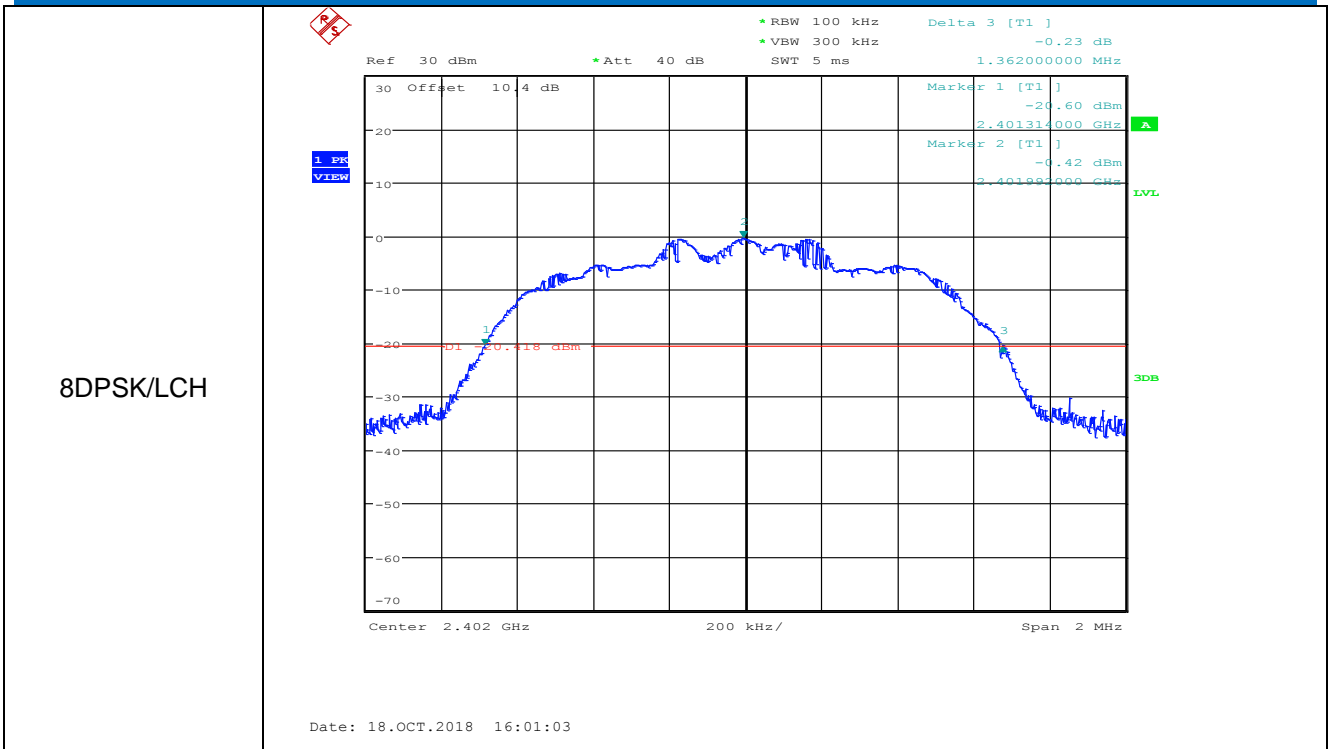

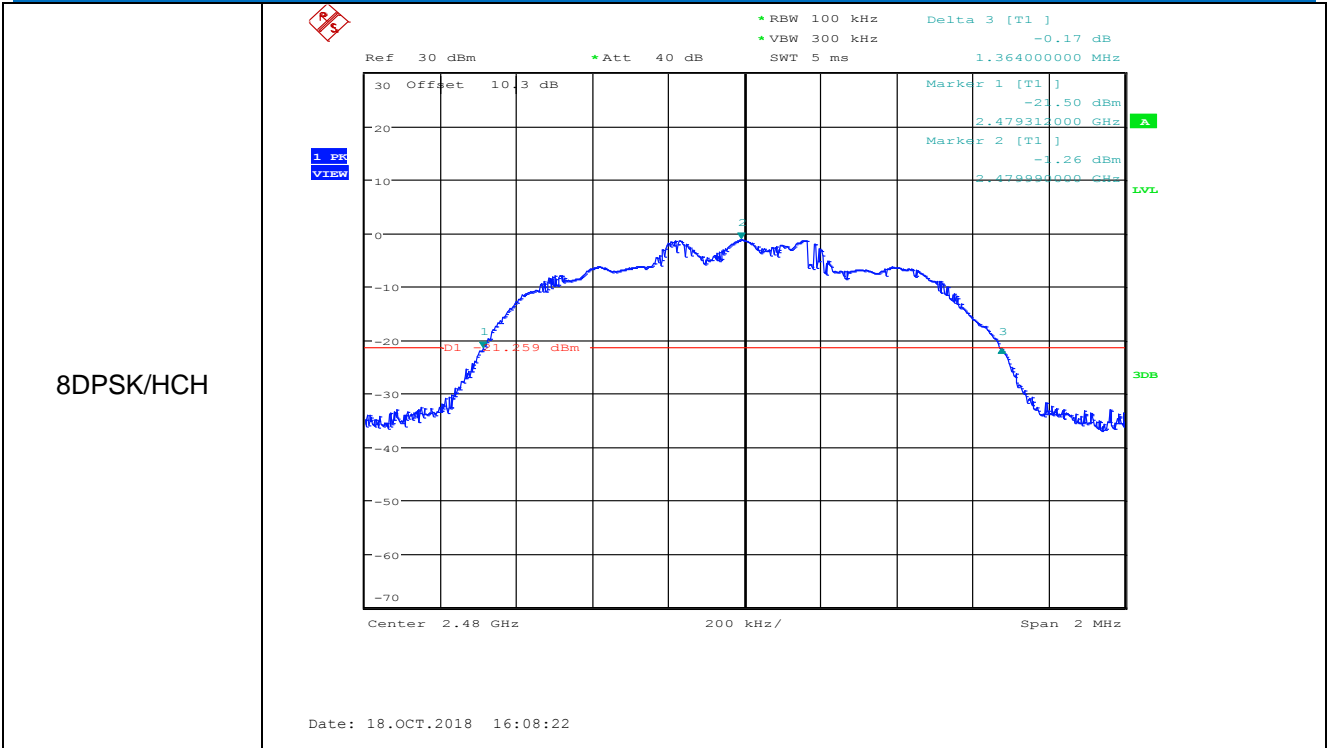

5.4 Carrier Frequencies Separation

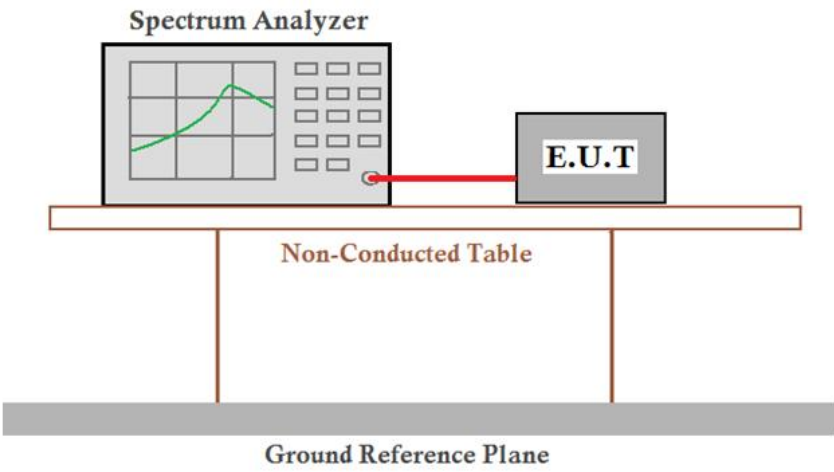
Test Requirement:	47 CFR Part 15C Section 15.247 (a)(1)
Test Method:	ANSI C63.10:2013
Test Setup:	 <p>Remark: Offset=Cable loss+ attenuation factor.</p>
Limit:	2/3 of the 20dB bandwidth
	Remark: the transmission power is less than 0.125W.
Exploratory Test Mode:	Hopping transmitting with all kind of modulation and all kind of data type
Final Test Mode:	Through Pre-scan, find the DH5 of data type is the worst case of GFSK modulation type, 2-DH5 of data type is the worst case of $\pi/4$ DQPSK modulation type, 3-DH5 of data type is the worst case of 8DPSK modulation type. Only the worst case is recorded in the report.
Test Results:	Pass

Measurement Data

GFSK mode			
Test channel	Carrier Frequencies Separation (MHz)	Limit (MHz)	Result
Lowest	0.995	≥0.745	Pass
Middle	1.005	≥0.745	Pass
Highest	1.005	≥0.745	Pass
π/4DQPSK mode			
Test channel	Carrier Frequencies Separation (MHz)	Limit (MHz)	Result
Lowest	1.000	≥0.911	Pass
Middle	1.005	≥0.911	Pass
Highest	1.005	≥0.911	Pass
8DPSK mode			
Test channel	Carrier Frequencies Separation (MHz)	Limit (MHz)	Result
Lowest	1.000	≥0.909	Pass
Middle	1.005	≥0.909	Pass
Highest	1.005	≥0.909	Pass

Note: According to section 5.4,

Mode	20dB bandwidth (MHz) (worse case)	Limit (MHz) (Carrier Frequencies Separation)
GFSK	1.118	0.745
π/4DQPSK	1.366	0.911
8DPSK	1.364	0.909

Test plot as follows:

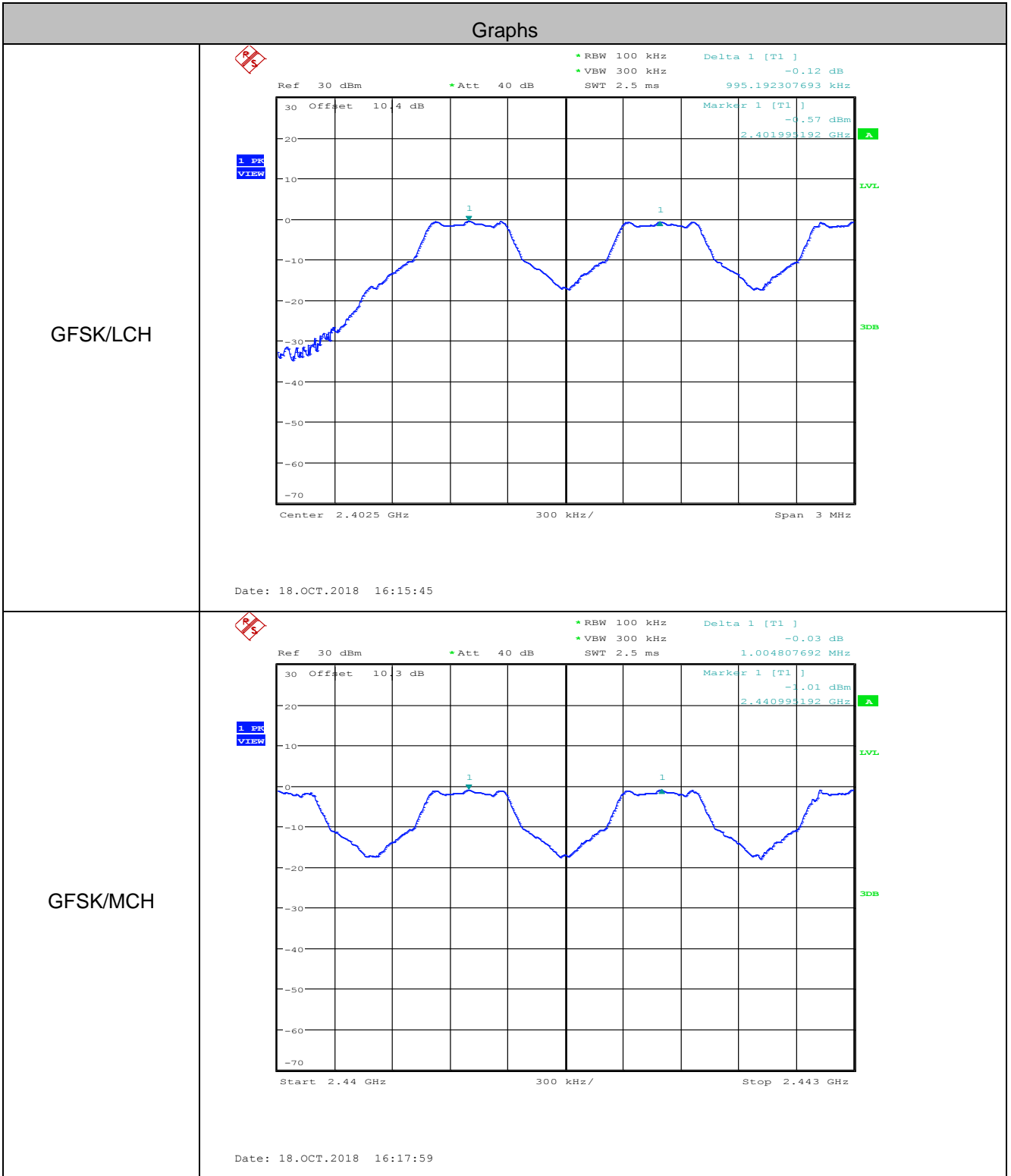

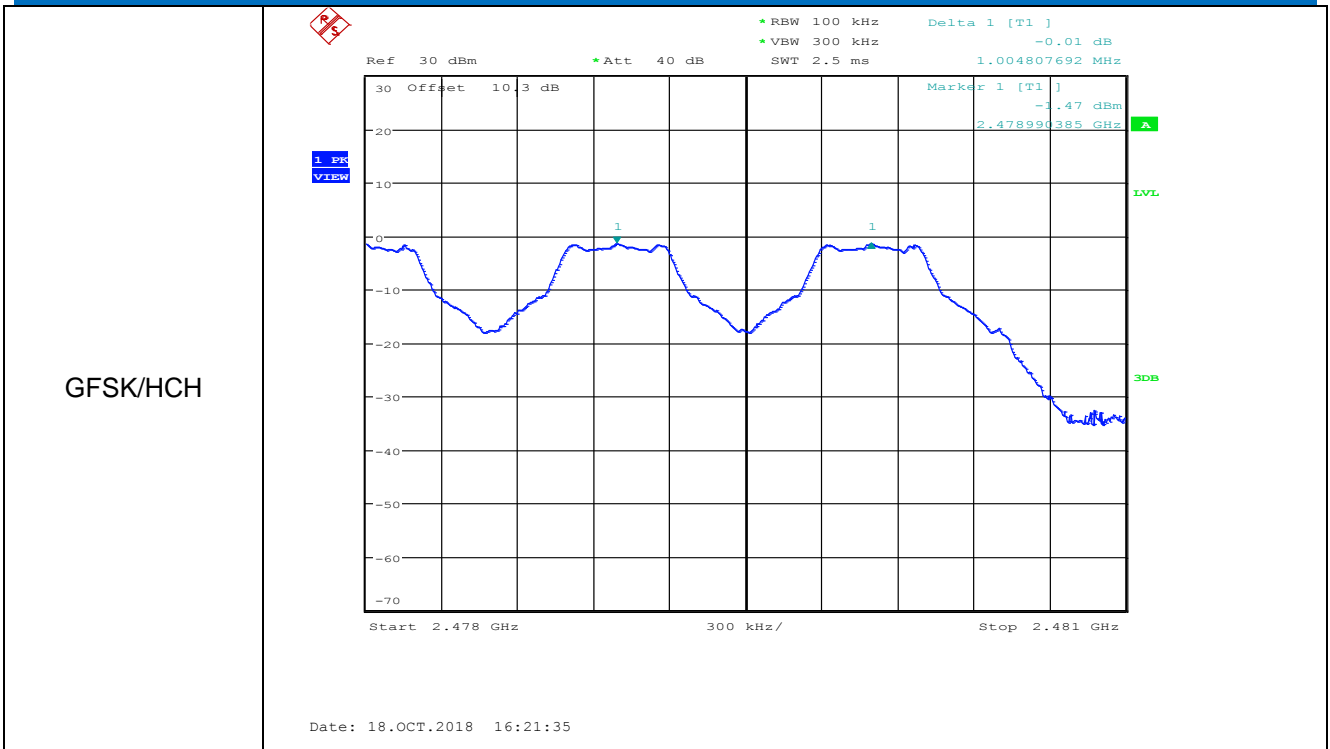

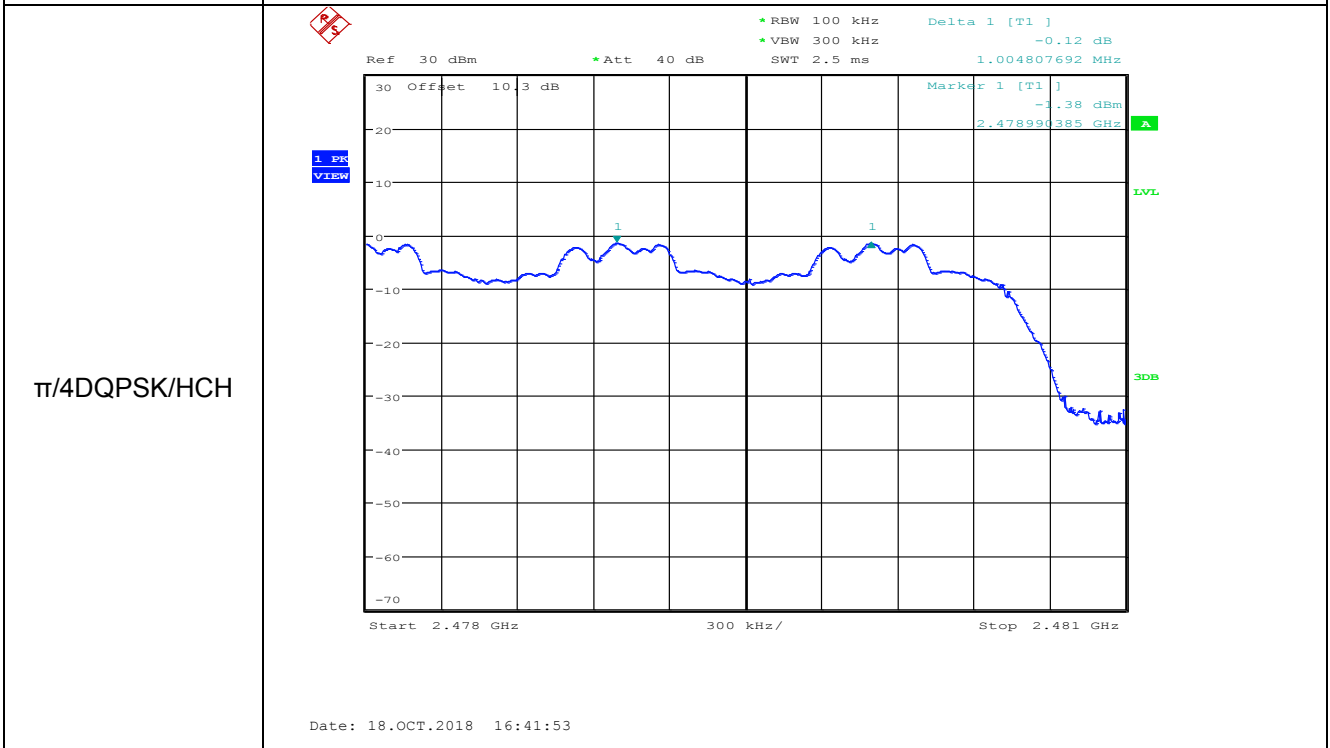
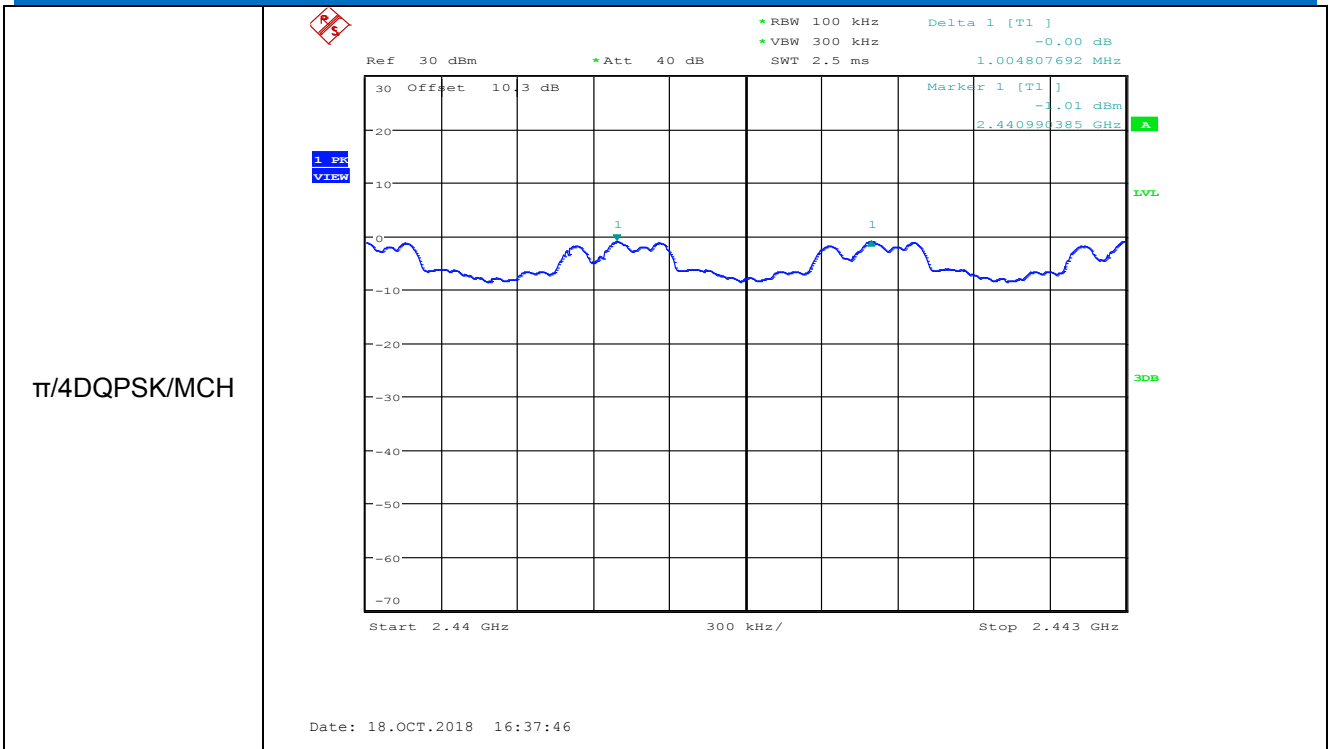

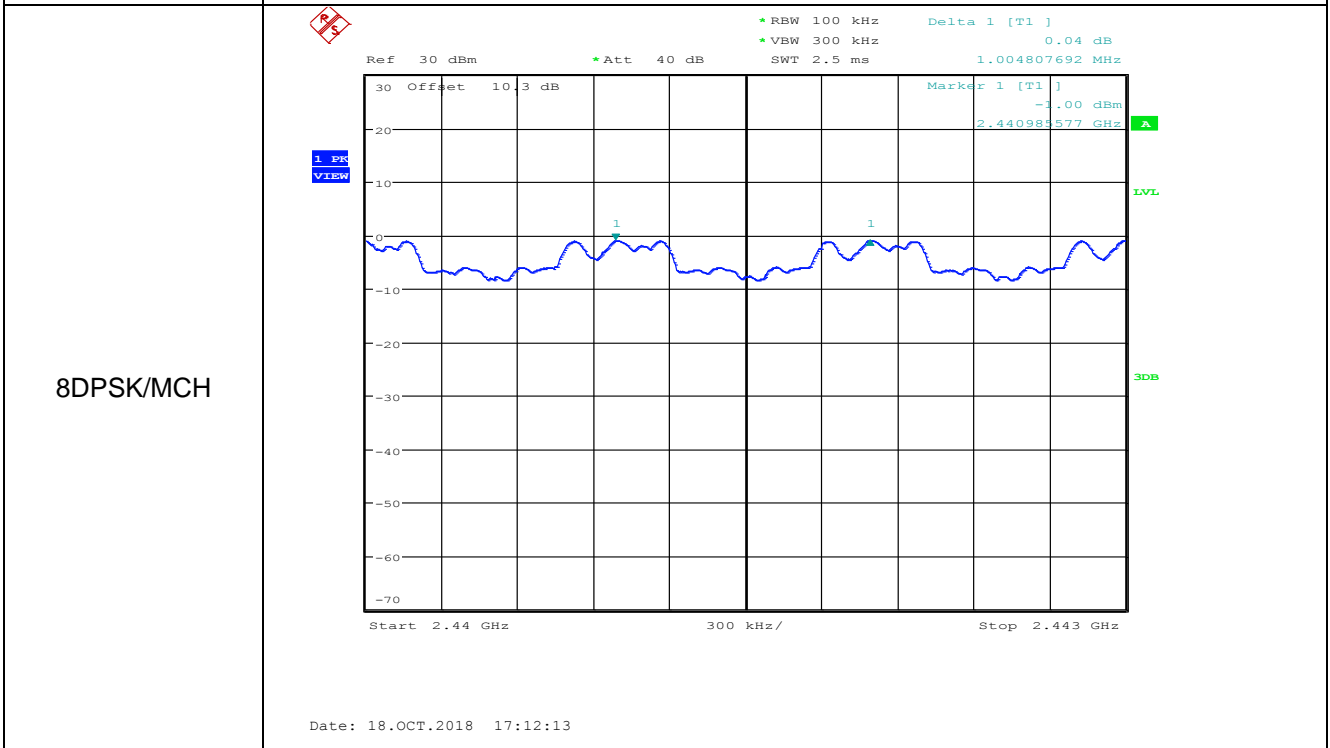
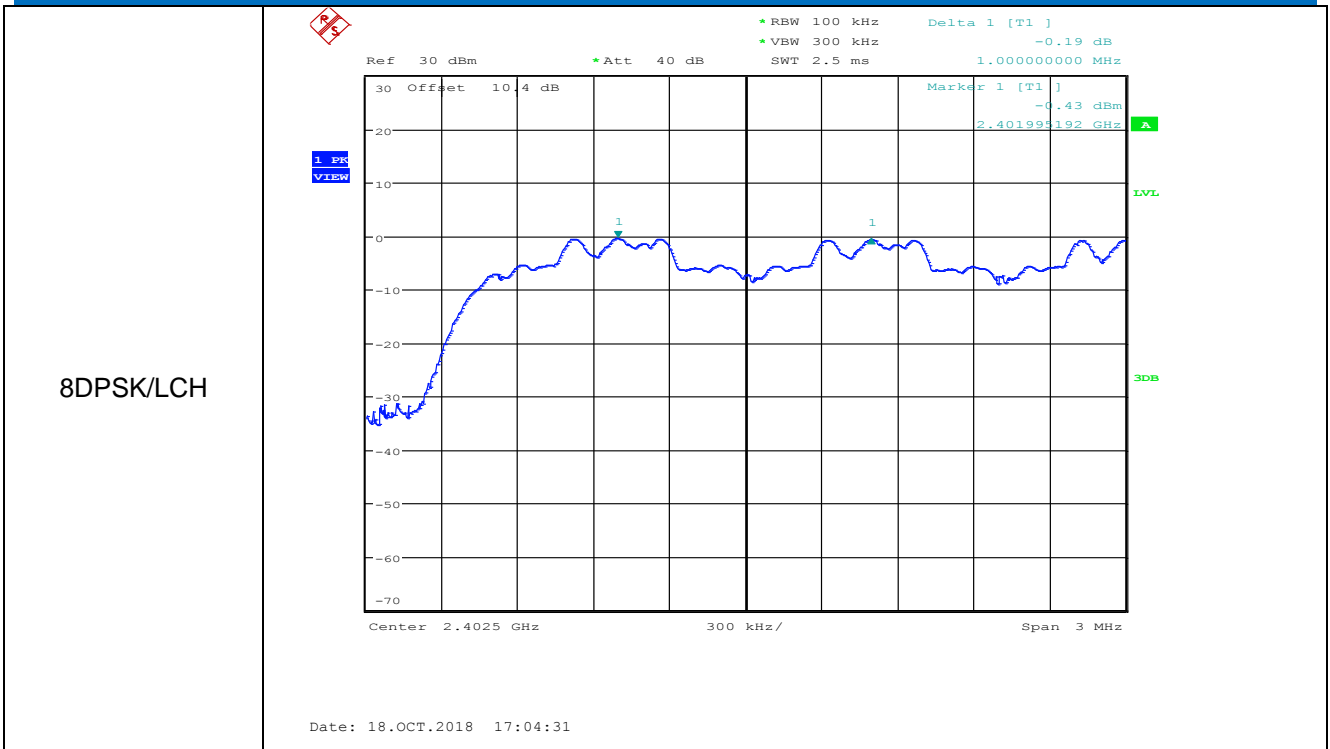

8DPSK/HCH

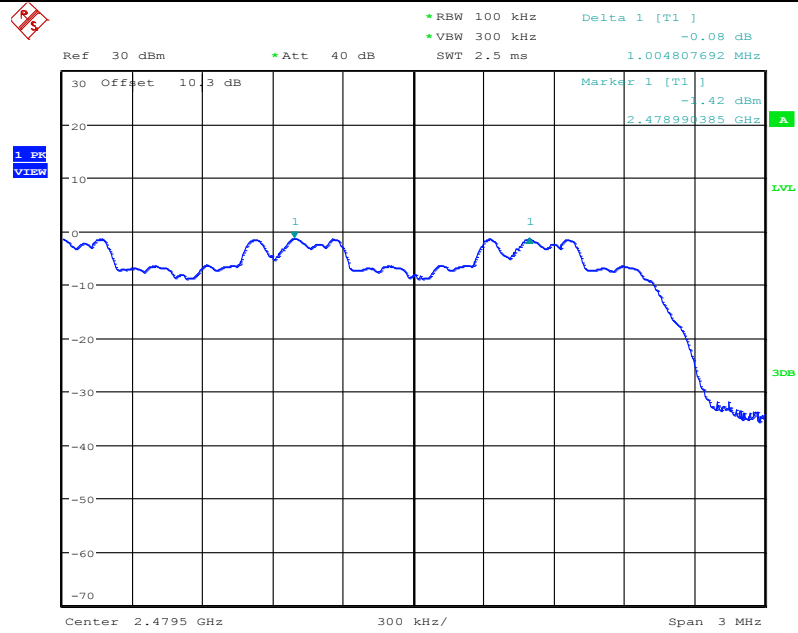

Date: 18.OCT.2018 17:16:09

5.5 Hopping Channel Number

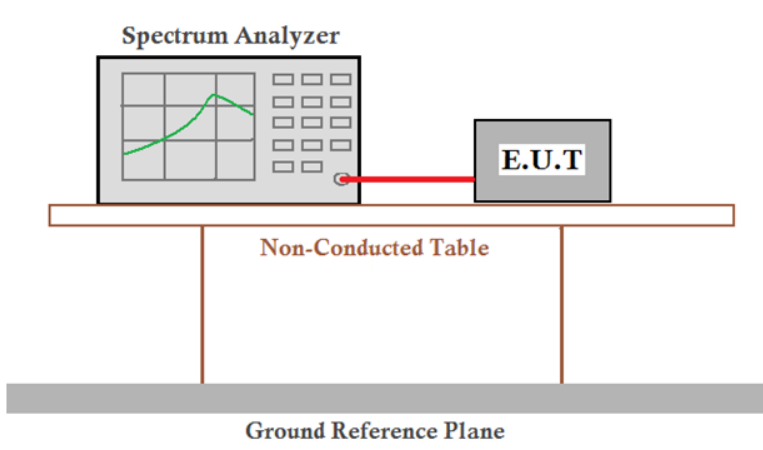
Test Requirement:	47 CFR Part 15C Section 15.247 (a)(1)
Test Method:	ANSI C63.10:2013
Test Setup:	 <p style="text-align: center;"><i>Remark: Offset=Cable loss+ attenuation factor.</i></p>
Limit:	At least 15 channels
Exploratory Test Mode:	hopping transmitting with all kind of modulation and all kind of data type
Final Test Mode:	Through Pre-scan, find the DH5 of data type is the worst case of GFSK modulation type, 2-DH5 of data type is the worst case of $\pi/4$ DQPSK modulation type, 3-DH5 of data type is the worst case of 8DPSK modulation type. Only the worst case is recorded in the report.
Test Results:	Pass

Measurement Data

Mode	Hopping channel numbers	Limit
GFSK	79	≥ 15
$\pi/4$ DQPSK	79	≥ 15
8DPSK	79	≥ 15

Test plot as follows:

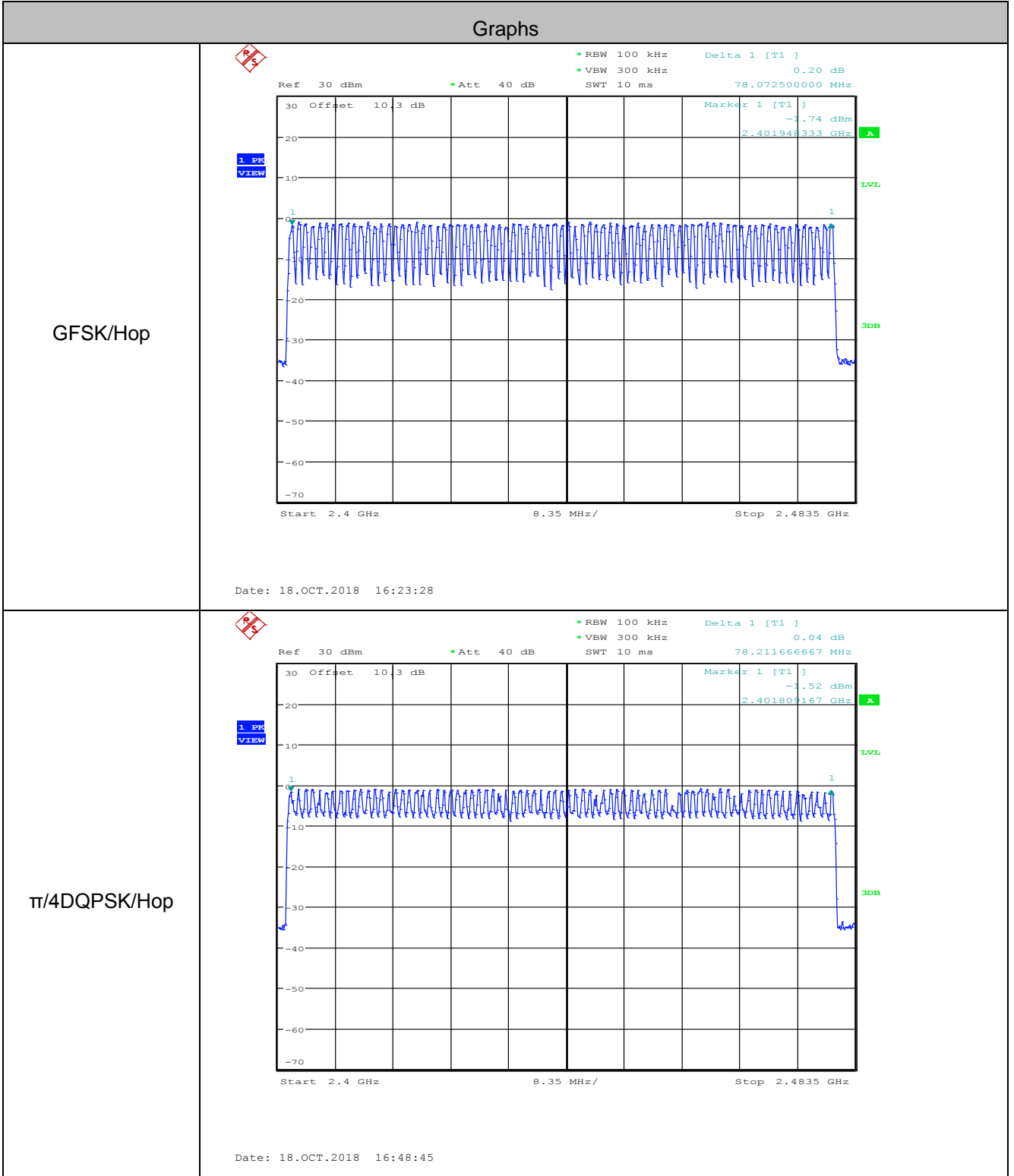

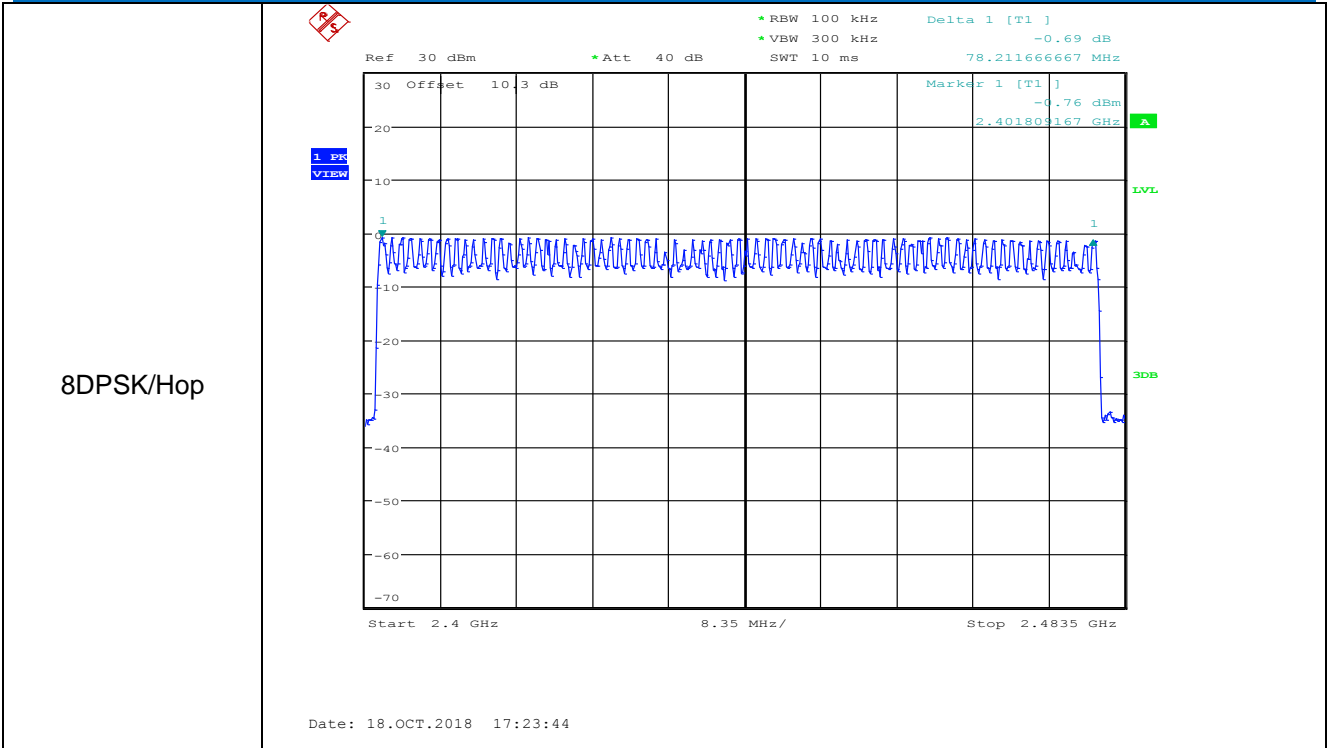

5.6 Dwell Time

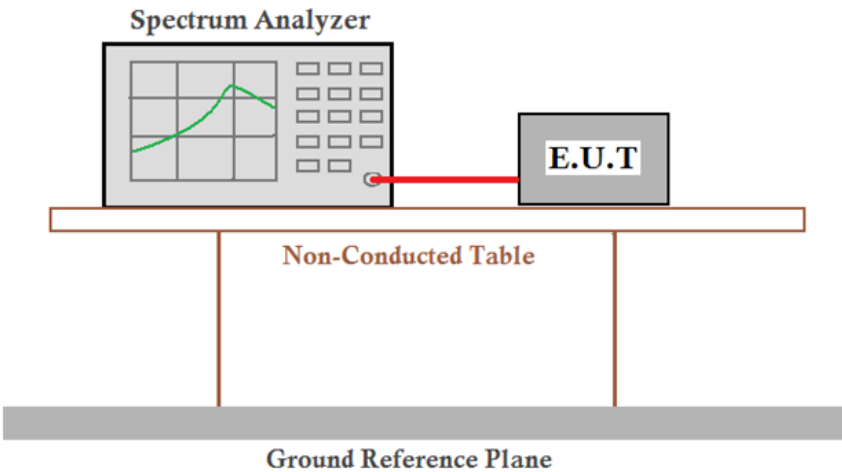
Test Requirement:	47 CFR Part 15C Section 15.247 (a)(1)
Test Method:	ANSI C63.10:2013
Test Setup:	 <p style="text-align: center;"><i>Remark: Offset=Cable loss+ attenuation factor.</i></p>
Test Mode:	Hopping transmitting with all kind of modulation and all kind of data type.
Limit:	0.4 Second
Test Results:	Pass

Measurement Data

Mode	Packet	Channel	Burst Width [ms/hop/ch]	Dwell Time[s]	Limit (second)
GFSK	DH1	LCH	0.41	0.131	≤0.4
GFSK	DH1	MCH	0.41	0.131	≤0.4
GFSK	DH1	HCH	0.41	0.131	≤0.4
π/4DQPSK	2DH1	LCH	0.42	0.134	≤0.4
π/4DQPSK	2DH1	MCH	0.42	0.134	≤0.4
π/4DQPSK	2DH1	HCH	0.42	0.134	≤0.4
8DPSK	3DH1	LCH	0.42	0.134	≤0.4
8DPSK	3DH1	MCH	0.42	0.134	≤0.4
8DPSK	3DH1	HCH	0.42	0.134	≤0.4
GFSK	DH3	LCH	1.66	0.266	≤0.4
GFSK	DH3	MCH	1.66	0.266	≤0.4
GFSK	DH3	HCH	1.66	0.266	≤0.4
π/4DQPSK	2DH3	LCH	1.67	0.267	≤0.4
π/4DQPSK	2DH3	MCH	1.67	0.267	≤0.4
π/4DQPSK	2DH3	HCH	1.67	0.267	≤0.4
8DPSK	3DH3	LCH	1.67	0.267	≤0.4
8DPSK	3DH3	MCH	1.67	0.267	≤0.4
8DPSK	3DH3	HCH	1.67	0.267	≤0.4
GFSK	DH5	LCH	2.91	0.31	≤0.4
GFSK	DH5	MCH	2.91	0.31	≤0.4
GFSK	DH5	HCH	2.91	0.31	≤0.4
π/4DQPSK	2DH5	LCH	2.92	0.312	≤0.4
π/4DQPSK	2DH5	MCH	2.92	0.312	≤0.4
π/4DQPSK	2DH5	HCH	2.92	0.312	≤0.4
8DPSK	3DH5	LCH	2.92	0.312	≤0.4
8DPSK	3DH5	MCH	2.92	0.312	≤0.4
8DPSK	3DH5	HCH	2.92	0.312	≤0.4

Remark:

The test period: $T = 0.4 \text{ Second/Channel} \times 79 \text{ Channel} = 31.6 \text{ s}$

DH1/2DH1/3DH1 Dwell time = Burst Width(ms)*(1600/(2*79))*31.6

DH3/2DH3/3DH3 Dwell time = Burst Width (ms)*(1600/(4*79))*31.6

DH5/2DH5/3DH5 Dwell time = Burst Width (ms)*(1600/(6*79))*31.6

Test plot as follows:

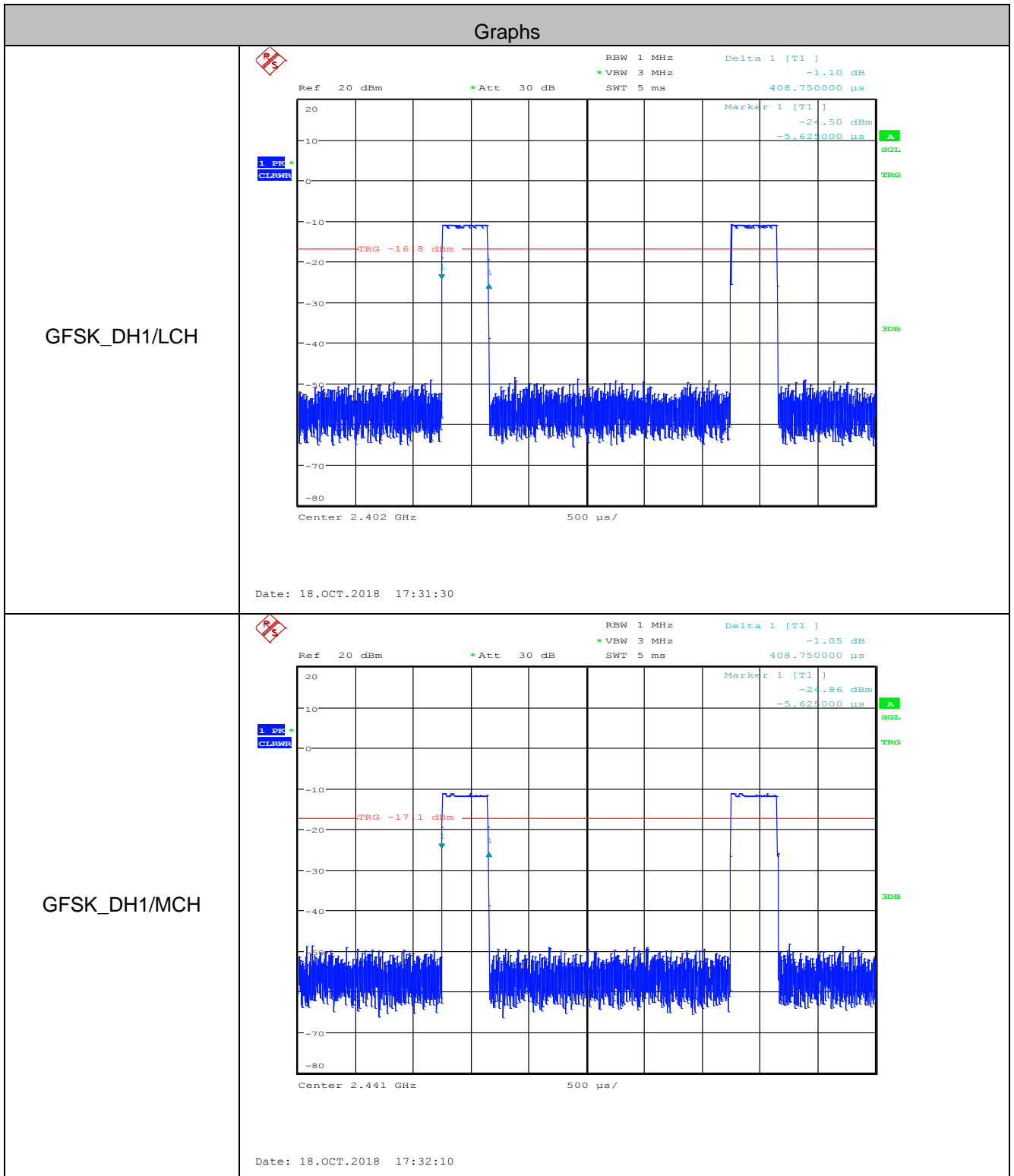

GFSK_DH1/HCH

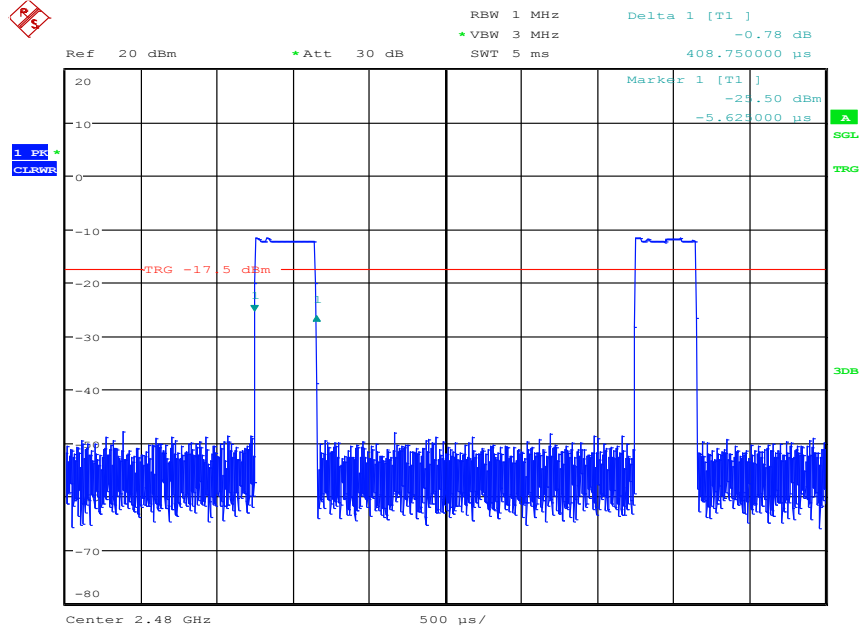

Date: 18.OCT.2018 17:32:48

$\pi/4$ DQPSK
_2DH1/LCH

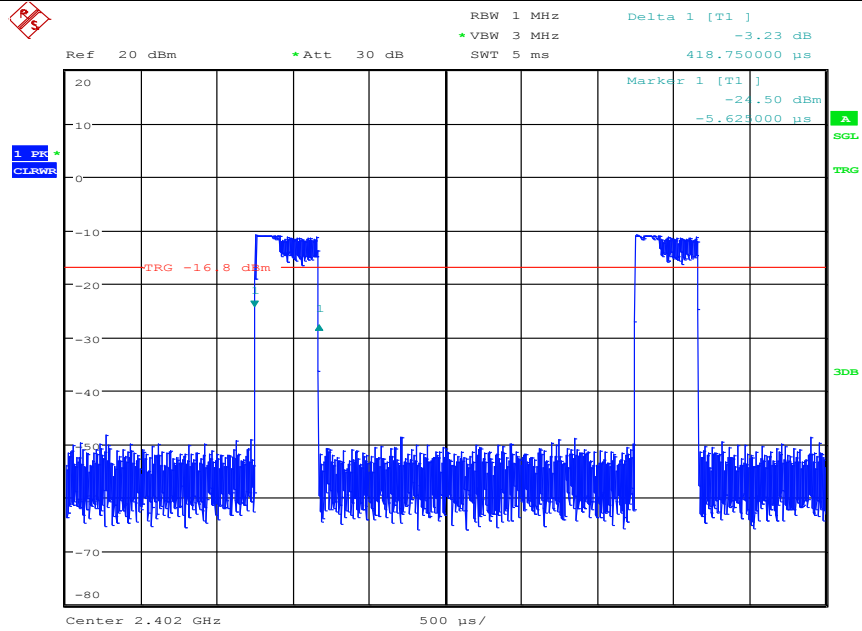

Date: 18.OCT.2018 17:36:29

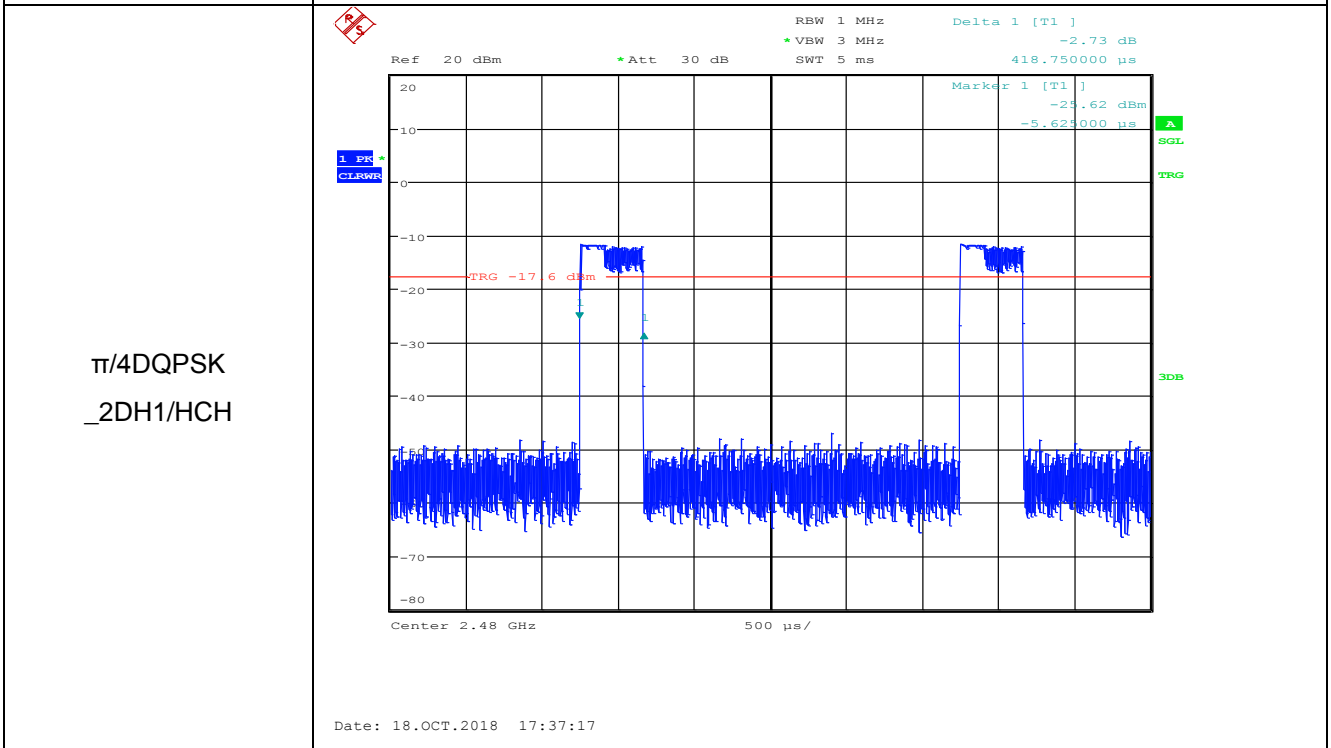
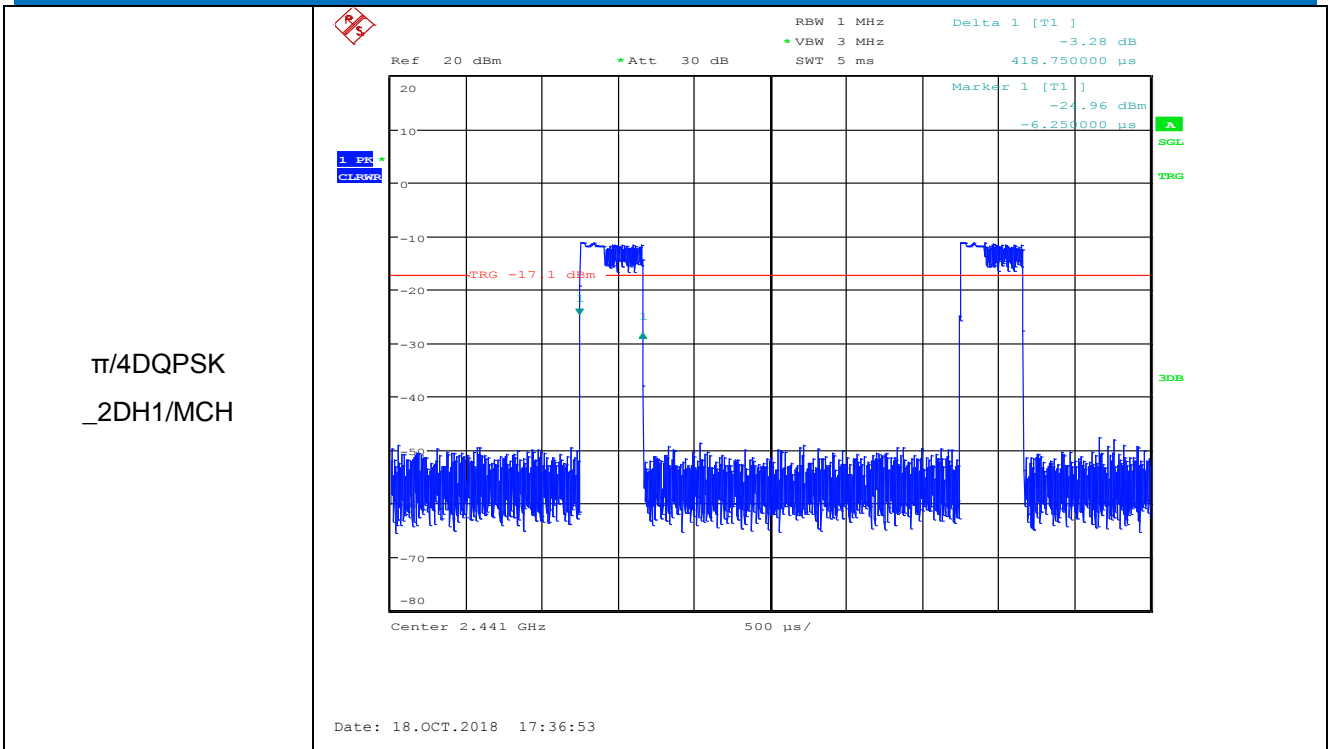

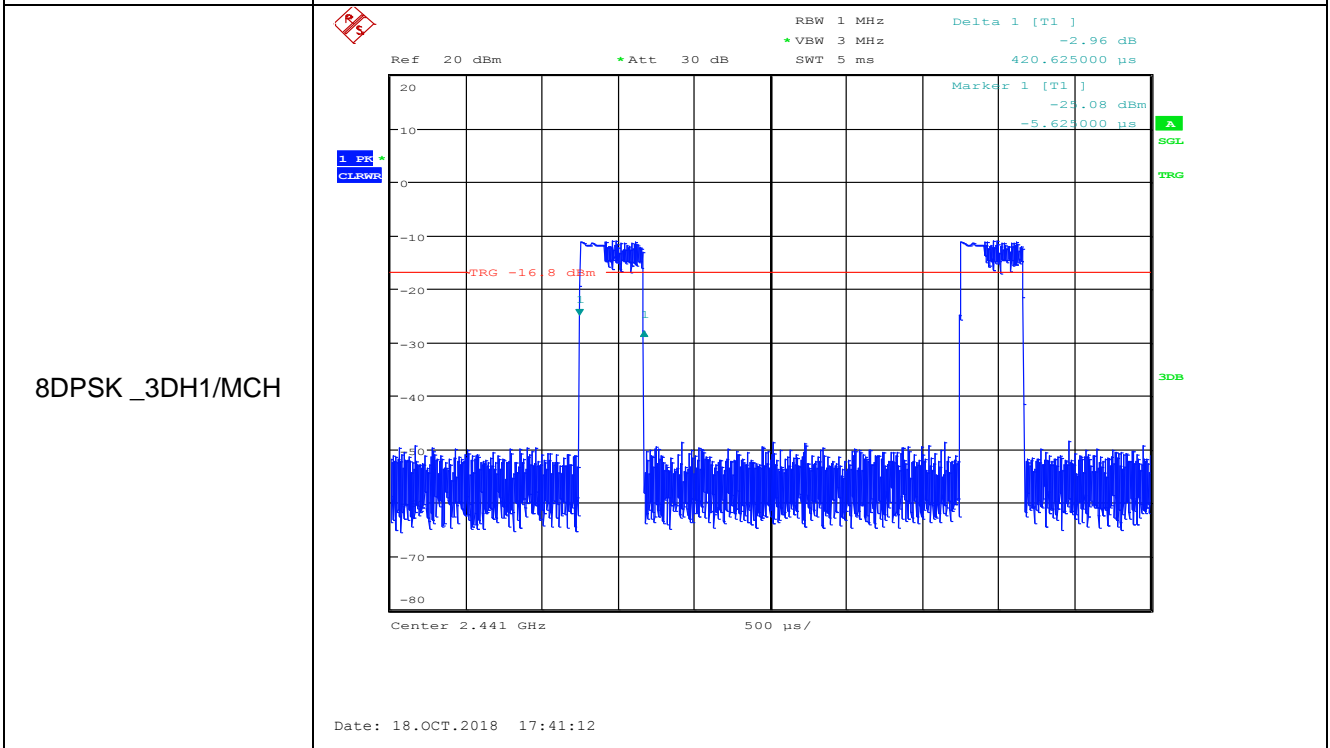
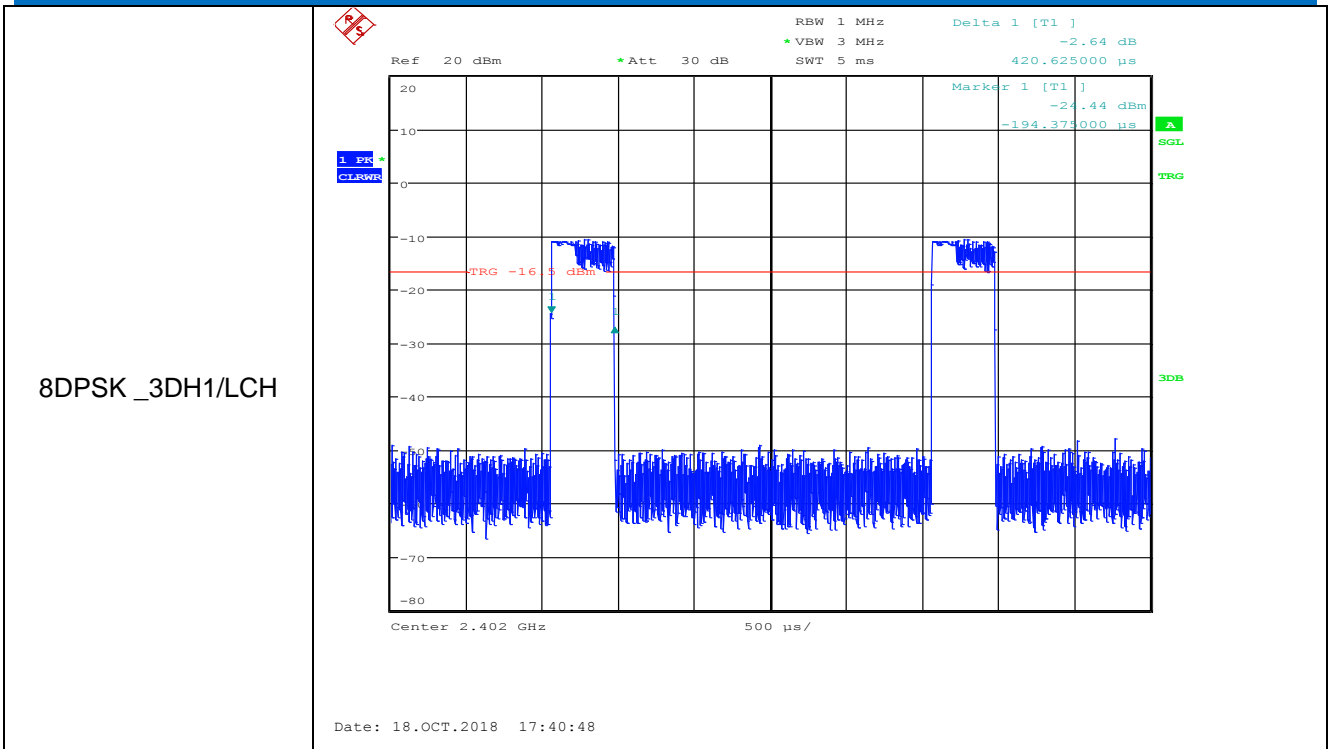

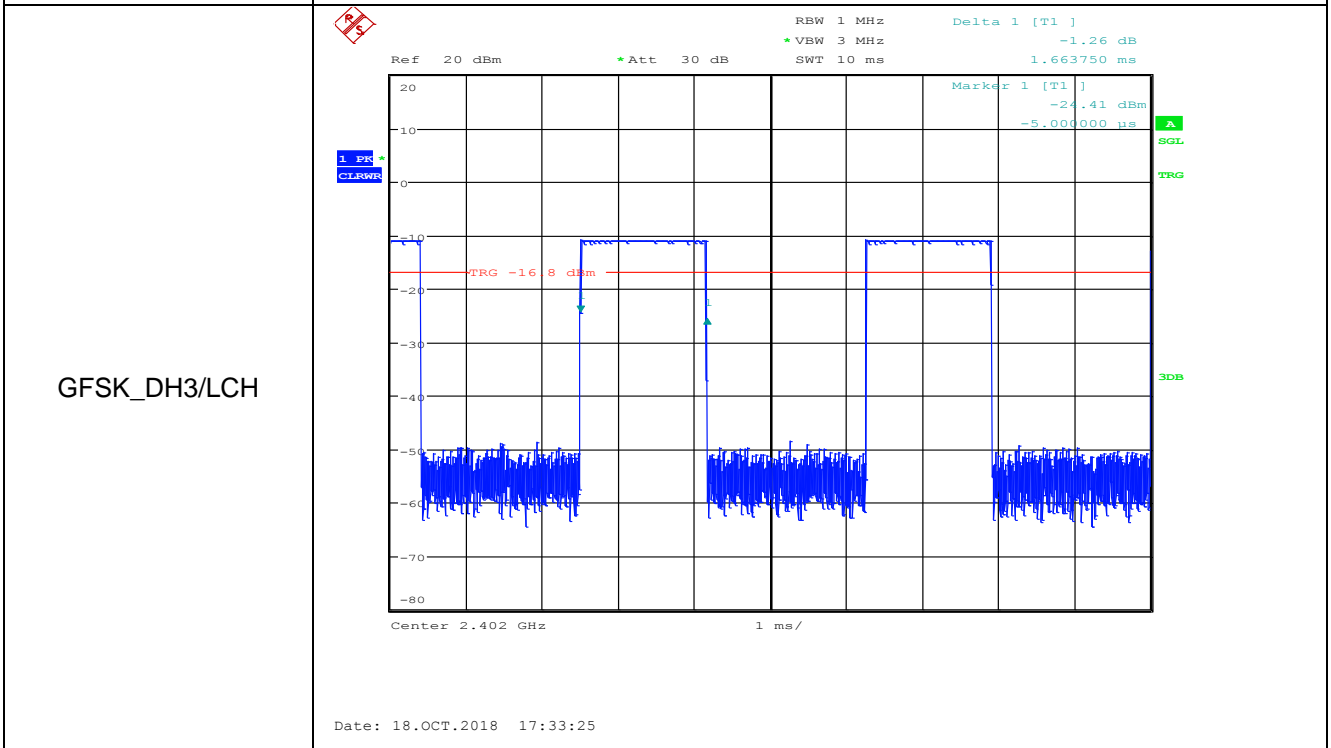
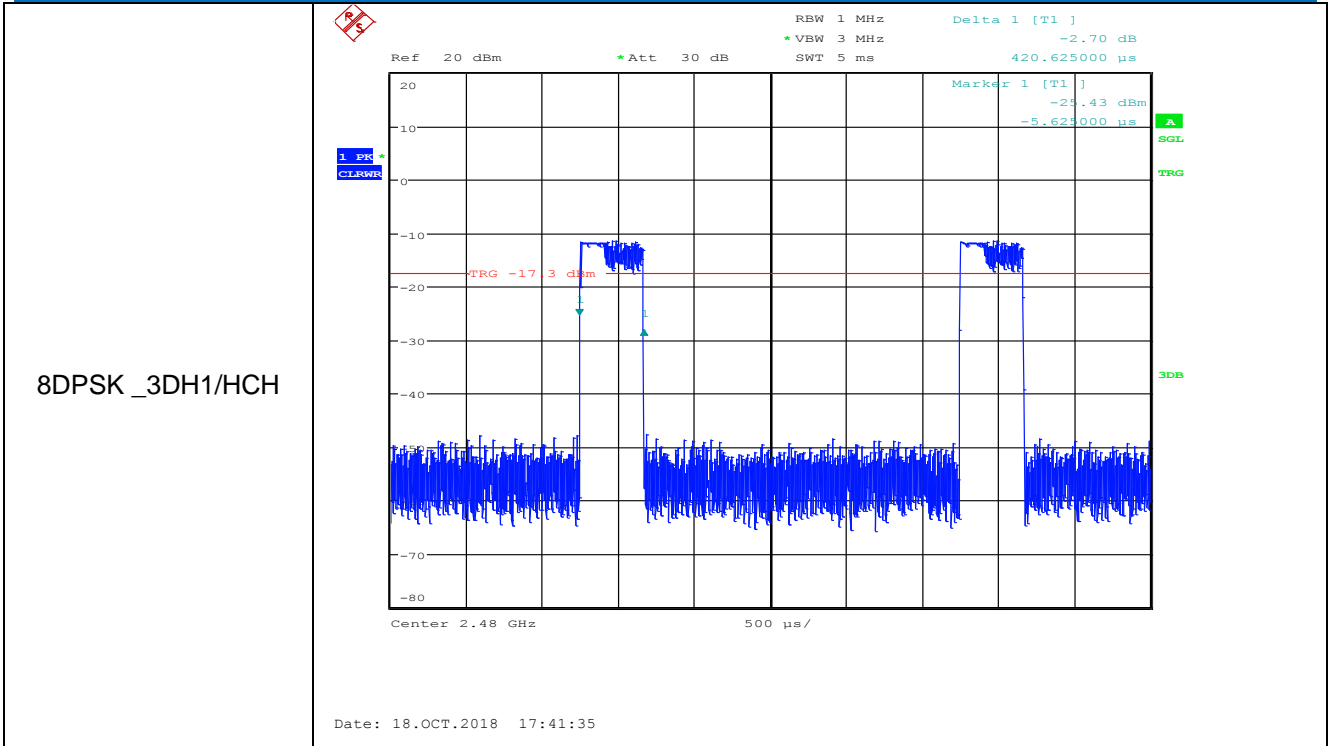

GFSK_DH3/MCH

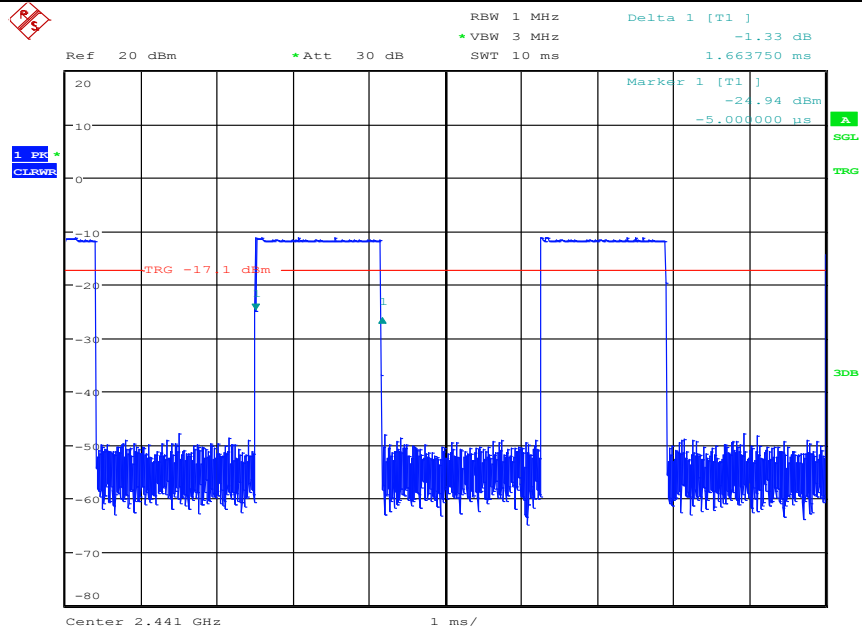

Date: 18.OCT.2018 17:33:50

GFSK_DH3/HCH

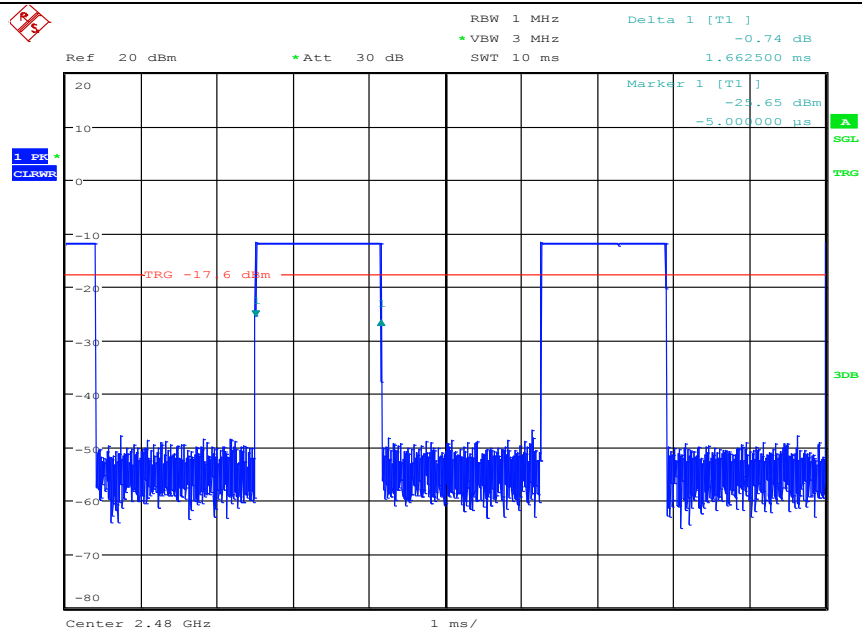

Date: 18.OCT.2018 17:34:15

$\pi/4$ DQPSK
_2DH3/LCH

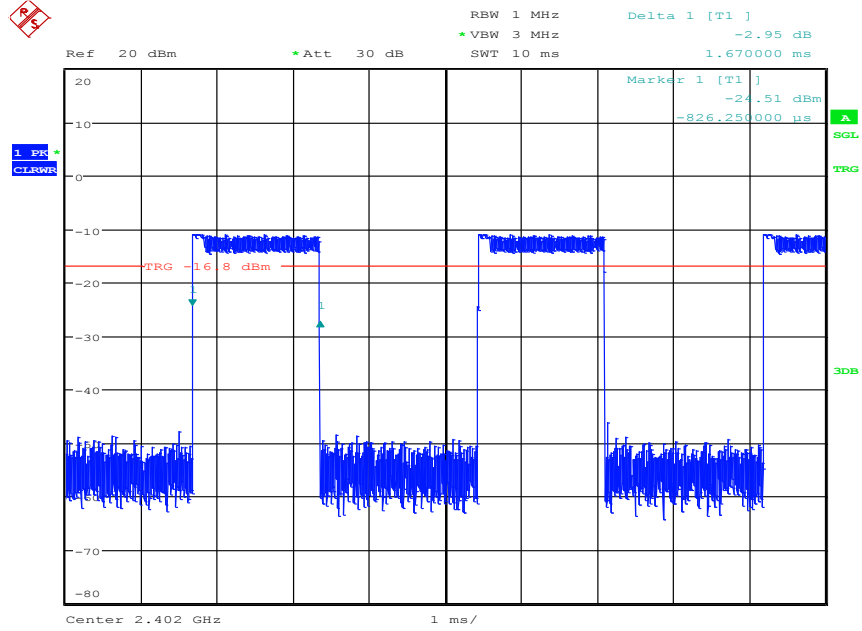

Date: 18.OCT.2018 17:37:48

$\pi/4$ DQPSK
_2DH3/MCH

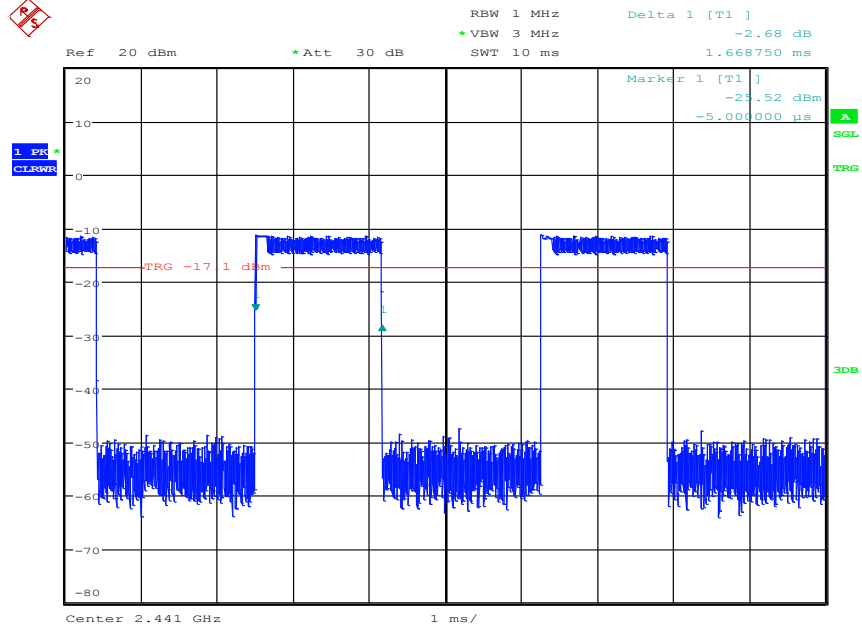

Date: 18.OCT.2018 17:38:19

$\pi/4$ DQPSK
_2DH3/HCH

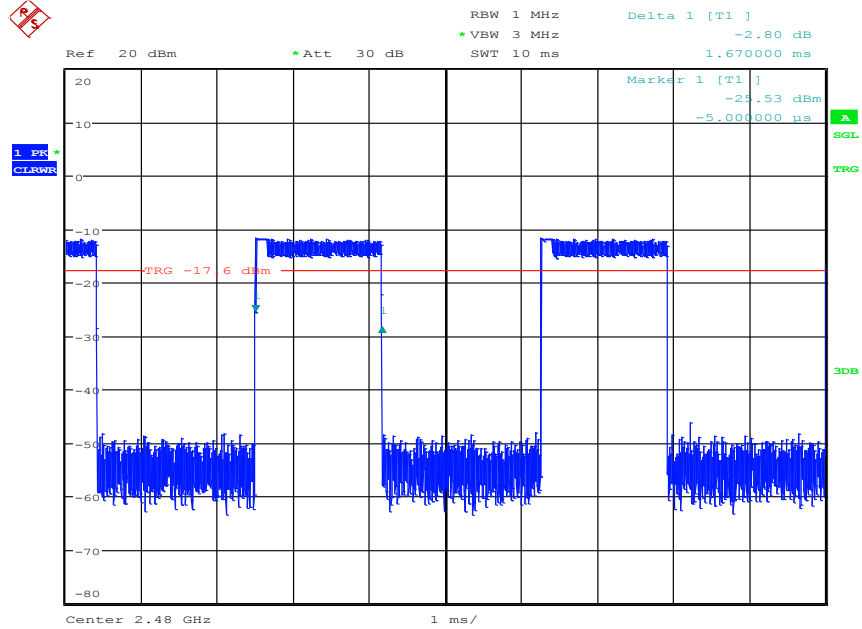

Date: 18.OCT.2018 17:38:43

8DPSK_3DH3/LCH

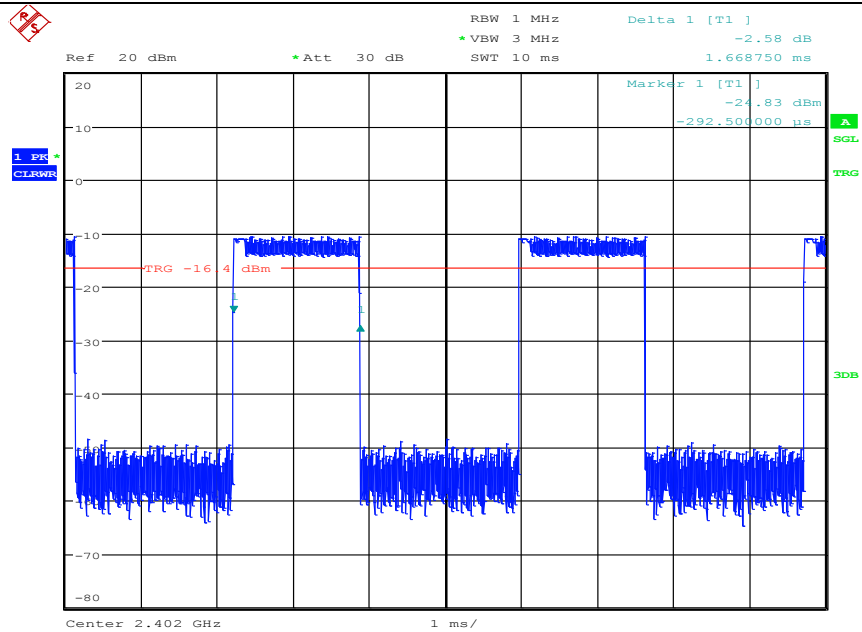

Date: 18.OCT.2018 17:42:10

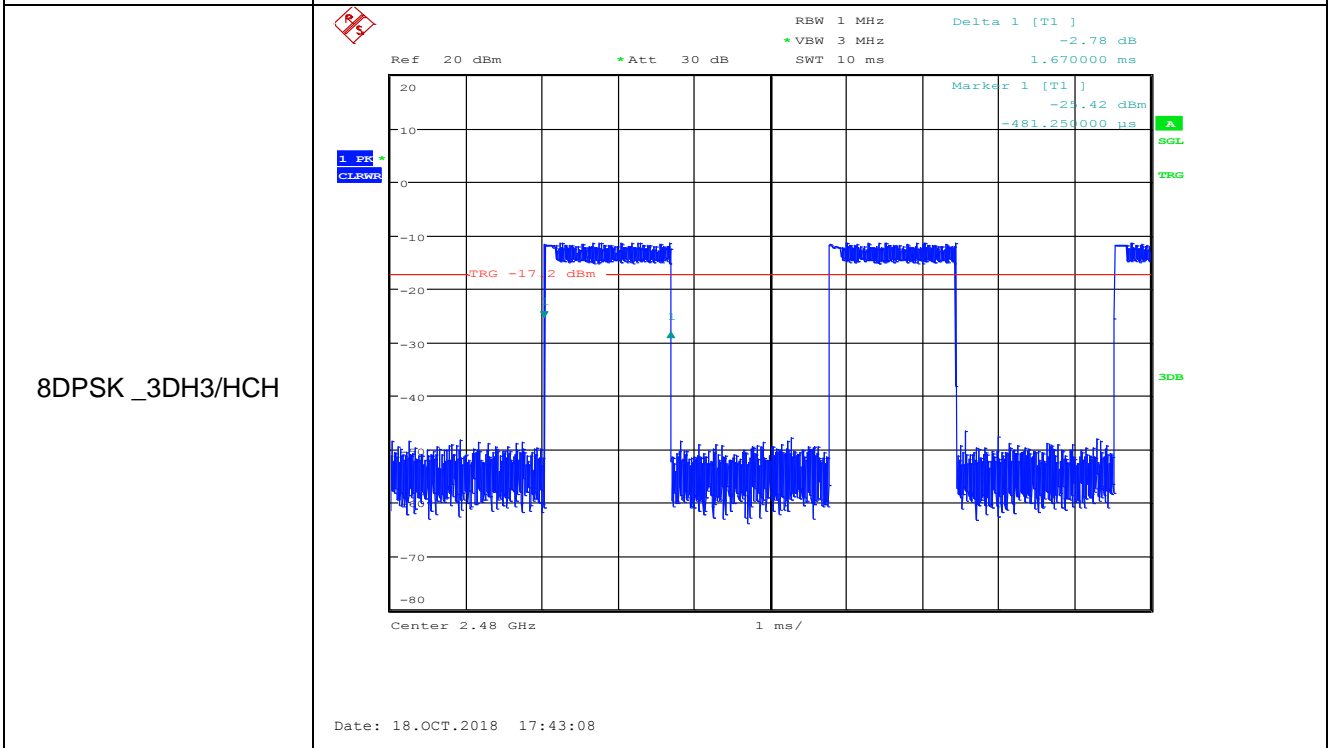
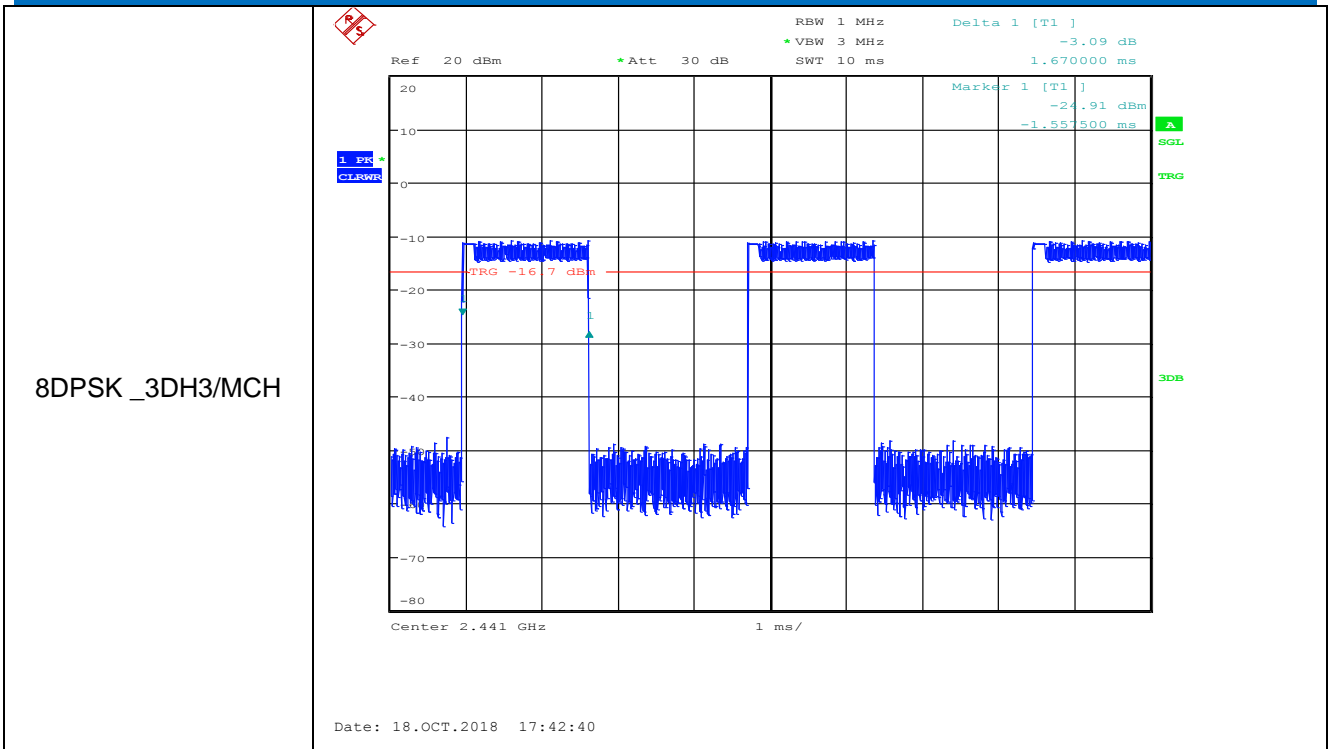

GFSK_DH5/LCH

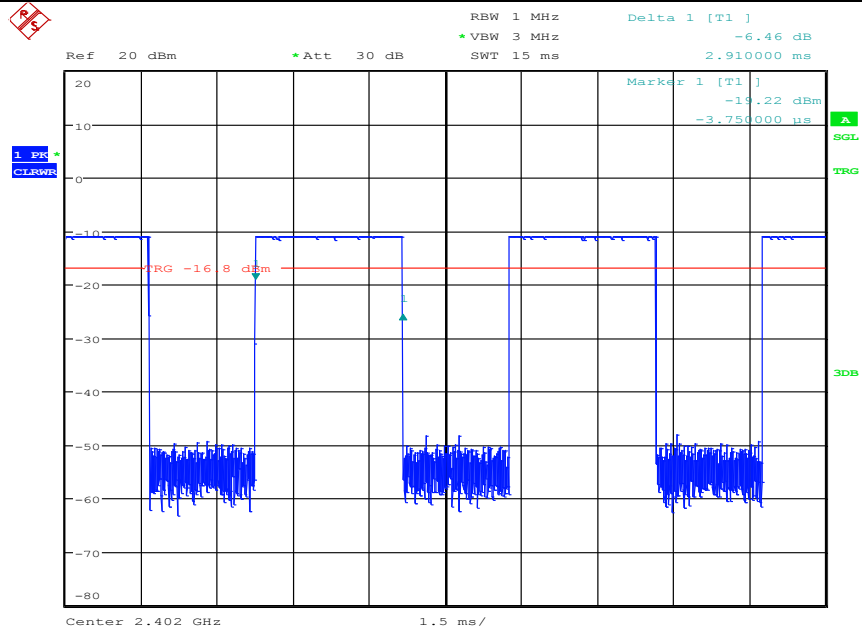

Date: 18.OCT.2018 17:34:53

GFSK_DH5/MCH

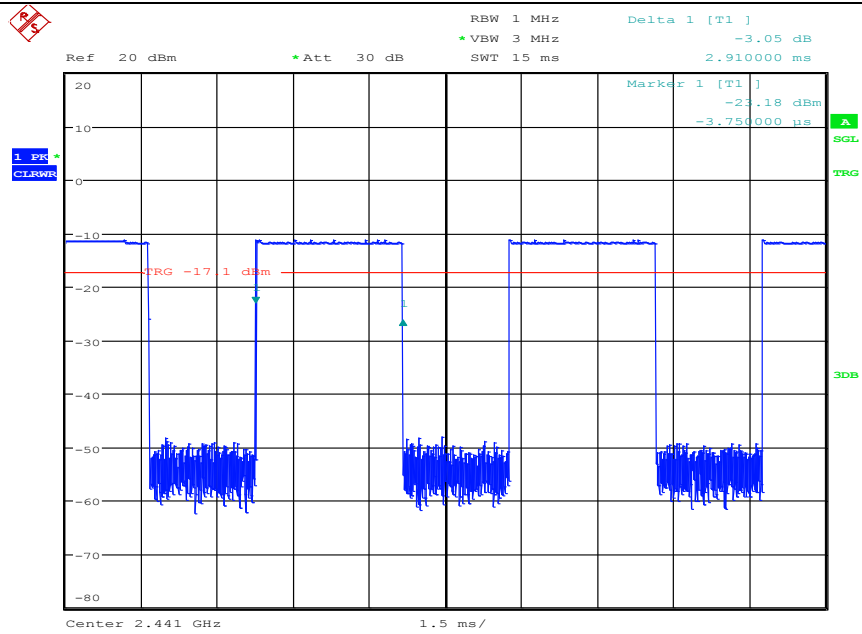

Date: 18.OCT.2018 17:35:25

GFSK_DH5/HCH

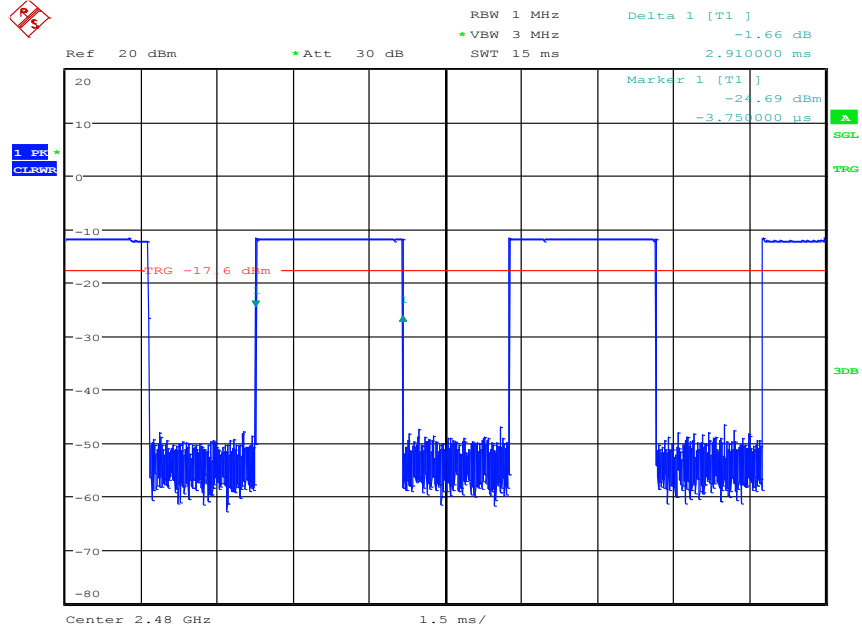

Date: 18.OCT.2018 17:35:53

$\pi/4$ DQPSK
_2DH5/LCH

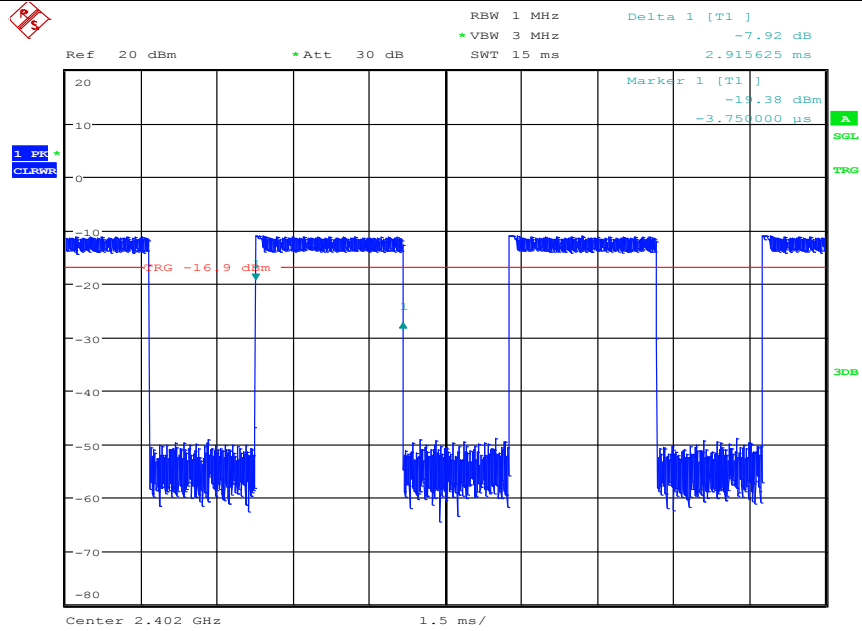

Date: 18.OCT.2018 17:39:18

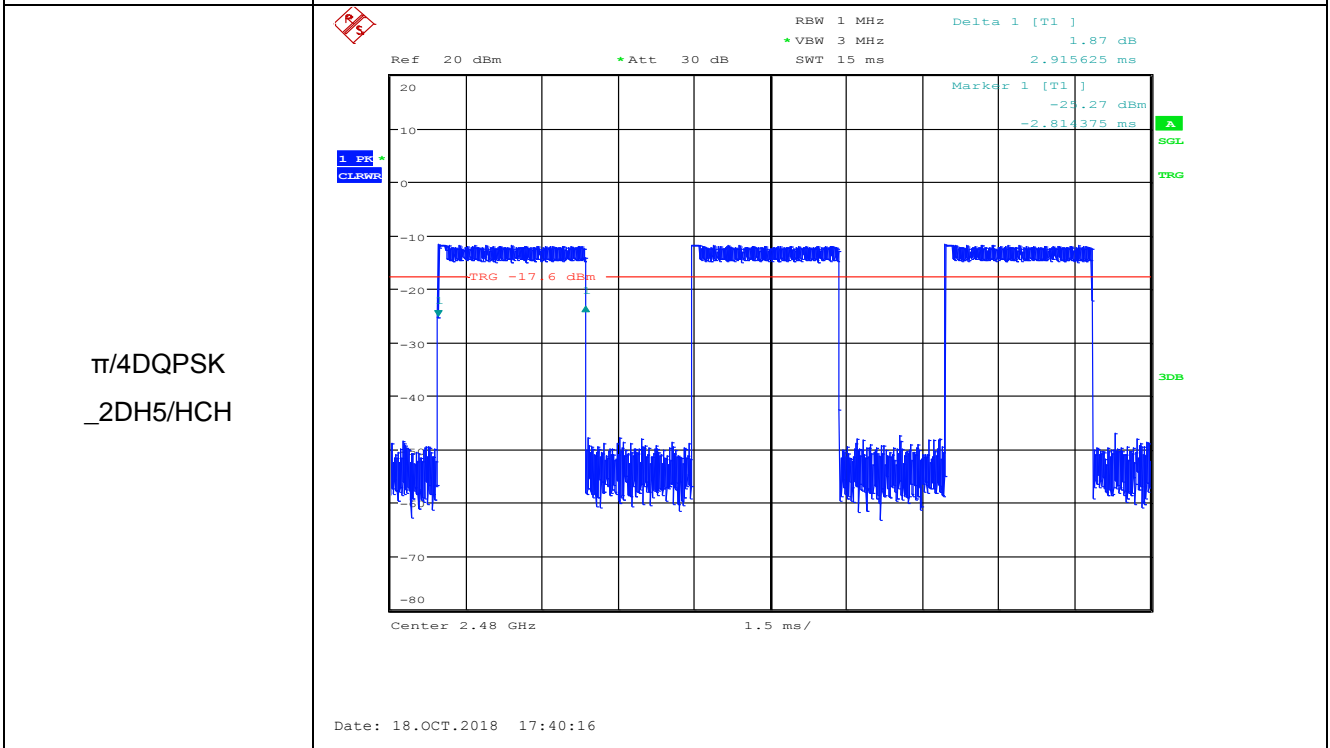
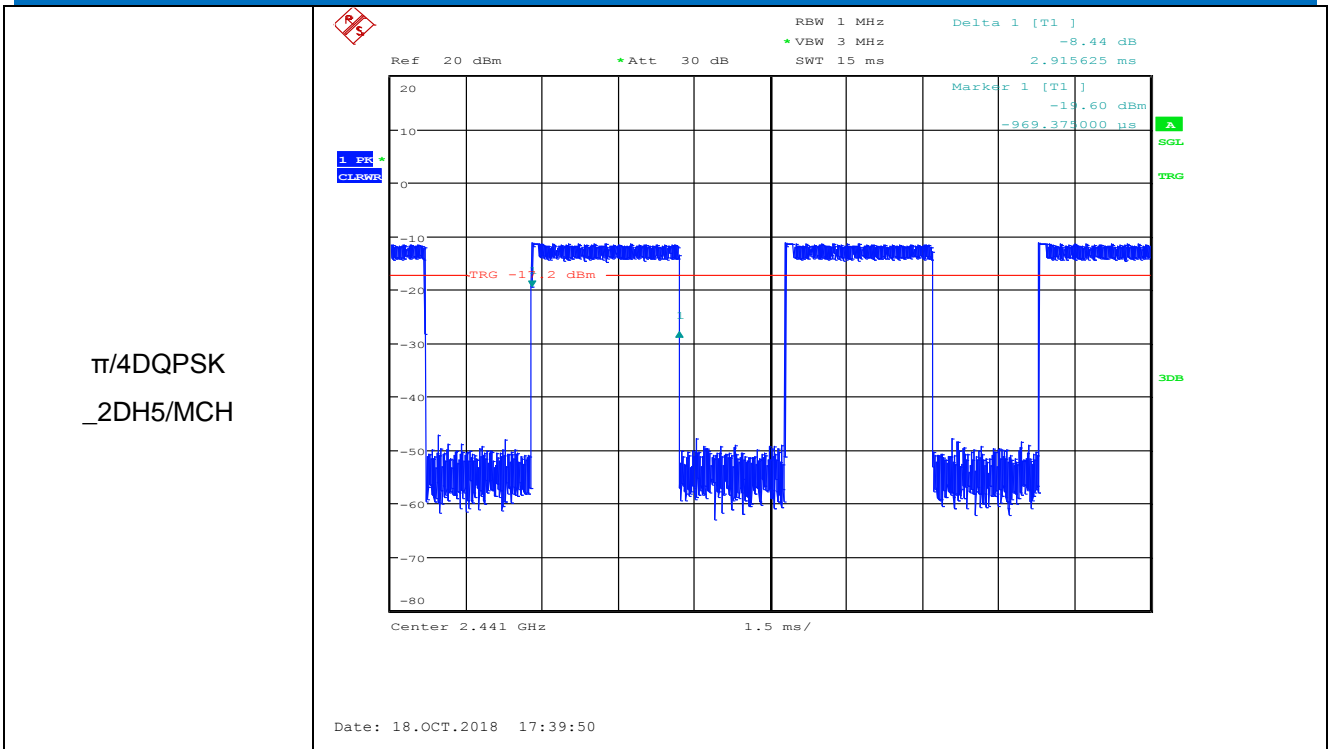

8DPSK_3DH5/LCH

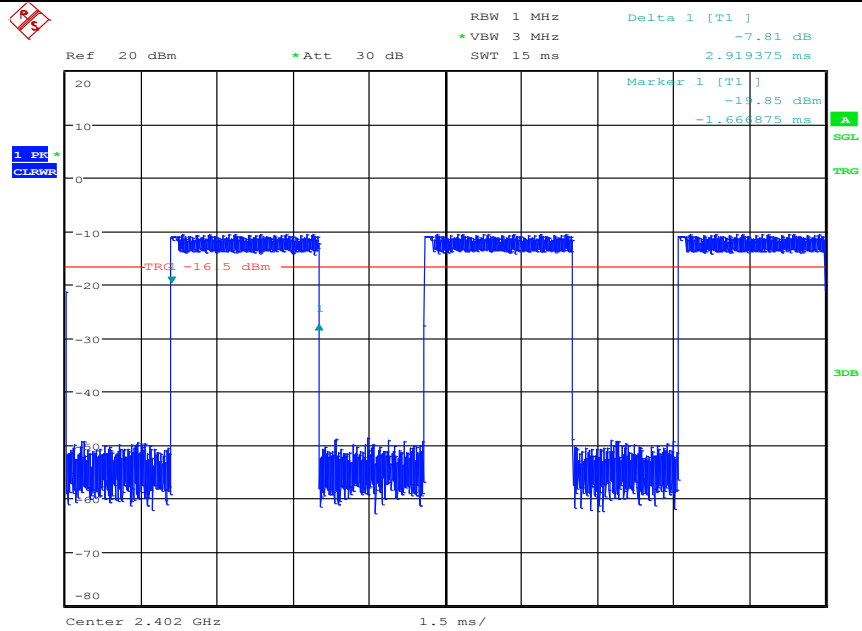

Date: 18.OCT.2018 17:43:38

8DPSK_3DH5/MCH

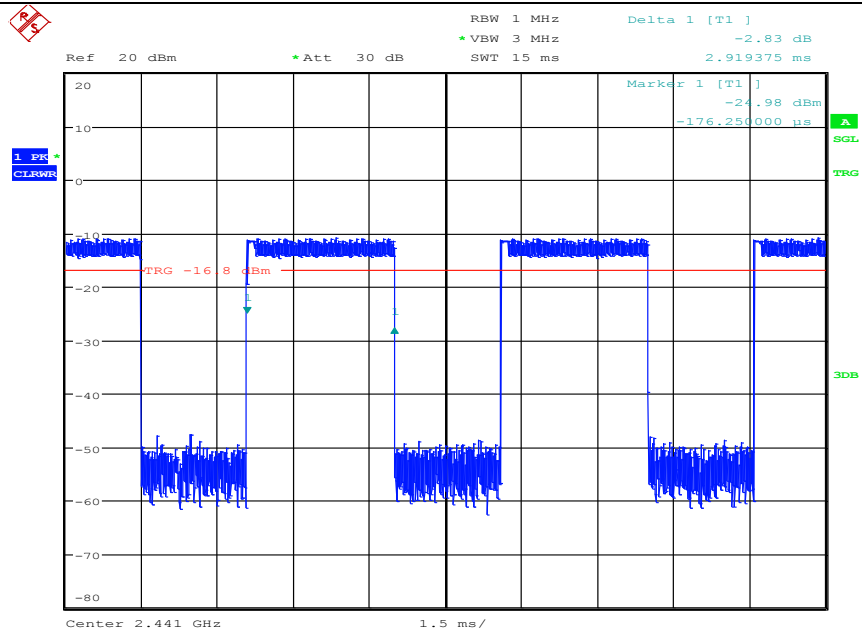

Date: 18.OCT.2018 17:44:08

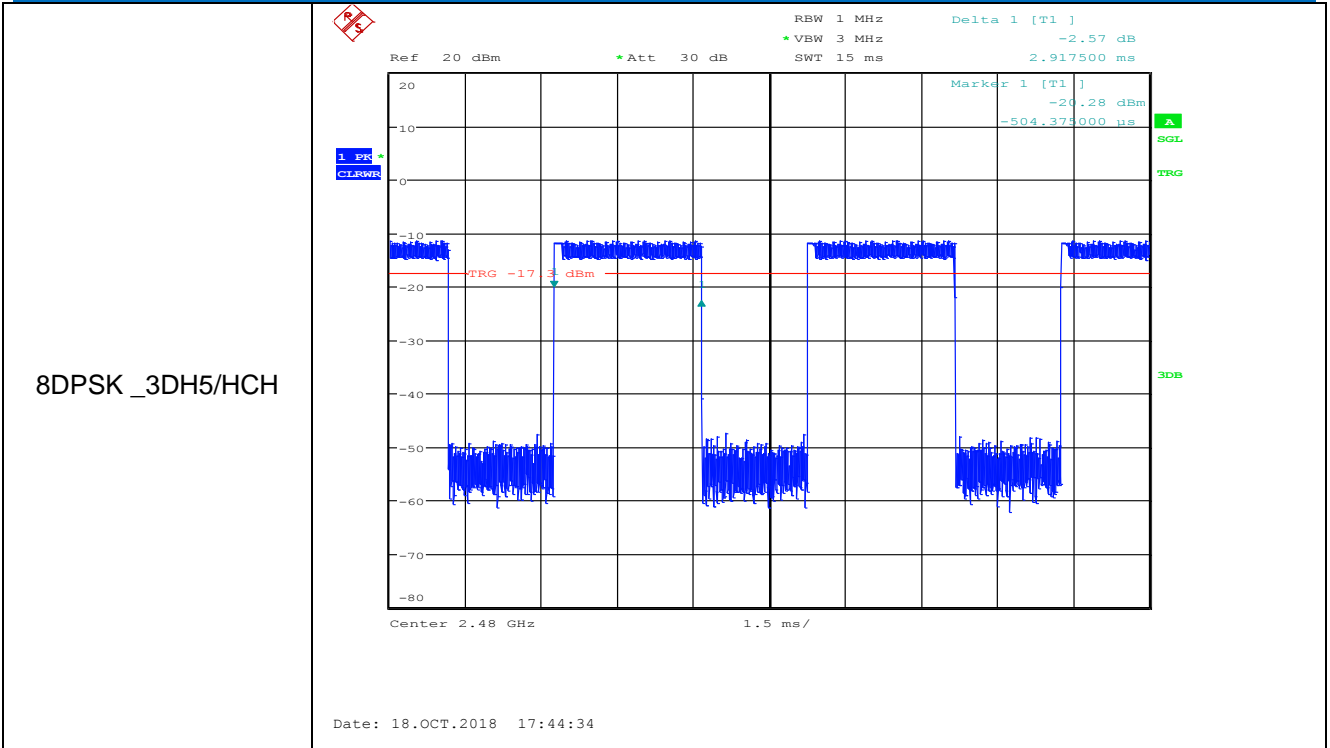

5.7 Band-edge for RF Conducted Emissions

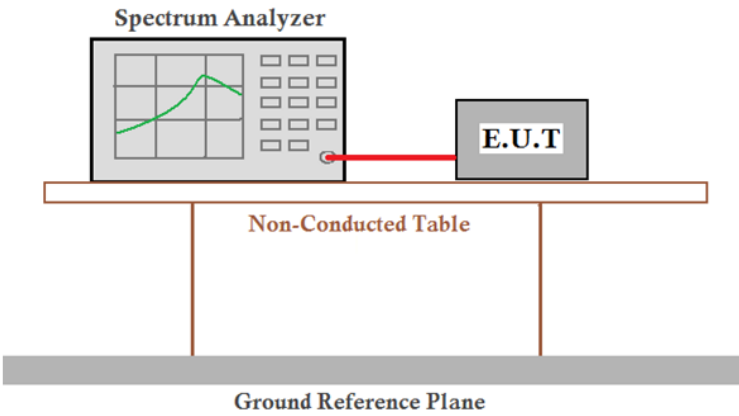
Test Requirement:	47 CFR Part 15C Section 15.247 (d)
Test Method:	ANSI C63.10:2013
Test Setup:	 <p style="text-align: center;"><i>Remark: Offset=cable loss+ attenuation factor.</i></p>
Limit:	In any 100 kHz bandwidth outside the frequency band in which the spread spectrum intentional radiator is operating, the radio frequency power that is produced by the intentional radiator shall be at least 20 dB below that in the 100 kHz bandwidth within the band that contains the highest level of the desired power, based on either an RF conducted or a radiated measurement.
Exploratory Test Mode:	Hopping and Non-hopping transmitting with all kind of modulation and all kind of data type
Final Test Mode:	Through Pre-scan, find the DH5 of data type is the worst case of GFSK modulation type, 2-DH5 of data type is the worst case of $\pi/4$ DQPSK modulation type, 3-DH5 of data type is the worst case of 8DPSK modulation type. Only the worst case is recorded in the report.
Test Results:	Pass

Mode	Test Channel	Frequency [MHz]	Frequency Hopping	Emission Level [dBm]	Limit [dBm]	Result
GFSK	LCH	2400	Off	-38.600	-20.64	PASS
			On	-35.980	-20.88	PASS
GFSK	HCH	2483.5	Off	-37.090	-21.92	PASS
			On	-35.430	-20.95	PASS
$\pi/4$ DQPSK	LCH	2400	Off	-39.610	-21.56	PASS
			On	-35.000	-20.85	PASS
$\pi/4$ DQPSK	HCH	2483.5	Off	-36.640	-21.53	PASS
			On	-35.670	-20.95	PASS
8DPSK	LCH	2400	Off	-38.590	-20.9	PASS
			On	-34.030	-20.72	PASS
8DPSK	HCH	2483.5	Off	-39.600	-21.6	PASS
			On	-35.090	-20.82	PASS

Test plot as follows:

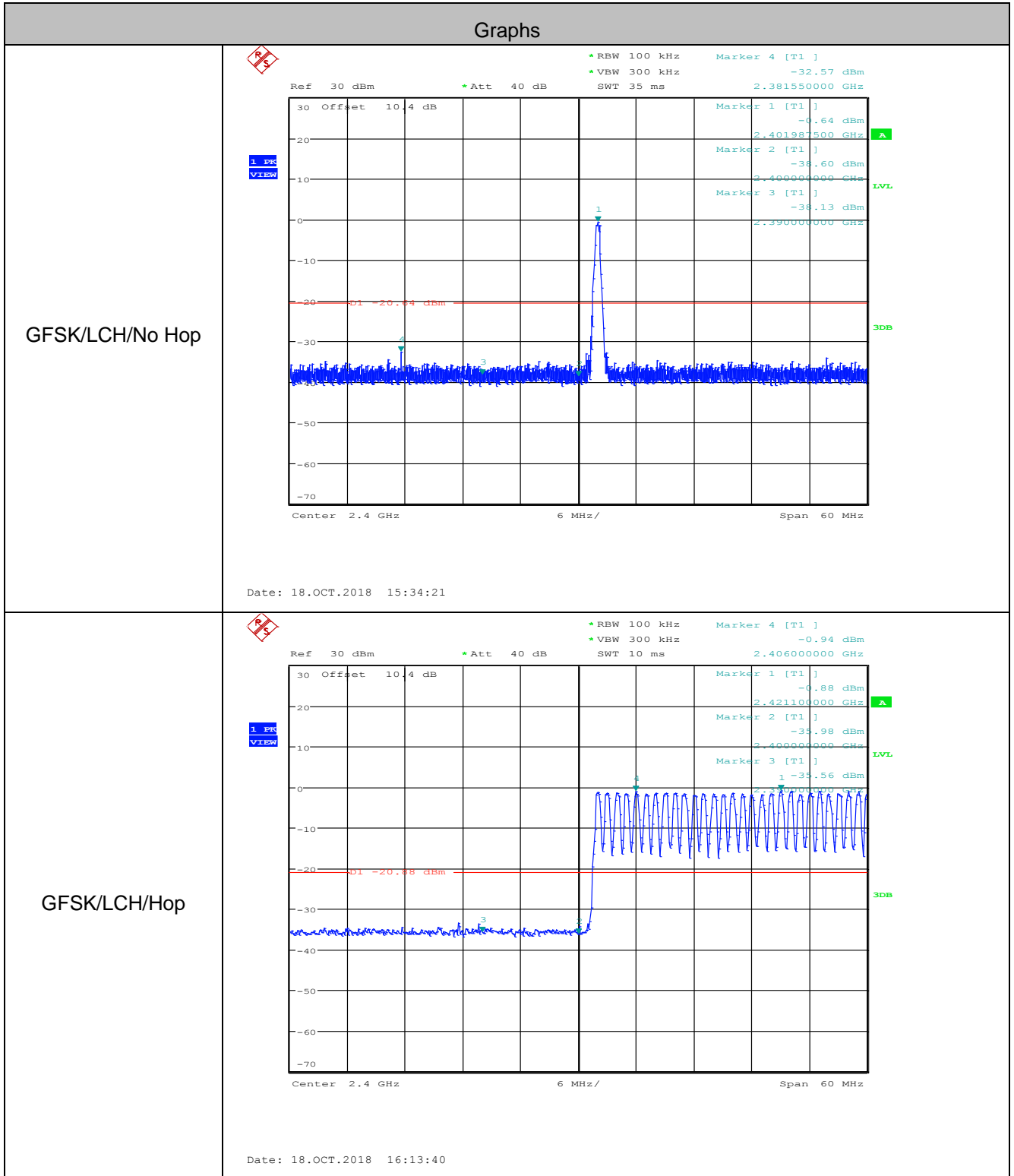

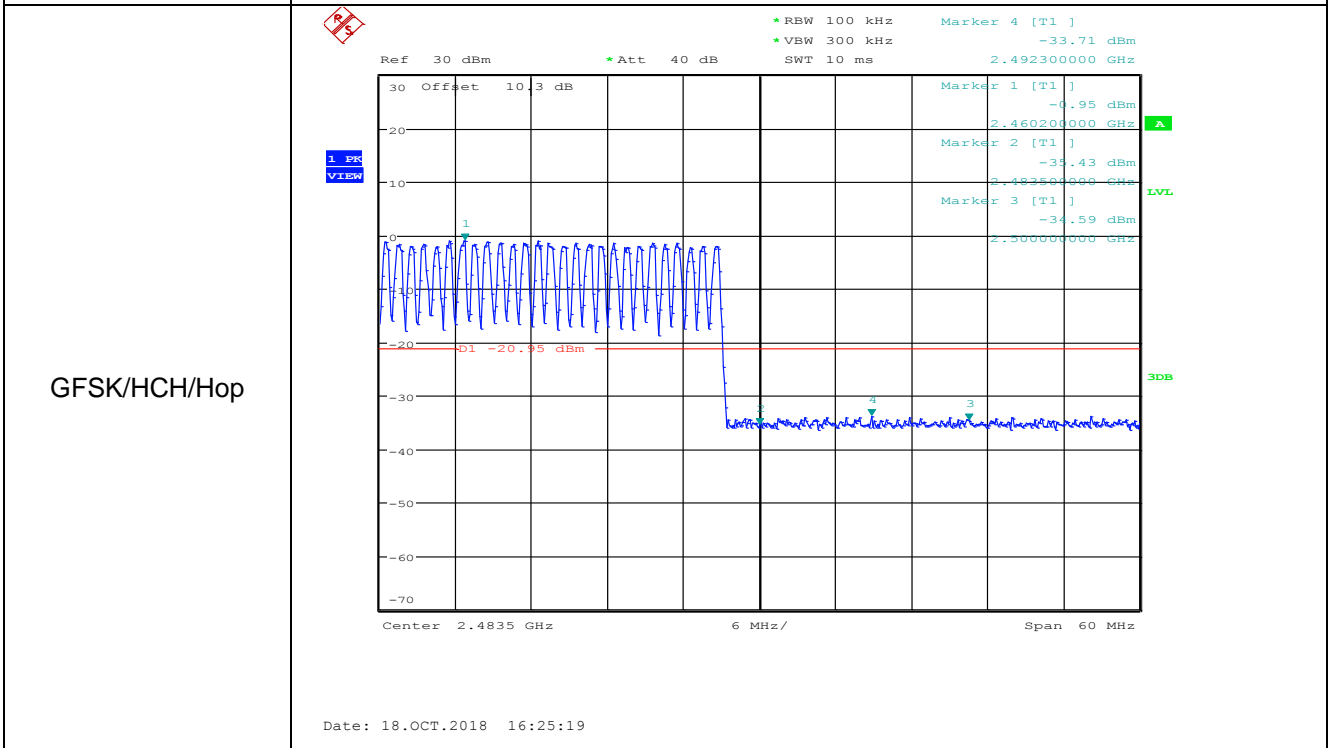
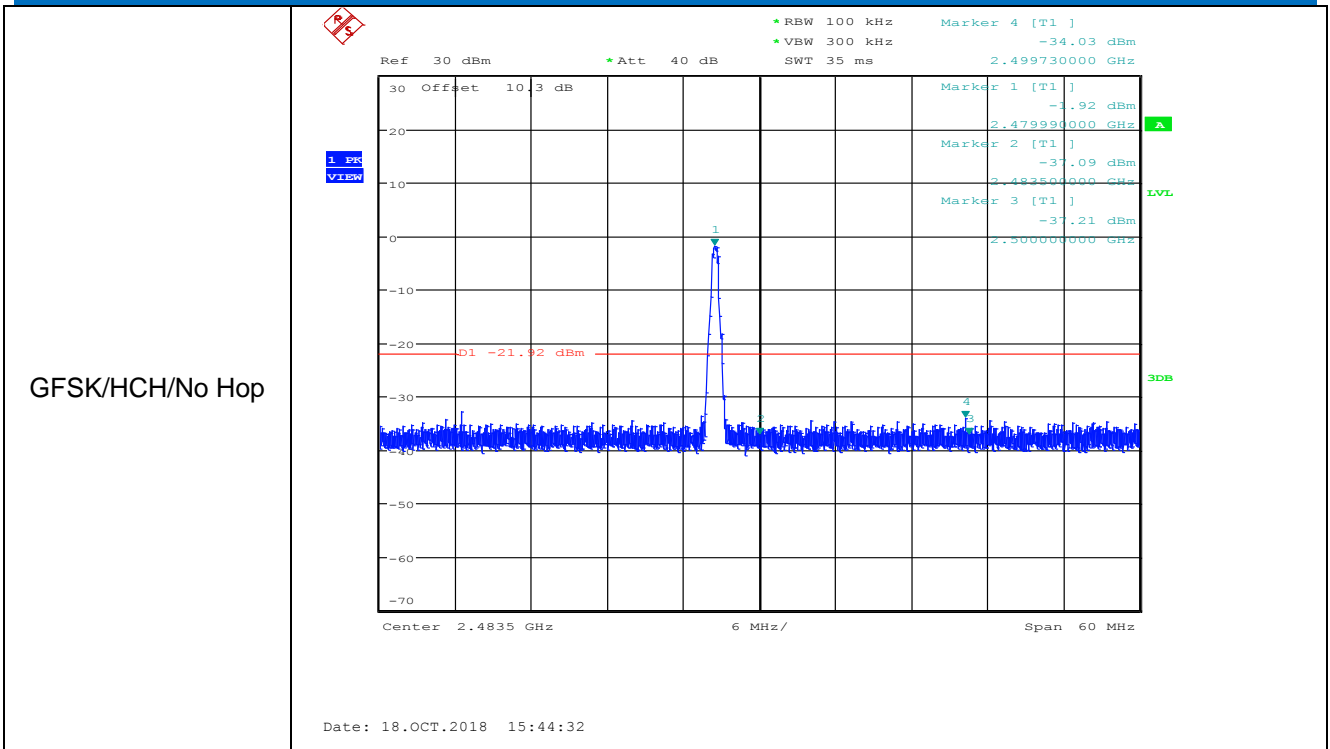

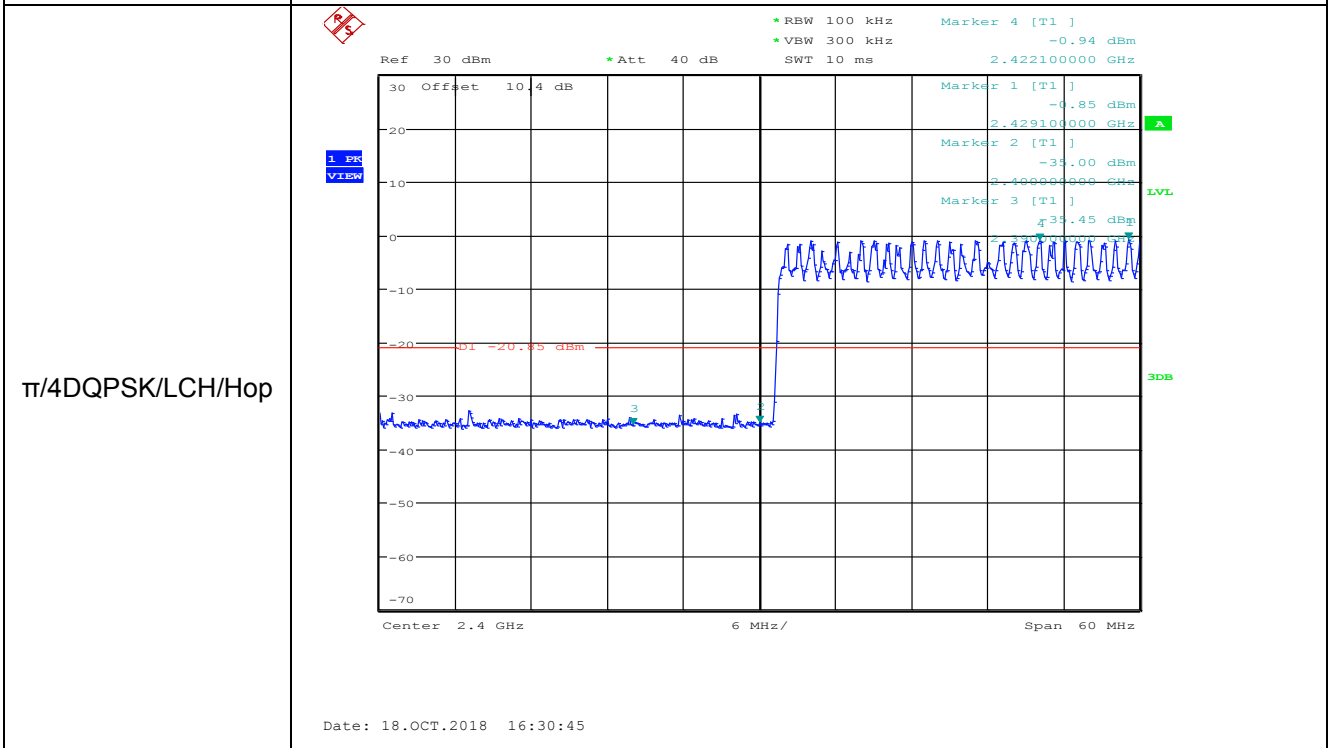
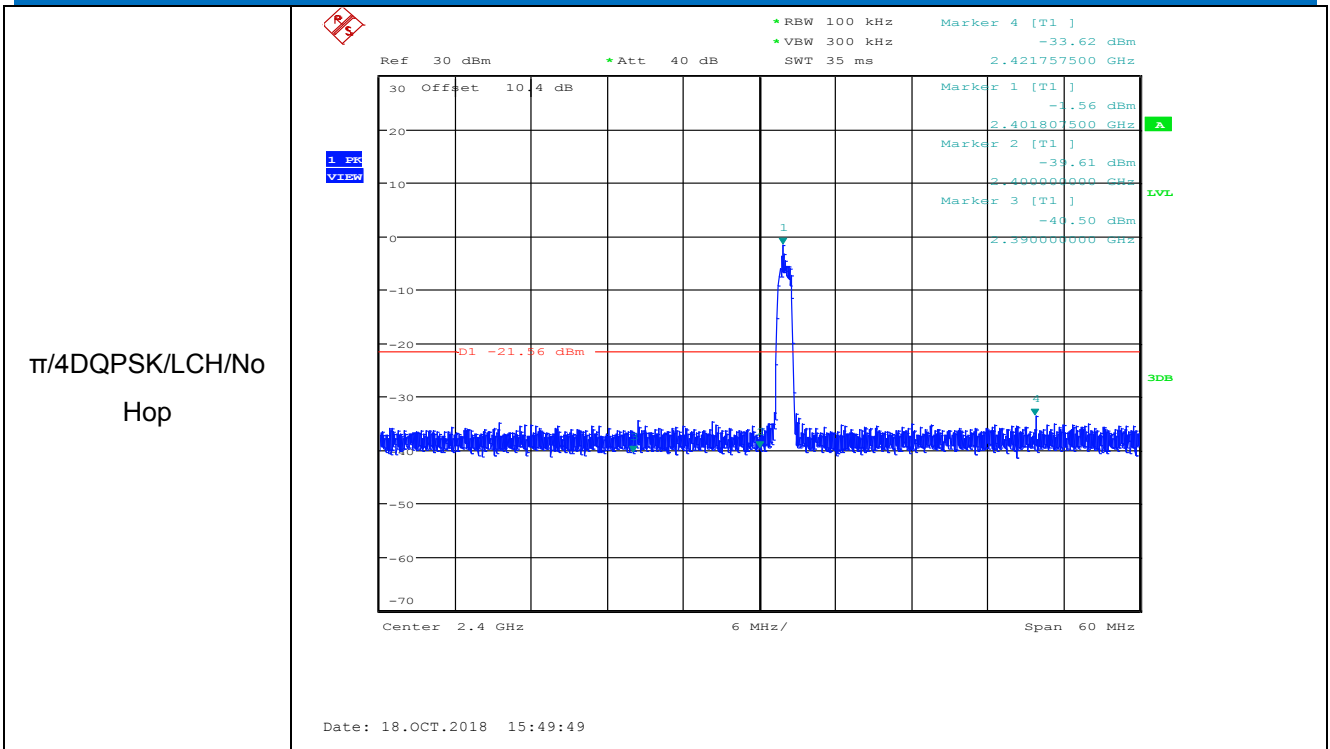

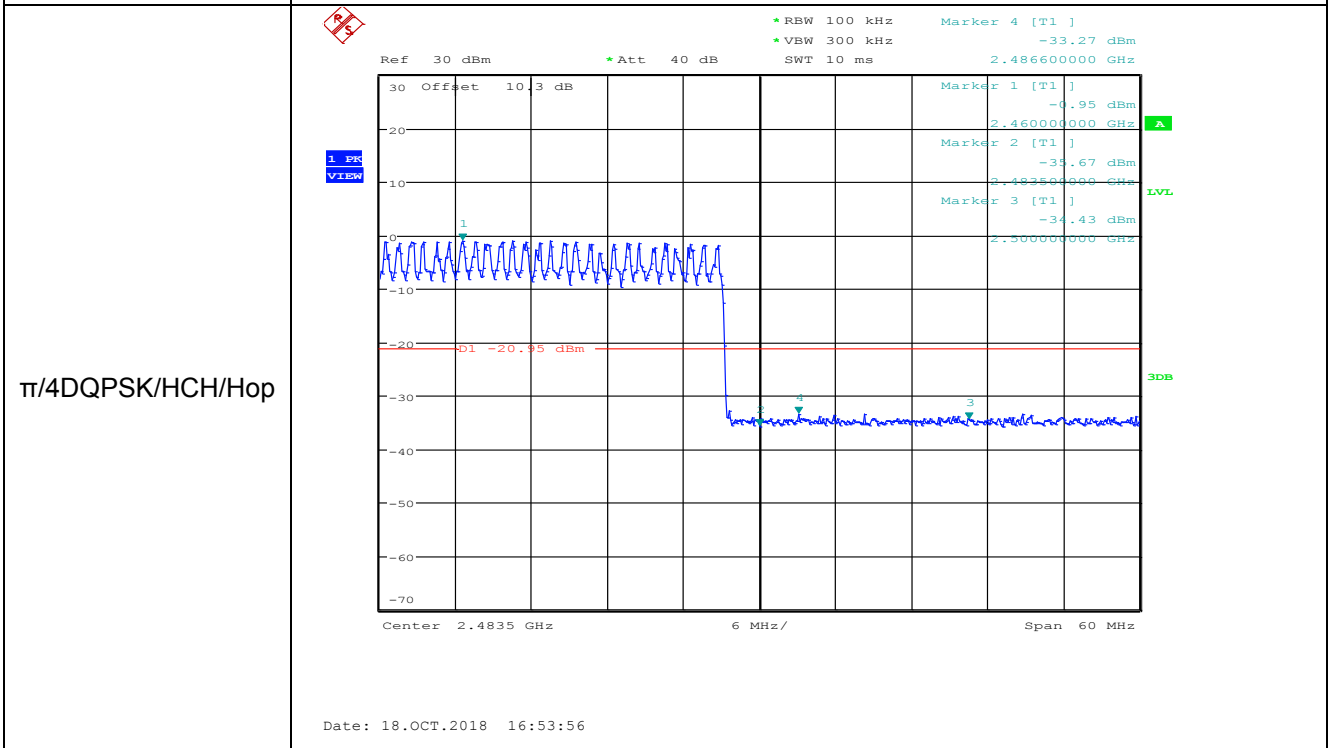
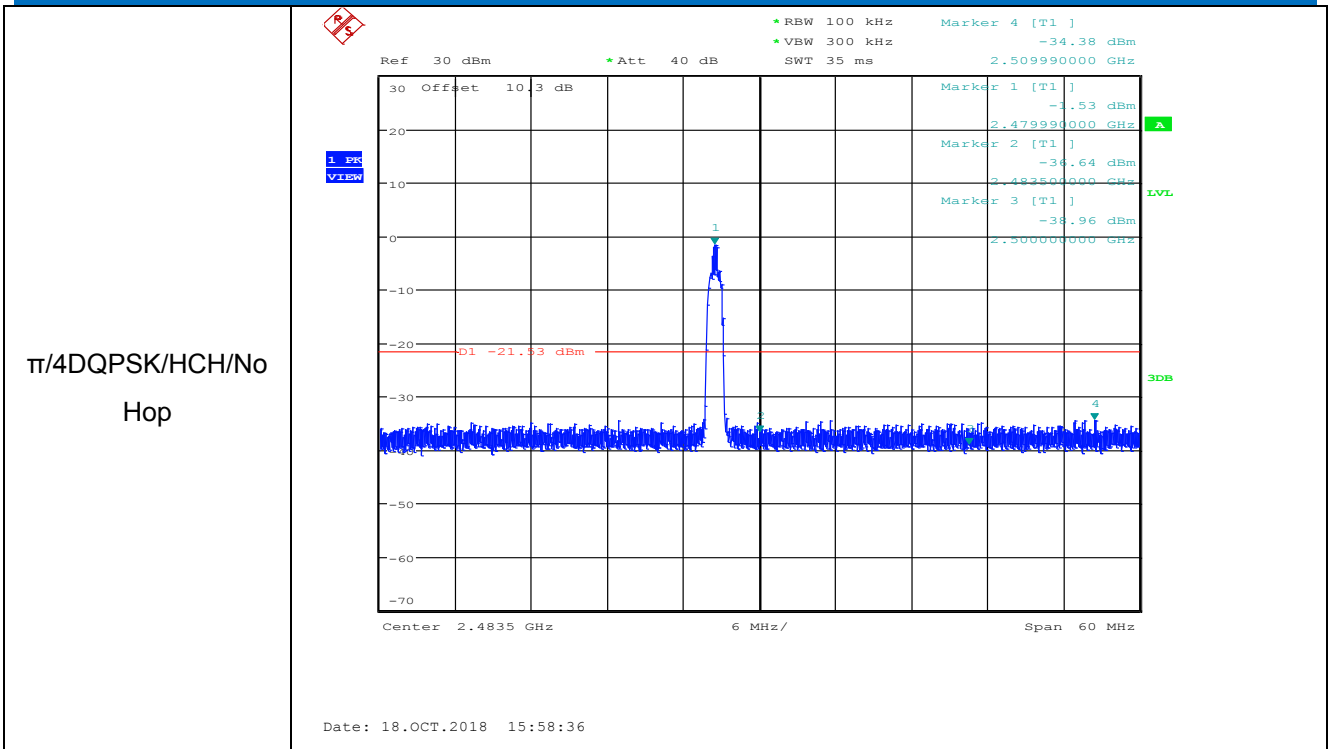

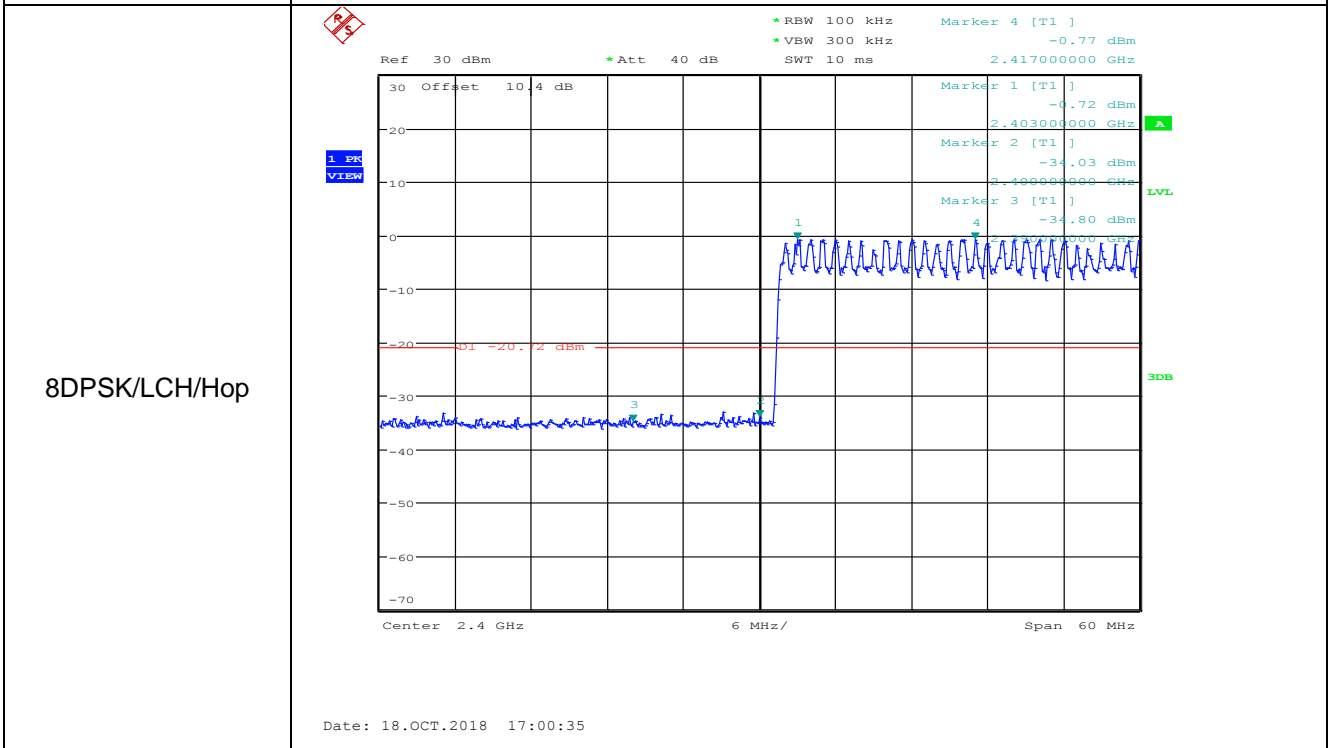
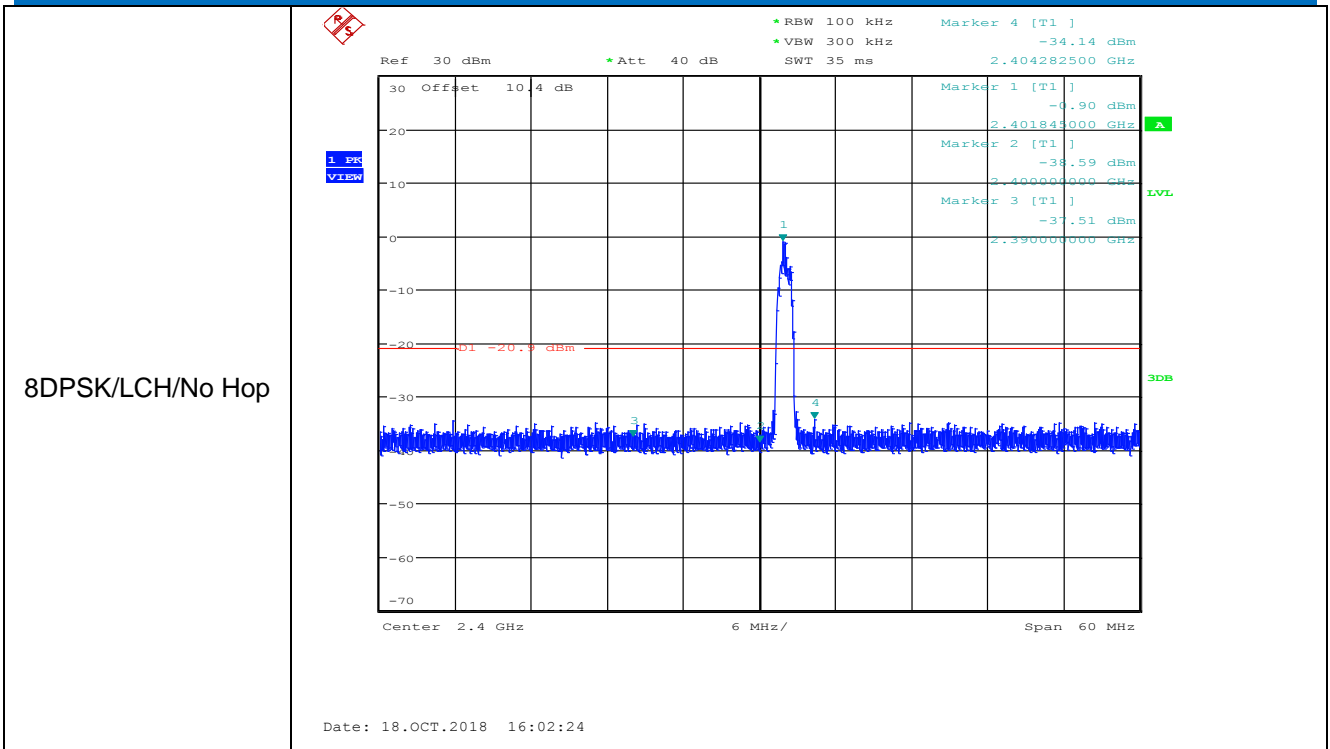

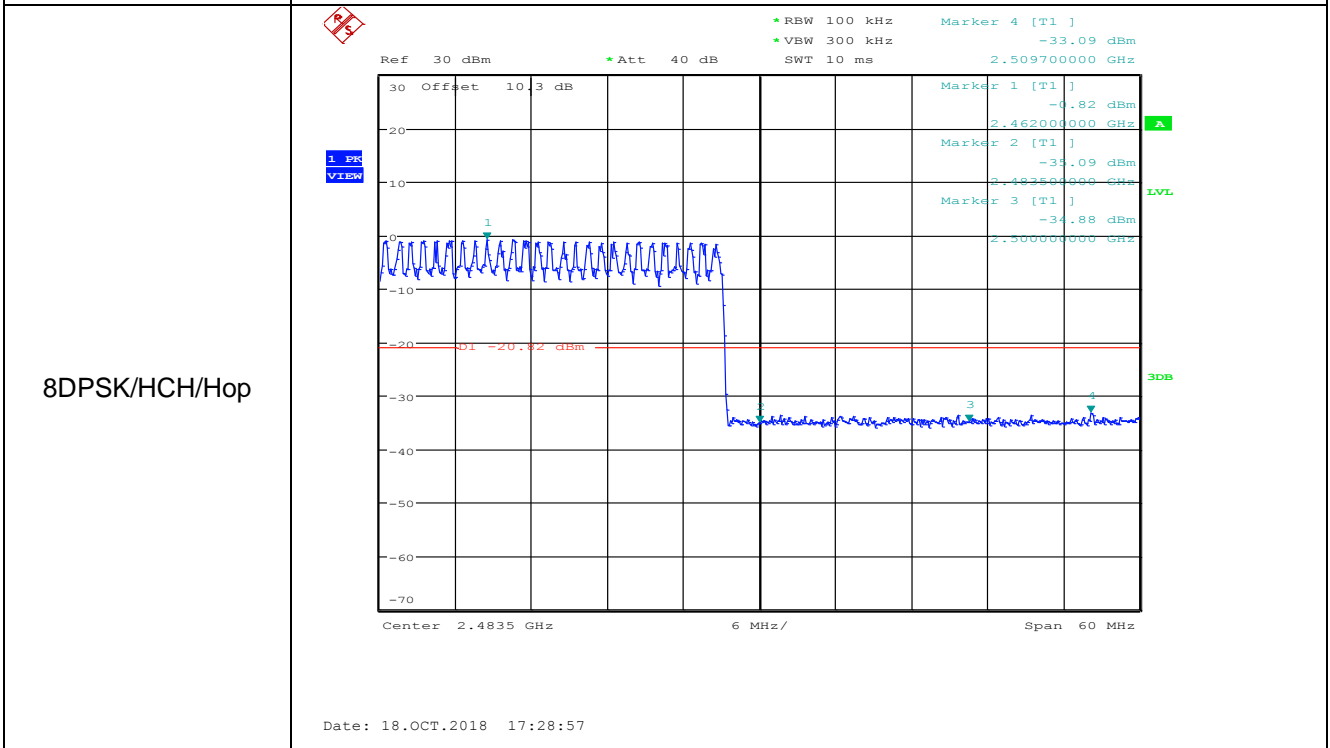
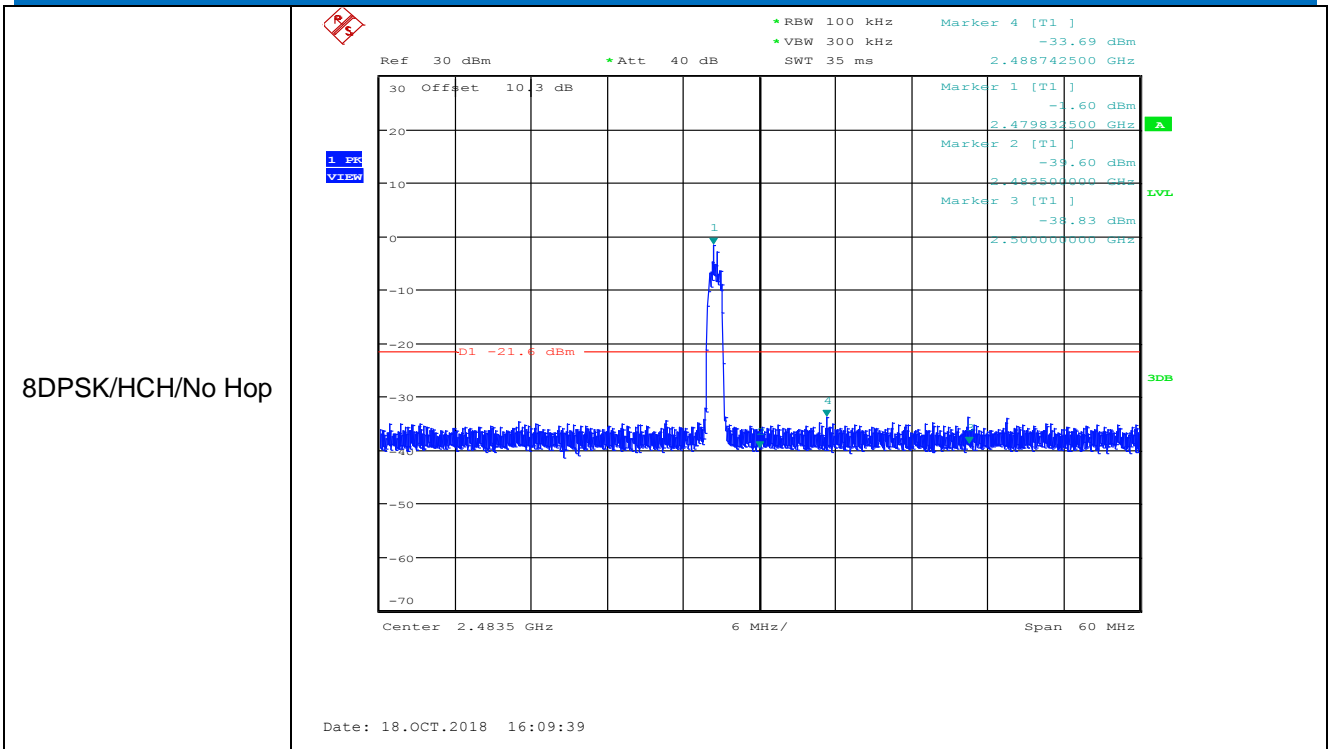

5.8 Spurious RF Conducted Emissions

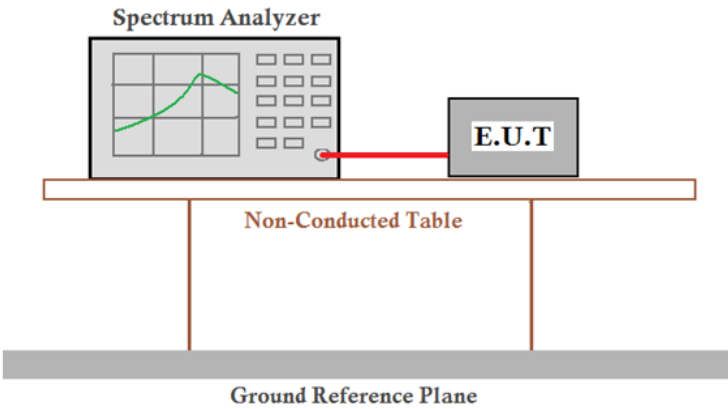
Test Requirement:	47 CFR Part 15C Section 15.247 (d)
Test Method:	ANSI C63.10:2013
Test Setup:	 <p style="text-align: center;"><i>Remark: Offset=cable loss+ attenuation factor.</i></p>
Limit:	In any 100 kHz bandwidth outside the frequency band in which the spread spectrum intentional radiator is operating, the radio frequency power that is produced by the intentional radiator shall be at least 20 dB below that in the 100 kHz bandwidth within the band that contains the highest level of the desired power, based on either an RF conducted or a radiated measurement.
Exploratory Test Mode:	Non-hopping transmitting with all kind of modulation and all kind of data type
Final Test Mode:	Through Pre-scan, find the DH5 of data type is the worst case of GFSK modulation type, 2-DH5 of data type is the worst case of $\pi/4$ DQPSK modulation type, 3-DH5 of data type is the worst case of 8DPSK modulation type.
Test Results:	Pass

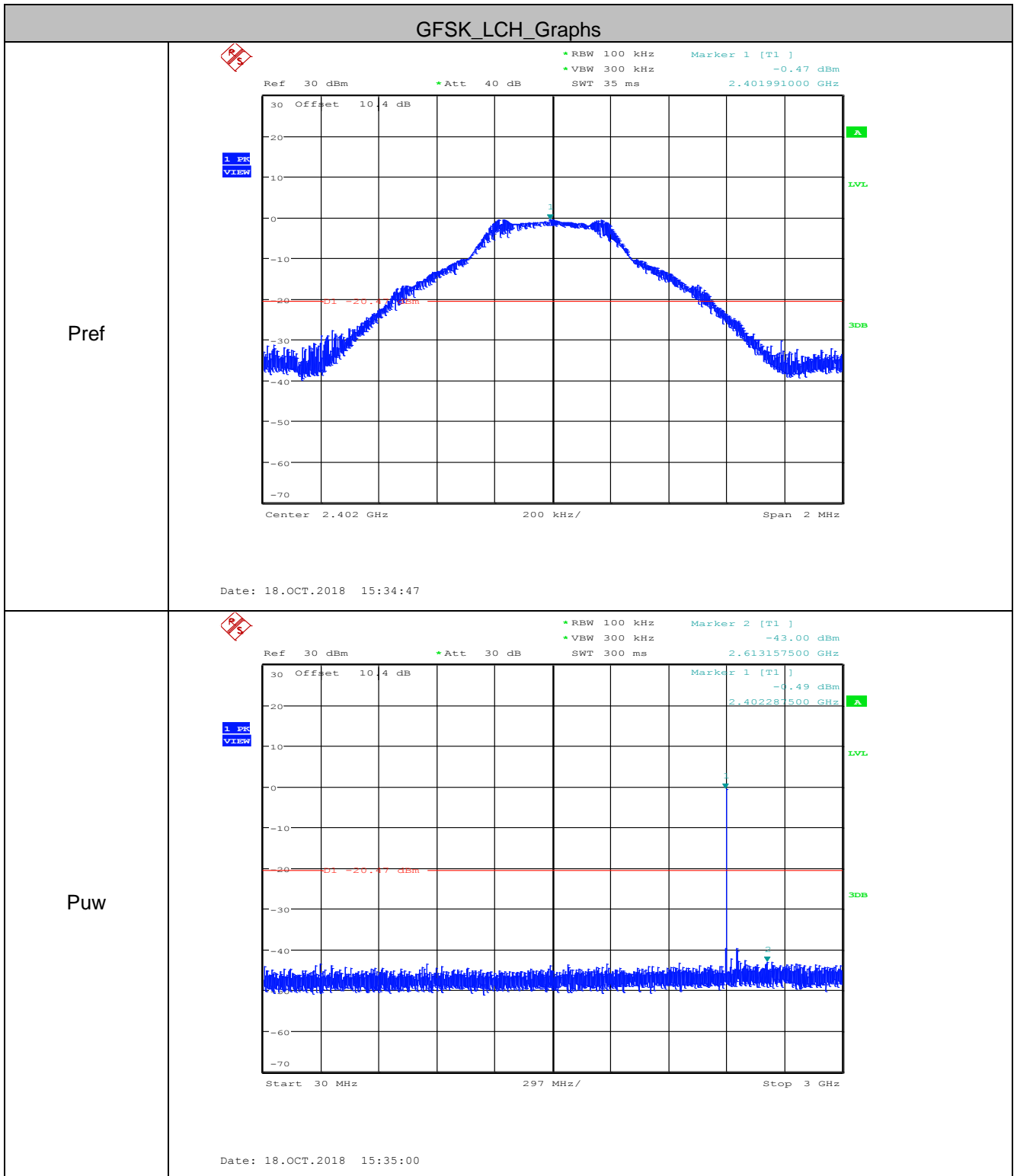

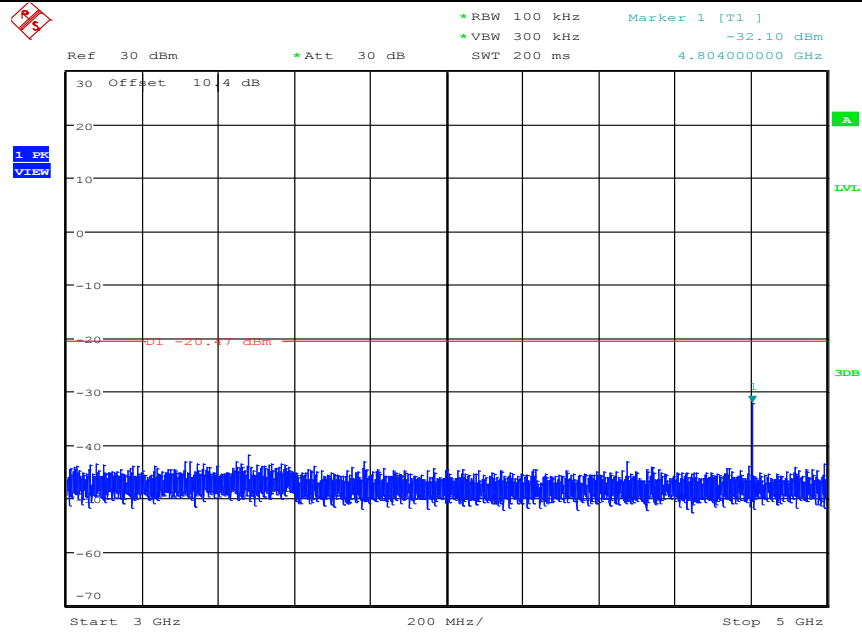

Date: 18.OCT.2018 15:35:11

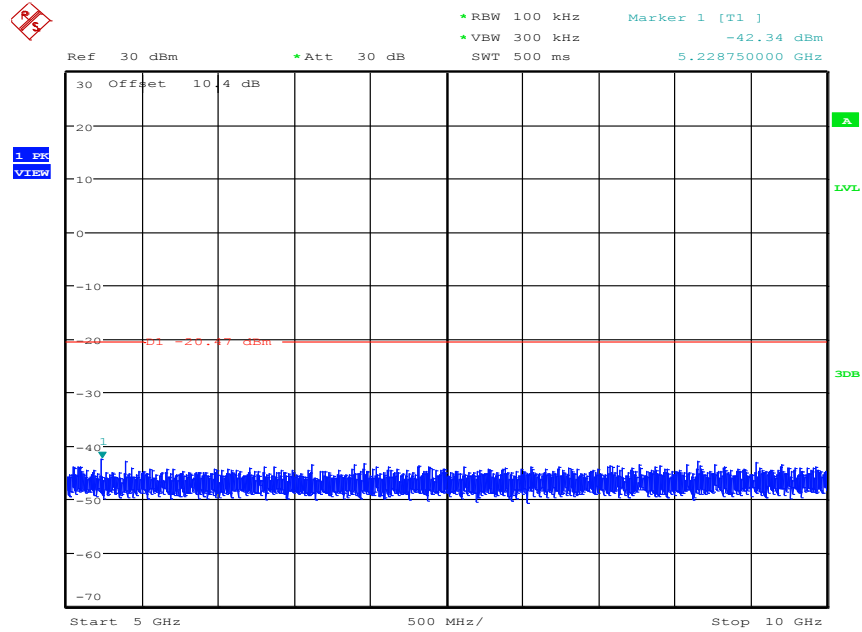

Date: 18.OCT.2018 15:35:24

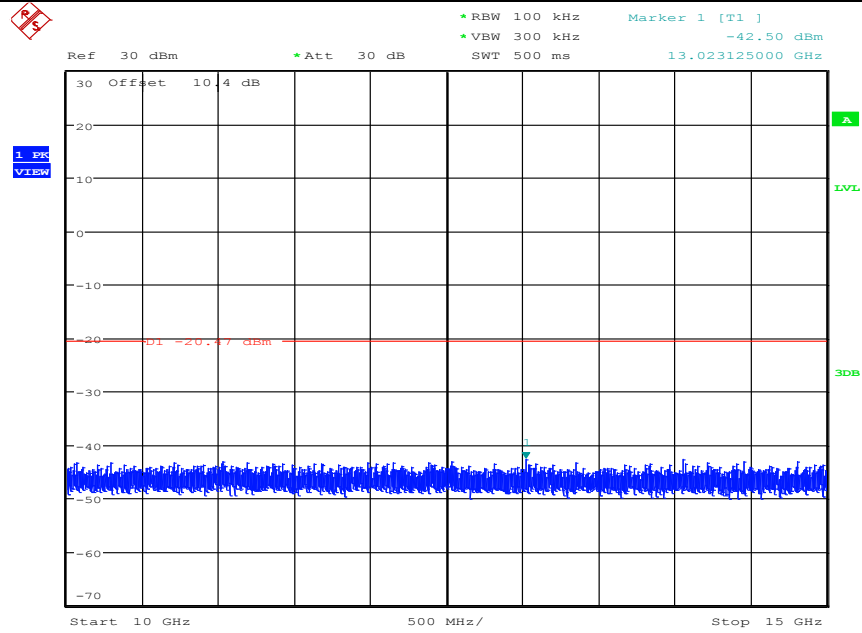

Date: 18.OCT.2018 15:35:37

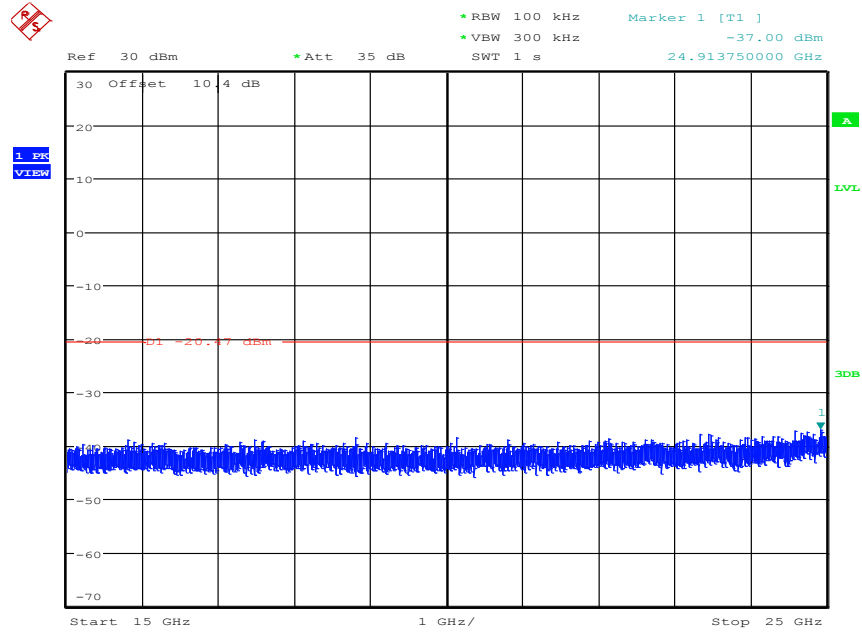

Date: 18.OCT.2018 15:35:49

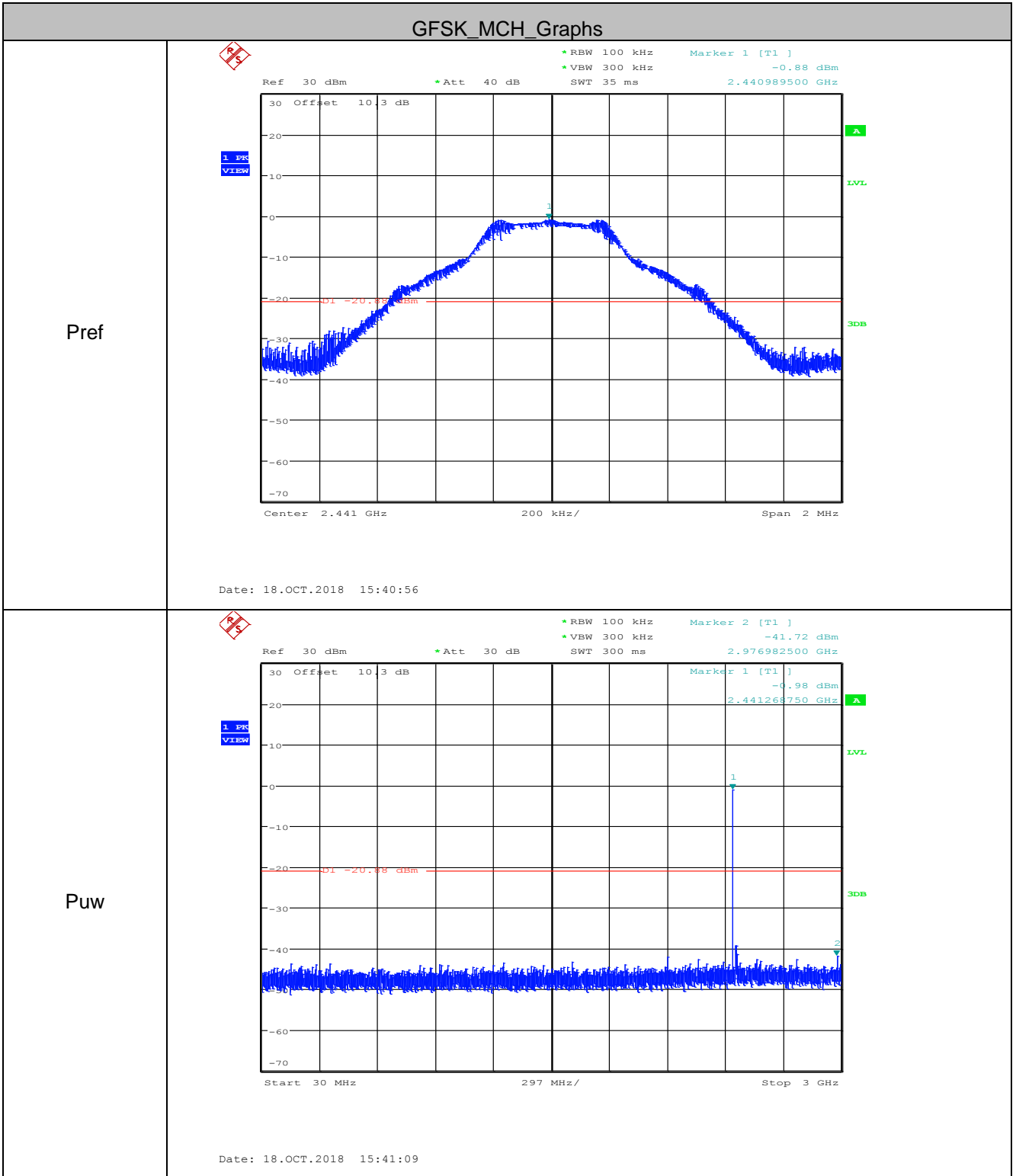

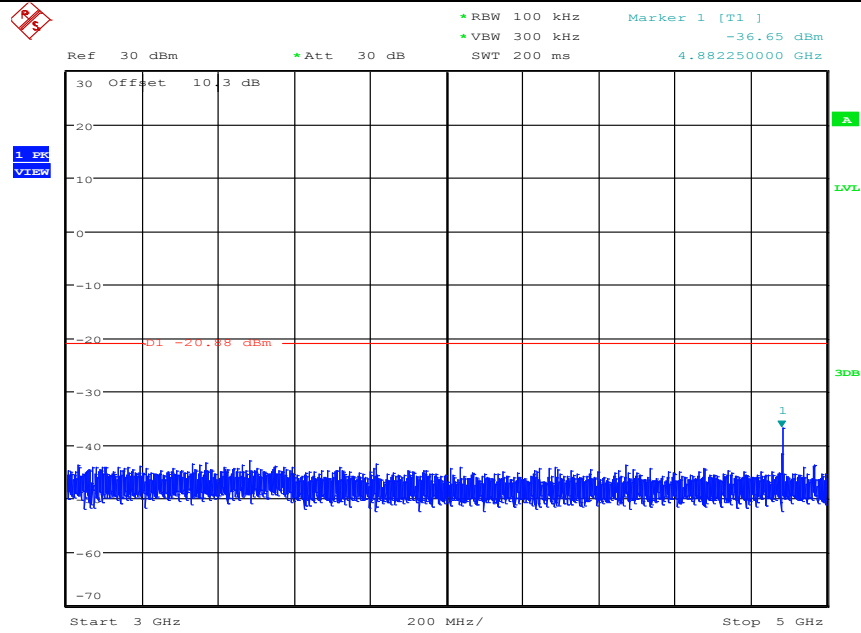

Date: 18.OCT.2018 15:41:20

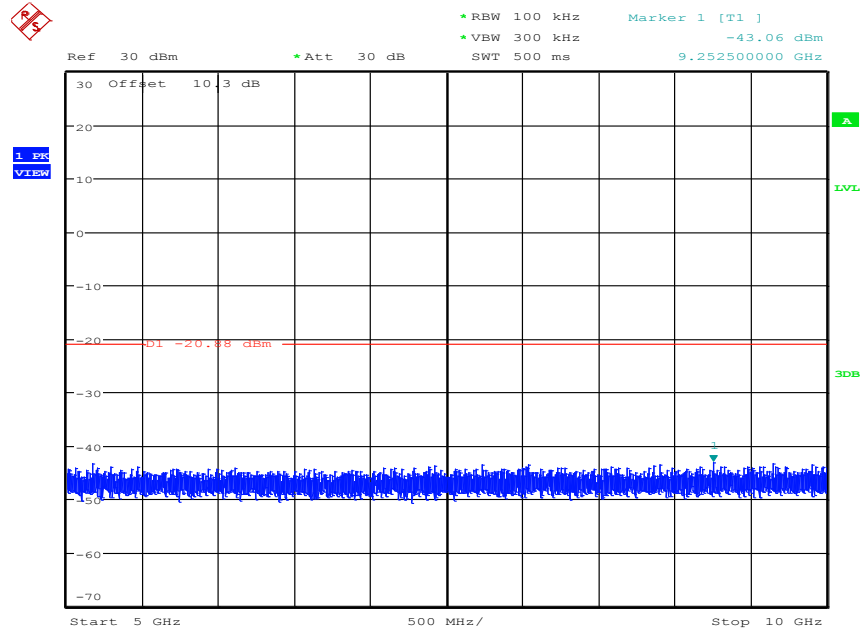

Date: 18.OCT.2018 15:41:33

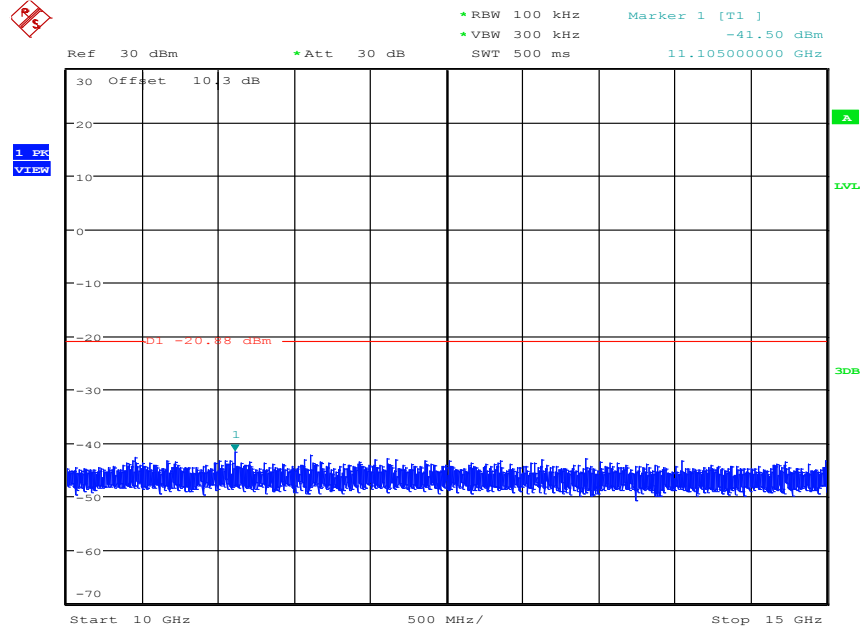

Date: 18.OCT.2018 15:41:46

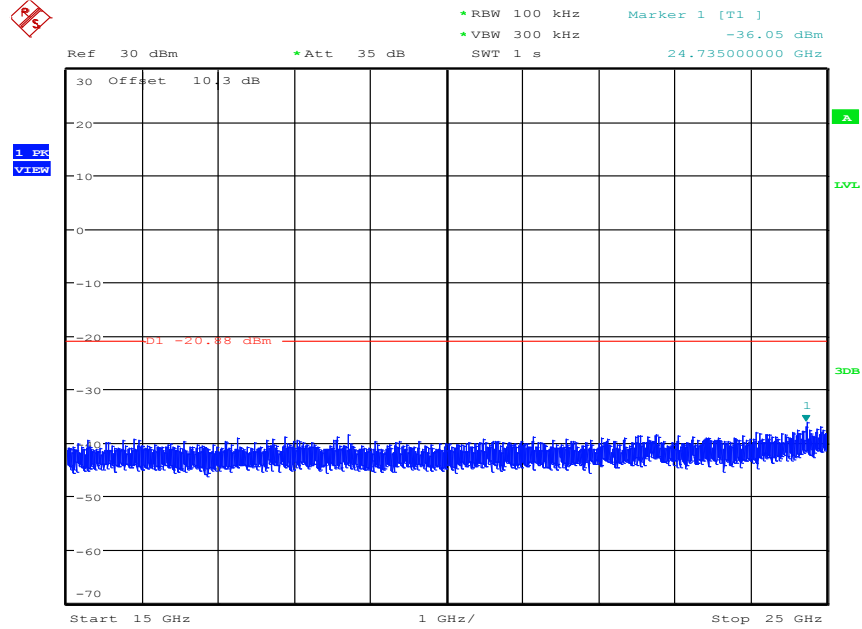

Date: 18.OCT.2018 15:41:59

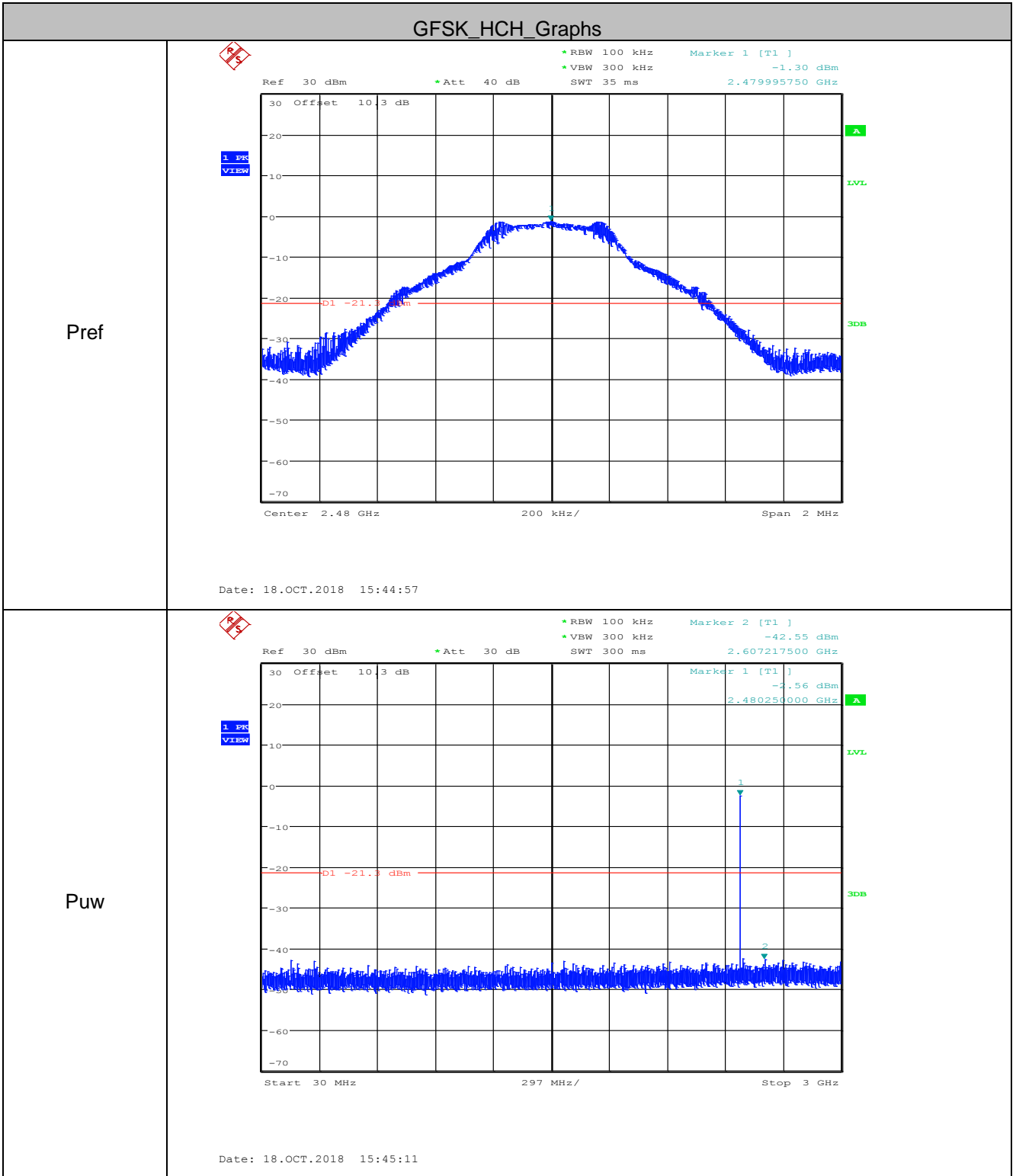

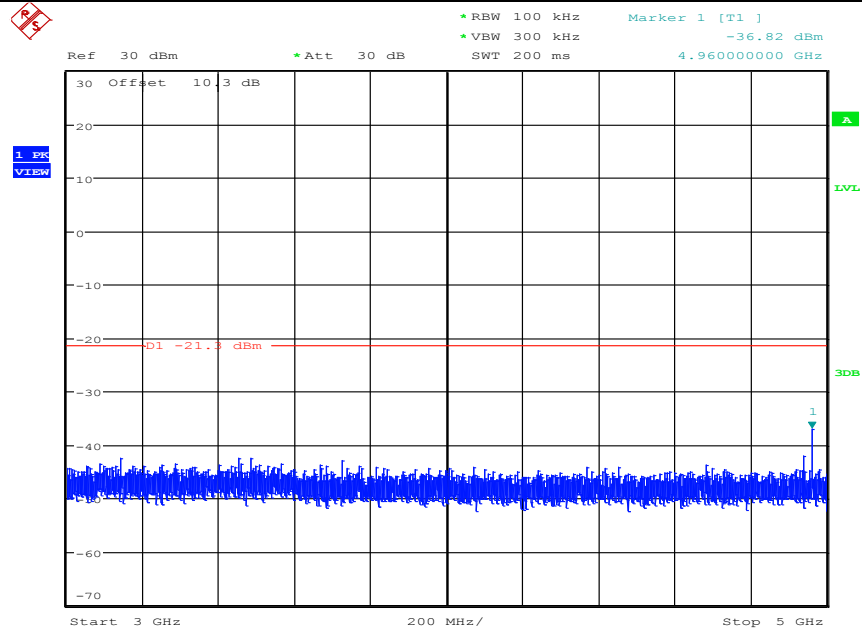

Date: 18.OCT.2018 15:45:22

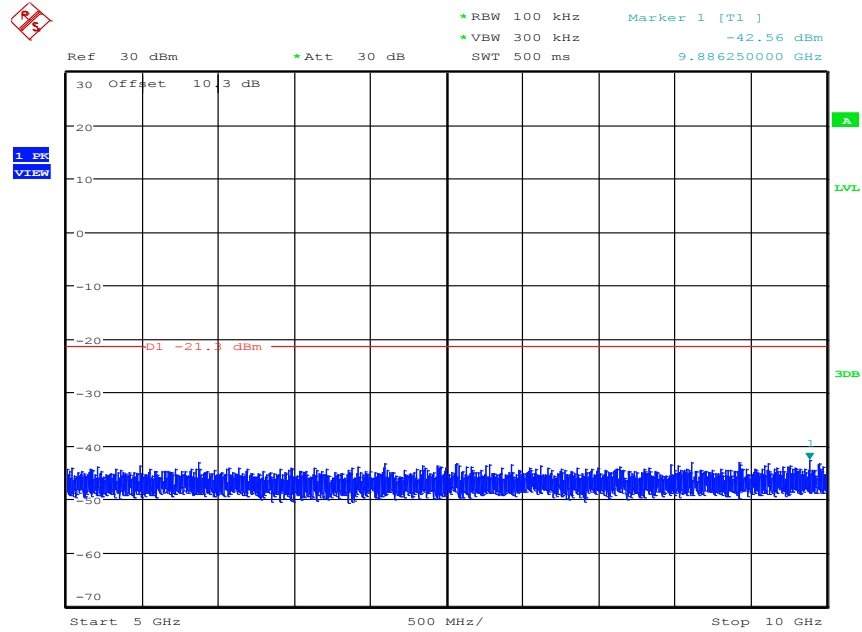

Date: 18.OCT.2018 15:45:35

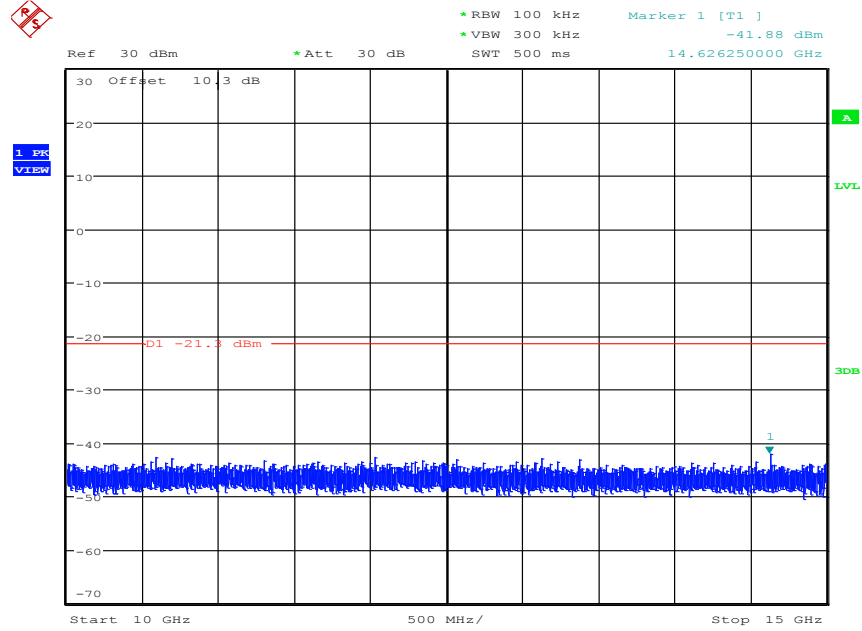

Date: 18.OCT.2018 15:45:48

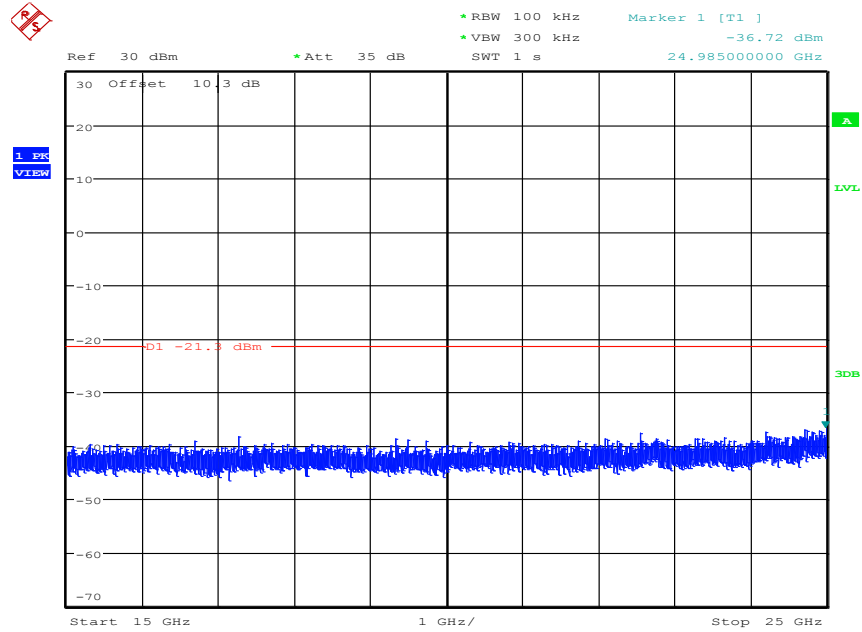

Date: 18.OCT.2018 15:46:01

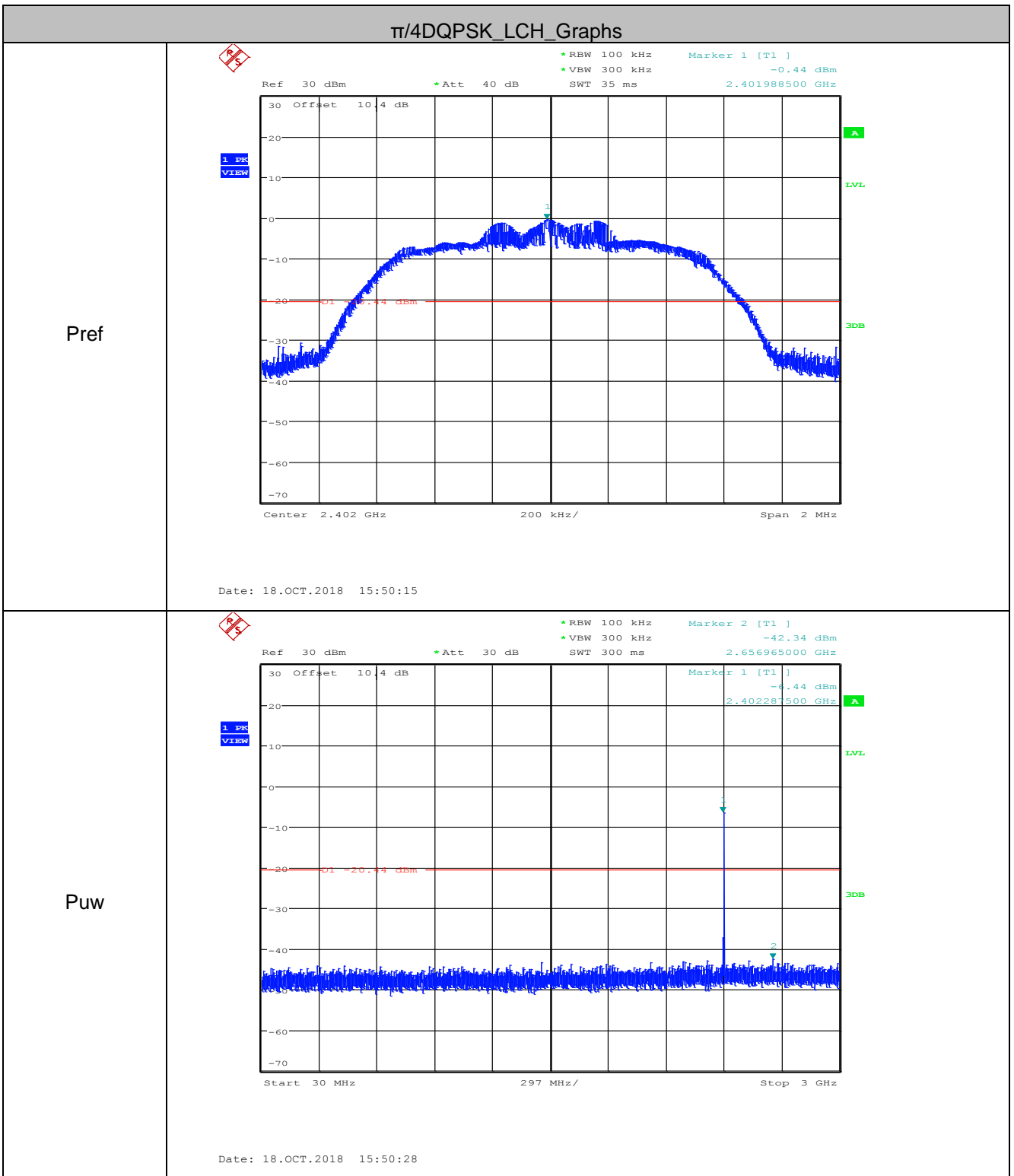

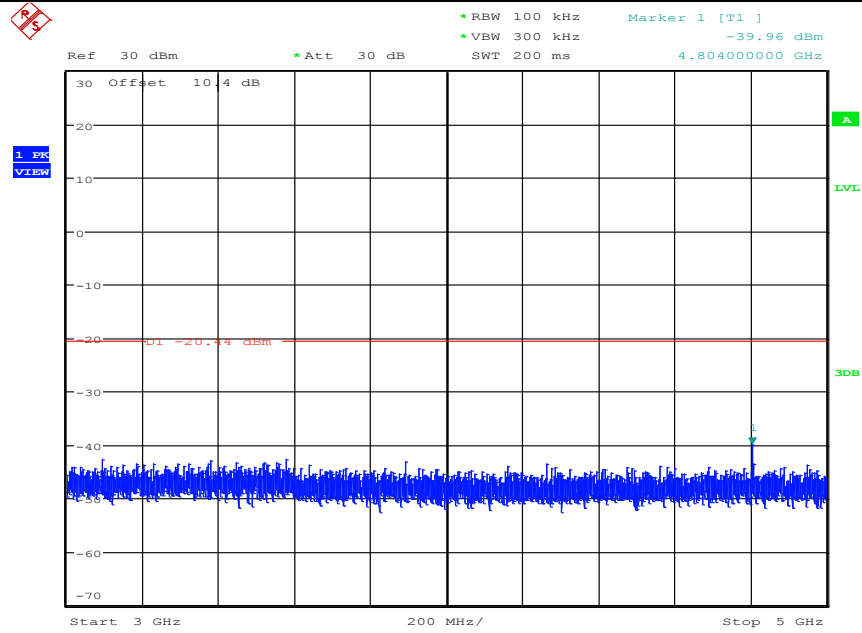

Date: 18.OCT.2018 15:50:39

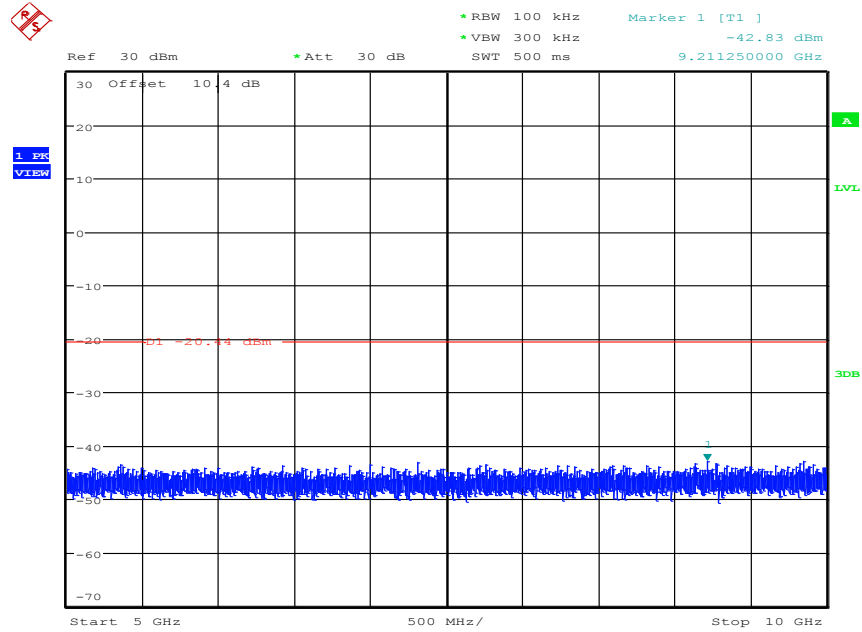

Date: 18.OCT.2018 15:50:52

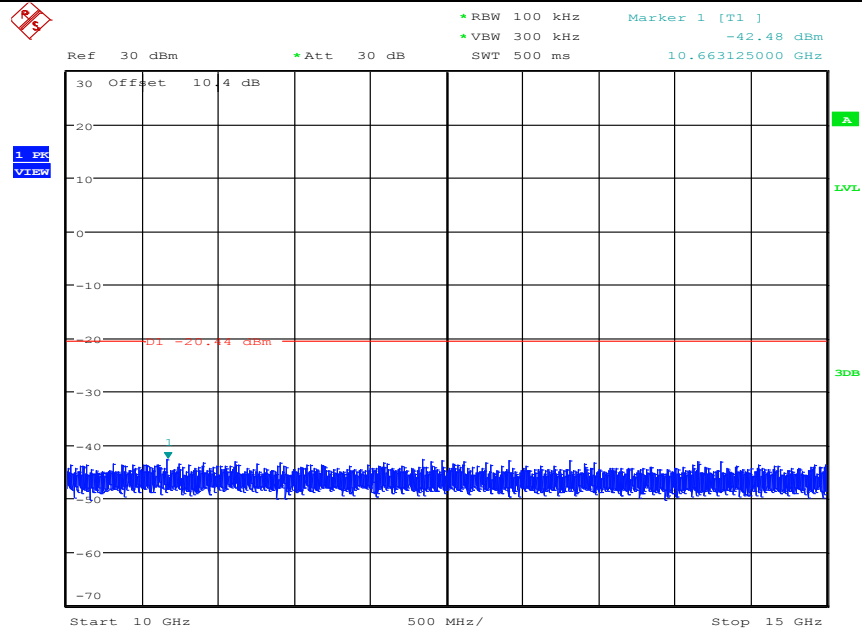

Date: 18.OCT.2018 15:51:05

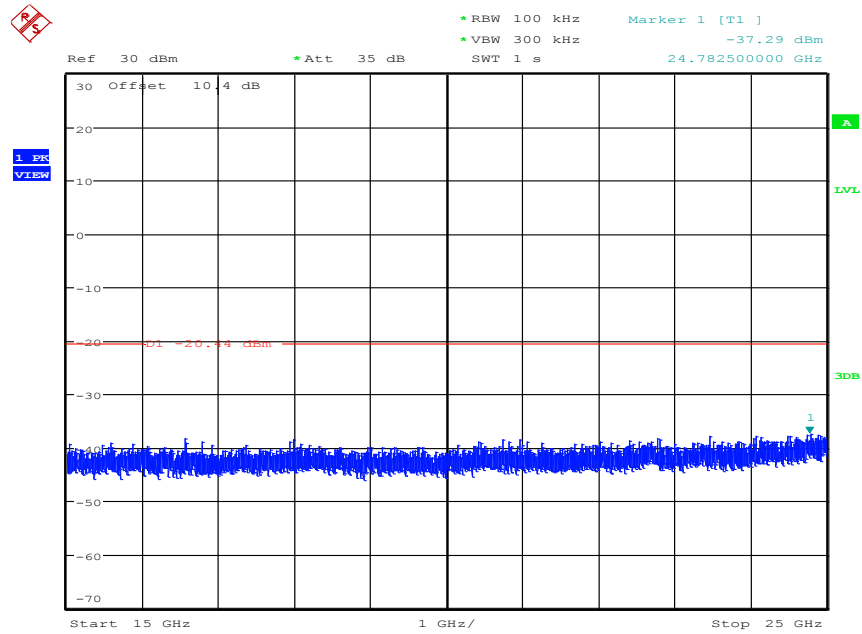

Date: 18.OCT.2018 15:51:18

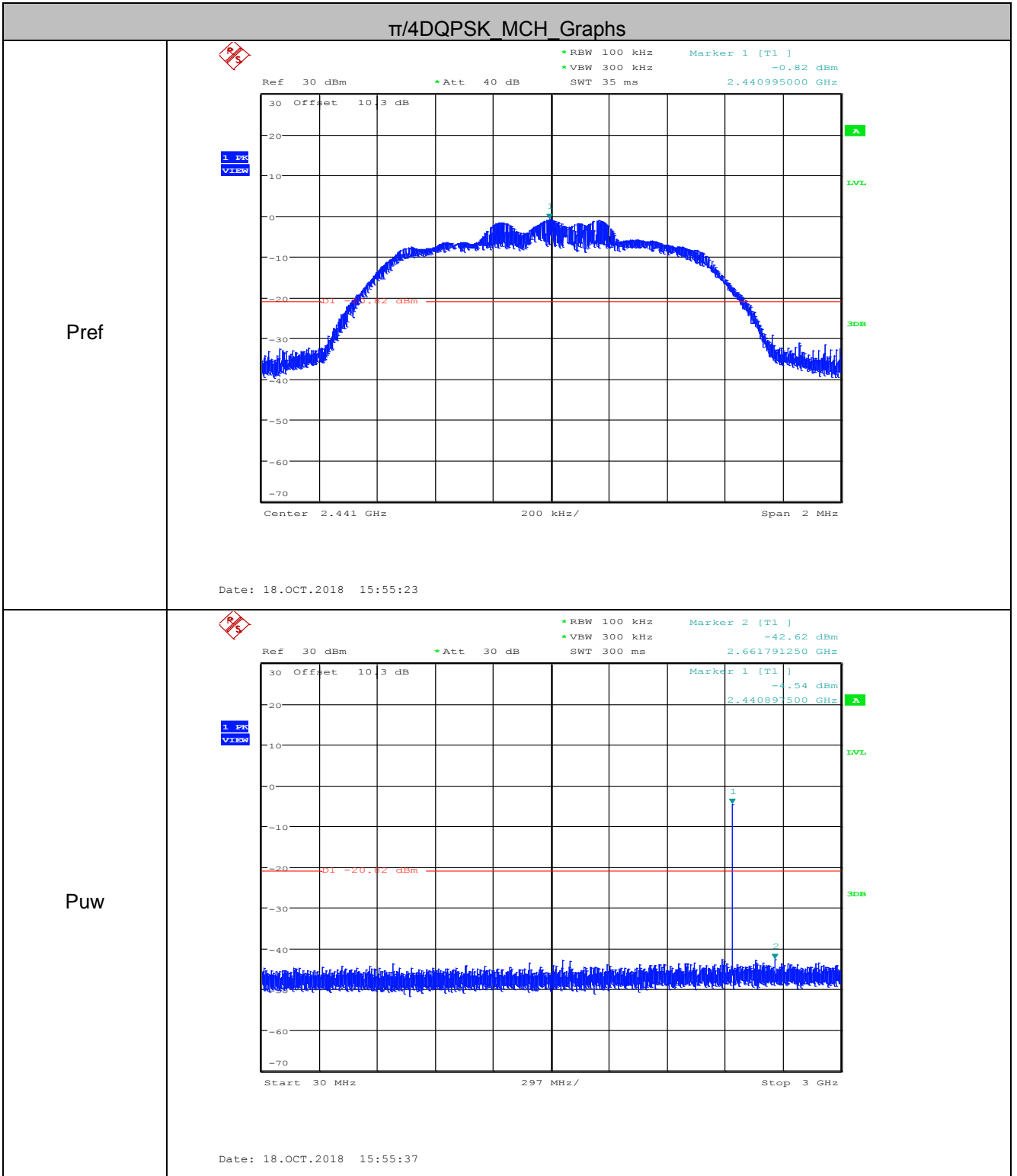

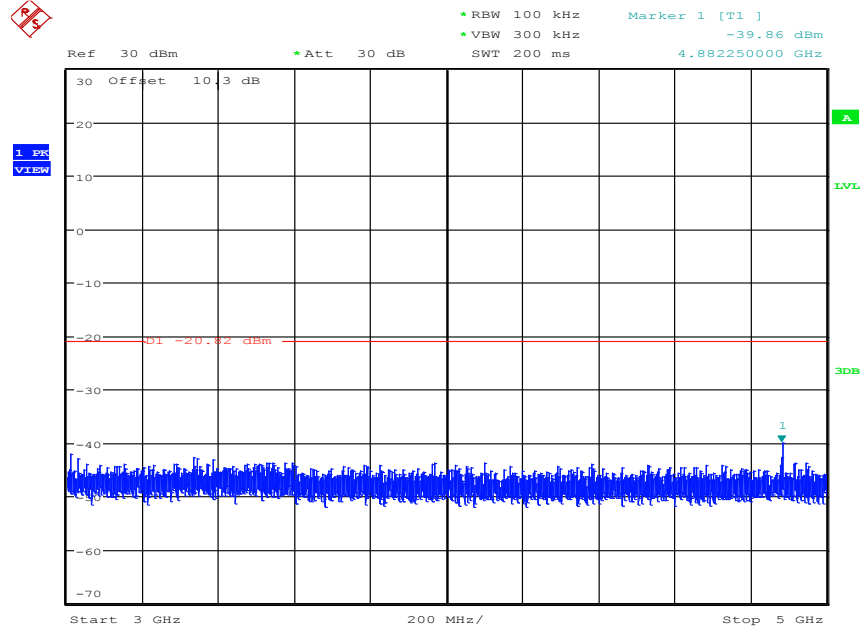

Date: 18.OCT.2018 15:55:48

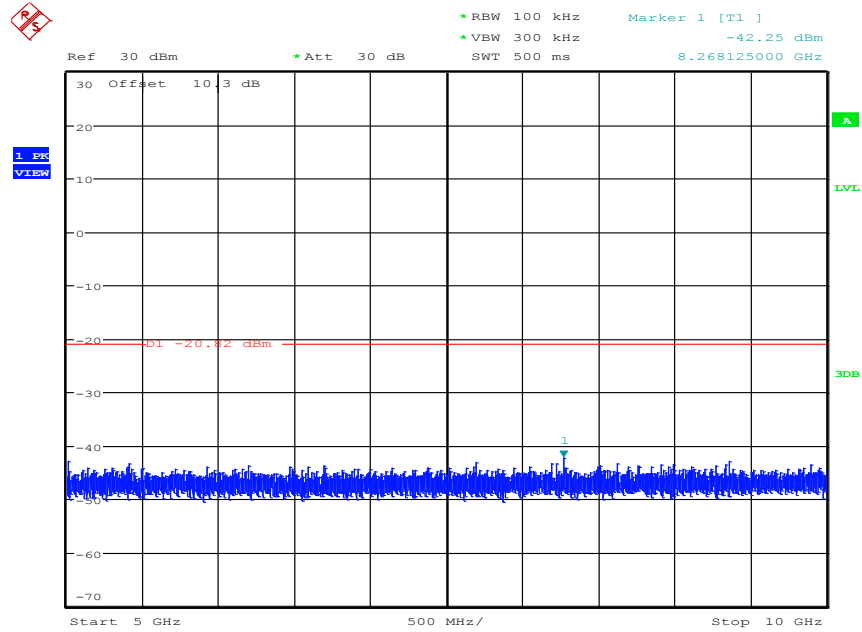

Date: 18.OCT.2018 15:56:01

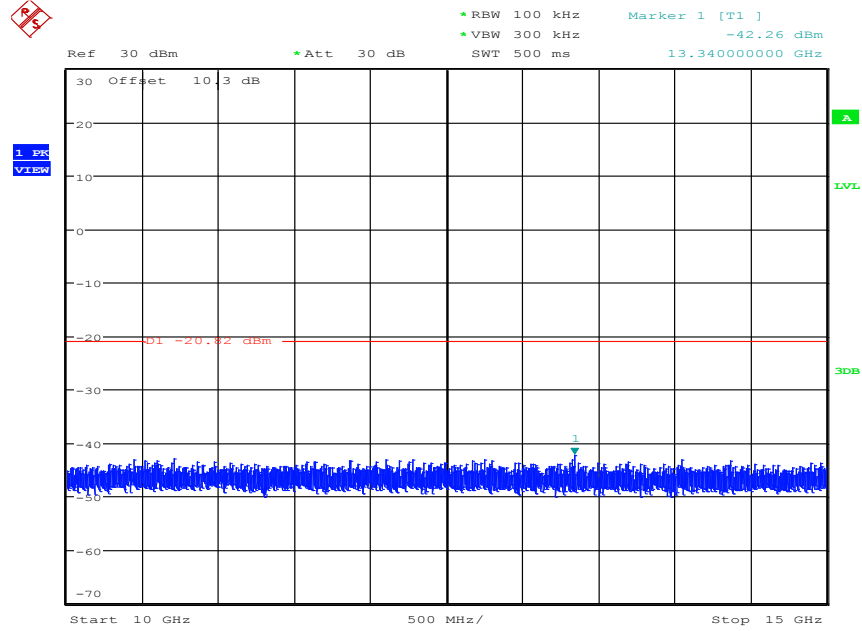

Date: 18.OCT.2018 15:56:14

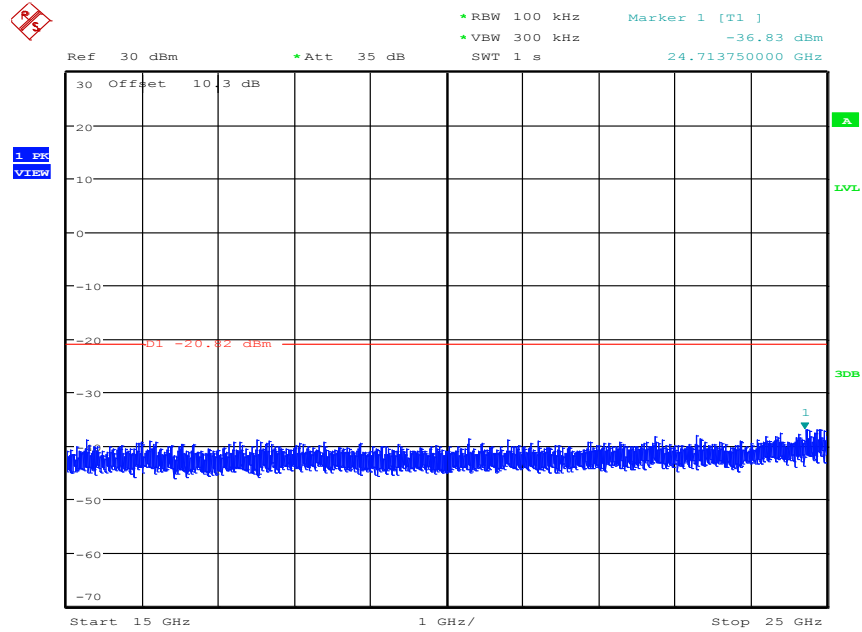

Date: 18.OCT.2018 15:56:27

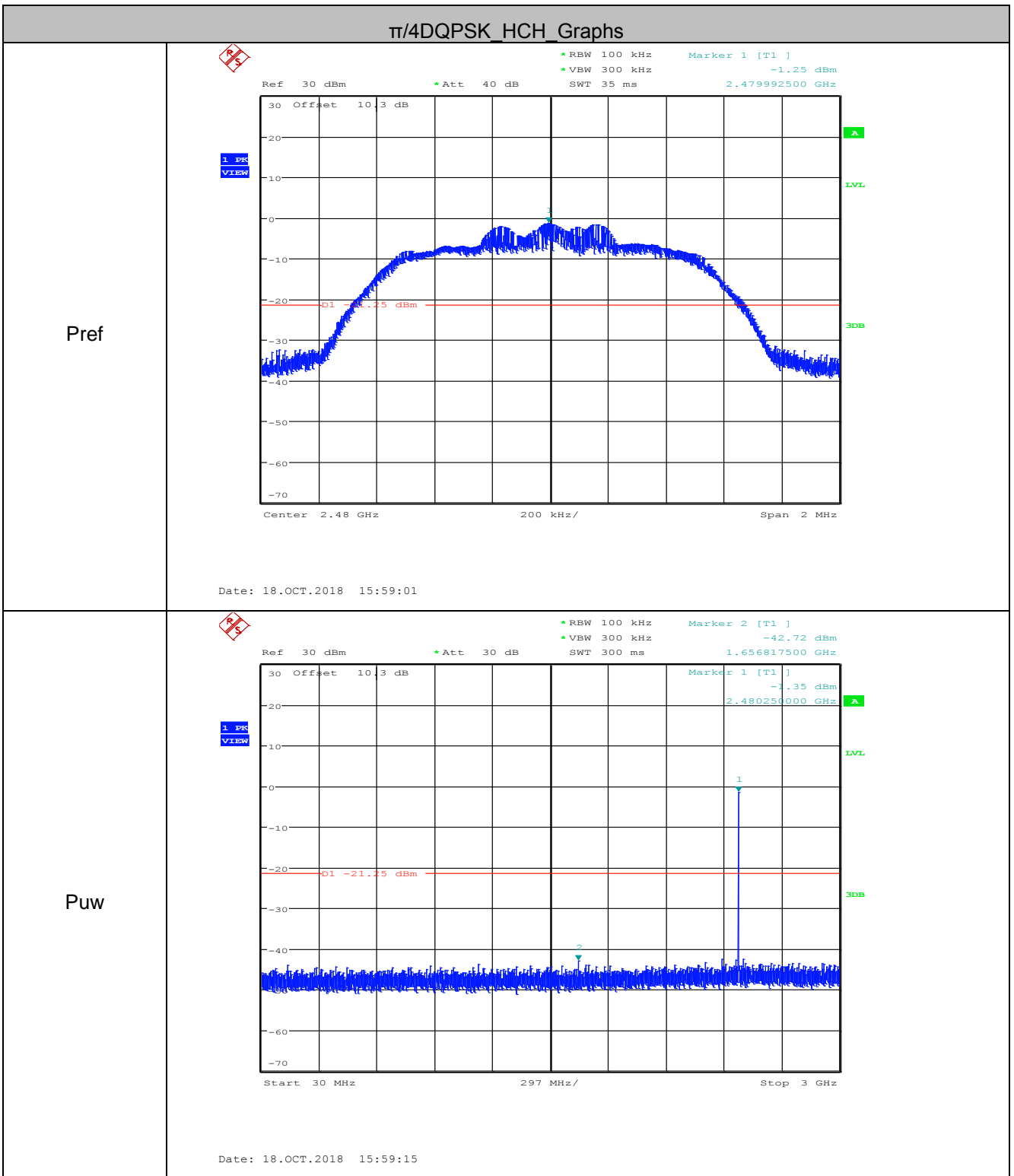

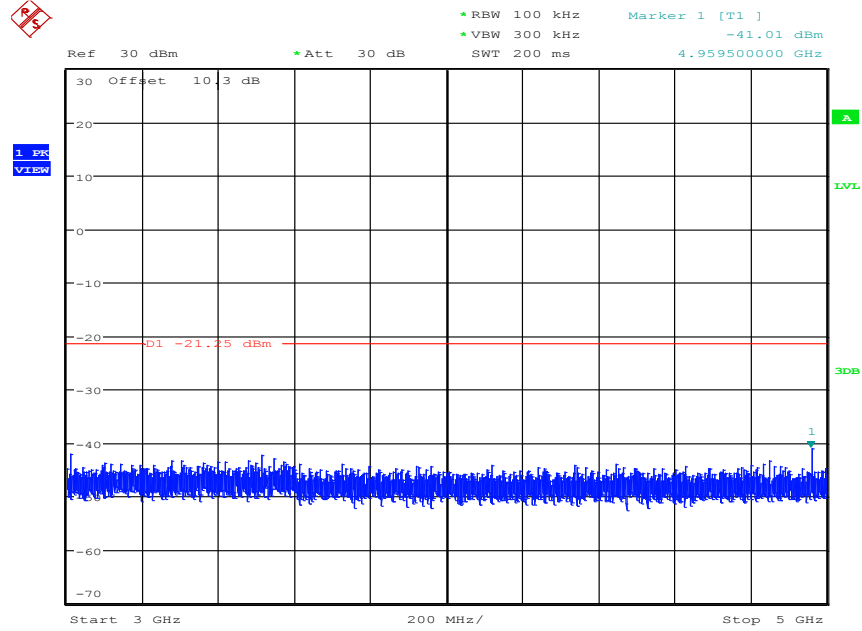

Date: 18.OCT.2018 15:59:26

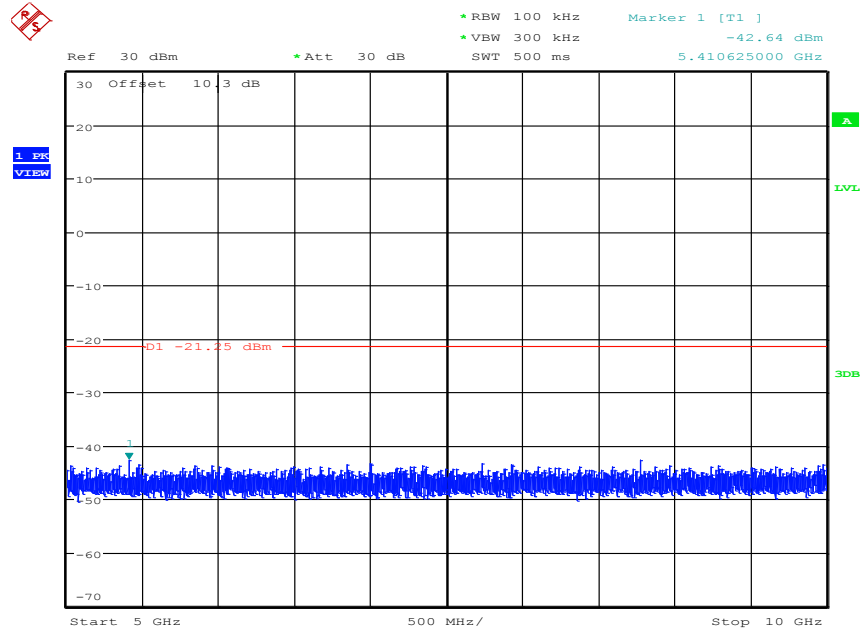

Date: 18.OCT.2018 15:59:39

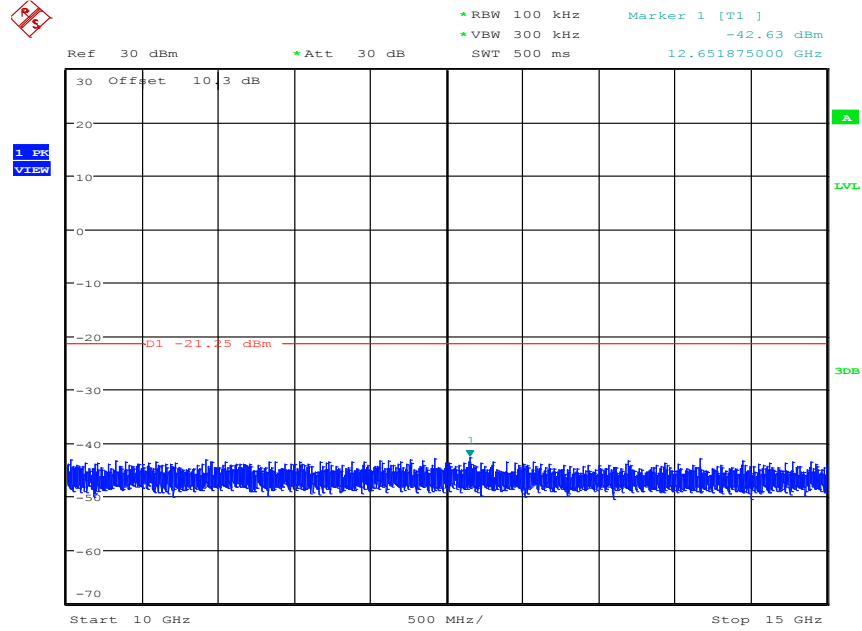

Date: 18.OCT.2018 15:59:52

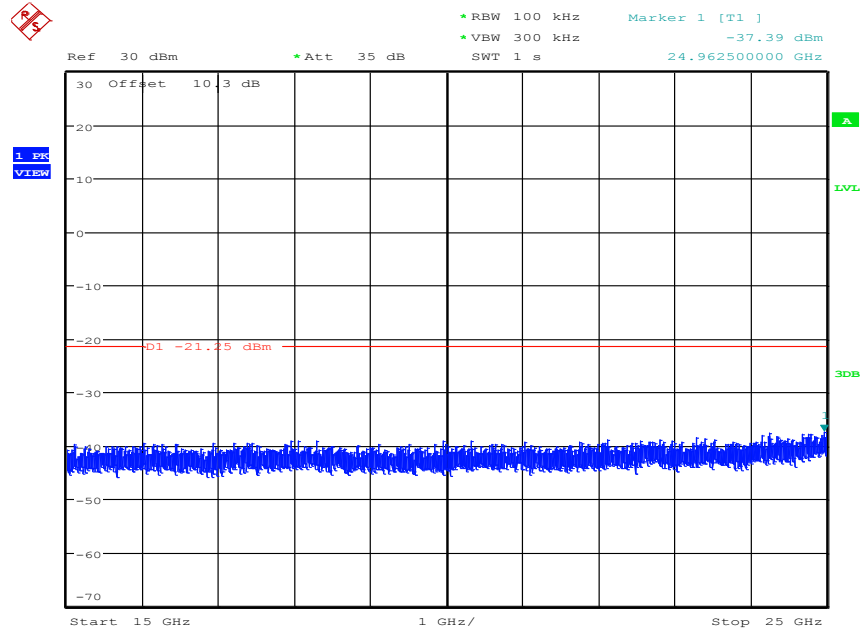

Date: 18.OCT.2018 16:00:05

8DPSK_LCH_Graphs

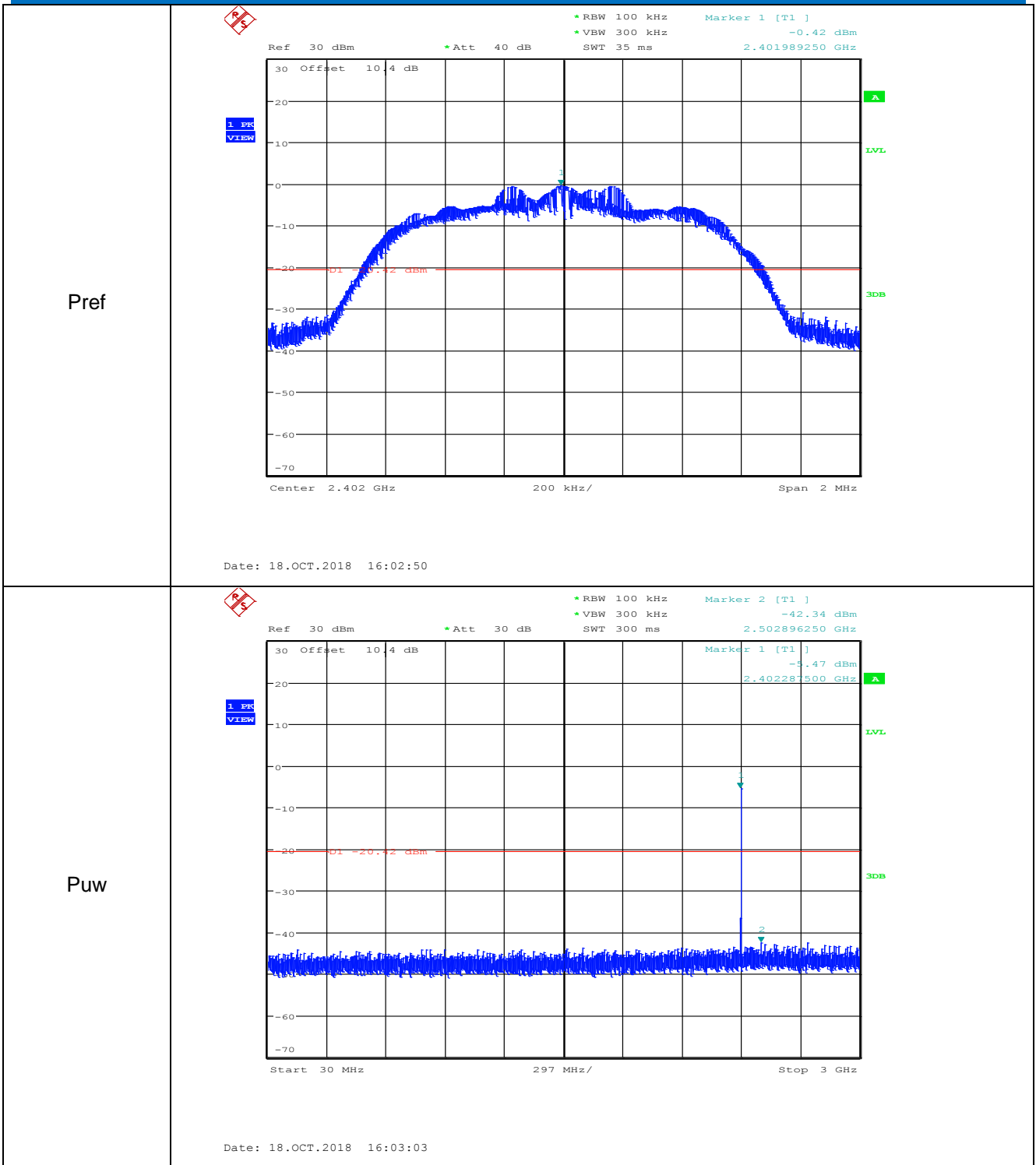

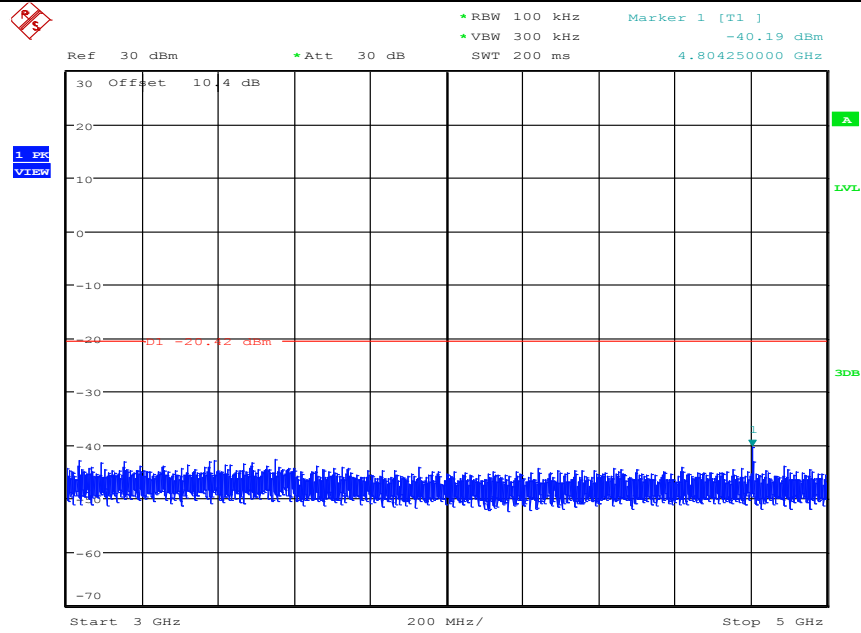

Date: 18.OCT.2018 16:03:14

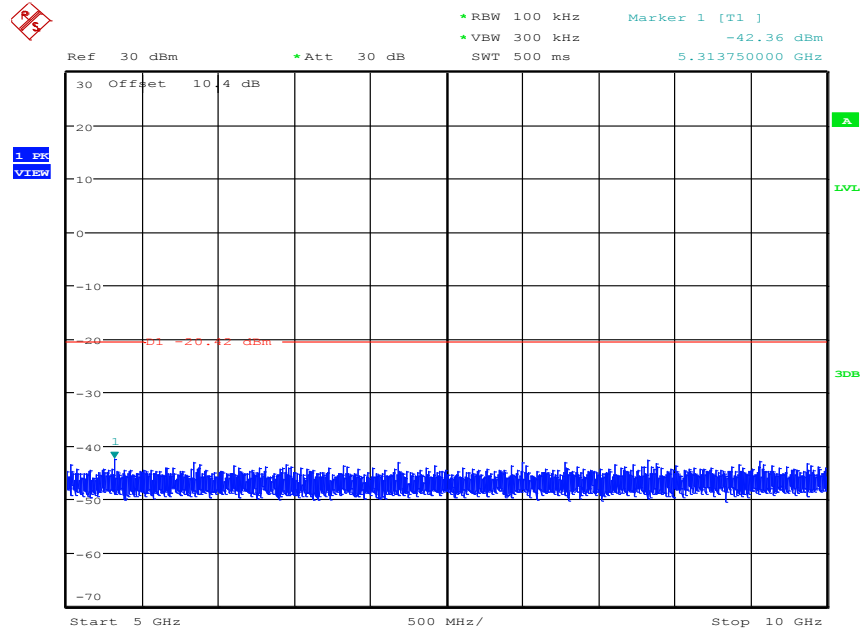

Date: 18.OCT.2018 16:03:27

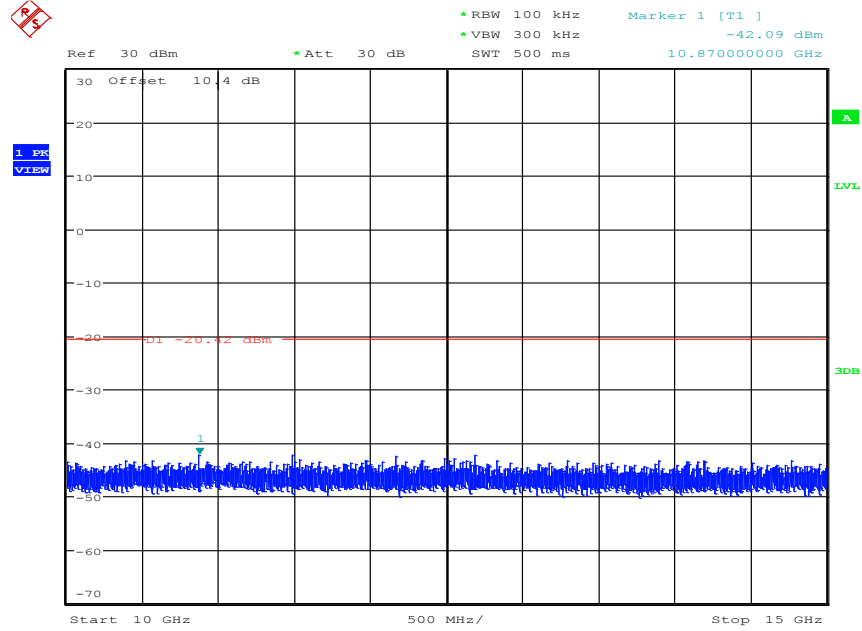

Date: 18.OCT.2018 16:03:40

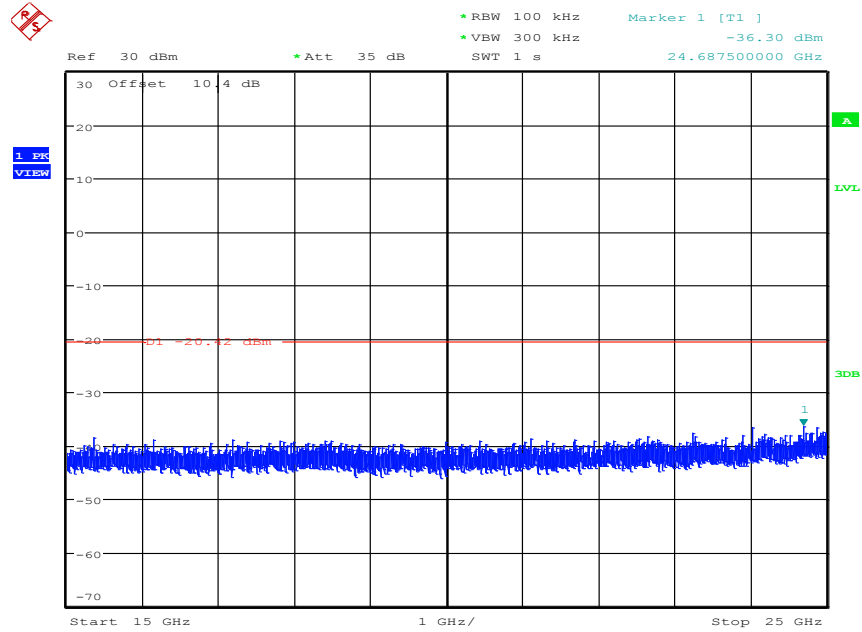

Date: 18.OCT.2018 16:03:53

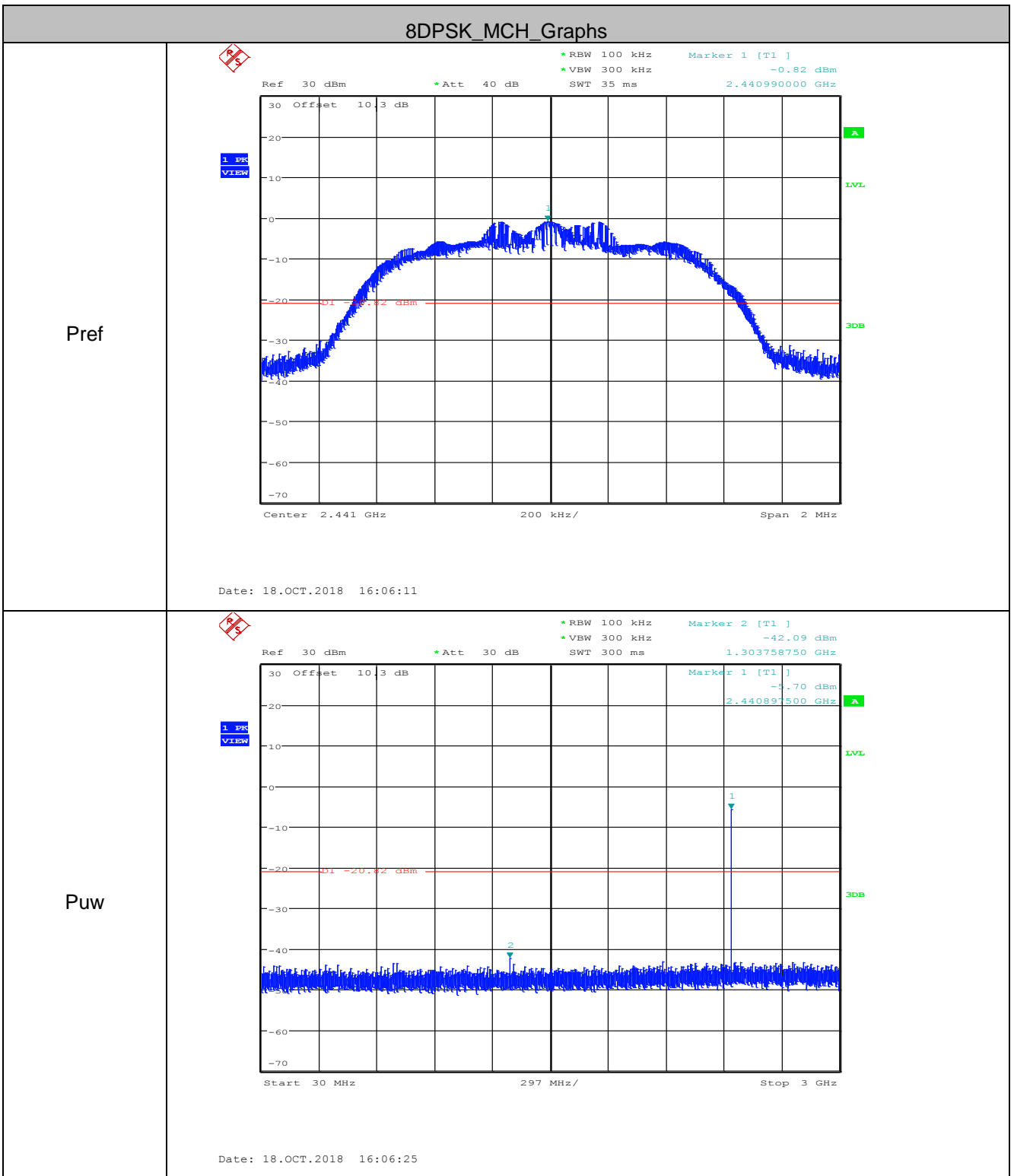

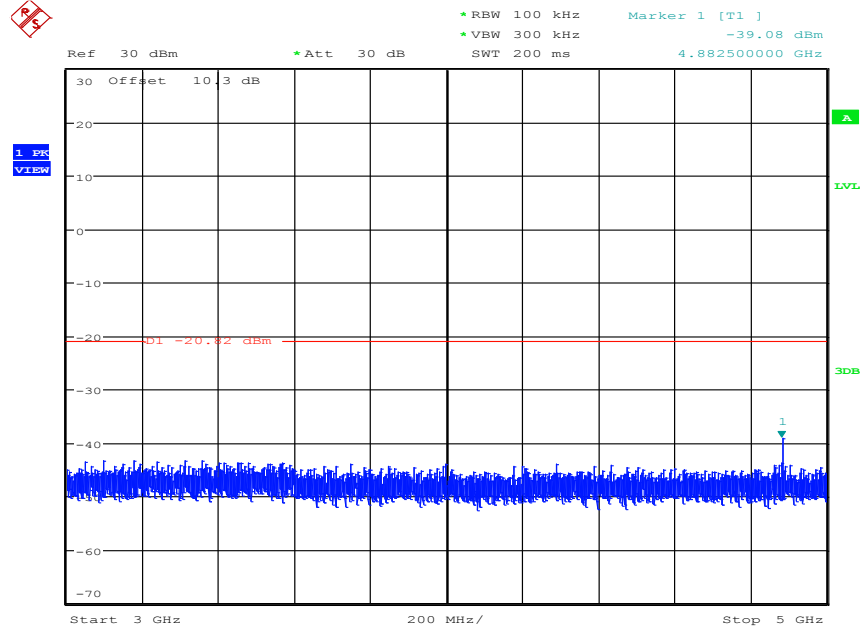

Date: 18.OCT.2018 16:06:36

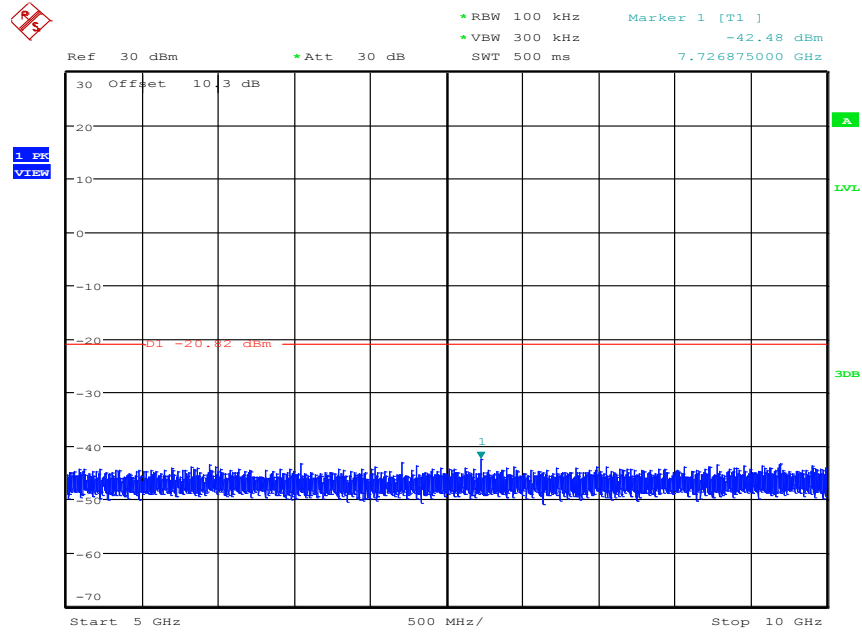

Date: 18.OCT.2018 16:06:49

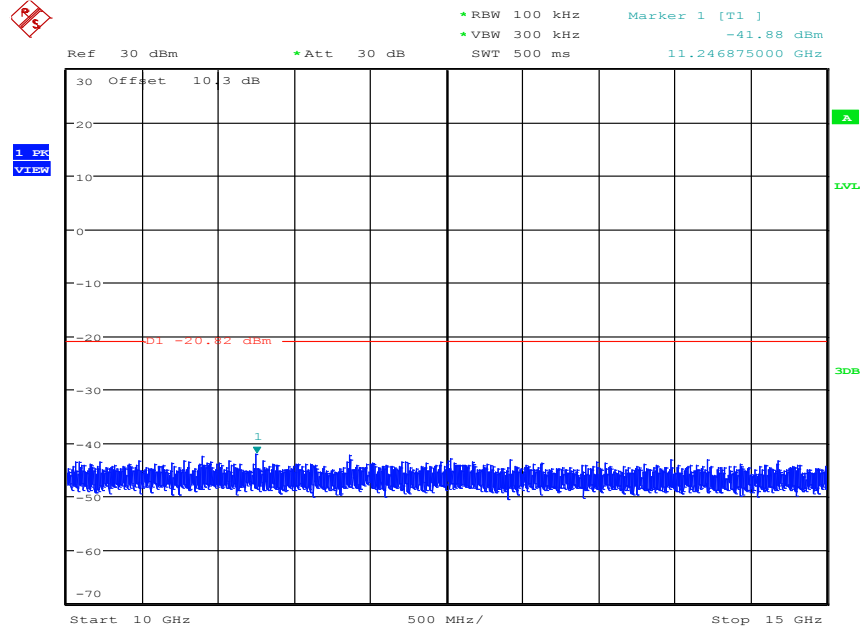

Date: 18.OCT.2018 16:07:02

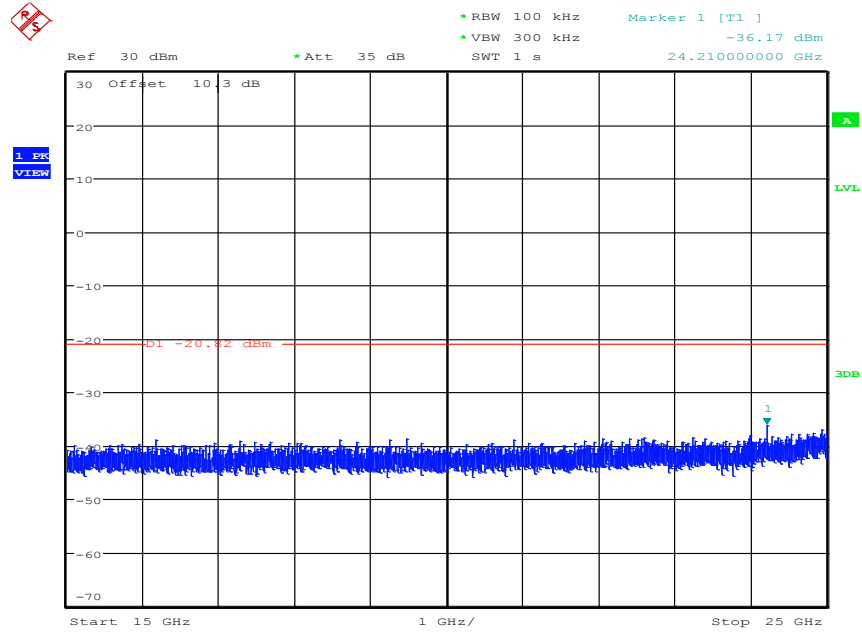

Date: 18.OCT.2018 16:07:15

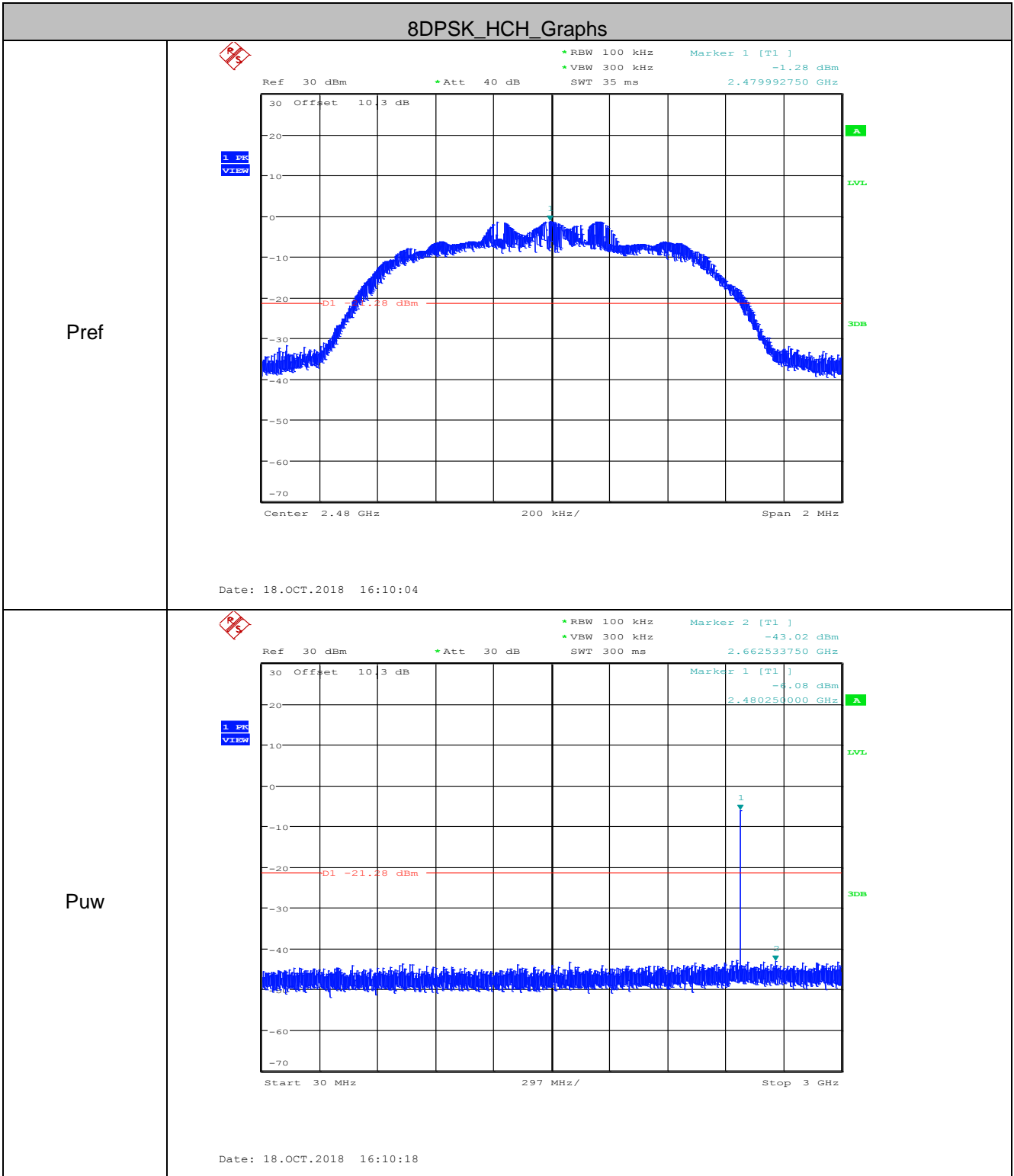

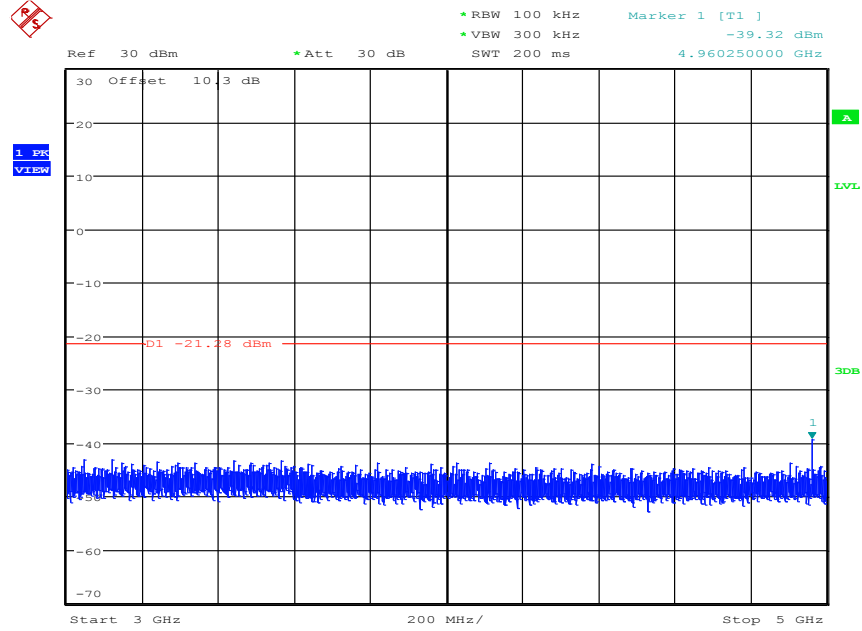

Date: 18.OCT.2018 16:10:29

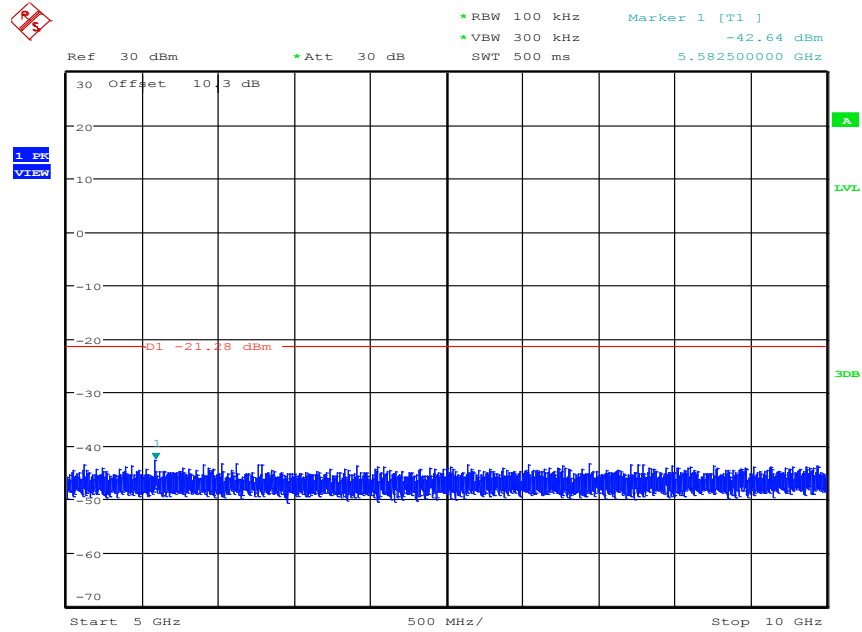

Date: 18.OCT.2018 16:10:42

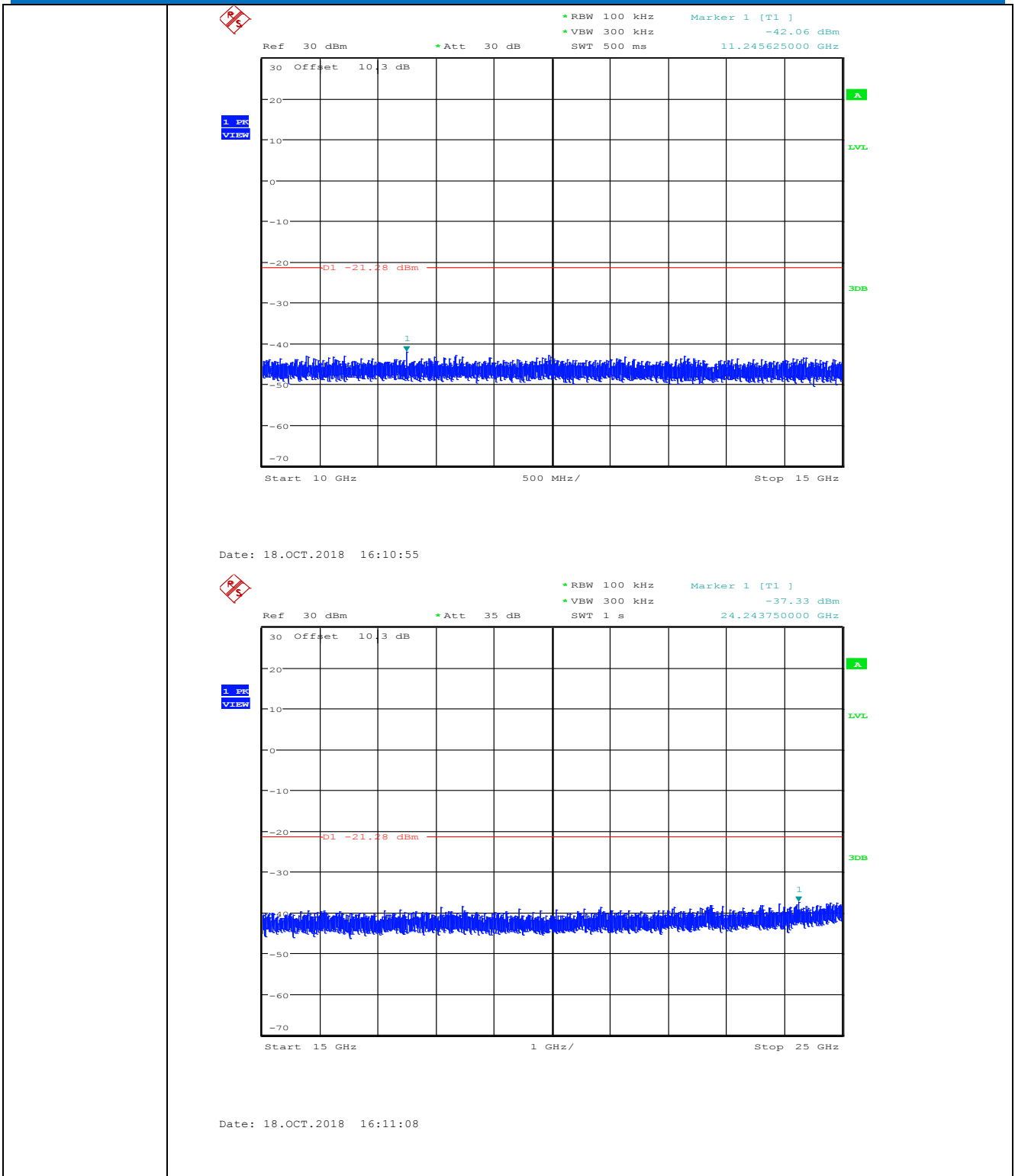

Remark:

Pre test 9kHz to 25GHz, find the highest point when testing, so only the worst data were shown in the test report. Per FCC Part 15.33 (a) and 15.31 (o), The amplitude of spurious emissions from intentional radiators which are attenuated more than 20 dB below the permissible value need not be reported unless specifically required elsewhere in this part.

5.9 Other requirements Frequency Hopping Spread Spectrum System

Test Requirement:	47 CFR Part 15C Section 15.247 (a)(1), (h) requirement:
<p>The system shall hop to channel frequencies that are selected at the system hopping rate from a Pseudorandom ordered list of hopping frequencies. Each frequency must be used equally on the average by each transmitter. The system receivers shall have input bandwidths that match the hopping channel bandwidths of their corresponding transmitters and shall shift frequencies in synchronization with the transmitted signals.</p> <p>Frequency hopping spread spectrum systems are not required to employ all available hopping channels during each transmission. However, the system, consisting of both the transmitter and the receiver, must be designed to comply with all of the regulations in this section should the transmitter be presented with a continuous data (or information) stream. In addition, a system employing short transmission bursts must comply with the definition of a frequency hopping system and must distribute its transmissions over the minimum number of hopping channels specified in this section.</p> <p>The incorporation of intelligence within a frequency hopping spread spectrum system that permits the system to recognize other users within the spectrum band so that it individually and independently chooses and adapts its hopsets to avoid hopping on occupied channels is permitted. The coordination of frequency hopping systems in any other manner for the express purpose of avoiding the simultaneous occupancy of individual hopping frequencies by multiple transmitters is not permitted.</p>	

Compliance for section 15.247(a)(1)

According to Bluetooth Core Specification, the pseudorandom sequence may be generated in a nine-stage shift register whose 5th and 9th stage outputs are added in a modulo-two addition stage. And the result is fed back to the input of the first stage. The sequence begins with the first ONE of 9 consecutive ONES; i.e. the shift register is initialized with nine ones.

- Number of shift register stages: 9
- Length of pseudo-random sequence: $2^9 - 1 = 511$ bits
- Longest sequence of zeros: 8 (non-inverted signal)

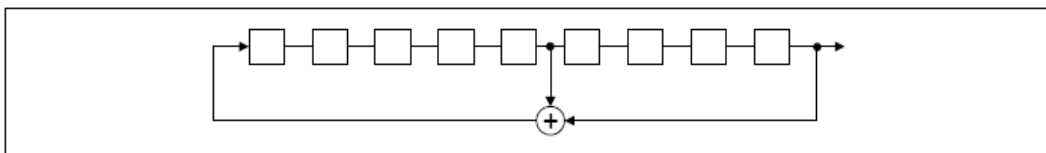

Linear Feedback Shift Register for Generation of the PRBS sequence

An example of Pseudorandom Frequency Hopping Sequence as follow:

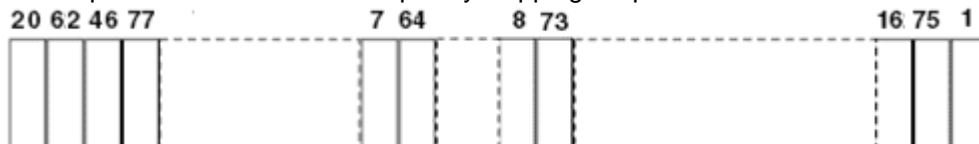

Each frequency used equally on the average by each transmitter. According to Bluetooth Core Specification, Bluetooth receivers are designed to have input and IF bandwidths that match the hopping channel bandwidths of any Bluetooth transmitters and shift frequencies in synchronization with the transmitted signals.

Compliance for section 15.247(g)

According to Bluetooth Core Specification, the Bluetooth system transmits the packet with the pseudorandom hopping frequency with a continuous data and the short burst transmission from the Bluetooth system is also transmitted under the frequency hopping system with the pseudorandom hopping frequency system.

Compliance for section 15.247(h)

According to Bluetooth Core specification, the Bluetooth system incorporates with an adaptive system to detect other user within the spectrum band so that it individually and independently to avoid hopping on the occupied channels.

According to the Bluetooth Core specification, the Bluetooth system is designed not have the ability to coordinated with other FHSS System in an effort to avoid the simultaneous occupancy of individual hopping frequencies by multiple transmitter.

5.10 Radiated Spurious Emission & Restricted bands

Test Requirement:	47 CFR Part 15C Section 15.209 and 15.205				
Test Method:	ANSI C63.10: 2013				
Test Site:	Measurement Distance: 3m (Semi-Anechoic Chamber)				
Receiver Setup:	Frequency	Detector	RBW	VBW	Remark
	0.009MHz-0.090MHz	Peak	10kHz	30kHz	Peak
	0.009MHz-0.090MHz	Average	10kHz	30kHz	Average
	0.090MHz-0.110MHz	Quasi-peak	10kHz	30kHz	Quasi-peak
	0.110MHz-0.490MHz	Peak	10kHz	30kHz	Peak
	0.110MHz-0.490MHz	Average	10kHz	30kHz	Average
	0.490MHz -30MHz	Quasi-peak	10kHz	30kHz	Quasi-peak
	30MHz-1GHz	Peak	100 kHz	300kHz	Peak
	Above 1GHz	Peak	1MHz	3MHz	Peak
Peak		1MHz	10Hz	Average	
Limit:	Frequency	Field strength (microvolt/meter)	Limit (dBuV/m)	Remark	Measurement distance (m)
	0.009MHz-0.490MHz	2400/F(kHz)	-	-	300
	0.490MHz-1.705MHz	24000/F(kHz)	-	-	30
	1.705MHz-30MHz	30	-	-	30
	30MHz-88MHz	100	40.0	Quasi-peak	3
	88MHz-216MHz	150	43.5	Quasi-peak	3
	216MHz-960MHz	200	46.0	Quasi-peak	3
	960MHz-1GHz	500	54.0	Quasi-peak	3
	Above 1GHz	500	54.0	Average	3
<p>Note: 15.35(b), Unless otherwise specified, the limit on peak radio frequency emissions is 20dB above the maximum permitted average emission limit applicable to the equipment under test. This peak limit applies to the total peak emission level radiated by the device.</p>					

Test Setup:

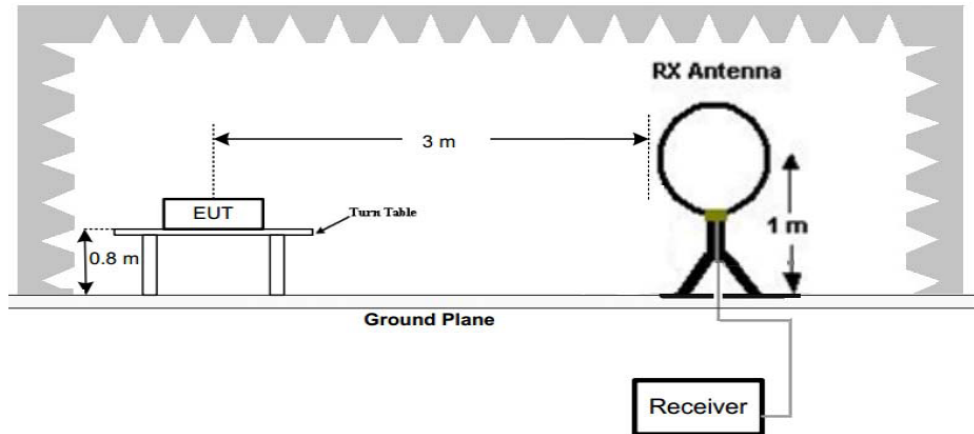

Figure 1. Below 30MHz

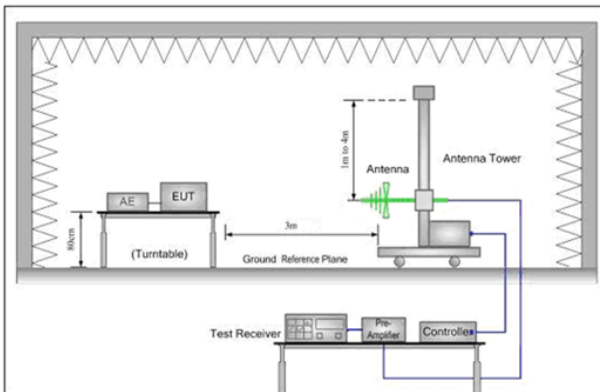

Figure 2. 30MHz to 1GHz

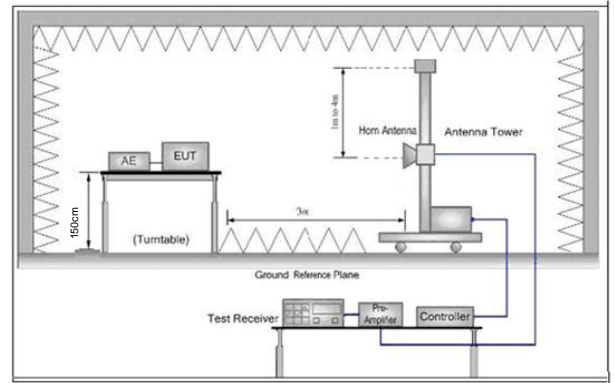

Figure 3. Above 1 GHz

Test Procedure:

- a. 1) Below 1G: The EUT was placed on the top of a rotating table 0.8 meters above the ground at a 3 meter semi-anechoic chamber. The table was rotated 360 degrees to determine the position of the highest radiation.
- 2) Above 1G: The EUT was placed on the top of a rotating table 1.5 meters above the ground at a 3 meter semi-anechoic chamber. The table was rotated 360 degrees to determine the position of the highest radiation.
- Note: For the radiated emission test above 1GHz:
Place the measurement antenna away from each area of the EUT determined to be a source of emissions at the specified measurement distance, while keeping the measurement antenna aimed at the source of emissions at each frequency of significant emissions, with polarization oriented for maximum response. The measurement antenna may have to be higher or lower than the EUT, depending on the radiation pattern of the emission and staying aimed at the emission source for receiving the maximum signal. The final measurement antenna elevation shall be that which maximizes the emissions. The measurement antenna elevation for maximum emissions shall be restricted to a range of heights of from 1 m to 4 m above the ground or reference ground plane.
- b. The EUT was set 3 meters away from the interference-receiving antenna, which was mounted on the top of a variable-height antenna tower.
- c. The antenna height is varied from one meter to four meters above the ground to determine the maximum value of the field strength. Both horizontal and vertical polarizations of the antenna are set to make the measurement.

	<p>d. For each suspected emission, the EUT was arranged to its worst case and then the antenna was tuned to heights from 1 meter to 4 meters (for the test frequency of below 30MHz, the antenna was tuned to heights 1 meter) and the rotatable table was turned from 0 degrees to 360 degrees to find the maximum reading.</p> <p>e. The test-receiver system was set to Peak Detect Function and Specified Bandwidth with Maximum Hold Mode.</p> <p>f. If the emission level of the EUT in peak mode was 10dB lower than the limit specified, then testing could be stopped and the peak values of the EUT would be reported. Otherwise the emissions that did not have 10dB margin would be re-tested one by one using peak, quasi-peak or average method as specified and then reported in a data sheet.</p> <p>g. Test the EUT in the lowest channel (2402MHz),the middle channel (2441MHz),the Highest channel (2480MHz)</p> <p>h. The radiation measurements are performed in X, Y, Z axis positioning for Transmitting mode, and found the X axis positioning which it is the worst case.</p> <p>i. Repeat above procedures until all frequencies measured was complete.</p>
<p>Exploratory Test Mode:</p>	<p>Non-hopping transmitting mode with all kind of modulation and all kind of data type Transmitting mode</p>
<p>Final Test Mode:</p>	<p>Through Pre-scan, find the DH5 of data type and 8DPSK modulation is the worst case. Pretest the EUT at Transmitting mode which it is worse case For below 1GHz part, through pre-scan, the worst case is the lowest channel. Only the worst case is recorded in the report.</p>
<p>Test Results:</p>	<p>Pass</p>

5.10.1 Radiated Emission below 1GHz

30MHz~1GHz (PEAK)		
Test mode:	Transmitting	Vertical

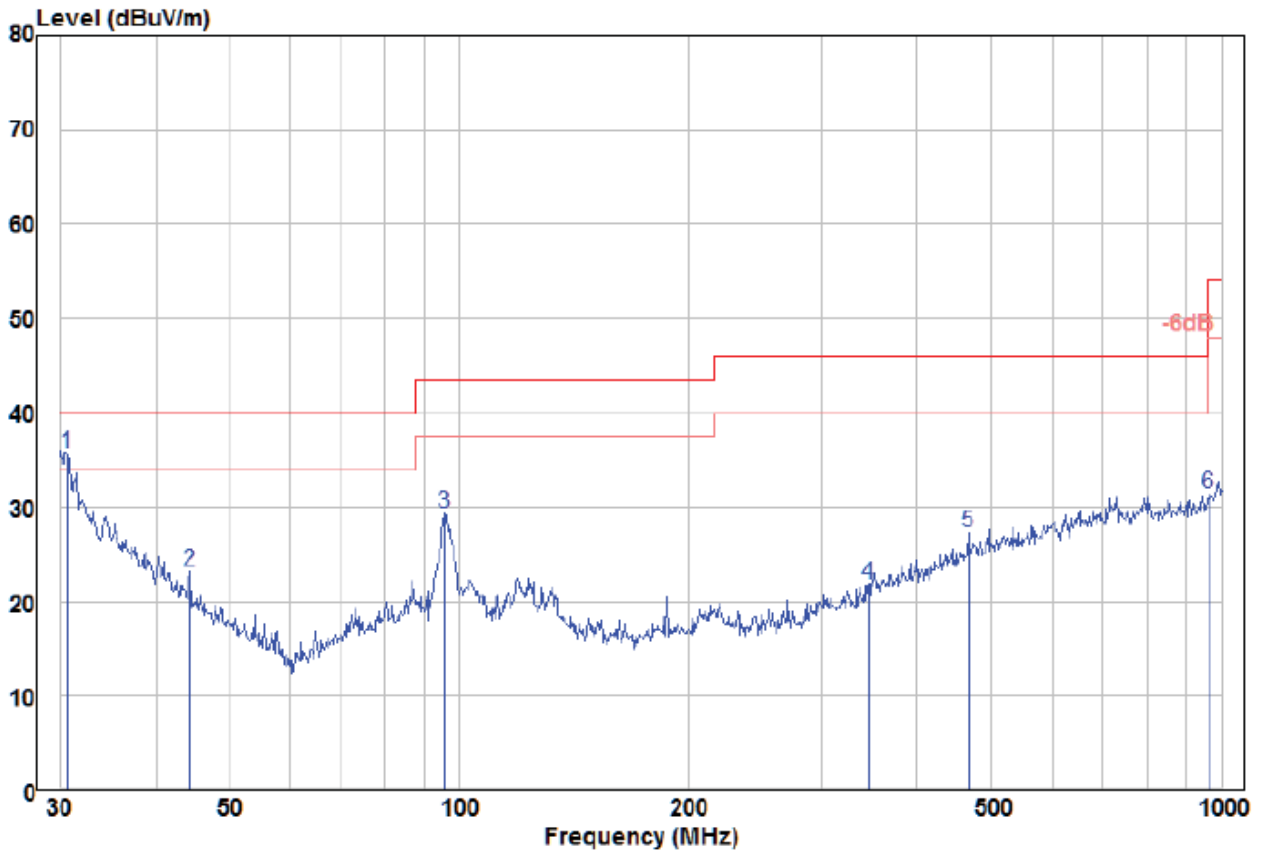

	Read Freq	Read Level	Ant Factor	Cable Loss	Cable Factor	Level	Limit Line	Over Limit	Remark	Pol/Phase
	MHz	dBuV	dB/m	dB	dB/m	dBuV/m	dBuV/m	dB		
1 pp	30.64	16.79	18.55	0.31	18.86	35.65	40.00	-4.35	Peak	VERTICAL
2	44.43	11.00	11.95	0.30	12.25	23.25	40.00	-16.75	Peak	VERTICAL
3	95.76	19.00	9.93	0.44	10.37	29.37	43.50	-14.13	Peak	VERTICAL
4	344.39	8.79	12.19	0.89	13.08	21.87	46.00	-24.13	Peak	VERTICAL
5	465.60	11.16	15.04	1.11	16.15	27.31	46.00	-18.69	Peak	VERTICAL
6	962.16	9.59	20.06	1.70	21.76	31.35	54.00	-22.65	Peak	VERTICAL

Remark:

The field strength is calculated by adding the Antenna Factor, Cable Factor & Preamplifier. The basic equation with a sample calculation is as follows:

Factor= Antenna Factor + Cable Factor – Preamplifier Factor,

Level = Read Level + Factor,

Over Limit=Level-Limit Line.

Test mode:	Transmitting	Horizontal
------------	--------------	------------

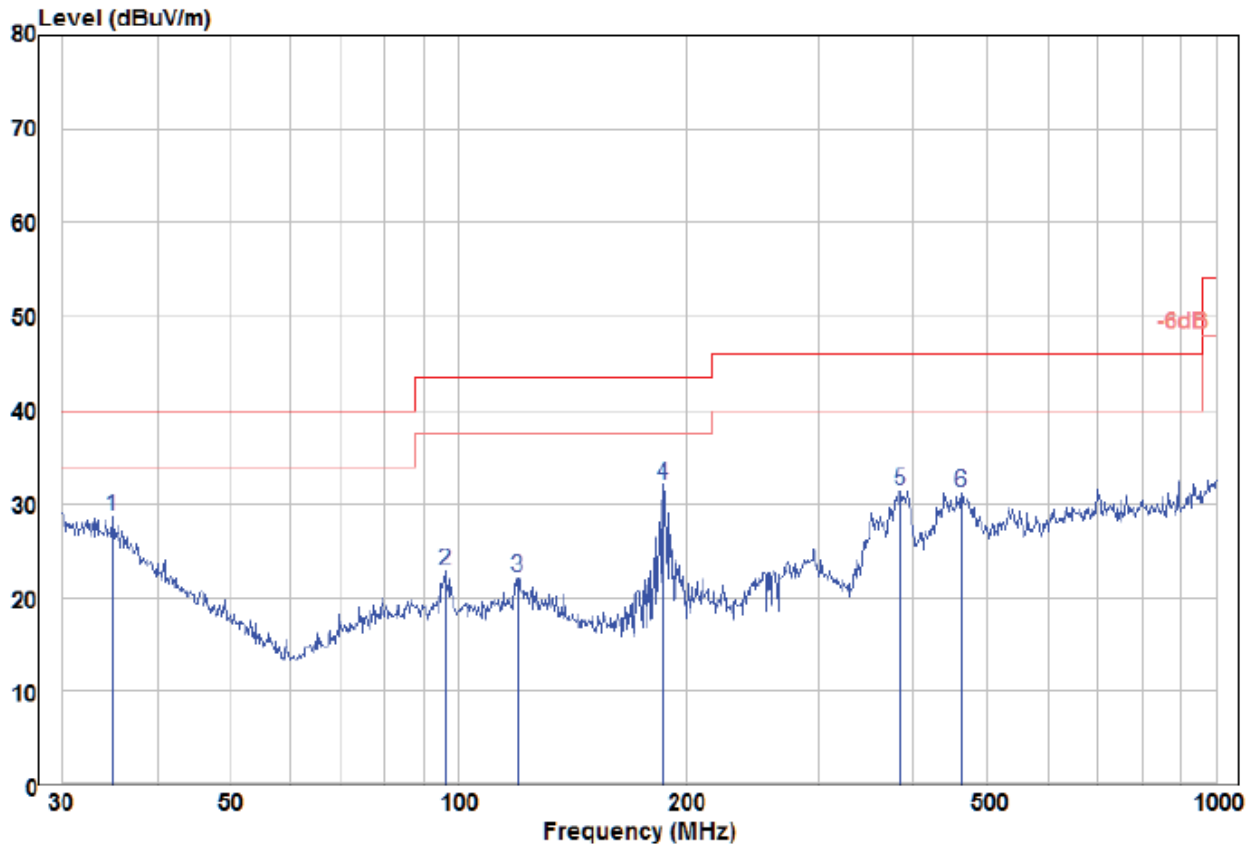

	Read	Ant	Cable		Limit	Over				
Freq	Level	Factor	Loss	Factor	Level	Line	Limit	Remark	Pol/Phase	
MHz	dBuV	dB/m	dB	dB/m	dBuV/m	dBuV/m	dB			
1 pp	35.00	10.22	18.20	0.30	18.50	28.72	40.00	-11.28	Peak	HORIZONTAL
2	96.10	12.51	9.94	0.44	10.38	22.89	43.50	-20.61	Peak	HORIZONTAL
3	119.86	11.48	10.19	0.50	10.69	22.17	43.50	-21.33	Peak	HORIZONTAL
4	186.44	23.95	7.48	0.66	8.14	32.09	43.50	-11.41	Peak	HORIZONTAL
5	383.93	17.55	12.97	0.93	13.90	31.45	46.00	-14.55	Peak	HORIZONTAL
6	462.35	15.14	14.95	1.10	16.05	31.19	46.00	-14.81	Peak	HORIZONTAL

Remark:

The field strength is calculated by adding the Antenna Factor, Cable Factor & Pre-amplifier. The basic equation with a sample calculation is as follows:

Factor= Antenna Factor + Cable Factor – Pre-amplifier Factor,

Level = Read Level + Factor,

Over Limit=Level-Limit Line.

5.10.2 Transmitter Emission above 1GHz

Worse case mode:		8DPSK (DH5)		Test channel:		Lowest	
Frequency	Meter Reading	Factor	Emission Level	Limits	Over	Detector Type	Ant. Pol.
(MHz)	(dB μ V)	(dB)	(dB μ V/m)	(dB μ V/m)	(dB)		H/V
2390	53.33	-9.2	44.13	74	-29.87	Peak	H
2400	54.53	-9.39	45.14	74	-28.86	Peak	H
4804	53.09	-4.33	48.76	74	-25.24	Peak	H
7206	49.88	1.01	50.89	74	-23.11	Peak	H
2390	54.85	-9.2	45.65	74	-28.35	Peak	V
2400	51.35	-9.39	41.96	74	-32.04	Peak	V
4804	53.55	-4.33	49.22	74	-24.78	Peak	V
7206	50.24	1.01	51.25	74	-22.75	Peak	V

Worse case mode:		8DPSK (DH5)		Test channel:		Middle	
Frequency	Meter Reading	Factor	Emission Level	Limits	Over	Detector Type	Ant. Pol.
(MHz)	(dB μ V)	(dB)	(dB μ V/m)	(dB μ V/m)	(dB)		H/V
4882	52.01	-4.11	47.90	74	-26.10	peak	H
7323	48.56	1.51	50.07	74	-23.93	peak	H
4882	51.60	-4.11	47.49	74	-26.51	peak	V
7323	49.60	1.51	51.11	74	-22.89	peak	V

Worse case mode:		8DPSK (DH5)		Test channel:		Highest	
Frequency	Meter Reading	Factor	Emission Level	Limits	Over	Detector Type	Ant. Pol.
(MHz)	(dB μ V)	(dB)	(dB μ V/m)	(dB μ V/m)	(dB)		H/V
2483.5	55.58	-9.29	46.29	74	-27.71	Peak	H
4960	51.79	-4.04	47.75	74	-26.25	Peak	H
7440	49.21	1.57	50.78	74	-23.22	Peak	H
2483.5	57.74	-9.29	48.45	74	-25.55	Peak	V
4960	50.08	-4.04	46.04	74	-27.96	Peak	V
7440	50.19	1.57	51.76	74	-22.24	Peak	V

Remark:

- The field strength is calculated by adding the Antenna Factor, Cable Factor & Preamplifier. The basic equation with a sample calculation is as follows:
Final Test Level = Receiver Reading + Antenna Factor + Cable Factor – Preamplifier Factor
- Scan from 9kHz to 25GHz, the disturbance above 10GHz and below 30MHz was very low. As shown in this section, for frequencies above 1GHz, the field strength limits are based on average limits. However, the peak field strength of any emission shall not exceed the maximum permitted average limits specified above by more than 20 dB under any condition of modulation. So, only the peak measurements were shown in the report.

6 Photographs - EUT Test Setup

6.1 Radiated Emission

9KHz~30MHz



30MHz~1GHz:



Above 1GHz:



7 Photographs - EUT Constructional Details

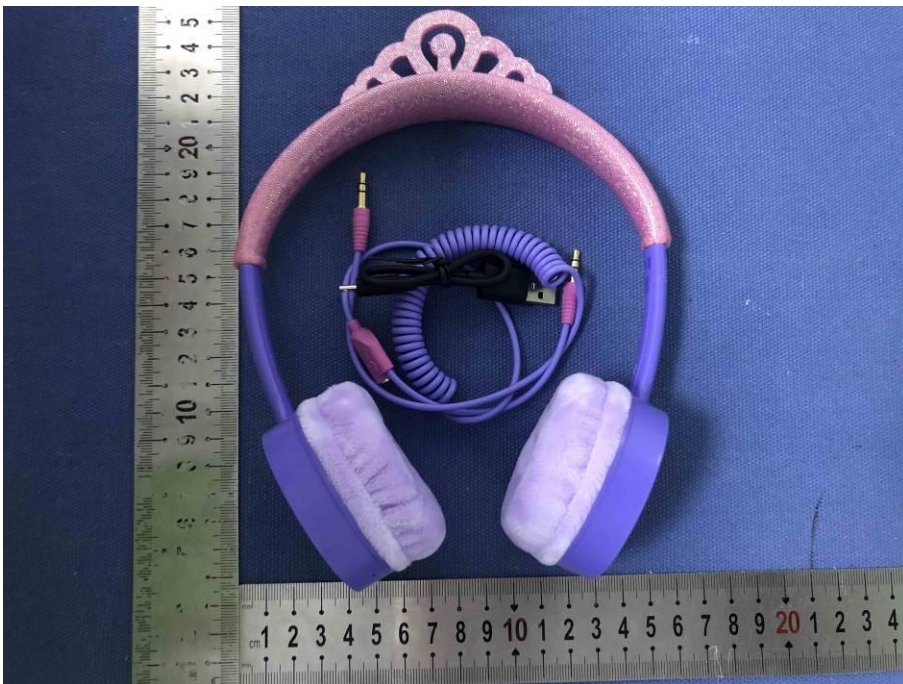



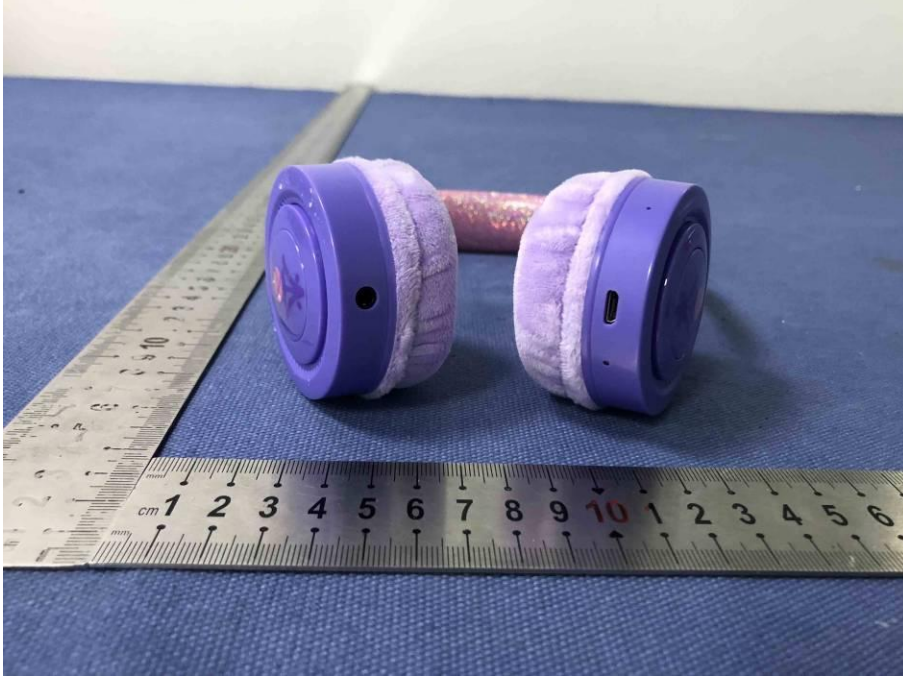



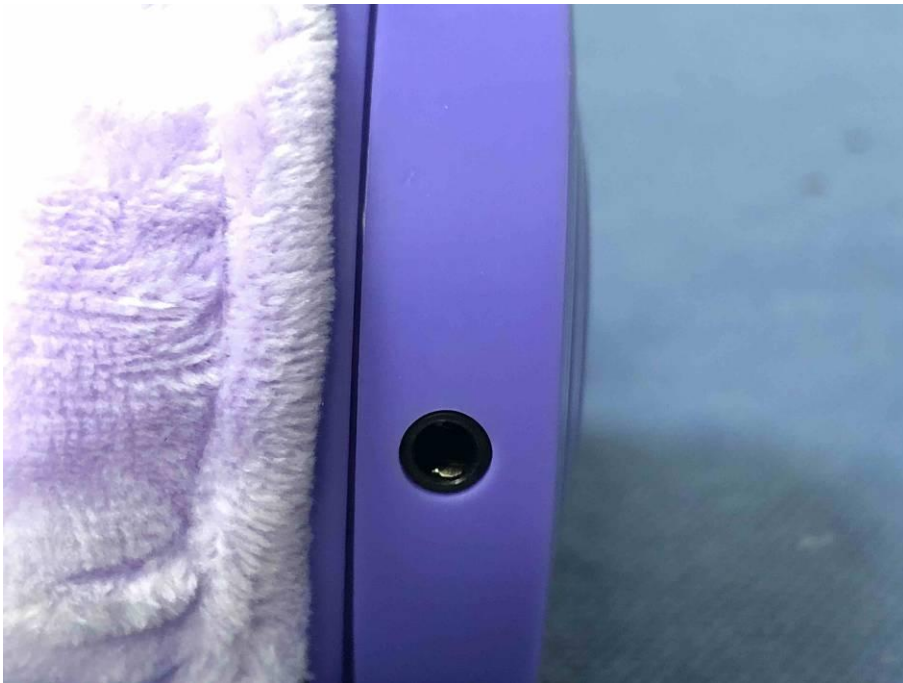

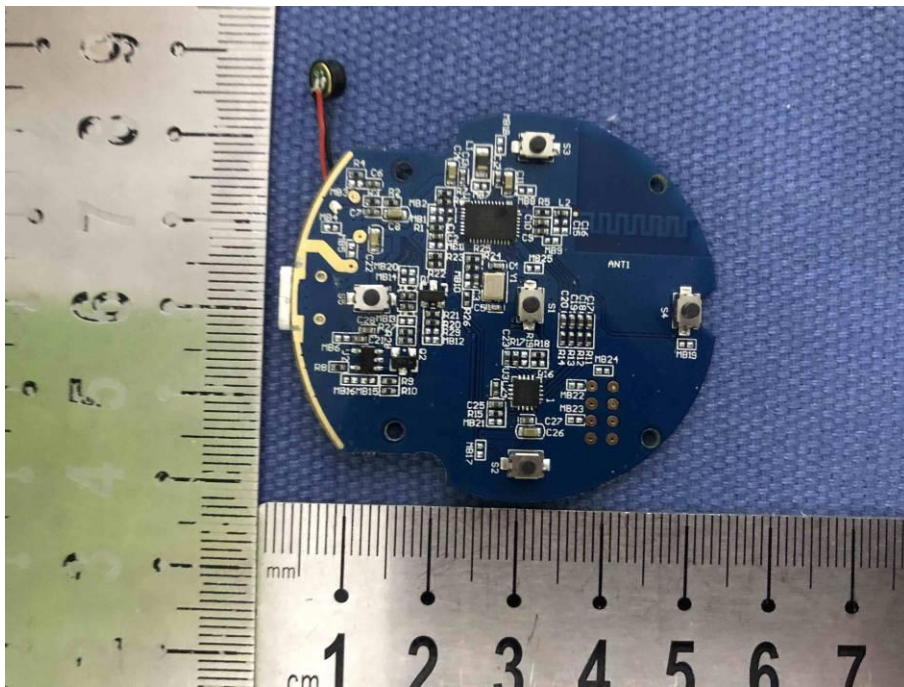

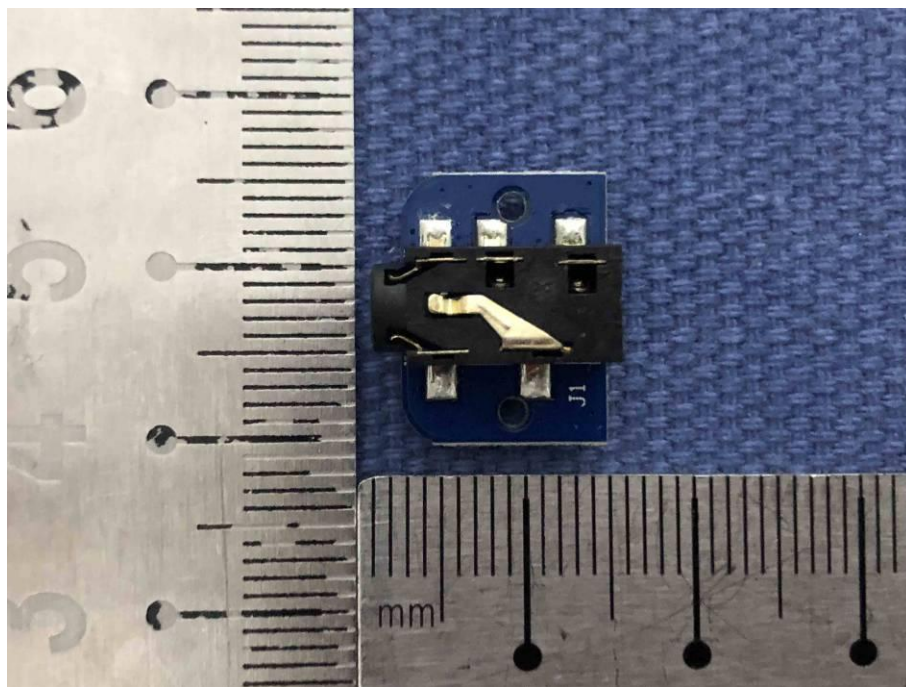
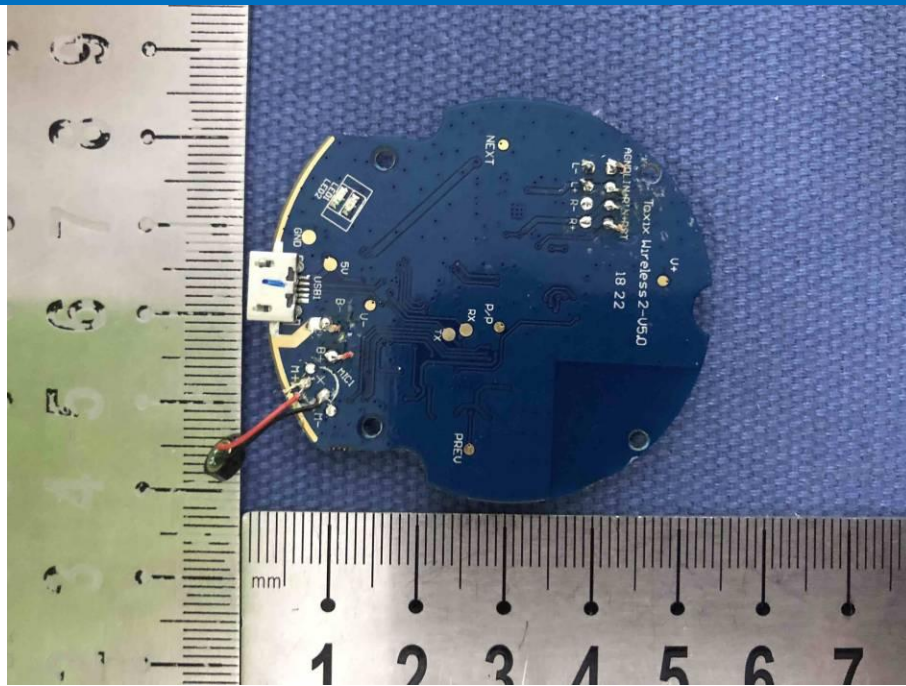

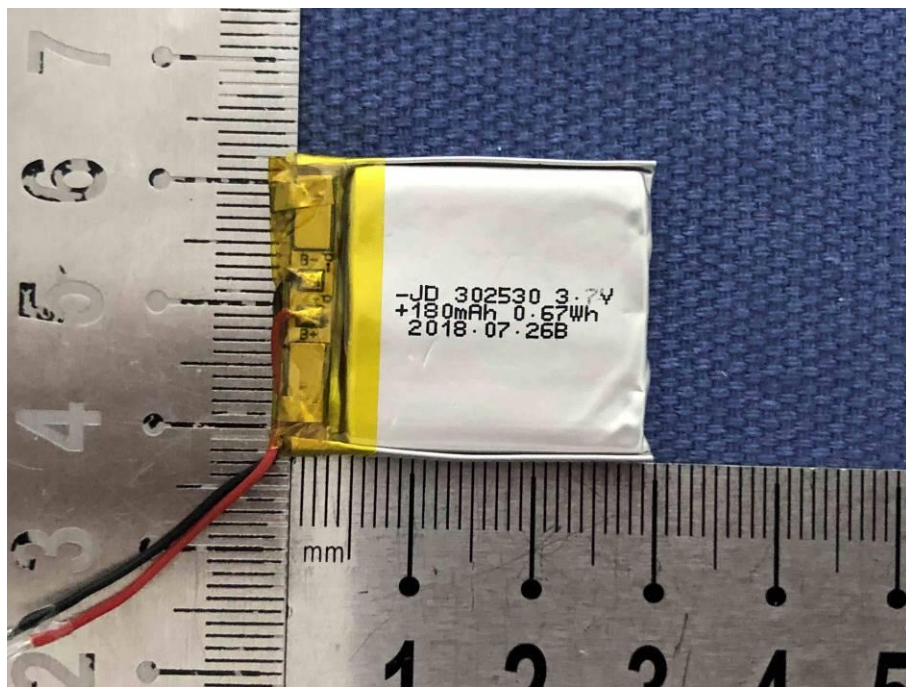
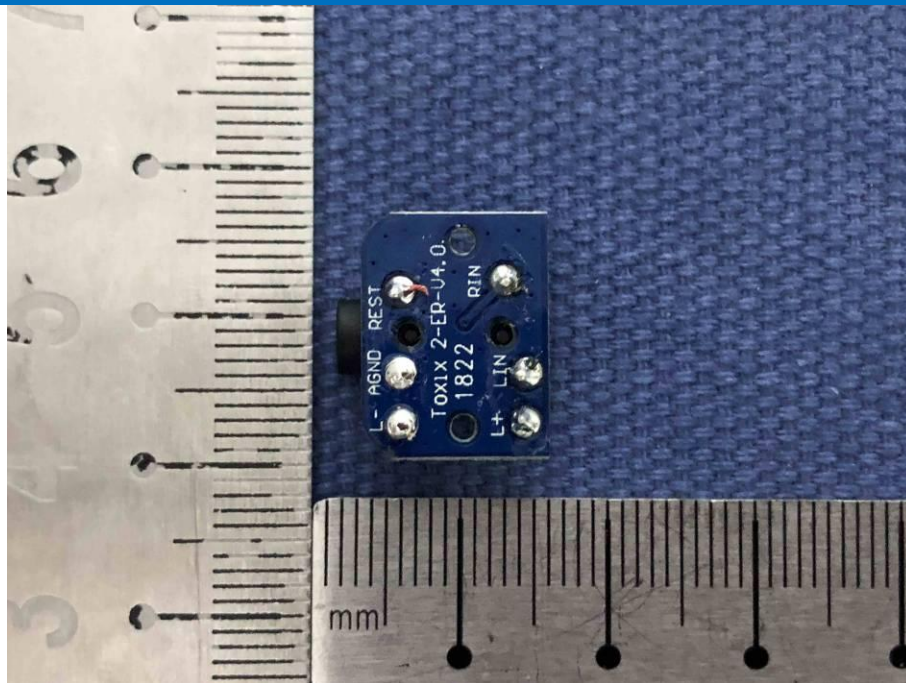

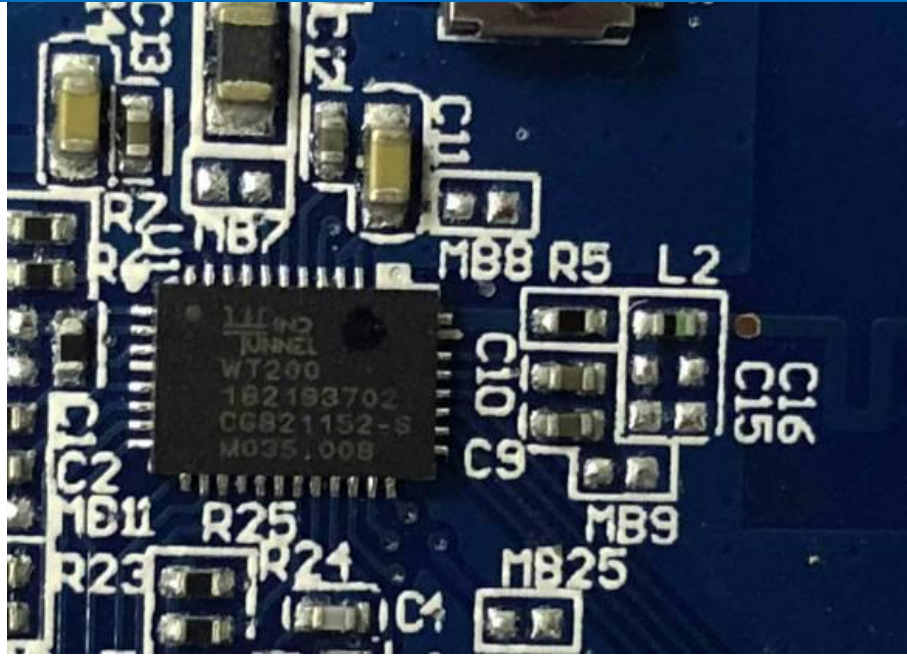

The End