



Neutron Engineering Inc.

FCC&IC Radio Test Report

FCC ID: QT7LENOVOPR700

IC: 11515A-LENOVOPR700

This report concerns (check one): Original Grant Class II Change

Issued Date : Mar. 18, 2014
Project No. : 1403C075
Equipment : Lenovo Multi-mode Portable Router
PR700
Model Name : Lenovo PR700
Applicant : Power7 Tchnology Co., Ltd.
Address : No.28 Binjiang Street, Shishuikou
Village, Qiaotou Town, Dongguan City,
GuangDong Province, P.R. China

Tested by: Neutron Engineering Inc. EMC Laboratory
Date of Receipt: Mar. 12, 2014
Date of Test: Mar. 12, 2014 ~ Mar. 17, 2014

Testing Engineer :

David Mao
(David Mao)

Technical Manager :

Leo Hung
(Leo Hung)

Authorized Signatory :

Steven Lu
(Steven Lu)

Neutron Engineering Inc.

No.3,Jinshagang 1st Road, ShiXia,
Dalang Town, Dong Guan, China.

TEL: 0769-8318-3000

FAX: 0769-8319-6000



Declaration

Neutron represents to the client that testing is done in accordance with standard procedures as applicable and that test instruments used has been calibrated with the standards traceable to National Measurement Laboratory (**NML**) of **R.O.C.**, or National Institute of Standards and Technology (**NIST**) of **U.S.A.**

Neutron's reports apply only to the specific samples tested under conditions. It is manufacture's responsibility to ensure that additional production units of this model are manufactured with the identical electrical and mechanical components. **Neutron** shall have no liability for any declarations, inferences or generalizations drawn by the client or others from **Neutron** issued reports.

Neutron's reports must not be used by the client to claim product endorsement by the authorities or any agency of the Government.

This report is the confidential property of the client. As a mutual protection to the clients, the public and **Neutron-self**, extracts from the test report shall not be reproduced except in full with **Neutron's** authorized written approval.

Neutron's laboratory quality assurance procedures are in compliance with the **ISO Guide 17025** requirements, and accredited by the conformity assessment authorities listed in this test report.

Limitation

For the use of the authority's logo is limited unless the Test Standard(s)/Scope(s)/Item(s) mentioned in this test report is (are) included in the conformity assessment authorities acceptance respective.



Table of Contents	Page
1 . CERTIFICATION	6
2 . SUMMARY OF TEST RESULTS	7
2.1 TEST FACILITY	8
2.2 MEASUREMENT UNCERTAINTY	8
3 . GENERAL INFORMATION	9
3.1 GENERAL DESCRIPTION OF EUT	9
3.2 DESCRIPTION OF TEST MODES	11
3.3 TABLE OF PARAMETERS OF TEXT SOFTWARE SETTING	12
3.4 BLOCK DIAGRAM SHOWING THE CONFIGURATION OF SYSTEM TESTED	13
3.5 DESCRIPTION OF SUPPORT UNITS	14
4 . EMC EMISSION TEST	15
4.1 CONDUCTED EMISSION MEASUREMENT	15
4.1.1 POWER LINE CONDUCTED EMISSION LIMITS	15
4.1.2 TEST PROCEDURE	15
4.1.3 DEVIATION FROM TEST STANDARD	15
4.1.4 TEST SETUP	16
4.1.5 EUT OPERATING CONDITIONS	16
4.1.6 EUT TEST CONDITIONS	16
4.1.7 TEST RESULTS	16
4.2 RADIATED EMISSION MEASUREMENT	19
4.2.1 RADIATED EMISSION LIMITS	19
4.2.2 TEST PROCEDURE	20
4.2.3 DEVIATION FROM TEST STANDARD	20
4.2.4 TEST SETUP	21
4.2.5 EUT OPERATING CONDITIONS	22
4.2.6 EUT TEST CONDITIONS	22
4.2.7 TEST RESULTS (9K~ 30MHZ)	23
4.2.8 TEST RESULTS (BETWEEN 30 – 1000 MHZ)	24
4.2.9 TEST RESULTS (ABOVE 1000 MHZ)	31
5 . BANDWIDTH TEST	60
5.1 APPLIED PROCEDURES	60
5.1.1 TEST PROCEDURE	60
5.1.2 DEVIATION FROM STANDARD	60
5.1.3 TEST SETUP	60
5.1.4 EUT OPERATION CONDITIONS	60
5.1.5 EUT TEST CONDITIONS	60
5.1.6 TEST RESULTS	61



Table of Contents	Page
6 . MAXIMUM OUTPUT POWER TEST	77
6.1 APPLIED PROCEDURES / LIMIT	77
6.1.1 TEST PROCEDURE	77
6.1.2 DEVIATION FROM STANDARD	77
6.1.3 TEST SETUP	77
6.1.4 EUT OPERATION CONDITIONS	77
6.1.5 EUT TEST CONDITIONS	77
6.1.6 TEST RESULTS	78
7 . ANTENNA CONDUCTED SPURIOUS EMISSION	82
7.1 APPLIED PROCEDURES / LIMIT	82
7.1.1 TEST PROCEDURE	82
7.1.2 DEVIATION FROM STANDARD	82
7.1.3 TEST SETUP	82
7.1.4 EUT OPERATION CONDITIONS	82
7.1.5 EUT TEST CONDITIONS	82
7.1.6 TEST RESULTS	83
8 . POWER SPECTRAL DENSITY TEST	123
8.1 APPLIED PROCEDURES / LIMIT	123
8.1.1 TEST PROCEDURE	123
8.1.2 DEVIATION FROM STANDARD	123
8.1.3 TEST SETUP	123
8.1.4 EUT OPERATION CONDITIONS	123
8.1.5 EUT TEST CONDITIONS	123
8.1.6 TEST RESULTS	124
9 . MEASUREMENT INSTRUMENTS LIST	144
10 . EUT TEST PHOTO	146



REPORT ISSUED HISTORY

Issued No.	Description	Issued Date
NEI-FICP-1-1403C075	Original Issue.	Mar. 18, 2014



1. CERTIFICATION

Equipment : Lenovo Multi-mode Portable Router PR700
Brand Name : Lenovo
Model Name : Lenovo PR700
Applicant : Power7 Tchnology Co., Ltd.
Manufacturer : Power7 Tchnology Co., Ltd.
Address : No.28 Binjiang Street, Shishuikou Village, Qiaotou Town, Dongguan City,
GuangDong Province, P.R. China
Factory : Power7 Tchnology Co., Ltd.
Address : No.28 Binjiang Street, Shishuikou Village, Qiaotou Town, Dongguan City,
GuangDong Province, P.R. China
Date of Test : Mar. 12, 2014 ~ Mar. 17, 2014
Test Item : ENGINEERING SAMPLE
Standard(s) : FCC Part15, Subpart C(15.247) / ANSI C63.4-2009
Canada RSS-210:2010
RSS-GEN Issue 3, Dec 2010

The above equipment has been tested and found compliance with the requirement of the relative standards by Neutron Engineering Inc. EMC Laboratory.

The test data, data evaluation, and equipment configuration contained in our test report (Ref No. NEI-FICP-1-1403C075) were obtained utilizing the test procedures, test instruments, test sites that has been accredited by the Authority of TAF according to the ISO-17025 quality assessment standard and technical standard(s).



2. SUMMARY OF TEST RESULTS

Test procedures according to the technical standard(s):

Applied Standard(s): FCC Part15 (15.247) , Subpart C Canada RSS-210:2010; RSS-GEN Issue 3, Dec 2010					
Standard(s)		Section	Test Item	Judgment	Remark
FCC	IC				
15.207		RSS-GEN 7.2.2	Conducted Emission	PASS	
15.247(d)		RSS-210 Annex 8 (A8.5)	Antenna conducted Spurious Emission	PASS	
15.247(a)(2)		RSS-210 Annex 8 (A8.2(a))	6dB Bandwidth	PASS	
15.247(b)(3)		RSS-210 Annex 8 (A8.4(4))	Peak Output Power	PASS	
15.247(e)		RSS-210 Annex 8 (A8.2(b))	Power Spectral Density	PASS	
15.203		-	Antenna Requirement	PASS	
15.209/15.205		RSS-210 Annex 8 (A8.5)	Transmitter Radiated Emissions	PASS	

NOTE:

- (1) "N/A" denotes test is not applicable in this test report.
- (2) The test follows FCC KDB Publication No. 558074 D01 DTS Meas Guidance v03r01 (Measurement Guidelines of DTS)



2.1 TEST FACILITY

The test facilities used to collect the test data in this report is **DG-C02/DG-CB03** at the location of No.3,Jinshagang 1st Road, ShiXia, Dalang Town, Dong Guan, China.523792

Neutron's test firm number for FCC: 319330

Neutron's test firm number for IC: 4428B-1

2.2 MEASUREMENT UNCERTAINTY

Where relevant, the following measurement uncertainty levels have been estimated for tests performed on the EUT as specified in CISPR 16-4-2:

The reported uncertainty of measurement $y \pm U$, where expanded uncertainty U is based on a standard uncertainty multiplied by a coverage factor of $k=2$, providing a level of confidence of approximately 95 %.

A. Conducted Measurement :

Test Site	Method	Measurement Frequency Range	U , (dB)	NOTE
DG-C02	CISPR	150 KHz ~ 30MHz	1.94	

B. Radiated Measurement :

Test Site	Method	Measurement Frequency Range	Ant. H / V	U , (dB)	NOTE
DG-CB03	CISPR	9KHz~30MHz	V	3.79	
		9KHz~30MHz	H	3.57	
		30MHz ~ 200MHz	V	3.82	
		30MHz ~ 200MHz	H	3.60	
		200MHz ~ 1,000MHz	V	3.86	
		200MHz ~ 1,000MHz	H	3.94	
		1GHz~18GHz	V	3.12	
		1GHz~18GHz	H	3.68	
		18GHz~40GHz	V	4.15	
		18GHz~40GHz	H	4.14	



3. GENERAL INFORMATION

3.1 GENERAL DESCRIPTION OF EUT

Equipment	Lenovo Multi-mode Portable Router PR700	
Brand Name	Lenovo	
Model Name	Lenovo PR700	
Model Difference	N/A	
Product Description	Operation Frequency	2412~2462 MHz
	Modulation Technology	802.11b:DSSS 802.11g:OFDM 802.11n:OFDM
	Bit Rate of Transmitter	802.11b: 11/5.5/2/1 Mbps 802.11g: 54/48/36/24/18/12/9/6 Mbps 802.11n up to 300 Mbps
	Output Power (Max.)	802.11b: 17.37 dBm 802.11g: 23.29 dBm 802.11n(20MHz): 23.35 dBm 802.11n(40MHz): 23.28 dBm
Power Source	#1 AC mains. #2 Supplied from Rechargeable Li-ion Battery.	
Power Rating	#1 I/P: AC 100-240V 0.3A, 50-60Hz O/P: DC 5V 1A/2.1A #2 DC 3.7V	
Connecting I/O Port(s)	Please refer to the User's Manual	

Note:

1. For a more detailed features description, please refer to the manufacturer's specifications or the User's Manual.



2.

Channel List							
CH 01 – CH 11 for 802.11b, 802.11g, 802.11n(20MHz) CH 03 – CH 09 for 802.11n(40MHz)							
Channel	Frequency (MHz)	Channel	Frequency (MHz)	Channel	Frequency (MHz)	Channel	Frequency (MHz)
01	2412	04	2427	07	2442	10	2457
02	2417	05	2432	08	2447	11	2462
03	2422	06	2437	09	2452		

3. Table for Filed Antenna

Ant.	Manufacturer	Model Name	Antenna Type	Connector	Gain (dBi)	Note
1	Sunlord	SLDA31-2R800G-S1 TF	Multilayer Chip Antenna	N/A	2.5	TX/RX
2	N/A	N/A	Internal	N/A	3	TX/RX

Note:

(1) The EUT incorporates a MIMO function. Physically, the EUT provides two completed two transmitters and two receivers (2T2R).

4.

Operating Mode	1TX	2TX
	TX Mode	
802.11b	-	V (ANT 1 + ANT 2)
802.11g	-	V (ANT 1 + ANT 2)
802.11n(20MHz)	-	V (ANT 1 + ANT 2)
802.11n(40MHz)	-	V (ANT 1 + ANT 2)



3.2 DESCRIPTION OF TEST MODES

To investigate the maximum EMI emission characteristics generates from EUT, the test system was pre-scanning tested base on the consideration of following EUT operation mode or test configuration mode which possible have effect on EMI emission level. Each of these EUT operation mode(s) or test configuration mode(s) mentioned above was evaluated respectively.

Pretest Mode	Description
Mode 1	TX B MODE CHANNEL 01/06/11
Mode 2	TX G MODE CHANNEL 01/06/11
Mode 3	TX N-20MHZ MODE CHANNEL 01/06/11
Mode 4	TX N-40MHZ MODE CHANNEL 03/06/09
Mode 5	TX MODE

The EUT system operated these modes were found to be the worst case during the pre-scanning test as following:

For Conducted Test	
Final Test Mode	Description
Mode 5	TX MODE

For Radiated Test	
Final Test Mode	Description
Mode 1	TX B MODE CHANNEL 01/06/11
Mode 2	TX G MODE CHANNEL 01/06/11
Mode 3	TX N-20MHZ MODE CHANNEL 01/06/11
Mode 4	TX N-40MHZ MODE CHANNEL 03/06/09

Note:

- (1) The measurements are performed at the high, middle, low available channels.
- (2) 802.11b mode: DBPSK (1Mbps)
 802.11g mode: OFDM (6Mbps)
 802.11n HT20 mode : BPSK (13Mbps)
 802.11n HT40 mode : BPSK (27Mbps)
 For radiated emission tests, the highest output powers were set for final test.
- (3) For radiated below 1G test, the 802.11b is found to be the worst case and recorded.



3.3 TABLE OF PARAMETERS OF TEXT SOFTWARE SETTING

During testing, channel & power controlling software provided by the customer was used to control the operating channel as well as the output power level. The RF output power selection is for the setting of RF output power expected by the customer and is going to be fixed on the firmware of the final end product power parameters of WLAN

Test software version	MT7620QA		
Frequency	2412 MHz	2437 MHz	2462 MHz
IEEE 802.11b DSSS	OE	OE	OD
IEEE 802.11g OFDM	OD	OD	OC
IEEE 802.11n (20MHz)	OD	OD	OC
Frequency (MHz)	2422 MHz	2437 MHz	2452 MHz
IEEE 802.11n (40MHz)	OF	OF	OE



3.4 BLOCK DIAGRAM SHOWING THE CONFIGURATION OF SYSTEM TESTED

Conducted TX Mode:

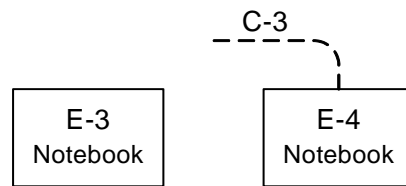
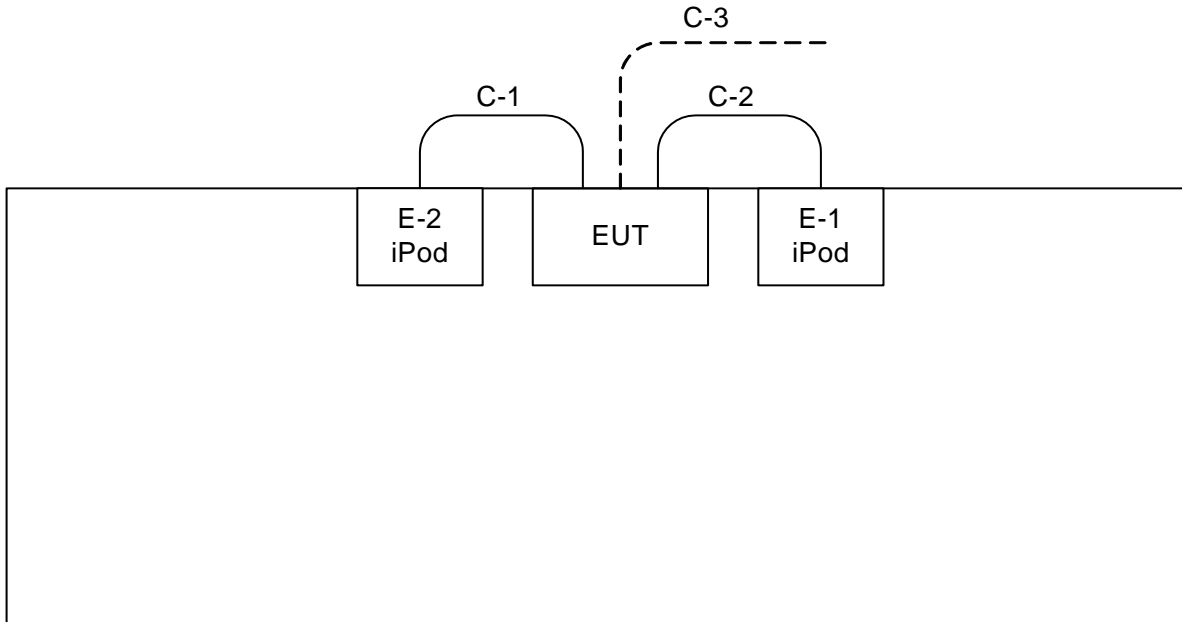

Radiated TX Mode:

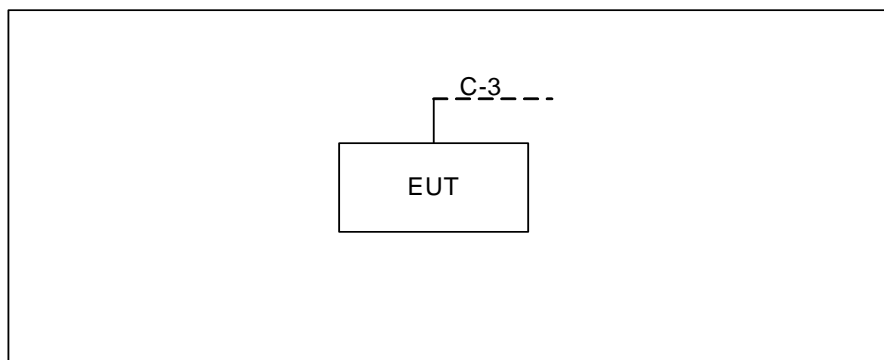

Control Room

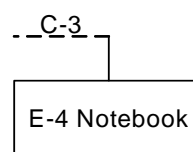



3.5 DESCRIPTION OF SUPPORT UNITS

The EUT has been tested as an independent unit together with other necessary accessories or support units. The following support units or accessories were used to form a representative test configuration during the tests.

Item	Equipment	Mfr/Brand	Model/Type No.	FCC ID/IC	Series No.	Note
E-1	iPod nano	Apple	A1137	DOC	YM63604QUPR	
E-2	iPod nano	Apple	A1199	DOC	YM7214GEVQ5	
E-3	Notebook	Lenovo	E46L	DOC	EB22953787	
E-4	Notebook	Lenovo	E46L	DOC	EB22953770	

Item	Shielded Type	Ferrite Core	Length	Note
C-1	NO	NO	0.8m	USB Cable
C-2	NO	NO	0.8m	USB Cable
C-3	NO	NO	10m	RJ45 Cable



4. EMC EMISSION TEST

4.1 CONDUCTED EMISSION MEASUREMENT

4.1.1 POWER LINE CONDUCTED EMISSION Limits (Frequency Range 150KHz-30MHz)

Frequency (MHz)	Class A (dBuV)		Class B (dBuV)		Standard
	Quasi-peak	Average	Quasi-peak	Average	
0.15 -0.5	79.00	66.00	66 - 56 *	56 - 46 *	CISPR
0.50 -5.0	73.00	60.00	56.00	46.00	CISPR
5.0 -30.0	73.00	60.00	60.00	50.00	CISPR
0.15 -0.5	79.00	66.00	66 - 56 *	56 - 46 *	FCC
0.50 -5.0	73.00	60.00	56.00	46.00	FCC
5.0 -30.0	73.00	60.00	60.00	50.00	FCC

Note:

- (1) The tighter limit applies at the band edges.
- (2) The limit of " * " marked band means the limitation decreases linearly with the logarithm of the frequency in the range.

The following table is the setting of the receiver

Receiver Parameters	Setting
Attenuation	10 dB
Start Frequency	0.15 MHz
Stop Frequency	30 MHz
IF Bandwidth	9 KHz

4.1.2 TEST PROCEDURE

- a. The EUT was placed 0.8 meters from the horizontal ground plane with EUT being connected to the power mains through a line impedance stabilization network (LISN). All other support equipments powered from additional LISN(s). The LISN provide 50 Ohm/ 50uH of coupling impedance for the measuring instrument.
- b. Interconnecting cables that hang closer than 40 cm to the ground plane shall be folded back and forth in the center forming a bundle 30 to 40 cm long.
- c. I/O cables that are not connected to a peripheral shall be bundled in the center. The end of the cable may be terminated, if required, using the correct terminating impedance. The overall length shall not exceed 1 m.
- d. LISN at least 80 cm from nearest part of EUT chassis.
- e. For the actual test configuration, please refer to the related Item –EUT Test Photos.

4.1.3 DEVIATION FROM TEST STANDARD

No deviation

4.1.4 TEST SETUP

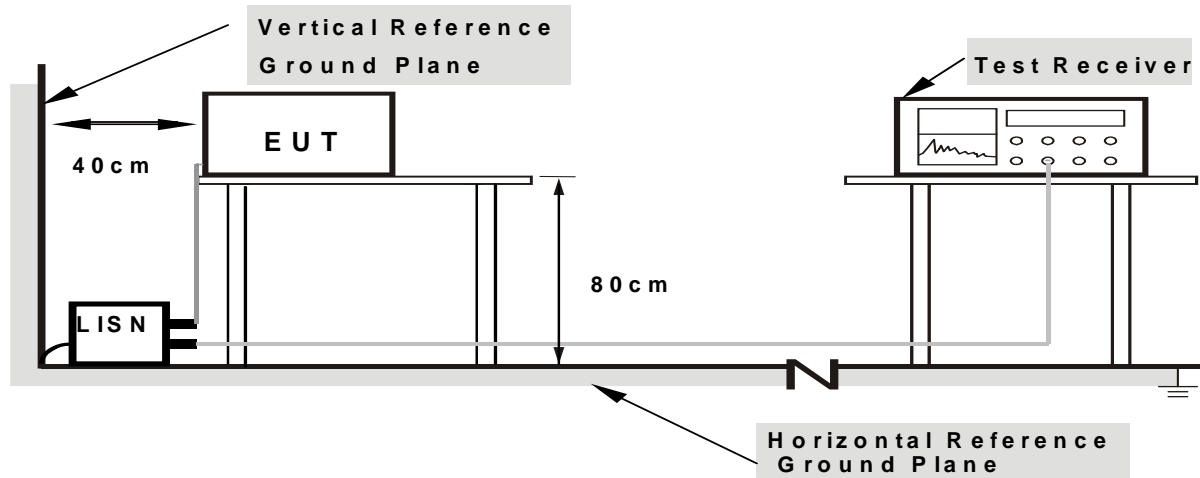

- Note:**
1. Support units were connected to second LISN.
 2. Both of LISNs (AMN) are 80 cm from EUT and at least 80 from other units and other metal planes

4.1.5 EUT OPERATING CONDITIONS

The EUT was configured for testing in a typical fashion (as a customer would normally use it). The EUT has been programmed to continuously transmit during test. This operating condition was tested and used to collect the included data.

4.1.6 EUT TEST CONDITIONS

Temperature: 25°C
 Relative Humidity: 55%
 Test Voltage: AC 120V/60Hz

4.1.7 TEST RESULTS

Remark:

- (1) All readings are QP Mode value unless otherwise stated AVG in column of 『Note』. If the QP Mode Measured value compliance with the QP Limits and lower than AVG Limits, the EUT shall be deemed to meet both QP & AVG Limits and then only QP Mode was measured, but AVG Mode didn't perform. In this case, a “*” marked in AVG Mode column of Interference Voltage Measured.
- (2) Measuring frequency range from 150KHz to 30MHz.



Test Mode : TX MODE

Line

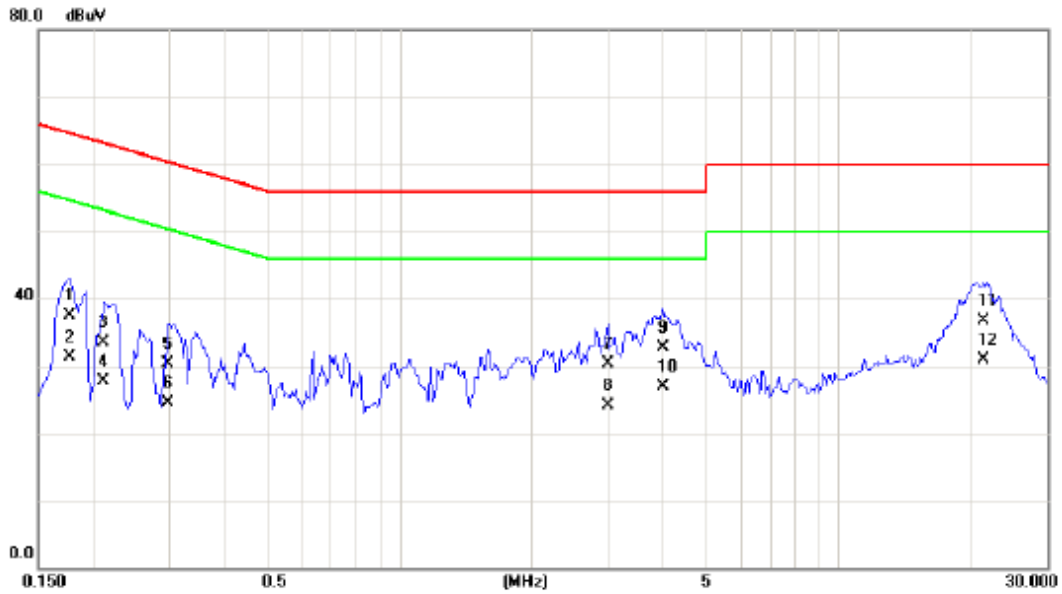

No.	Mk.	Freq. MHz	Reading Level dBuV	Correct Factor dB	Measure- ment dBuV	Limit dBuV	Over dB	Detector	Comment
1		0.1773	27.80	9.65	37.45	64.61	-27.16	QP	
2		0.1773	21.70	9.65	31.35	54.61	-23.26	AVG	
3		0.2125	23.90	9.65	33.55	63.11	-29.56	QP	
4		0.2125	18.10	9.65	27.75	53.11	-25.36	AVG	
5		0.2983	20.70	9.67	30.37	60.29	-29.92	QP	
6		0.2983	14.90	9.67	24.57	50.29	-25.72	AVG	
7		2.9781	20.40	9.86	30.26	56.00	-25.74	QP	
8		2.9781	14.30	9.86	24.16	46.00	-21.84	AVG	
9		3.9883	22.90	9.90	32.80	56.00	-23.20	QP	
10	*	3.9883	17.10	9.90	27.00	46.00	-19.00	AVG	
11		21.4961	26.50	10.27	36.77	60.00	-23.23	QP	
12		21.4961	20.70	10.27	30.97	50.00	-19.03	AVG	



Test Mode : TX MODE

Neutral

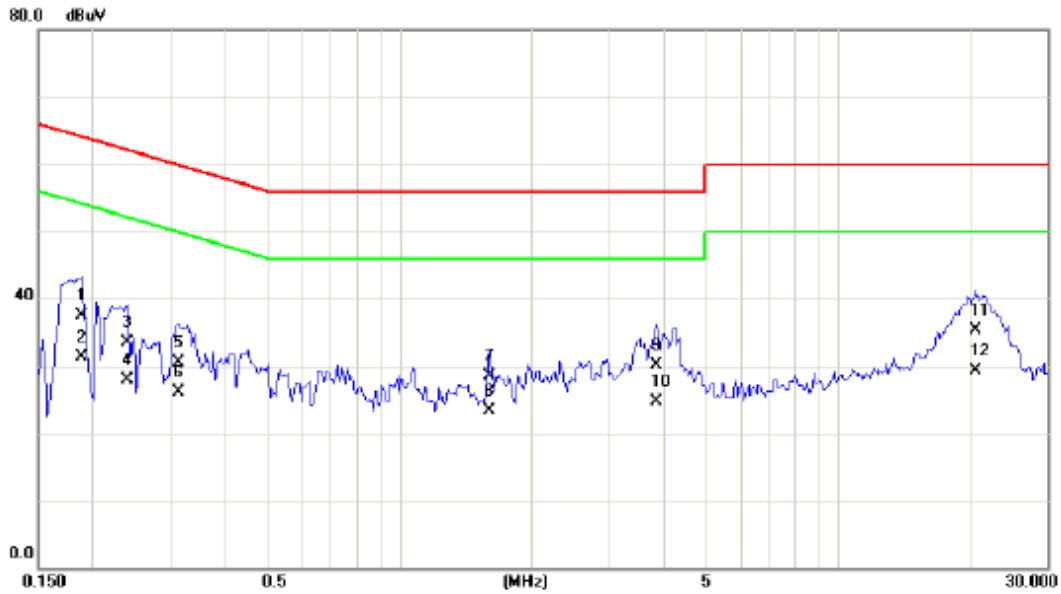

No.	Mk.	Freq. MHz	Reading Level dBuV	Correct Factor dB	Measure- ment dBuV	Limit dBuV	Over dB	Detector	Comment
1		0.1891	27.80	9.71	37.51	64.08	-26.57	QP	
2		0.1891	21.60	9.71	31.31	54.08	-22.77	AVG	
3		0.2398	23.70	9.71	33.41	62.10	-28.69	QP	
4		0.2398	18.10	9.71	27.81	52.10	-24.29	AVG	
5		0.3141	20.70	9.72	30.42	59.86	-29.44	QP	
6		0.3141	16.30	9.72	26.02	49.86	-23.84	AVG	
7		1.6070	18.60	9.83	28.43	56.00	-27.57	QP	
8		1.6070	13.50	9.83	23.33	46.00	-22.67	AVG	
9		3.8594	20.10	9.91	30.01	56.00	-25.99	QP	
10		3.8594	14.70	9.91	24.61	46.00	-21.39	AVG	
11		20.5234	24.80	10.41	35.21	60.00	-24.79	QP	
12	*	20.5234	18.90	10.41	29.31	50.00	-20.69	AVG	



4.2 RADIATED EMISSION MEASUREMENT

4.2.1 RADIATED EMISSION LIMITS (Frequency Range 9KHz-1000MHz)

20dB in any 100 KHz bandwidth outside the operating frequency band. In case the emission fall within the restricted band specified on 15.205(a) & RSS-210 section 2.2& Annex 8 (A8.5), then the 15.209(a)& RSS-Gen limit in the table below has to be followed.

Frequency (MHz)	Field Strength (microvolts/meter)	Measurement Distance (meters)
0.009~0.490	2400/F(KHz)	300
0.490~1.705	24000/F(KHz)	30
1.705~30.0	30	30
30~88	100	3
88~216	150	3
216~960	200	3
960~1000	500	3

LIMITS OF RADIATED EMISSION MEASUREMENT (Above 1000MHz)

Frequency (MHz)	(dBuV/m) (at 3 meters)	
	PEAK	AVERAGE
Above 1000	74	54

Notes:

- (1) The limit for radiated test was performed according to FCC PART 15C.
- (2) The tighter limit applies at the band edges.
- (3) Emission level (dBuV/m)=20log Emission level (uV/m).

Spectrum Parameter	Setting
Attenuation	Auto
Start Frequency	1000 MHz
Stop Frequency	10th carrier harmonic
RBW / VBW (Emission in restricted band)	1MHz / 1MHz for Peak, 1 MHz / 10Hz for Average

Receiver Parameter	Setting
Attenuation	Auto
Start ~ Stop Frequency	9KHz~90KHz for PK/AVG detector
Start ~ Stop Frequency	90KHz~110KHz for QP detector
Start ~ Stop Frequency	110KHz~490KHz for PK/AVG detector
Start ~ Stop Frequency	490KHz~30MHz for QP detector
Start ~ Stop Frequency	30MHz~1000MHz for QP detector



4.2.2 TEST PROCEDURE

- a. The EUT was placed on the top of a rotating table 0.8 meters above the ground at a 3 meter semi-anechoic chamber. The table was rotated 360 degrees to determine the position of the highest radiation.(below 1GHz)
- b. The EUT was placed on the top of a rotating table 0.8 meters above the ground at a 3 meter fully-anechoic chamber. The table was rotated 360 degrees to determine the position of the highest radiation.(above 1GHz)
- c. The height of the equipment or of the substitution antenna shall be 0.8 m; the height of the test antenna shall vary between 1 m to 4 m. Both horizontal and vertical polarizations of the antenna are set to make the measurement.
- d. The initial step in collecting conducted emission data is a spectrum analyzer peak detector mode pre-scanning the measurement frequency range. Significant peaks are then marked and then Quasi Peak detector mode re-measured.
- e. If the Peak Mode measured value compliance with and lower than Quasi Peak Mode Limit, the EUT shall be deemed to meet QP Limits and then no additional QP Mode measurement performed.
- f. For the actual test configuration, please refer to the related Item –EUT Test Photos.

4.2.3 DEVIATION FROM TEST STANDARD

No deviation

4.2.4 TEST SETUP

(A) Radiated Emission Test Set-Up Frequency Below 1 GHz

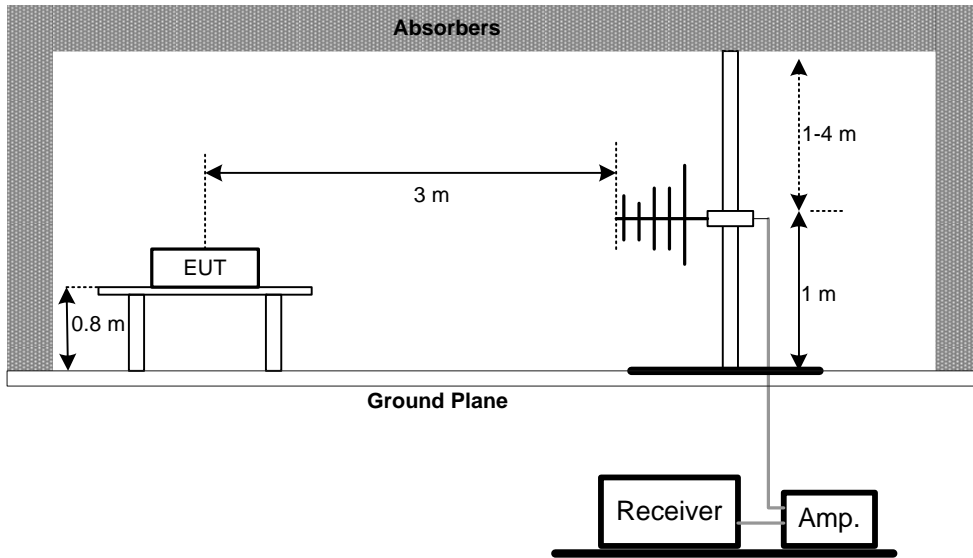

(B) Radiated Emission Test Set-Up Frequency Above 1 GHz

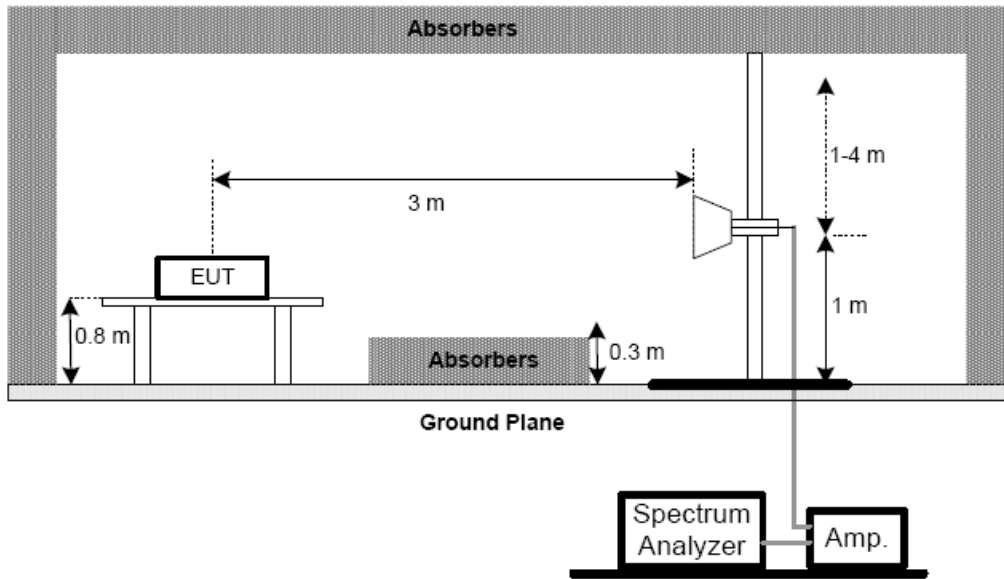

(C) For radiated emissions below 30MHz

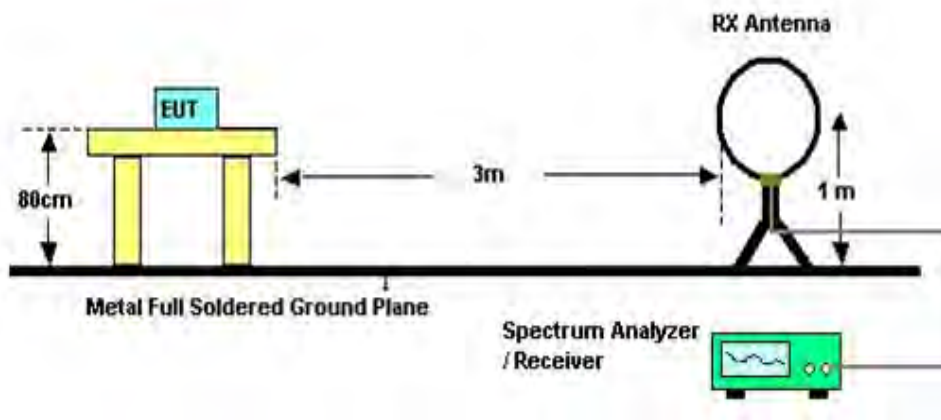

4.2.5 EUT OPERATING CONDITIONS

The EUT tested system was configured as the statements of 4.1.6 Unless otherwise a special operating condition is specified in the follows during the testing.

4.2.6 EUT TEST CONDITIONS

Temperature: 25°C

Relative Humidity: 55%

Test Voltage: AC 120V/60Hz



4.2.7 TEST RESULTS (9K~ 30MHZ)

Test Mode : TX Mode 2412MHz

Freq. (MHz)	Ant. 0°/90°	Reading(RA) (dBuV)	Corr.Factor(CF) (dB)	Measured(FS) (dBuV/m)	Limits(QP) (dBuV/m)	Margin (dB)	Note
0.0094	0°	17.53	24.30	41.83	128.12	-86.29	AV
0.0095	0°	19.72	24.30	44.02	148.12	-104.10	PK
0.0134	0°	18.15	24.30	42.45	125.06	-82.61	AV
0.0137	0°	20.40	24.30	44.70	145.06	-100.36	PK
0.0245	0°	17.46	24.02	41.48	119.82	-78.35	AV
0.0247	0°	20.08	24.02	44.10	139.82	-95.73	PK
0.0326	0°	18.13	23.50	41.63	117.34	-75.71	AV
0.0328	0°	20.55	23.50	44.05	137.34	-93.29	PK
0.4240	0°	18.72	19.98	38.70	95.06	-56.35	AVG
0.4260	0°	21.15	19.98	41.13	115.06	-73.92	PK
1.5250	0°	18.95	19.55	38.50	63.94	-25.44	QP

Freq. (MHz)	Ant. 0°/90°	Reading(RA) (dBuV)	Corr.Factor(CF) (dB)	Measured(FS) (dBuV/m)	Limits(QP) (dBuV/m)	Margin (dB)	Note
0.0094	90°	18.51	24.30	42.81	128.19	-85.38	AVG
0.0094	90°	20.23	24.30	44.53	148.19	-103.66	PK
0.0236	90°	17.55	24.07	41.62	120.15	-78.52	AVG
0.0237	90°	20.33	24.07	44.40	140.15	-95.74	PK
0.0317	90°	18.43	23.56	41.99	117.58	-75.59	AVG
0.0318	90°	20.67	23.56	44.23	137.58	-93.35	PK
0.0428	90°	17.85	22.86	40.71	114.98	-74.27	AVG
0.0429	90°	20.39	22.86	43.25	134.98	-91.73	PK
0.2370	90°	17.45	20.43	37.88	100.11	-62.23	AVG
0.2390	90°	20.72	20.43	41.15	120.11	-78.96	PK
1.6750	90°	18.63	19.53	38.16	63.12	-24.96	QP

Remark:

- (1) The amplitude of spurious emissions which are attenuated by more than 20 dB below the permissible value has no need to be reported.
- (2) Distance extrapolation factor = $40 \log(\text{specific distance} / \text{test distance})$ (dB);
- (3) Limit line = specific limits (dBuV) + distance extrapolation factor.



4.2.8 TEST RESULTS (BETWEEN 30 – 1000 MHZ)

Remark:

- (1) Reading in which marked as QP or Peak means measurements by using are Quasi-Peak Mode or Peak Mode with Detector BW=120KHz ; SPA setting in RBW=120KHz, VBW =120KHz, Swp. Time = 0.3 sec./MHz.
- (2) All readings are Peak unless otherwise stated QP in column of 『Note』 . Peak denotes that the Peak reading compliance with the QP Limits and then QP Mode measurement didn't perform.
- (3) Measuring frequency range from 30MHz to 1000MHz.
- (4) If the peak scan value lower limit more than 20dB, then this signal data does not show in table.



Test Mode: TX B MODE CHANNEL 01

Vertical

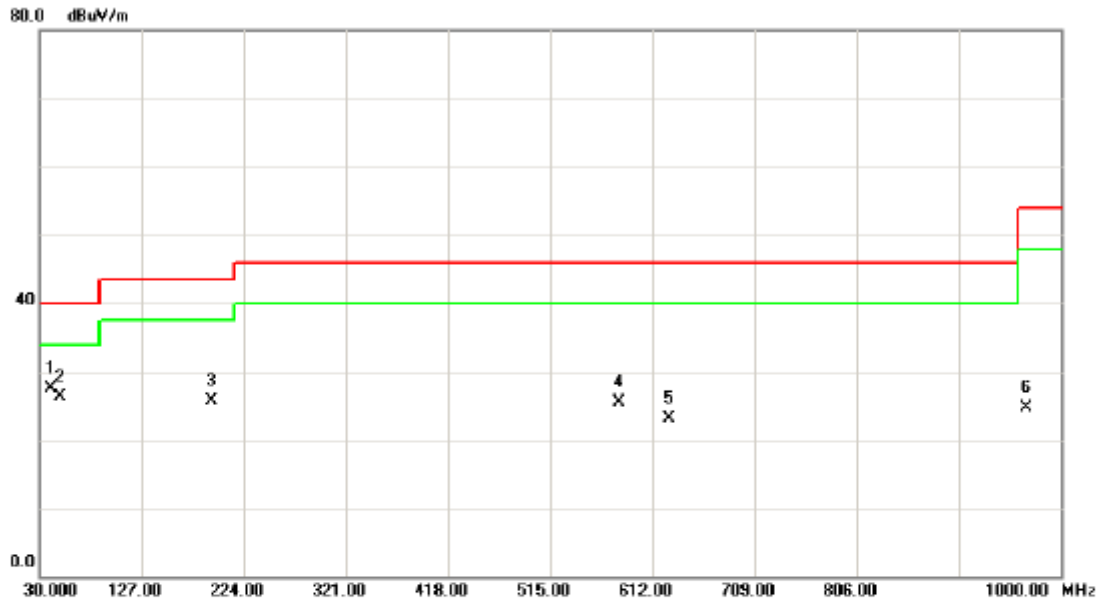

No.	Mk.	Freq. MHz	Reading Level dBuV	Correct Factor dB	Measure- ment dBuV/m	Limit dBuV/m	Over dB	Detector	Comment
1	*	40.6700	42.04	-14.58	27.46	40.00	-12.54	QP	
2		49.4000	40.99	-14.70	26.29	40.00	-13.71	QP	
3		192.9600	40.20	-14.58	25.62	43.50	-17.88	QP	
4		579.9900	33.50	-7.92	25.58	46.00	-20.42	QP	
5		628.4900	29.70	-6.66	23.04	46.00	-22.96	QP	
6		967.0200	24.90	-0.26	24.64	54.00	-29.36	QP	



Test Mode: TX B MODE CHANNEL 01

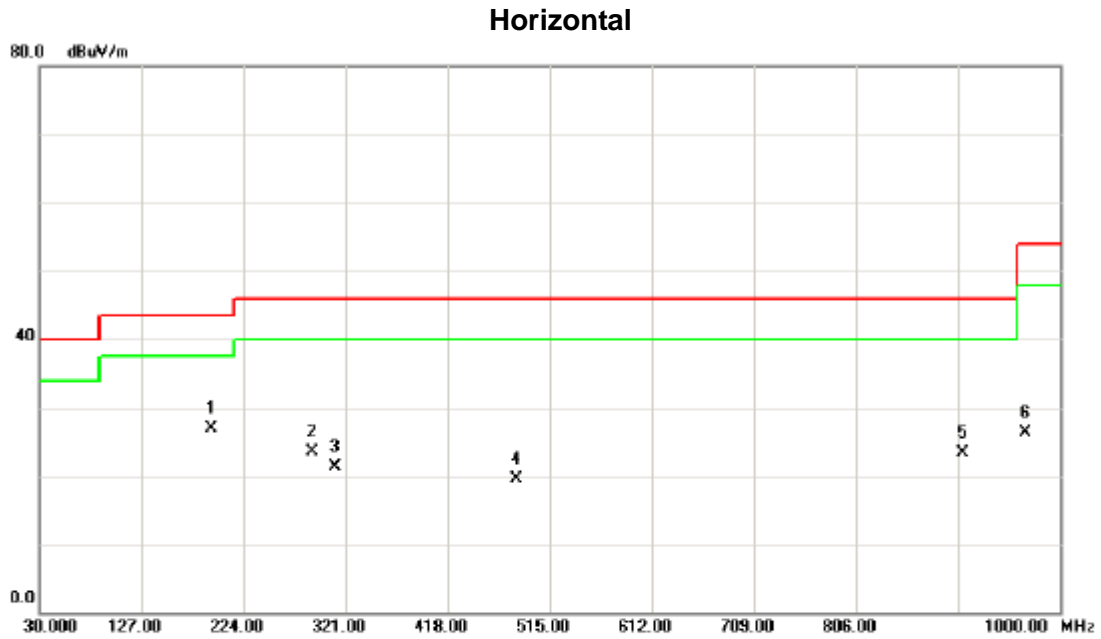

No.	Mk.	Freq. MHz	Reading Level dBuV	Correct Factor dB	Measure- ment dBuV/m	Limit dBuV/m	Over dB	Detector	Comment
1	*	192.9600	41.44	-14.58	26.86	43.50	-16.64	QP	
2		288.9900	35.37	-11.89	23.48	46.00	-22.52	QP	
3		311.3000	32.63	-11.30	21.33	46.00	-24.67	QP	
4		482.9900	29.37	-9.85	19.52	46.00	-26.48	QP	
5		906.8800	24.38	-1.16	23.22	46.00	-22.78	QP	
6		967.0200	26.51	-0.26	26.25	54.00	-27.75	QP	



Test Mode: TX B MODE CHANNEL 06

Vertical

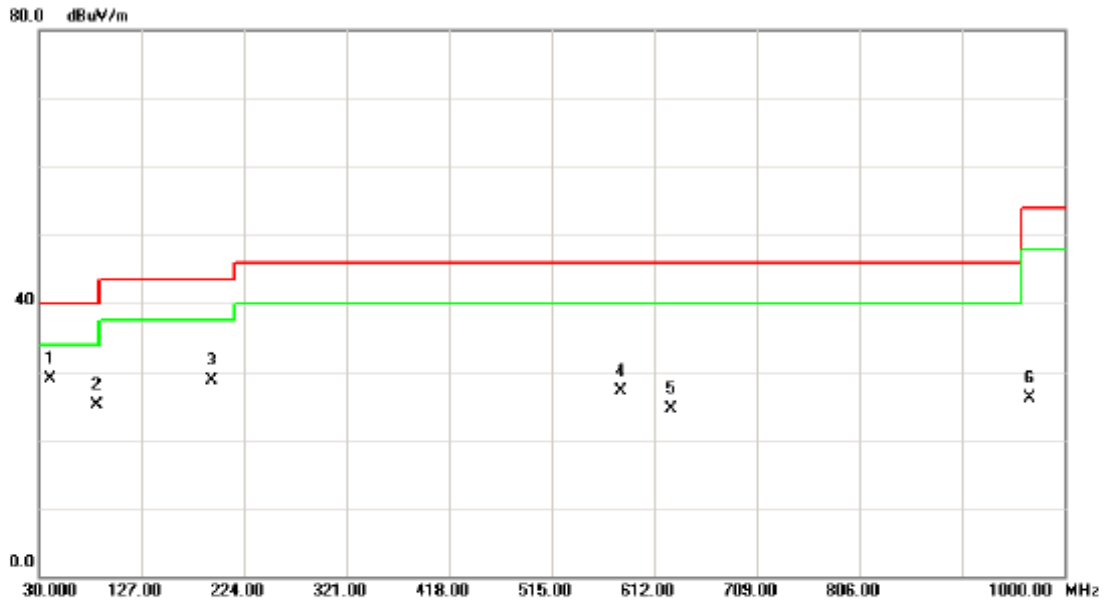

No.	Mk.	Freq. MHz	Reading Level dBuV	Correct Factor dB	Measure- ment dBuV/m	Limit dBuV/m	Over dB	Detector	Comment
1	*	40.6700	43.50	-14.58	28.92	40.00	-11.08	QP	
2		85.2900	42.90	-17.88	25.02	40.00	-14.98	QP	
3		192.9600	43.20	-14.58	28.62	43.50	-14.88	QP	
4		579.9900	35.10	-7.92	27.18	46.00	-18.82	QP	
5		628.4900	31.20	-6.66	24.54	46.00	-21.46	QP	
6		967.0200	26.30	-0.26	26.04	54.00	-27.96	QP	



Test Mode: TX B MODE CHANNEL 06

Horizontal

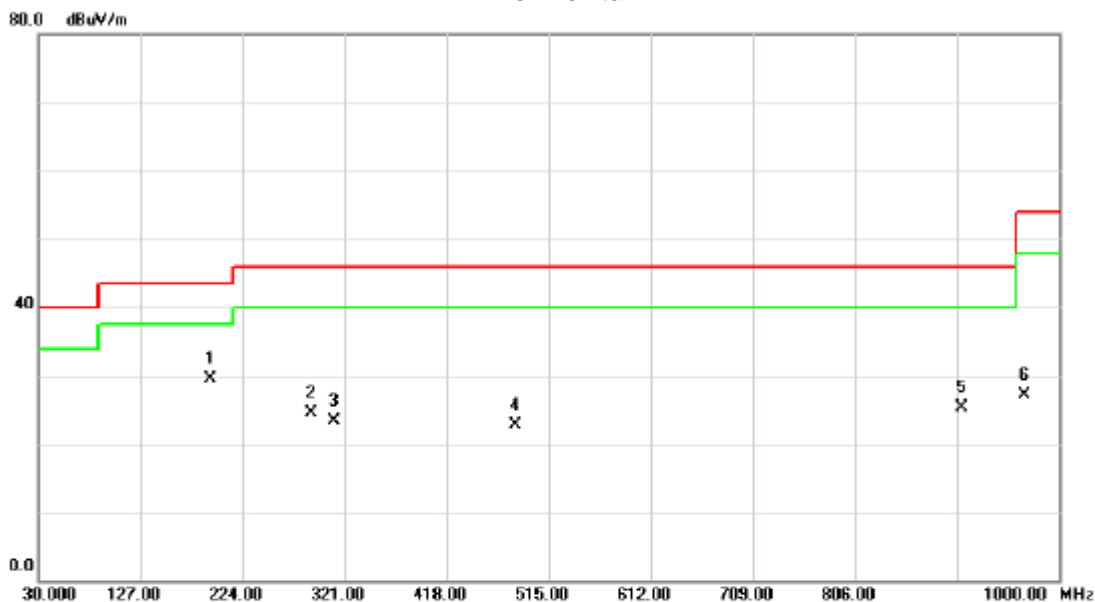

No.	Mk.	Freq. MHz	Reading Level dBuV	Correct Factor dB	Measure- ment dBuV/m	Limit dBuV/m	Over dB	Detector	Comment
1	*	192.9600	44.10	-14.58	29.52	43.50	-13.98	QP	
2		288.9900	36.30	-11.89	24.41	46.00	-21.59	QP	
3		311.3000	34.70	-11.30	23.40	46.00	-22.60	QP	
4		482.9900	32.60	-9.85	22.75	46.00	-23.25	QP	
5		906.8800	26.50	-1.16	25.34	46.00	-20.66	QP	
6		967.0200	27.30	-0.26	27.04	54.00	-26.96	QP	



Test Mode: TX B MODE CHANNEL 11

Vertical

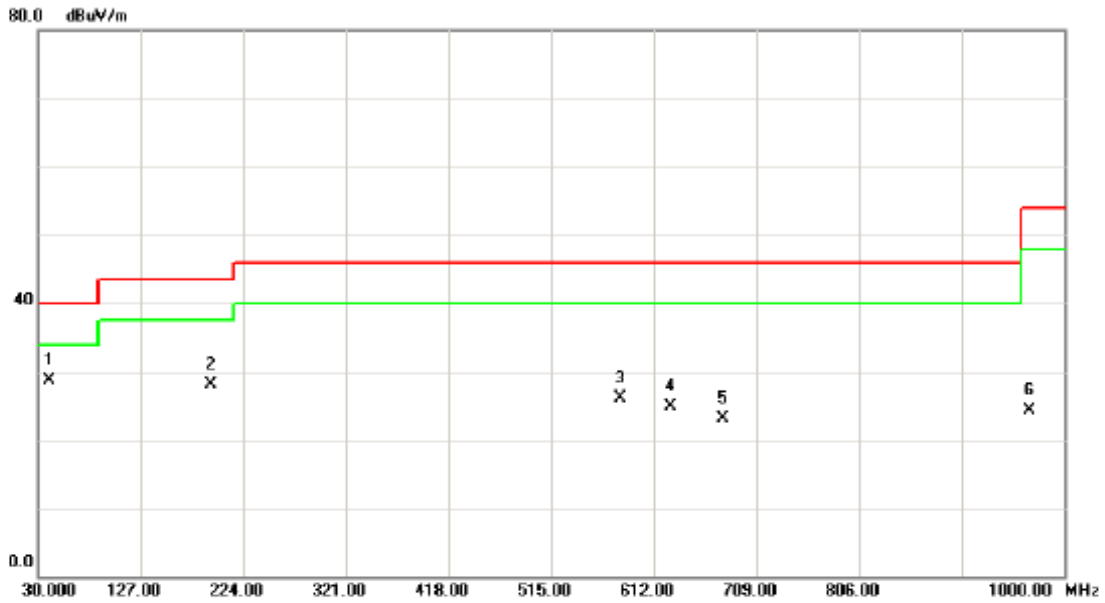

No.	Mk.	Freq. MHz	Reading Level dBuV	Correct Factor dB	Measurement dBuV/m	Limit dBuV/m	Over dB	Detector	Comment
1	*	40.6700	43.20	-14.58	28.62	40.00	-11.38	QP	
2		192.9600	42.60	-14.58	28.02	43.50	-15.48	QP	
3		579.9900	34.10	-7.92	26.18	46.00	-19.82	QP	
4		628.4900	31.50	-6.66	24.84	46.00	-21.16	QP	
5		676.9900	28.20	-5.16	23.04	46.00	-22.96	QP	
6		967.0200	24.60	-0.26	24.34	54.00	-29.66	QP	



Test Mode: TX B MODE CHANNEL 11

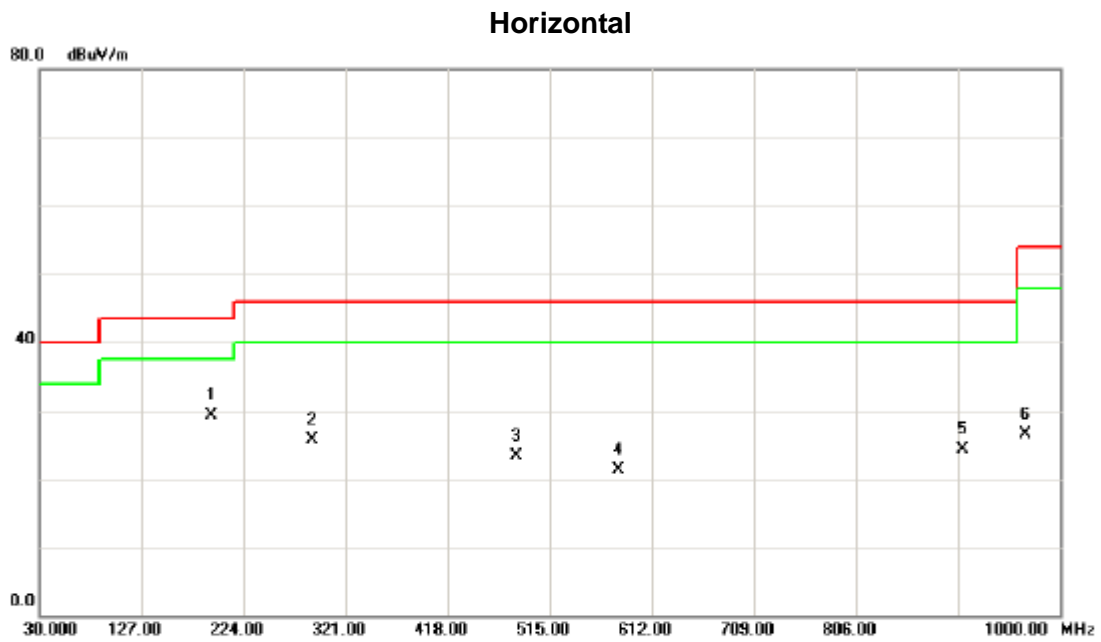

No.	Mk.	Freq. MHz	Reading Level dBuV	Correct Factor dB	Measure- ment dBuV/m	Limit dBuV/m	Over dB	Detector	Comment
1	*	192.9600	43.90	-14.58	29.32	43.50	-14.18	QP	
2		288.9900	37.50	-11.89	25.61	46.00	-20.39	QP	
3		482.9900	33.10	-9.85	23.25	46.00	-22.75	QP	
4		579.9900	29.20	-7.92	21.28	46.00	-24.72	QP	
5		906.8800	25.40	-1.16	24.24	46.00	-21.76	QP	
6		967.0200	26.80	-0.26	26.54	54.00	-27.46	QP	



4.2.9 TEST RESULTS (ABOVE 1000 MHZ)

Remark:

- (1) All readings are Peak unless otherwise stated QP in column of 『Note 』 . Peak denotes that the Peak reading compliance with the QP Limits and then QP Mode measurement didn't perform.
- (2) Measuring frequency range from 30MHz to 1000MHz or the 10th harmonic of highest fundamental frequency. "F" denotes fundamental frequency; "H" denotes spurious frequency; "E" denotes band edge frequency. (This judgment method includes the Band Edge Requirement.)
- (3) Radiated emissions measured in frequency range above 1000MHz were made with an instrument using Peak detector mode and AV detector mode of the emission.
- (4) Data of measurement within this frequency range shown " * " in the table above means the reading of emissions are attenuated more than 20dB below the permissible limits or the field strength is too small to be measured.
- (5) A preamp and high pass filter were used for this test in order to provide sufficient measurement sensitivity.
- (6) EUT Orthogonal Axis:
"X" - denotes Laid on Table; "Y" - denotes Vertical Stand; "Z" - denotes Side Stand
- (7) During the measurements above 1 GHz it is taken care of that the EUT is always within the 3 dB cone of radiation BW of the used antenna



Test Mode : TX B MODE 2412MHz

Freq. (MHz)	Ant.Pol. H/V	Reading		Ant./CF CF(dB)	Act.		Limit		Note
		Peak (dBuV)	AV (dBuV)		Peak (dBuV/m)	AV (dBuV/m)	Peak (dBuV/m)	AV (dBuV/m)	
2390.00	V	23.46	14.02	34.09	57.55	48.11	74.00	54.00	X/E
2412.20	V	69.01	66.70	34.16	103.17	100.86			X/F
4824.03	V	49.57	46.31	6.43	56.00	52.74	74.00	54.00	X/H

Freq. (MHz)	Ant.Pol. H/V	Reading		Ant./CF CF(dB)	Act.		Limit		Note
		Peak (dBuV)	AV (dBuV)		Peak (dBuV/m)	AV (dBuV/m)	Peak (dBuV/m)	AV (dBuV/m)	
2390.00	H	23.09	13.97	34.09	57.18	48.06	74.00	54.00	X/E
2411.20	H	69.02	66.77	34.16	103.18	100.93			X/F
4824.02	H	48.77	46.13	6.43	55.20	52.56	74.00	54.00	X/H

Test Mode : TX B MODE 2437MHz

Freq. (MHz)	Ant.Pol. H/V	Reading		Ant./CF CF(dB)	Act.		Limit		Note
		Peak (dBuV)	AV (dBuV)		Peak (dBuV/m)	AV (dBuV/m)	Peak (dBuV/m)	AV (dBuV/m)	
2436.20	V	66.94	64.78	34.23	101.17	99.01			X/F
4873.59	V	48.69	45.31	6.58	55.27	51.89	74.00	54.00	X/H

Freq. (MHz)	Ant.Pol. H/V	Reading		Ant./CF CF(dB)	Act.		Limit		Note
		Peak (dBuV)	AV (dBuV)		Peak (dBuV/m)	AV (dBuV/m)	Peak (dBuV/m)	AV (dBuV/m)	
2438.00	H	67.71	65.44	34.23	101.94	99.67			X/F
4874.37	H	47.62	44.58	6.58	54.20	51.16	74.00	54.00	X/H

Test Mode : TX B MODE 2462MHz

Freq. (MHz)	Ant.Pol. H/V	Reading		Ant./CF CF(dB)	Act.		Limit		Note
		Peak (dBuV)	AV (dBuV)		Peak (dBuV/m)	AV (dBuV/m)	Peak (dBuV/m)	AV (dBuV/m)	
2463.00	V	66.59	64.08	34.31	100.90	98.39			X/F
2483.50	V	23.05	13.51	34.37	57.42	47.88	74.00	54.00	X/E
4924.21	V	48.28	44.72	6.72	55.00	51.44	74.00	54.00	X/H

Freq. (MHz)	Ant.Pol. H/V	Reading		Ant./CF CF(dB)	Act.		Limit		Note
		Peak (dBuV)	AV (dBuV)		Peak (dBuV/m)	AV (dBuV/m)	Peak (dBuV/m)	AV (dBuV/m)	
2463.00	H	66.52	63.70	34.31	100.83	98.01			X/F
2483.50	H	24.10	13.51	34.37	58.47	47.88	74.00	54.00	X/E
4924.31	H	47.48	44.11	6.72	54.20	50.83	74.00	54.00	X/H



TX CH01 (Above 1000 MHz, Vertical)

120.0 dBuV/m

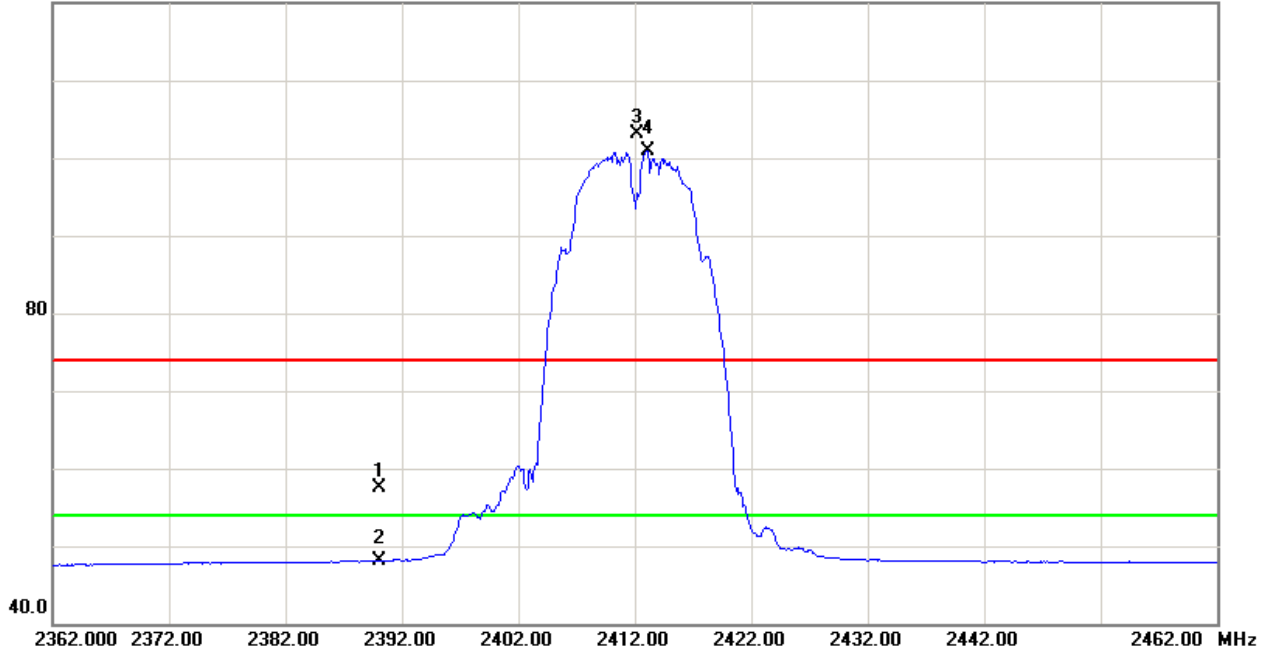

80.0 dBuV/m

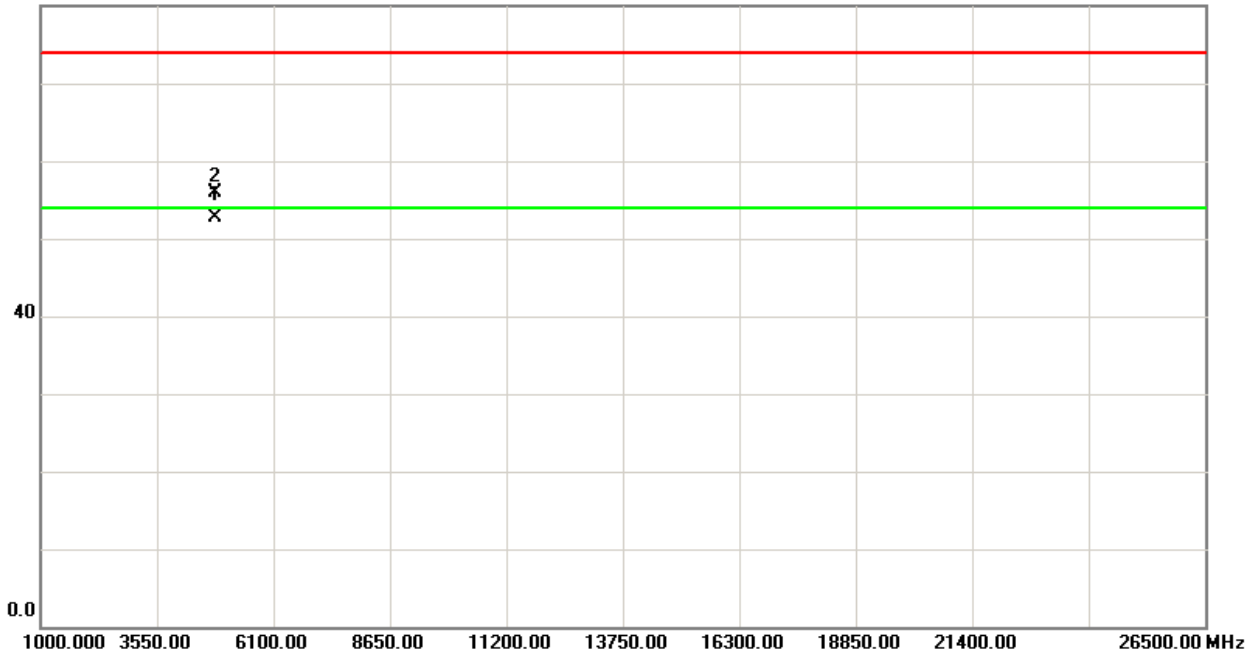



TX CH01 (Above 1000 MHz, Horizontal)

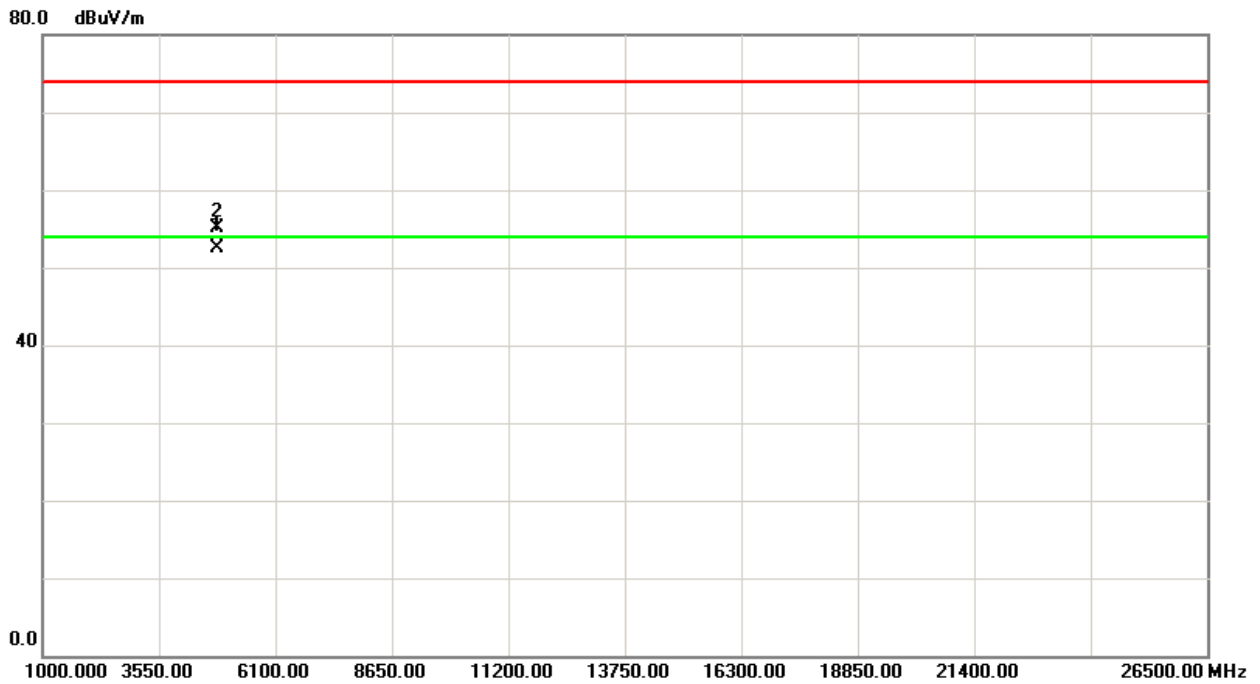
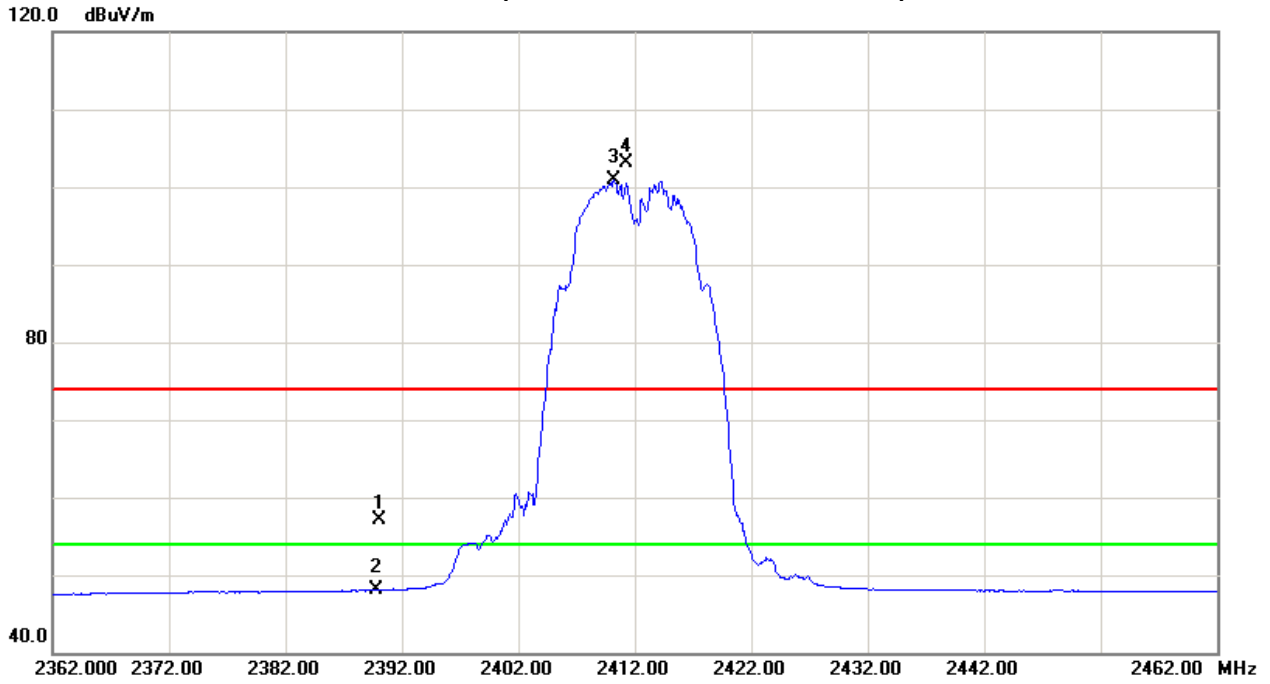



TX CH06 (Above 1000 MHz, Vertical)

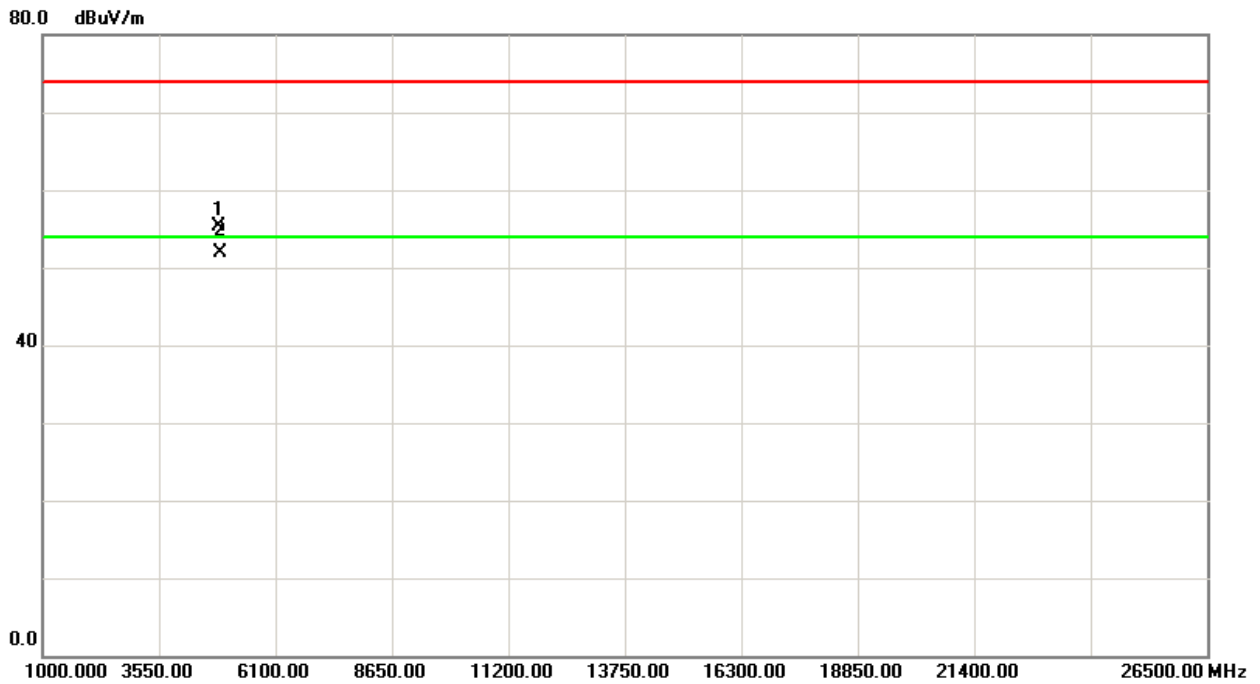
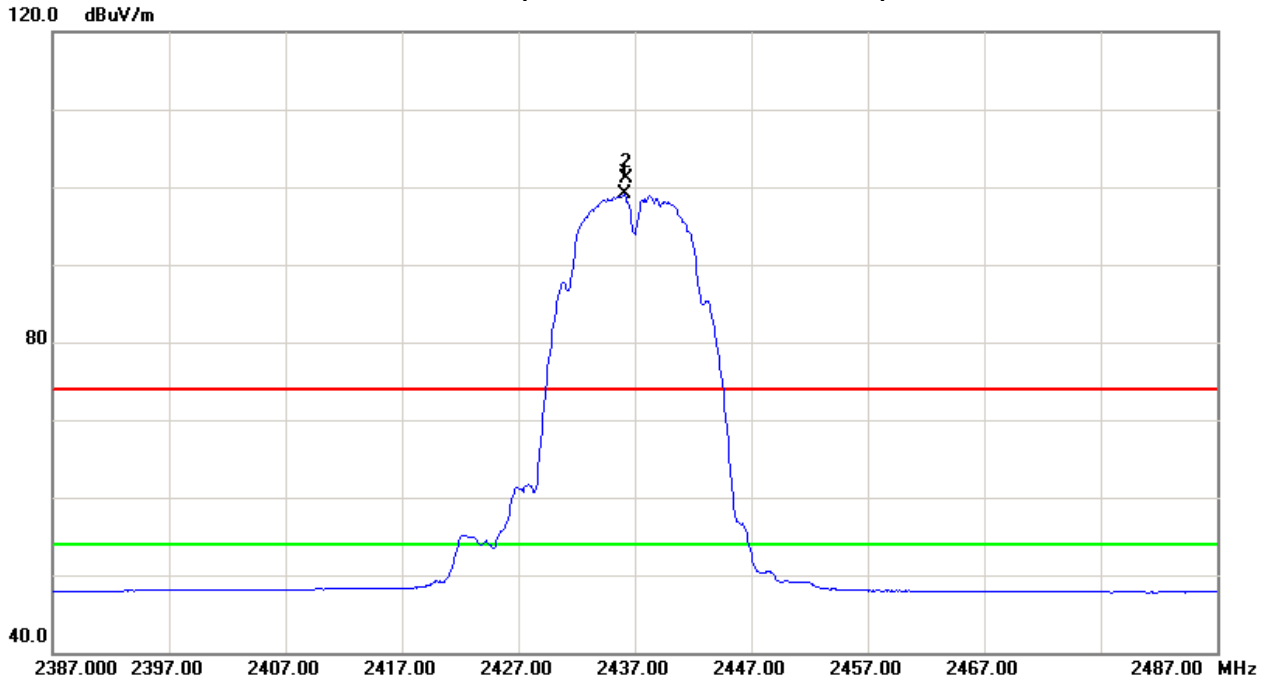



TX CH06 (Above 1000 MHz, Horizontal)

120.0 dBuV/m

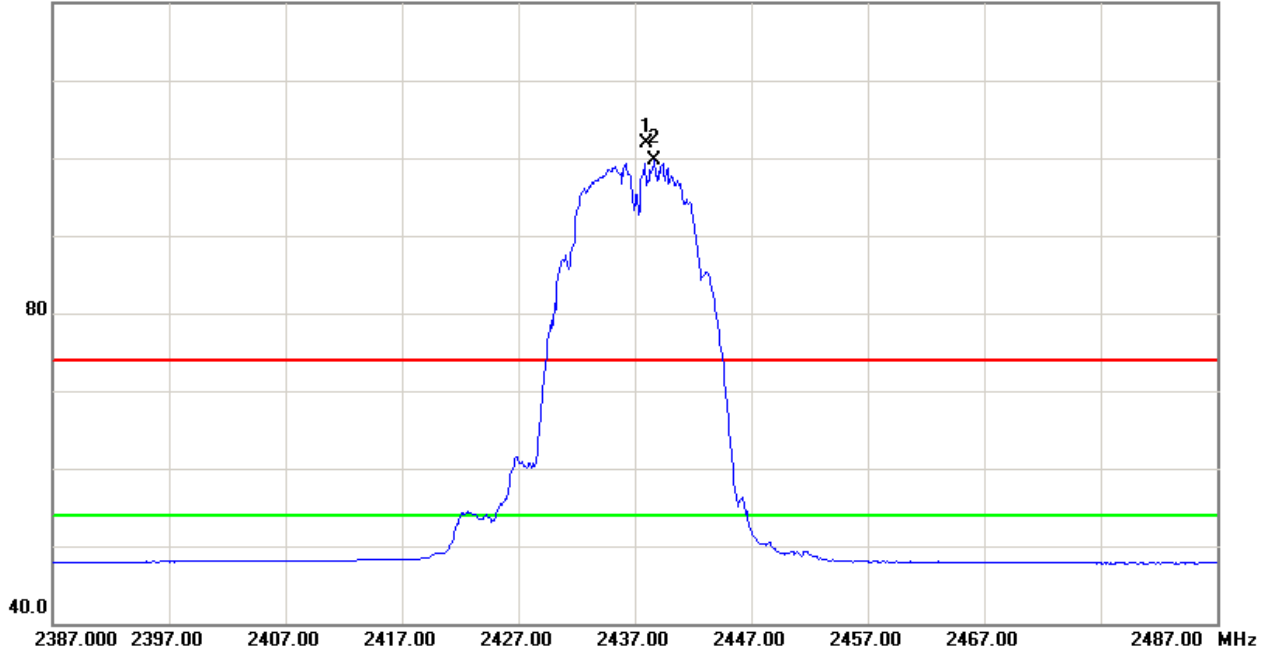

80.0 dBuV/m

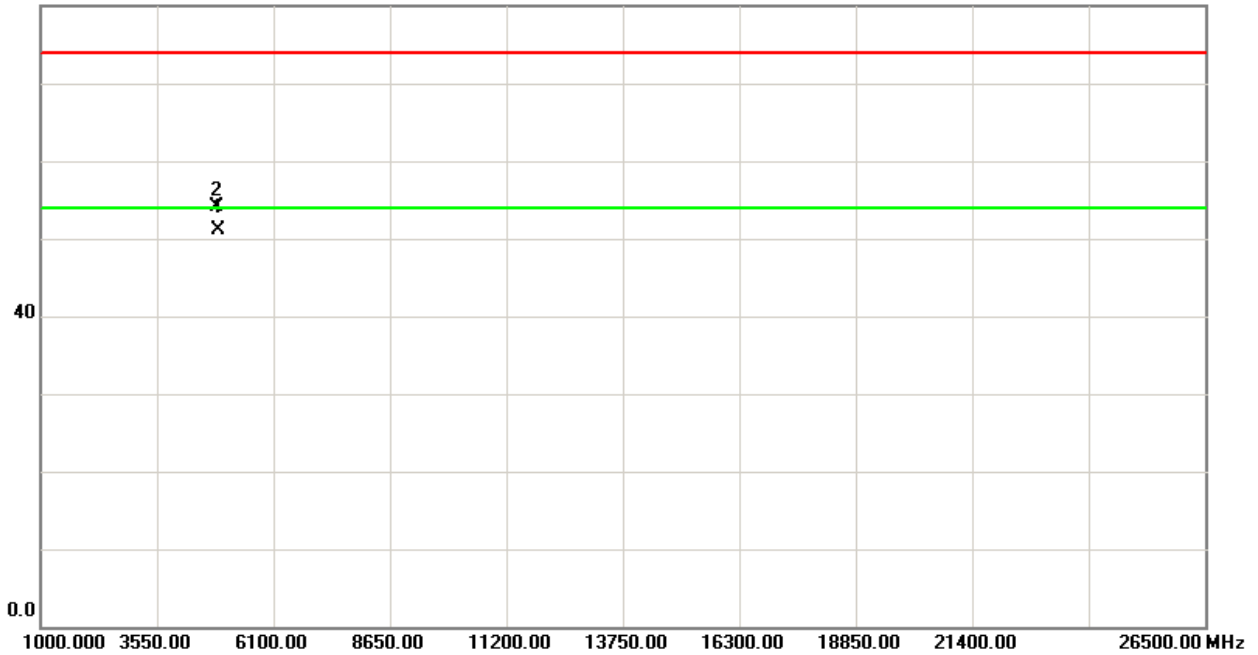



TX CH11 (Above 1000 MHz, Vertical)

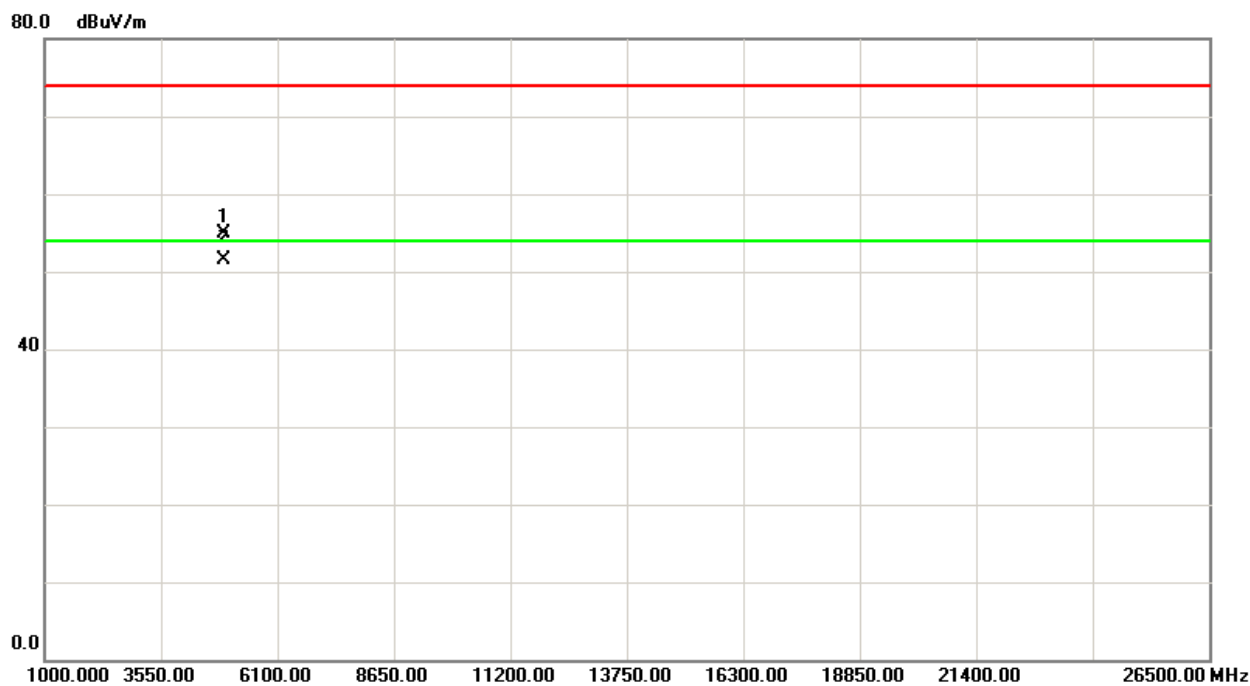
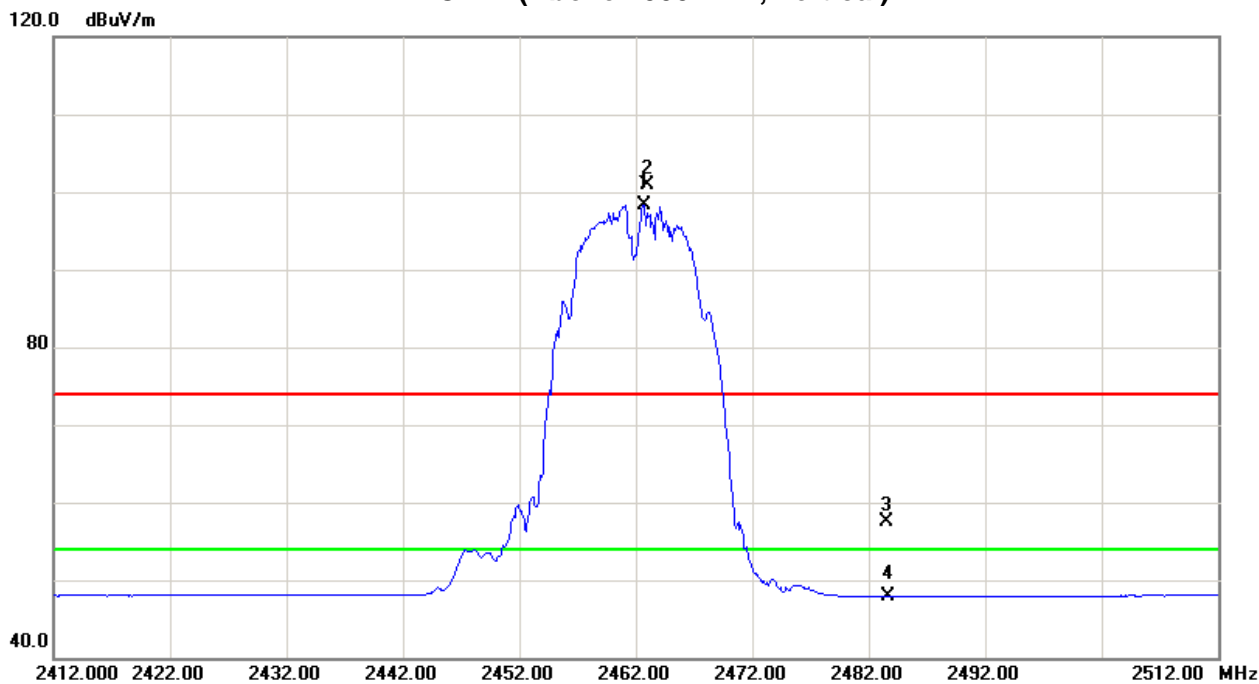



TX CH11 (Above 1000 MHz, Horizontal)

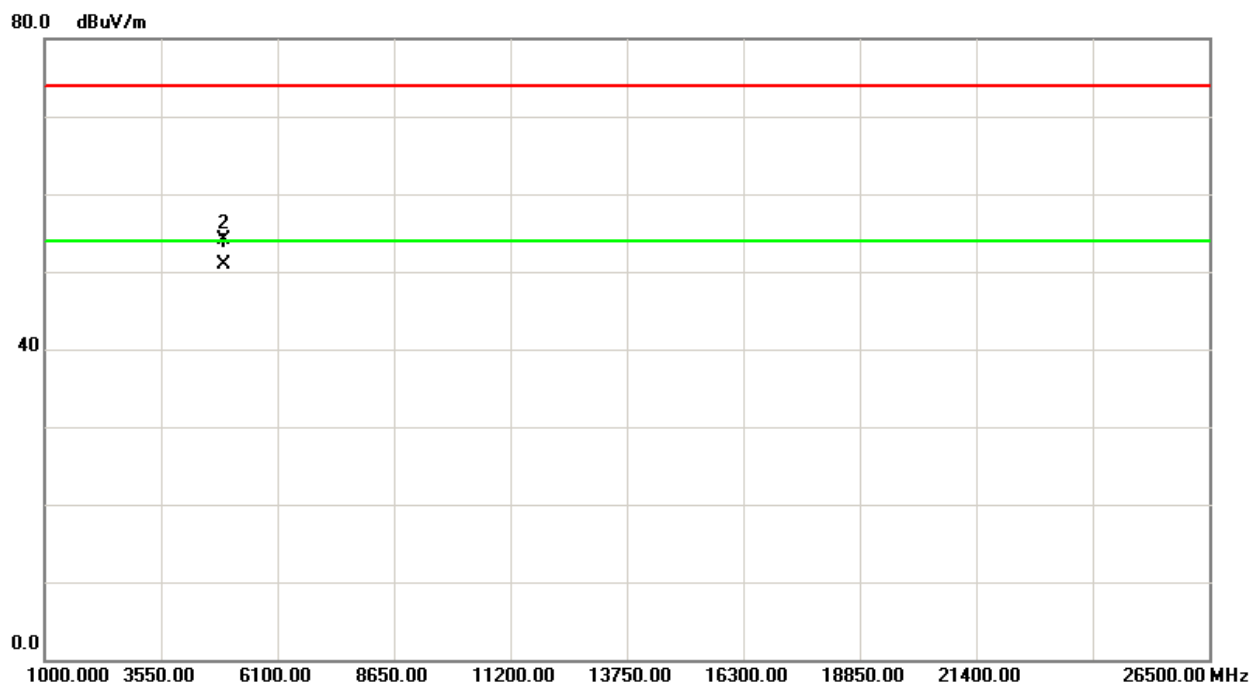
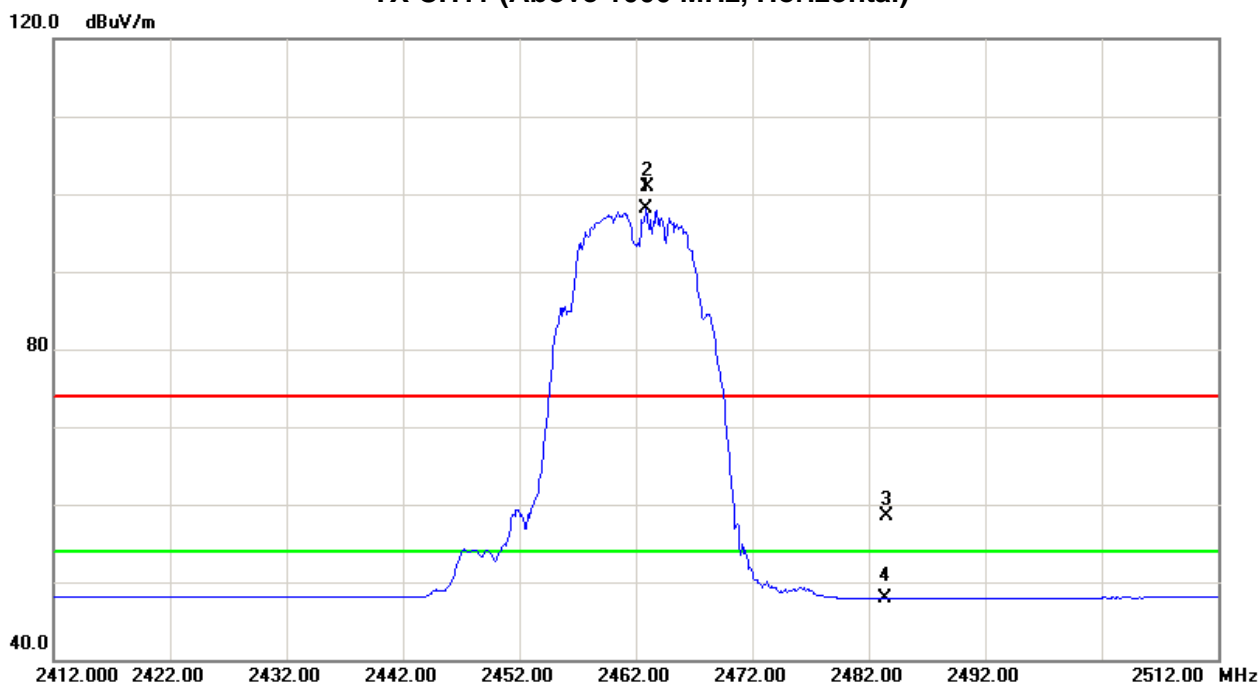



Test Mode : TX G MODE 2412MHz

Freq.	Ant.Pol.	Reading		Ant./CF	Act.		Limit		Note
		Peak	AV		Peak	AV	Peak	AV	
(MHz)	H/V	(dBuV)	(dBuV)	CF(dB)	(dBuV/m)	(dBuV/m)	(dBuV/m)	(dBuV/m)	
2390.00	V	27.14	16.88	34.09	61.23	50.97	74.00	54.00	X/E
2404.50	V	73.30	63.19	34.14	107.44	97.33			X/F
4824.25	V	47.71	42.31	6.43	54.14	48.74	74.00	54.00	X/H

Freq.	Ant.Pol.	Reading		Ant./CF	Act.		Limit		Note
		Peak	AV		Peak	AV	Peak	AV	
(MHz)	H/V	(dBuV)	(dBuV)	CF(dB)	(dBuV/m)	(dBuV/m)	(dBuV/m)	(dBuV/m)	
2390.00	H	26.76	16.92	34.09	60.85	51.01	74.00	54.00	X/E
2404.50	H	72.97	63.49	34.14	107.11	97.63			X/F
4824.23	H	47.21	41.31	6.43	53.64	47.74	74.00	54.00	X/H

Test Mode : TX G MODE 2437MHz

Freq.	Ant.Pol.	Reading		Ant./CF	Act.		Limit		Note
		Peak	AV		Peak	AV	Peak	AV	
(MHz)	H/V	(dBuV)	(dBuV)	CF(dB)	(dBuV/m)	(dBuV/m)	(dBuV/m)	(dBuV/m)	
2429.60	V	71.64	62.29	34.21	105.85	96.50			X/F
4874.33	V	47.22	41.86	6.58	53.80	48.44	74.00	54.00	X/H

Freq.	Ant.Pol.	Reading		Ant./CF	Act.		Limit		Note
		Peak	AV		Peak	AV	Peak	AV	
(MHz)	H/V	(dBuV)	(dBuV)	CF(dB)	(dBuV/m)	(dBuV/m)	(dBuV/m)	(dBuV/m)	
2432.20	H	71.26	62.08	34.22	105.48	96.30			X/F
4874.22	H	46.62	41.28	6.58	53.20	47.86	74.00	54.00	X/H

Test Mode : TX G MODE 2462MHz

Freq.	Ant.Pol.	Reading		Ant./CF	Act.		Limit		Note
		Peak	AV		Peak	AV	Peak	AV	
(MHz)	H/V	(dBuV)	(dBuV)	CF(dB)	(dBuV/m)	(dBuV/m)	(dBuV/m)	(dBuV/m)	
2454.90	V	69.65	60.38	34.29	103.94	94.67			X/F
2483.50	V	27.16	15.40	34.37	61.53	49.77	74.00	54.00	X/E
4924.35	V	47.28	42.02	6.72	54.00	48.74	74.00	54.00	X/H

Freq.	Ant.Pol.	Reading		Ant./CF	Act.		Limit		Note
		Peak	AV		Peak	AV	Peak	AV	
(MHz)	H/V	(dBuV)	(dBuV)	CF(dB)	(dBuV/m)	(dBuV/m)	(dBuV/m)	(dBuV/m)	
2455.10	H	68.12	60.35	34.29	102.41	94.64			X/F
2483.50	H	25.21	15.34	34.37	59.58	49.71	74.00	54.00	X/E
4924.28	H	46.48	41.34	6.72	53.20	48.06	74.00	54.00	X/H



TX CH01 (Above 1000 MHz, Vertical)

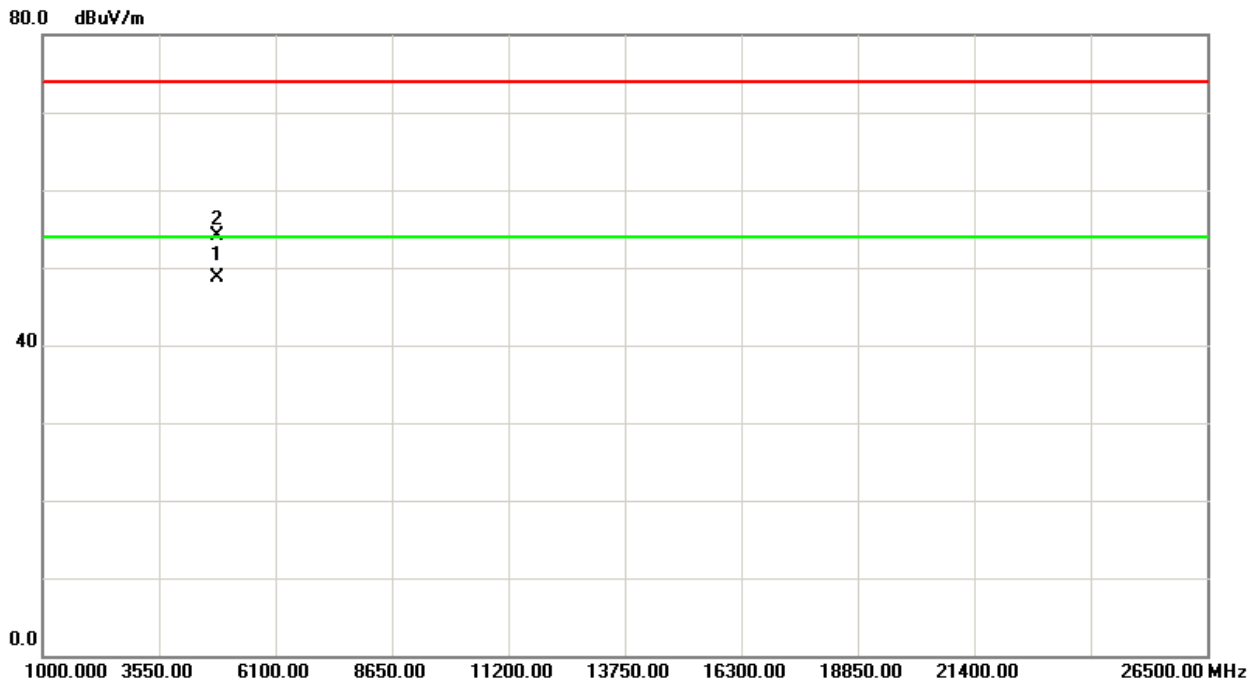
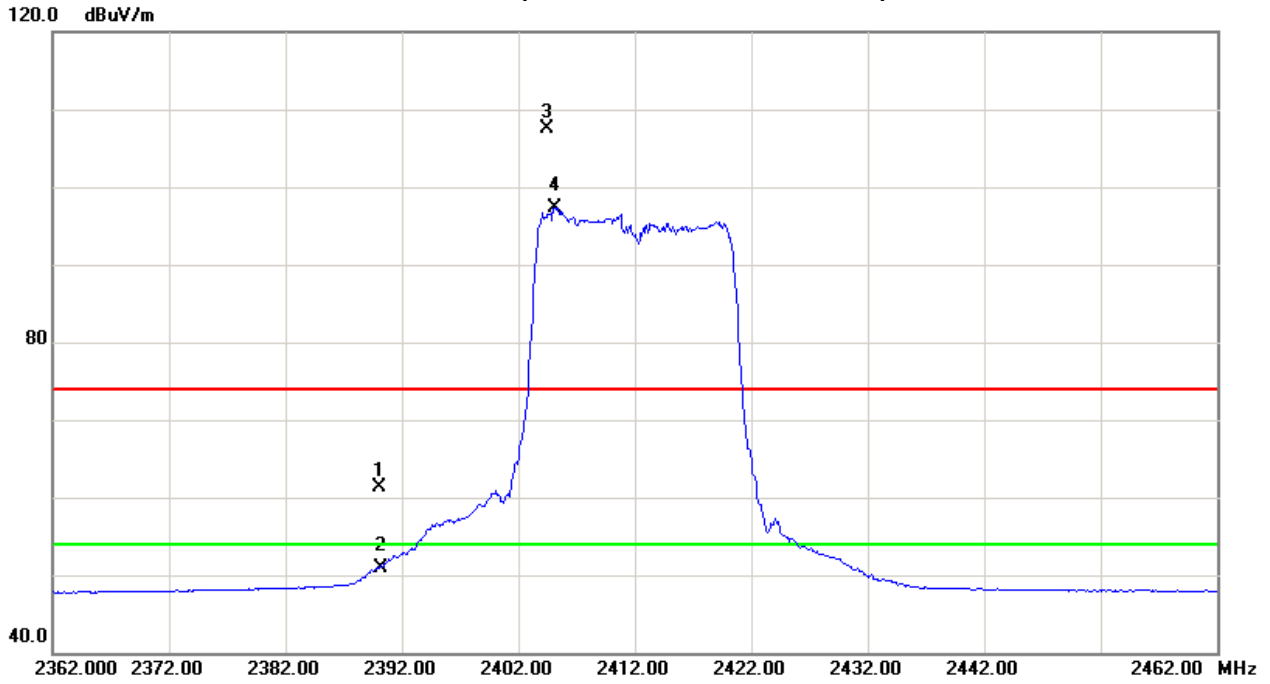



TX CH01 (Above 1000 MHz, Horizontal)

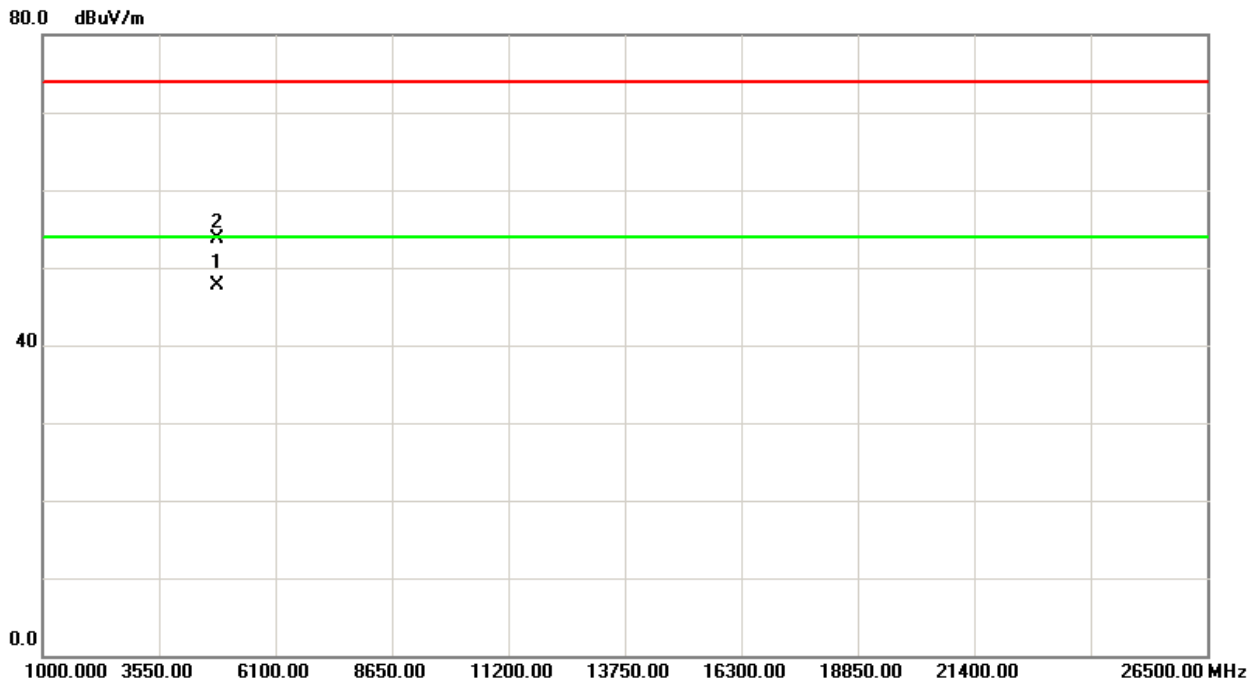
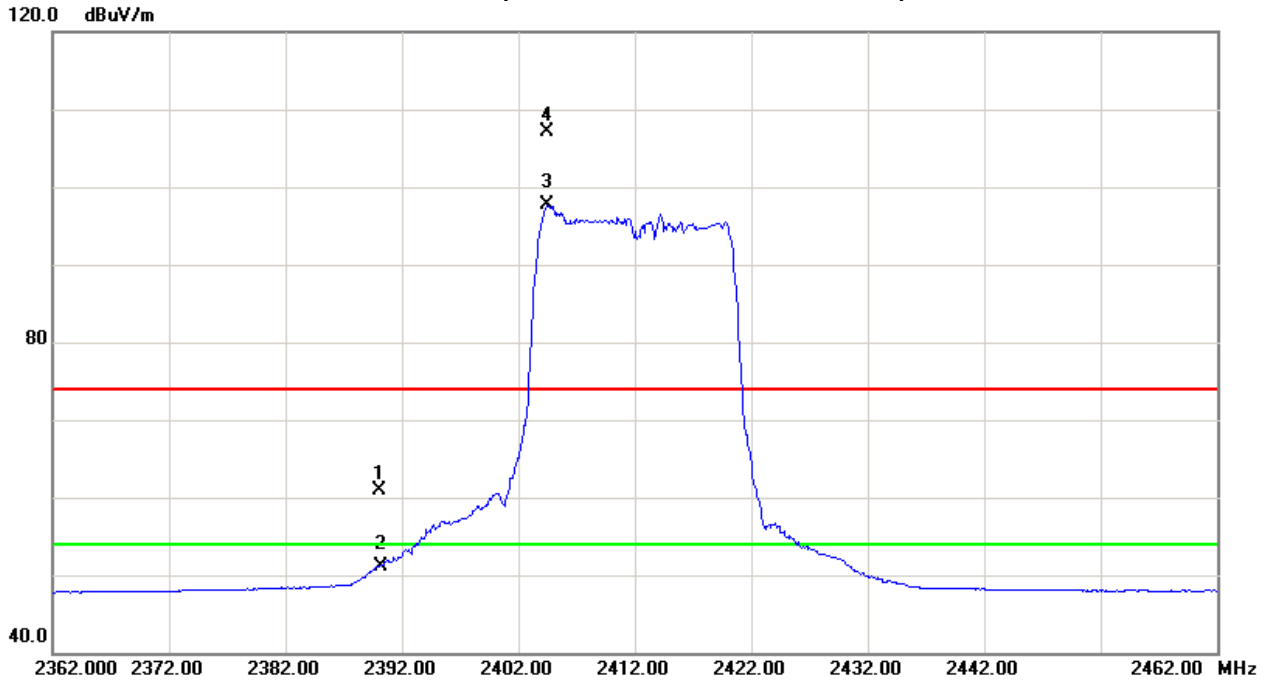



TX CH06 (Above 1000 MHz, Vertical)

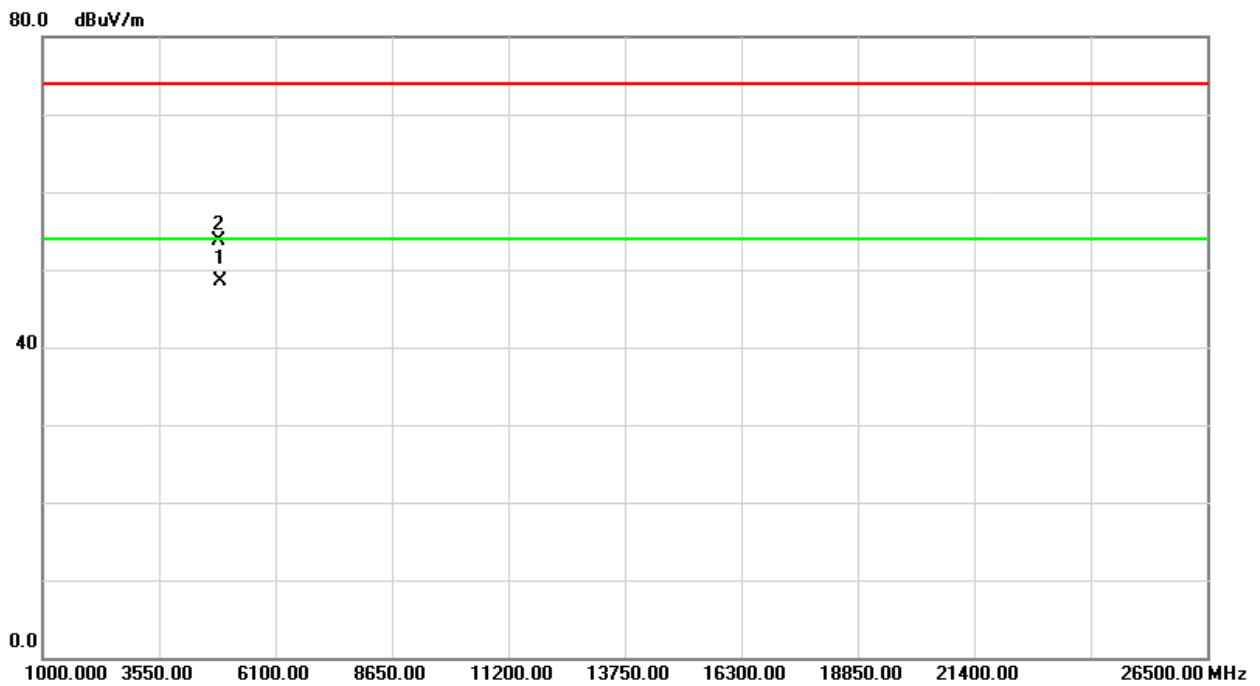
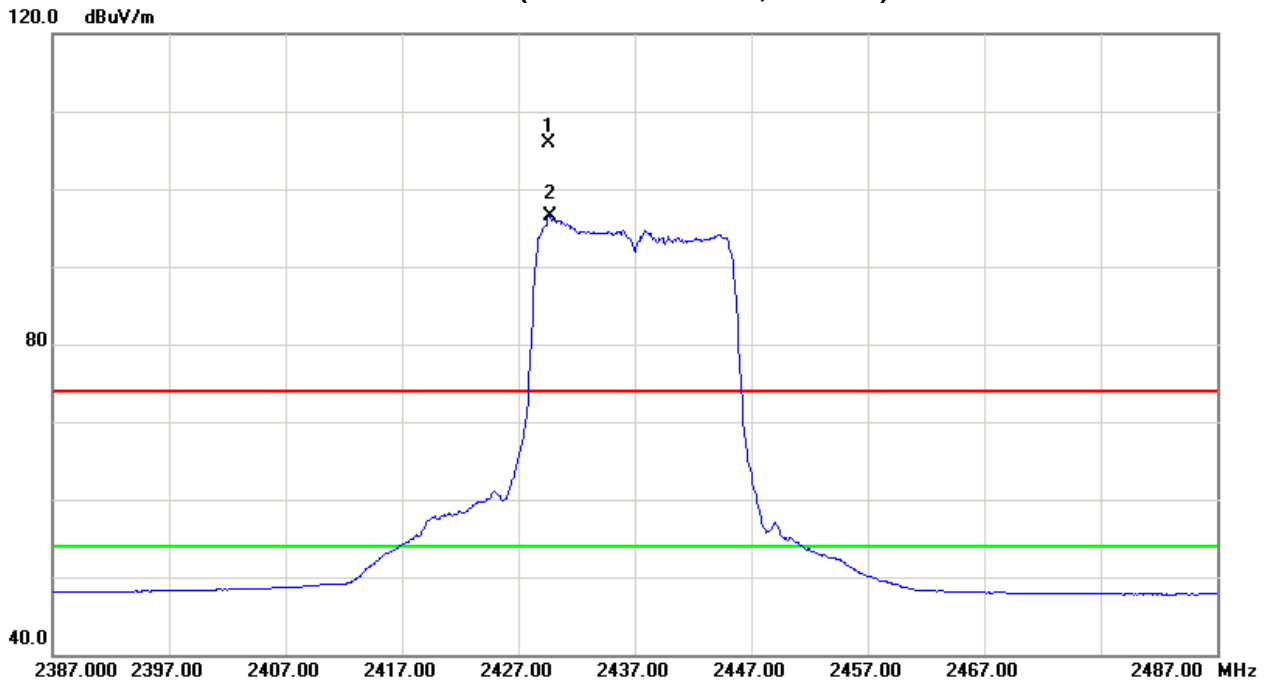



TX CH06 (Above 1000 MHz, Horizontal)

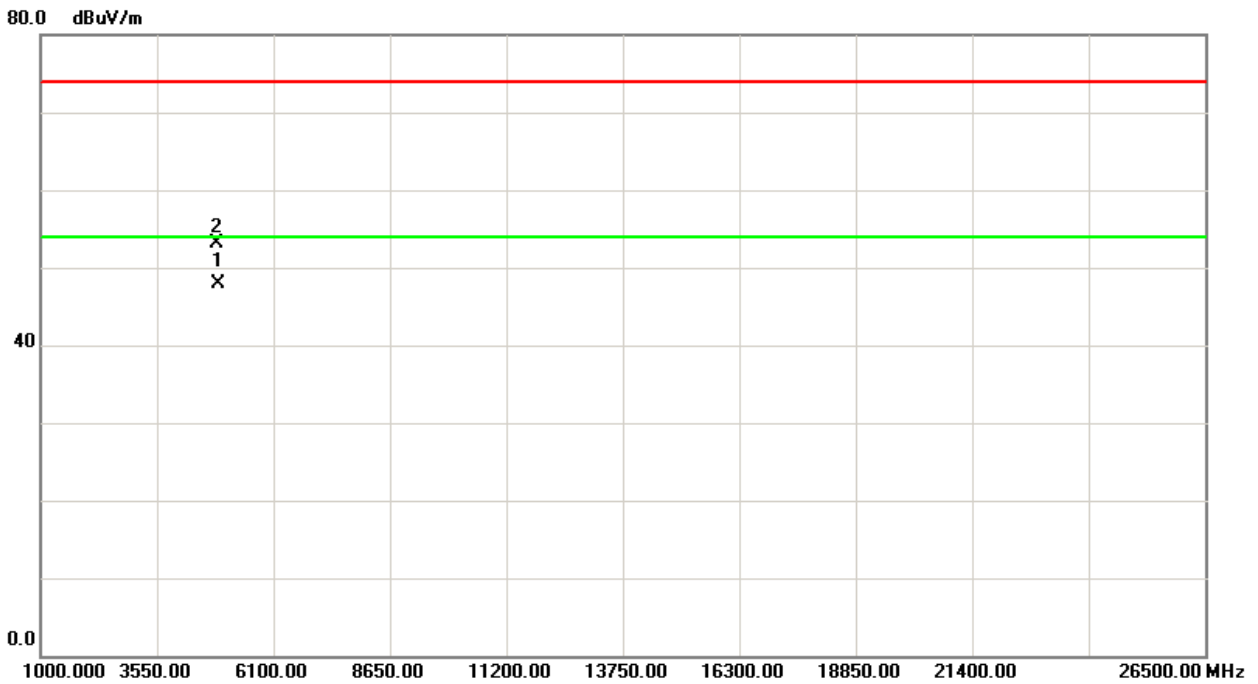
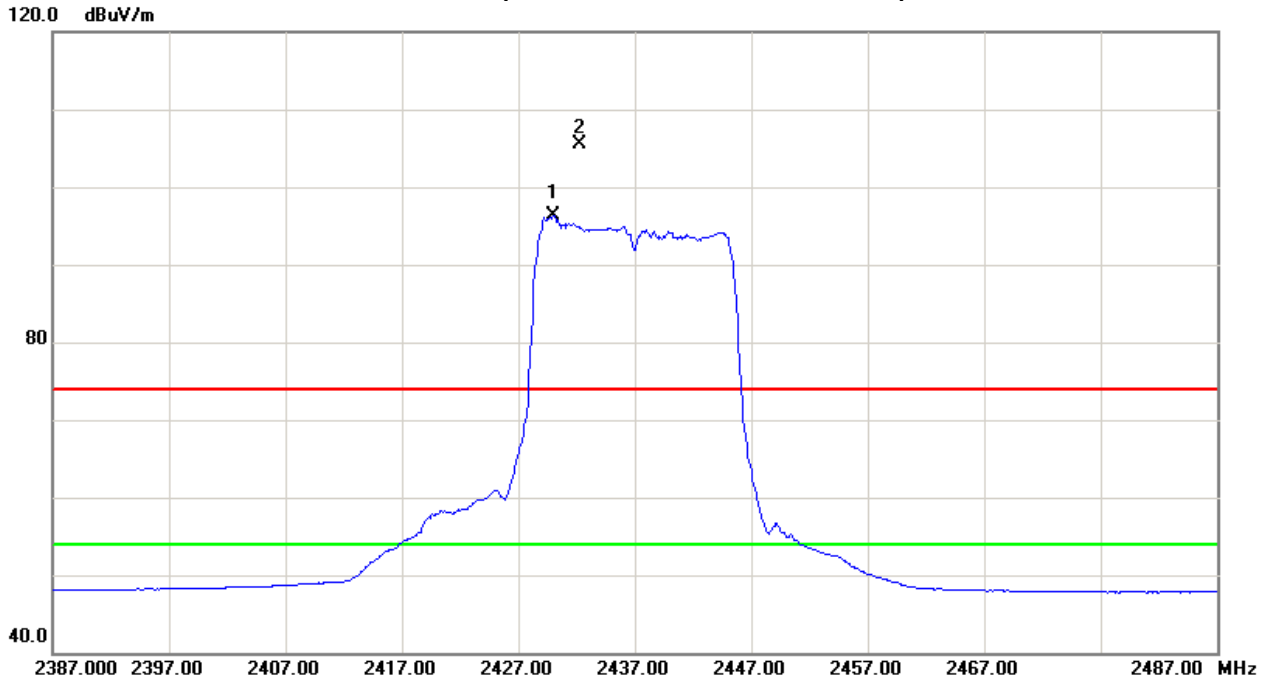



TX CH11 (Above 1000 MHz, Vertical)

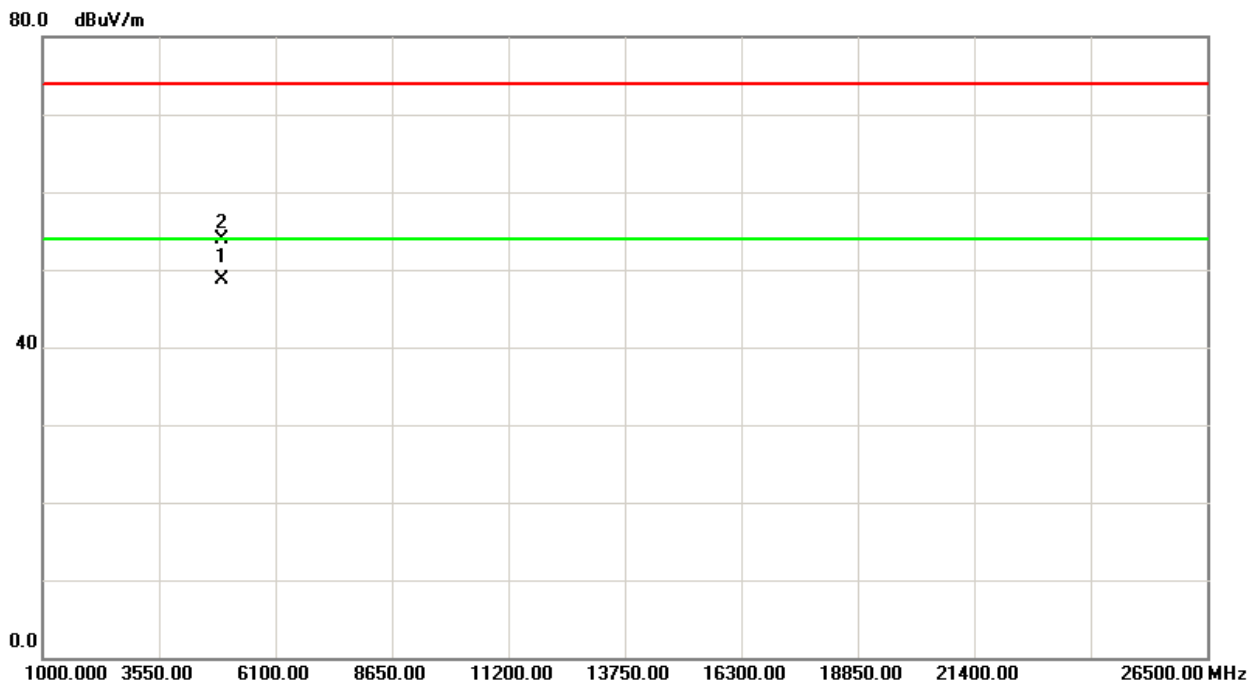
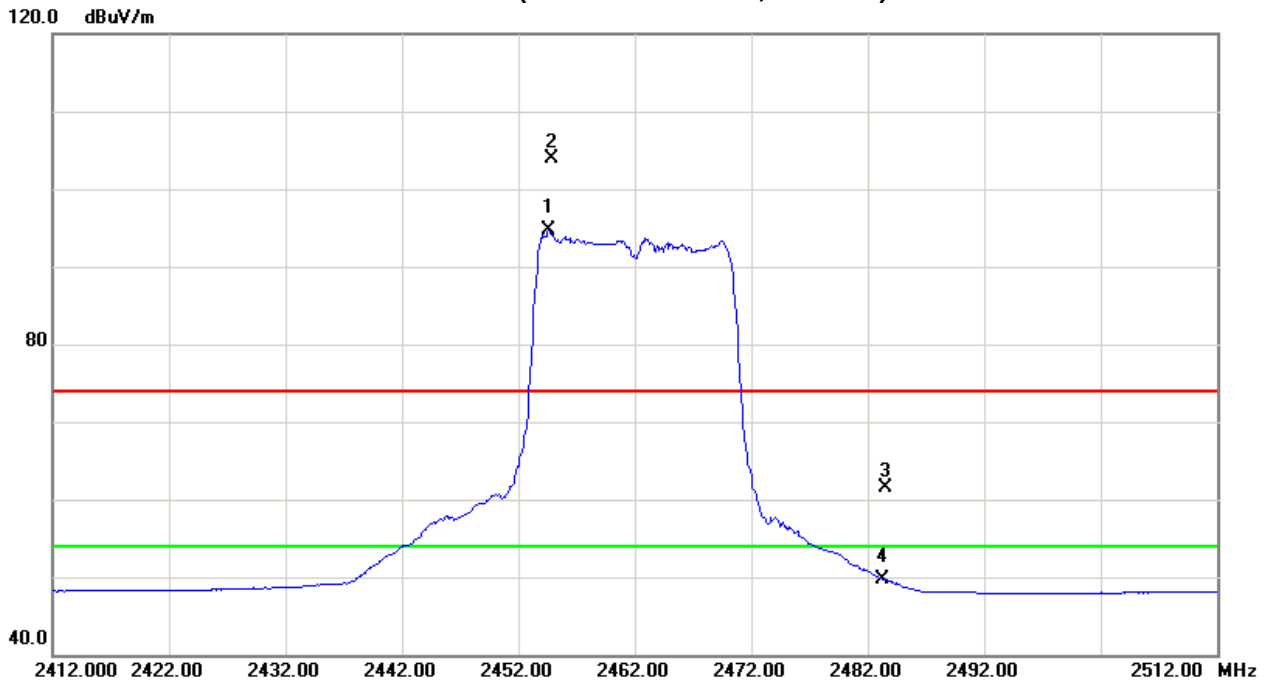



TX CH11 (Above 1000 MHz, Horizontal)

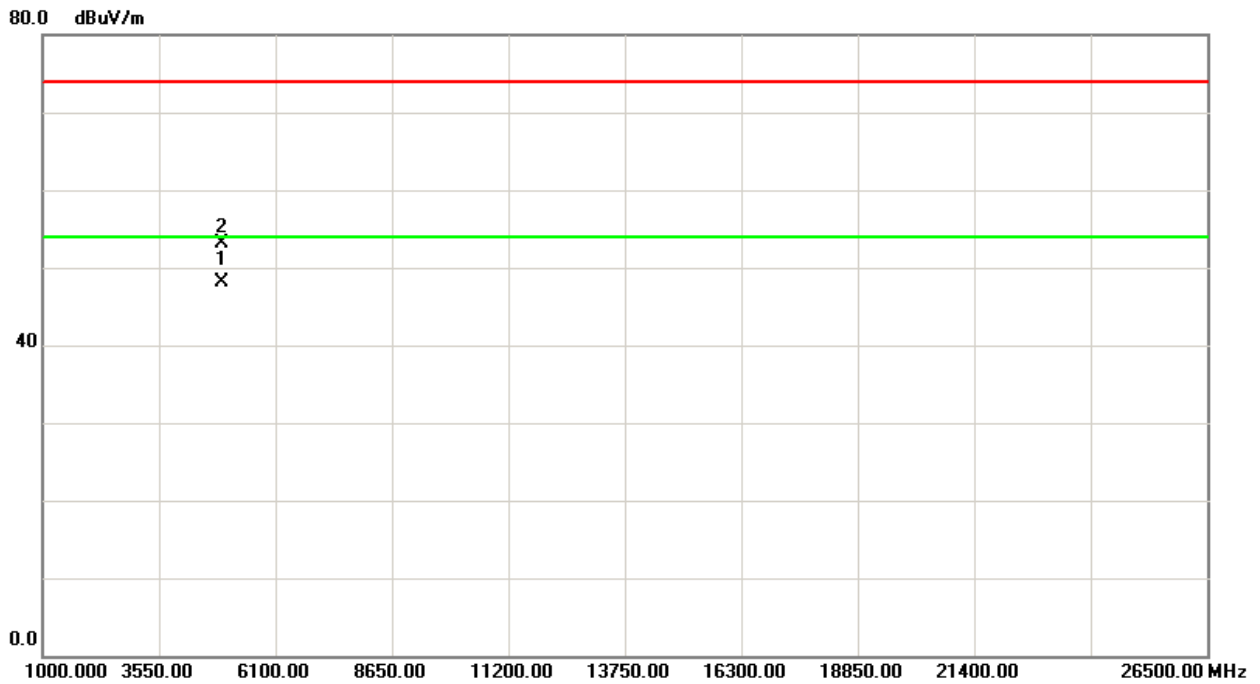
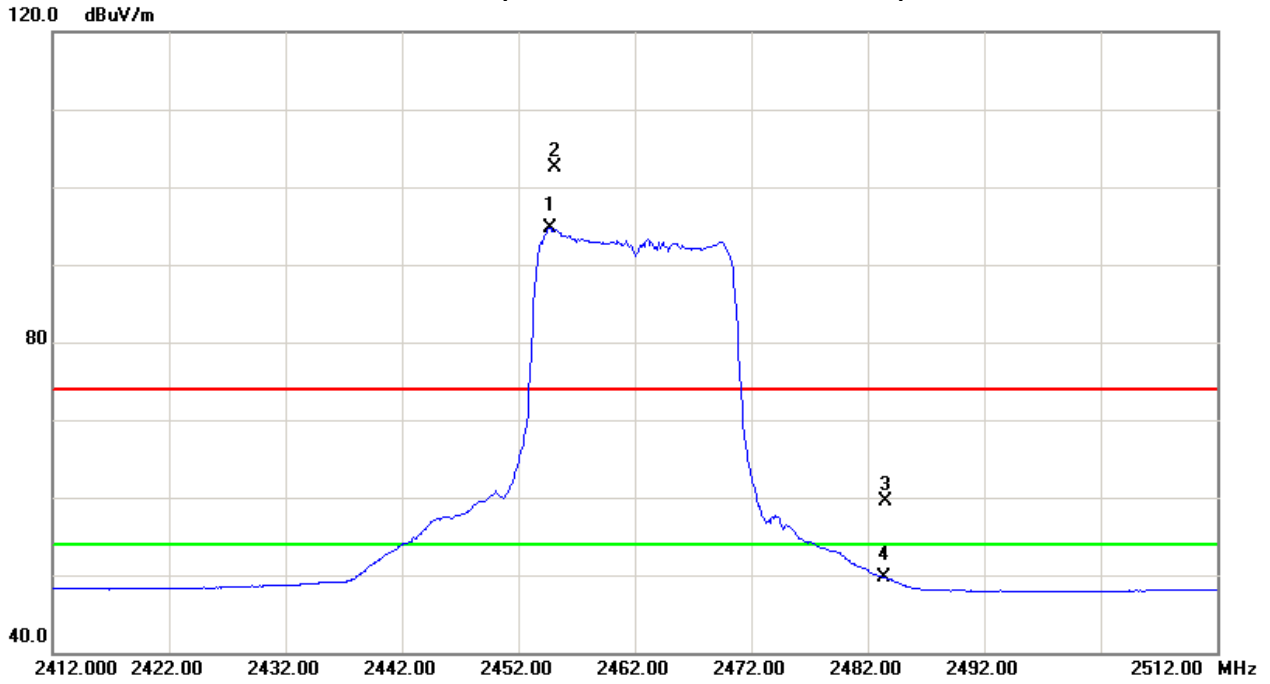



Test Mode : TX N-20M MODE 2412MHz

Freq.	Ant.Pol.	Reading		Ant./CF	Act.		Limit		Note
		Peak	AV		Peak	AV	Peak	AV	
(MHz)	H/V	(dBuV)	(dBuV)	CF(dB)	(dBuV/m)	(dBuV/m)	(dBuV/m)	(dBuV/m)	
2390.00	V	30.83	17.89	34.09	64.92	51.98	74.00	54.00	X/E
2404.60	V	71.53	61.57	34.14	105.67	95.71			X/F
4824.01	V	48.52	42.31	6.43	54.95	48.74	74.00	54.00	X/H

Freq.	Ant.Pol.	Reading		Ant./CF	Act.		Limit		Note
		Peak	AV		Peak	AV	Peak	AV	
(MHz)	H/V	(dBuV)	(dBuV)	CF(dB)	(dBuV/m)	(dBuV/m)	(dBuV/m)	(dBuV/m)	
2390.00	H	29.46	17.61	34.09	63.55	51.70	74.00	54.00	X/E
2404.60	H	71.63	61.38	34.14	105.77	95.52			X/F
4824.14	H	47.77	41.13	6.43	54.20	47.56	74.00	54.00	X/H

Test Mode : TX N-20M MODE 2437MHz

Freq.	Ant.Pol.	Reading		Ant./CF	Act.		Limit		Note
		Peak	AV		Peak	AV	Peak	AV	
(MHz)	H/V	(dBuV)	(dBuV)	CF(dB)	(dBuV/m)	(dBuV/m)	(dBuV/m)	(dBuV/m)	
2430.00	V	69.68	60.47	34.21	103.89	94.68			X/F
4873.99	V	47.41	41.16	6.58	53.99	47.74	74.00	54.00	X/H

Freq.	Ant.Pol.	Reading		Ant./CF	Act.		Limit		Note
		Peak	AV		Peak	AV	Peak	AV	
(MHz)	H/V	(dBuV)	(dBuV)	CF(dB)	(dBuV/m)	(dBuV/m)	(dBuV/m)	(dBuV/m)	
2430.00	H	70.15	60.03	34.21	104.36	94.24			X/F
4874.26	H	47.32	40.98	6.58	53.90	47.56	74.00	54.00	X/H

Test Mode : TX N-20M MODE 2462MHz

Freq.	Ant.Pol.	Reading		Ant./CF	Act.		Limit		Note
		Peak	AV		Peak	AV	Peak	AV	
(MHz)	H/V	(dBuV)	(dBuV)	CF(dB)	(dBuV/m)	(dBuV/m)	(dBuV/m)	(dBuV/m)	
2455.20	V	68.78	58.69	34.29	103.07	92.98			X/F
2483.50	V	27.51	15.62	34.37	61.88	49.99	74.00	54.00	X/E
4923.79	V	47.81	42.02	6.72	54.53	48.74	74.00	54.00	X/H

Freq.	Ant.Pol.	Reading		Ant./CF	Act.		Limit		Note
		Peak	AV		Peak	AV	Peak	AV	
(MHz)	H/V	(dBuV)	(dBuV)	CF(dB)	(dBuV/m)	(dBuV/m)	(dBuV/m)	(dBuV/m)	
2458.10	H	69.01	59.28	34.29	103.30	93.57			X/F
2483.50	H	28.92	16.21	34.37	63.29	50.58	74.00	54.00	X/E
4924.16	H	46.48	40.84	6.72	53.20	47.56	74.00	54.00	X/H



TX CH01 (Above 1000 MHz, Vertical)

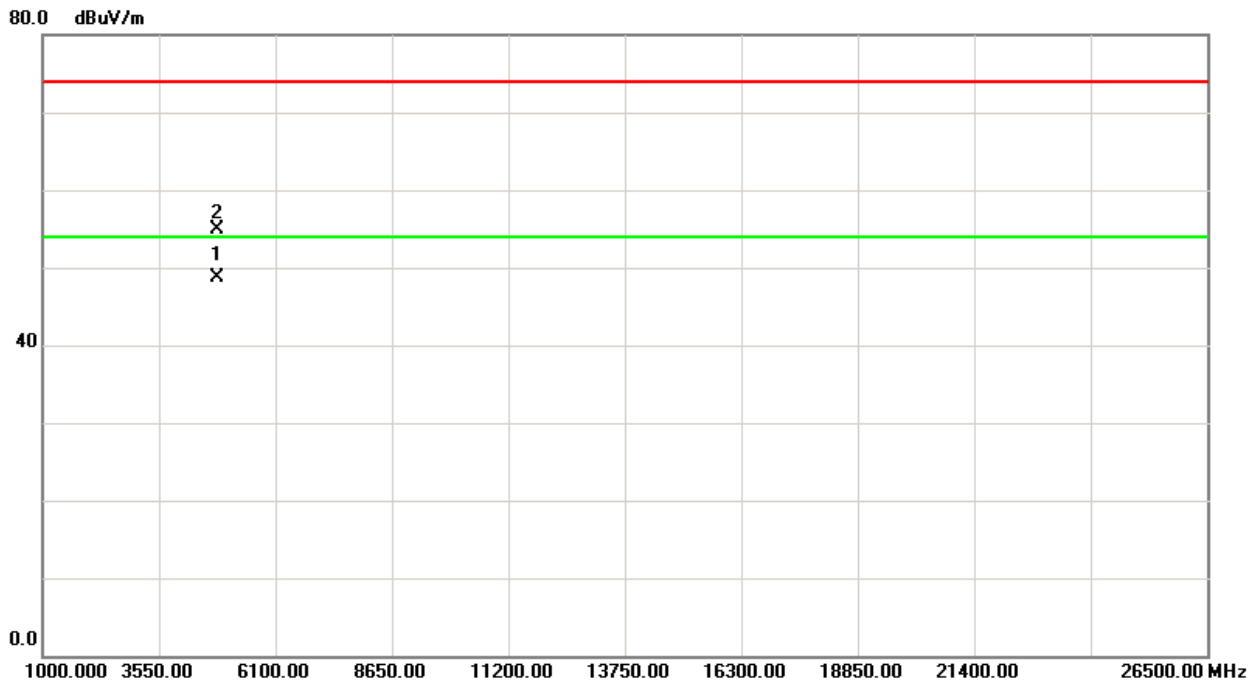
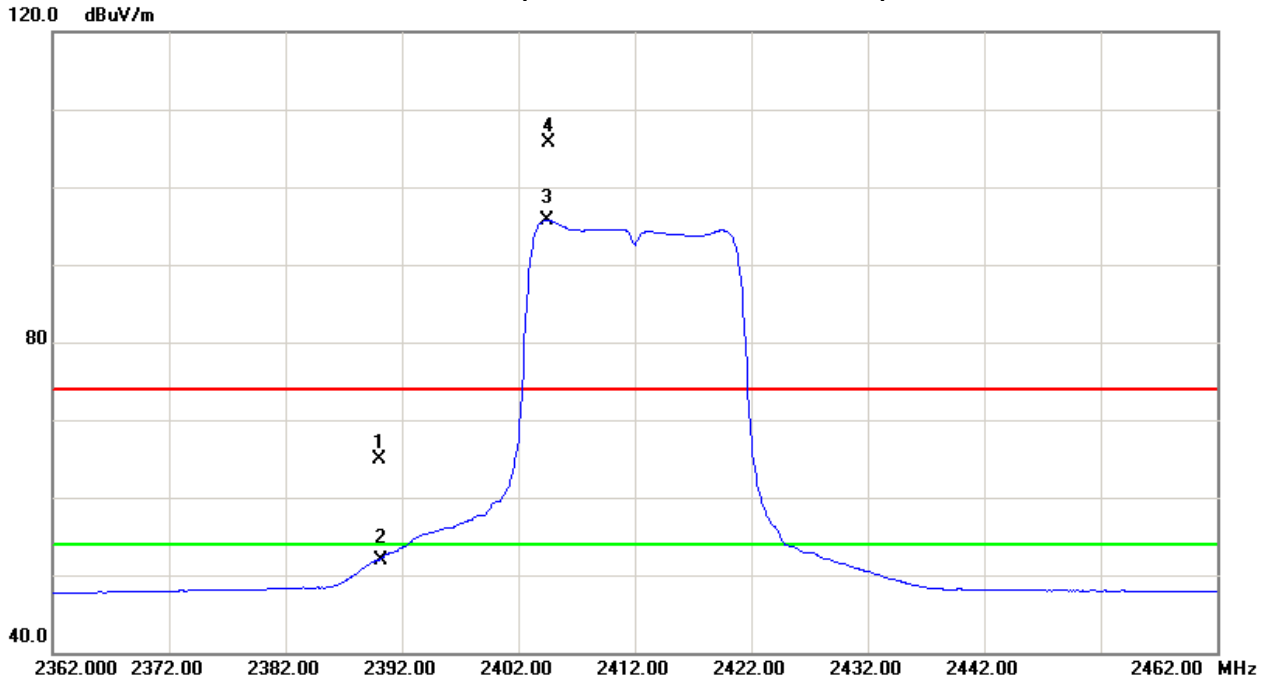



TX CH01 (Above 1000 MHz, Horizontal)

120.0 dBuV/m

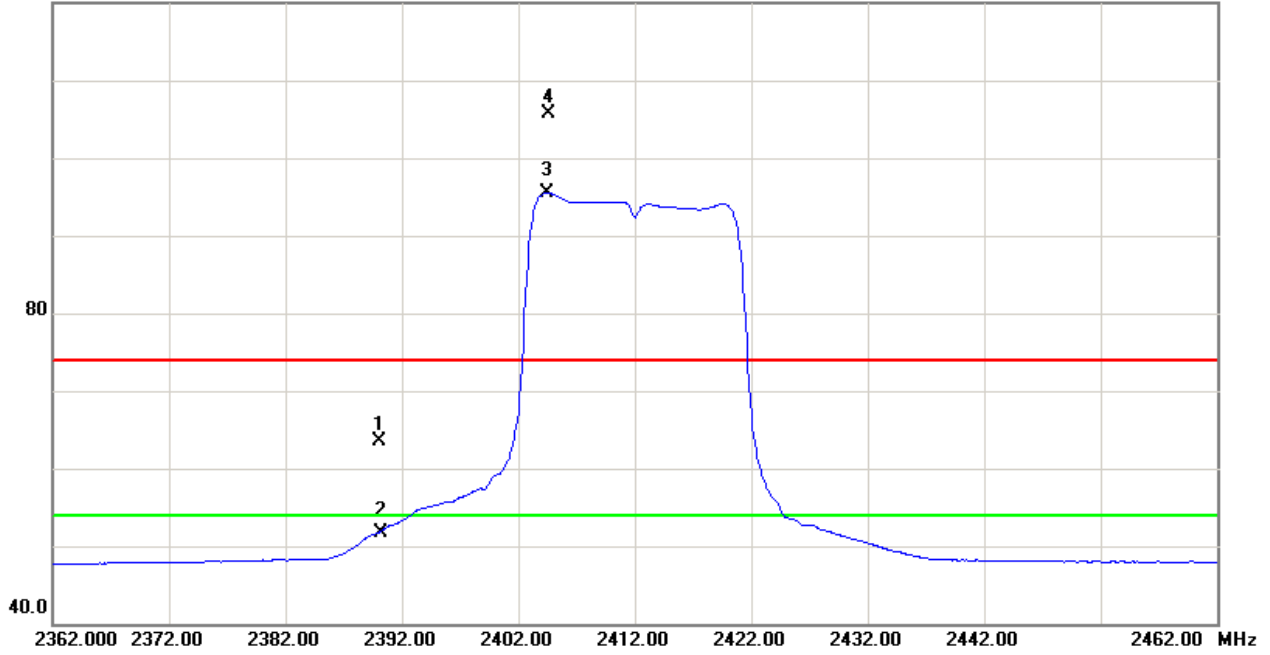

80.0 dBuV/m

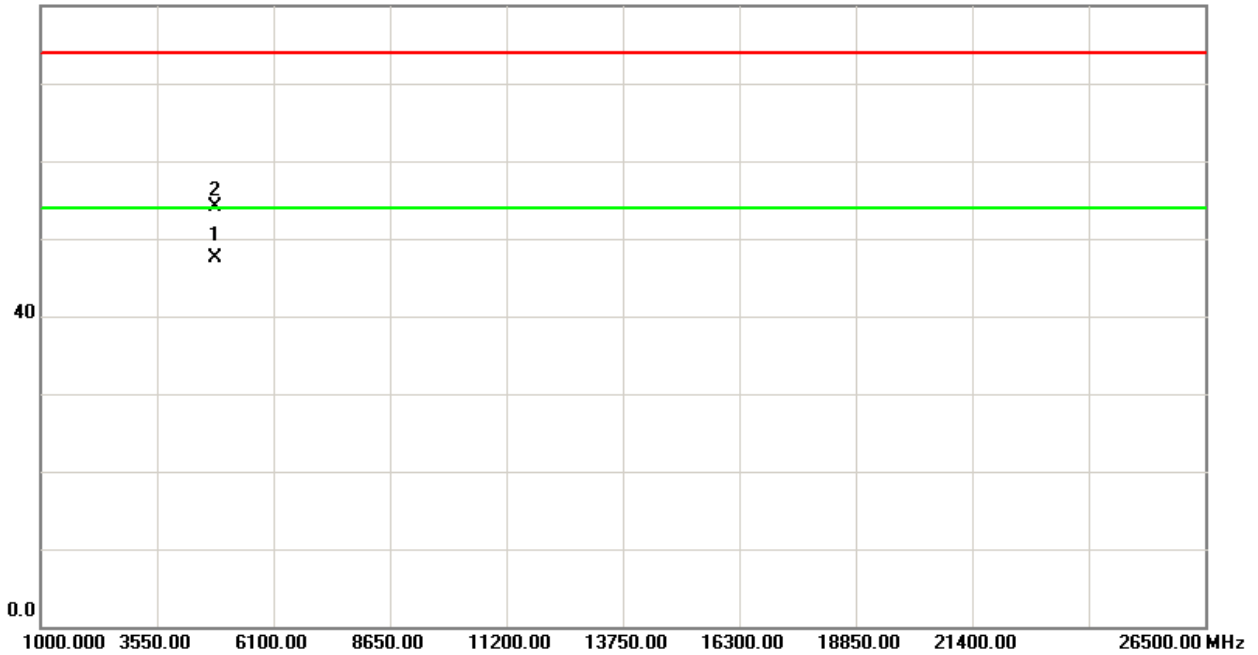



TX CH06 (Above 1000 MHz, Vertical)

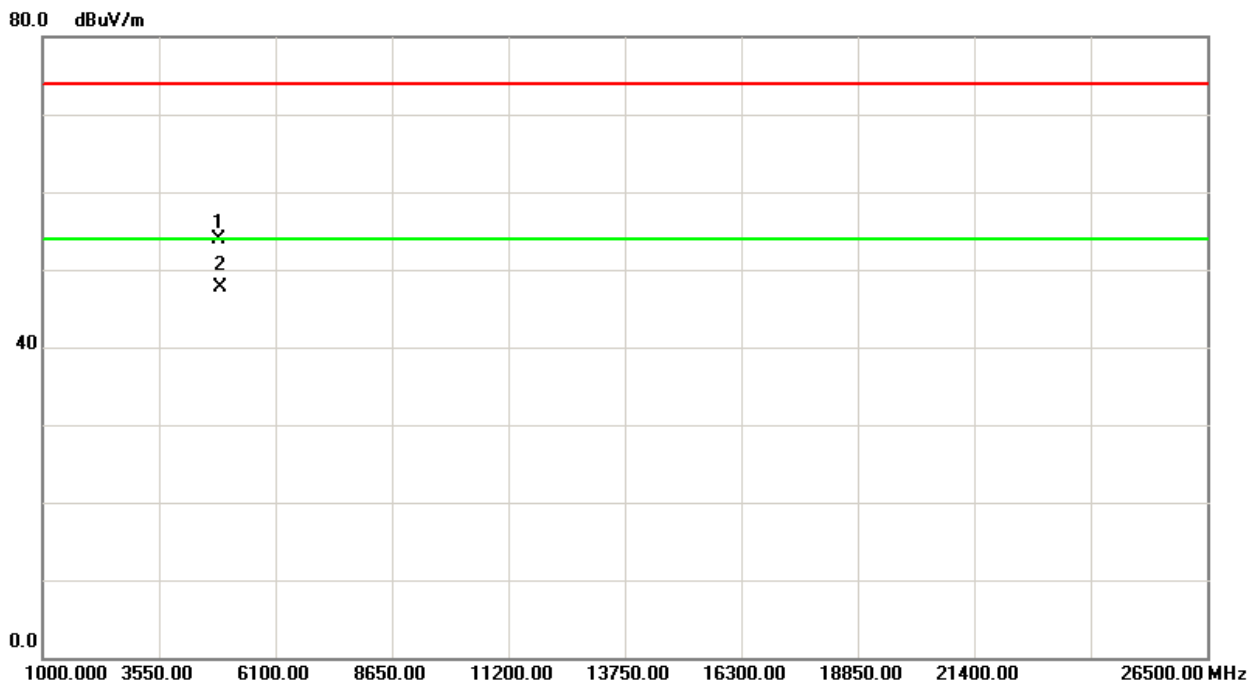
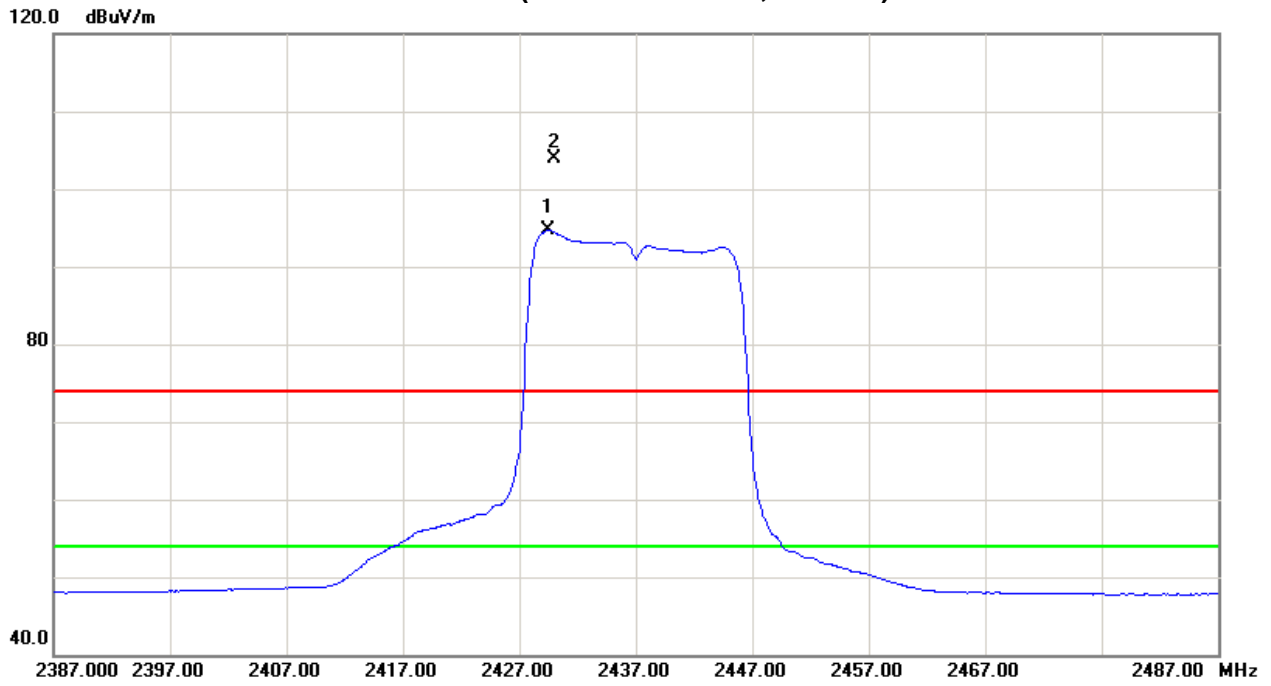



TX CH06 (Above 1000 MHz, Horizontal)

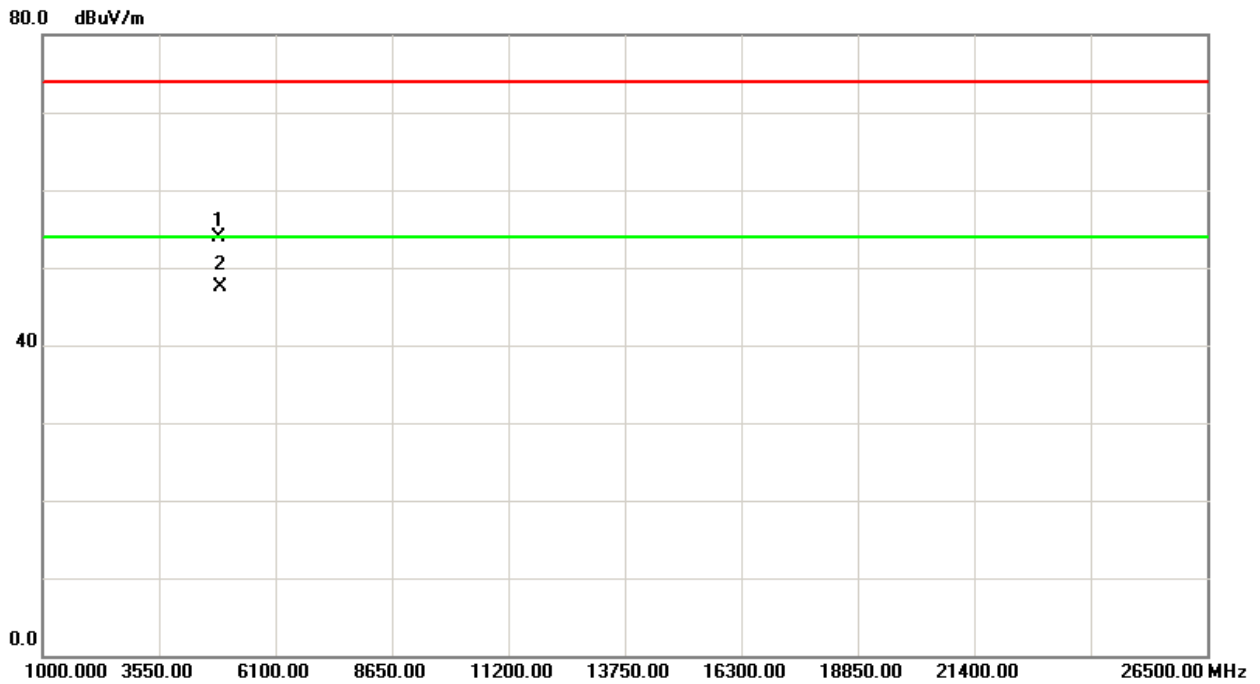
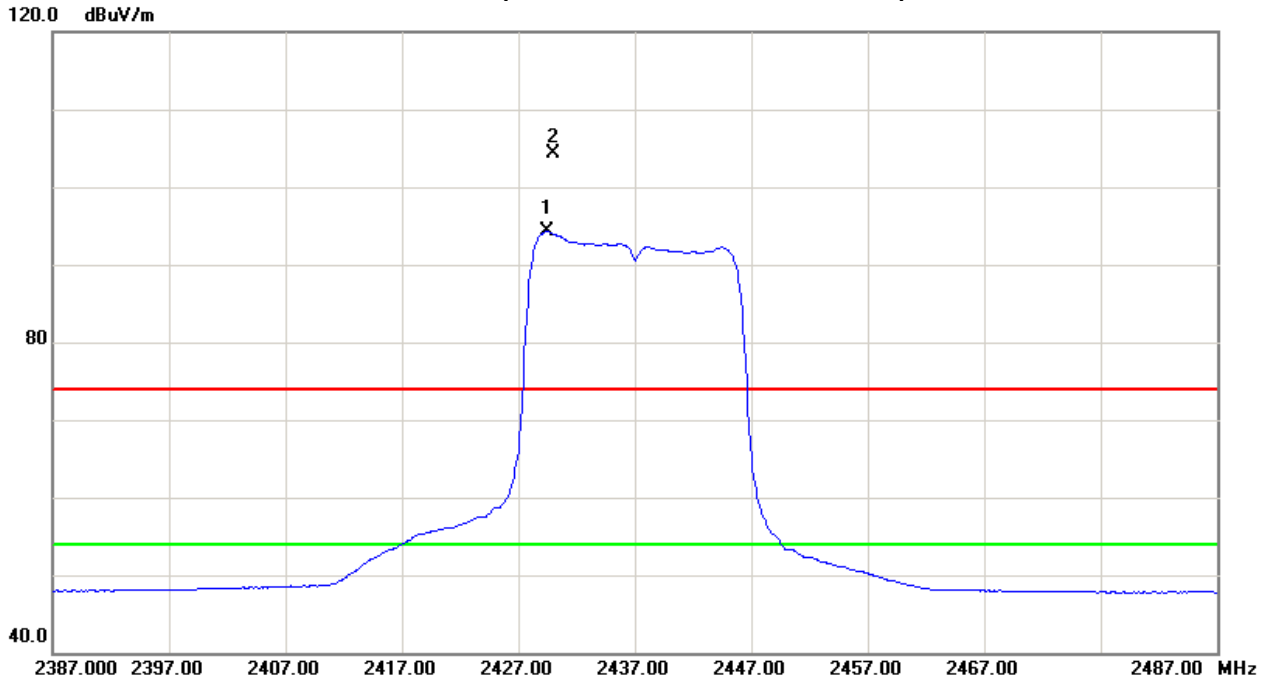



TX CH11 (Above 1000 MHz, Vertical)

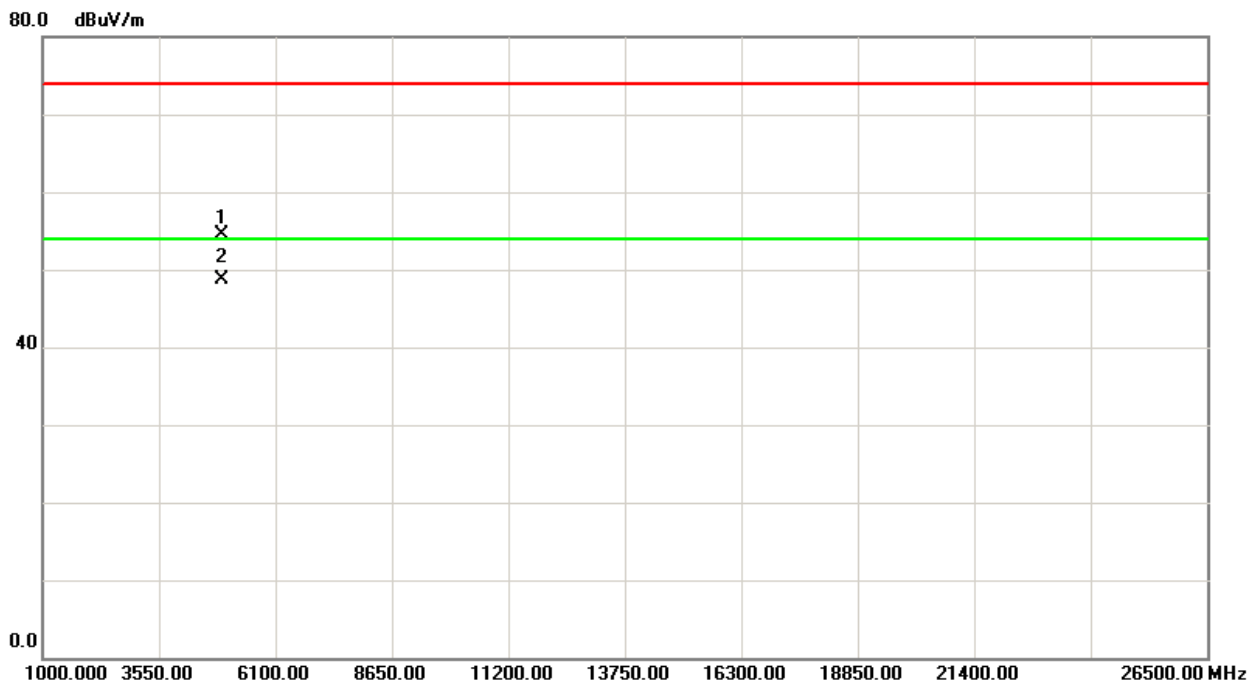
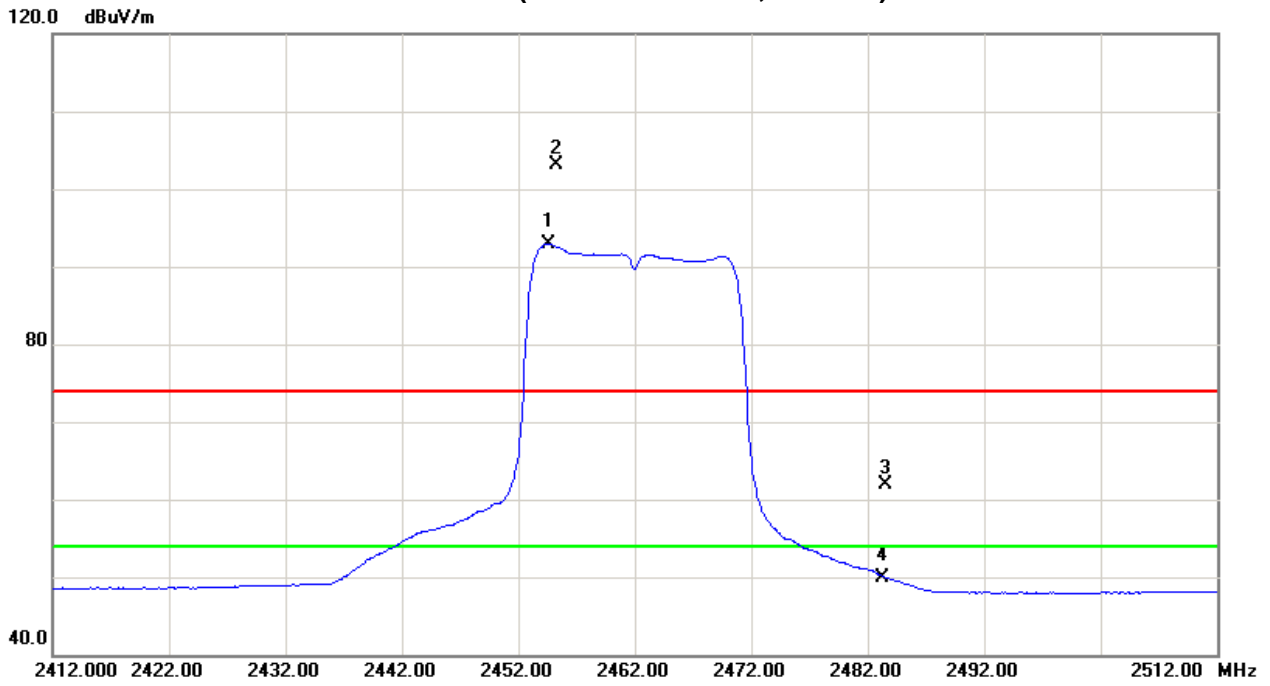



TX CH11 (Above 1000 MHz, Horizontal)

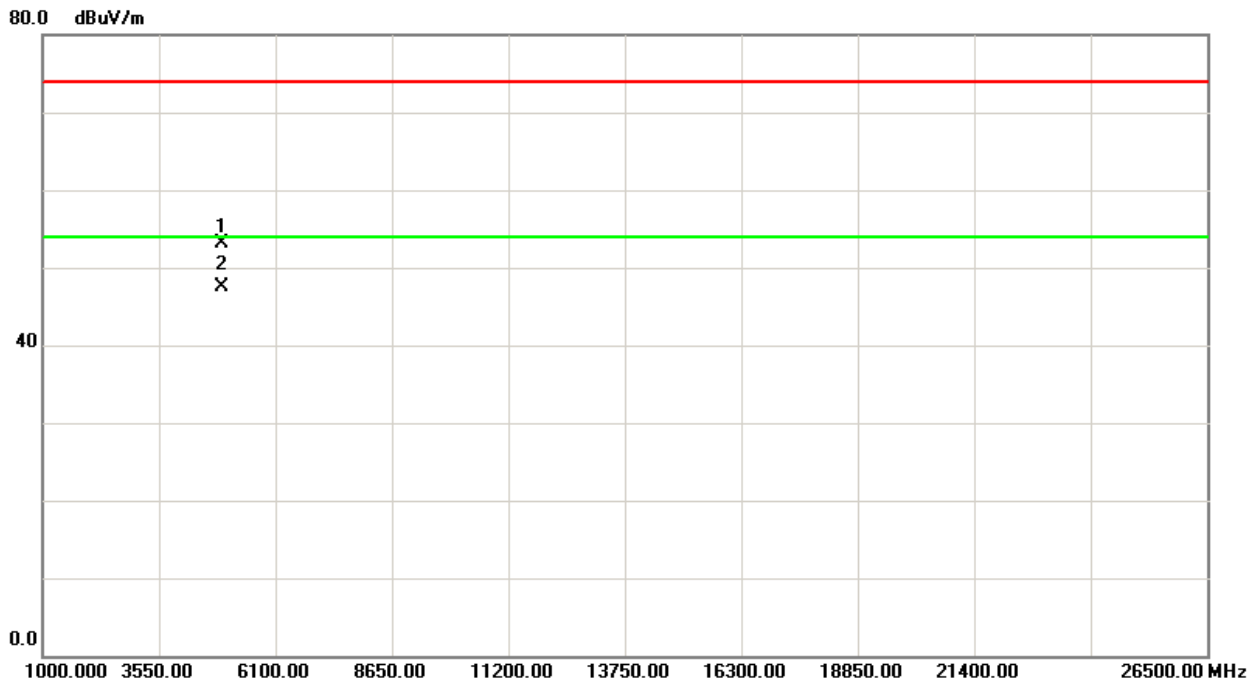
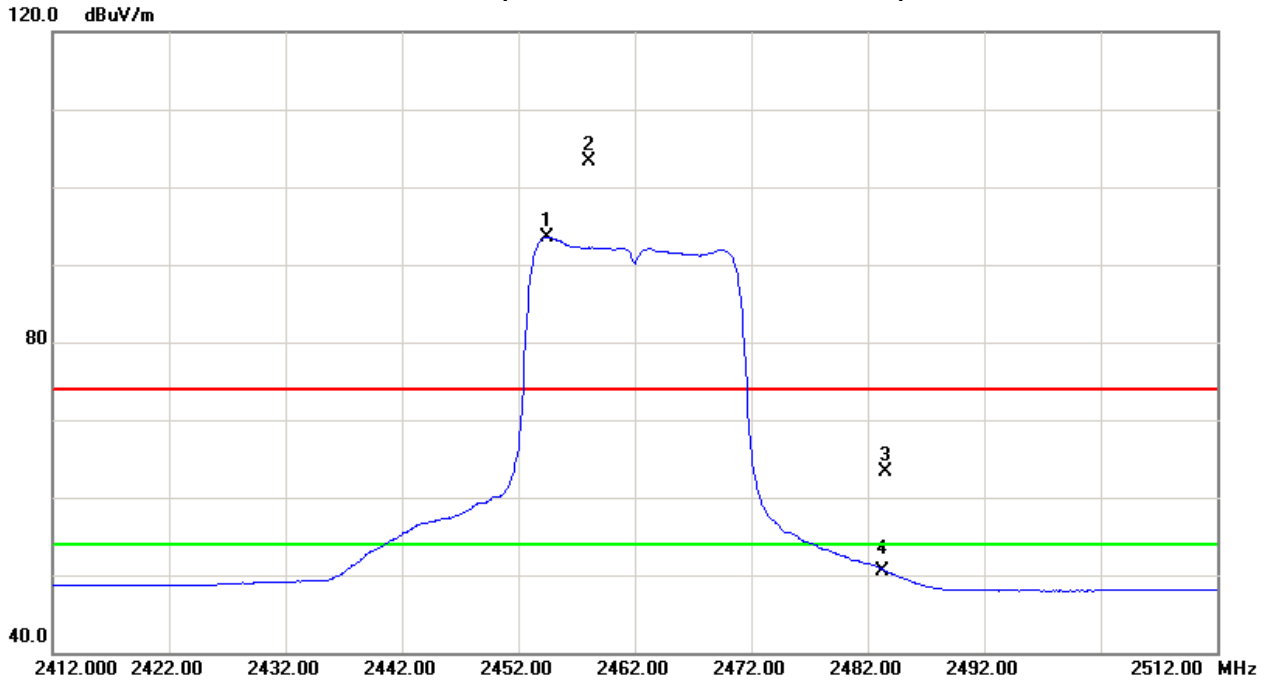



Test Mode : TX N-40M MODE 2422MHz

Freq. (MHz)	Ant.Pol. H/V	Reading (dBuV)		Ant./CF CF(dB)	Act. (dBuV/m)		Limit (dBuV/m)		Note
		Peak	AV		Peak	AV	Peak	AV	
2390.00	V	31.37	18.70	34.09	65.46	52.79	74.00	54.00	X/E
2405.40	V	68.00	55.72	34.14	102.14	89.86			X/F
4844.34	V	46.50	38.24	6.50	53.00	44.74	74.00	54.00	X/H

Freq. (MHz)	Ant.Pol. H/V	Reading (dBuV)		Ant./CF CF(dB)	Act. (dBuV/m)		Limit (dBuV/m)		Note
		Peak	AV		Peak	AV	Peak	AV	
2390.00	H	33.33	18.75	34.09	67.42	52.84	74.00	54.00	X/E
2406.00	H	68.81	55.90	34.14	102.95	90.04			X/F
4843.89	H	44.70	37.06	6.50	51.20	43.56	74.00	54.00	X/H

Test Mode : TX N-40M MODE 2437MHz

Freq. (MHz)	Ant.Pol. H/V	Reading (dBuV)		Ant./CF CF(dB)	Act. (dBuV/m)		Limit (dBuV/m)		Note
		Peak	AV		Peak	AV	Peak	AV	
2420.60	V	69.03	56.86	34.18	103.21	91.04			X/F
4874.22	V	47.11	38.76	6.58	53.69	45.34	74.00	54.00	X/H

Freq. (MHz)	Ant.Pol. H/V	Reading (dBuV)		Ant./CF CF(dB)	Act. (dBuV/m)		Limit (dBuV/m)		Note
		Peak	AV		Peak	AV	Peak	AV	
2419.60	H	68.64	56.79	34.18	102.82	90.97			X/F
4874.37	H	45.62	37.98	6.58	52.20	44.56	74.00	54.00	X/H

Test Mode : TX N-40M MODE 2452MHz

Freq. (MHz)	Ant.Pol. H/V	Reading (dBuV)		Ant./CF CF(dB)	Act. (dBuV/m)		Limit (dBuV/m)		Note
		Peak	AV		Peak	AV	Peak	AV	
2435.20	V	68.39	56.07	34.23	102.62	90.30			X/F
2483.50	V	31.60	16.85	34.37	65.97	51.22	74.00	54.00	X/E
4904.27	V	46.97	37.54	6.67	53.64	44.21	74.00	54.00	X/H

Freq. (MHz)	Ant.Pol. H/V	Reading (dBuV)		Ant./CF CF(dB)	Act. (dBuV/m)		Limit (dBuV/m)		Note
		Peak	AV		Peak	AV	Peak	AV	
2435.60	H	67.62	55.92	34.23	101.85	90.15			X/F
2483.50	H	30.33	16.95	34.37	64.70	51.32	74.00	54.00	X/E
4904.62	H	46.15	37.11	6.67	52.82	43.78	74.00	54.00	X/H



TX CH03 (Above 1000 MHz, Vertical)

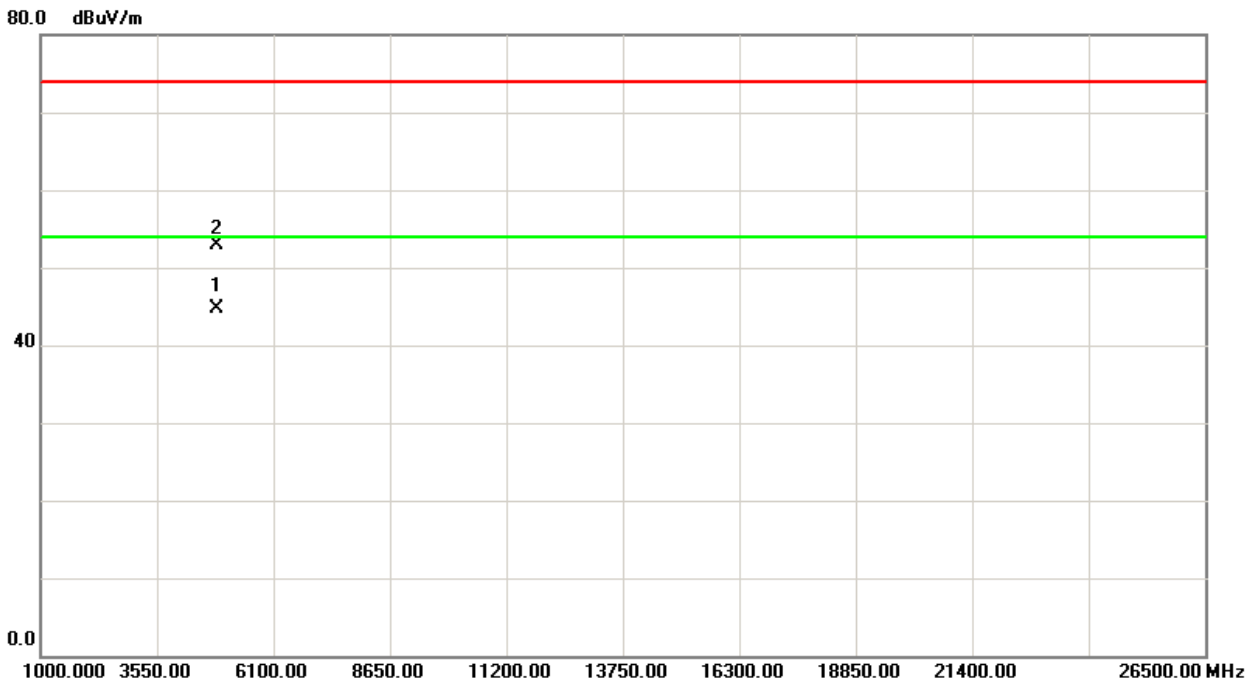
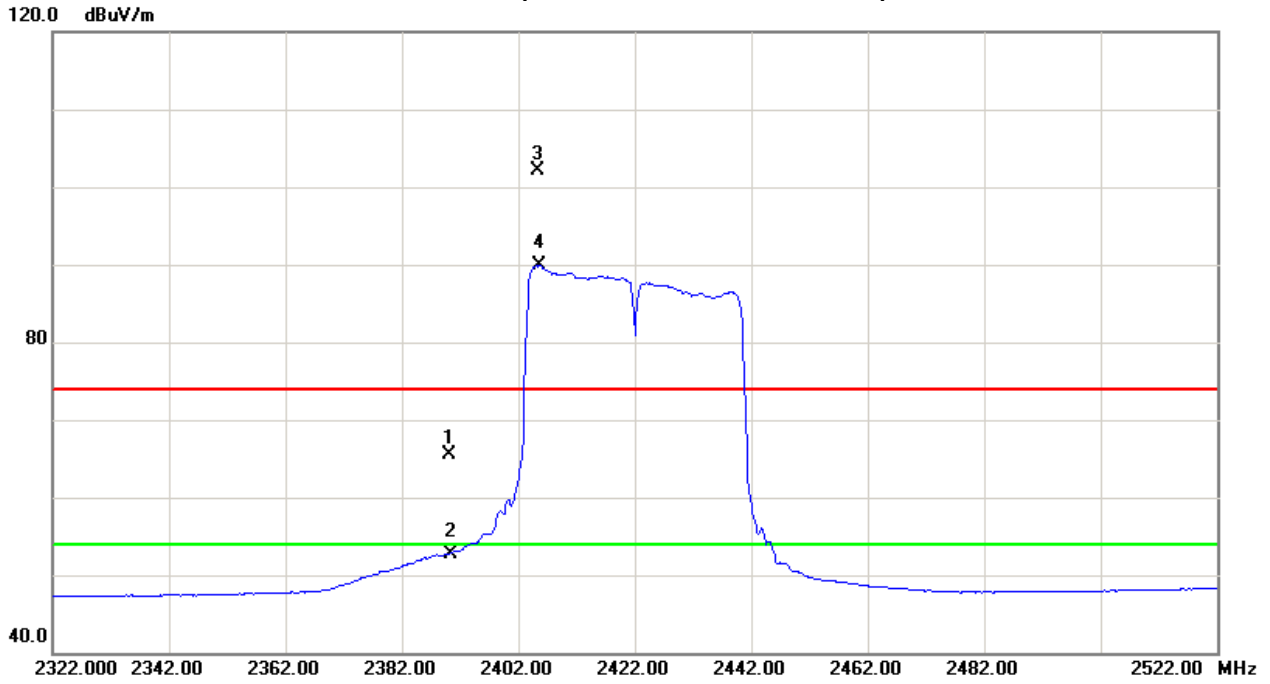



TX CH03 (Above 1000 MHz, Horizontal)

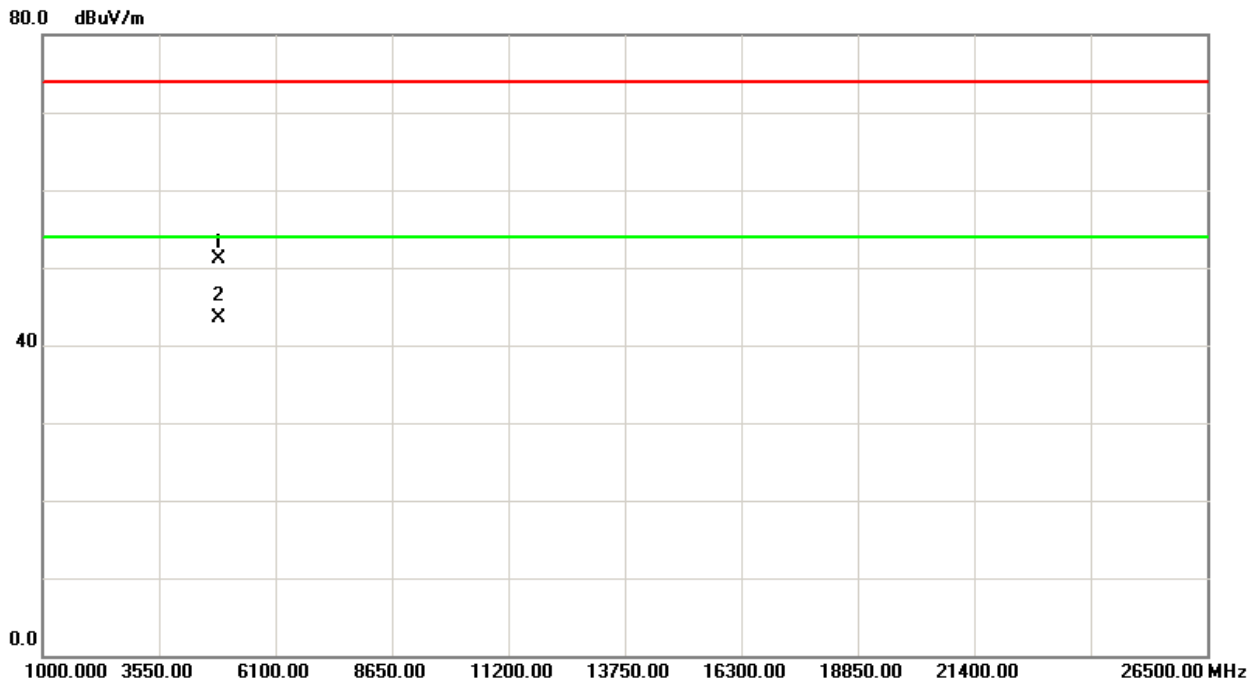
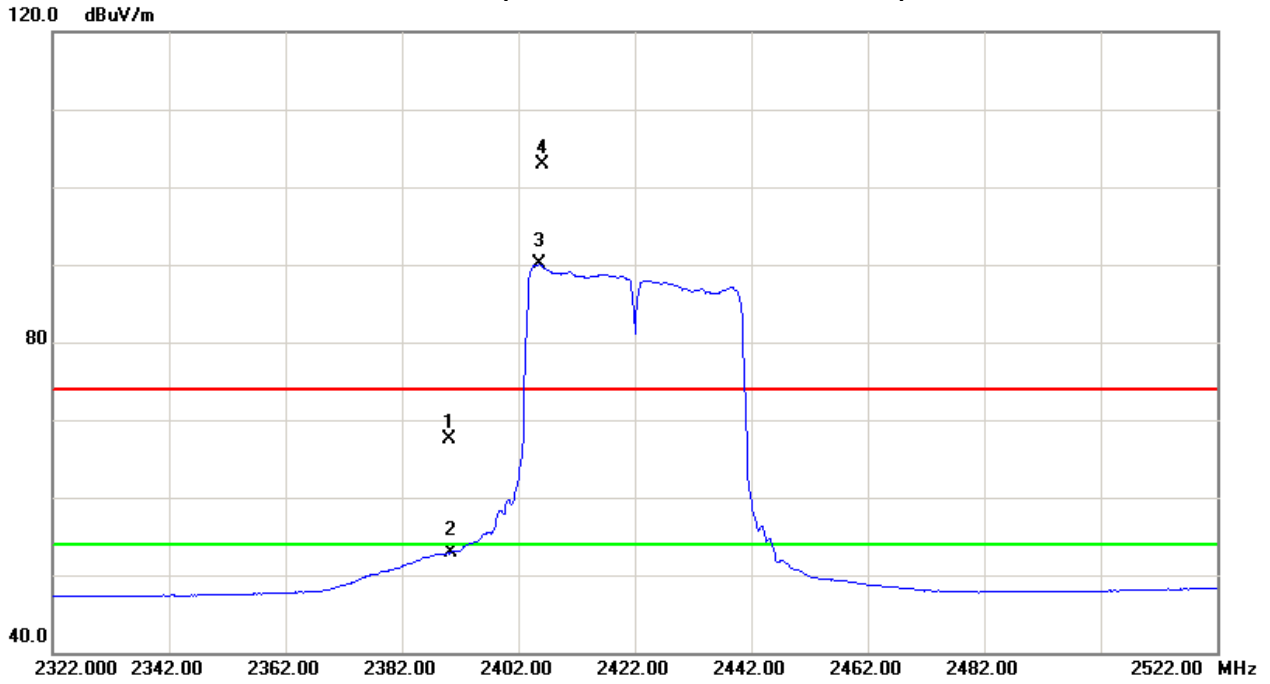



TX CH06 (Above 1000 MHz, Vertical)

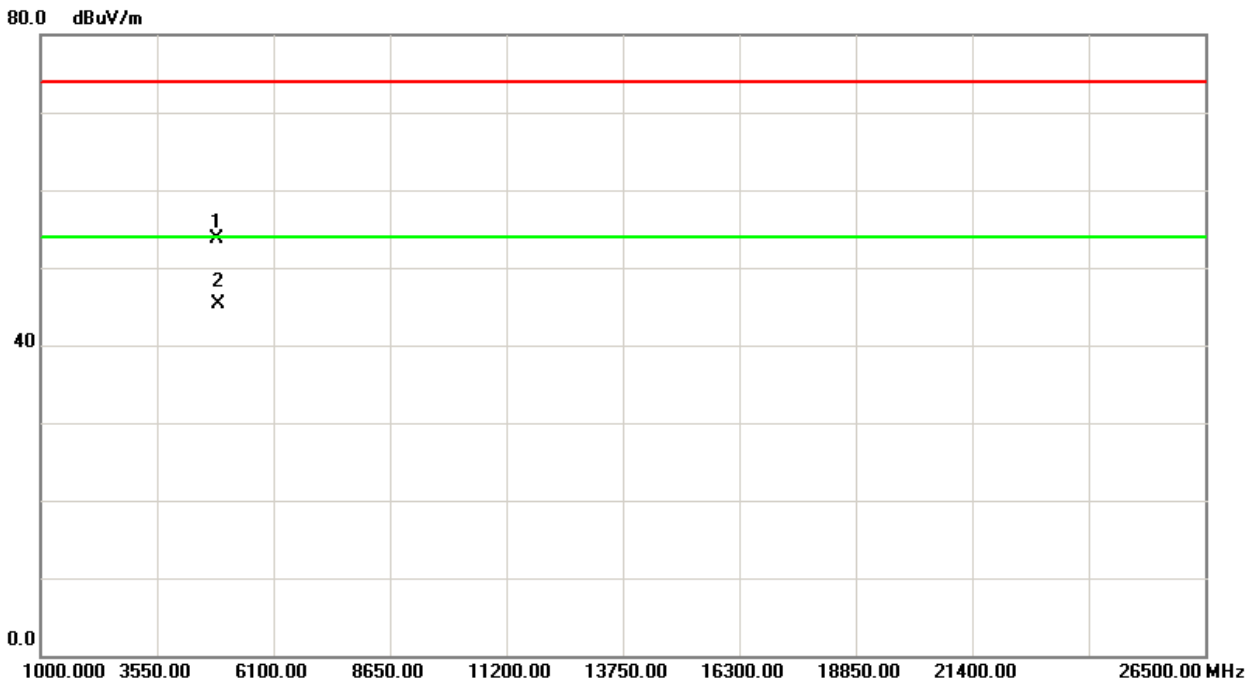
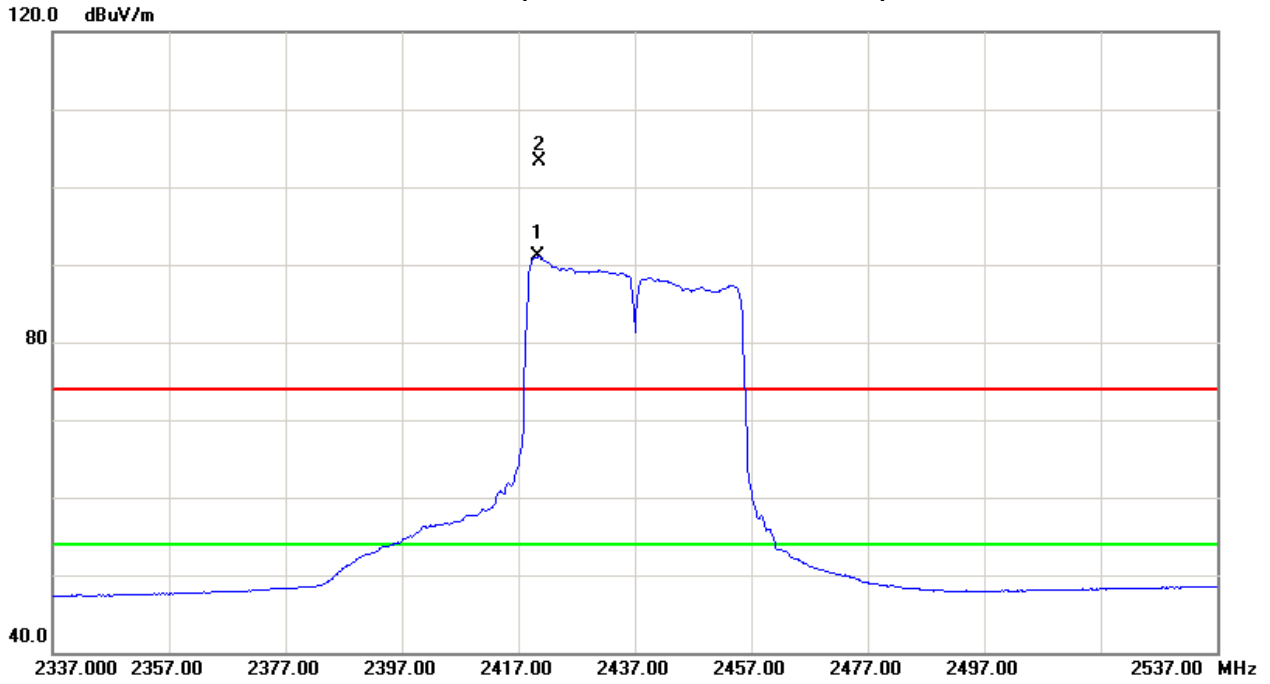



TX CH06 (Above 1000 MHz, Horizontal)

120.0 dBuV/m

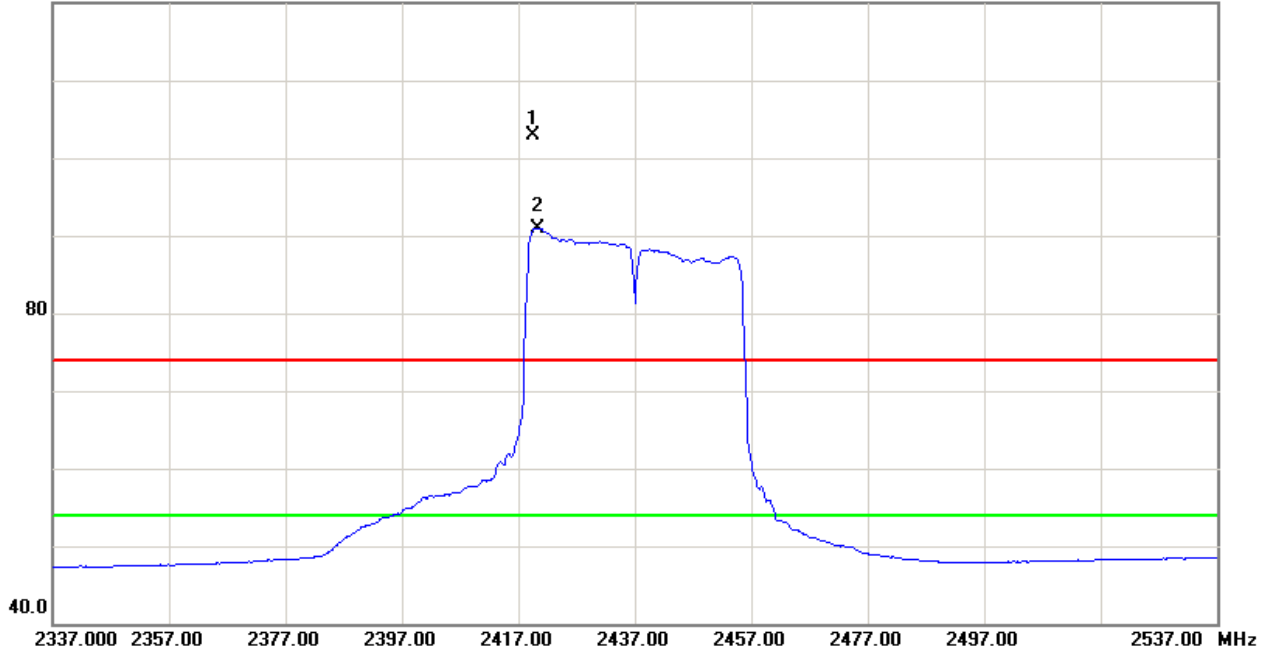

80.0 dBuV/m

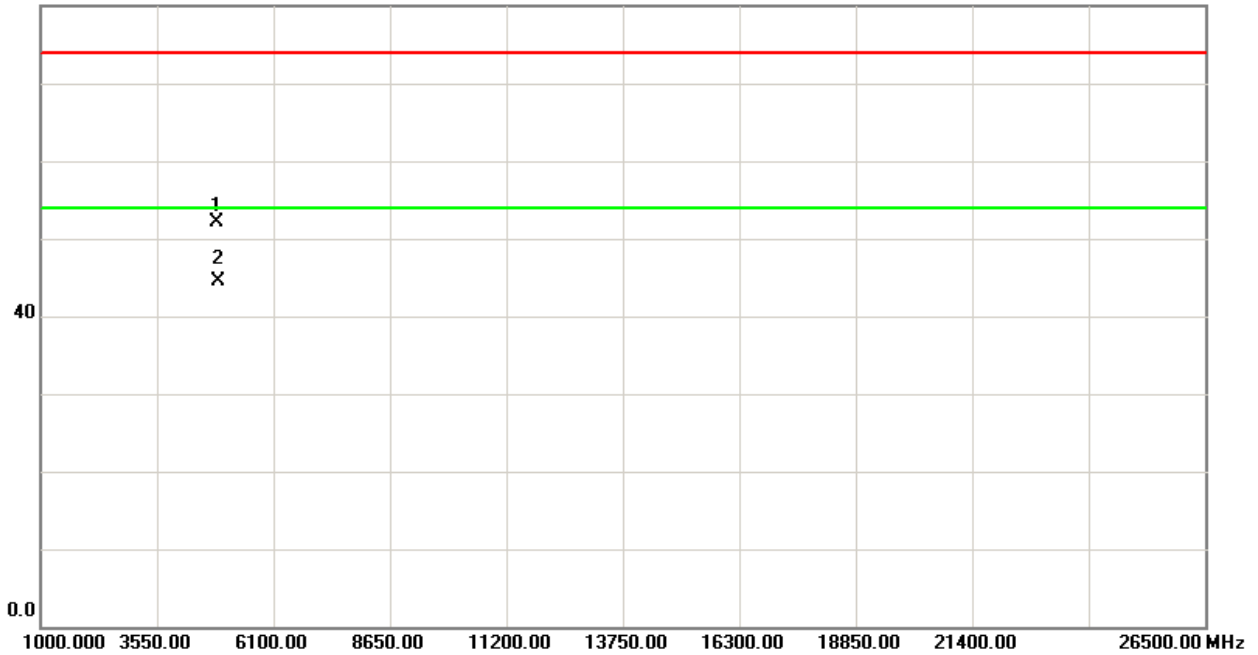



TX CH09 (Above 1000 MHz, Vertical)

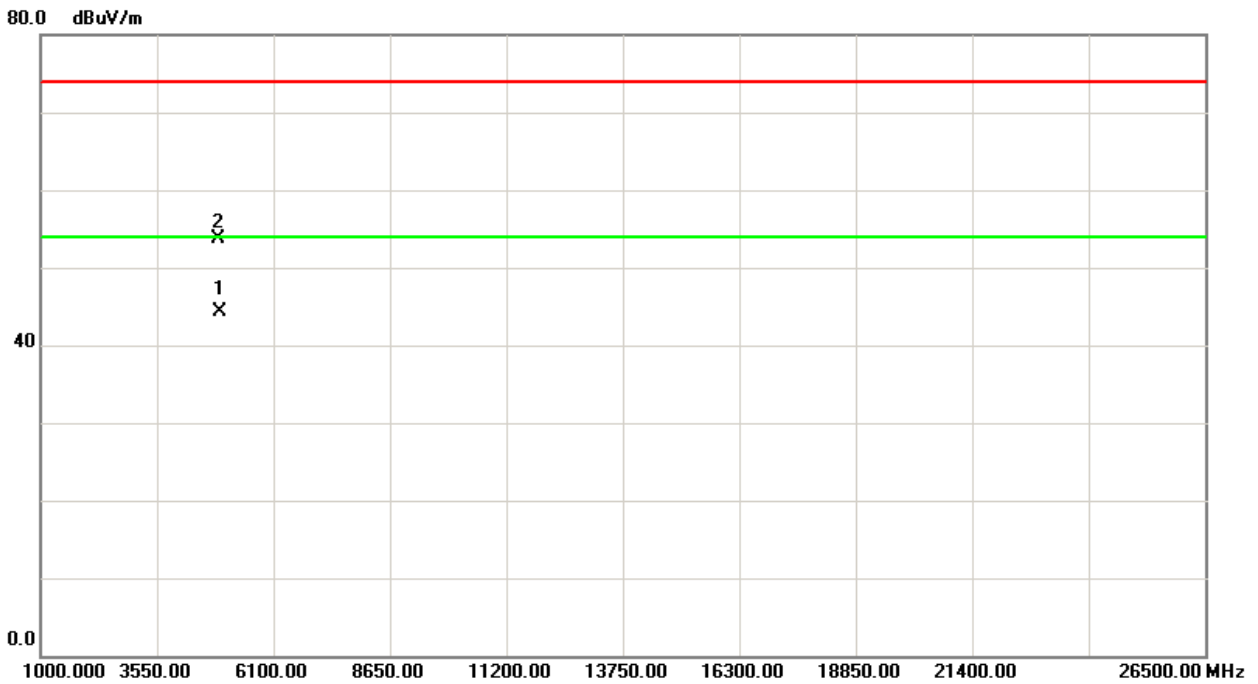
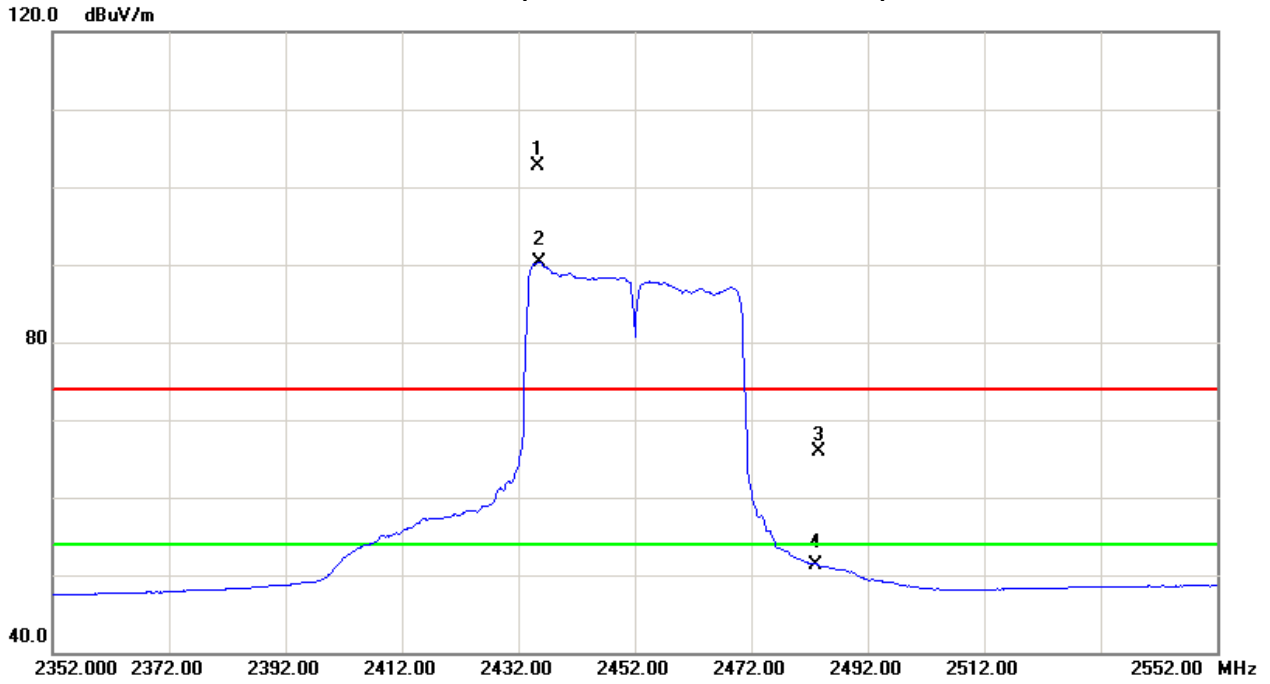



TX CH09 (Above 1000 MHz, Horizontal)

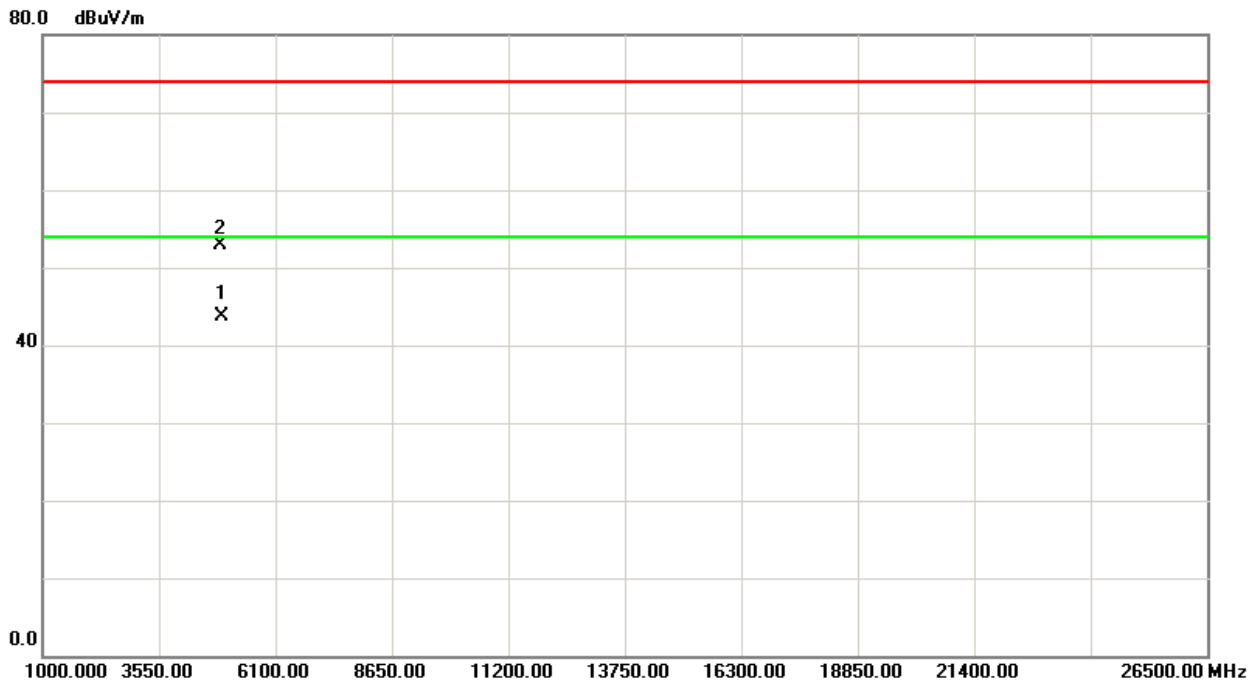
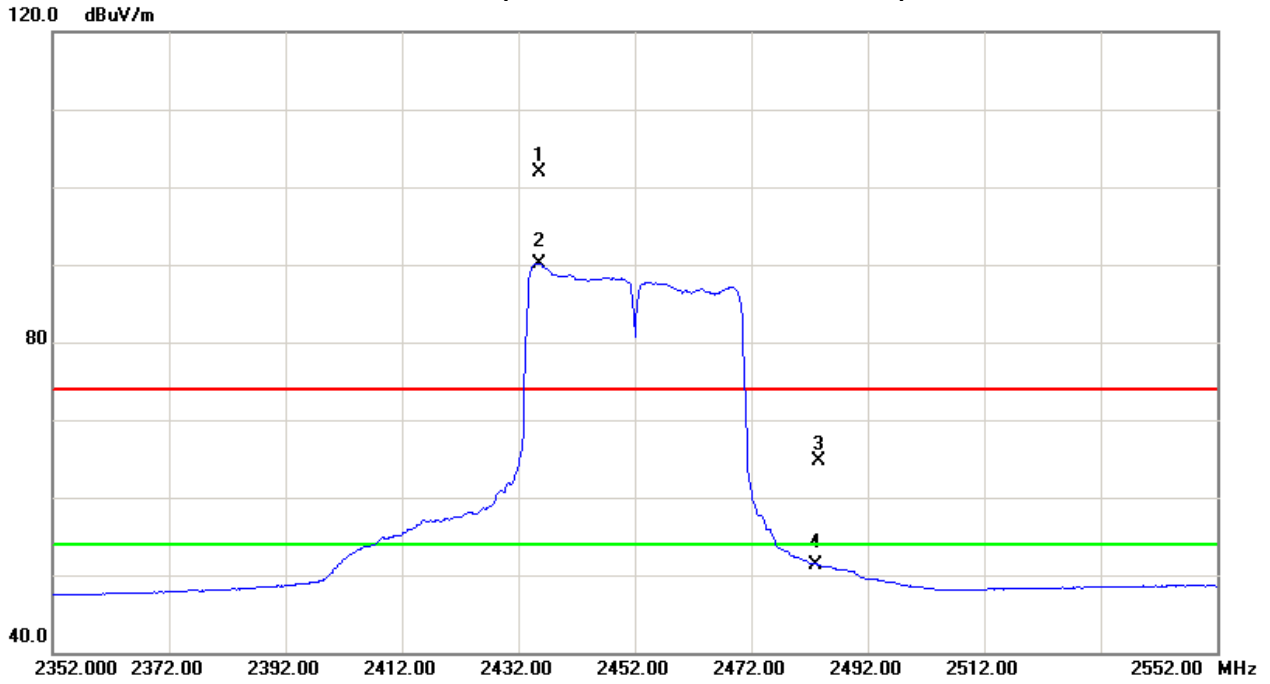



5. BANDWIDTH TEST

5.1 Applied procedures

FCC Part15 (15.247) , Subpart C/ RSS-GEN and RSS-210			
Section	Test Item	Frequency Range (MHz)	Result
15.247(a)(2) RSS-GEN section 4.6.1 RSS-210 Annex 8 (A8.2(a))	Bandwidth	2400-2483.5	PASS

5.1.1 TEST PROCEDURE

- a. The EUT was directly connected to the spectrum analyzer and antenna output port as show in the block diagram below,
- b. Spectrum Setting: RBW= 100KHz, VBW=300KHz, Sweep time = 2.5 ms.

5.1.2 DEVIATION FROM STANDARD

No deviation.

5.1.3 TEST SETUP



5.1.4 EUT OPERATION CONDITIONS

The EUT tested system was configured as the statements of 4.1.6 Unless otherwise a special operating condition is specified in the follows during the testing.

5.1.5 EUT TEST CONDITIONS

Temperature: 25°C
 Relative Humidity: 55%
 Test Voltage: AC 120V/60Hz



5.1.6 TEST RESULTS

Test Mode : TX B Mode_CH01/06/11_ANT 1

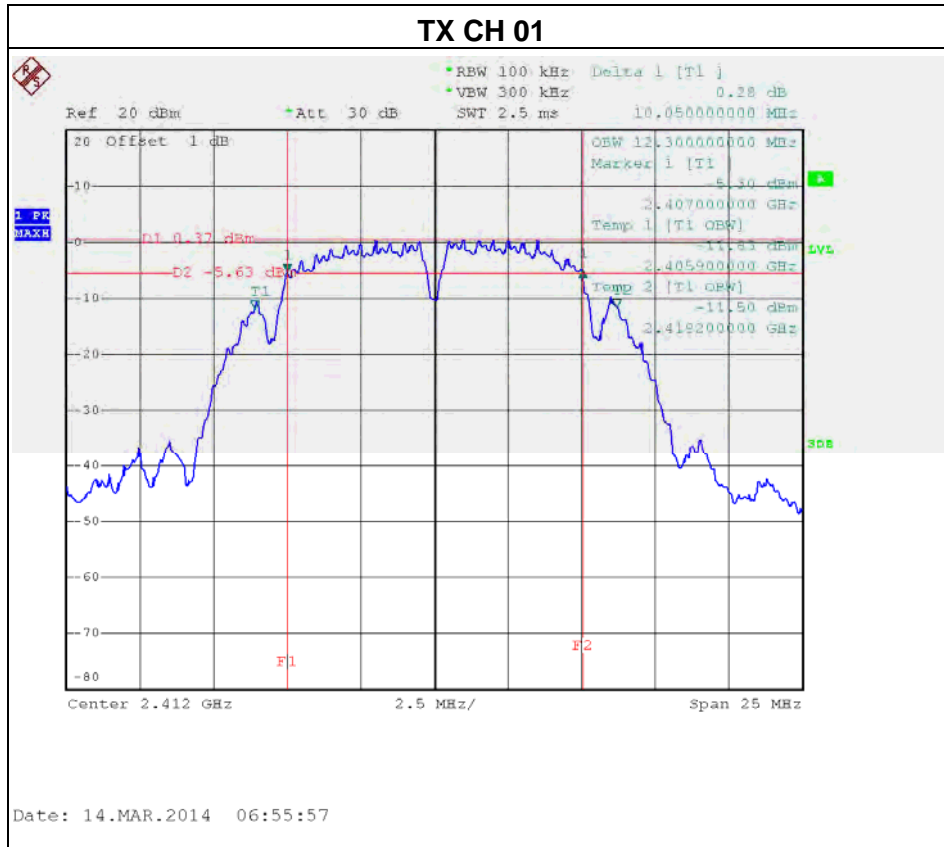

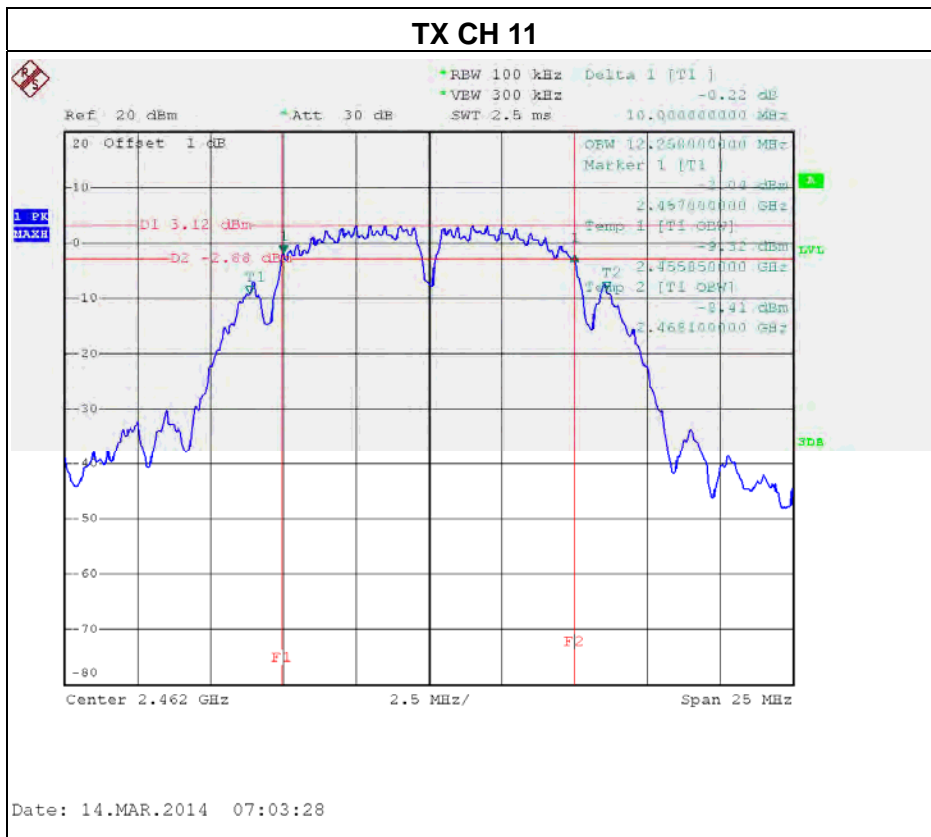
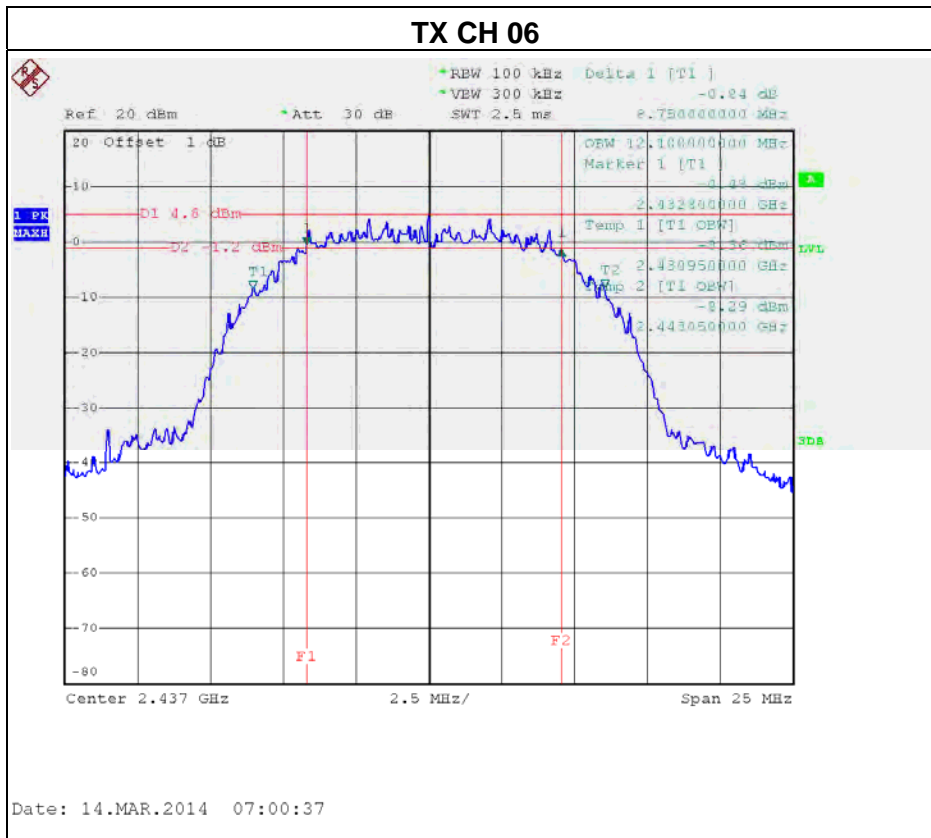



Test Mode : TX B Mode_CH01/06/11_ANT 2

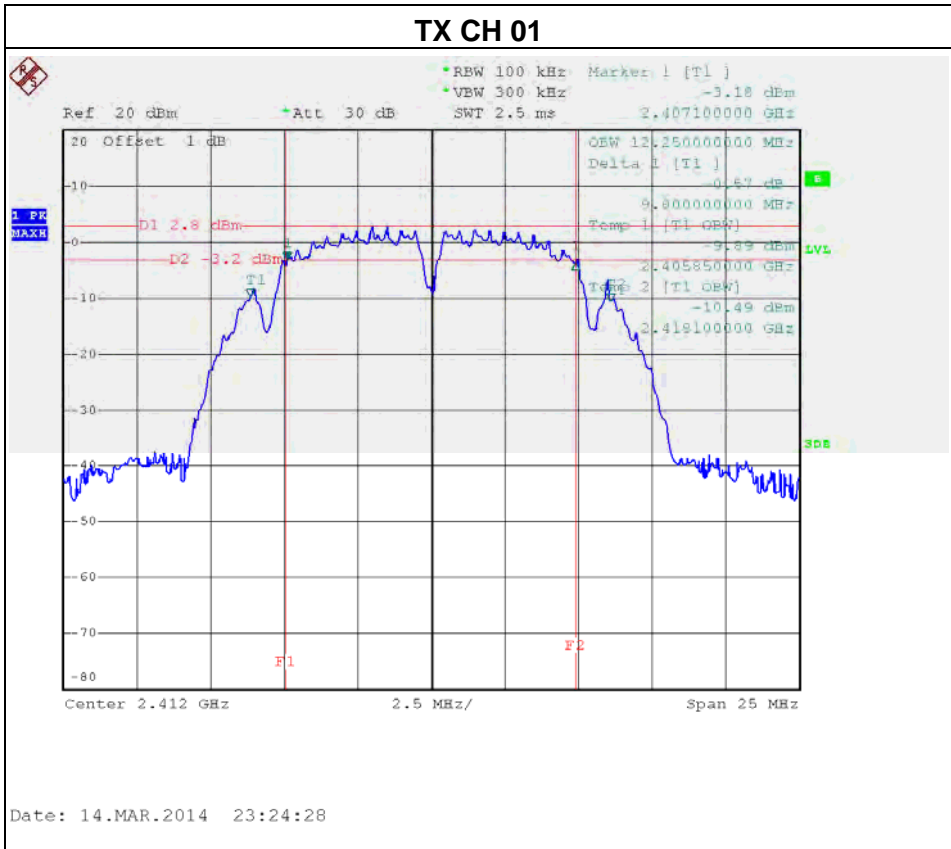

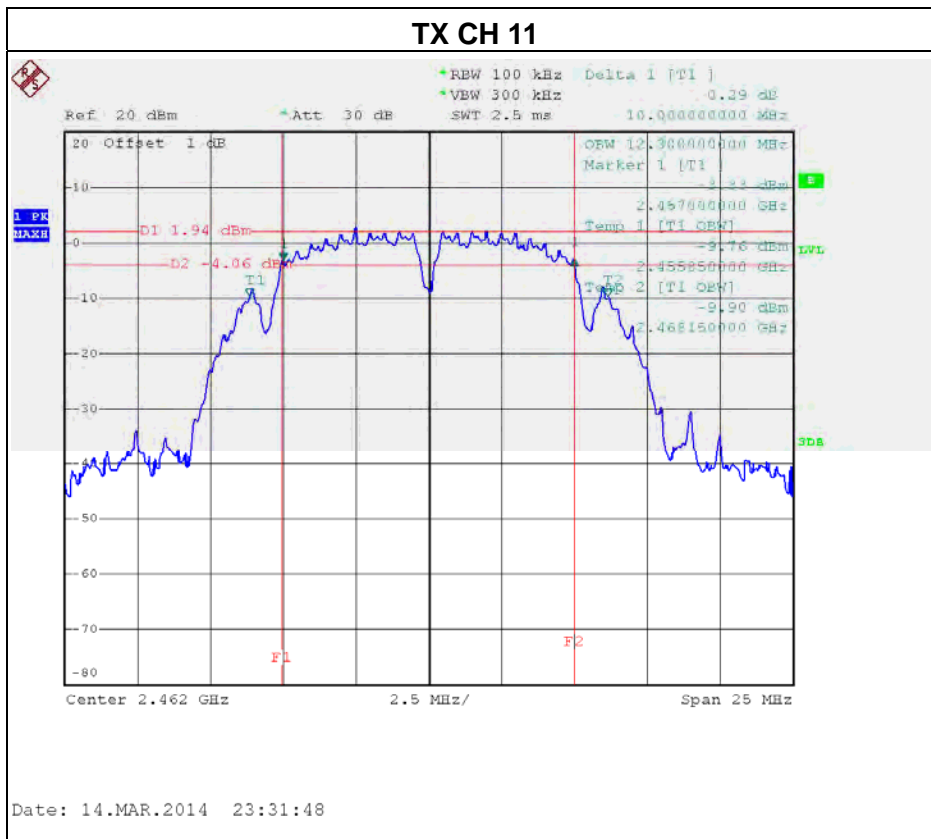
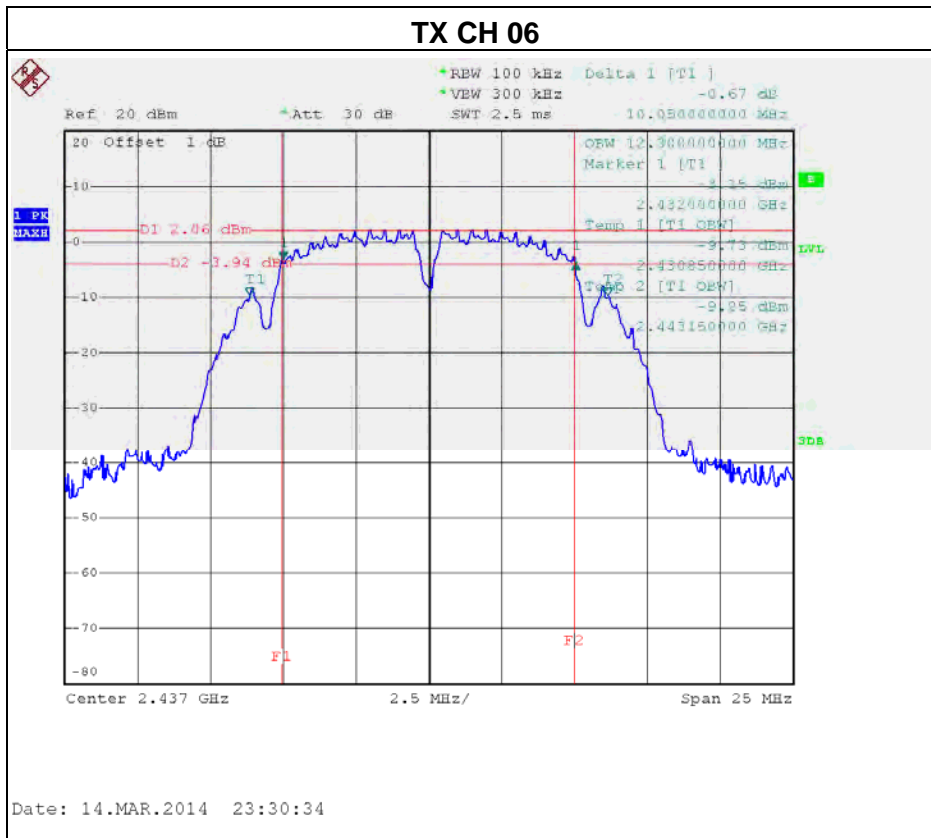



Test Mode: TX G Mode_CH01/06/11_ANT 1

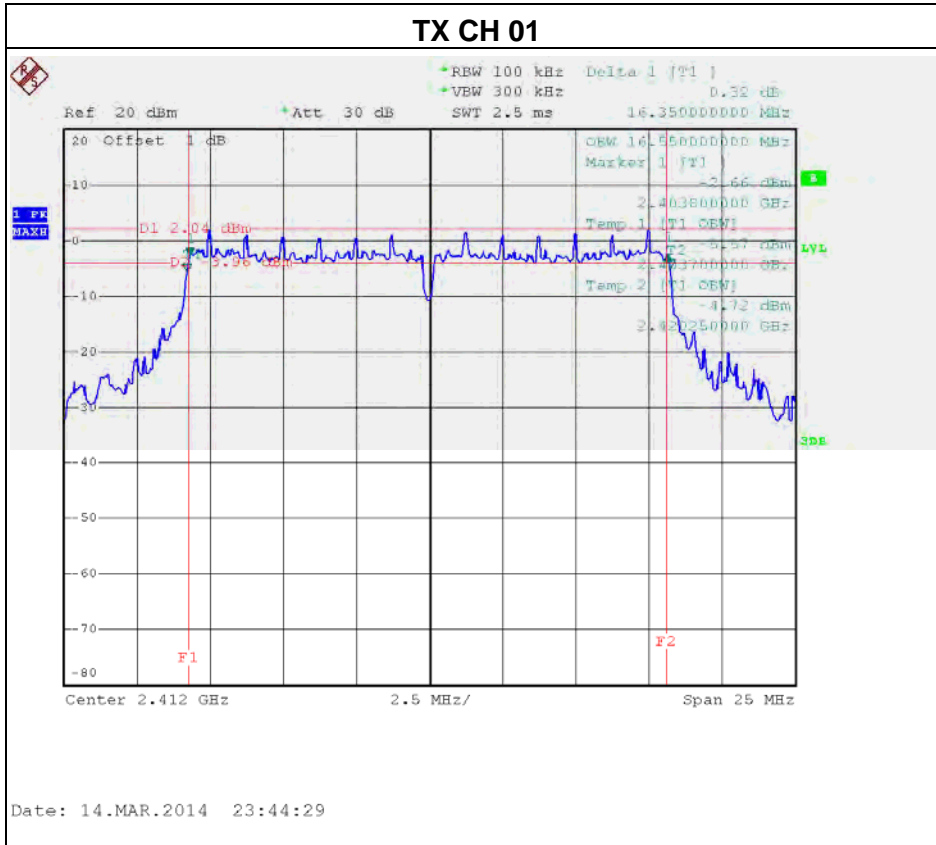

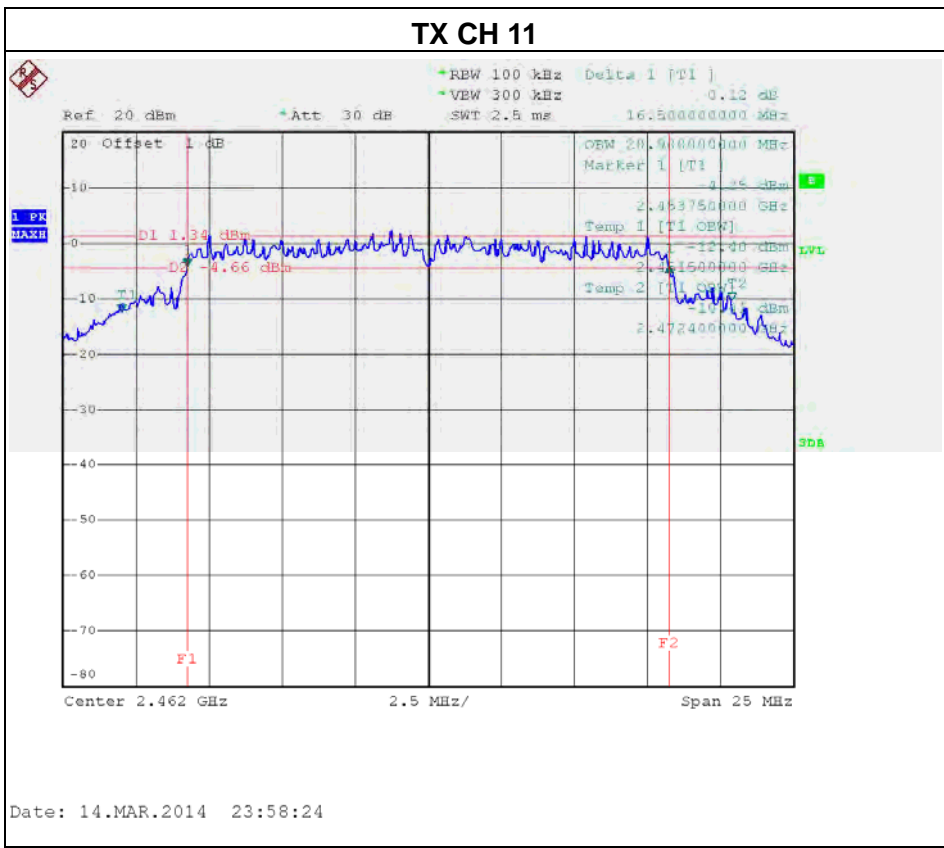
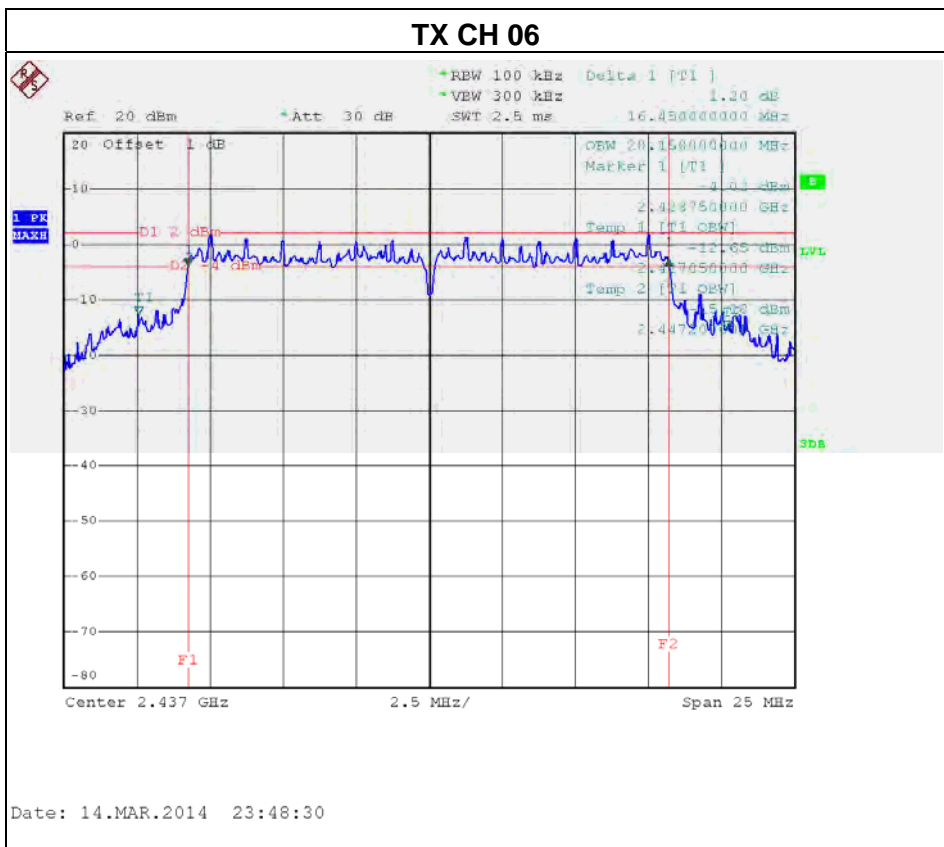



Test Mode: TX G Mode_CH01/06/11_ANT 2

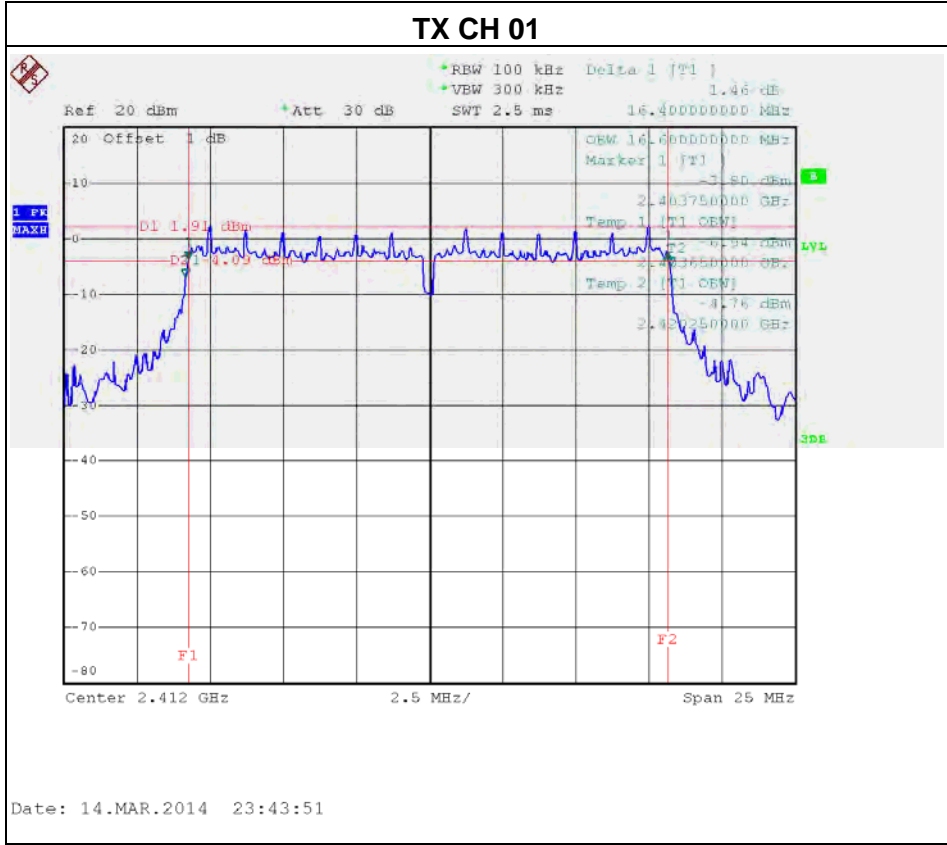

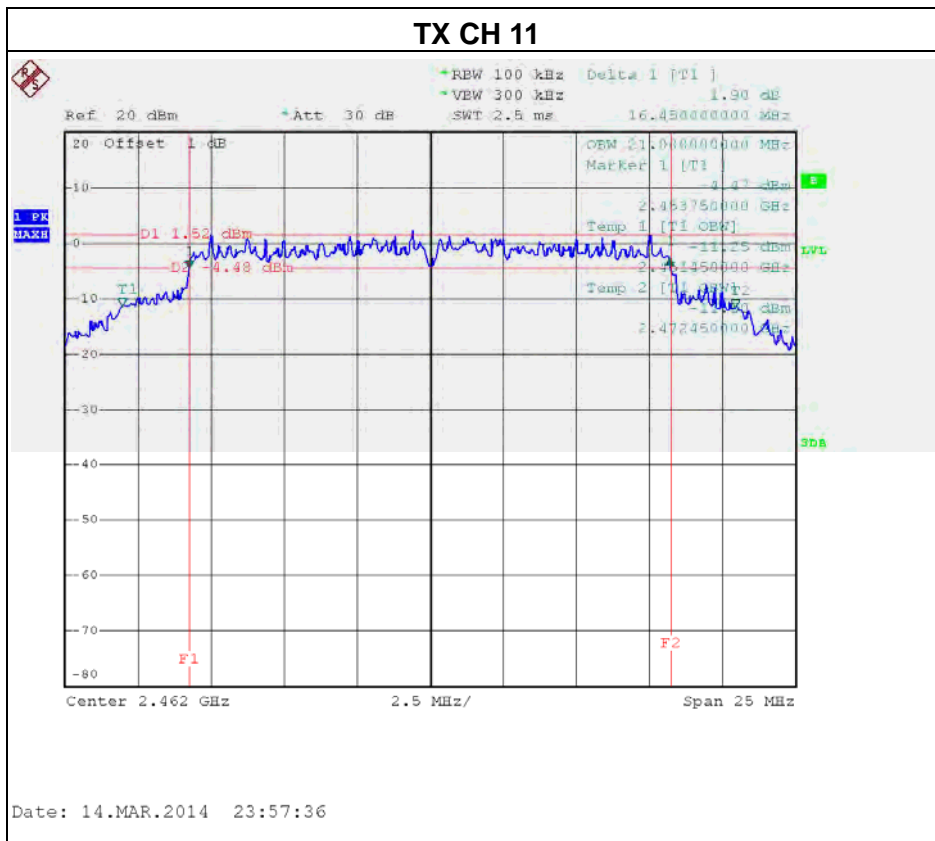
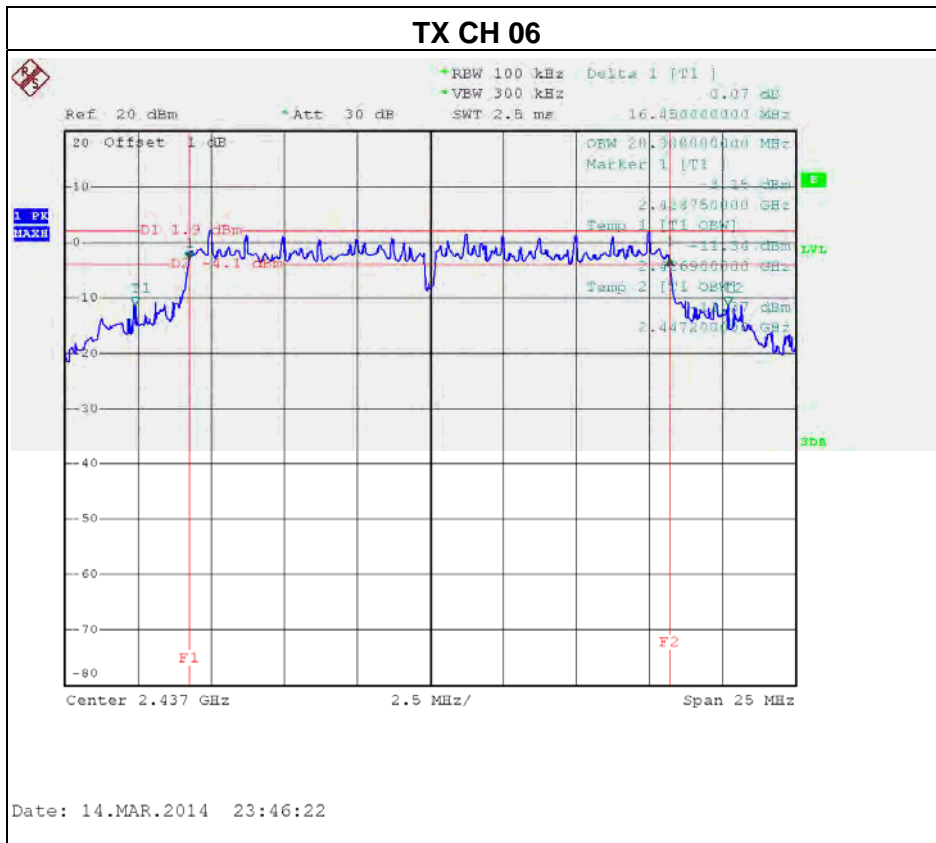



Test Mode : TX N-20MHz Mode_CH01/06/11_ANT 1

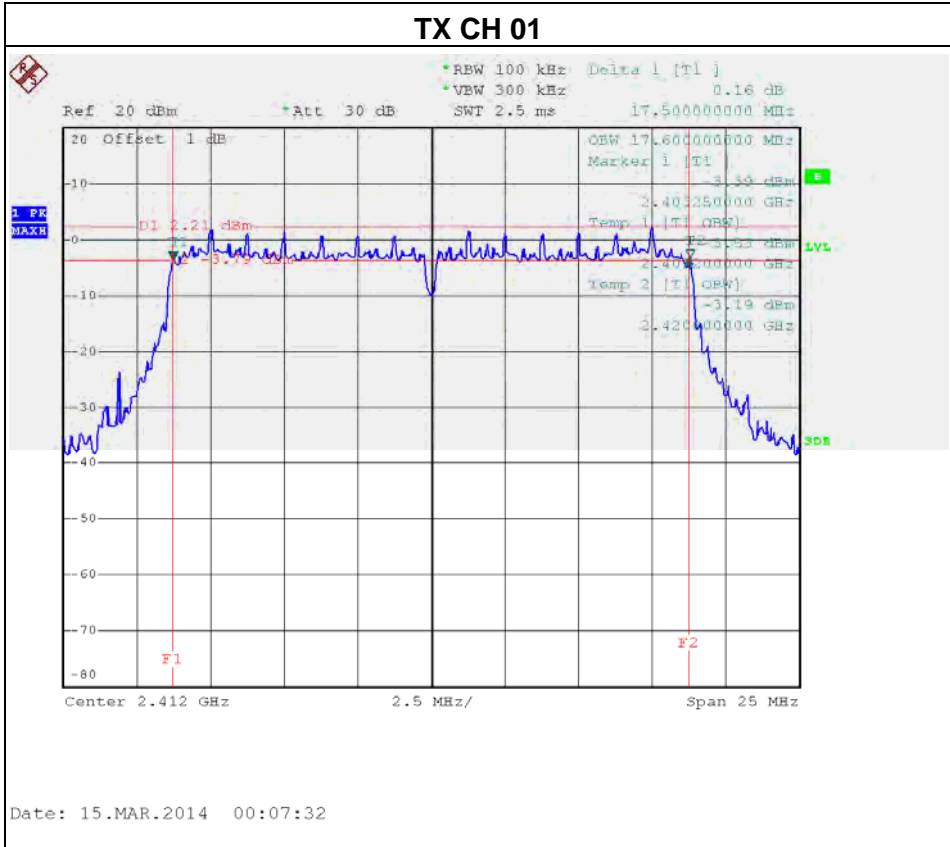

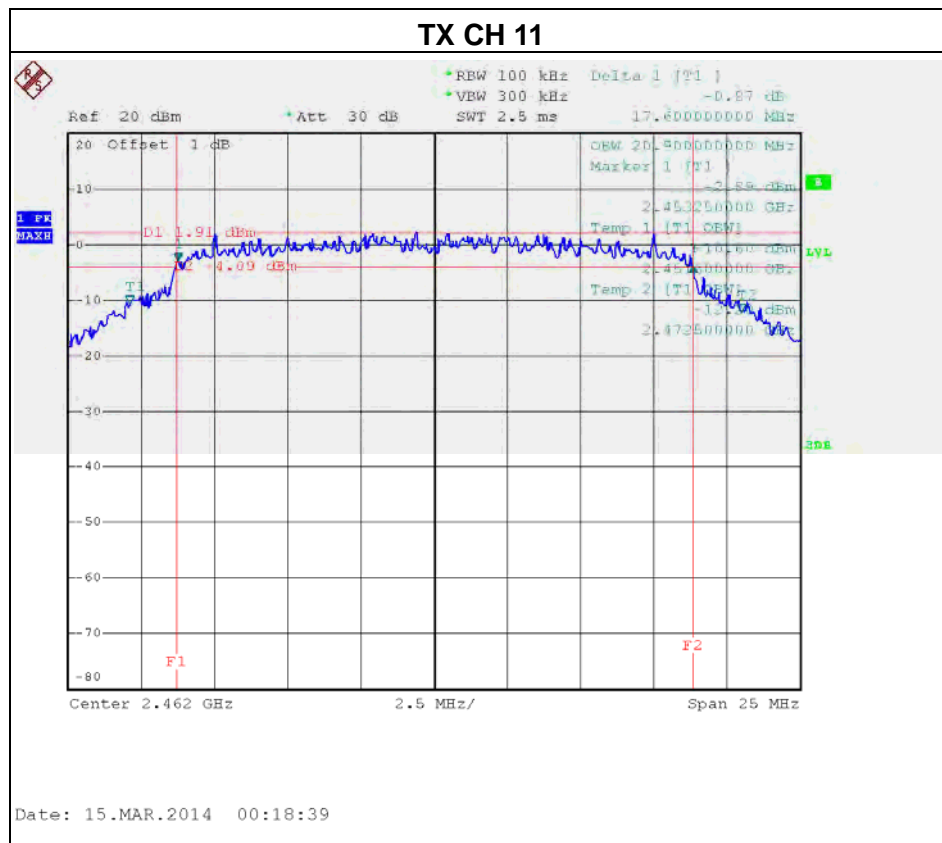
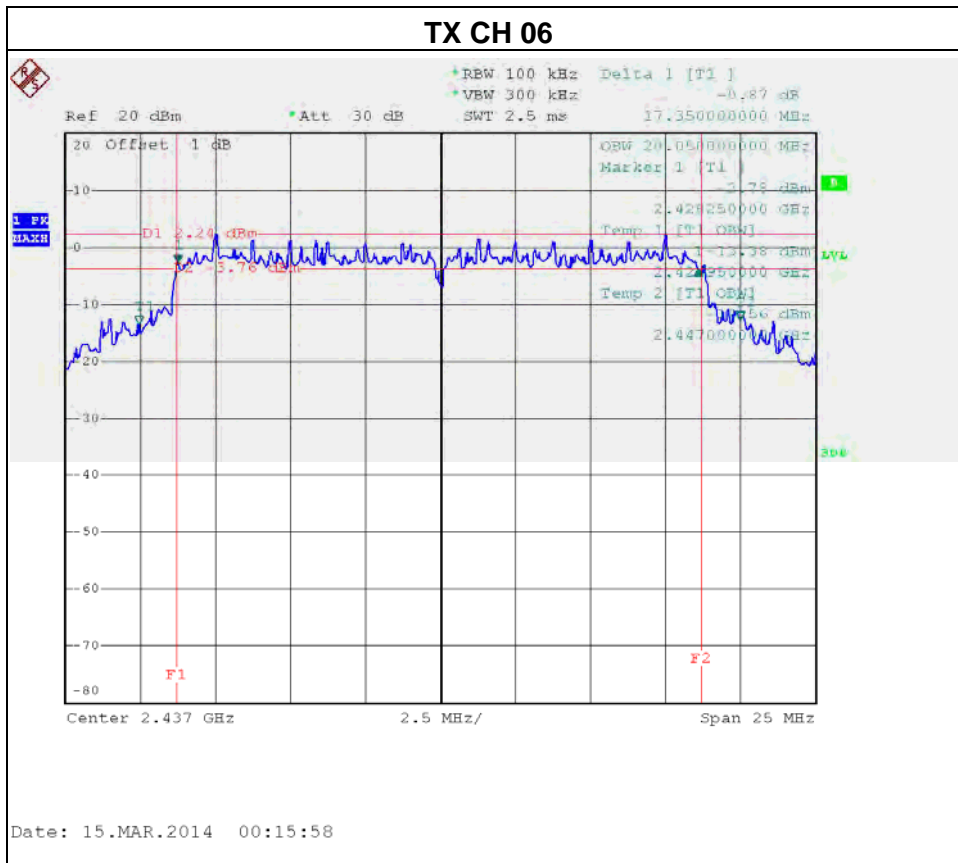



Test Mode : TX N-20MHz Mode_CH01/06/11_ANT 2

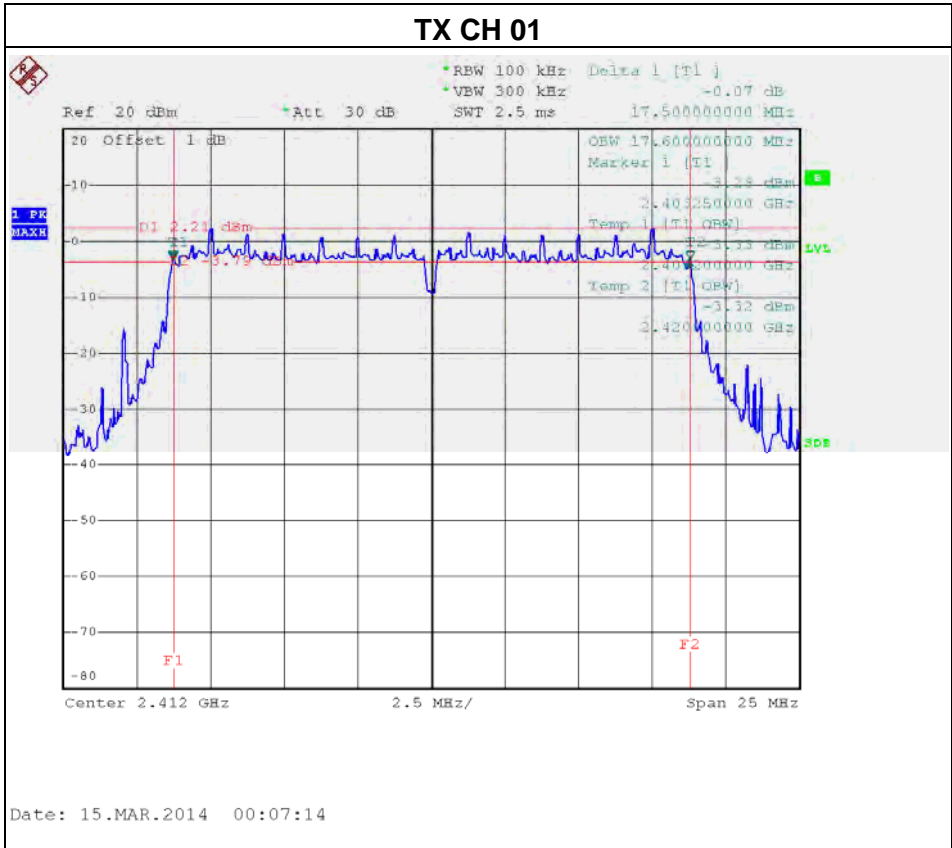

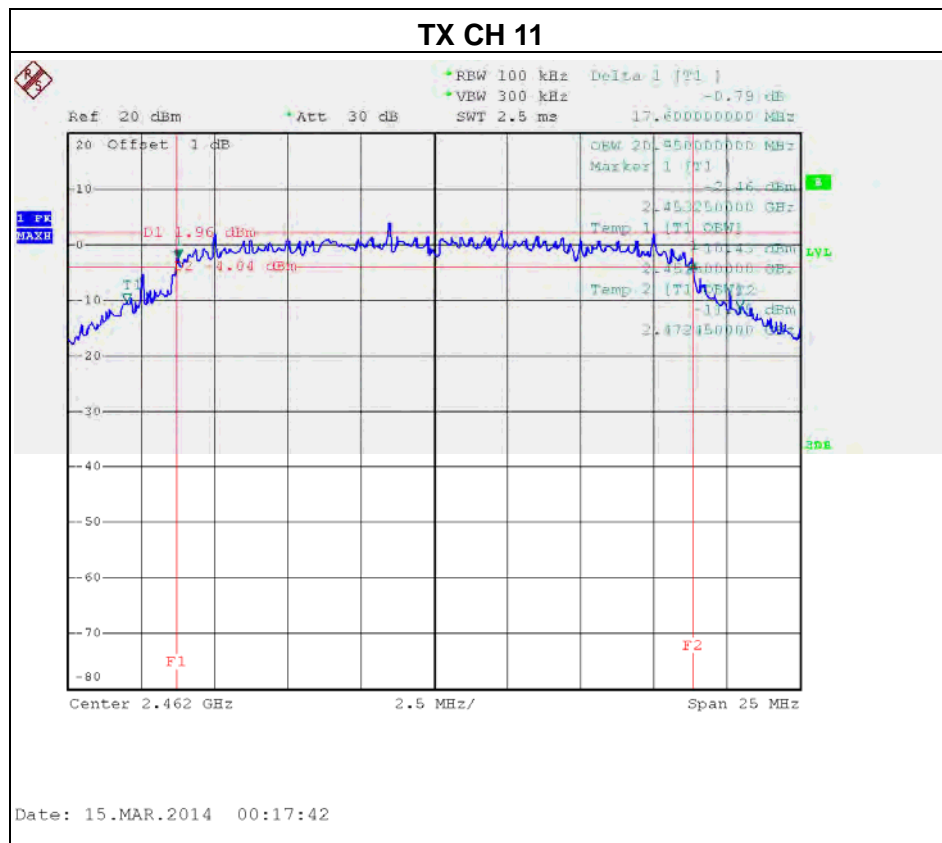
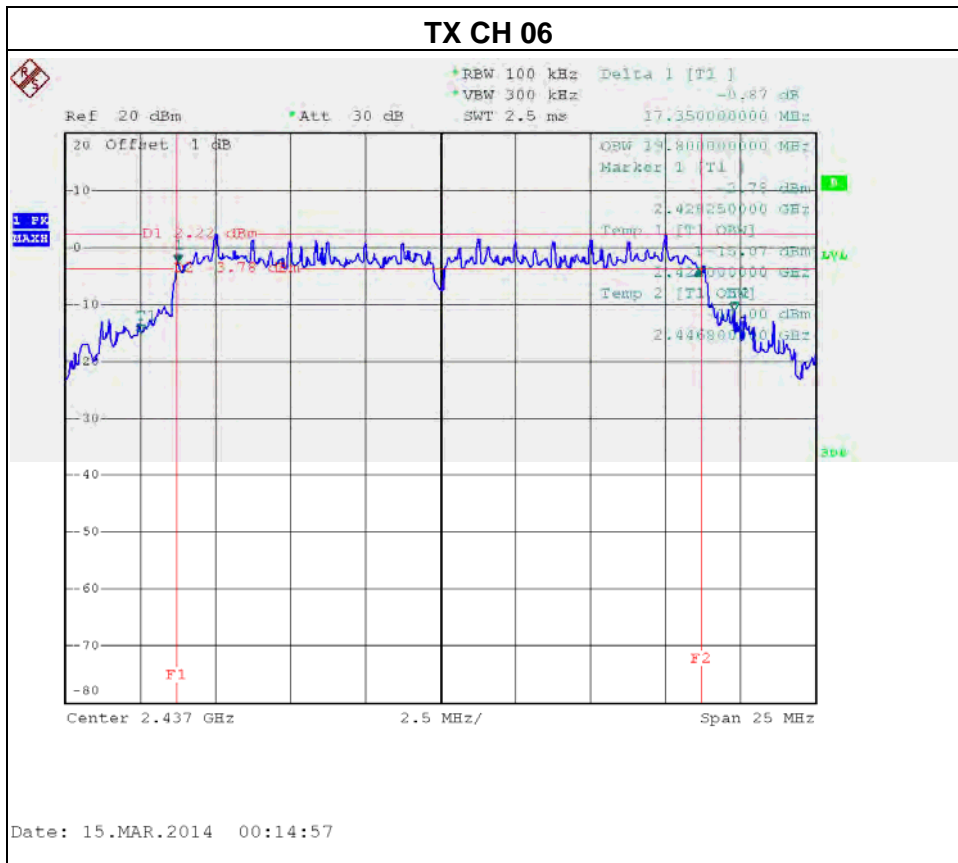



Test Mode : TX N-40MHz Mode_CH03/06/09_ANT 1

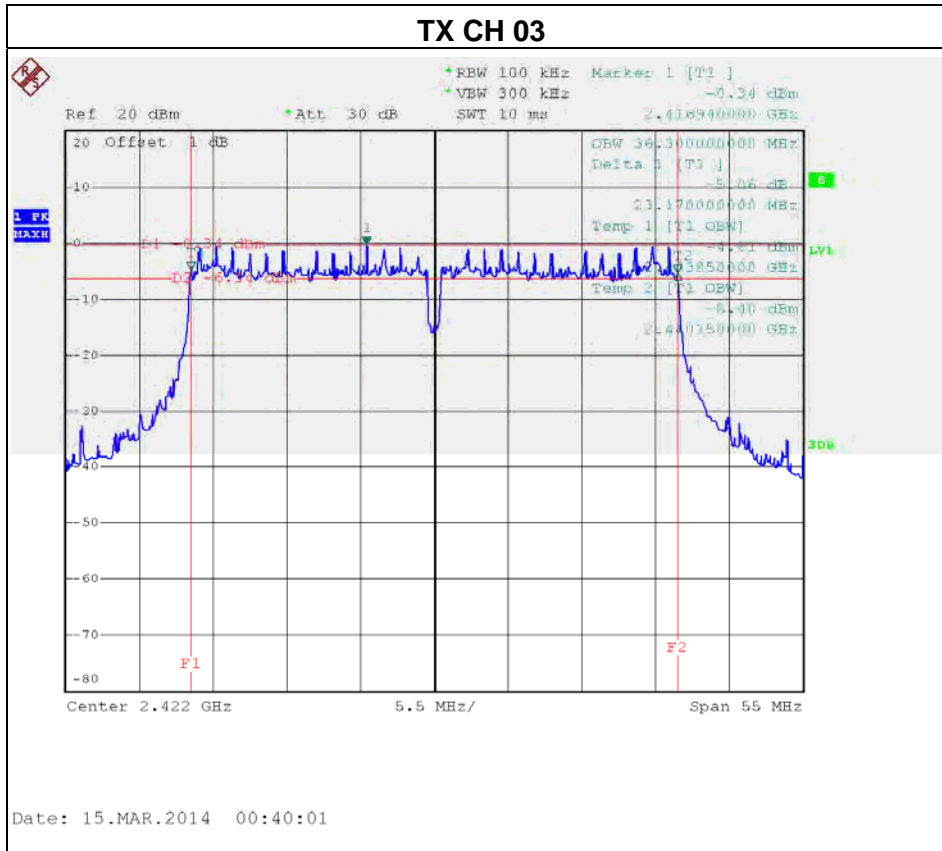

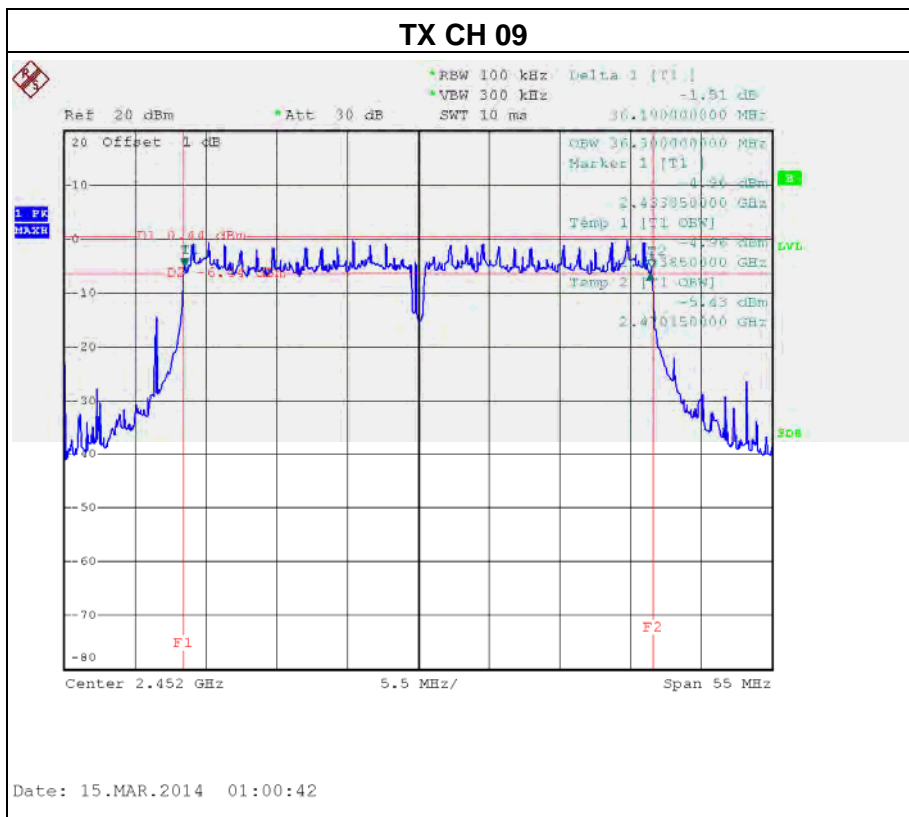
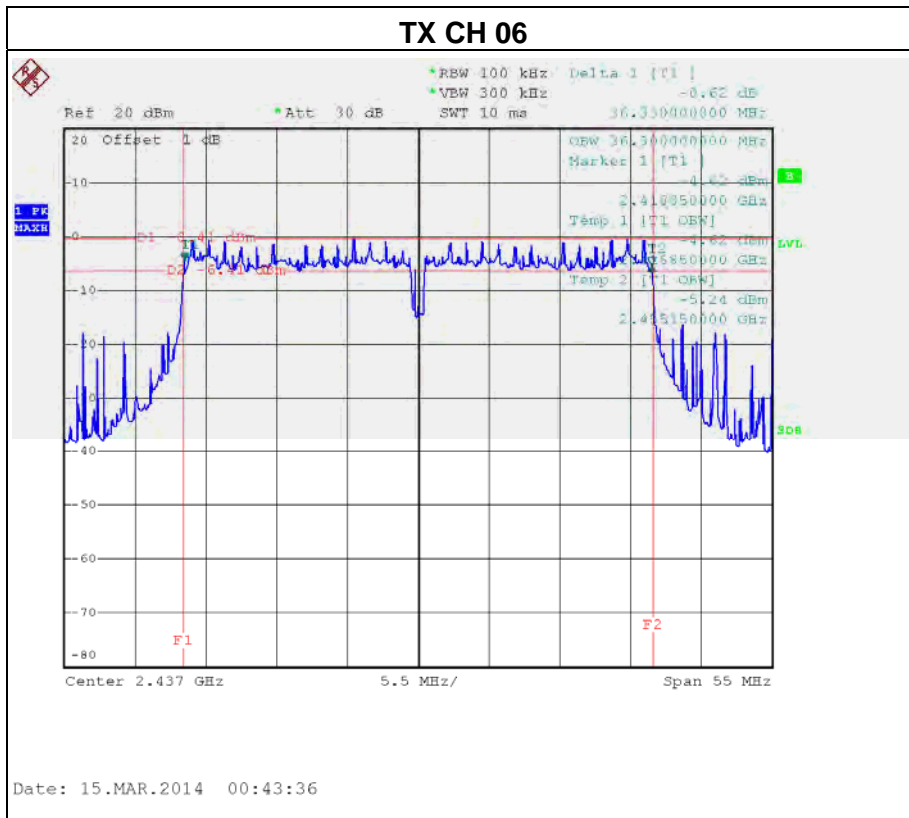



Test Mode : TX N-40MHz Mode_CH03/06/09_ANT 2

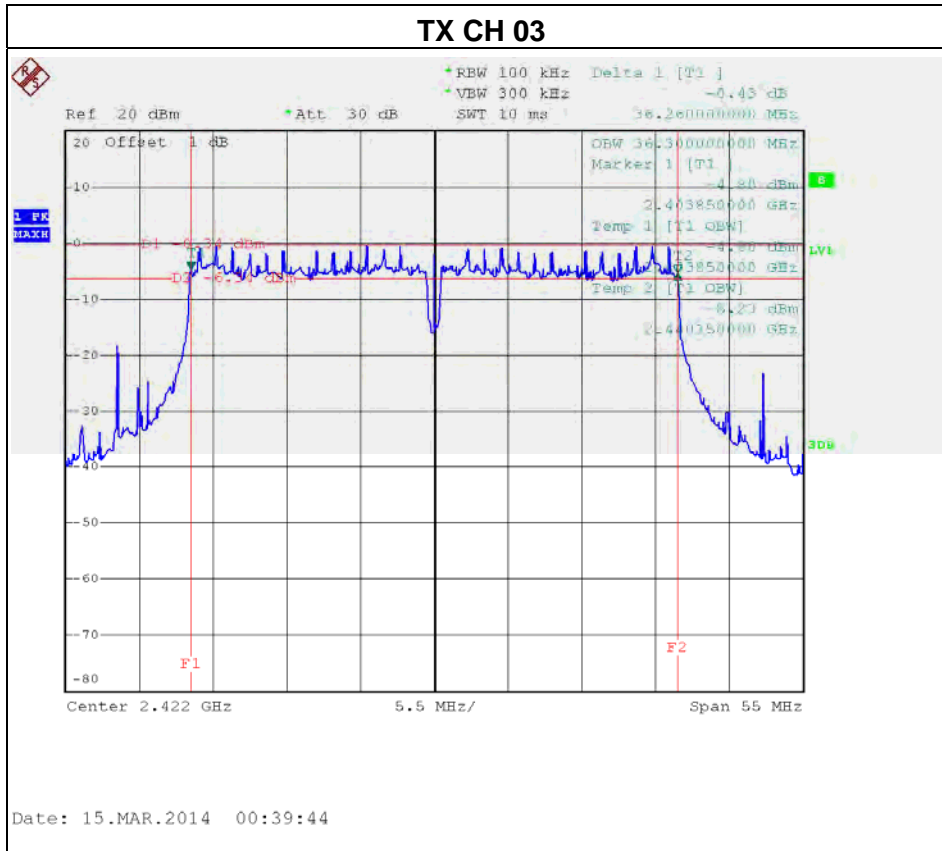

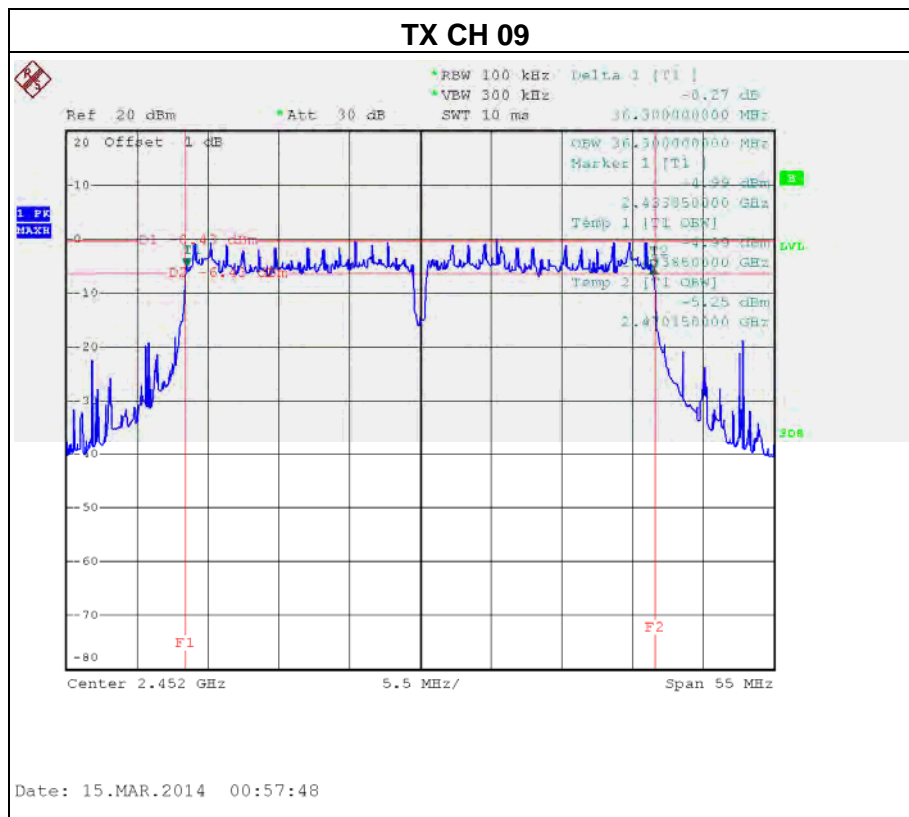
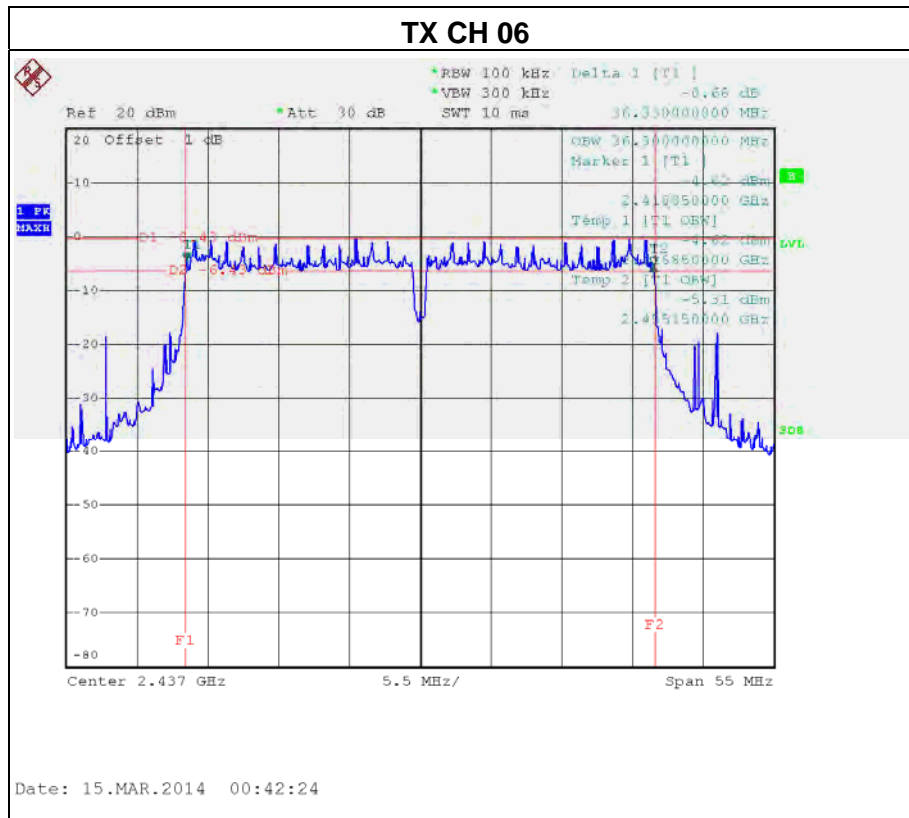



6. MAXIMUM OUTPUT POWER TEST

6.1 Applied procedures / limit

FCC Part15 (15.247) , Subpart C/ RSS-210				
Section	Test Item	Limit	Frequency Range (MHz)	Result
15.247(b)(3) RSS-210 Annex 8.4(4)	Maximum Output Power	1 Watt or 30dBm	2400-2483.5	PASS

6.1.1 TEST PROCEDURE

- a. The EUT was directly connected to the power meter and antenna output port as show in the block diagram below,
- b. The maximum peak conducted output power was performed in accordance with method 9.1.3 of FCC KDB 558074 D01 DTS Meas Guidance v03r01.

6.1.2 DEVIATION FROM STANDARD

No deviation.

6.1.3 TEST SETUP



6.1.4 EUT OPERATION CONDITIONS

The EUT tested system was configured as the statements of 4.1.6 Unless otherwise a special operating condition is specified in the follows during the testing. Transmit output power was measured while the host equipment supply voltage was varied from 85 % to 115 % of the nominal rated supply voltage. No change in transmit output power was observed.

6.1.5 EUT TEST CONDITIONS

Temperature: 25°C
 Relative Humidity: 55%
 Test Voltage: AC 120V/60Hz



6.1.6 TEST RESULTS

Test Mode : TX B Mode_ANT 1

Test Channel	Frequency (MHz)	Output Power (dBm)	Limit (dBm)	Limit (Watt)
CH01	2412	14.20	30	1
CH06	2437	14.47	30	1
CH11	2462	14.49	30	1

Test Mode : TX B Mode_ANT 2

Test Channel	Frequency (MHz)	Output Power (dBm)	Limit (dBm)	Limit (Watt)
CH01	2412	14.26	30	1
CH06	2437	14.24	30	1
CH11	2462	14.11	30	1

Test Mode : TX B Mode_Total

Test Channel	Frequency (MHz)	Output Power (dBm)	Limit (dBm)	Limit (Watt)
CH01	2412	17.24	30	1
CH06	2437	17.37	30	1
CH11	2462	17.32	30	1



Test Mode : TX G Mode_ANT 1				
Test Channel	Frequency (MHz)	Output Power (dBm)	Limit (dBm)	Limit (Watt)
CH01	2412	20.37	30	1
CH06	2437	20.52	30	1
CH11	2462	20.47	30	1

Test Mode : TX G Mode_ANT 2				
Test Channel	Frequency (MHz)	Output Power (dBm)	Limit (dBm)	Limit (Watt)
CH01	2412	19.69	30	1
CH06	2437	20.03	30	1
CH11	2462	19.49	30	1

Test Mode : TX G Mode_Total				
Test Channel	Frequency (MHz)	Output Power (dBm)	Limit (dBm)	Limit (Watt)
CH01	2412	23.05	30	1
CH06	2437	23.29	30	1
CH11	2462	23.02	30	1



Test Mode : TX N-20M Mode_ANT 1

Test Channel	Frequency (MHz)	Output Power (dBm)	Limit (dBm)	Limit (Watt)
CH01	2412	19.90	30	1
CH06	2437	20.09	30	1
CH11	2462	19.93	30	1

Test Mode : TX N-20M Mode_ANT 2

Test Channel	Frequency (MHz)	Output Power (dBm)	Limit (dBm)	Limit (Watt)
CH01	2412	20.74	30	1
CH06	2437	20.40	30	1
CH11	2462	20.01	30	1

Test Mode : TX N-20M Mode_Total

Test Channel	Frequency (MHz)	Output Power (dBm)	Limit (dBm)	Limit (Watt)
CH01	2412	23.35	30	1
CH06	2437	23.26	30	1
CH11	2462	22.98	30	1



Test Mode : TX N-40M Mode_ANT 1

Test Channel	Frequency (MHz)	Output Power (dBm)	Limit (dBm)	Limit (Watt)
CH03	2422	20.10	30	1
CH06	2437	20.04	30	1
CH09	2452	20.11	30	1

Test Mode : TX N-40M Mode_ANT 2

Test Channel	Frequency (MHz)	Output Power (dBm)	Limit (dBm)	Limit (Watt)
CH03	2422	19.06	30	1
CH06	2437	20.48	30	1
CH09	2452	20.05	30	1

Test Mode : TX N-40M Mode_Total

Test Channel	Frequency (MHz)	Output Power (dBm)	Limit (dBm)	Limit (Watt)
CH03	2422	22.62	30	1
CH06	2437	23.28	30	1
CH09	2452	23.09	30	1



7. ANTENNA CONDUCTED SPURIOUS EMISSION

7.1 Applied procedures / limit

In any 100 kHz bandwidth outside the frequency band in which the spread spectrum or digitally modulated intentional radiator is operating, the radio frequency power that is produced by the intentional radiator shall be at least 20 dB below that in the 100 kHz bandwidth within the band that contains the highest level of the desired power, based on either an RF conducted measurement, provided the transmitter demonstrates compliance with the peak conducted power limits.

7.1.1 TEST PROCEDURE

- a. The EUT was directly connected to the spectrum analyzer and antenna output port as show in the block diagram below,
- b. Spectrum Setting: RBW= 100KHz, VBW=300KHz, Sweep time = Auto.

7.1.2 DEVIATION FROM STANDARD

No deviation.

7.1.3 TEST SETUP



7.1.4 EUT OPERATION CONDITIONS

The EUT tested system was configured as the statements of 4.1.6 Unless otherwise a special operating condition is specified in the follows during the testing.

7.1.5 EUT TEST CONDITIONS

Temperature: 25°C
Relative Humidity: 55%
Test Voltage: AC 120V/60Hz



7.1.6 TEST RESULTS

Test Mode :	TX B Mode_ANT 1
-------------	-----------------

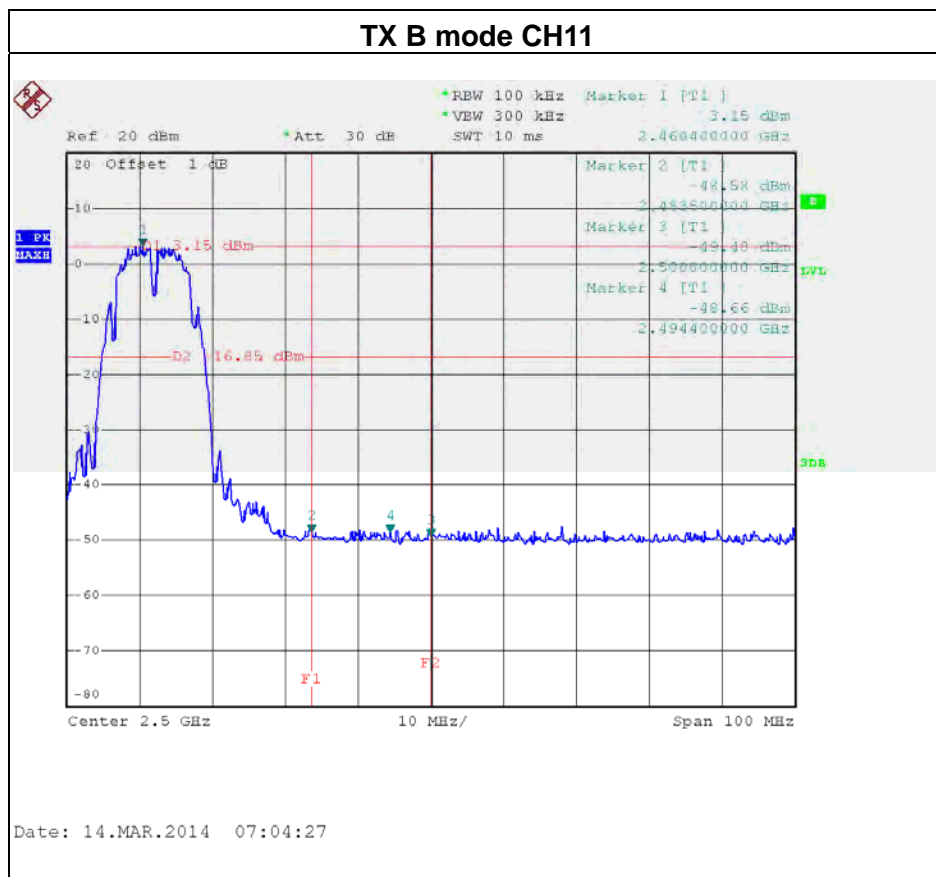
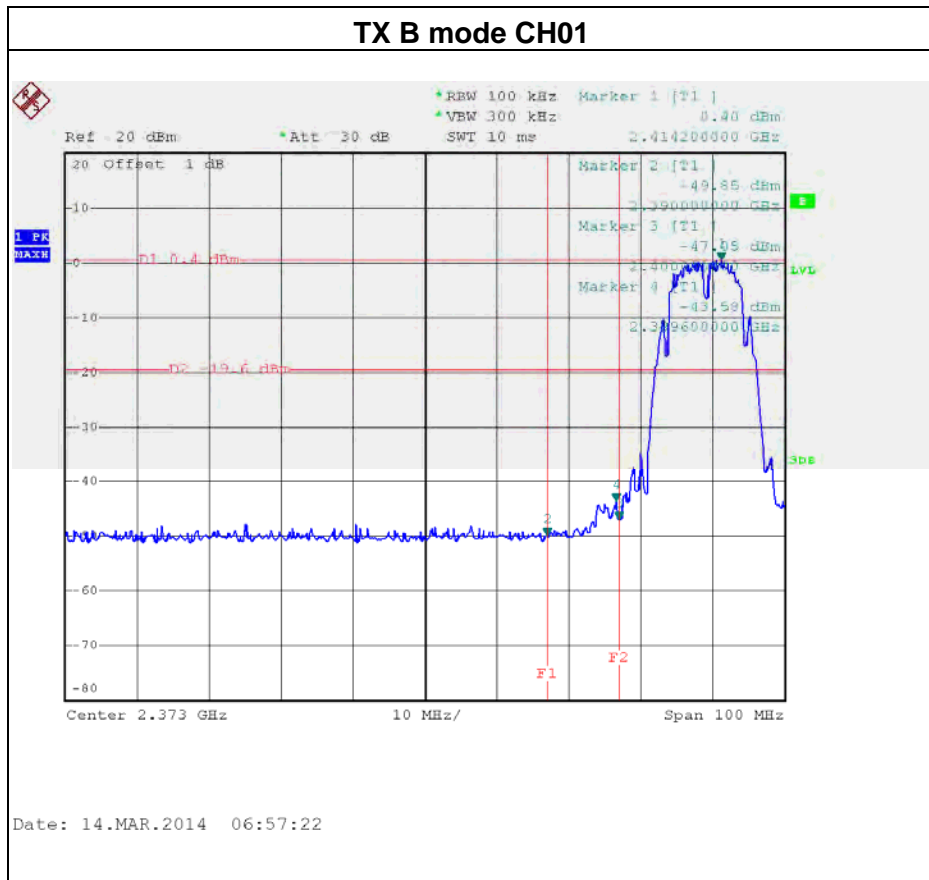

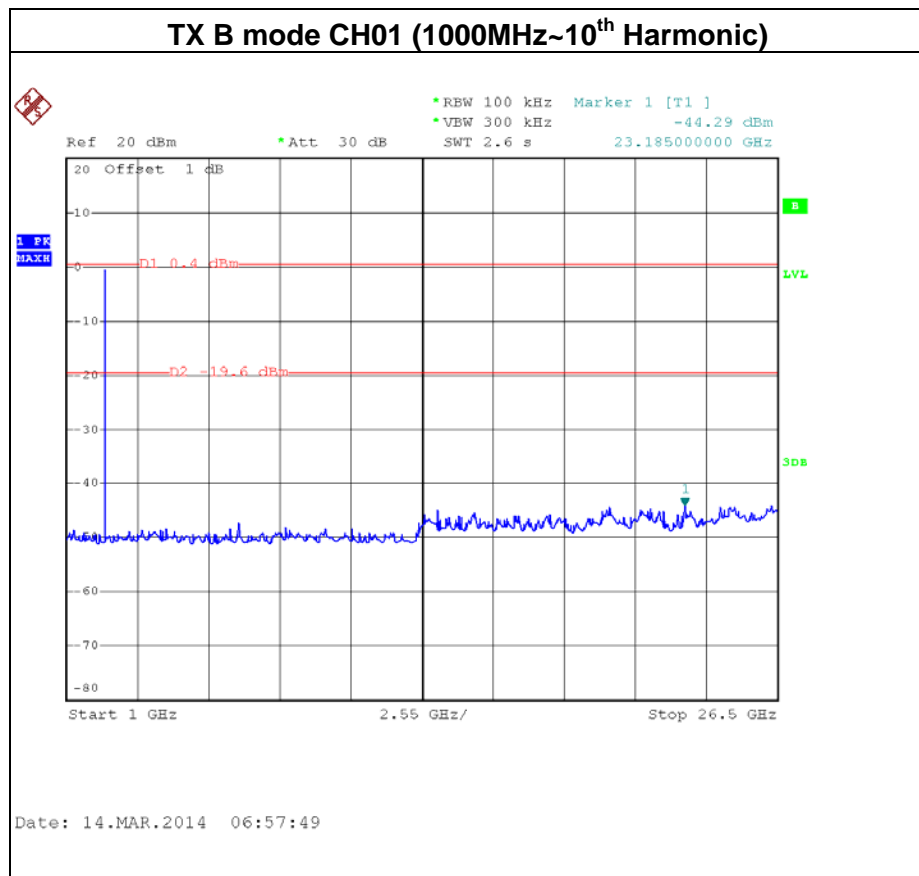
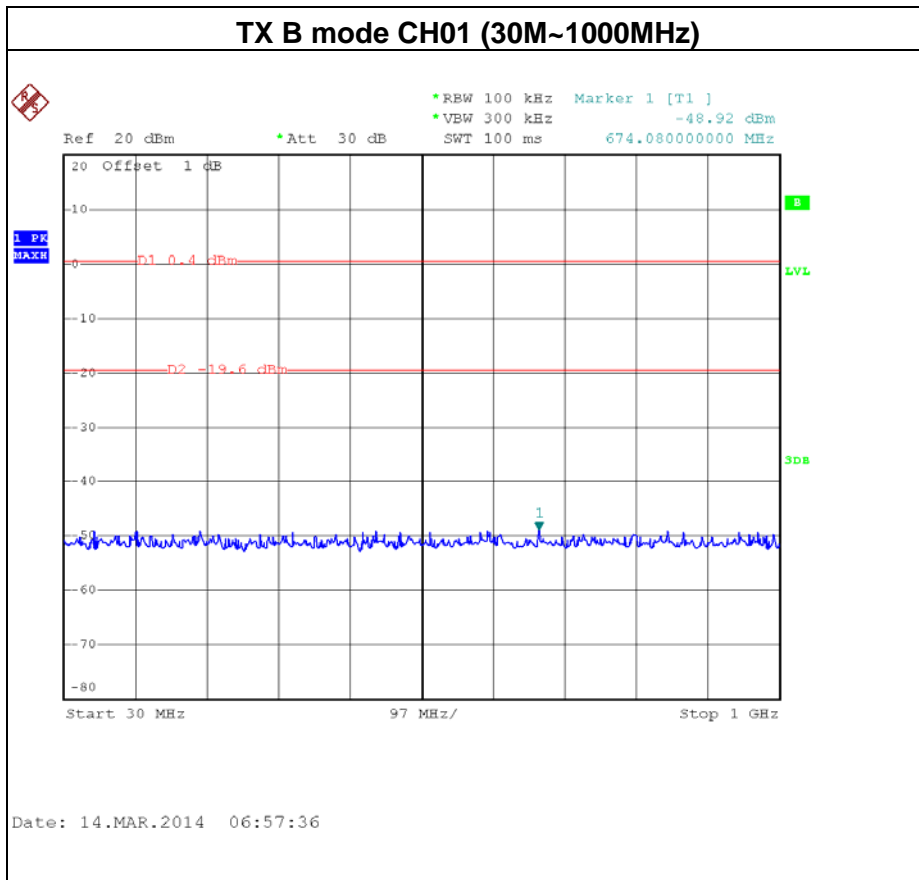

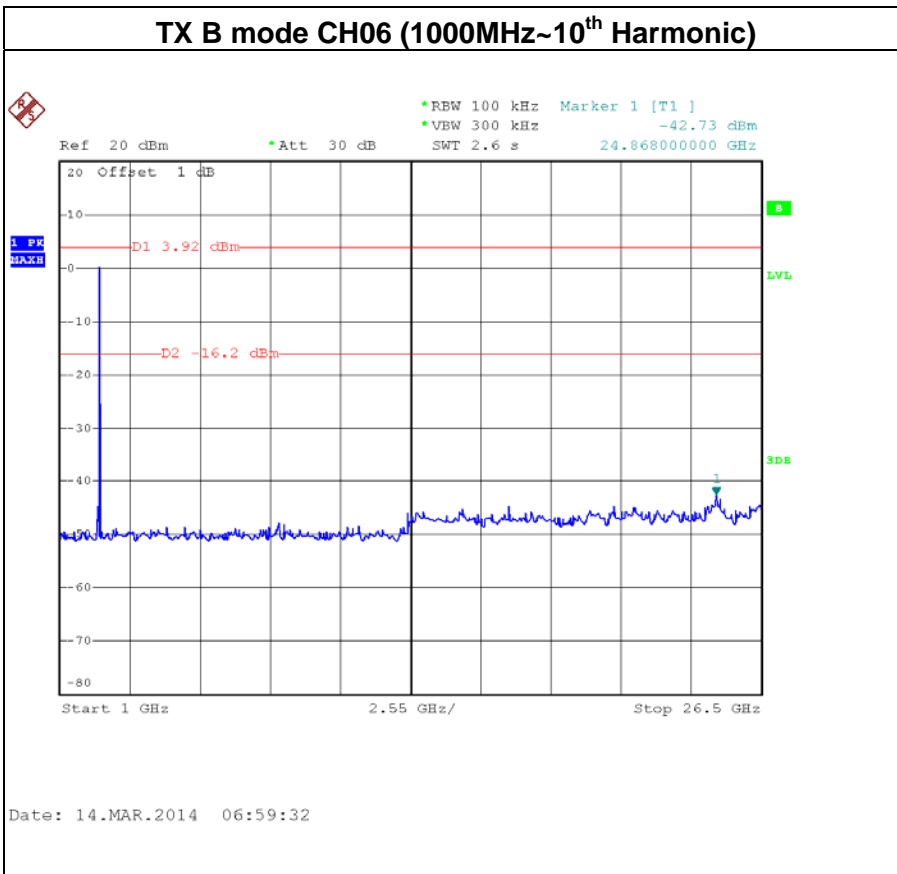
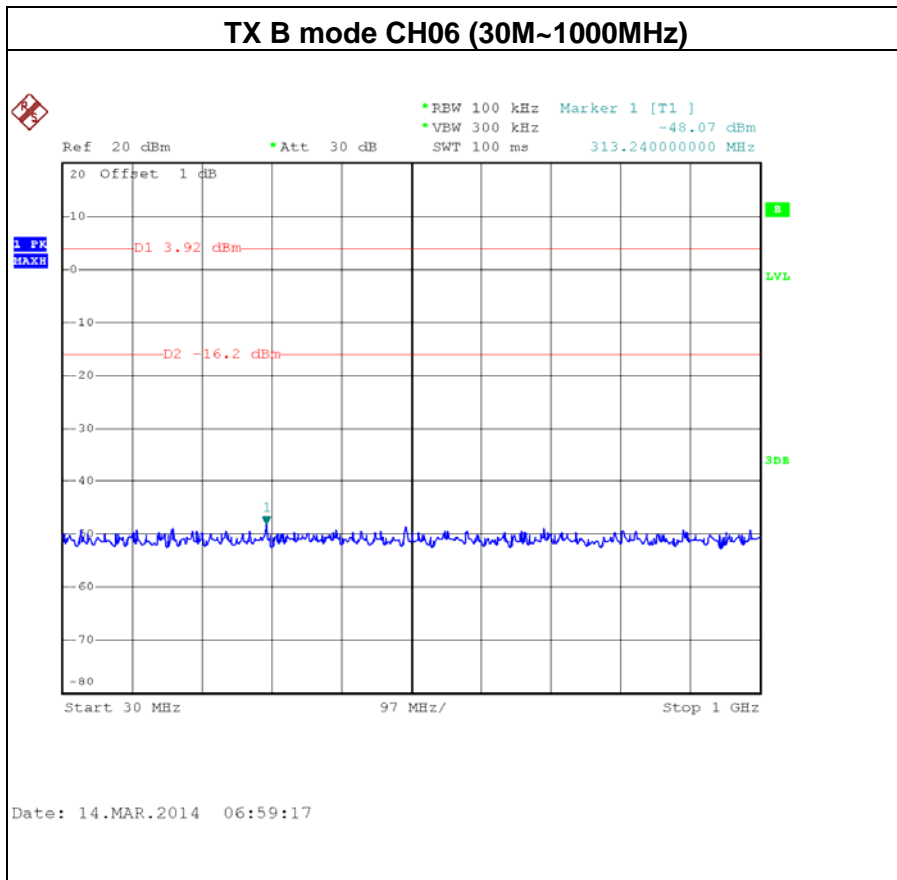

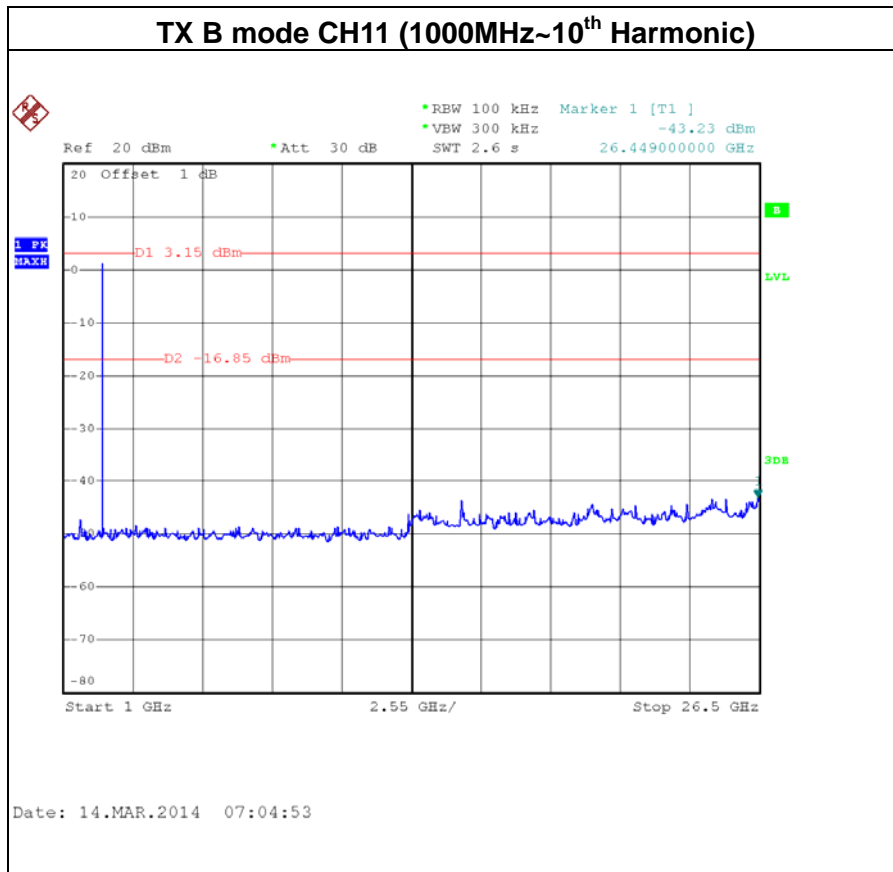
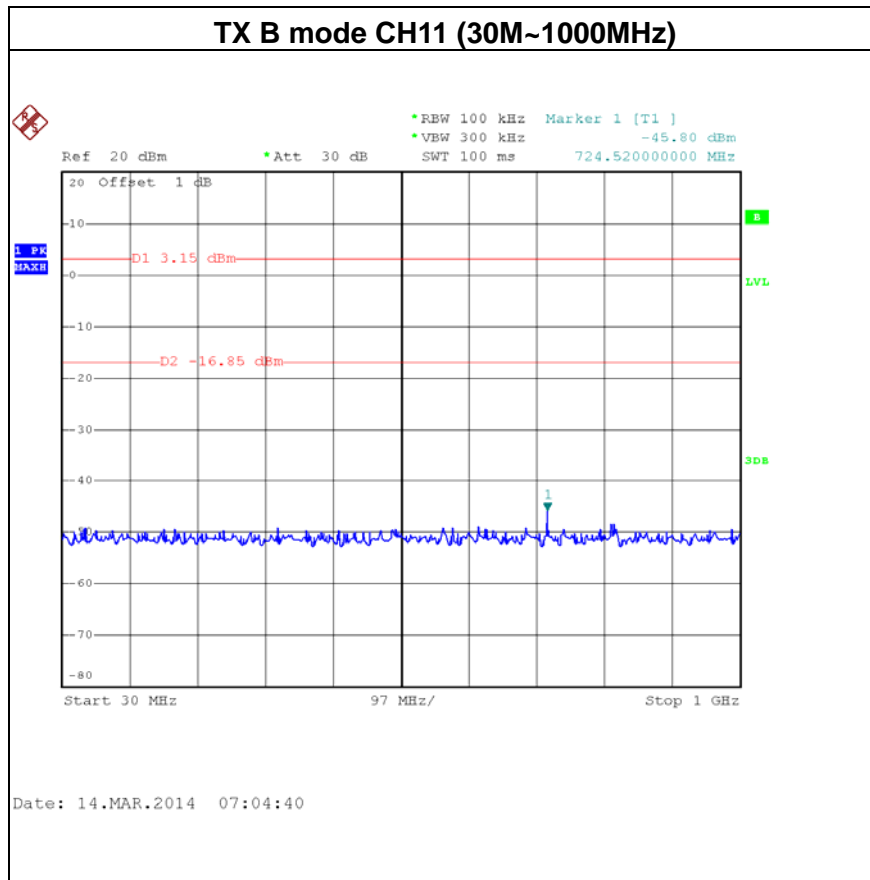



Test Mode :	TX B Mode_ANT 2
-------------	-----------------

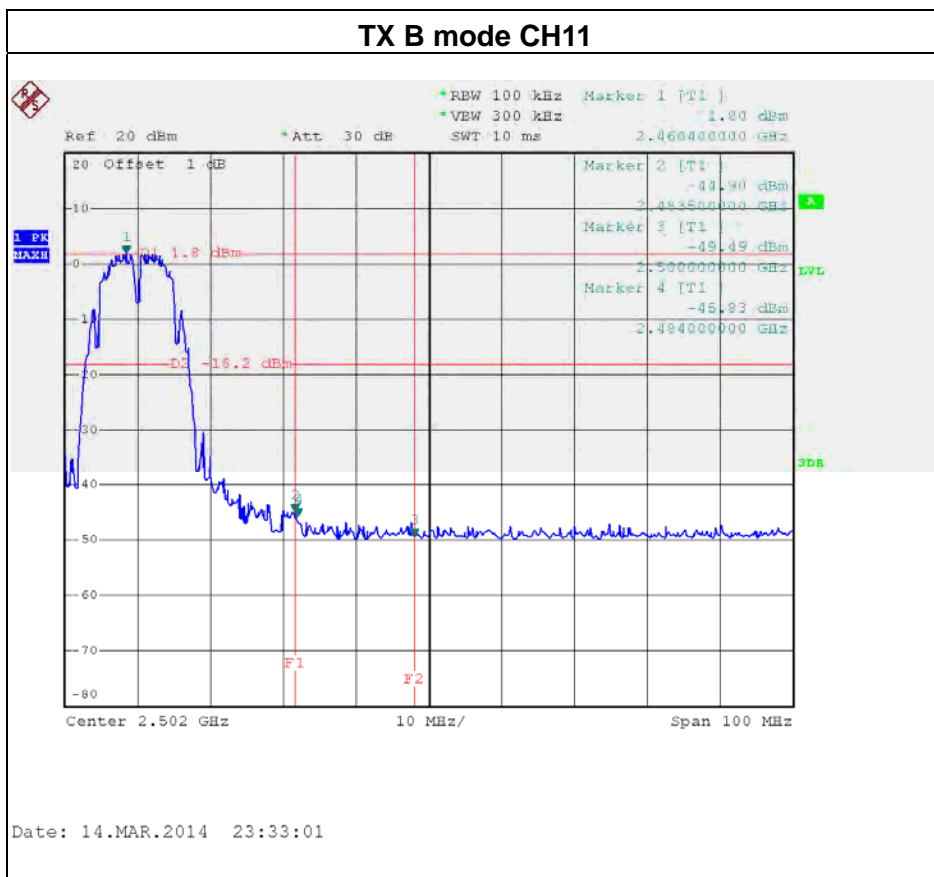
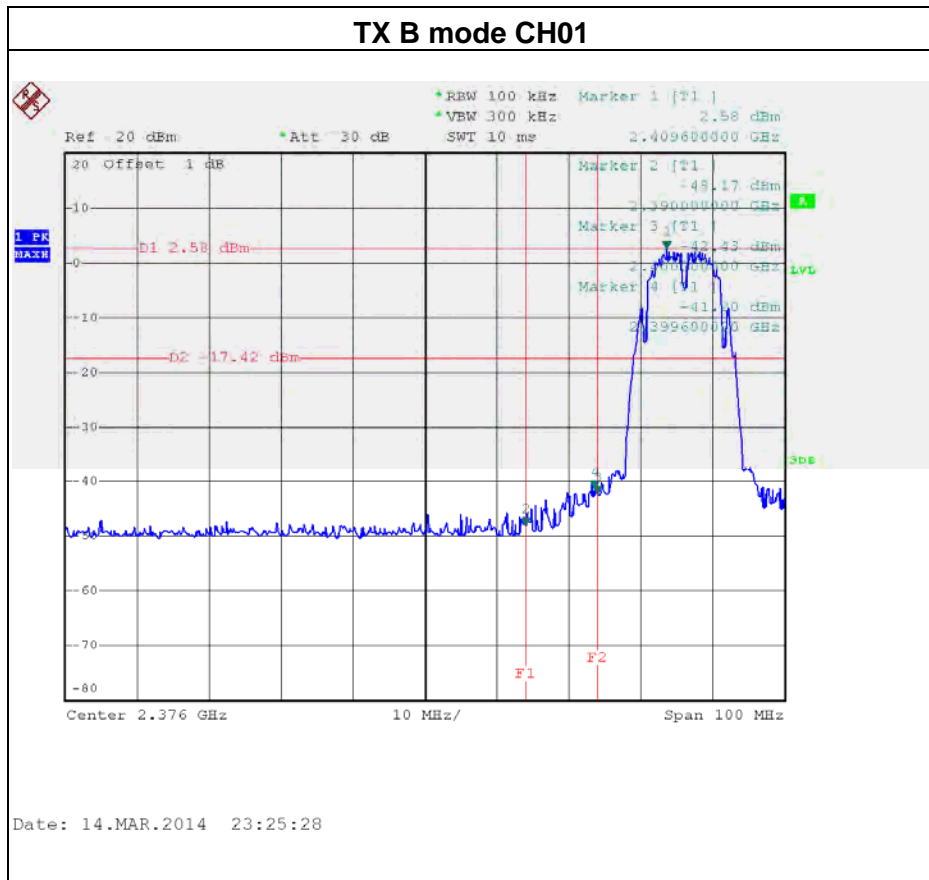

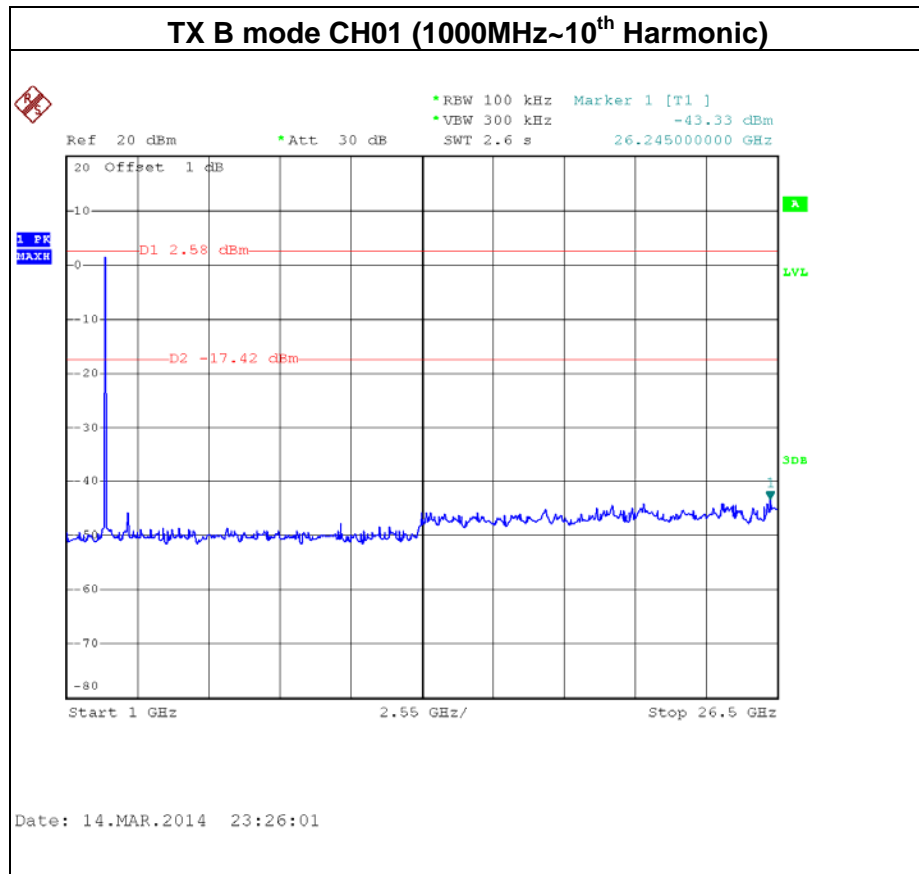
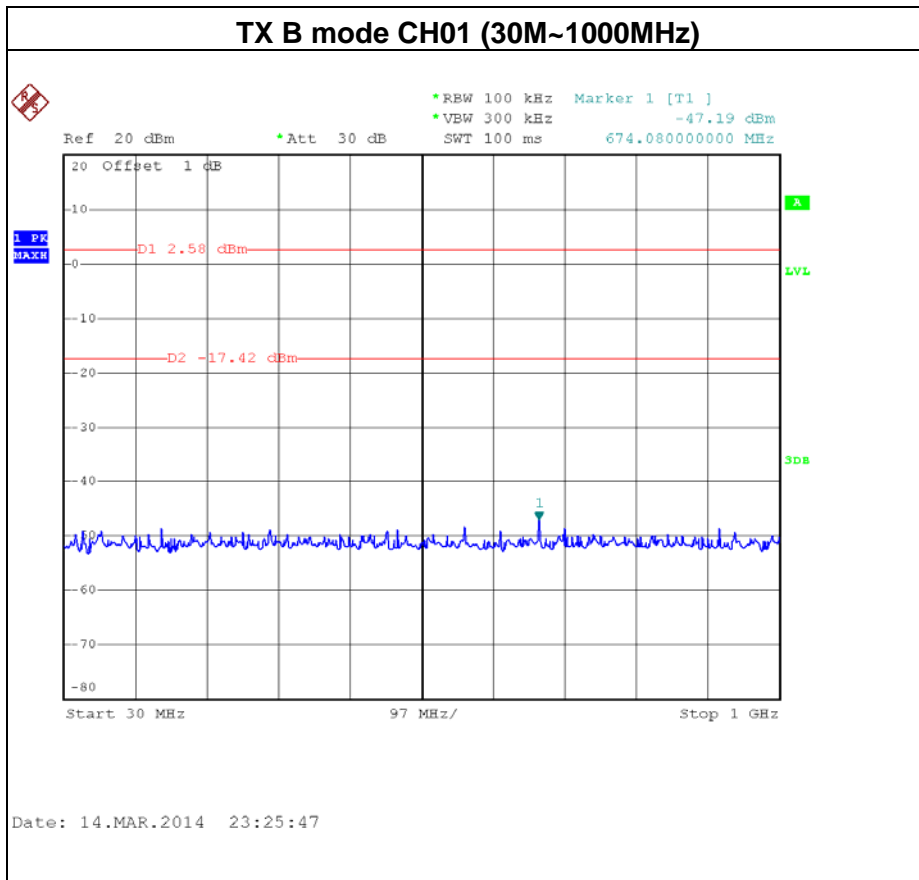

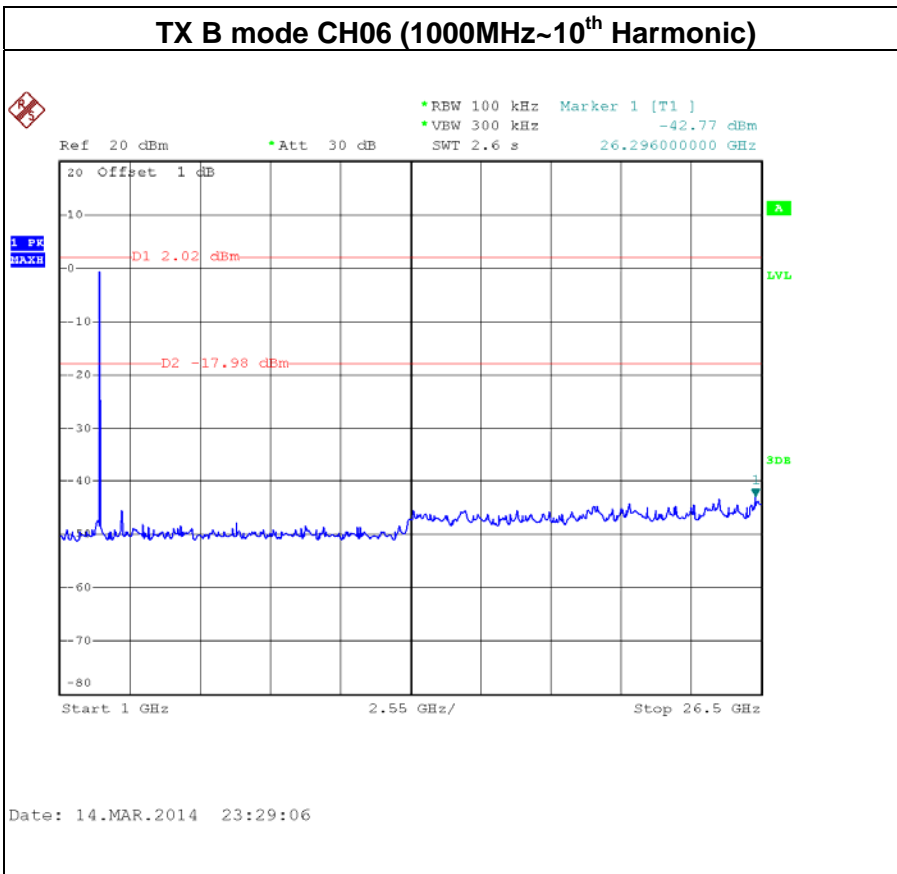
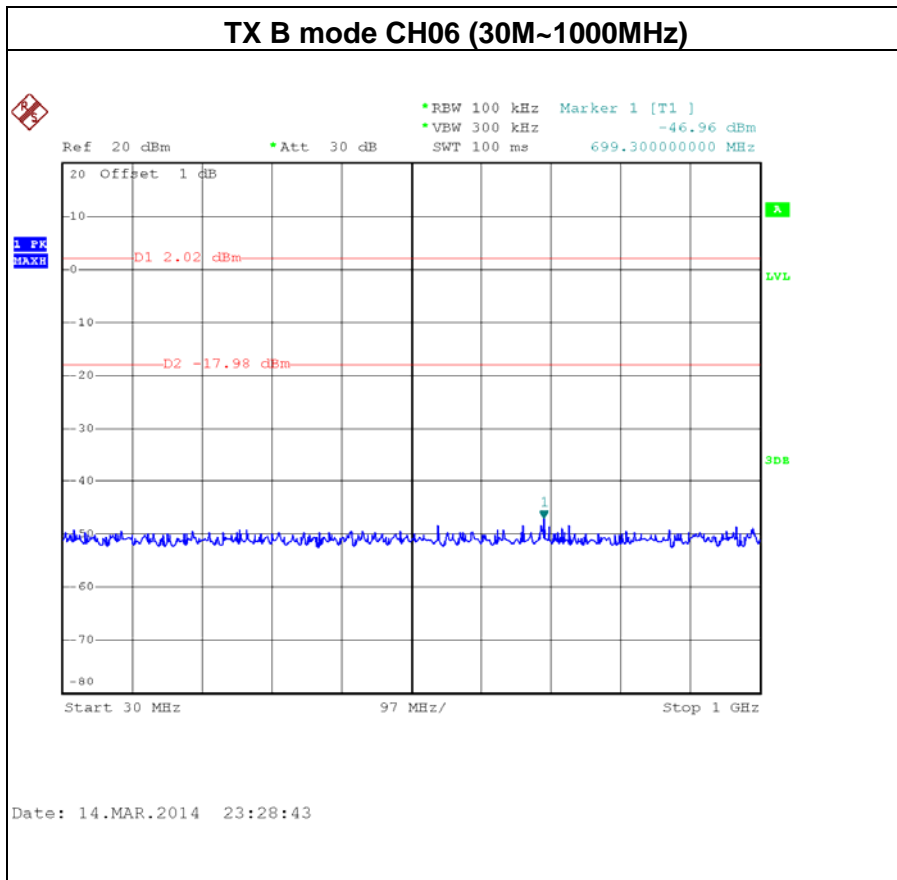

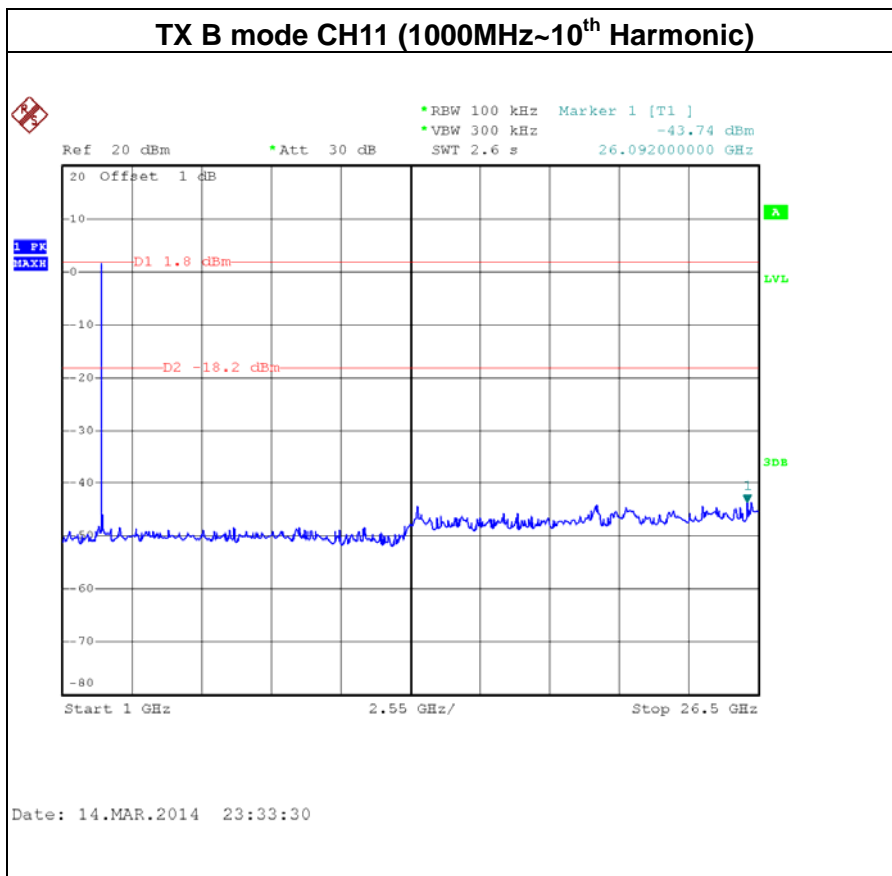
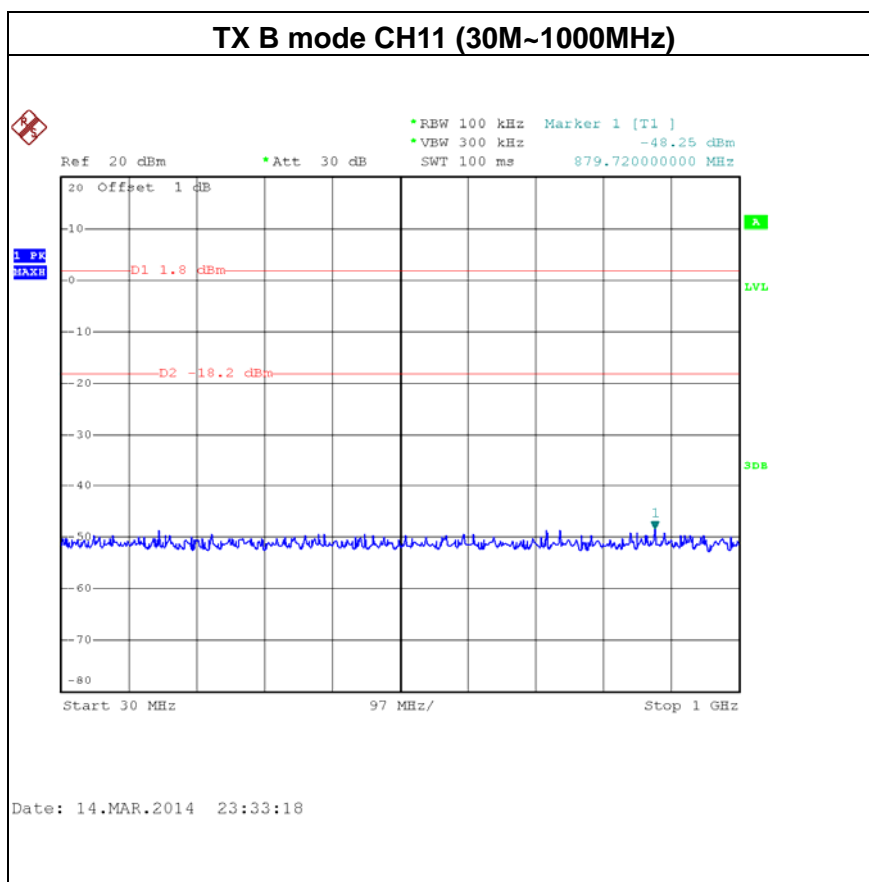



Test Mode :	TX G Mode_ANT 1
-------------	-----------------

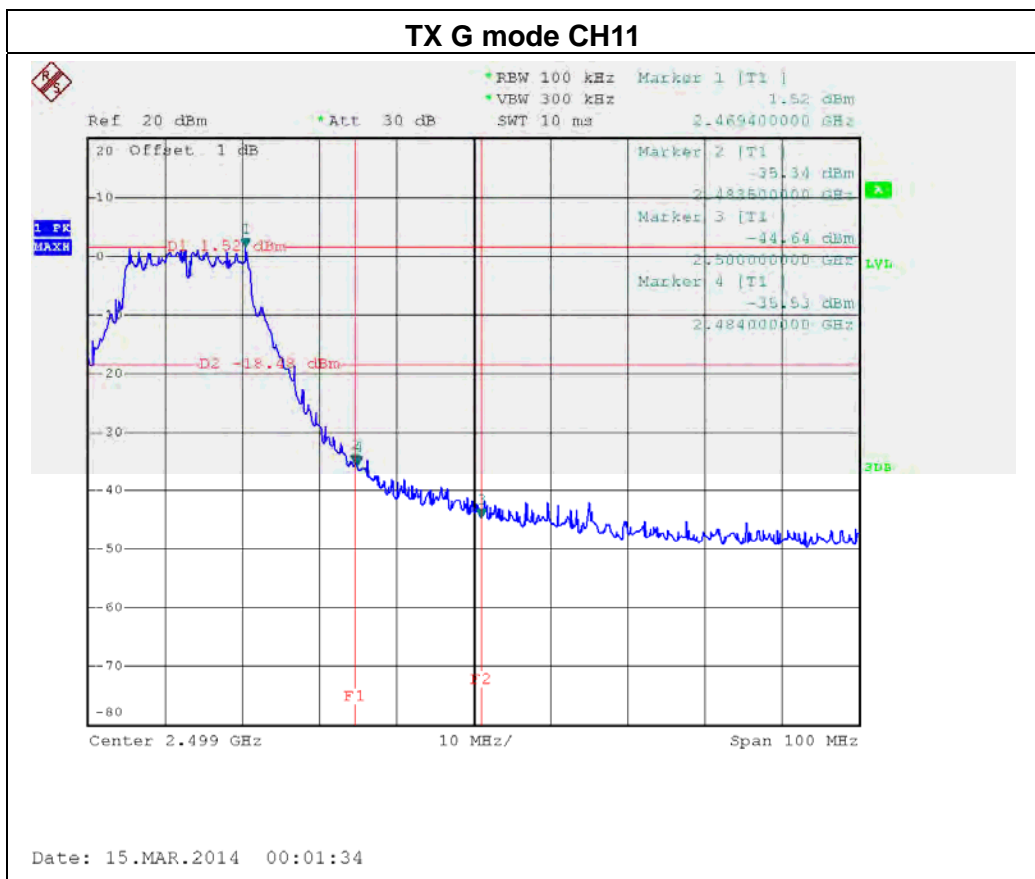
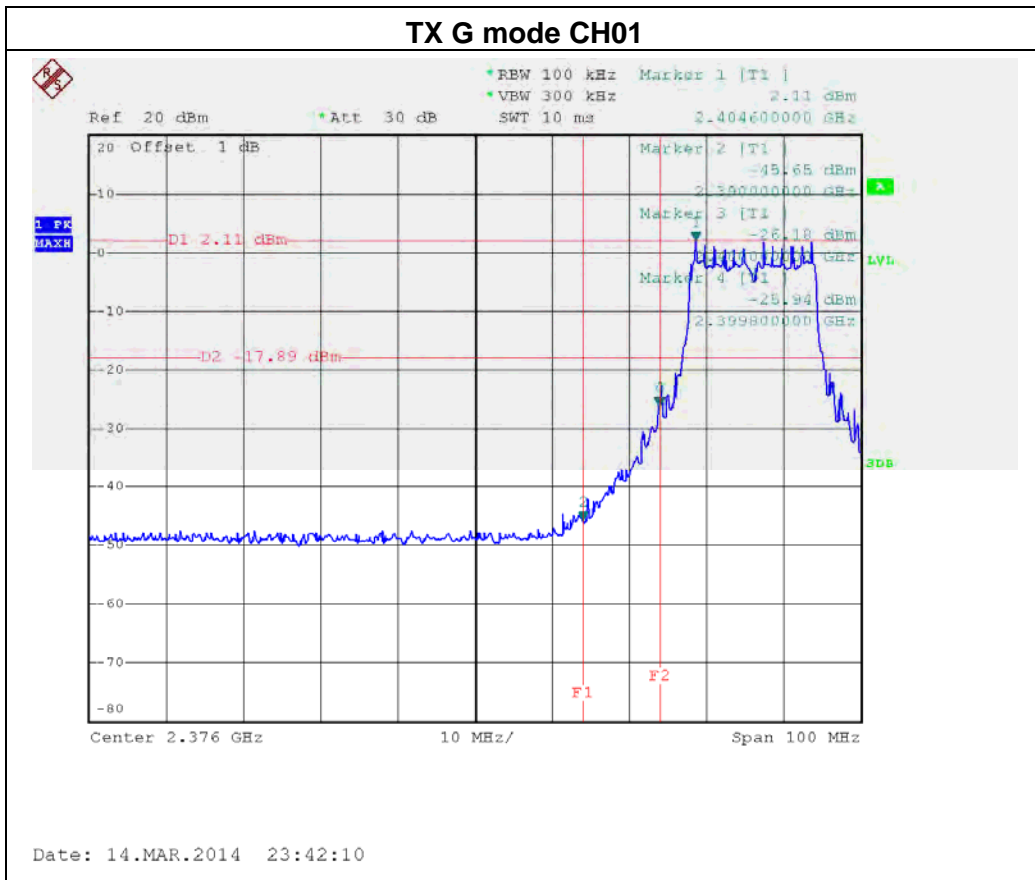

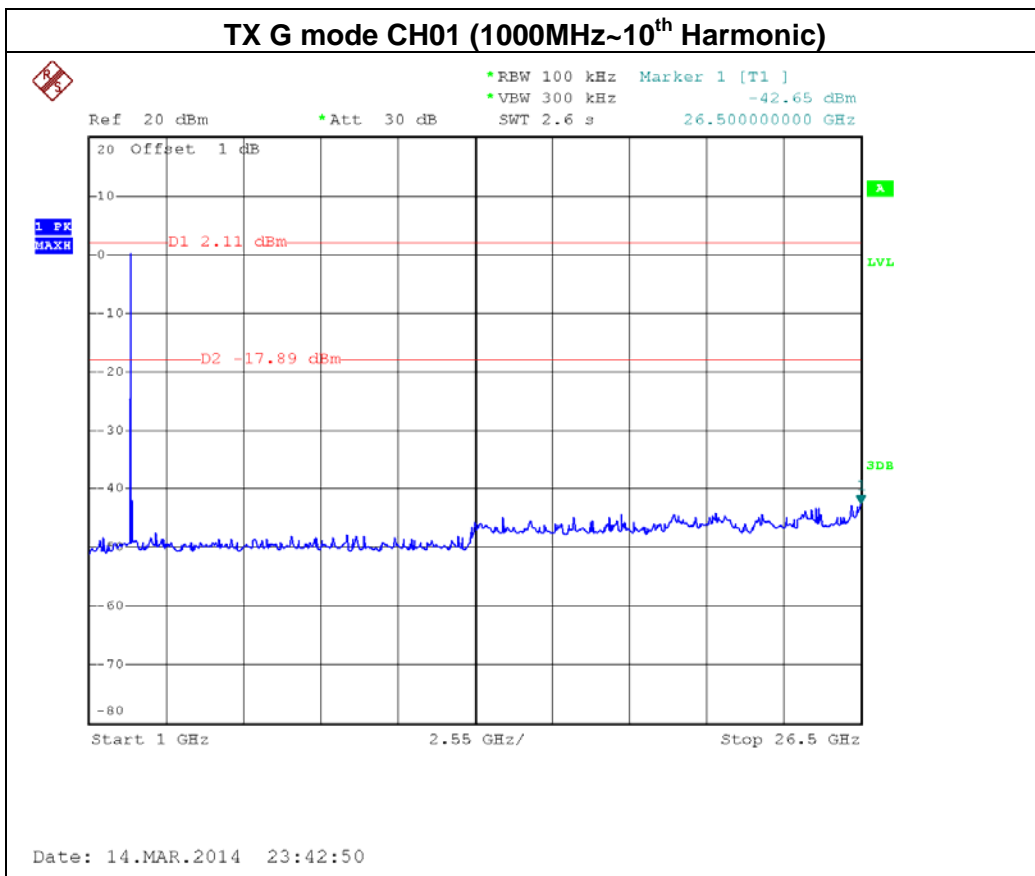
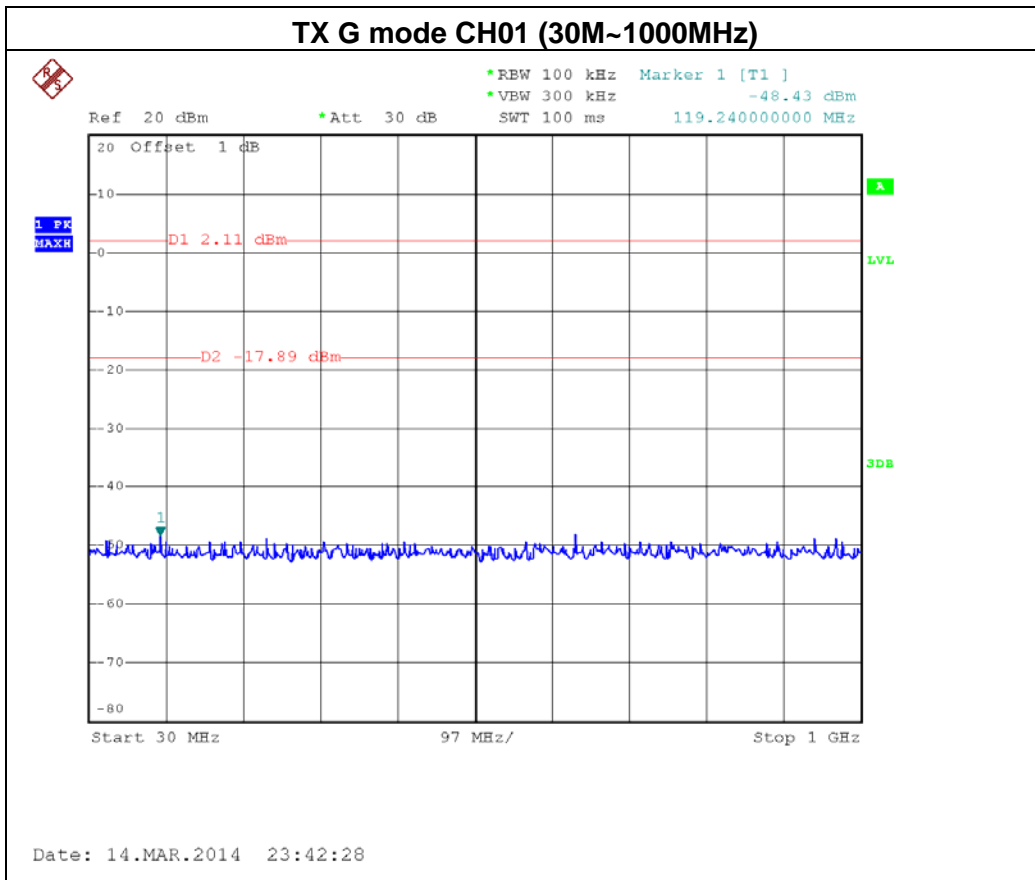

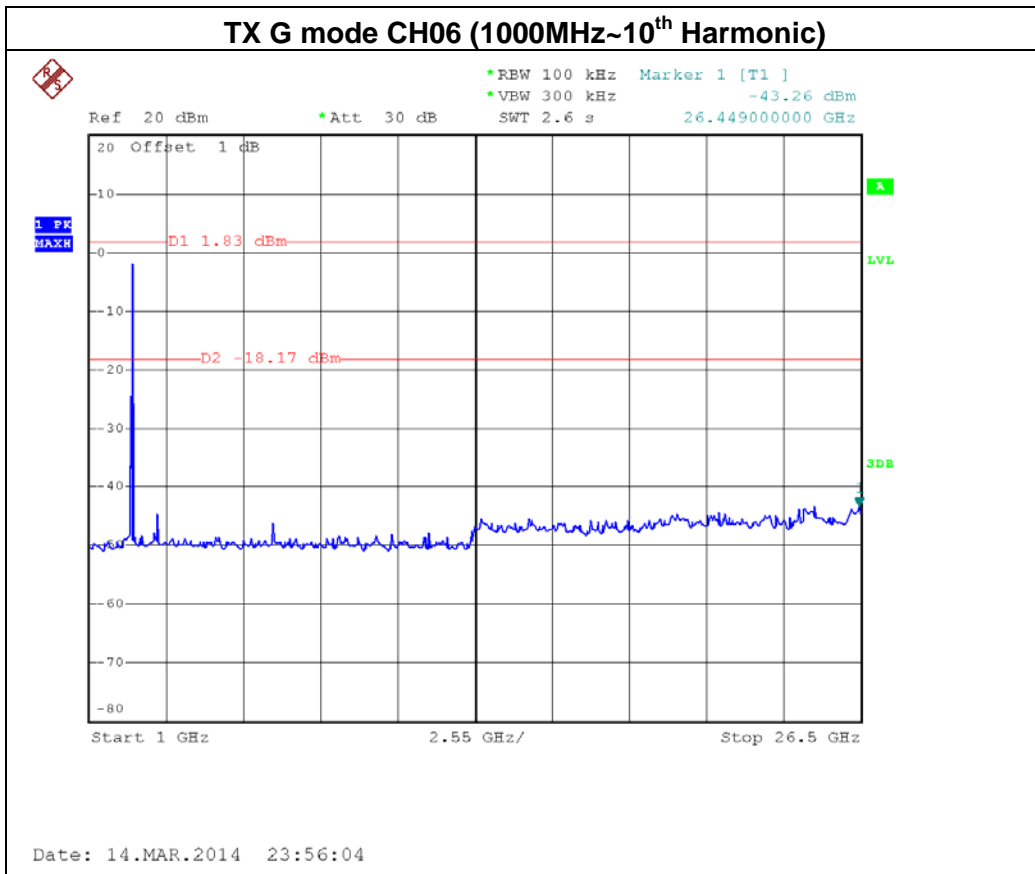
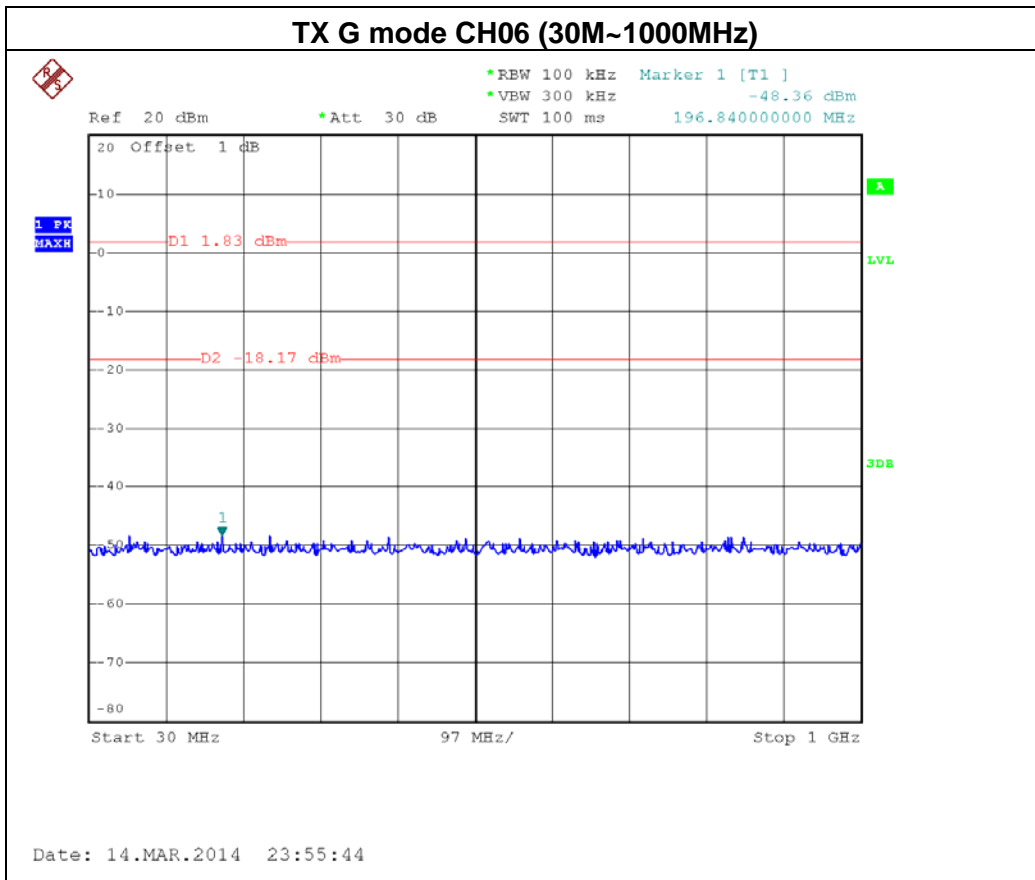

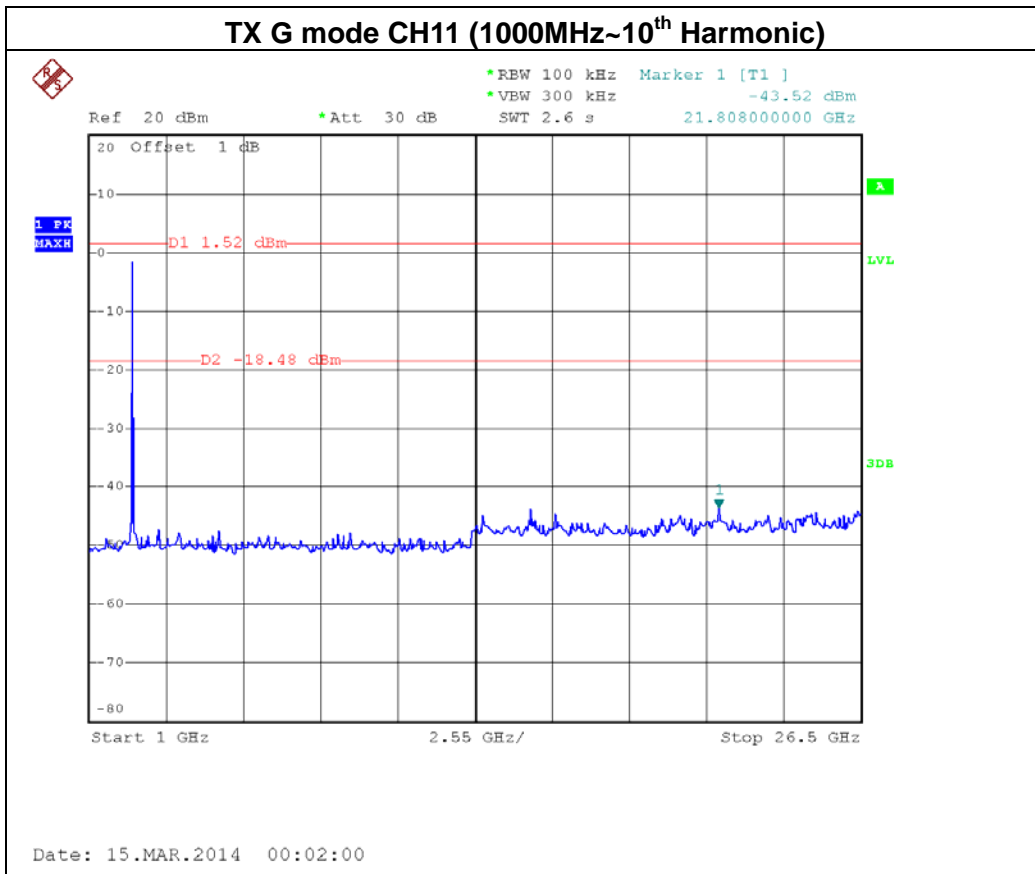
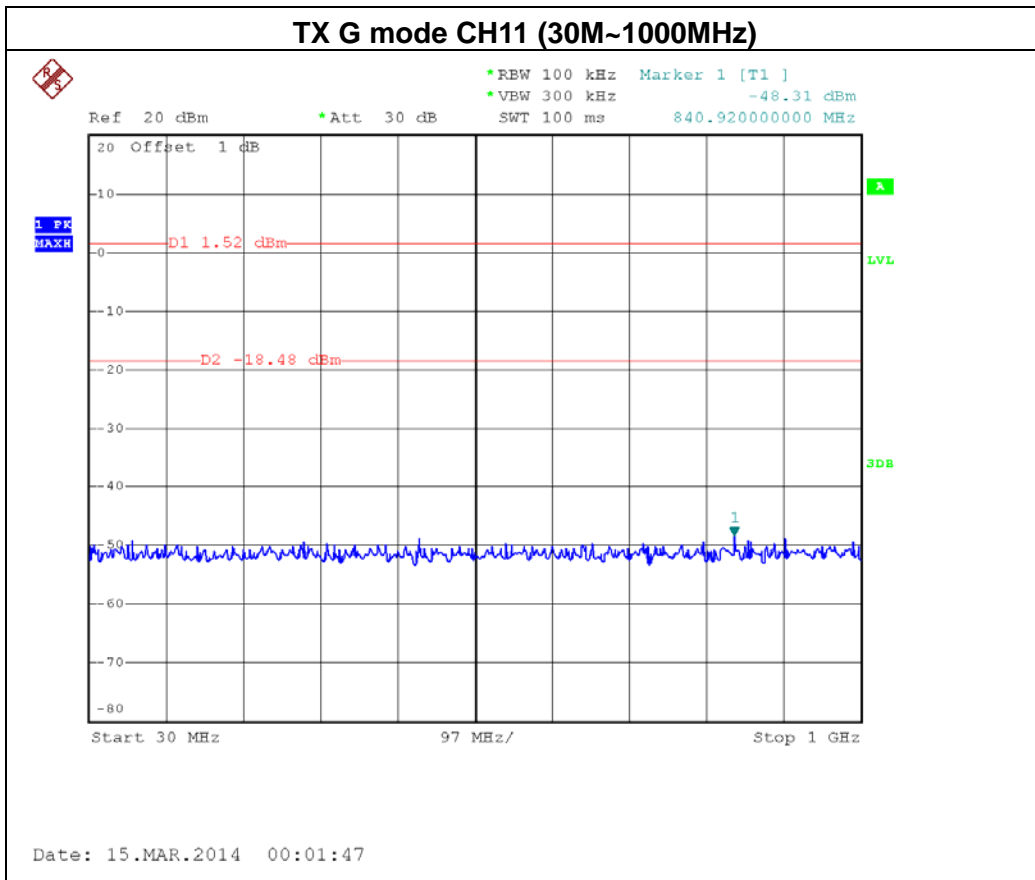



Test Mode :	TX G Mode_ANT 2
-------------	-----------------

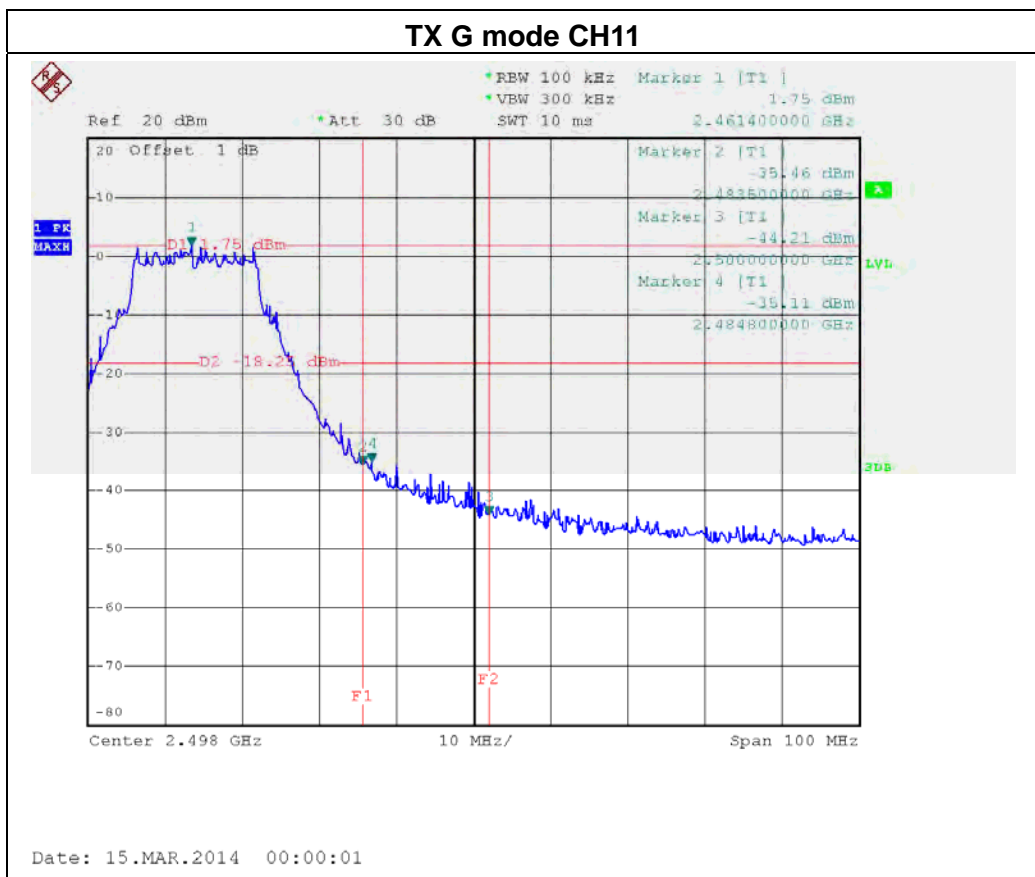
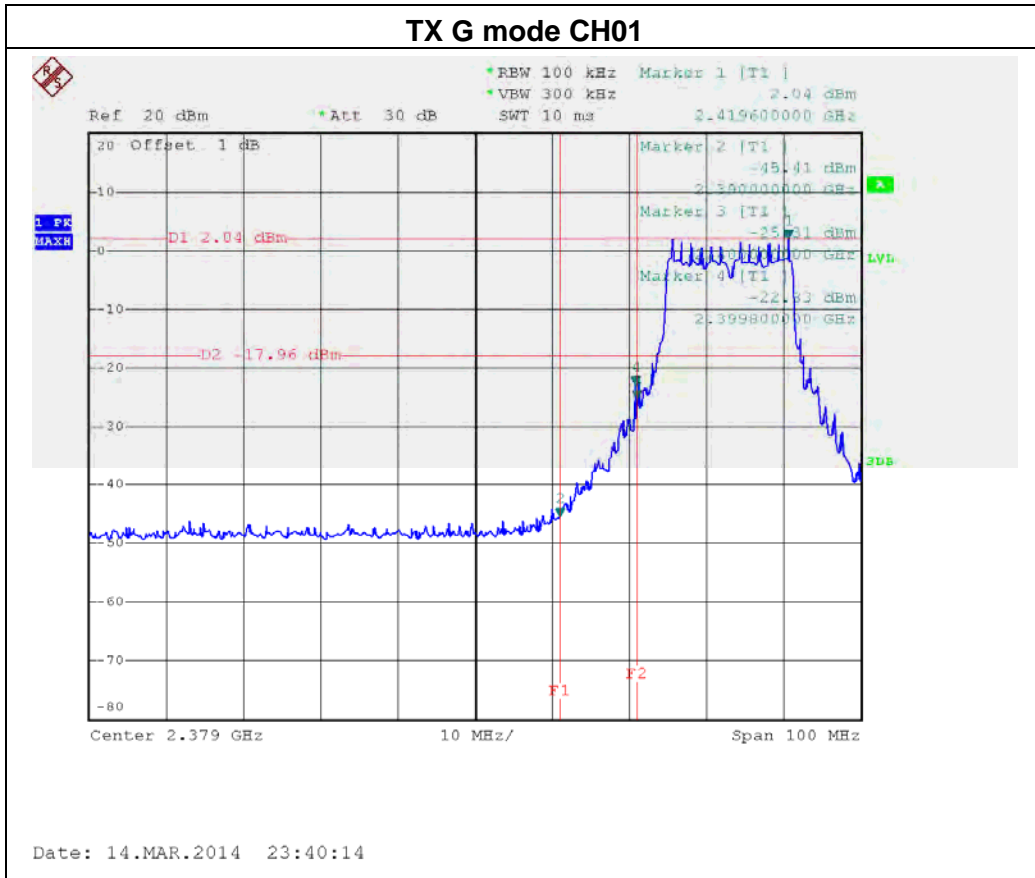

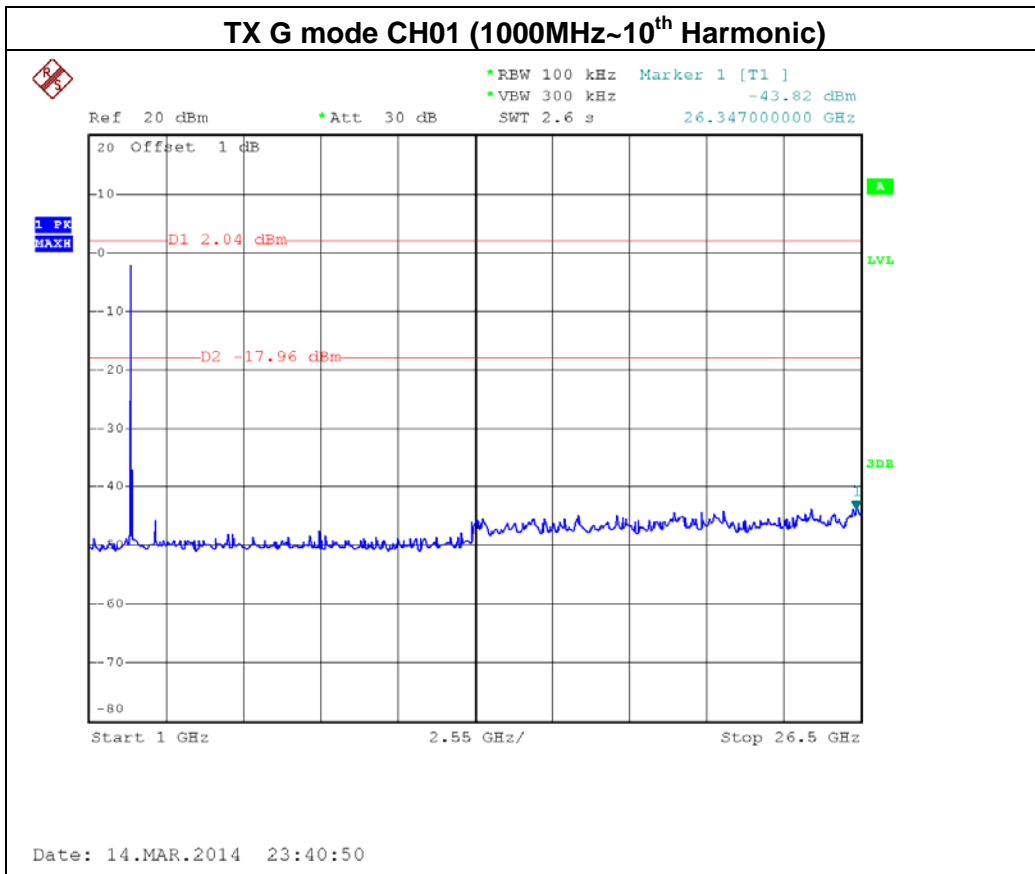
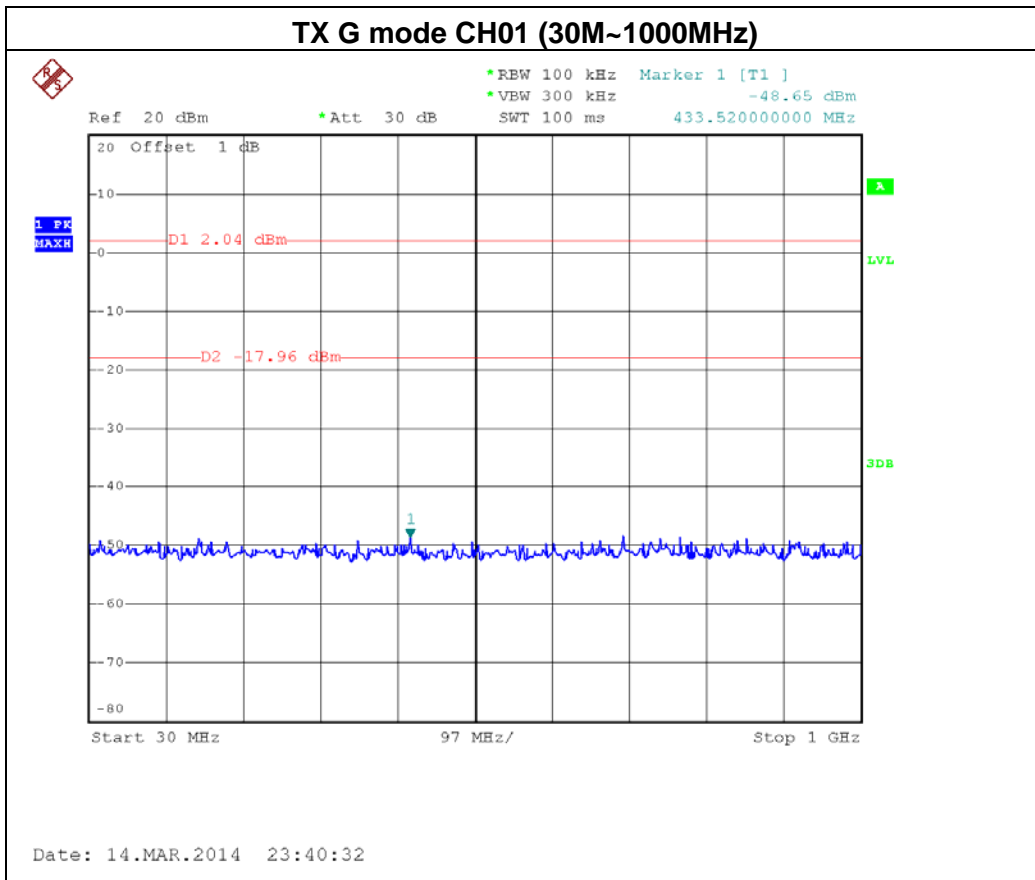

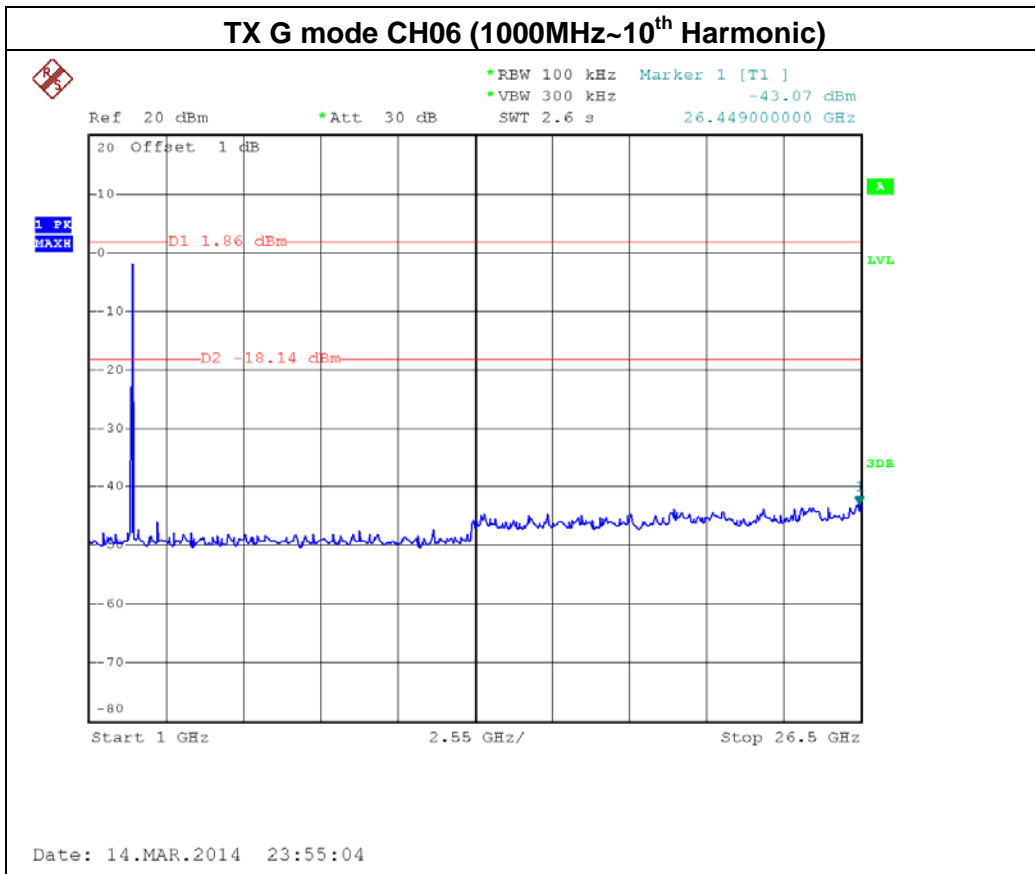
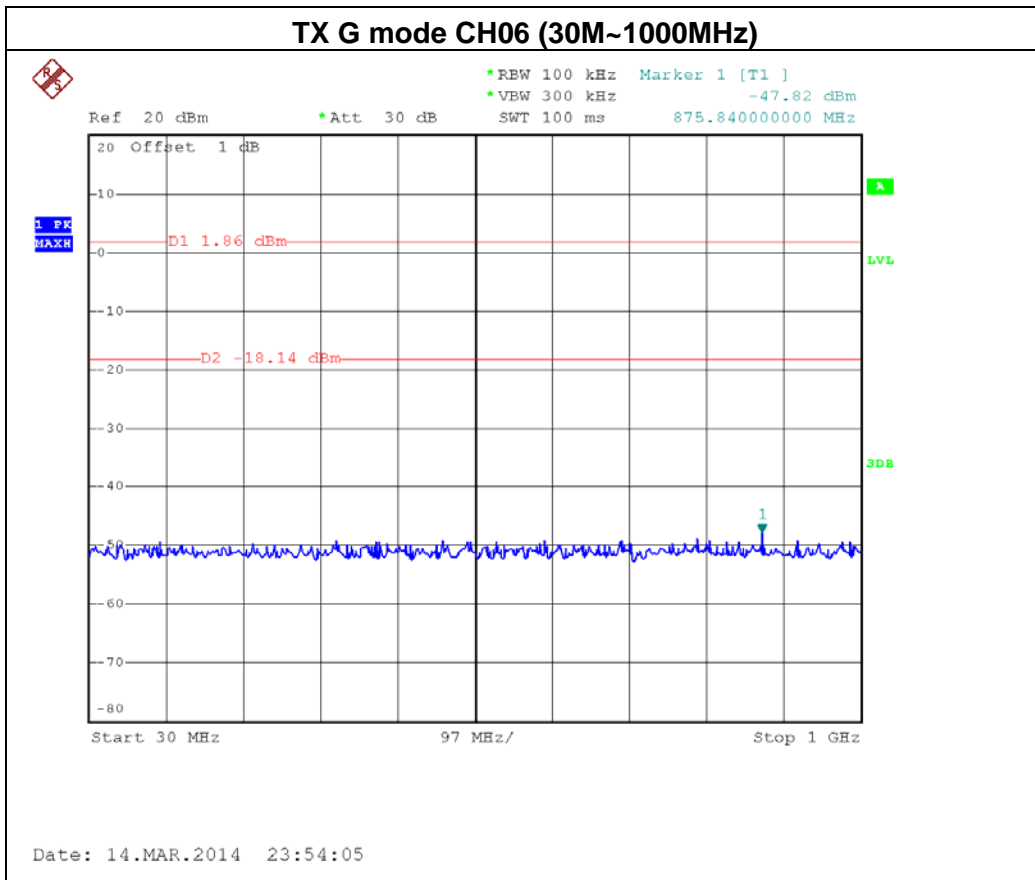

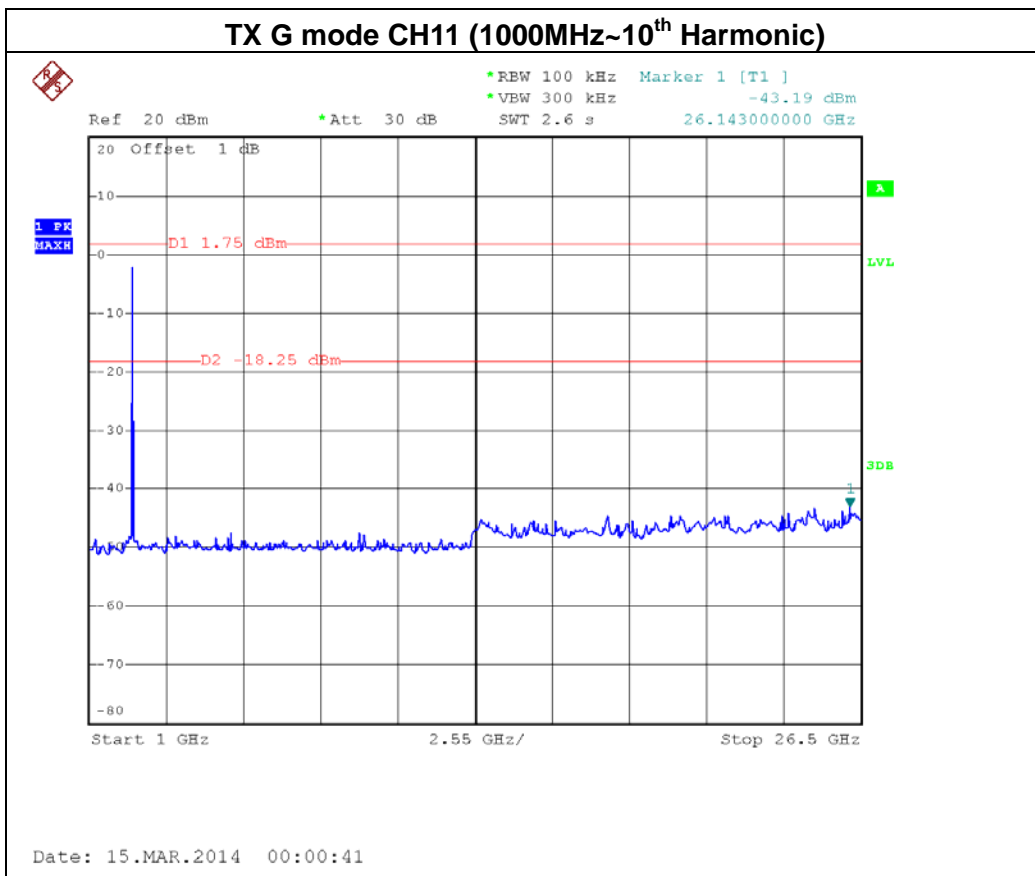
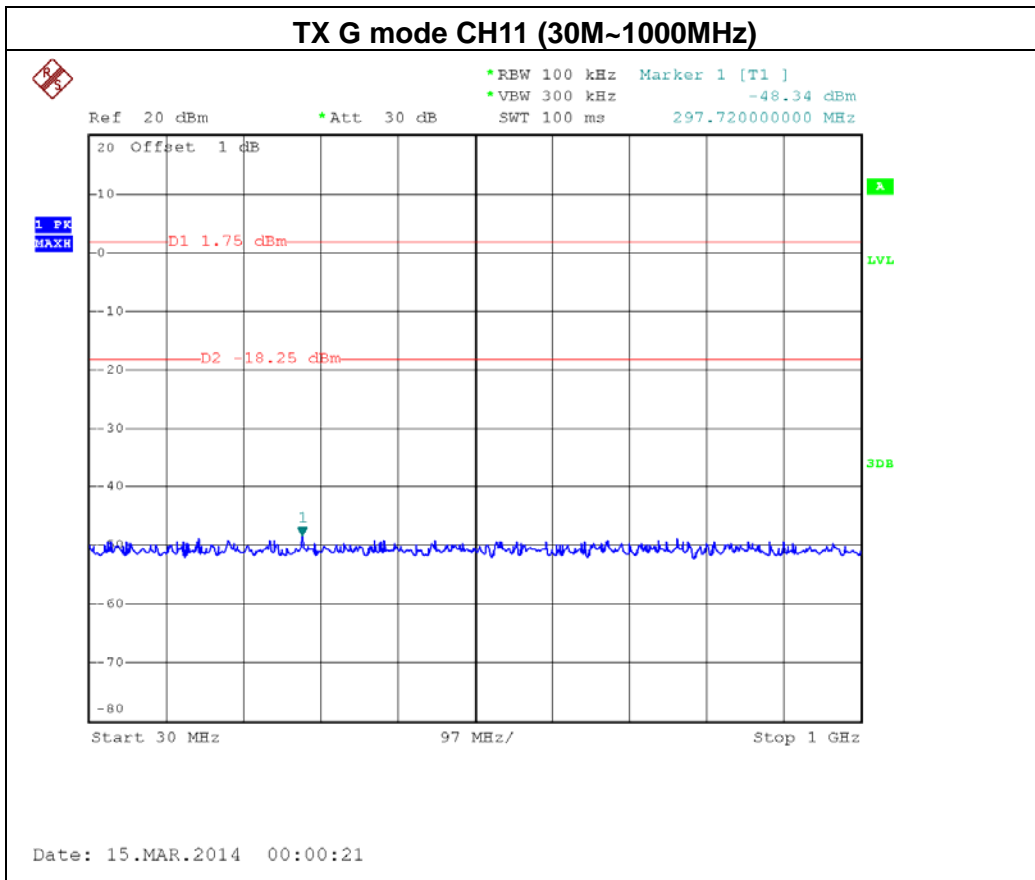



Test Mode :	TX N-20M Mode_ANT 1
-------------	---------------------

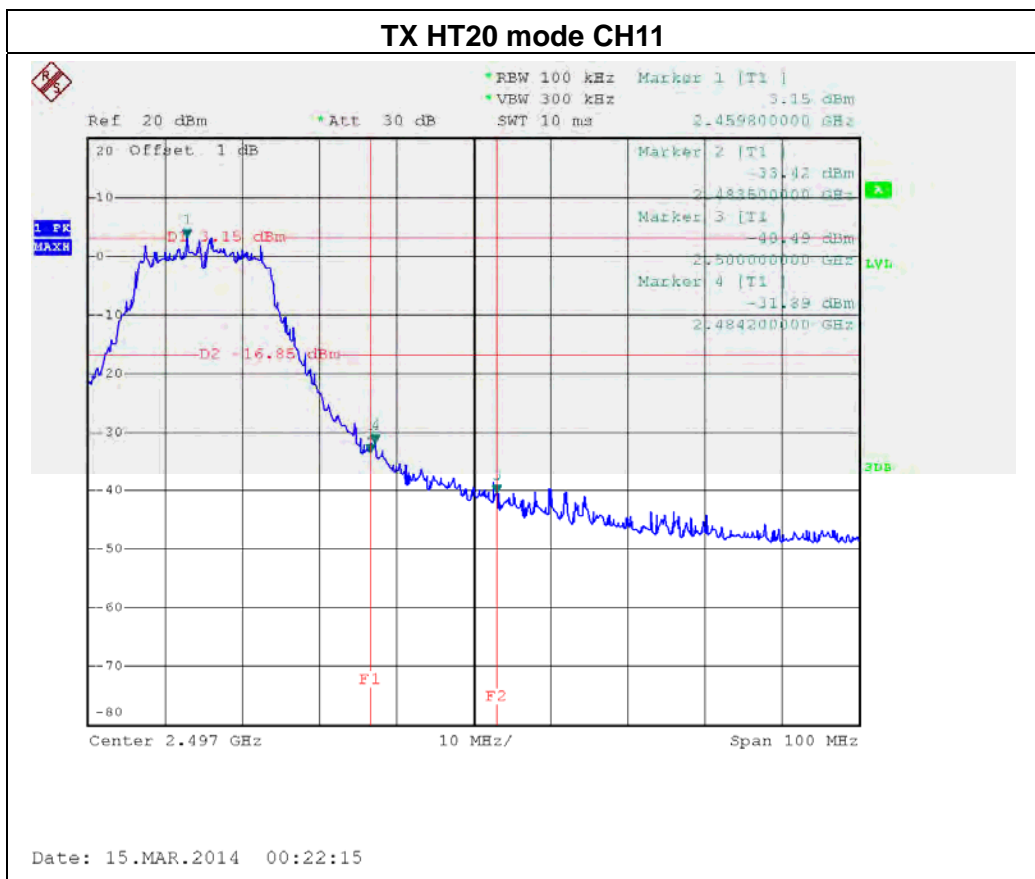
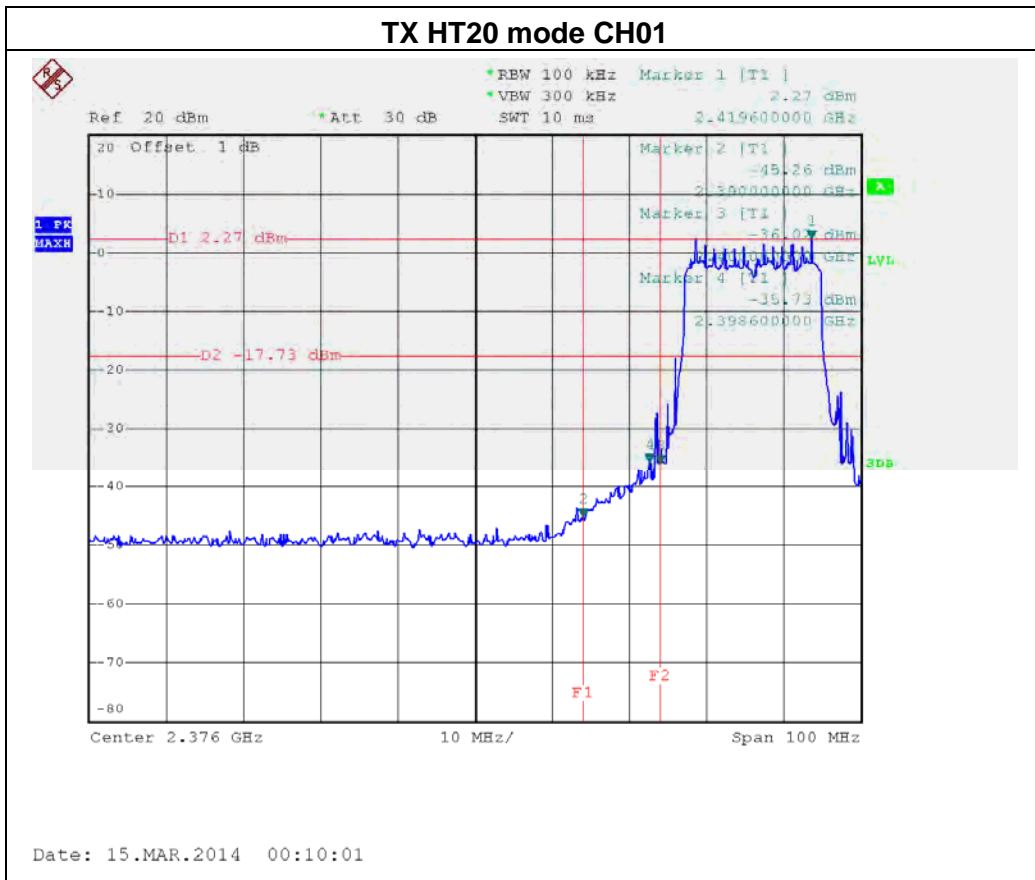

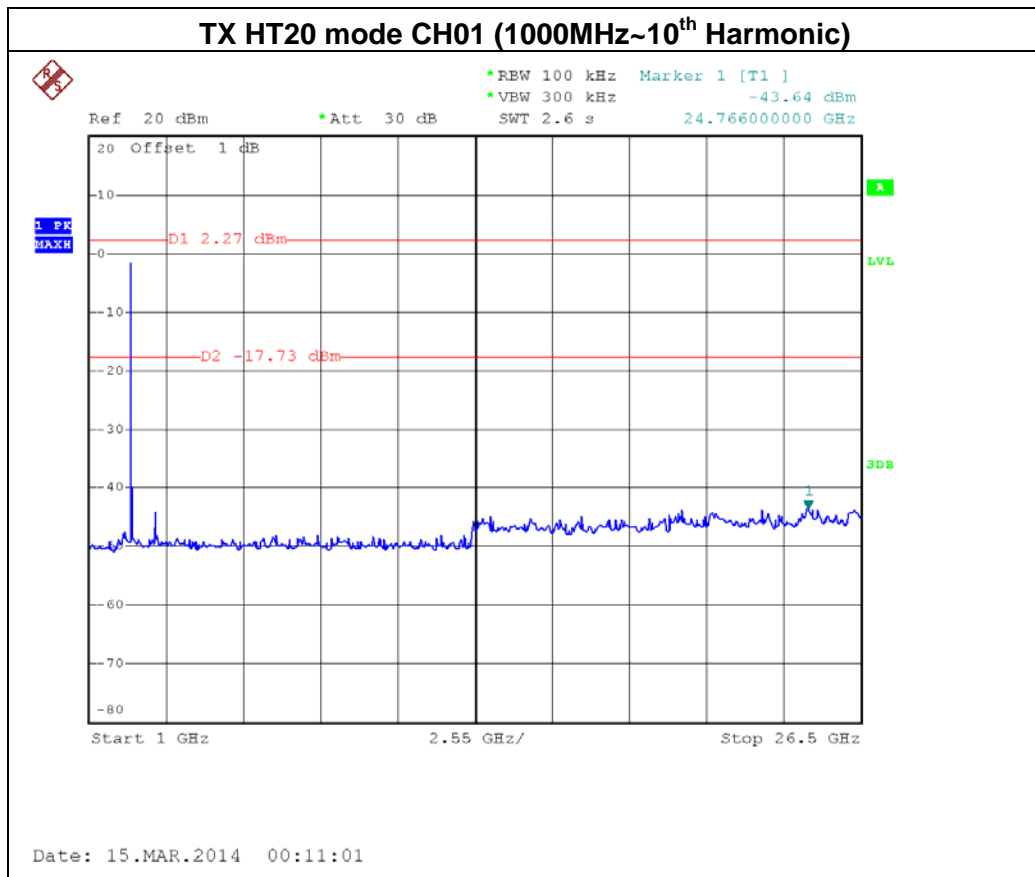
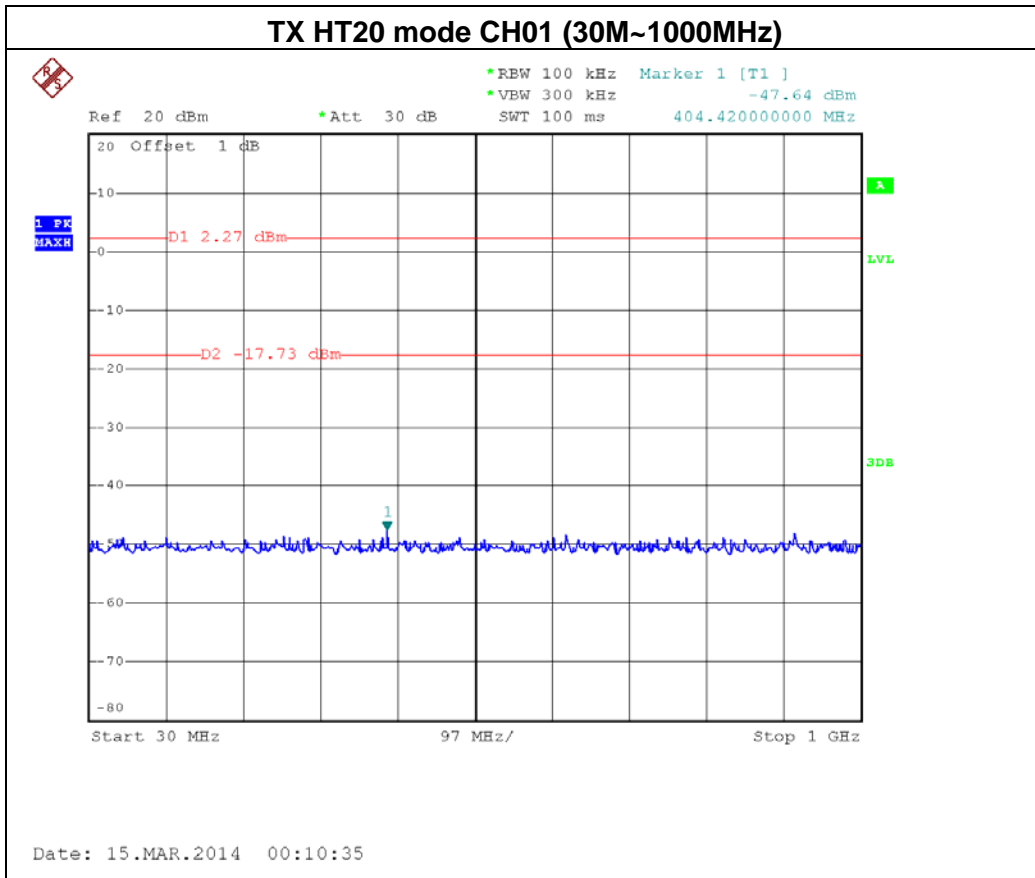

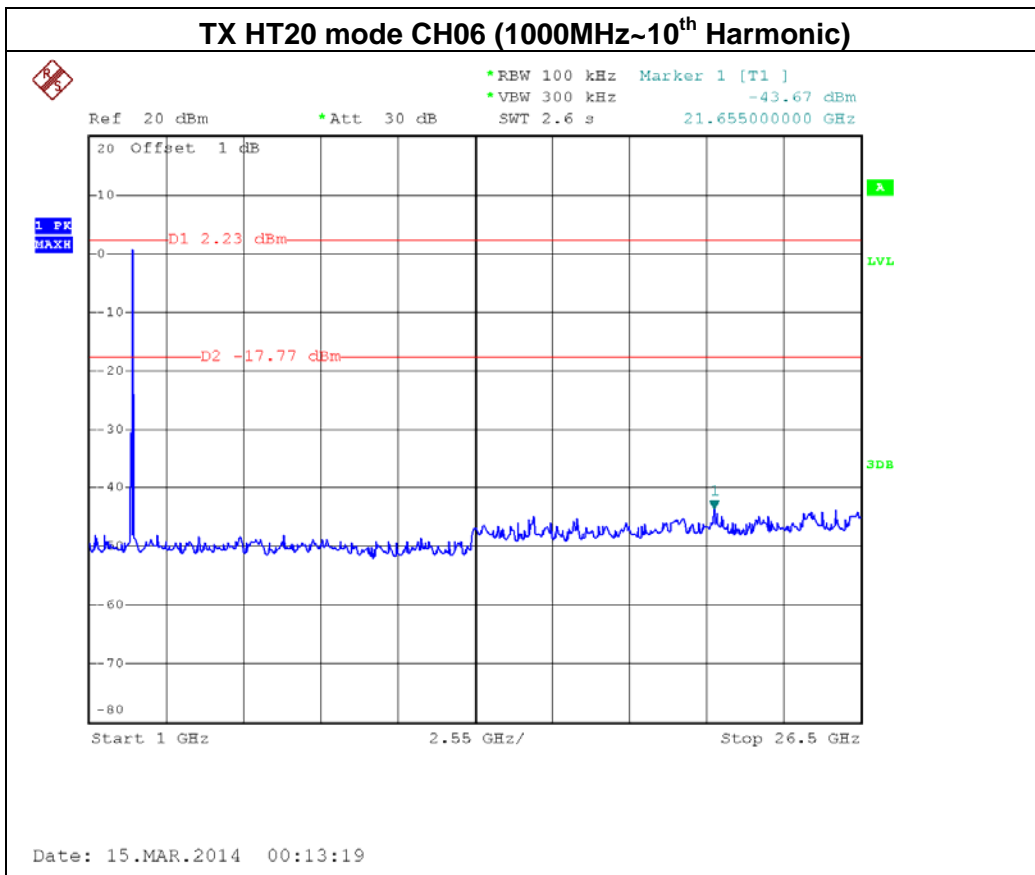
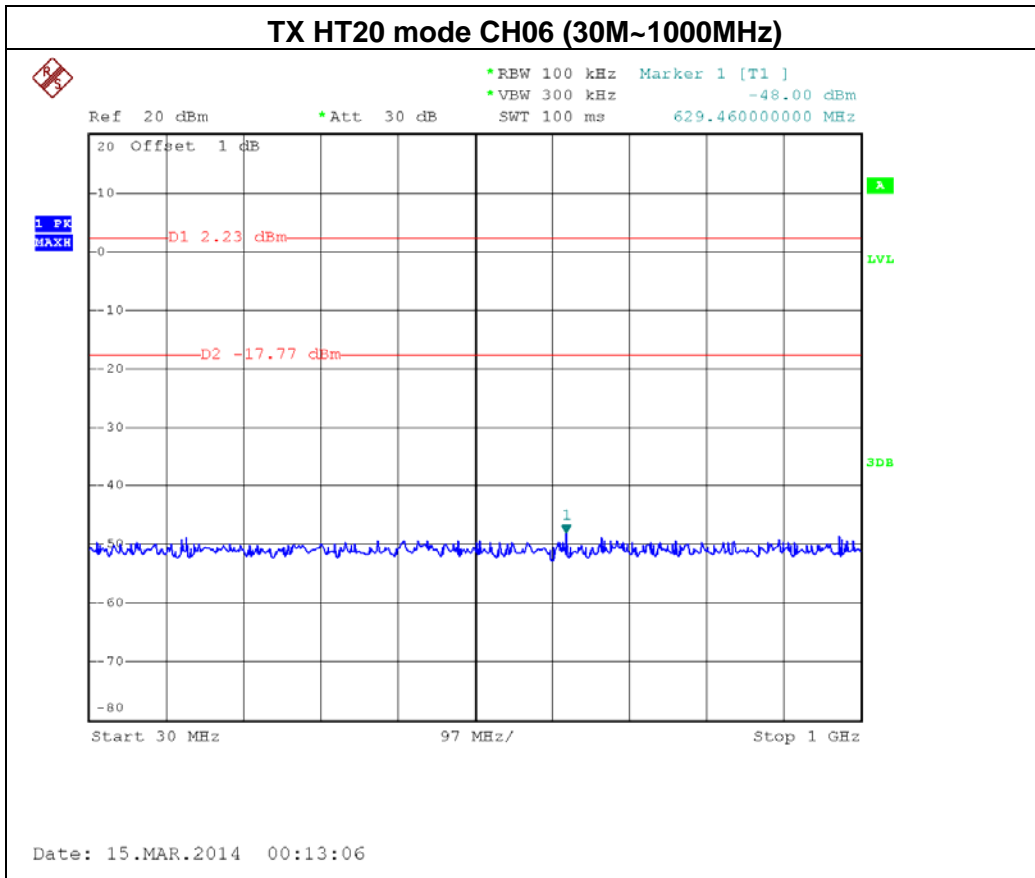

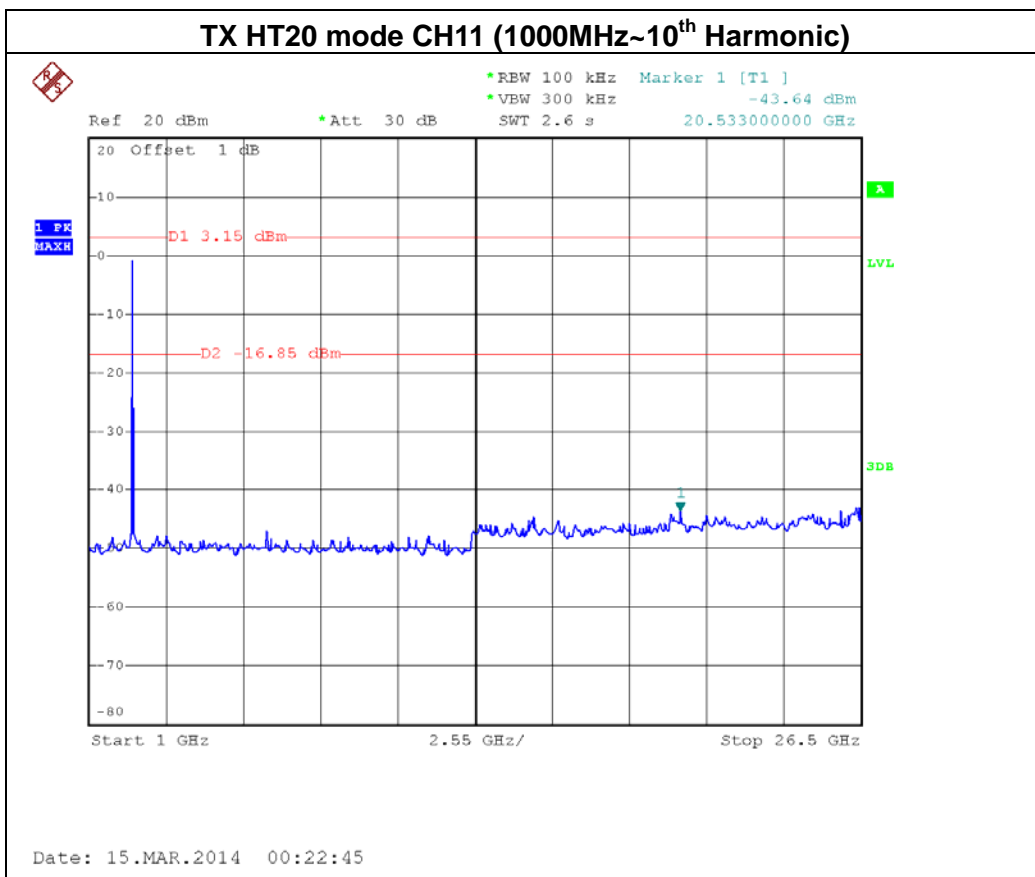
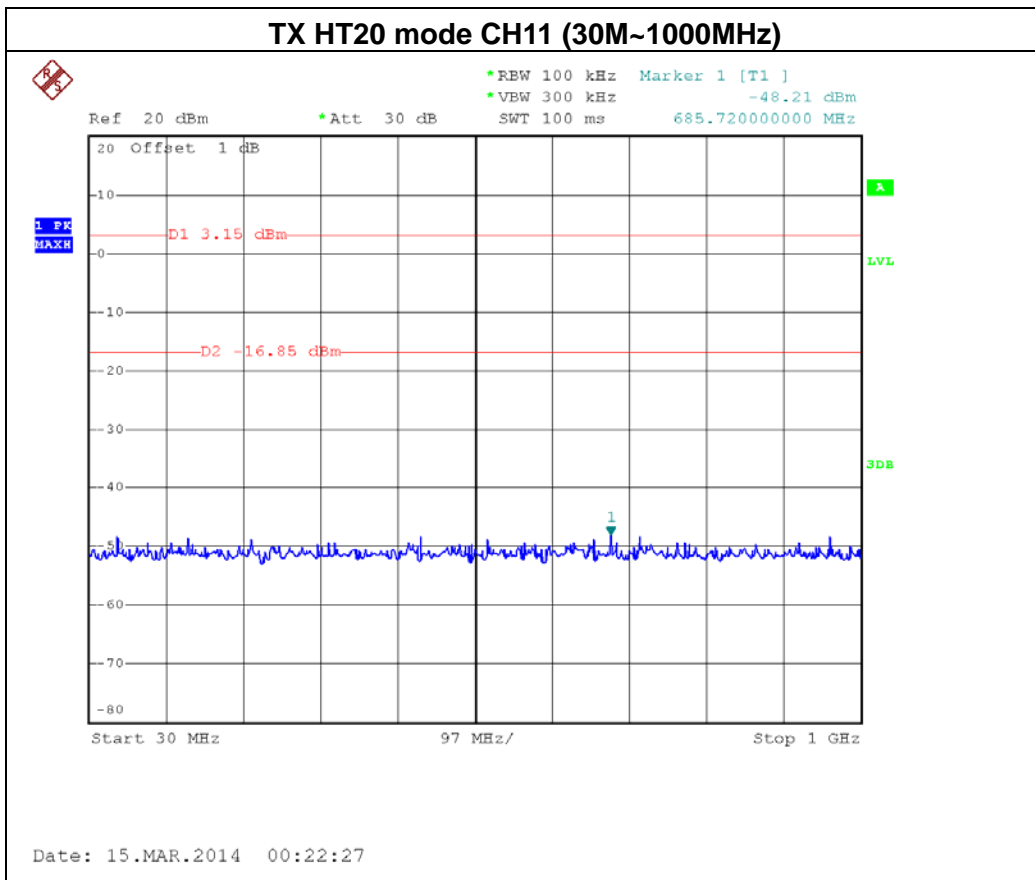



Test Mode :	TX N-20M Mode_ANT 2
-------------	---------------------

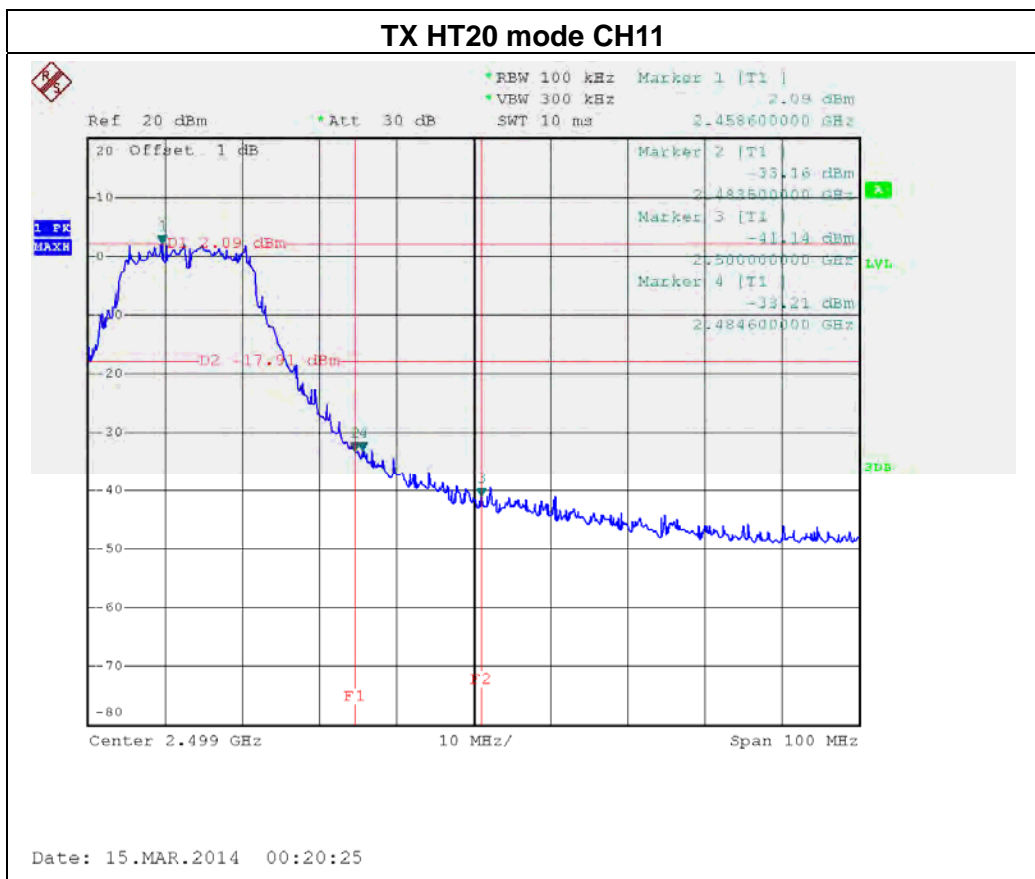
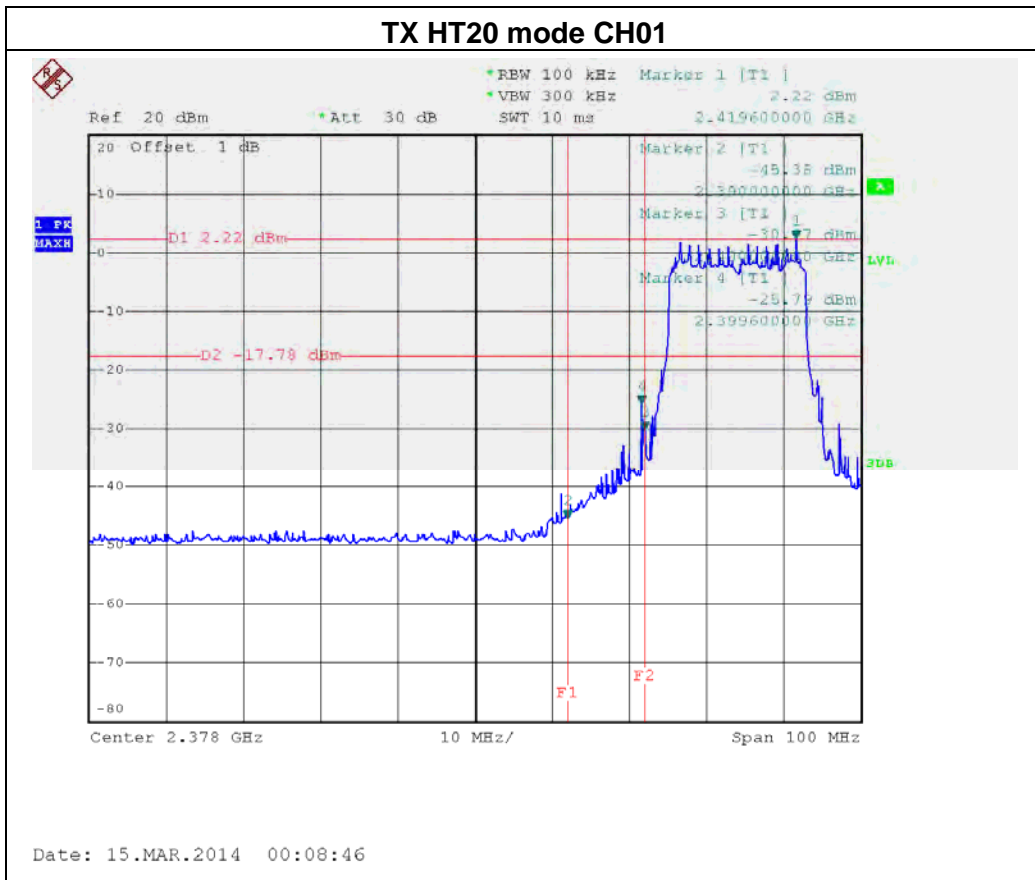

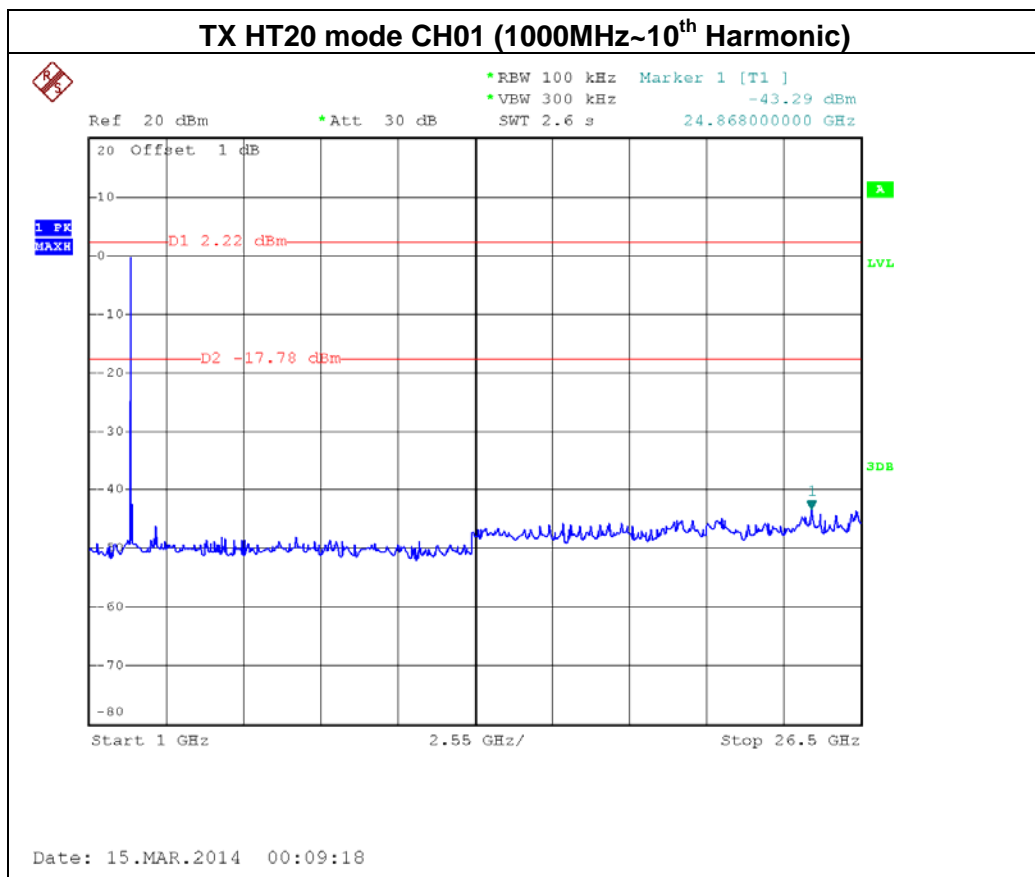
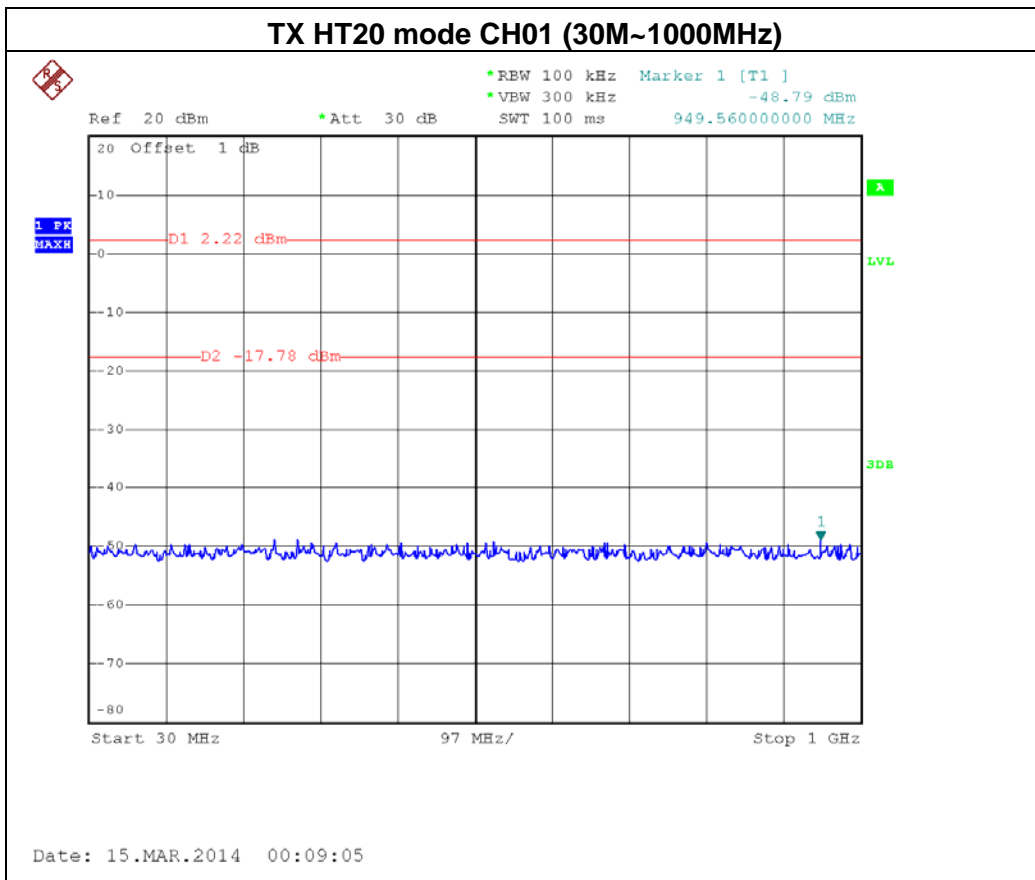

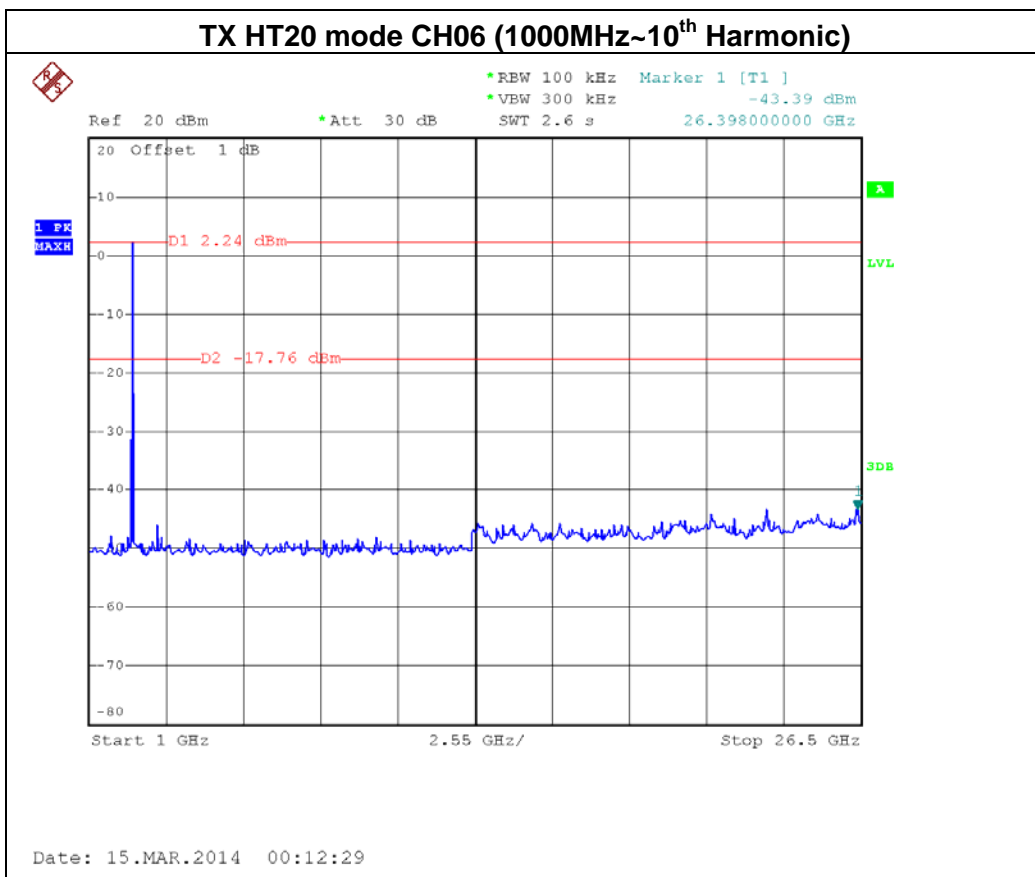
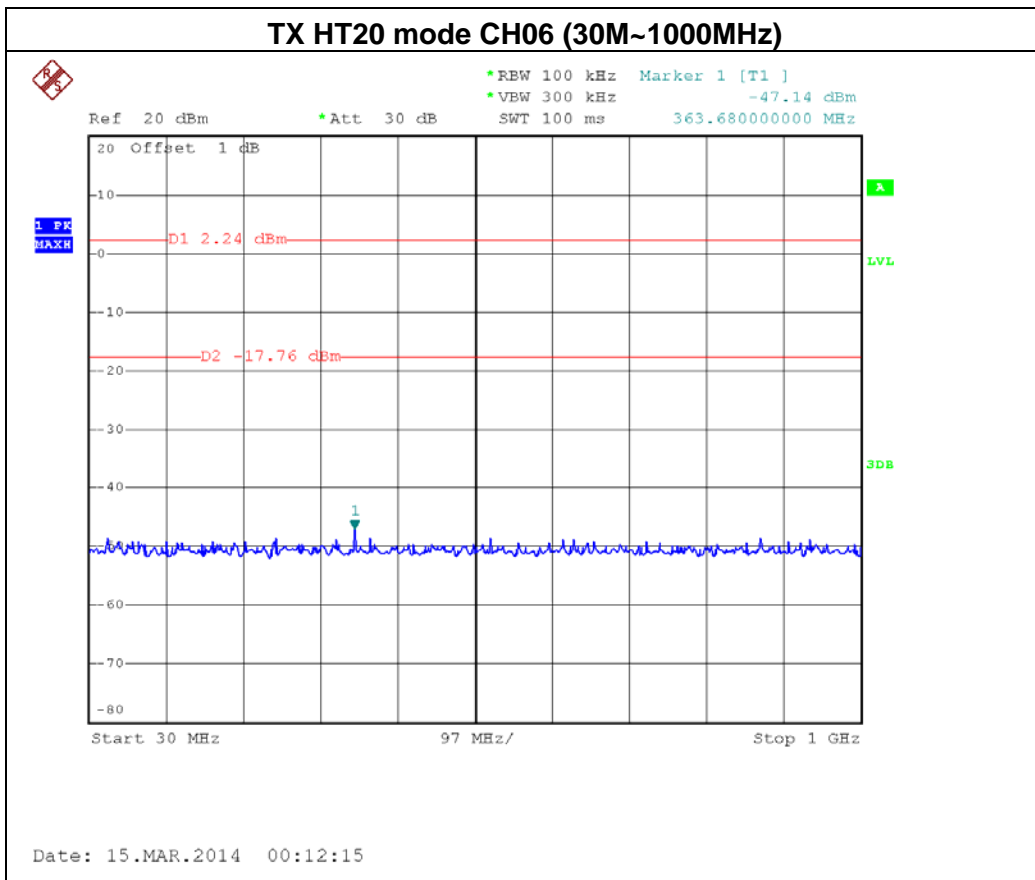

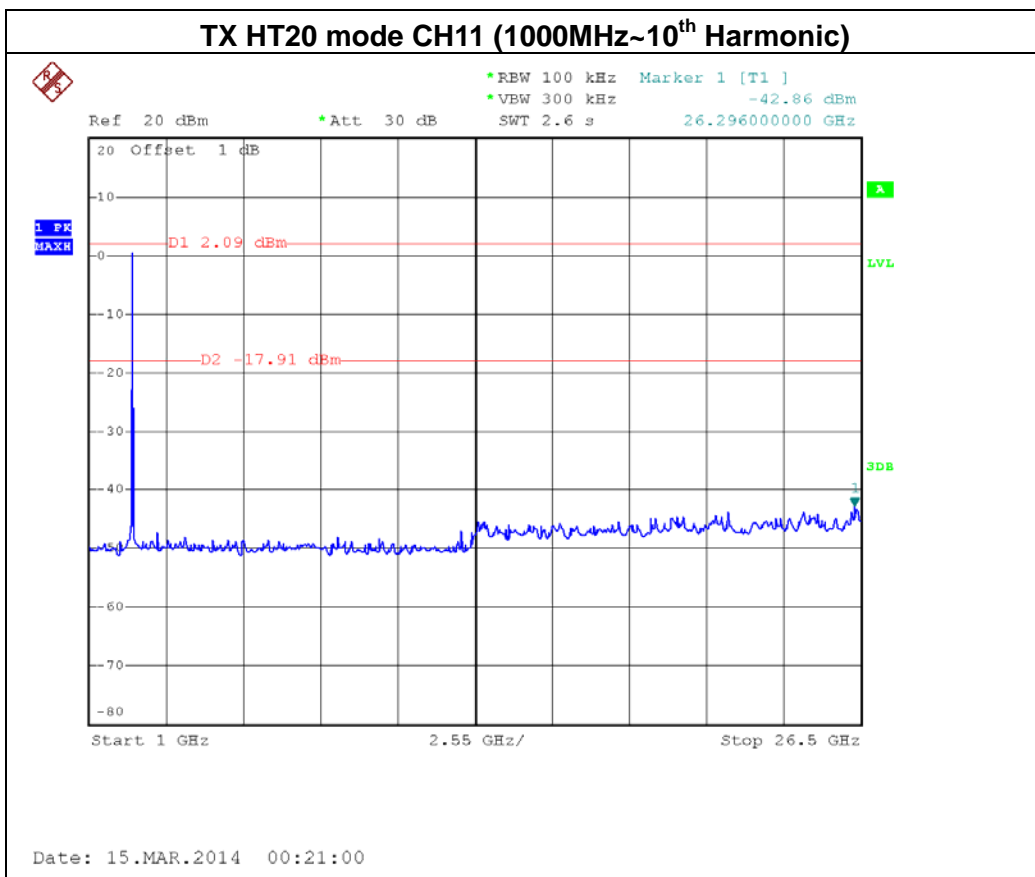
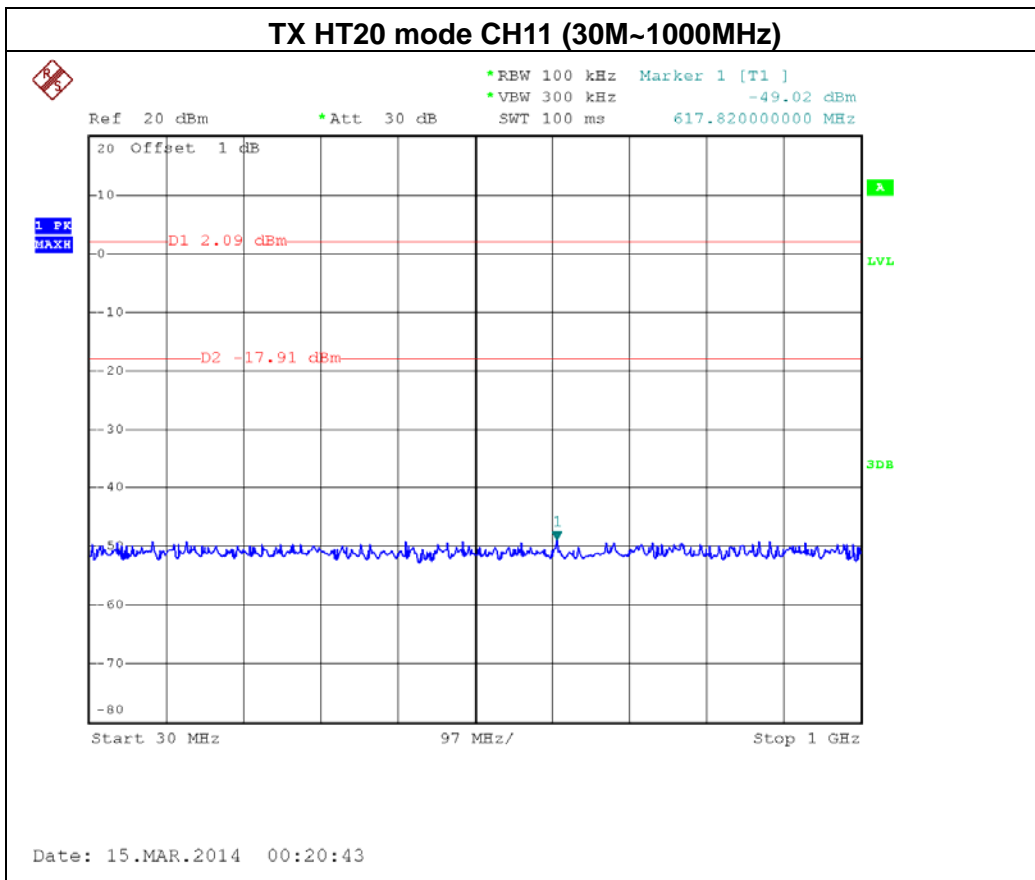



Test Mode :	TX N-40M Mode_ANT 1
-------------	---------------------

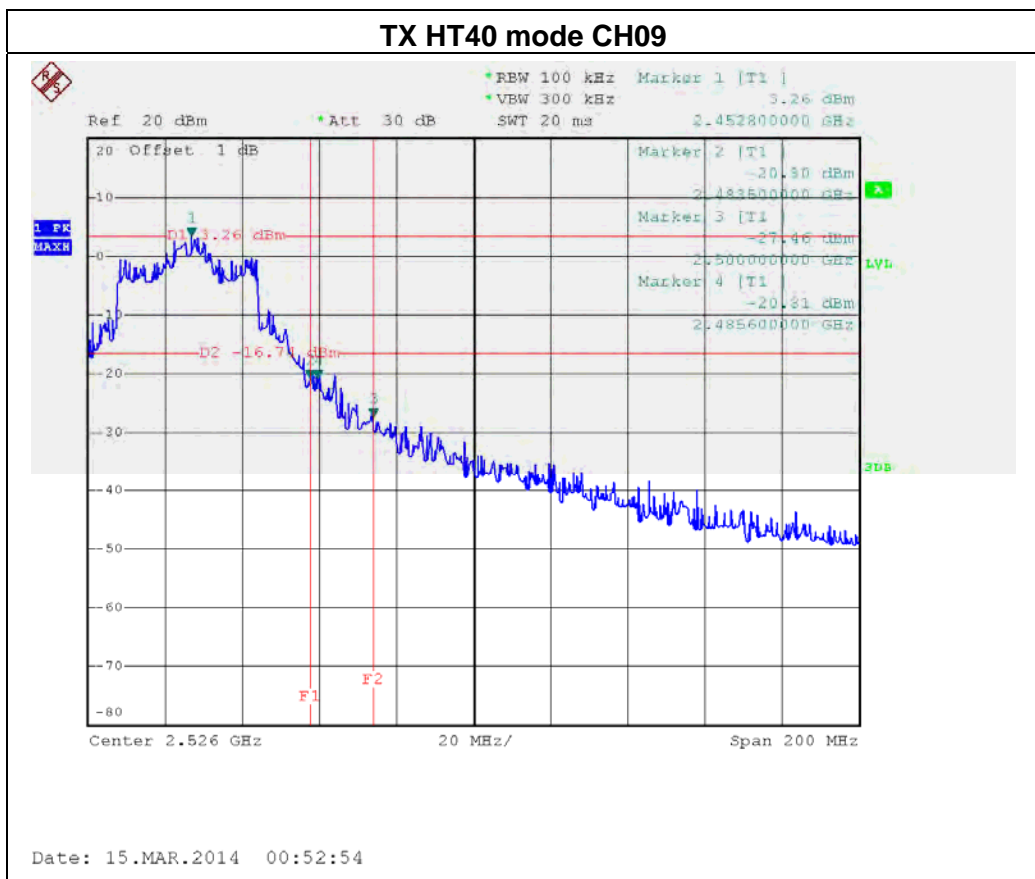
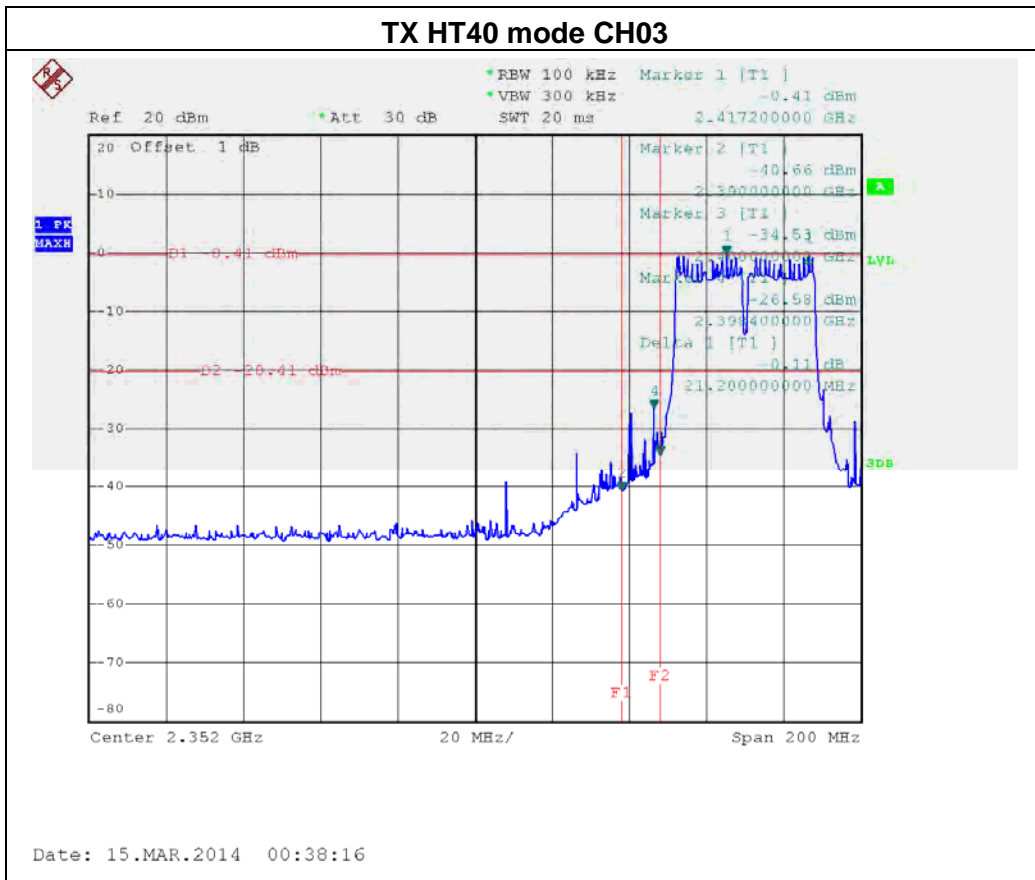

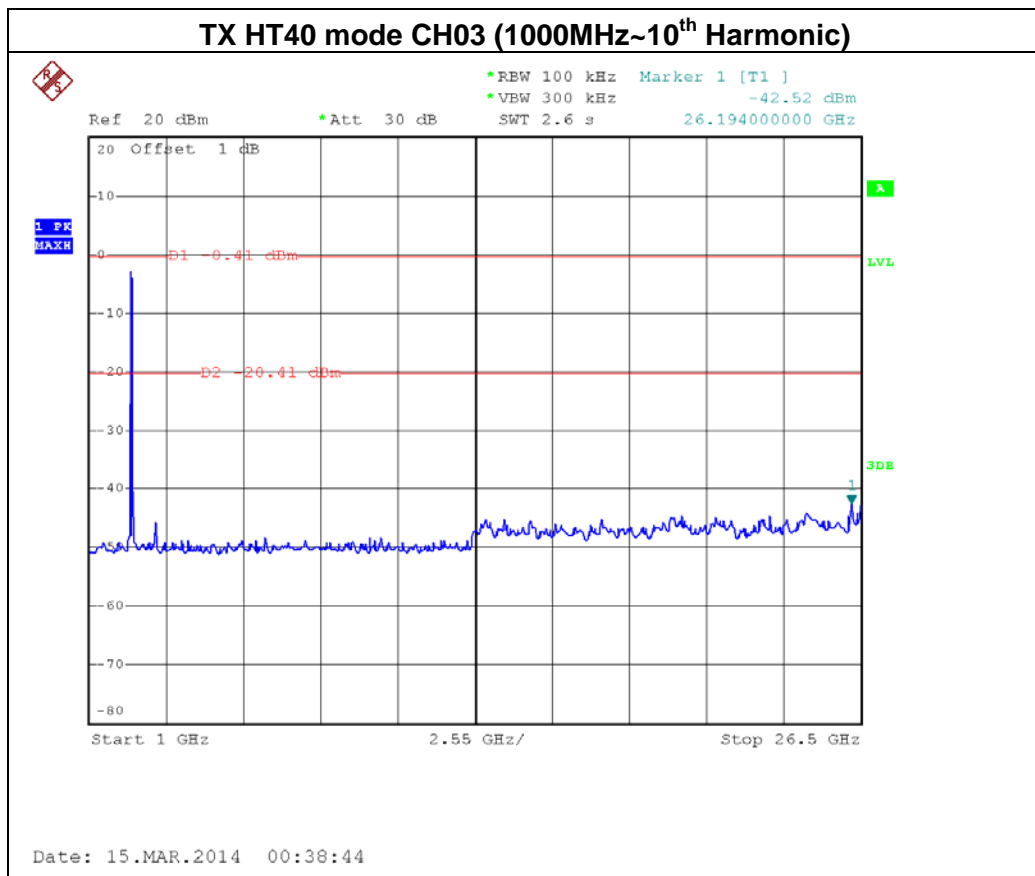
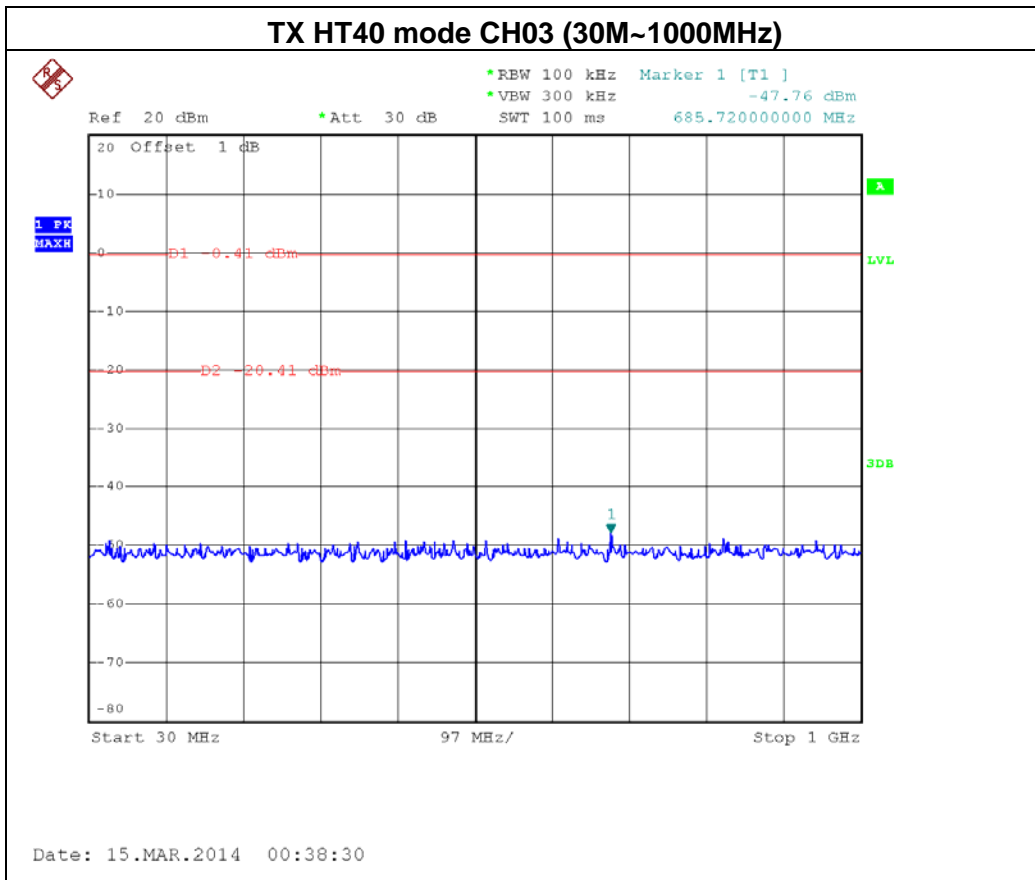

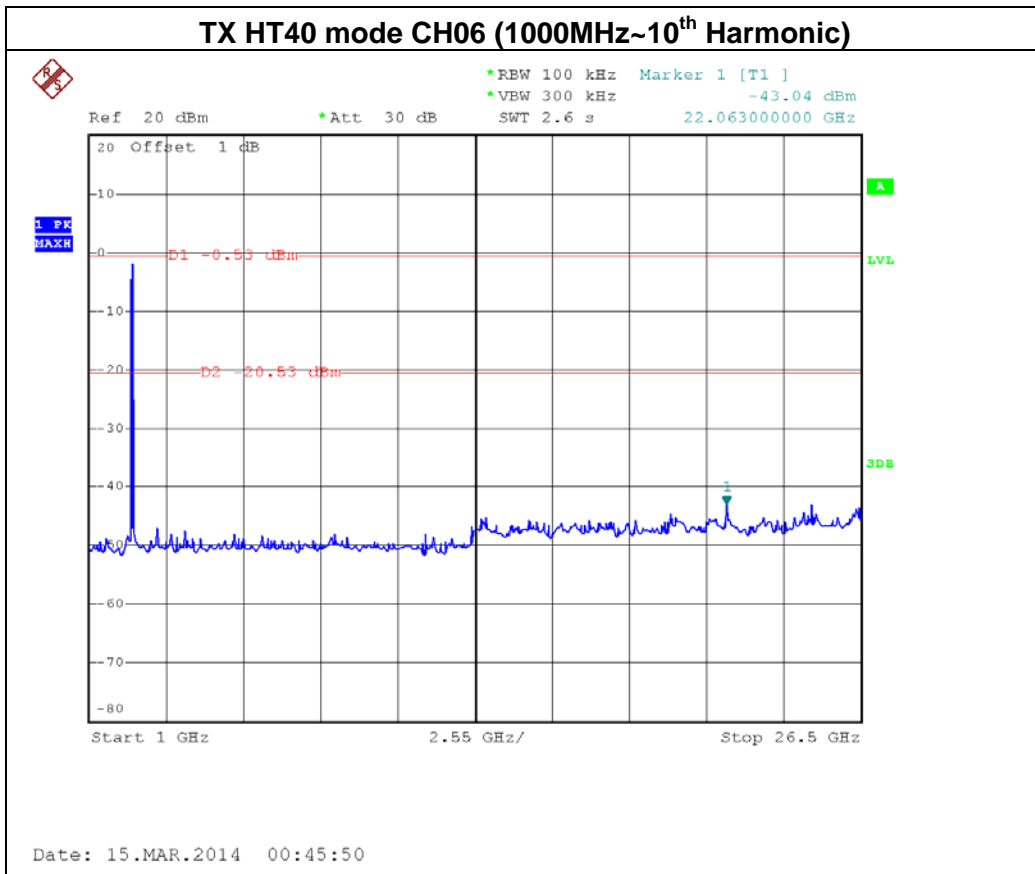
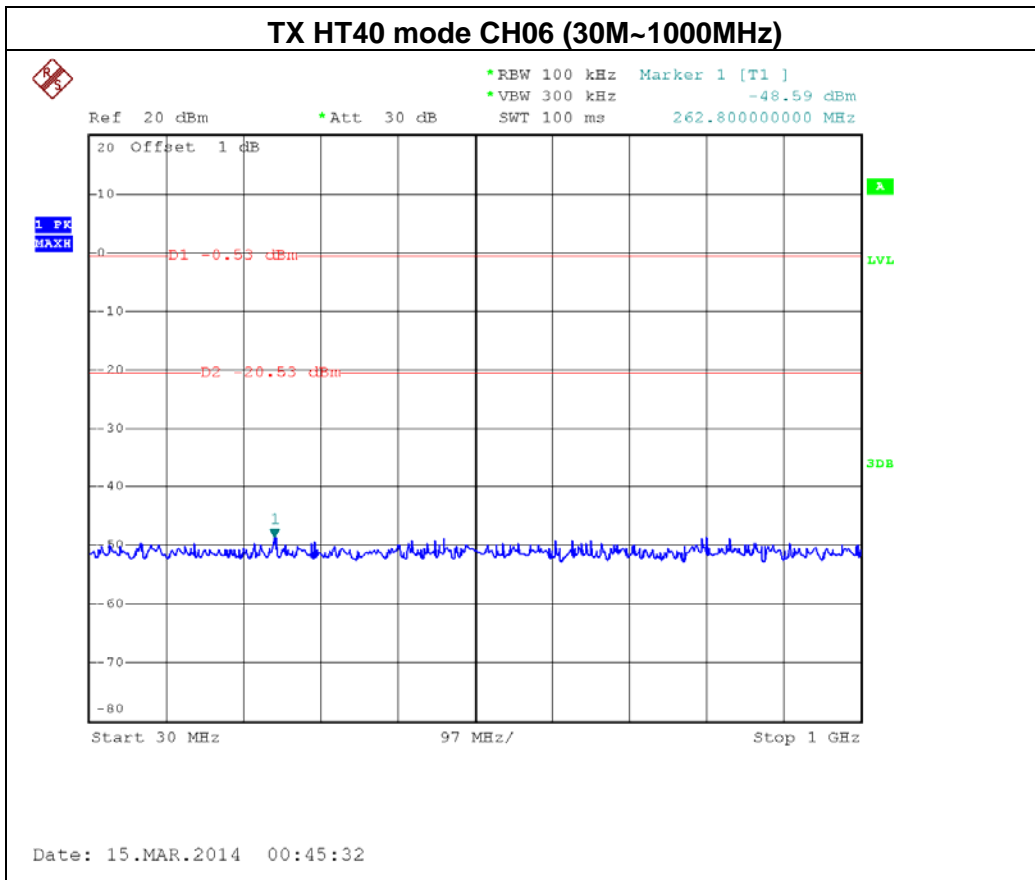

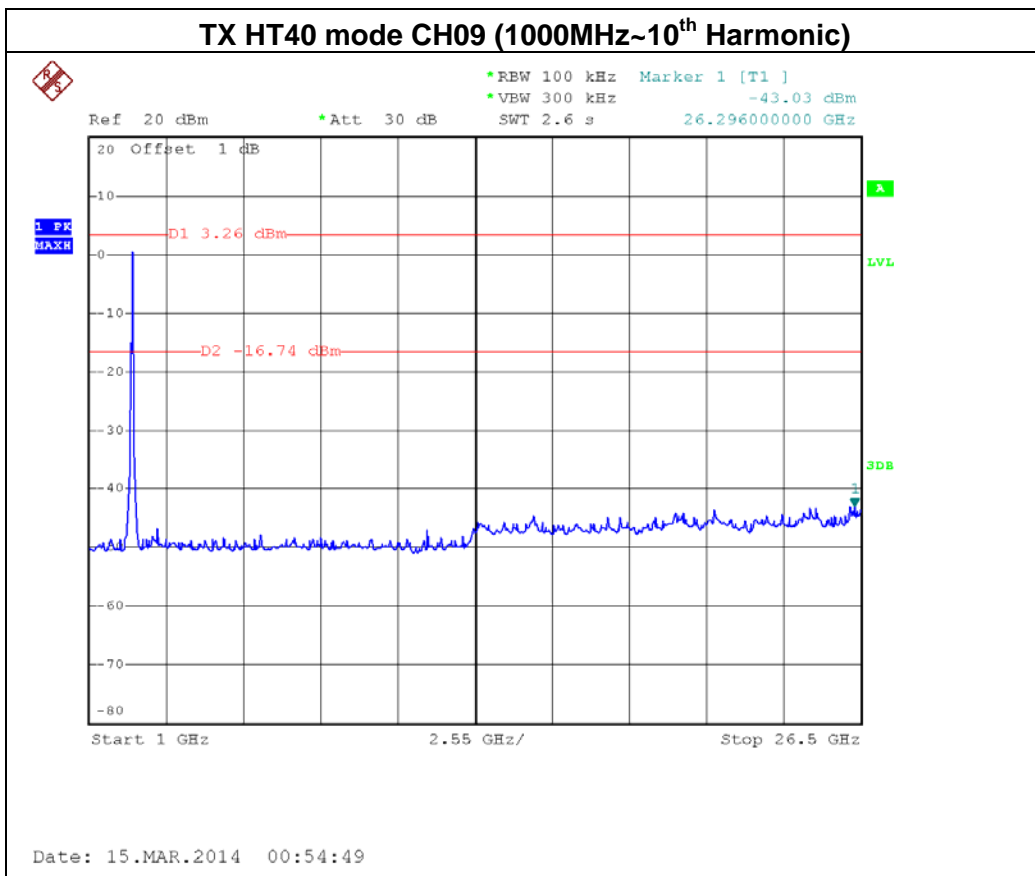
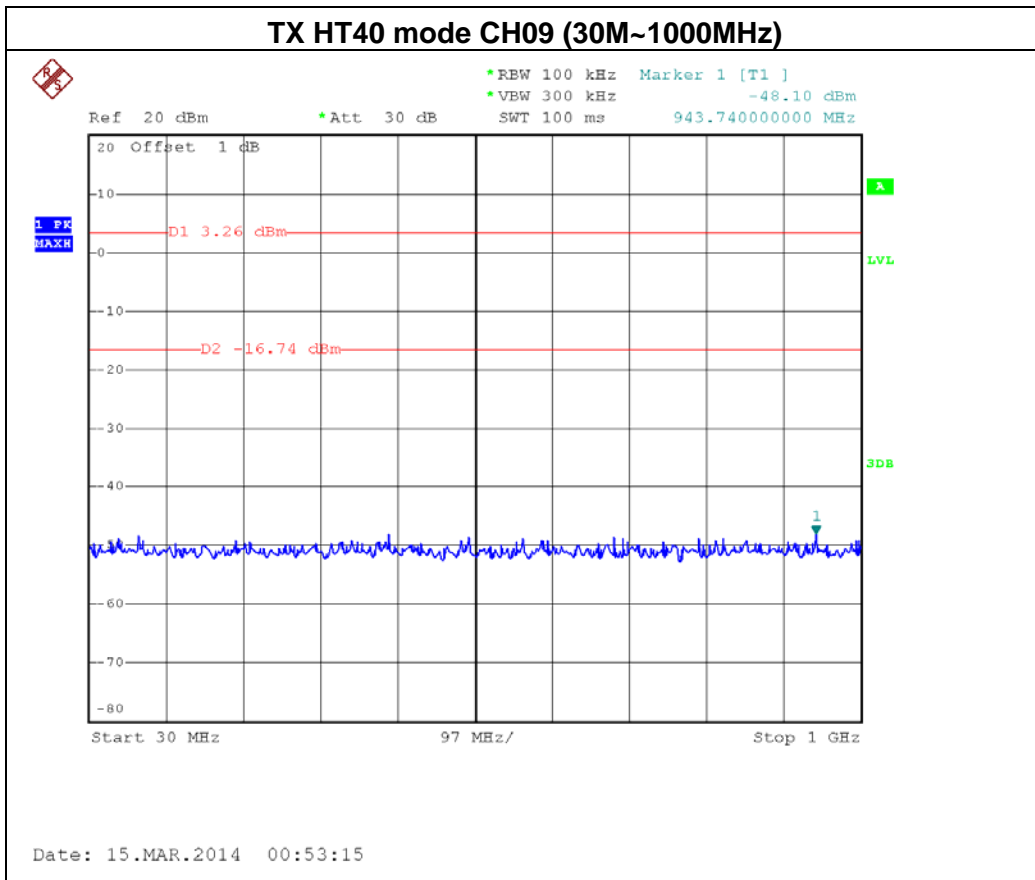



Test Mode :	TX N-40M Mode_ANT 2
-------------	---------------------

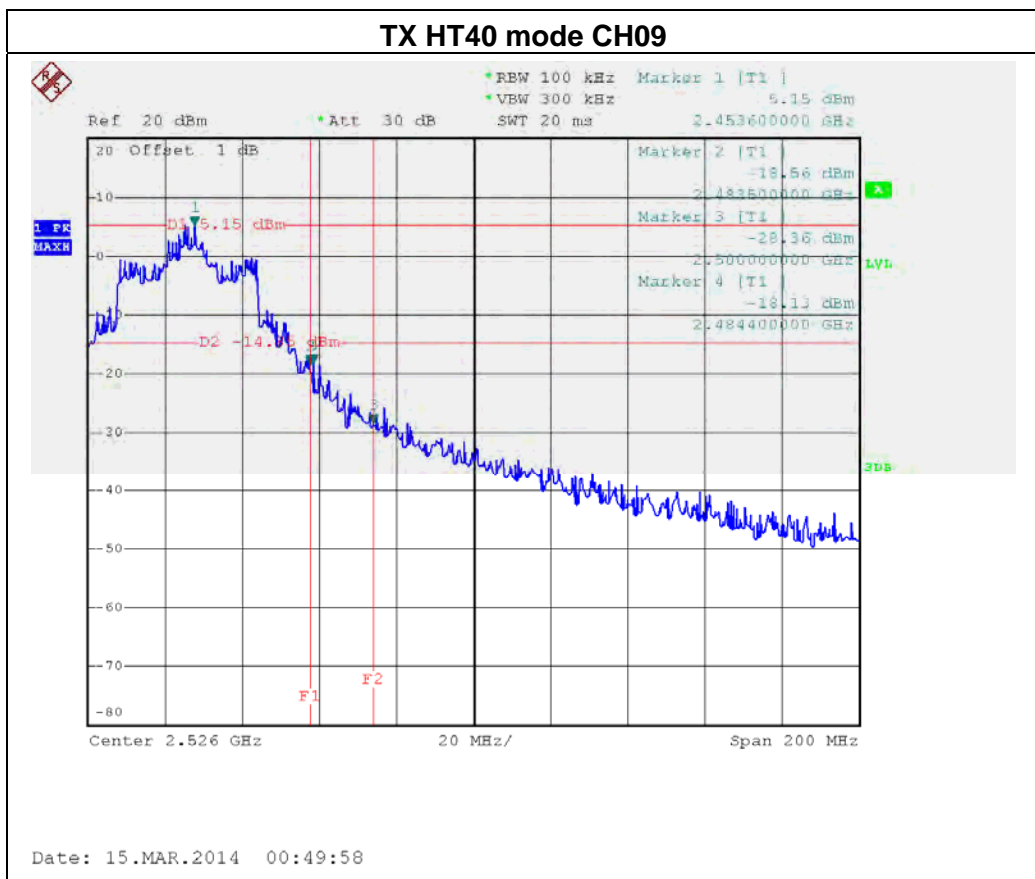
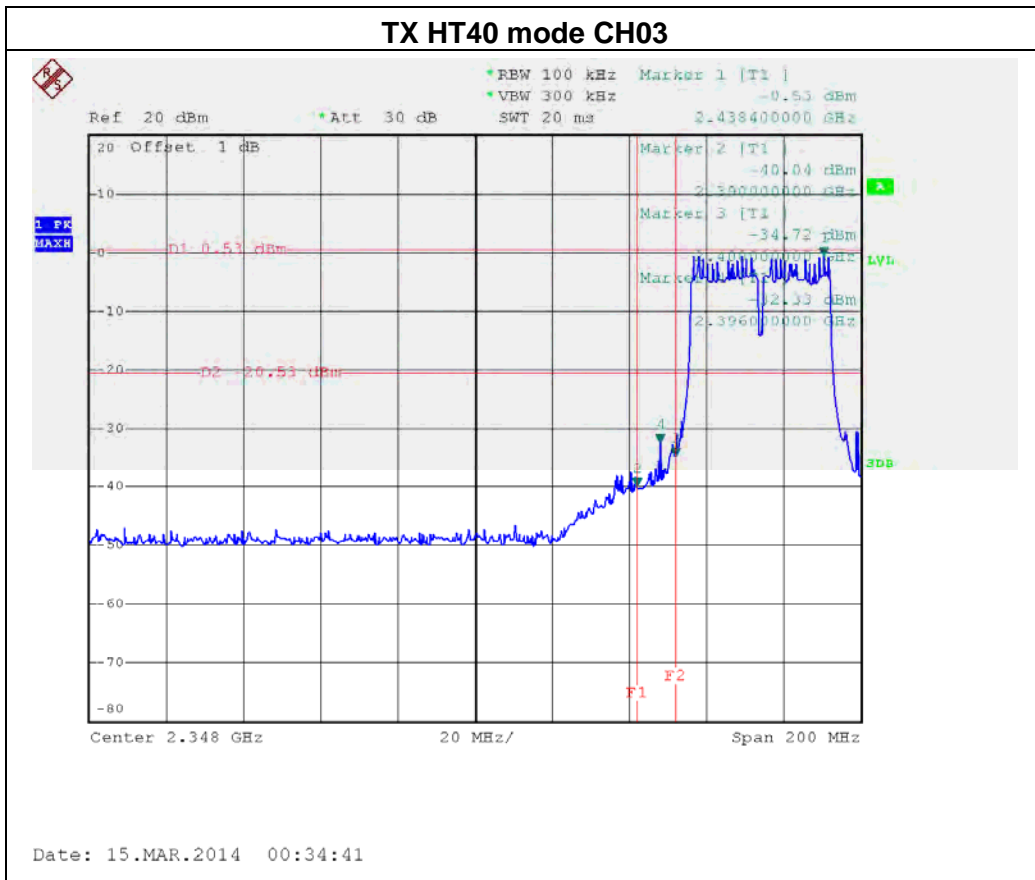

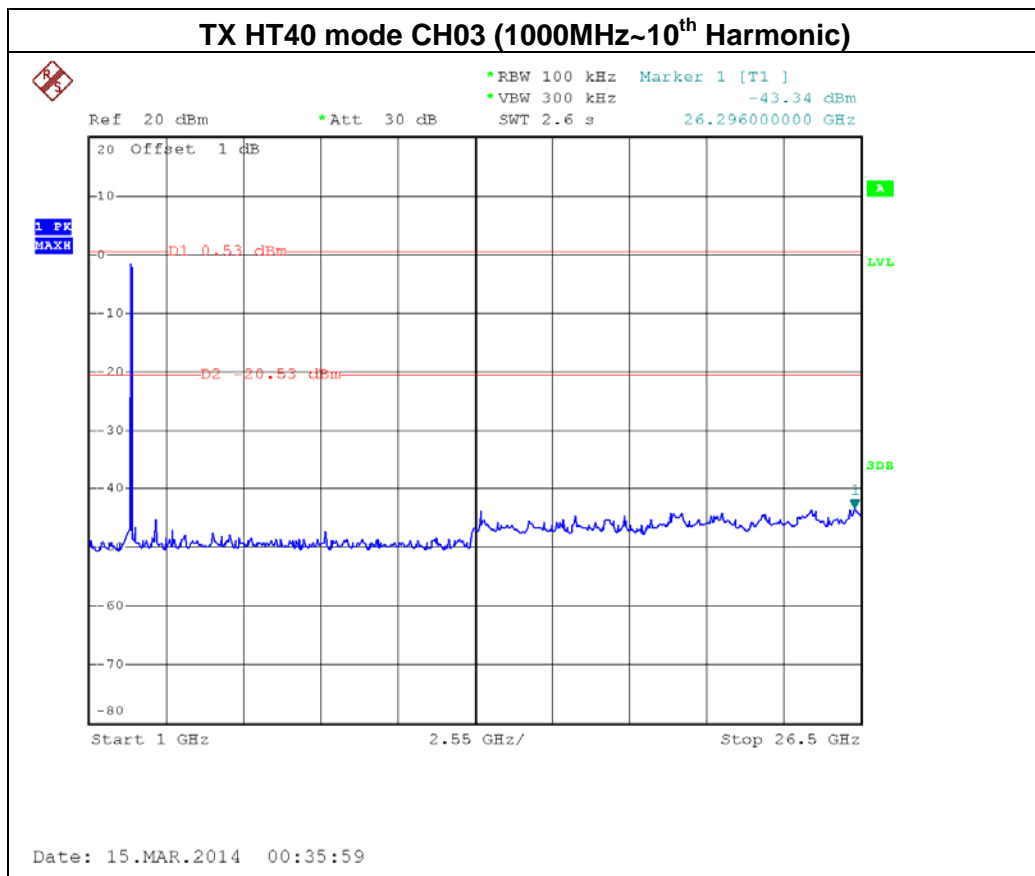
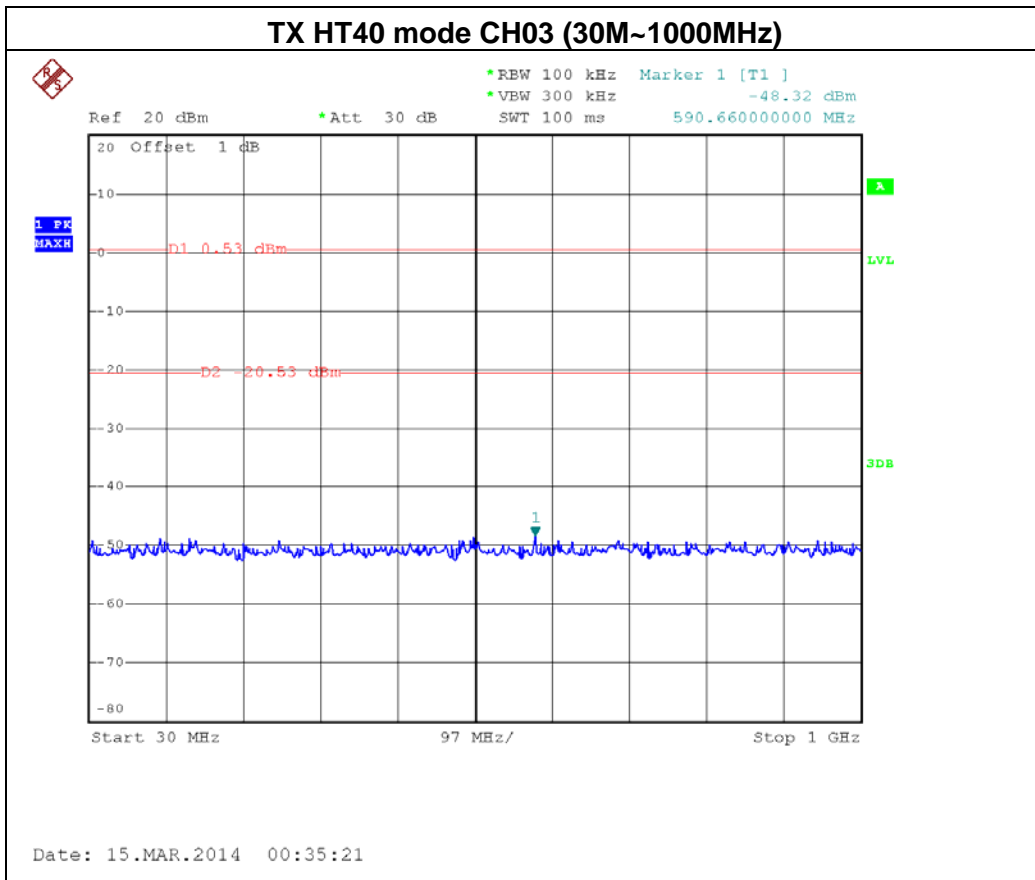

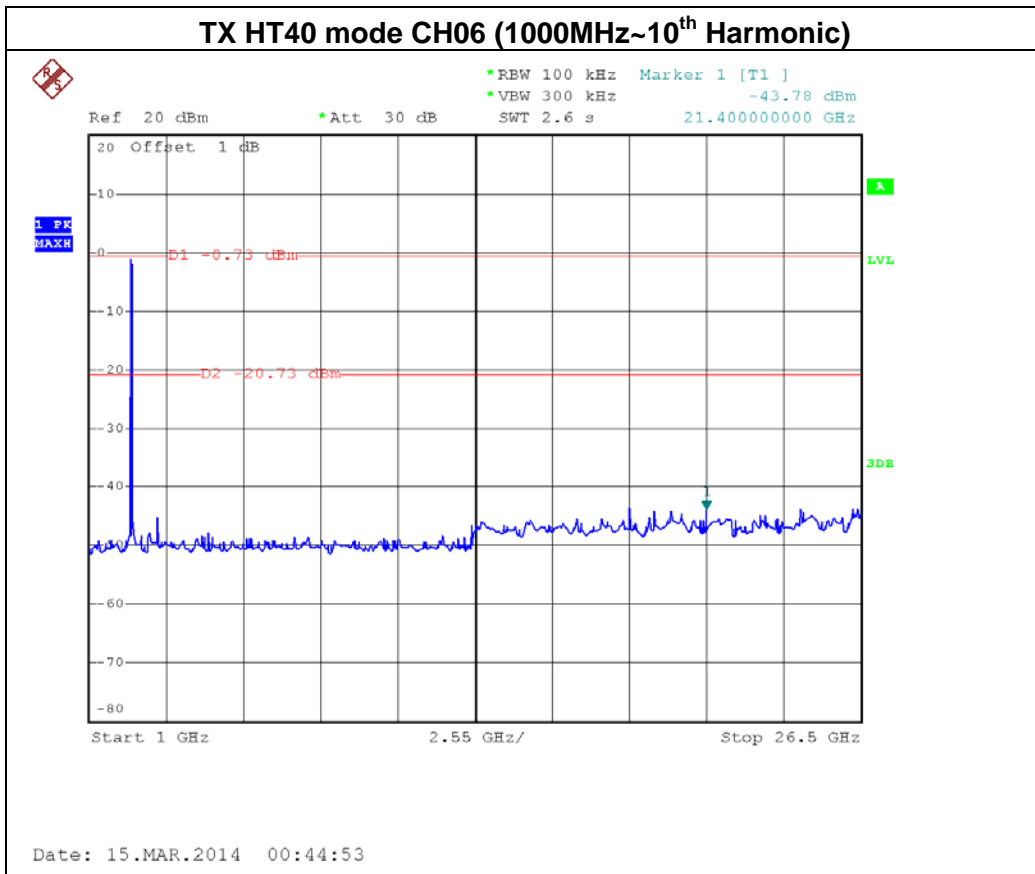
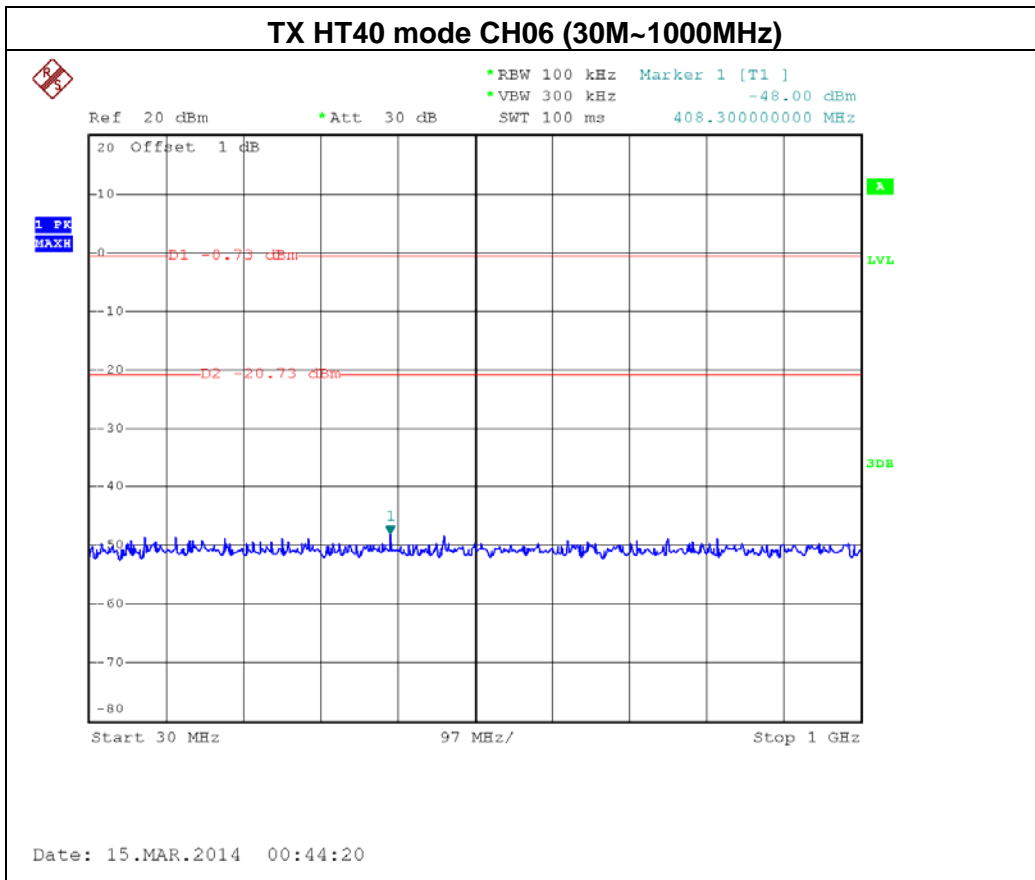

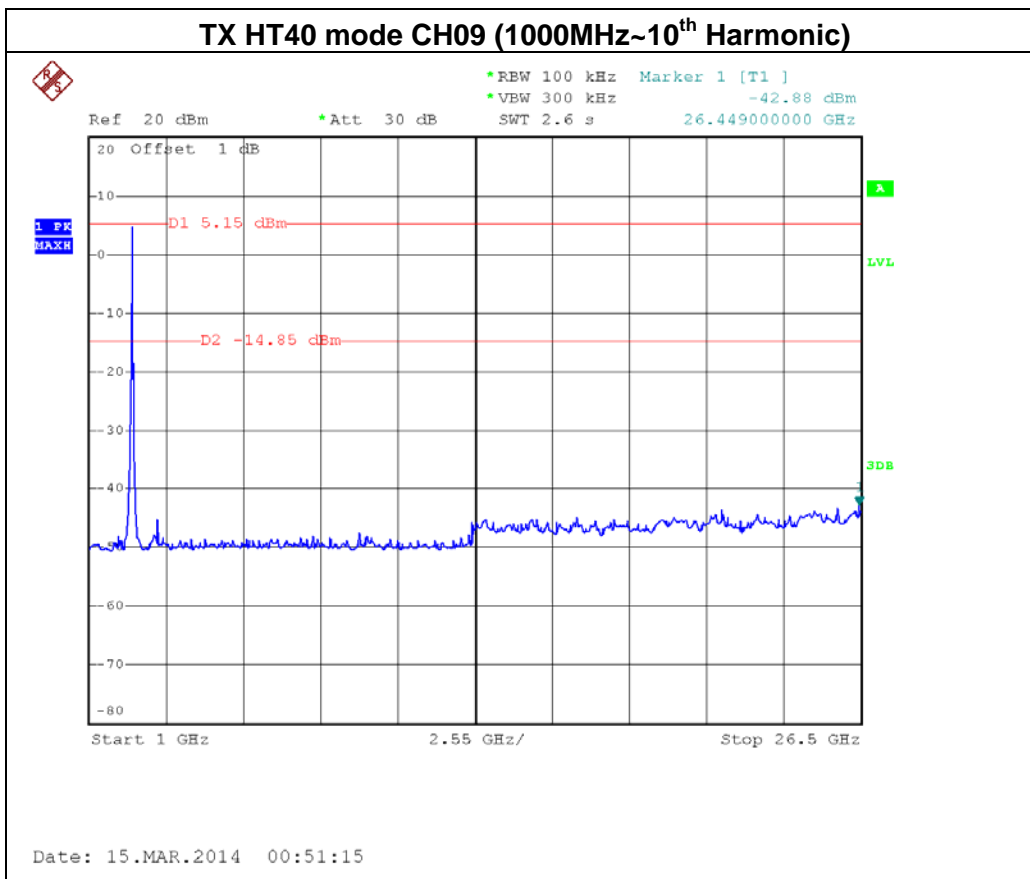
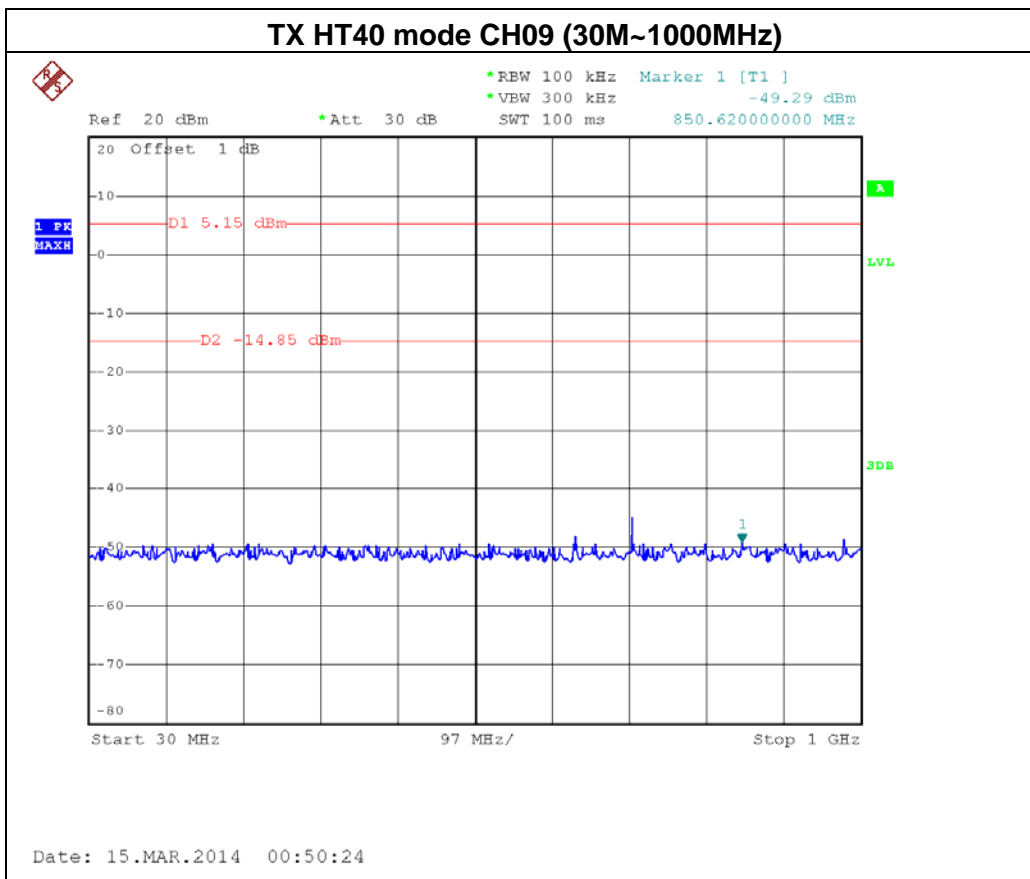



8. POWER SPECTRAL DENSITY TEST

8.1 Applied procedures / limit

FCC Part15 (15.247) , Subpart C / RSS-210				
Section	Test Item	Limit	Frequency Range (MHz)	Result
15.247(e) RSS-210 Annex 8(A8.2(b))	Power Spectral Density	8 dBm (in any 3KHz)	2400-2483.5	PASS

8.1.1 TEST PROCEDURE

- a. The EUT was directly connected to the spectrum analyzer and antenna output port as show in the block diagram below,
- b. Spectrum Setting: RBW=3KHz, VBW=10KHz, Sweep time = Auto.

8.1.2 DEVIATION FROM STANDARD

No deviation.

8.1.3 TEST SETUP



8.1.4 EUT OPERATION CONDITIONS

The EUT tested system was configured as the statements of 4.1.6 Unless otherwise a special operating condition is specified in the follows during the testing.

8.1.5 EUT TEST CONDITIONS

Temperature: 25°C
 Relative Humidity: 55%
 Test Voltage: AC 120V/60Hz



8.1.6 TEST RESULTS

Test Mode :TX B Mode_CH01/06/11_ANT 1

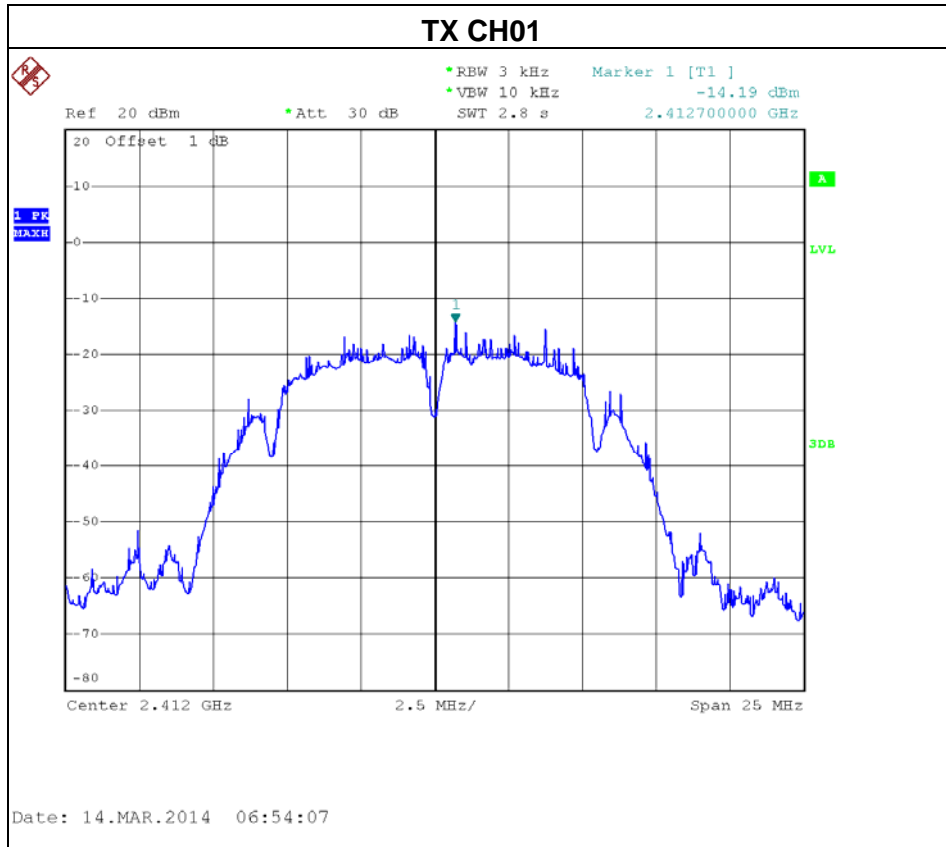

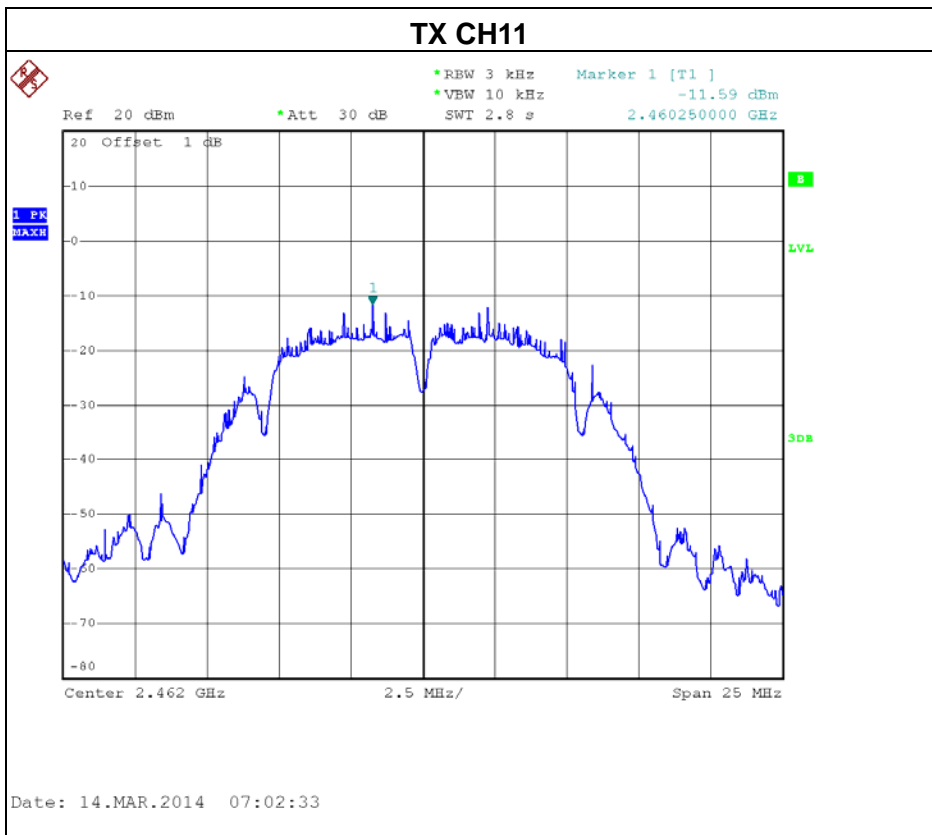
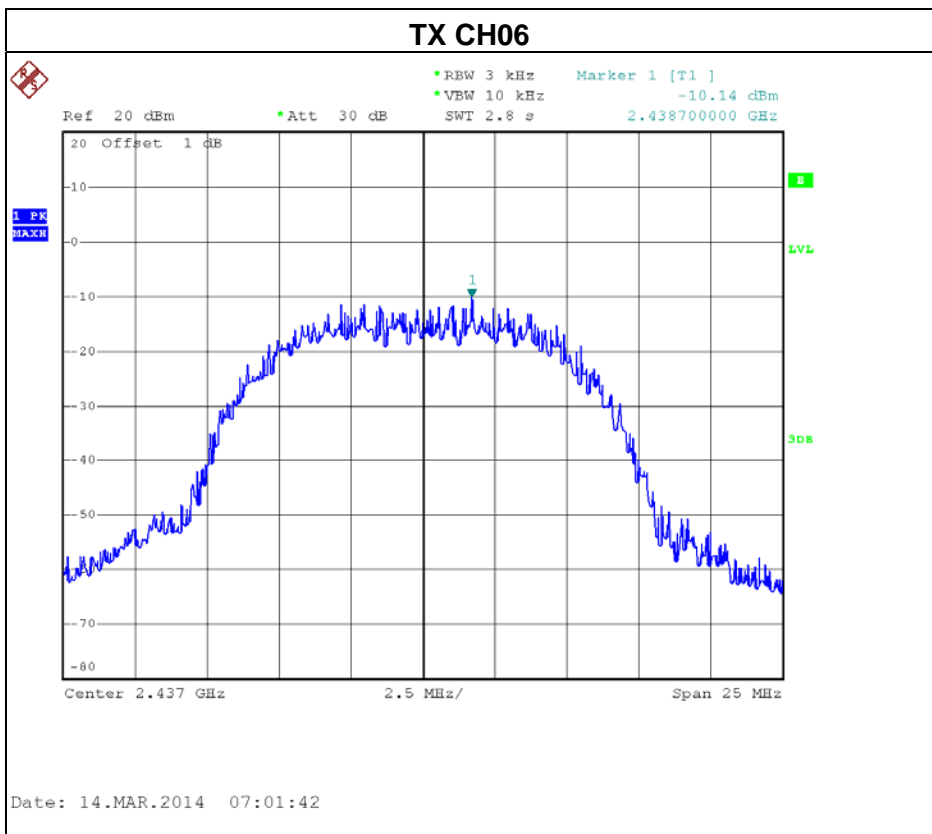



Test Mode :TX B Mode_CH01/06/11_ANT 2

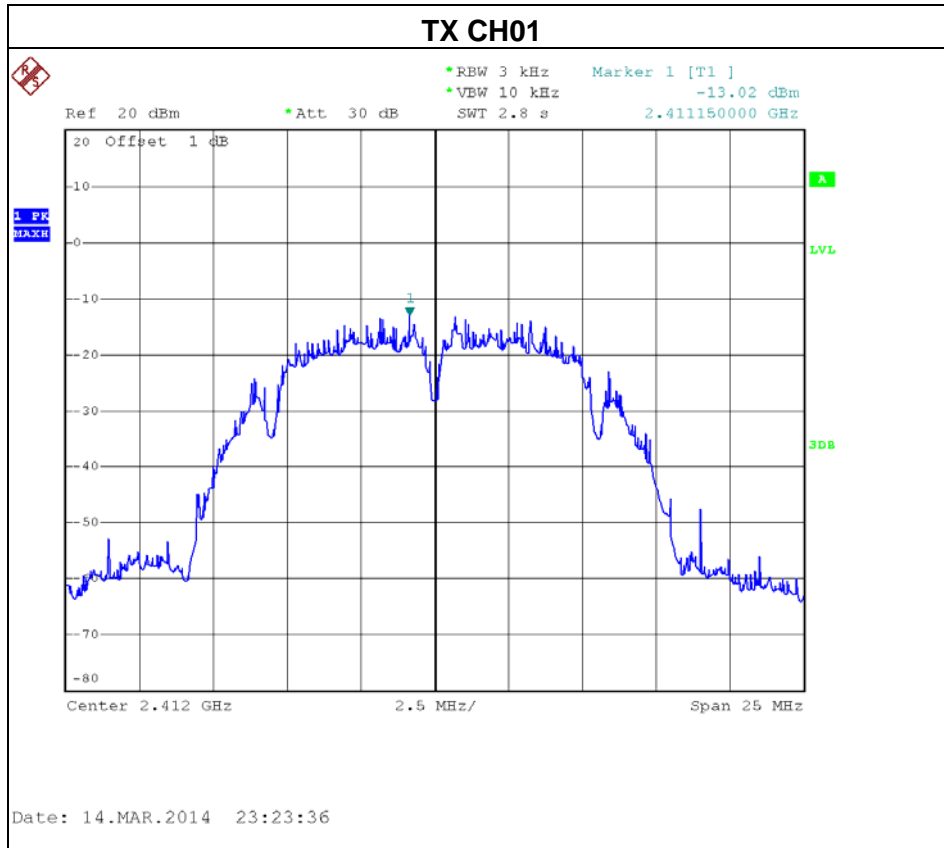

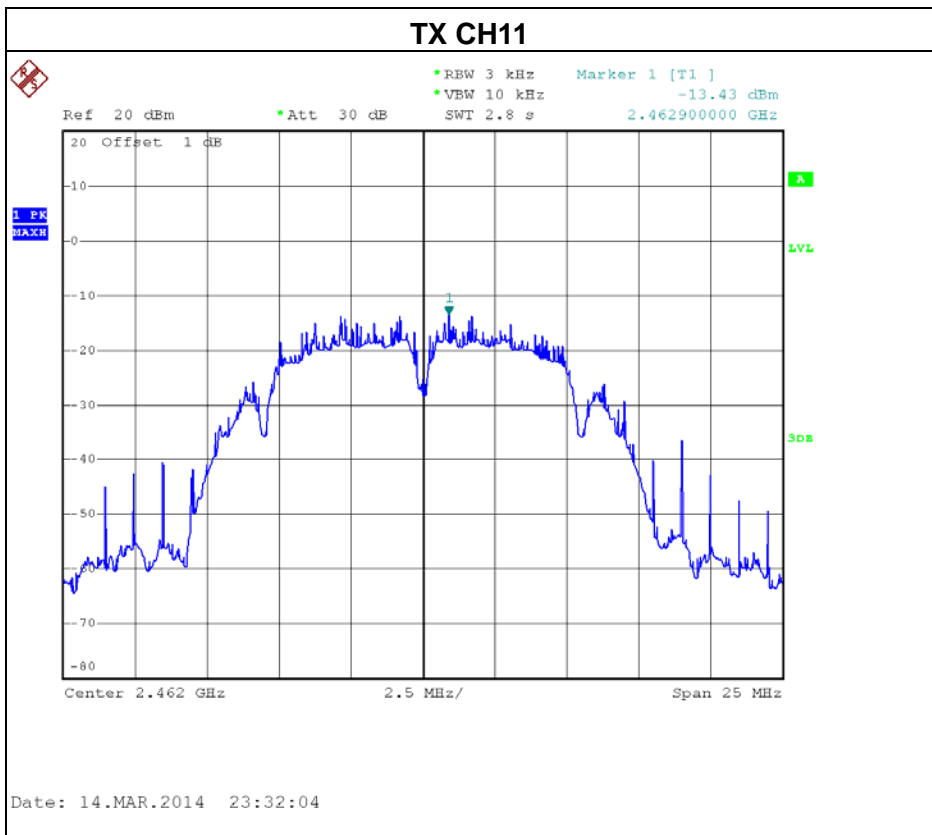
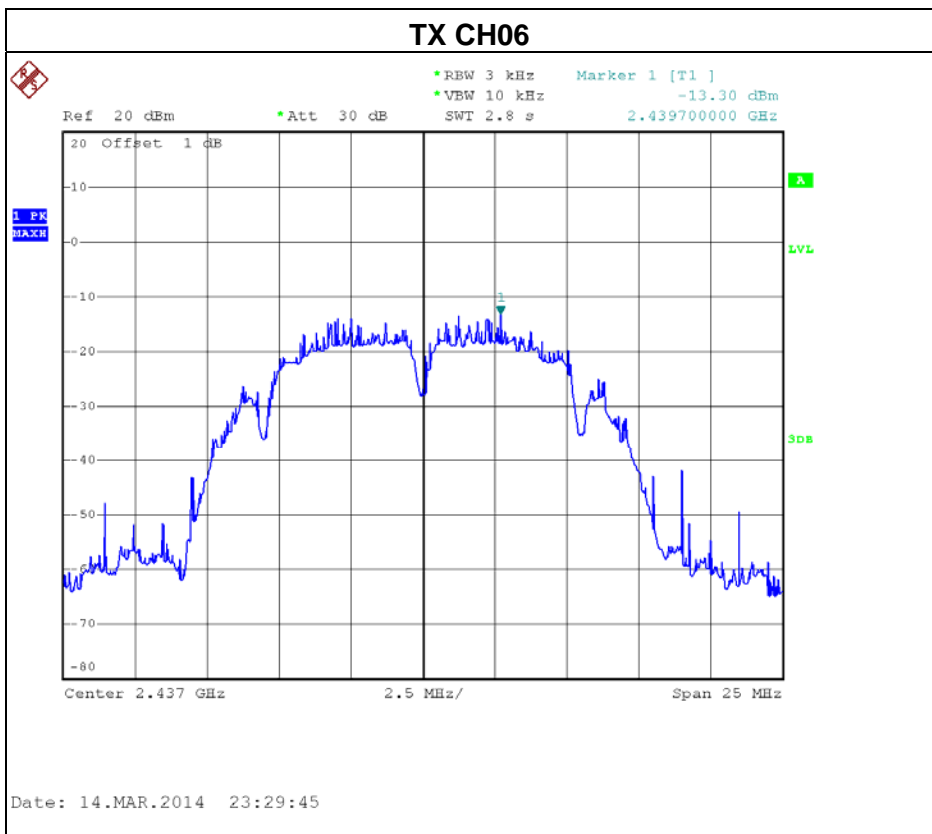



Test Mode : TX B Mode_CH01/06/11_Total			
Test Channel	Frequency (MHz)	Power Density (dBm)	Limit (dBm)
CH01	2412	-10.56	8
CH06	2437	-8.43	8
CH11	2462	-9.40	8



Test Mode :TX G Mode_CH01/06/11_ANT 1

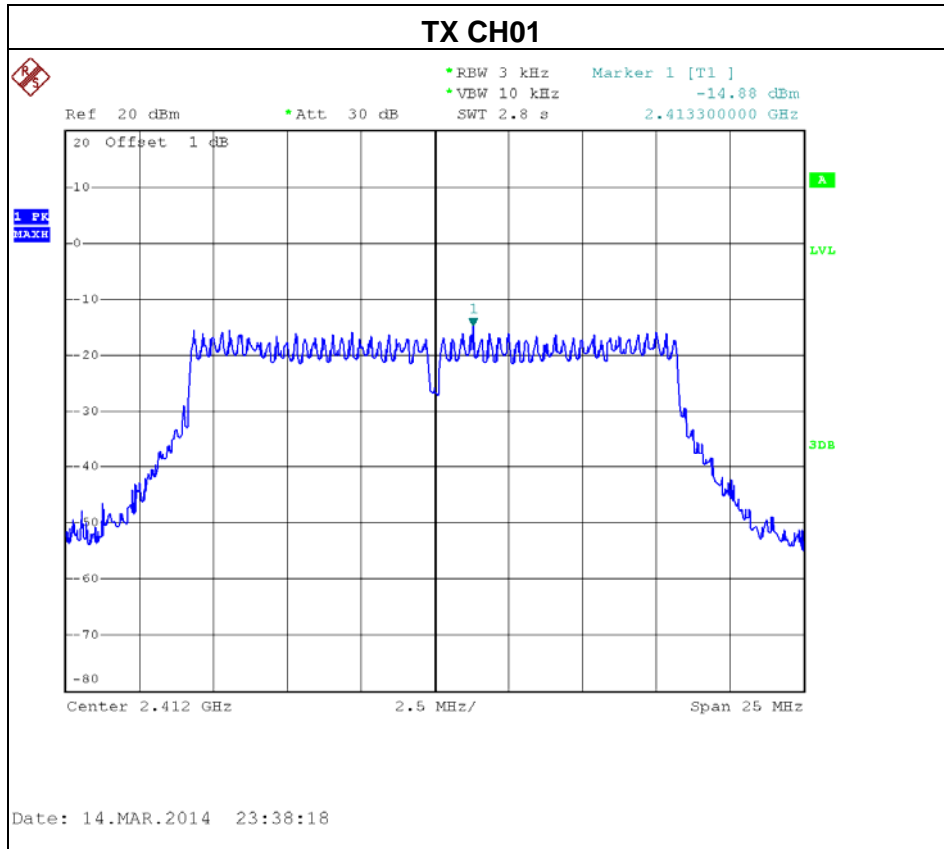

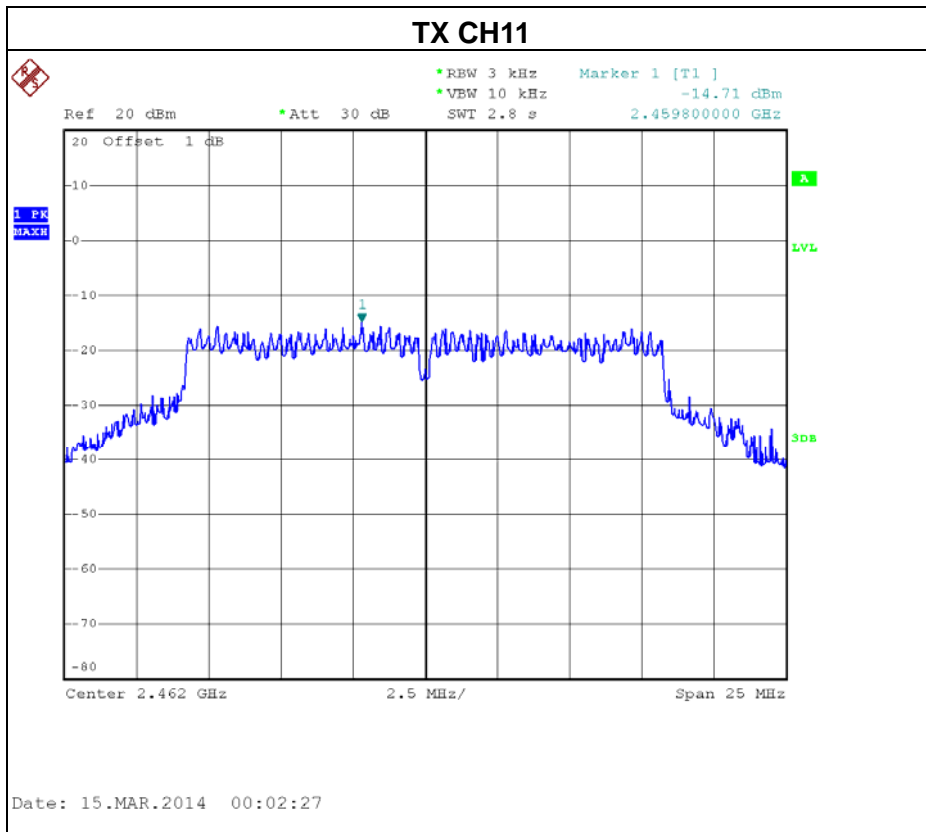
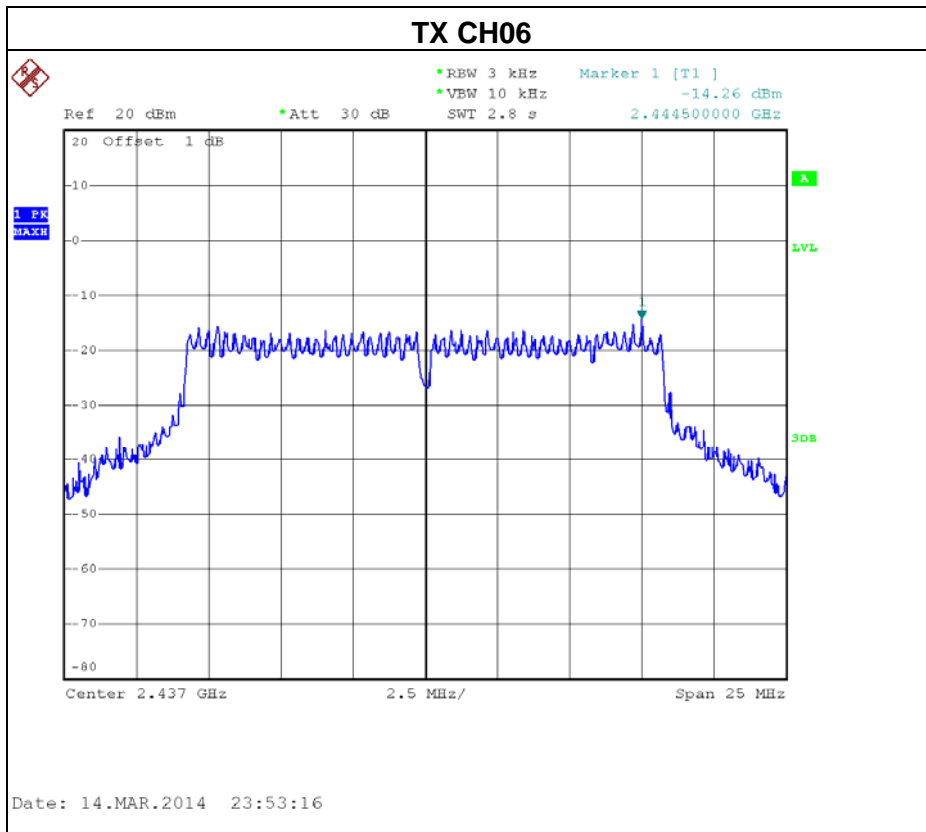



Test Mode :TX G Mode_CH01/06/11_ANT 2

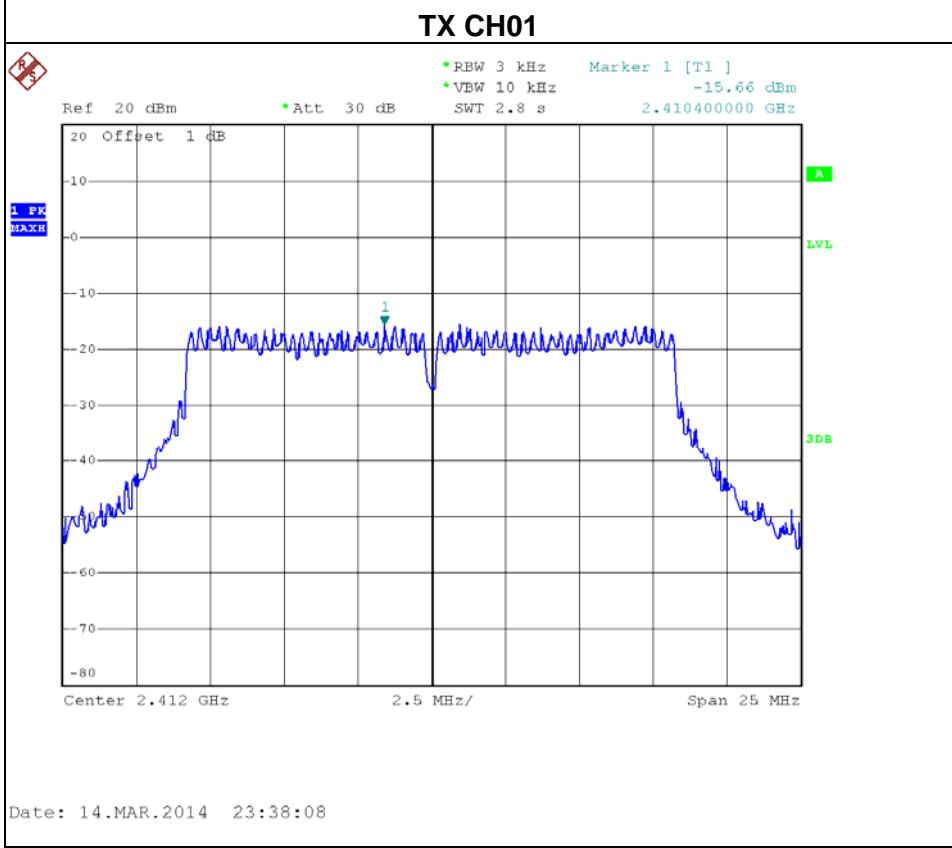

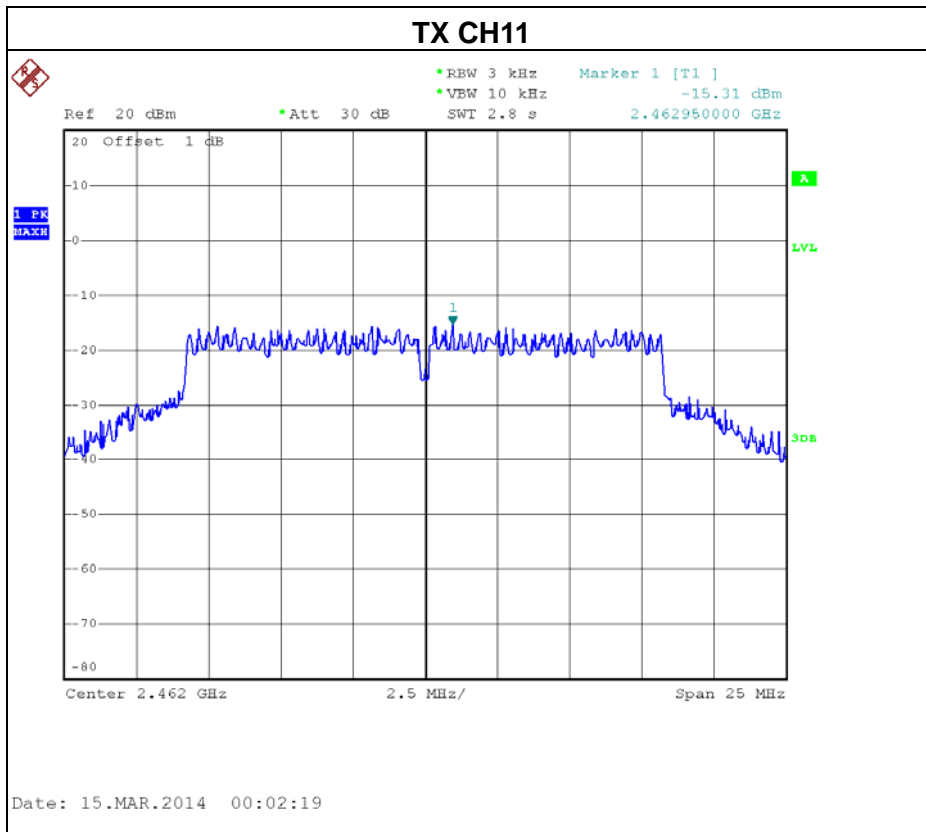
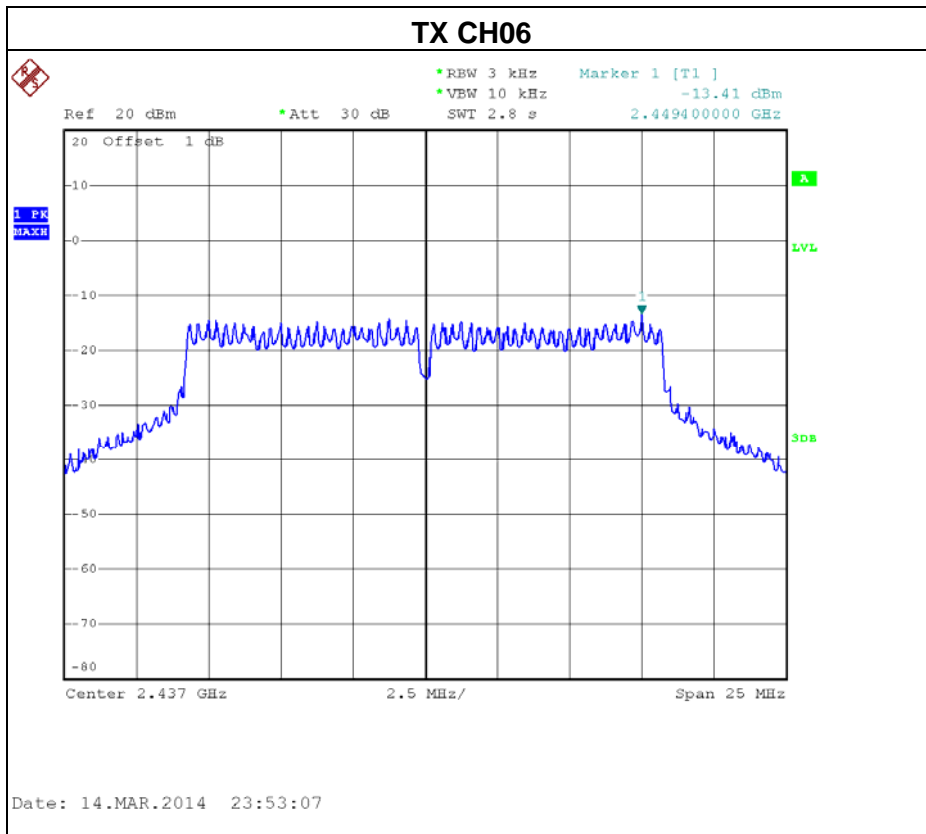



Test Mode : TX G Mode_CH01/06/11_Total			
Test Channel	Frequency (MHz)	Power Density (dBm)	Limit (dBm)
CH01	2412	-12.24	8
CH06	2437	-10.80	8
CH11	2462	-11.99	8



Test Mode : TX N-20M Mode_CH01/06/11_ANT 1

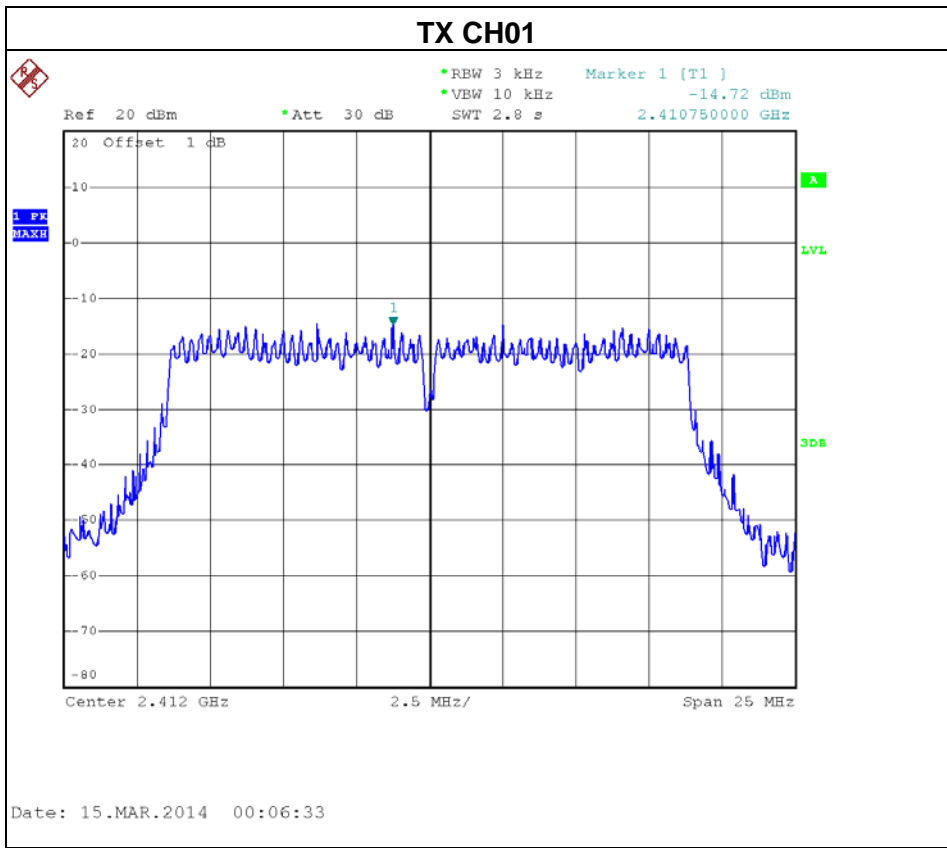

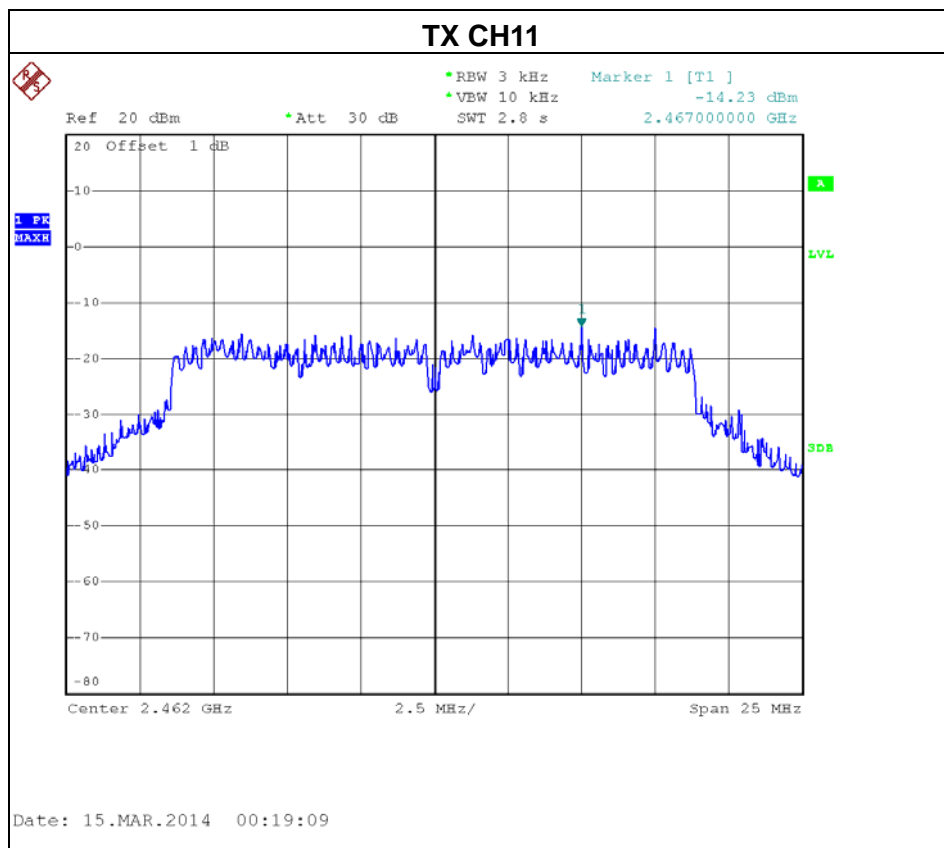
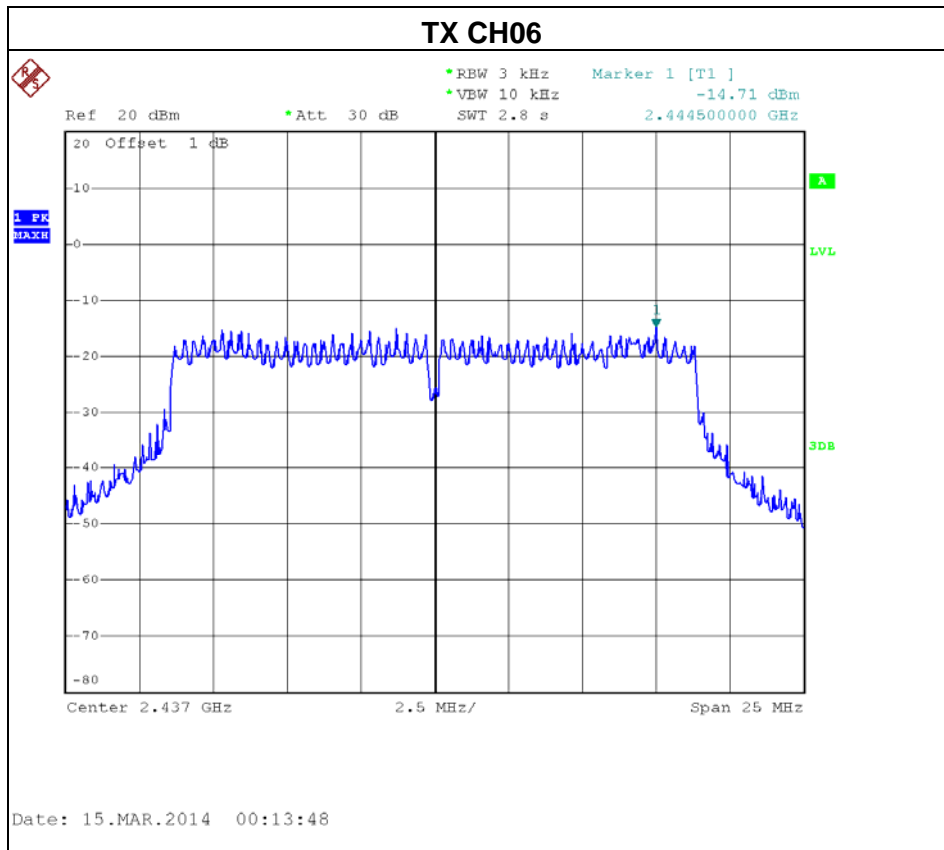



Test Mode : TX N-20M Mode_CH01/06/11_ANT 2

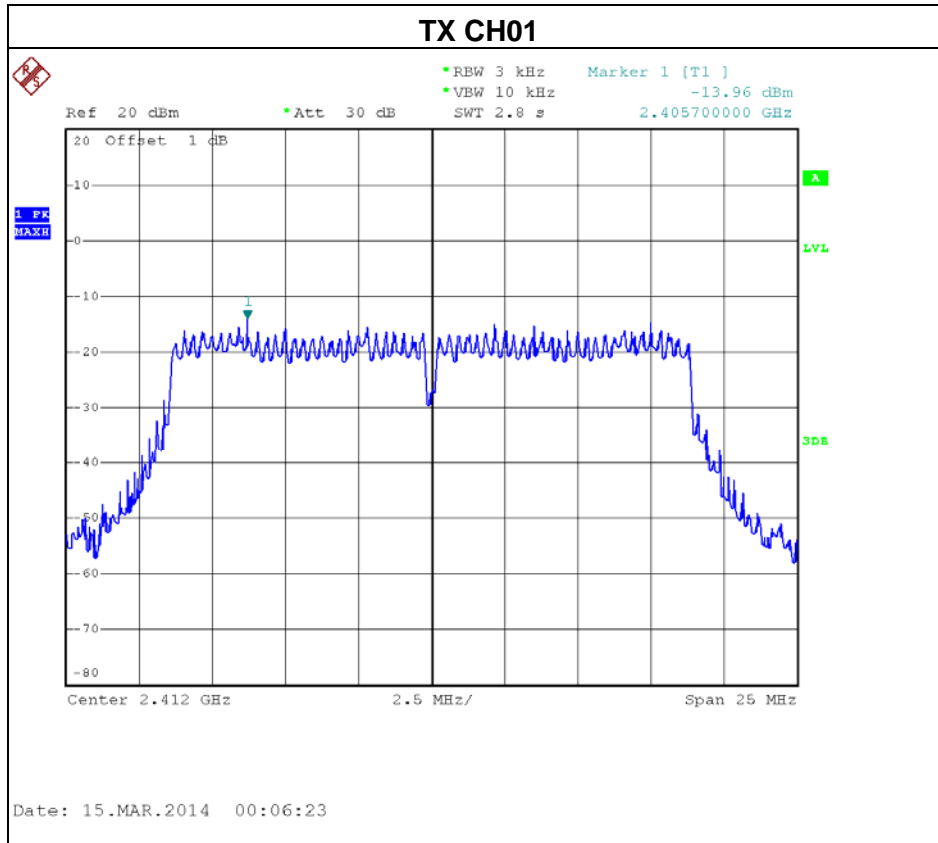

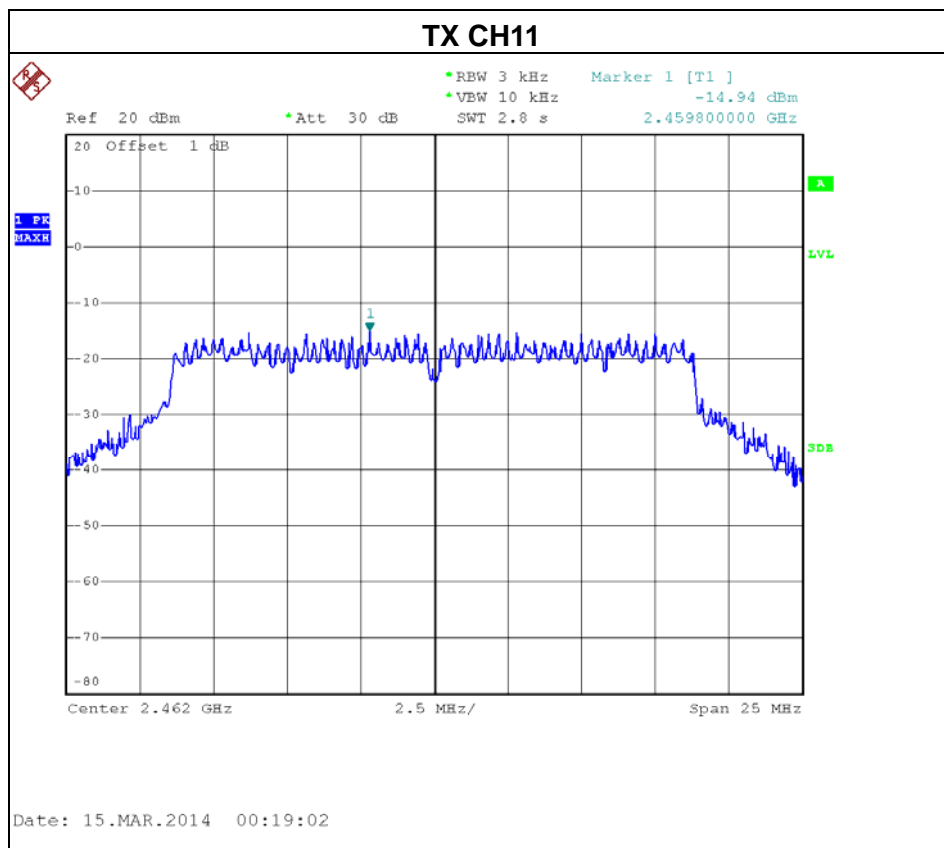
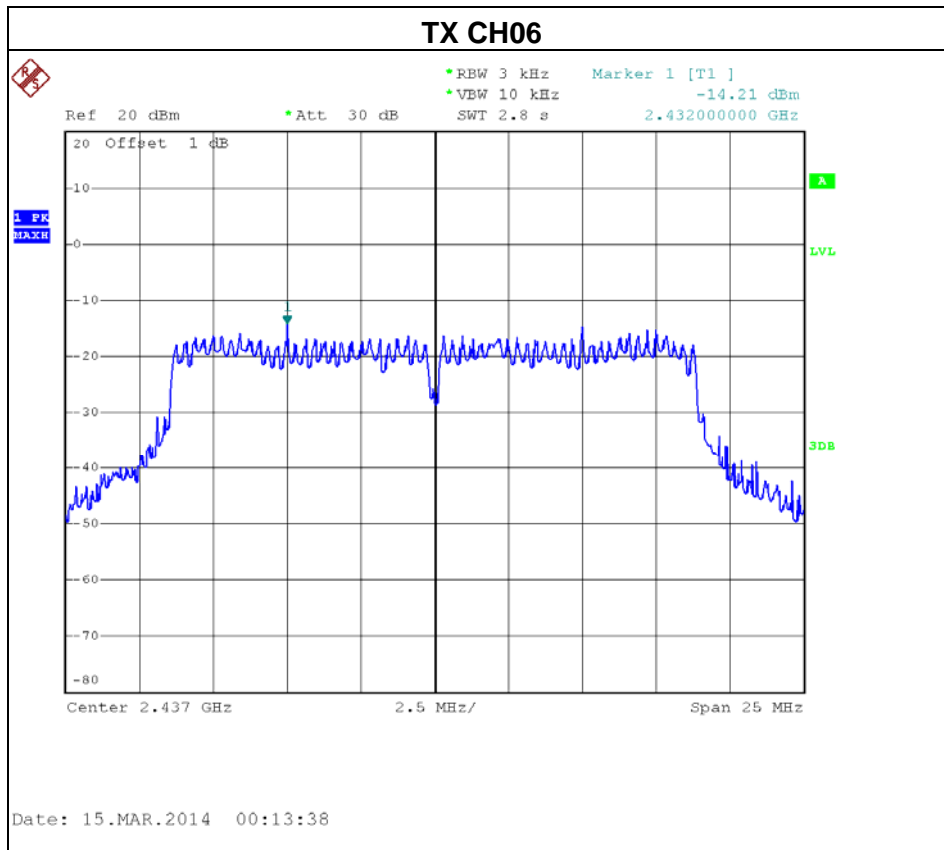



Test Mode : TX N-20M Mode_CH01/06/11_Total			
Test Channel	Frequency (MHz)	Power Density (dBm)	Limit (dBm)
CH01	2412	-11.31	8
CH06	2437	-11.44	8
CH11	2462	-11.56	8



Test Mode : TX N-40M Mode_CH03/06/09_ANT 1

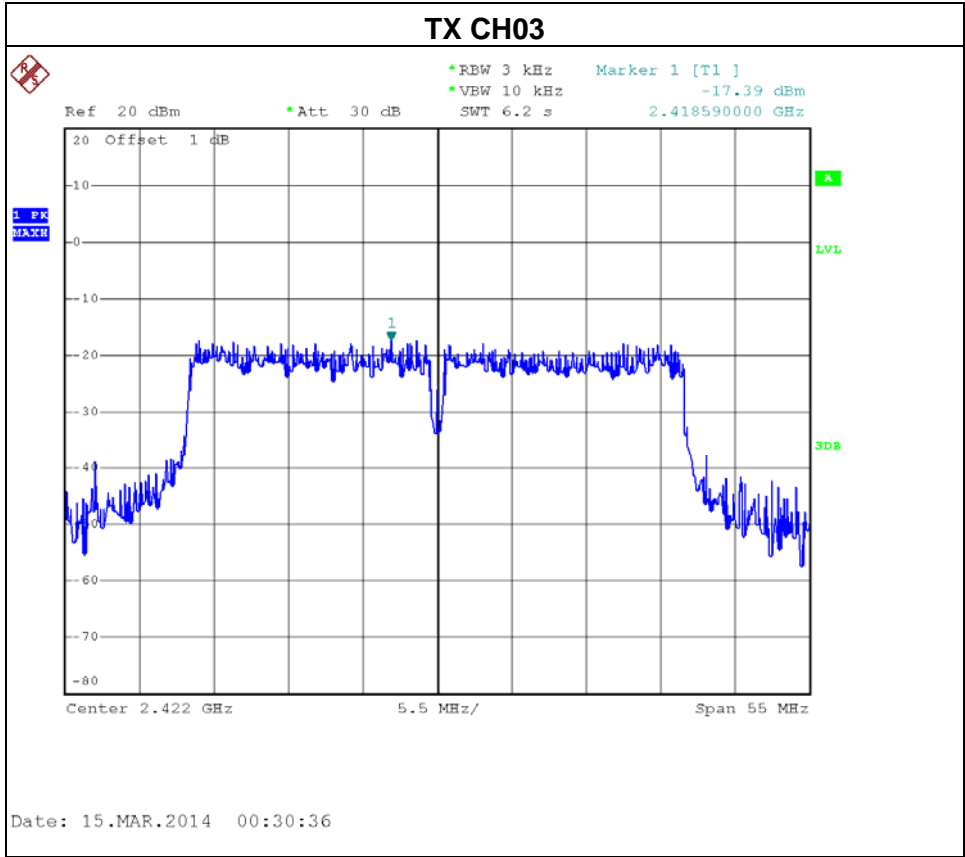

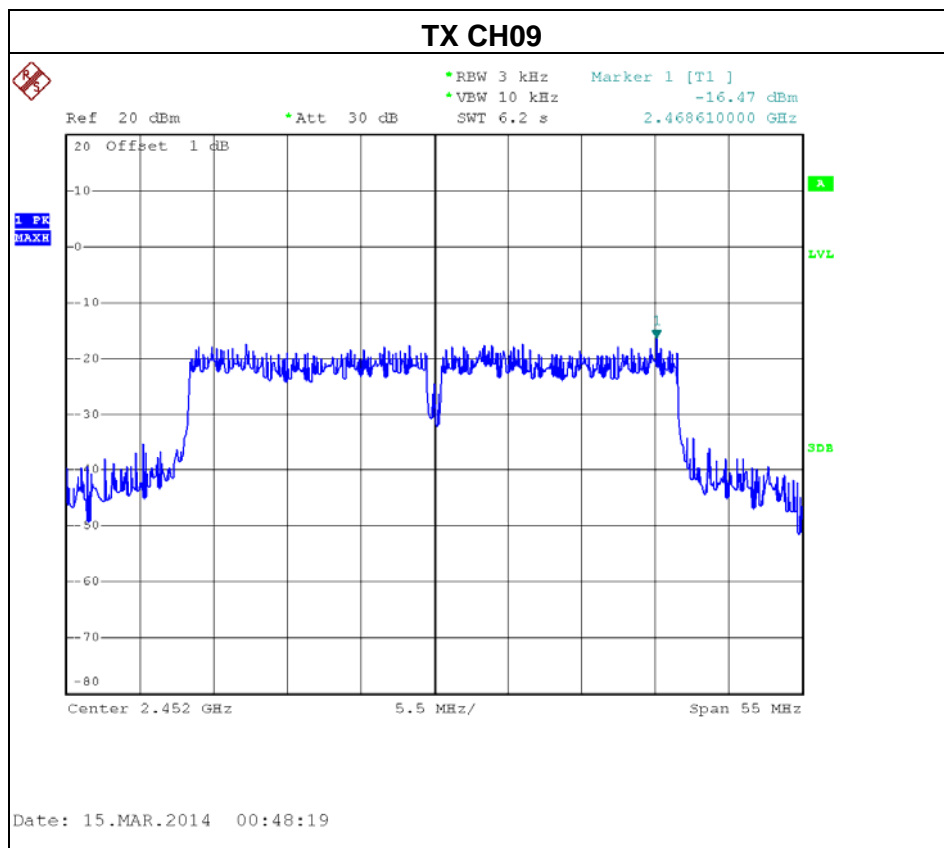
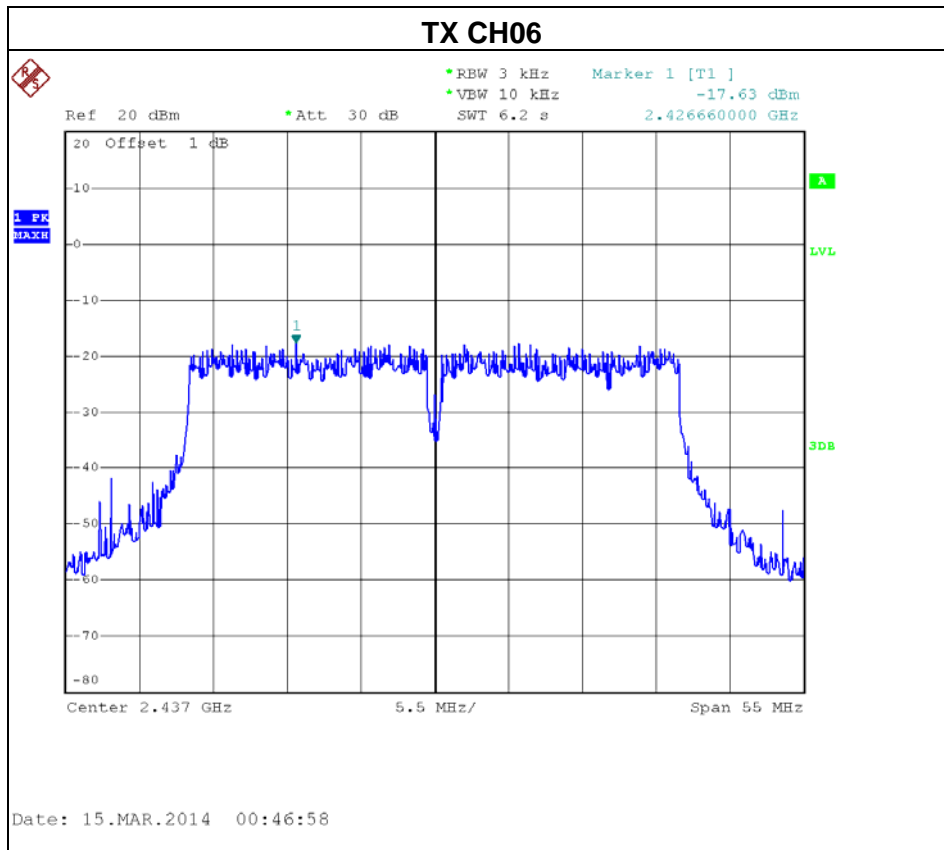



Test Mode : TX N-40M Mode_CH03/06/09_ANT 2

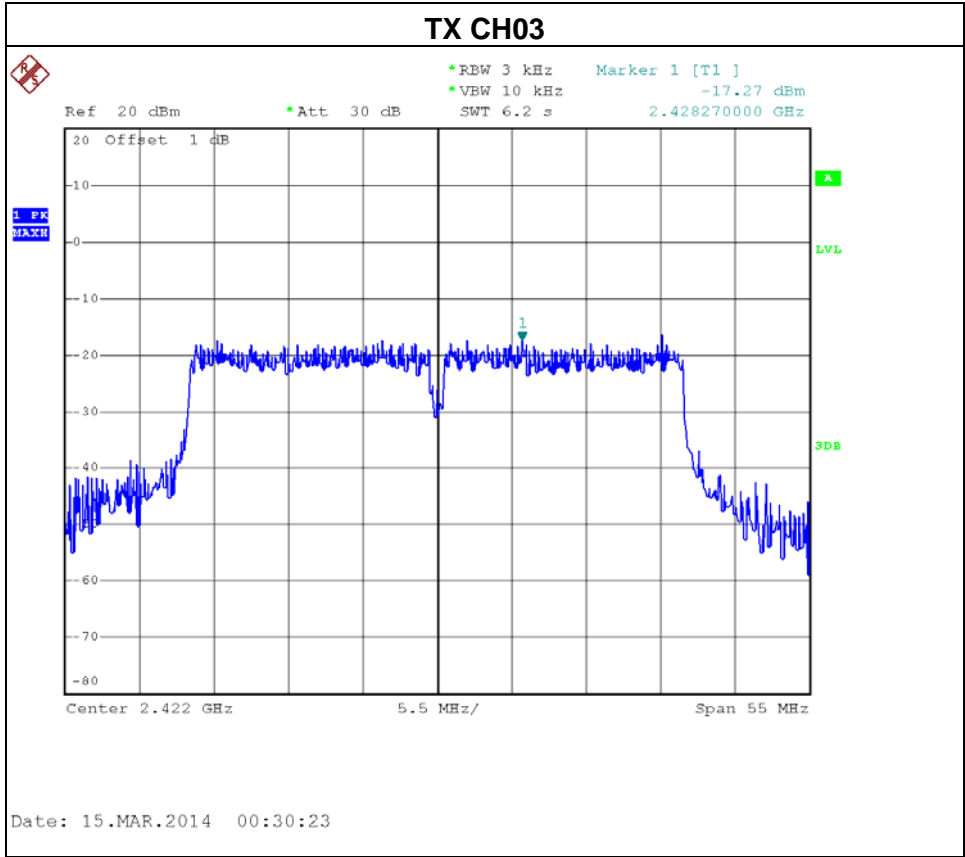

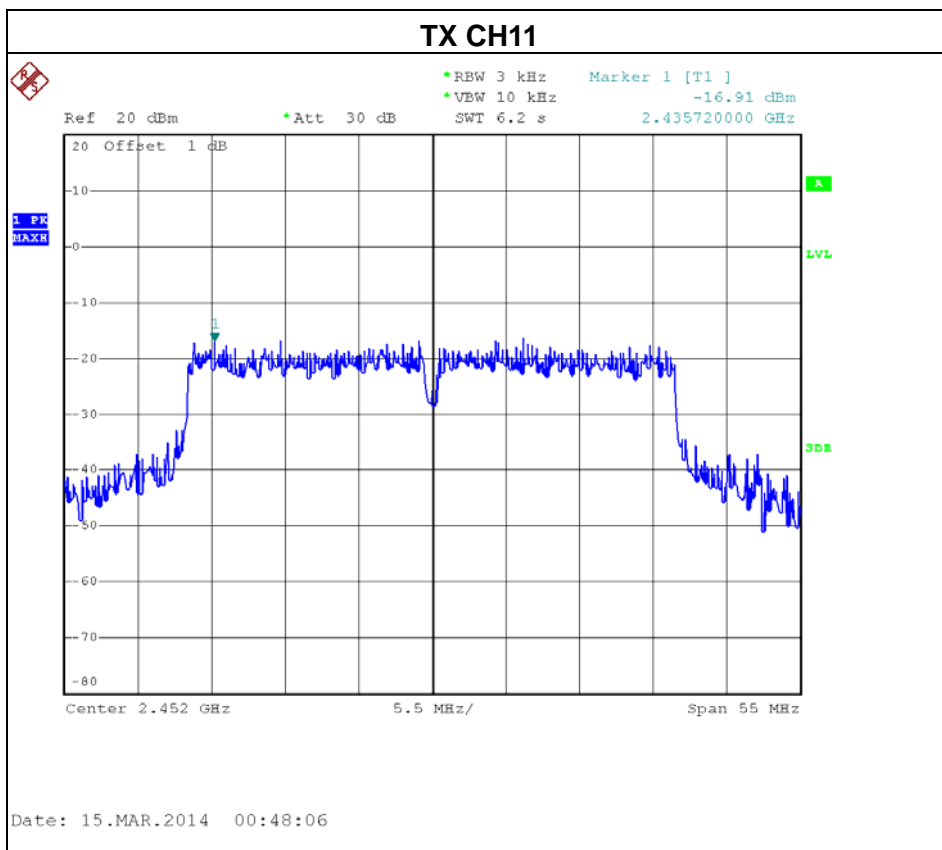
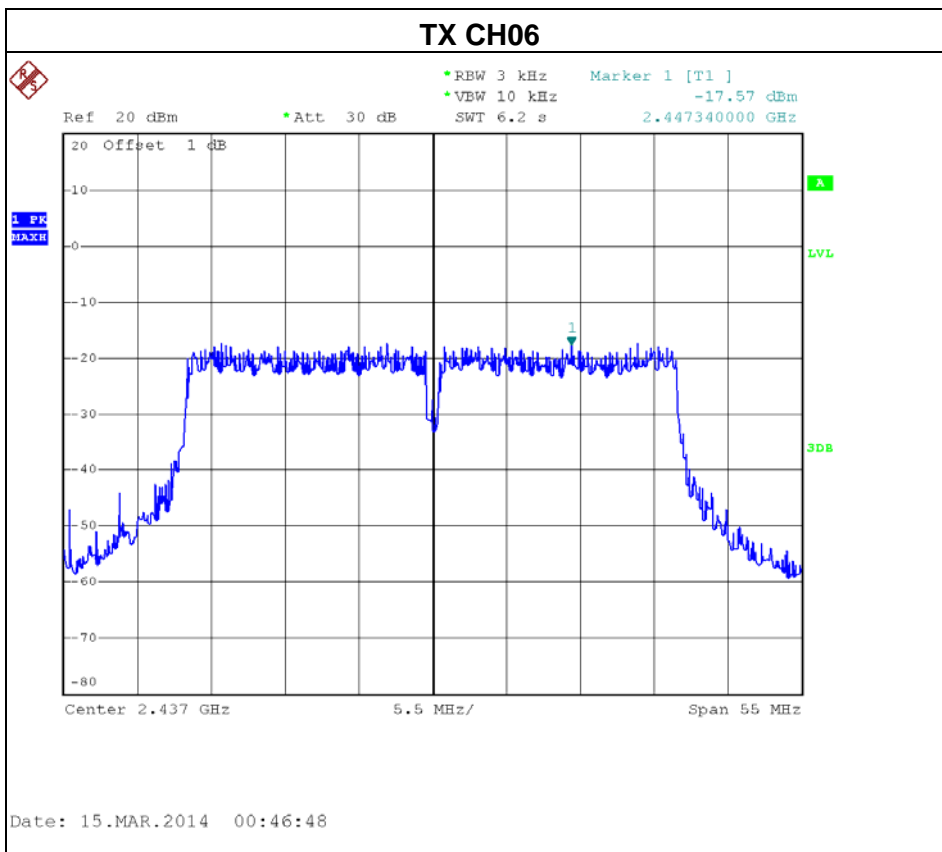



Test Mode : TX N-40M Mode_CH03/06/09_Total			
Test Channel	Frequency (MHz)	Power Density (dBm)	Limit (dBm)
CH03	2422	-14.32	8
CH06	2437	-14.59	8
CH09	2452	-13.67	8



9. MEASUREMENT INSTRUMENTS LIST

Conducted Emission Measurement					
Item	Kind of Equipment	Manufacturer	Type No.	Serial No.	Calibrated until
1	LISN	EMCO	3816/2	00052765	Apr. 25, 2014
2	LISN	R&S	ENV216	100087	Nov. 09, 2014
3	Test Cable	N/A	C_17	N/A	Mar.14, 2015
4	EMI TEST RECEIVER	R&S	ESCS30	826547/022	Apr. 25, 2014
5	50Ω Terminator	SHX	TF2-3G-A	08122902	Apr. 25, 2014

Radiated Emission Measurement					
Item	Kind of Equipment	Manufacturer	Type No.	Serial No.	Calibrated until
1	Antenna	Schwarzbeck	VULB9160	9160-3232	Apr. 25, 2014
2	Amplifier	HP	8447D	2944A09673	Apr. 25, 2014
3	Test Receiver	R&S	ESCI	100382	Apr. 25, 2014
4	Test Cable	N/A	C-01_CB03	N/A	Jul. 02, 2014
5	Antenna	ETS	3115	00075789	Apr. 25, 2014
6	Amplifier	Agilent	8449B	3008A02274	Apr. 25, 2014
7	Spectrum	Agilent	E4408B	US39240143	Nov. 09, 2014
8	Test Cable	HUBER+SUHNER	C-45	N/A	Apr. 30, 2014
9	Controller	CT	SC100	N/A	N/A
10	Horn Antenna	EMCO	3115	9605-4803	Apr. 25, 2014
11	Active Loop Antenna	R&S	HFH2-Z2	830749/020	Apr. 25, 2014
12	Broad-Band Horn Antenna	Schwarzbeck	BBHA 9170	9170319	Oct. 22, 2014

6dB Bandwidth Measurement					
Item	Kind of Equipment	Manufacturer	Type No.	Serial No.	Calibrated until
1	Spectrum Analyzer	R&S	FSP 40	100185	Nov. 09, 2014

Peak Output Power Measurement					
Item	Kind of Equipment	Manufacturer	Type No.	Serial No.	Calibrated until
1	P-series Power meter	Agilent	N1911A	MY45100473	Apr. 25, 2014
2	Wireband Power sensor	Agilent	N1921A	MY51100041	Apr. 25, 2014



Antenna Conducted Spurious Emission Measurement					
Item	Kind of Equipment	Manufacturer	Type No.	Serial No.	Calibrated until
1	Spectrum Analyzer	R&S	FSP 40	100185	Nov. 09, 2014

Power Spectral Density Measurement					
Item	Kind of Equipment	Manufacturer	Type No.	Serial No.	Calibrated until
1	Spectrum Analyzer	R&S	FSP 40	100185	Nov. 09, 2014

Remark: "N/A" denotes no model name, serial no. or calibration specified.
All calibration period of equipment list is one year.



10. EUT TEST PHOTO

Conducted Measurement Photos

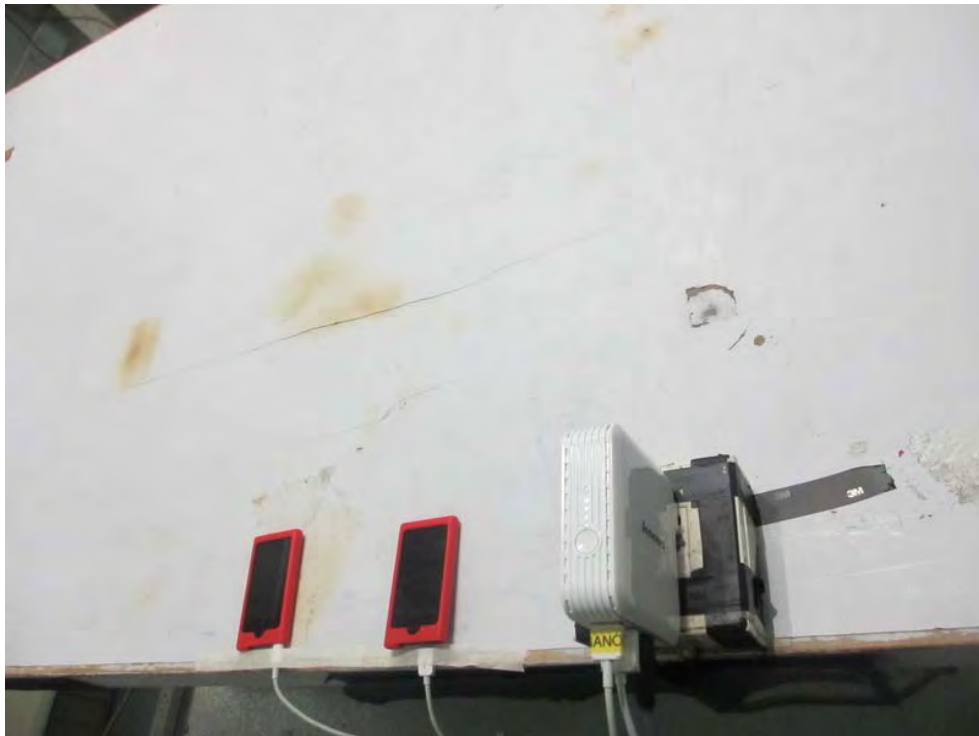



**Radiated Measurement Photos
9K~30MHz**

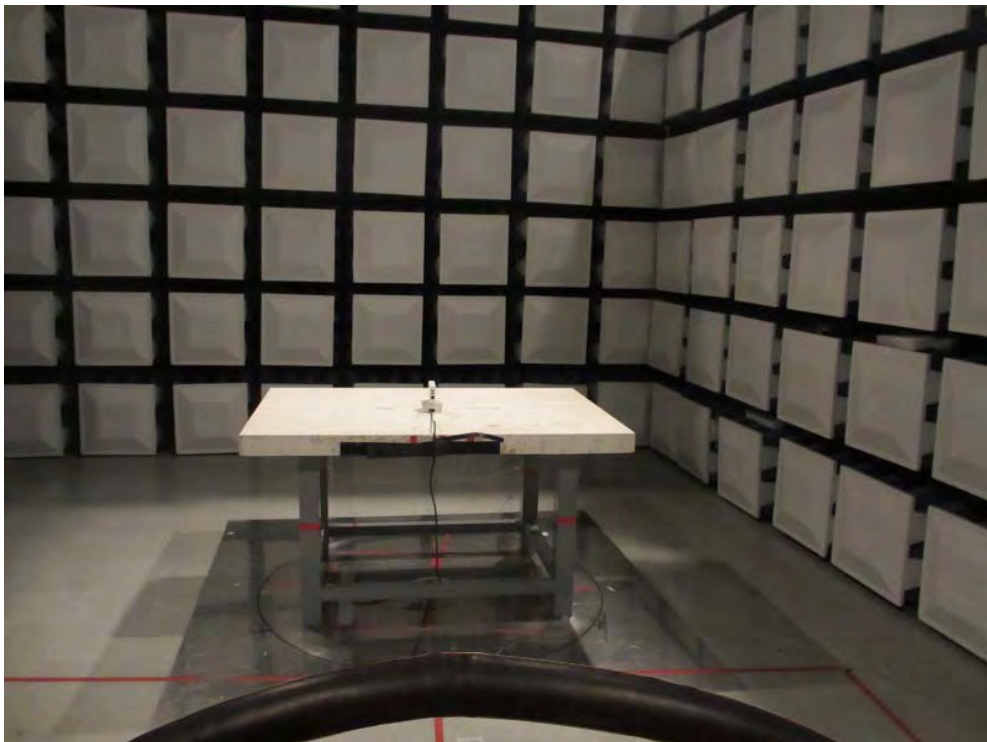
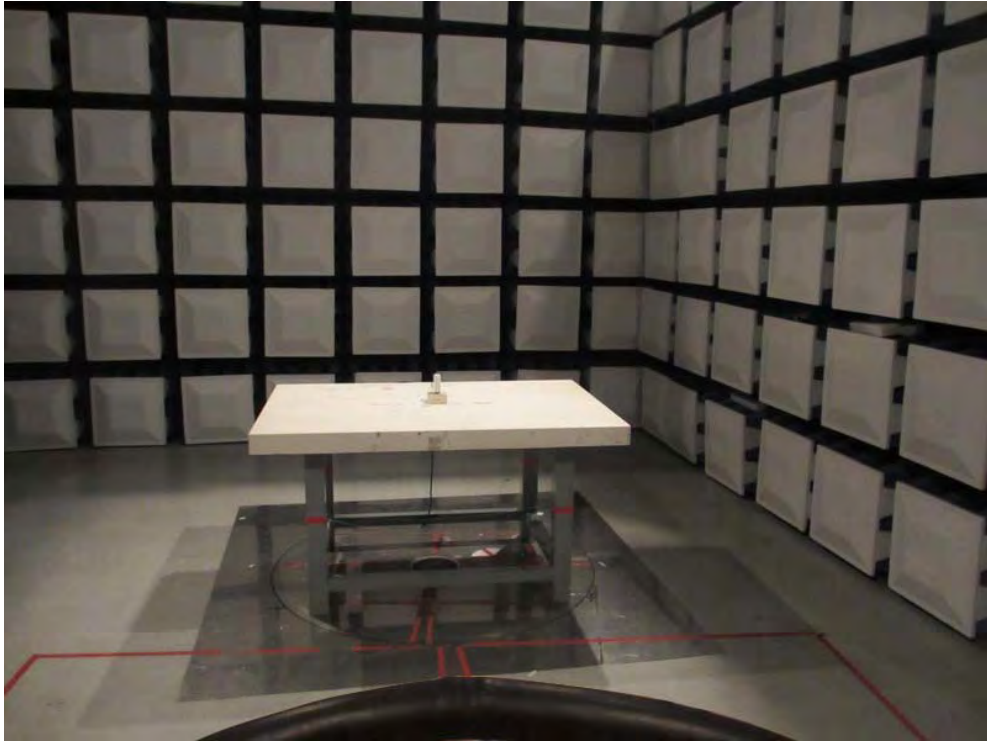



**Radiated Measurement Photos
30~1000MHz**

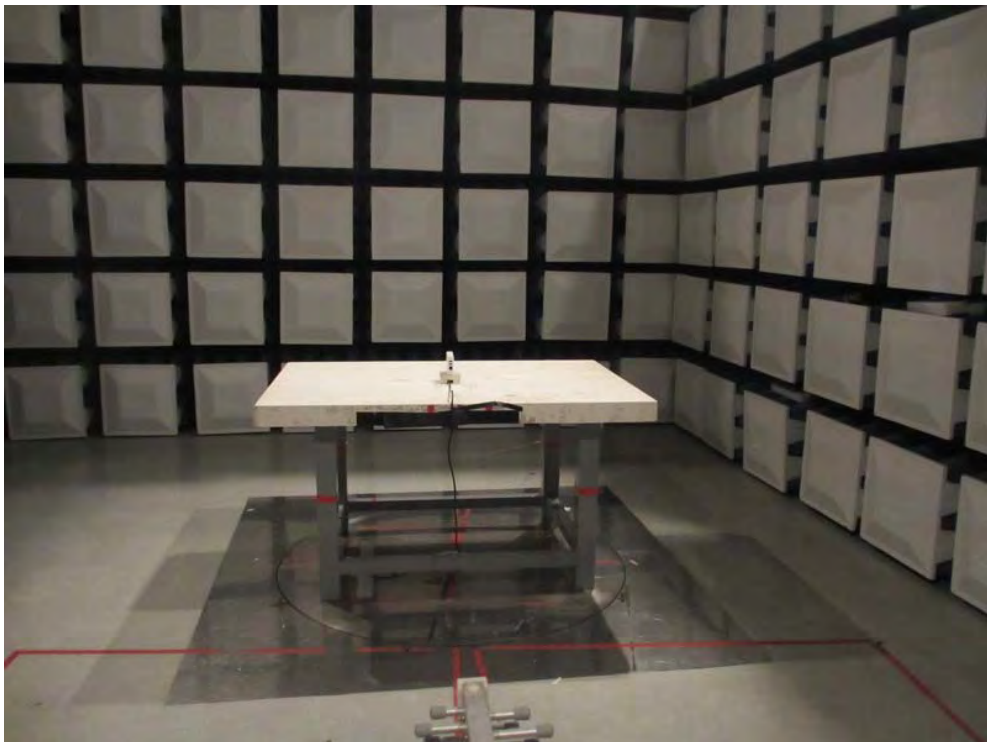
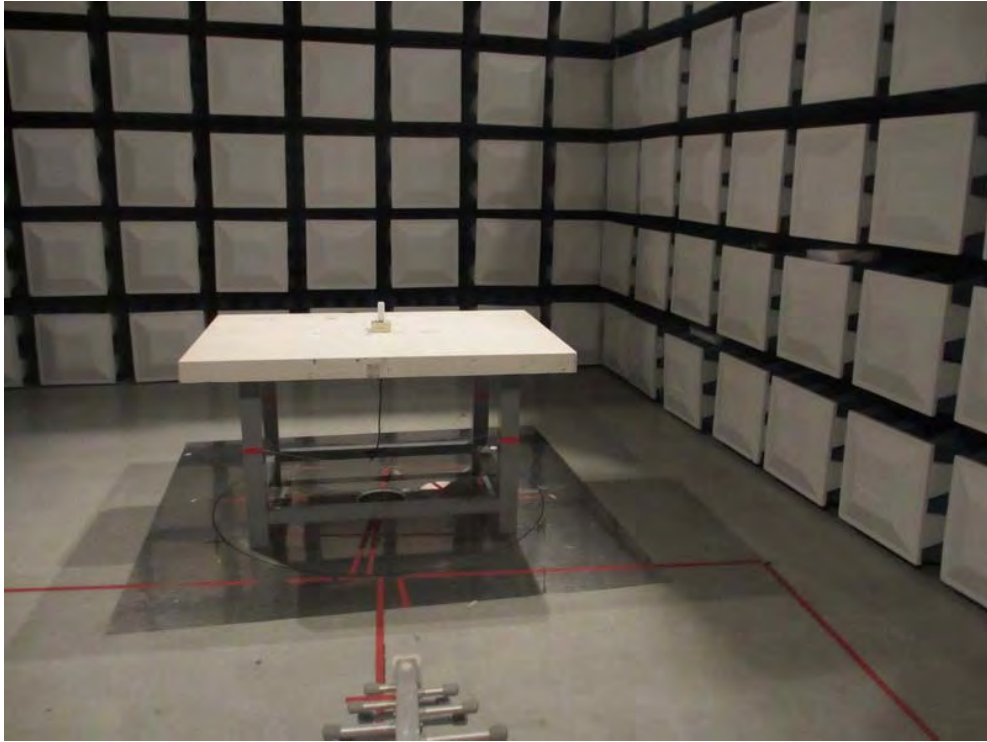



**Radiated Measurement Photos
Above 1000MHz**

