

Model No.: ZT31D-F

Brand Name: CARDIOSPORT

Product Name: TP5 Duplex Heart

Rate Transmitter

Antenna Spec

DATA SHEET

永昶科技股份有限公司

5220 Chip antenna

For Bluetooth / WLAN Applications

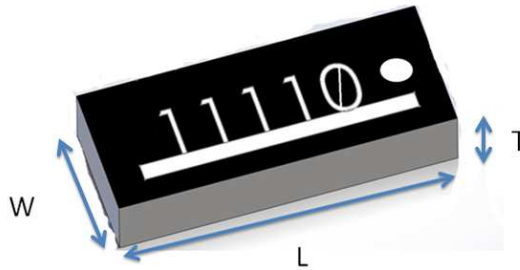

P/N: WAN5220D245M04

	Dimension (mm)
L	5.20 ± 0.10
W	2.12 ± 0.10
T	1.05 ± 0.10

1. Electrical Specification

Specification		
Part Number	WAN5220D245M04	
Central Frequency	2450	MHz
Bandwidth	100 (Min.)	MHz
Return Loss	-10 (Max)	dB
Peak Gain	1.57	dBi
Impedance	50	Ohm
Operating Temperature	-40~+85	°C
Maximum Power	4	W
Resistance to Soldering Heats	10 (@ 260°C)	sec.
Polarization	Linear	
Azimuth Beamwidth	Omni-directional	
Termination	Ni / Sn (Leadless)	

Remark : Bandwidth & Peak Gain was measured under evaluation board of page2

◆ Part Number Information

WAN 5220 D 245 M 04
 A B C D E F

A	Product Series	Antenna
B	Dimension L x W	5.2X2.0mm (+-0.2mm)
C	Material	High K material
D	Working Frequency	2.4 ~ 2.5GHz
E	Feeding mode	Monopole & Single Feeding
F	Antenna type	Type 04

2. Recommended PCB Pattern

◆ Evaluation Board Dimension

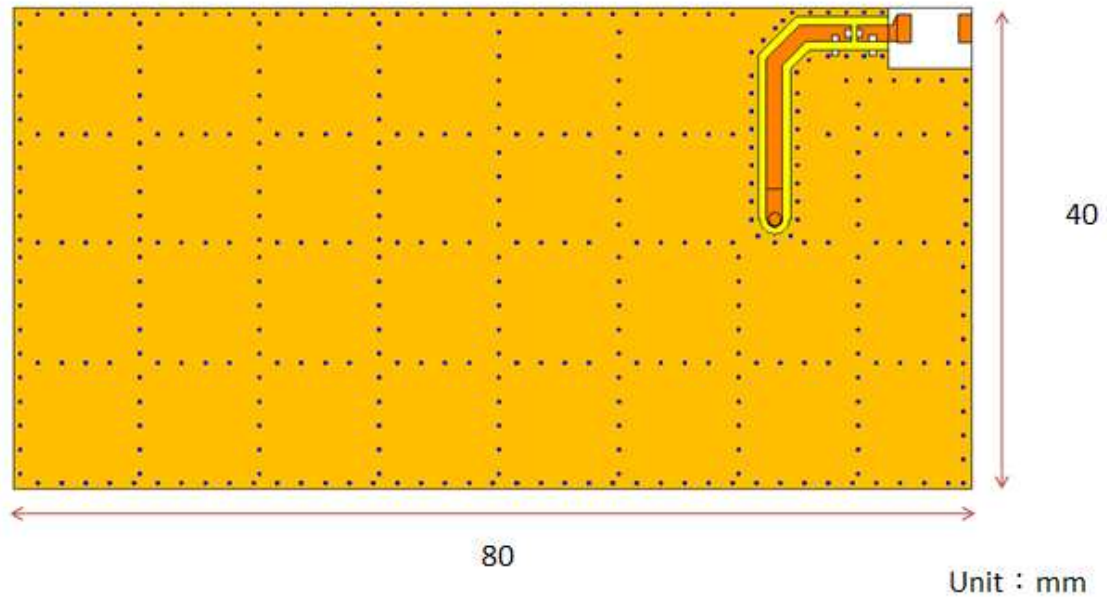

◆ Suggested Matching Circuit

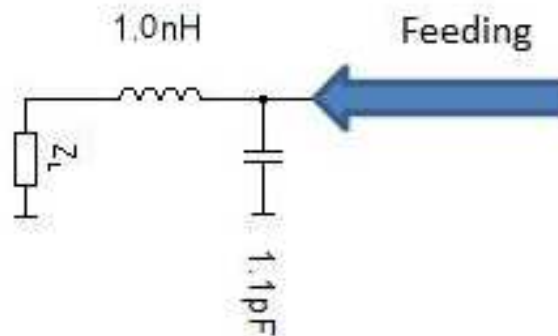

◆ Layout Dimensions in Clearance area(Size=7.0*5.0mm)

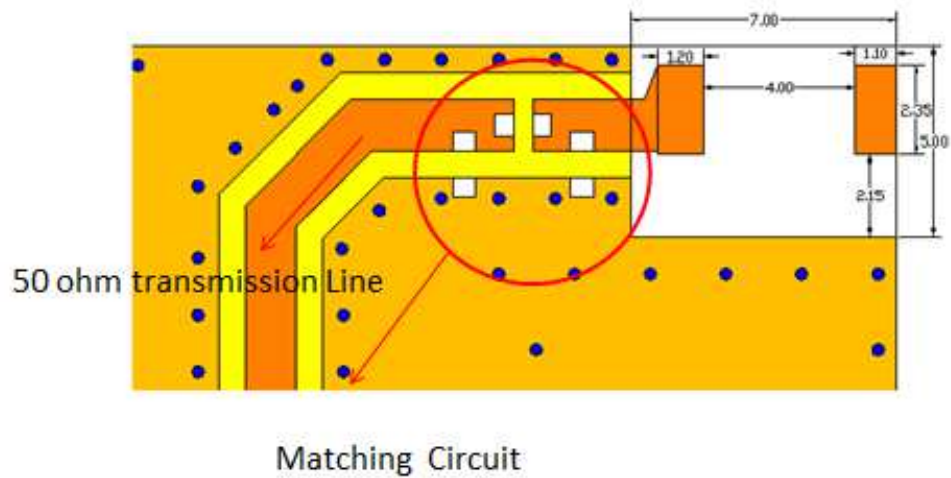

FootPrint (Unit : mm)

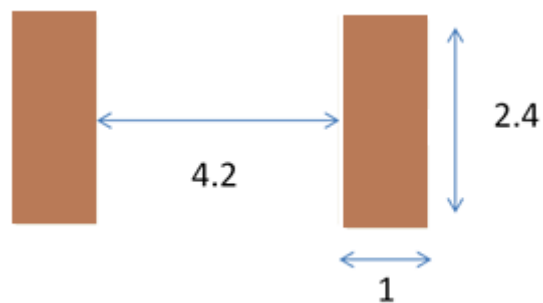

3. Measurement Results

◆ Return Loss

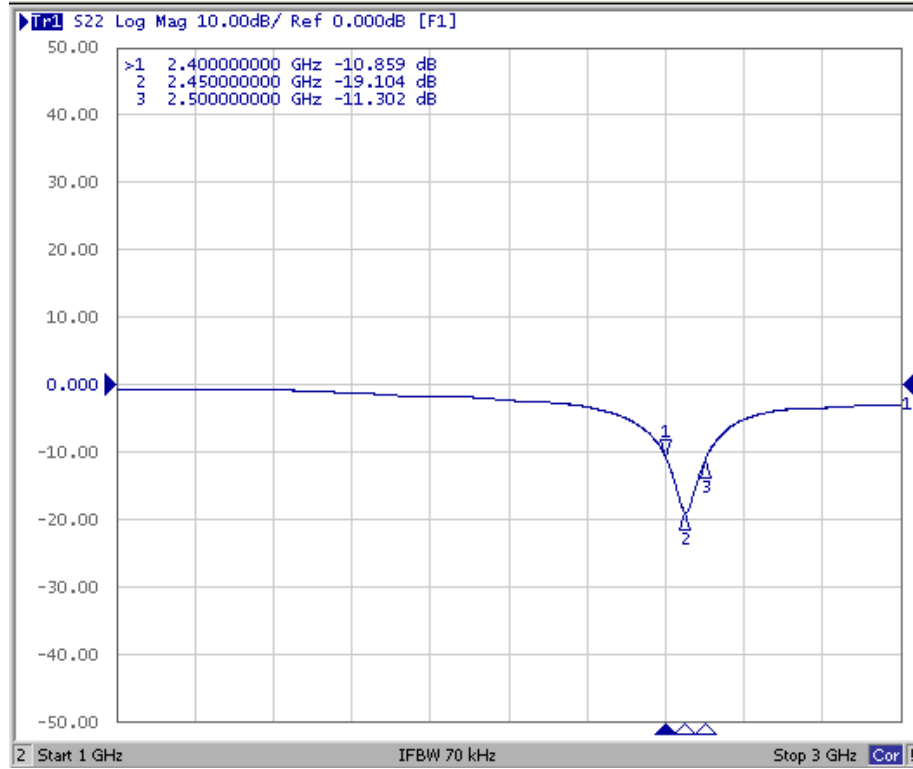

◆ Radiation Pattern

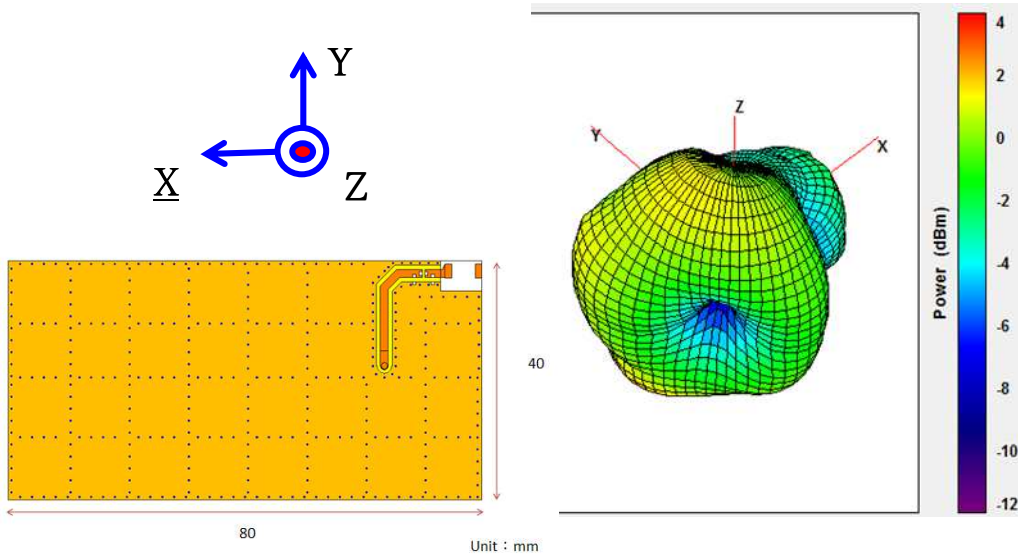

	Efficiency	Peak Gain	Directivity
2400MHz	55.56 %	0.57 dBi	4.13 dBi
2450MHz	70.58 %	1.79 dBi	4.03 dBi
2500MHz	57.13 %	1.26 dBi	4.11 dBi

Chamber Coordinate System

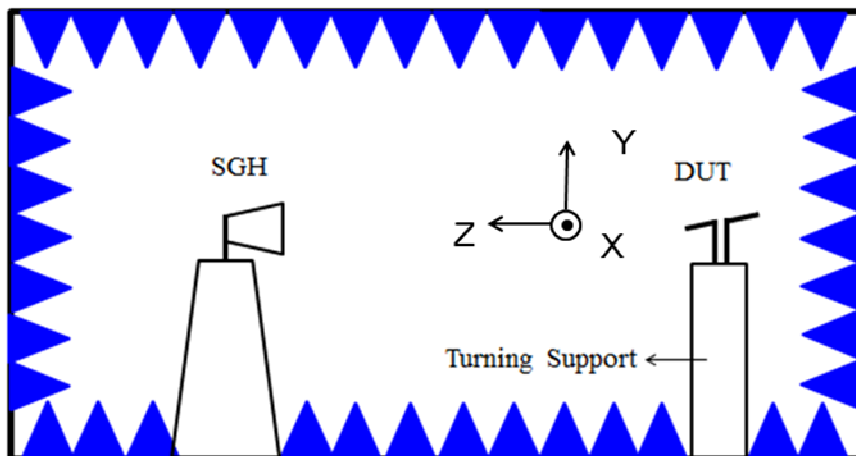

4. Reliability and Test Conditions

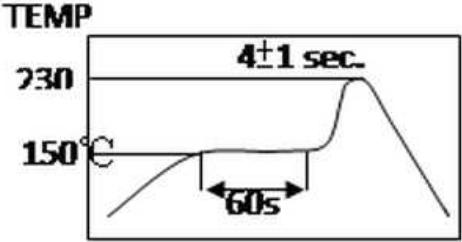
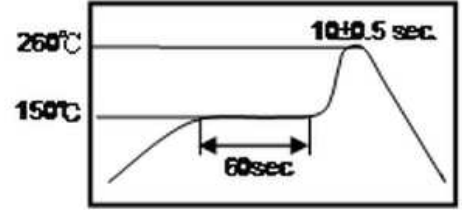
ITEM	REQUIREMENTS	TEST CONDITION
Solderability	1. Wetting shall exceed 90% coverage 2. No visible mechanical damage 	<ul style="list-style-type: none"> ✓ Pre-heating temperature:150°C /60sec. ✓ Solder temperature:230±5°C ✓ Duration:4±1sec. ✓ Solder:Sn-Ag3.0-Cu0.5 ✓ Flux for lead free: rosin
Solder heat Resistance	1. No visible mechanical damage 2. Central Freq. change :within ± 6% 	<ul style="list-style-type: none"> ✓ Pre-heating temperature:150°C /60sec. ✓ Solder temperature:260±5°C ✓ Duration:10±0.5sec. ✓ Solder:Sn-Ag3.0-Cu0.5 ✓ Flux for lead free: rosin
Component Adhesion (Push test)	1. No visible mechanical damage	The device should be reflow soldered(230±5°C for 10sec.) to a tinned copper substrate A dynamometer force gauge should be applied the side of the component. The device must with-ST-F 0.5 Kg without failure of the termination attached to component.
Component Adhesion (Pull test)	1. No visible mechanical damage	<ul style="list-style-type: none"> ✓ Insert 10cm wire into the remaining open eye bend ,the ends of even wire lengths upward and wind together. ✓ Terminal shall not be remarkably damaged.

Thermal shock	1. No visible mechanical damage	<ul style="list-style-type: none"> ✓ +85°C => 30±3min -40°C => 30±3min ✓ Test cycle: 10 cycles ✓ The chip shall be stabilized at normal condition for 2~3 hours before measuring. 															
	2. Central Freq. change :within ±6%																
	<table border="1"> <thead> <tr> <th>Phase</th> <th>Temperature(°C)</th> <th>Time(min)</th> </tr> </thead> <tbody> <tr> <td>1</td> <td>+85±5°C</td> <td>30±3</td> </tr> <tr> <td>2</td> <td>Room Temperature</td> <td>Within 3sec</td> </tr> <tr> <td>3</td> <td>-40±2°C</td> <td>30±3</td> </tr> <tr> <td>4</td> <td>Room Temperature</td> <td>Within 3sec</td> </tr> </tbody> </table>		Phase	Temperature(°C)	Time(min)	1	+85±5°C	30±3	2	Room Temperature	Within 3sec	3	-40±2°C	30±3	4	Room Temperature	Within 3sec
	Phase		Temperature(°C)	Time(min)													
	1		+85±5°C	30±3													
2	Room Temperature	Within 3sec															
3	-40±2°C	30±3															
4	Room Temperature	Within 3sec															
Resistance to High Temperature	1. No visible mechanical damage 2. Central Freq. change :within ±6% 3. No disconnection or short circuit.	<ul style="list-style-type: none"> ✓ Temperature: 85±5°C ✓ Duration: 1000±12hrs ✓ The chip shall be stabilized at normal condition for 2~3 hours before measuring. 															
Resistance to Low Temperature	1. No visible mechanical damage 2. Central Freq. change :within ±6% 3. No disconnection or short circuit.	<ul style="list-style-type: none"> ✓ Temperature: -40±5°C ✓ Duration: 1000±12hrs ✓ The chip shall be stabilized at normal condition for 2~3 hours before measuring. 															
Humidity	1. No visible mechanical damage 2. Central Freq. change :within ±6% 3. No disconnection or short circuit.	<ul style="list-style-type: none"> ✓ Temperature: 40±2°C ✓ Humidity: 90% to 95% RH ✓ Duration: 1000±12hrs ✓ The chip shall be stabilized at normal condition for 2~3 hours before measuring. 															

5. Soldering and Mounting

Mildly activated rosin fluxes are preferred. The minimum amount of solder can lead to damage from the stresses caused by the difference in coefficients of expansion between solder, chip and substrate. The terminations are suitable for all wave and re-flow soldering systems. If hand soldering cannot be avoided, the preferred technique is the utilization of hot air soldering tools.

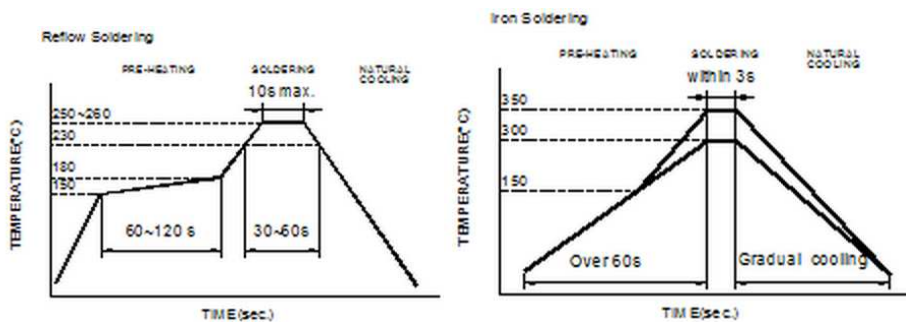

Recommended temperature profiles for re-flow soldering in Figure 1.

Products attachment with a soldering iron is discouraged due to the inherent process control limitations. In the event that a soldering iron must be employed the following precautions are recommended.

- Preheat circuit and products to 150°C
- Never contact the ceramic with the iron tip
- Use a 20 watt soldering iron with tip diameter of 1.0mm
- 280°C tip temperature (max)
- 1.0mm tip diameter (max)
- Limit soldering time to 3 sec.

6. Packaging Information

◆ Tape Specification:

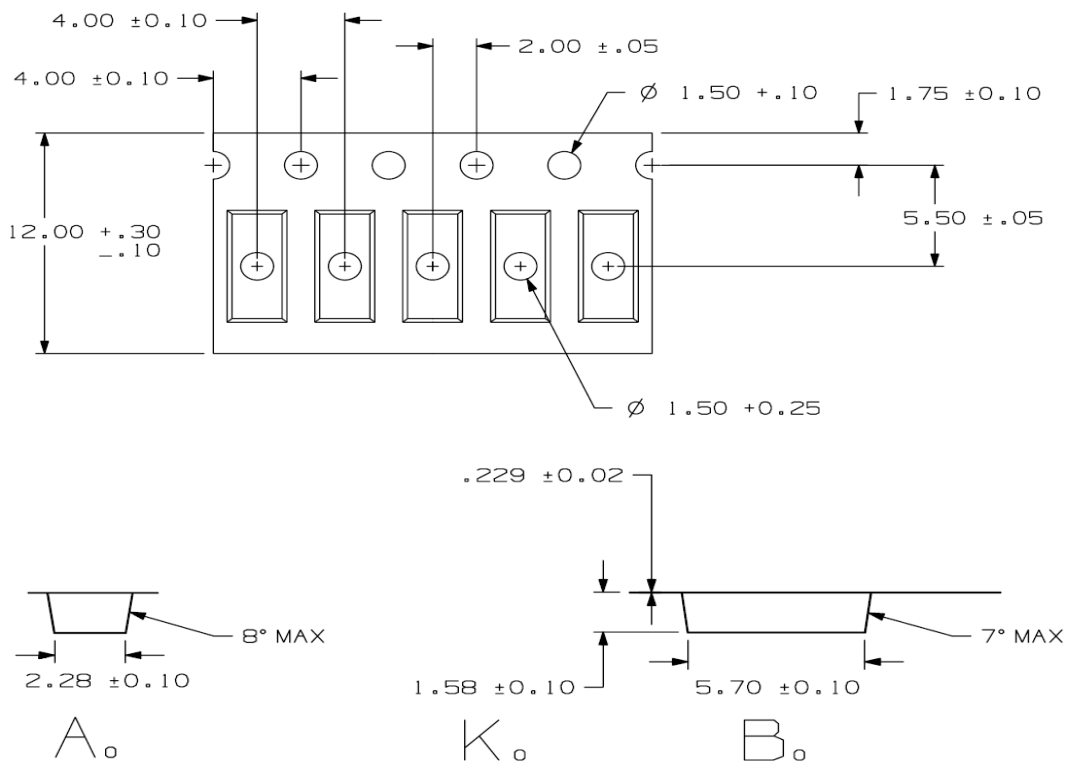

◆ Reel Specification: (7", Φ180 mm)

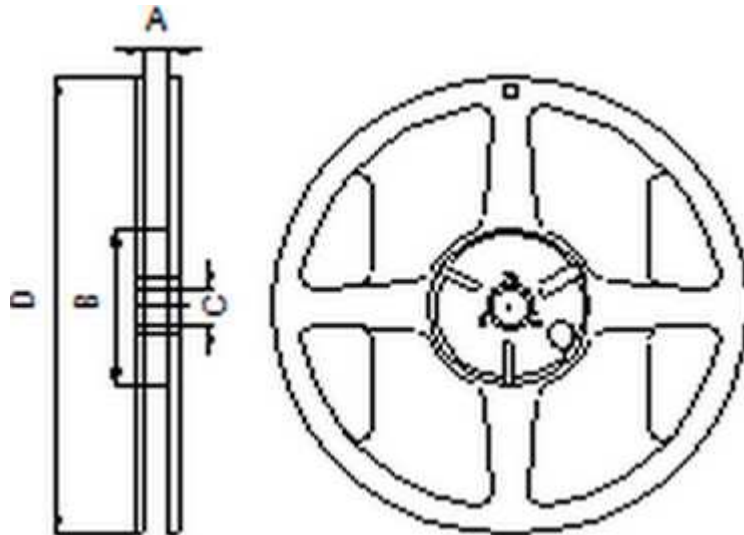

Tape Width(mm)	A(mm)	B(mm)	C(mm)	D(mm)	Chip/Reel(pcs)
12	12±1.0	60±2	13.5±0.5	178±2	2000

7. Storage and Transportation Information

◆ Storage Conditions

To maintain the solderability of terminal electrodes:

1. Temperature and humidity conditions: -10~ 40°C and 30~70% RH.
2. Recommended products should be used within 6 months from the time of delivery.
3. The packaging material should be kept where no chlorine or sulfur exists in the air.

◆ Transportation Conditions

1. Products should be handled with care to avoid damage or contamination from perspiration and skin oils.
2. The use of tweezers or vacuum pick up is strongly recommended for individual components.
3. Bulk handling should ensure that abrasion and mechanical shock are minimized.

8. Revision Table

Revision	Date	Content	Remark
V1	9 th , Dec, 2013	New issued	