

ZAS1A-01A2

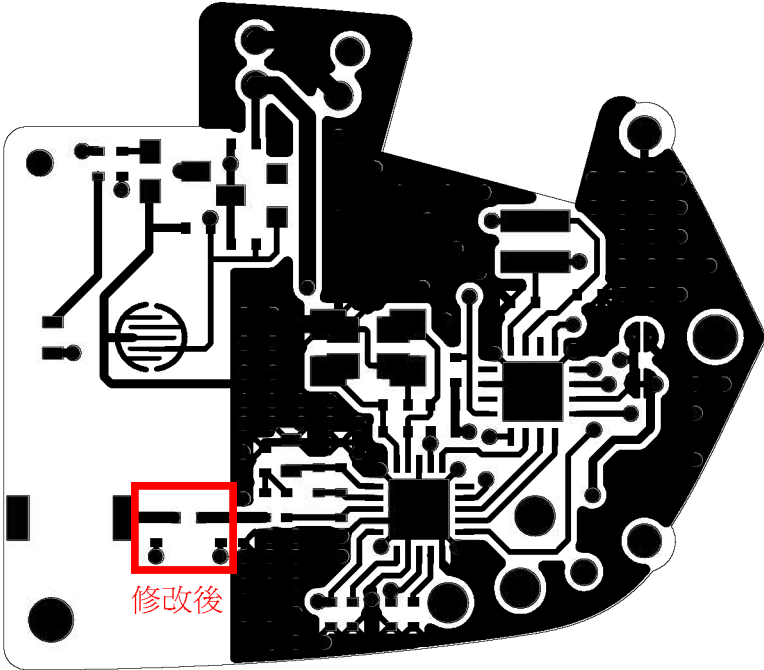

修改後

#COMP SIDE

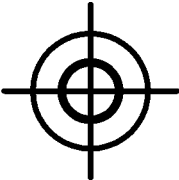
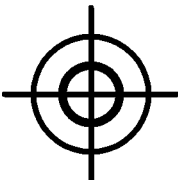
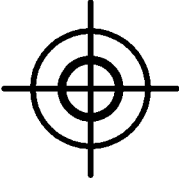

ΣΑ10-Α12ΑΣ

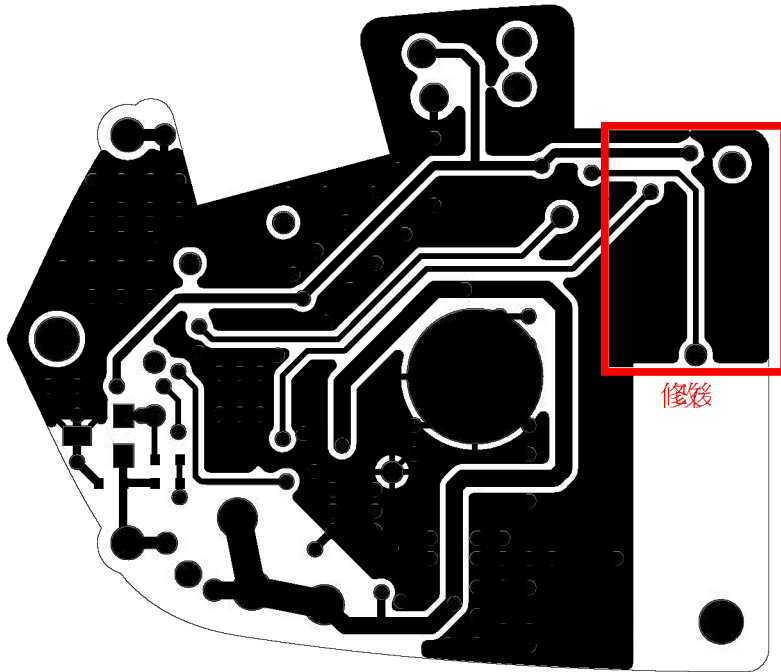
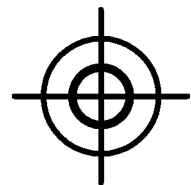
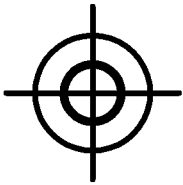

修後

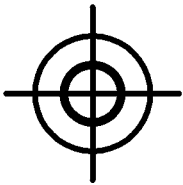

#SOLD SIDE

ZAS1A-01A2

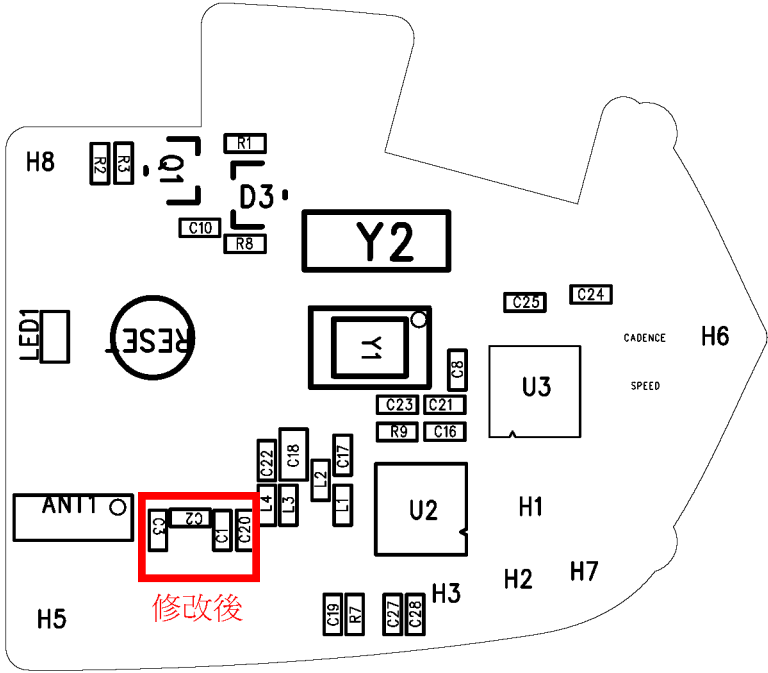
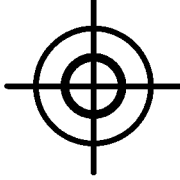
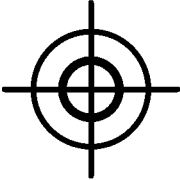

修改後

#COMP SILK

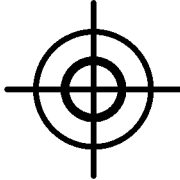

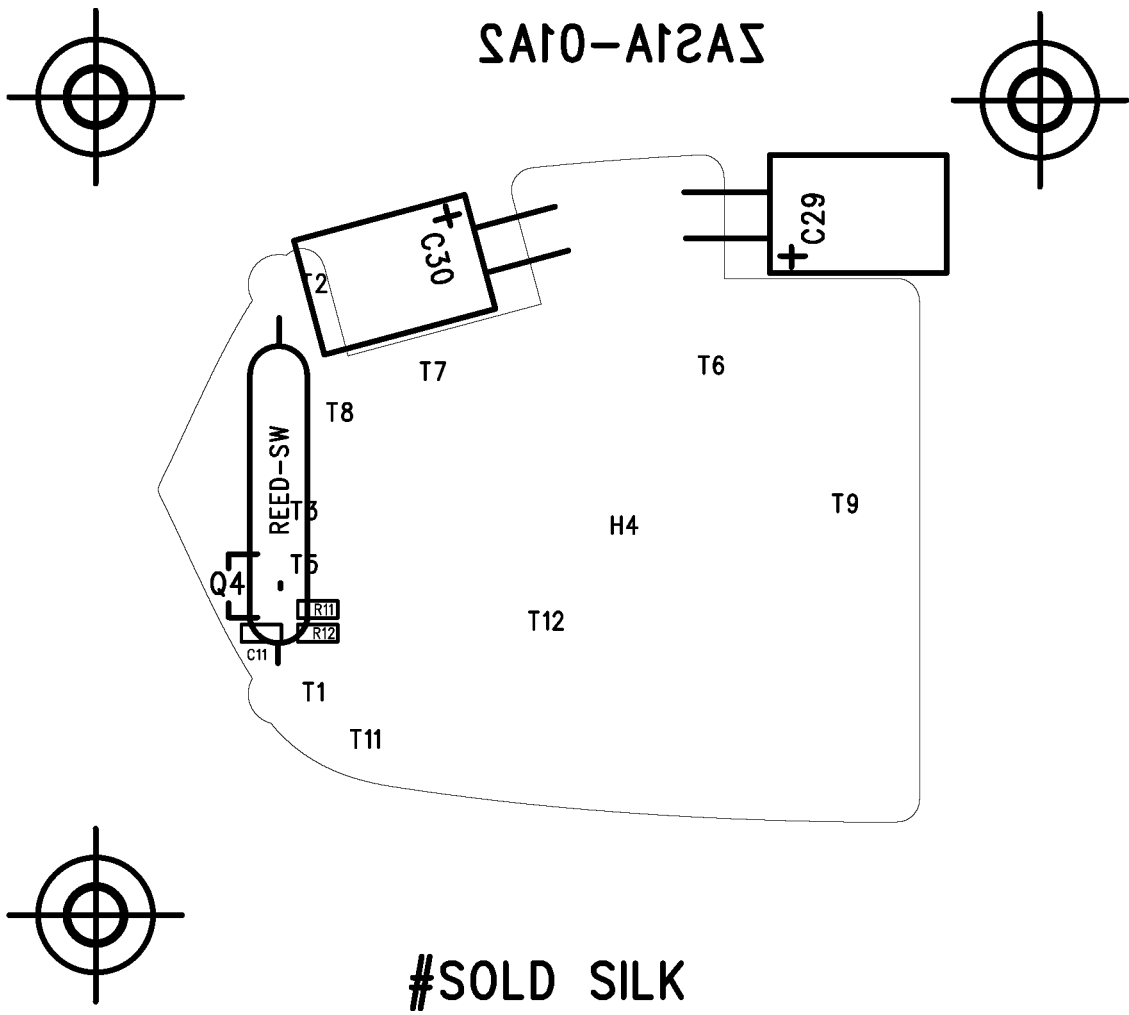

6

5

4

3

2

1

REVISION RECORD			
LTR	ECO NO:	APPROVED:	DATE:

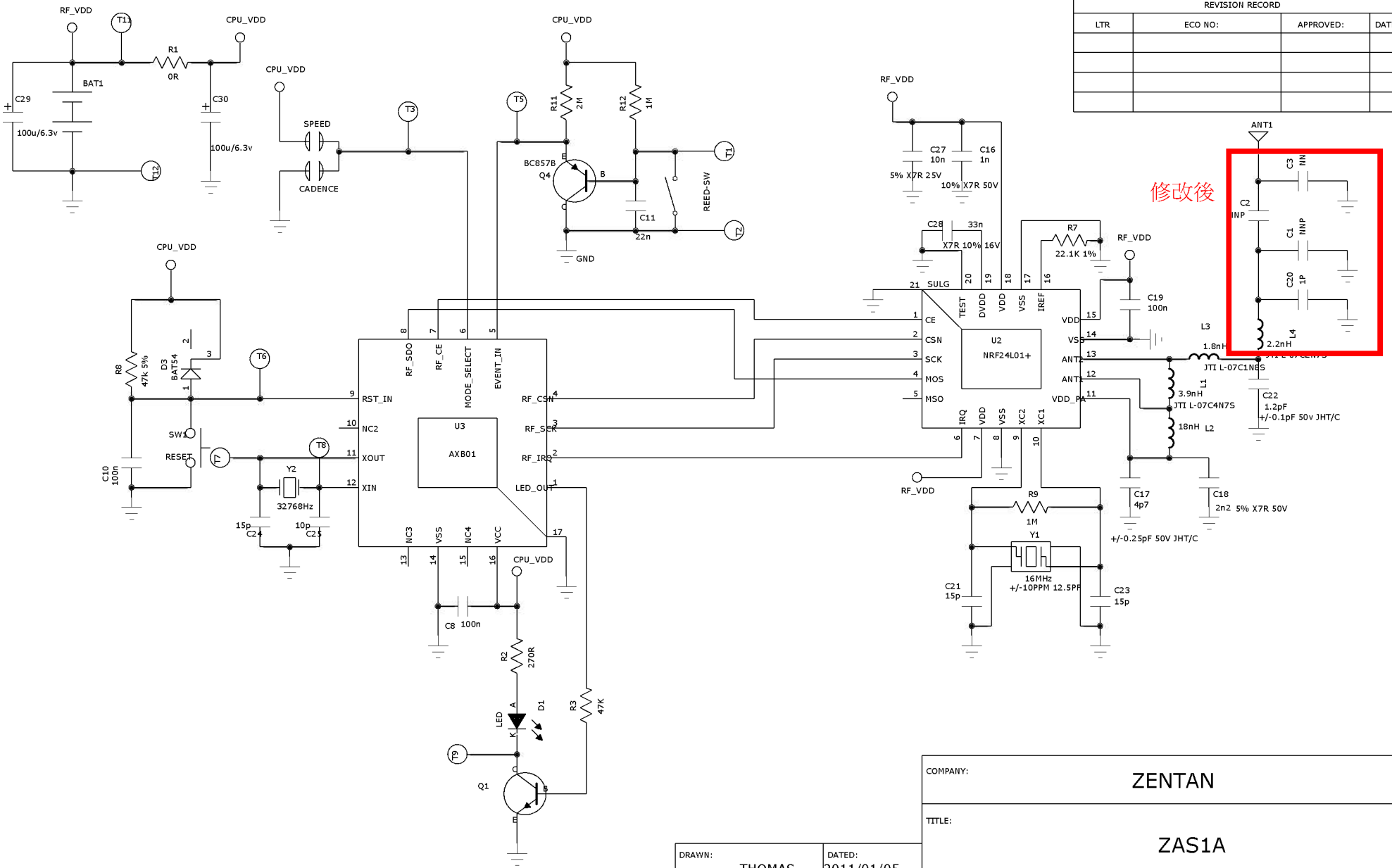

修改後

COMPANY:				ZENTAN			
TITLE:				ZAS1A			
DRAWN:	THOMAS	DATED:	2011/01/05	CODE:	SIZE:	DRAWING NO:	REV:
CHECKED:	<Checked By>	DATED:	<Checked Date>	<Code>	A3	<Drawing Number>	1.2
QUALITY CONTROL:	<QC By>	DATED:	<QC Date>	SCALE: <Scale>		SHEET: 1 of 1	
RELEASED:	<Released By>	DATED:	<Release Date>				

D

C

B

A

D

C

B

A