

# ZT21A+ 01A5

修改後

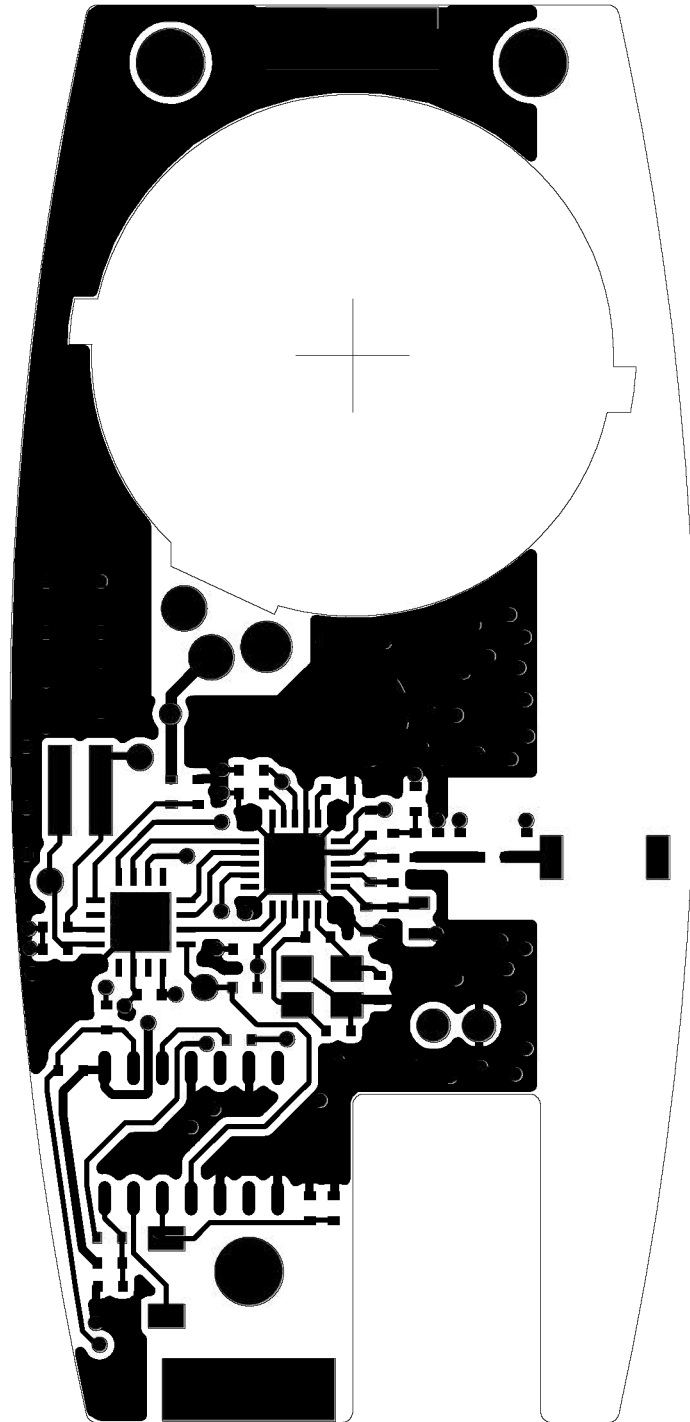

#COMP SIDE

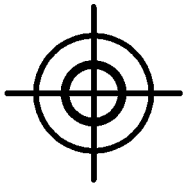

ΣΤΣ1Α+ 01Α2

修改後

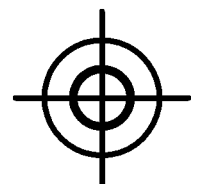
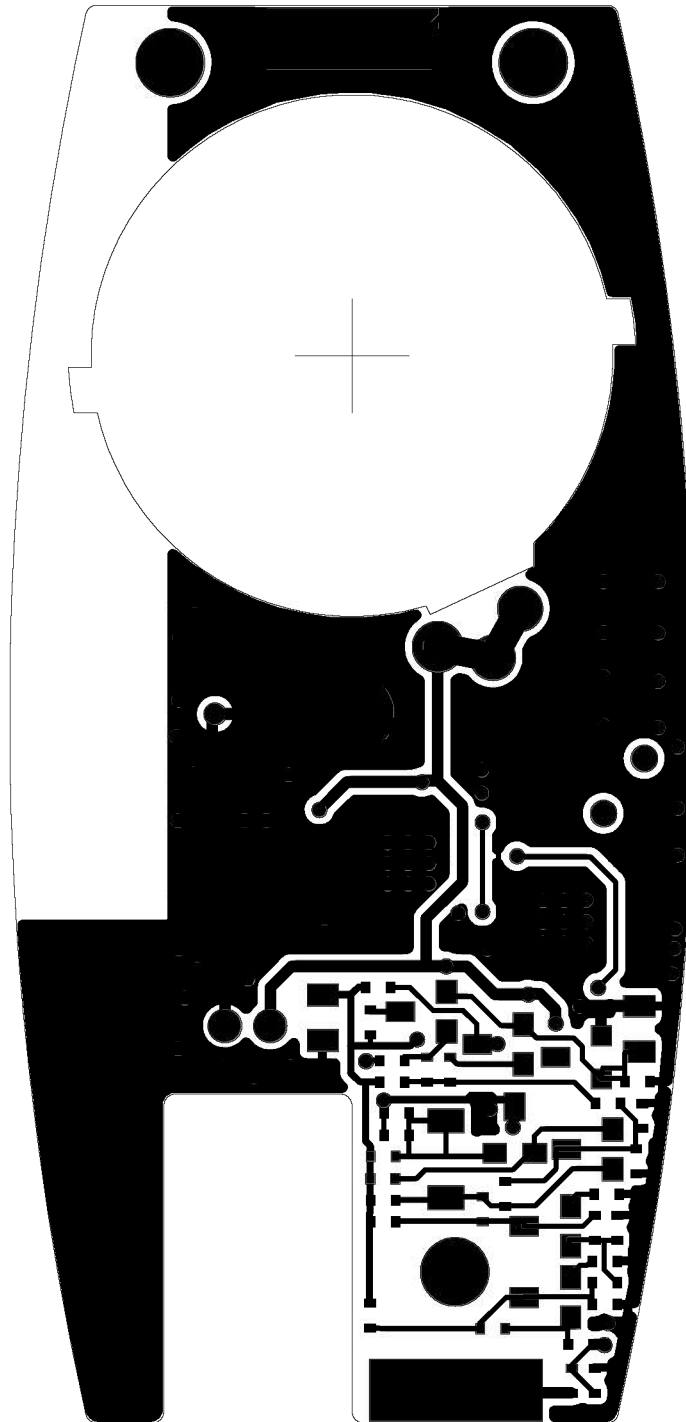
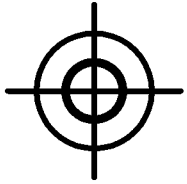

#SOLD SIDE

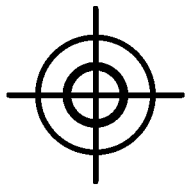

# ΣΤΣ1Α+ 01Α2

修改後

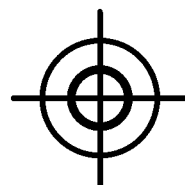
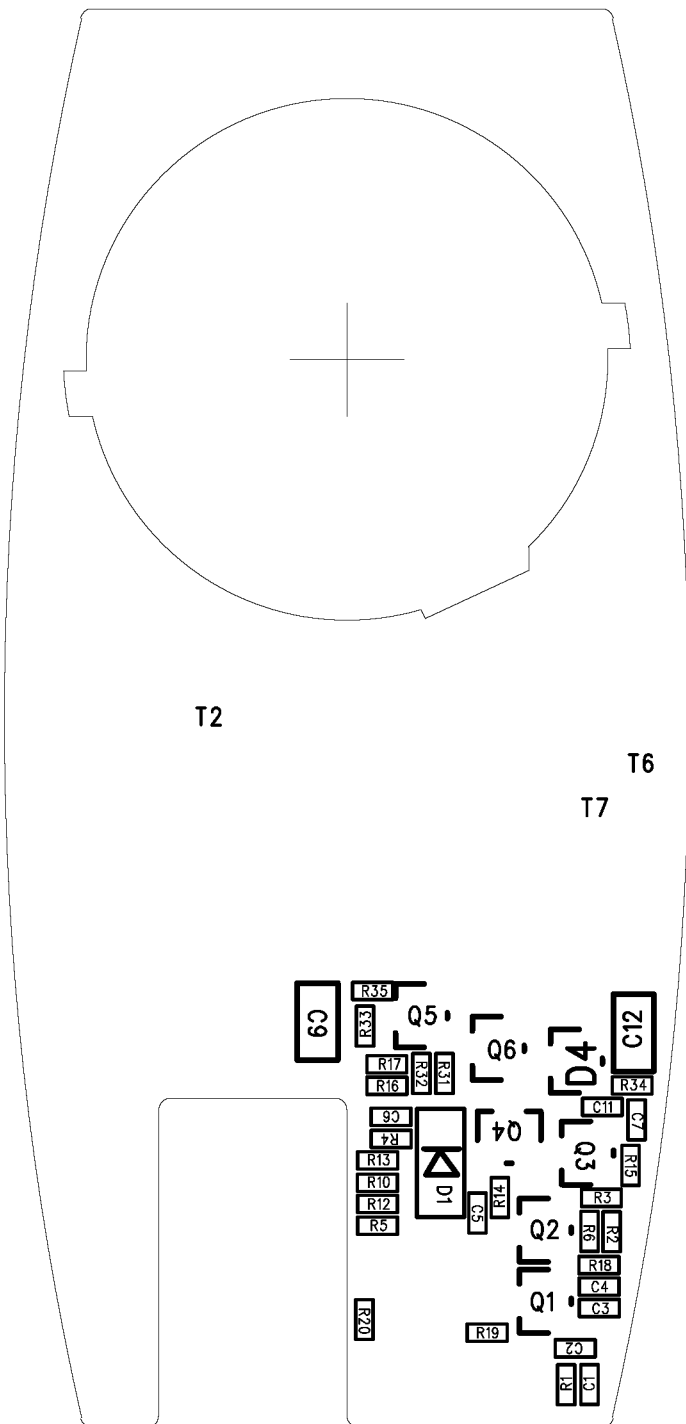
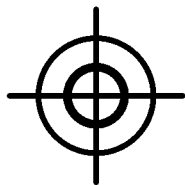

#SOLD SILK

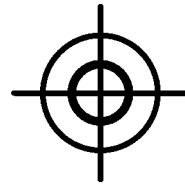

# ZT21A+ 01A5

修改後

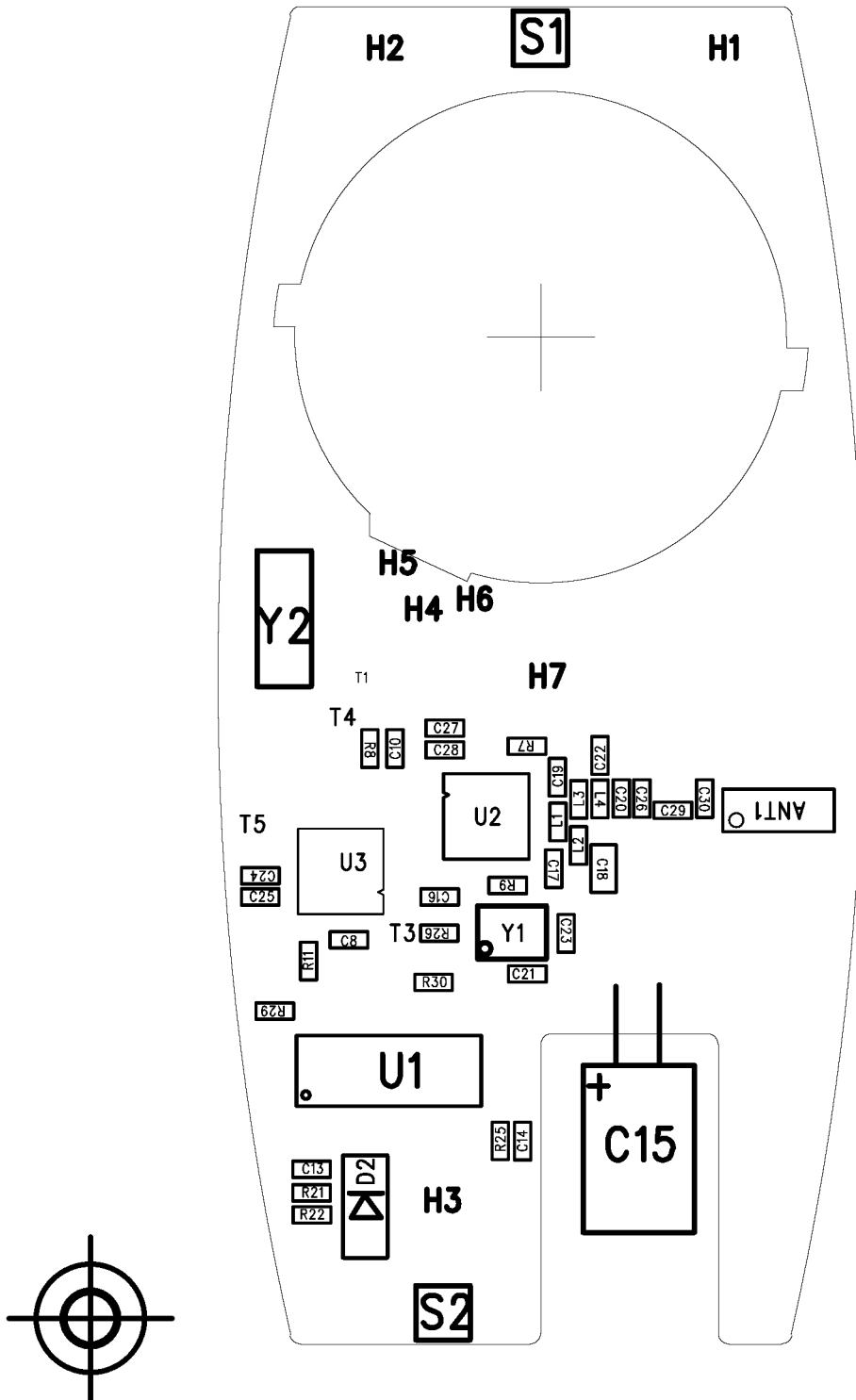
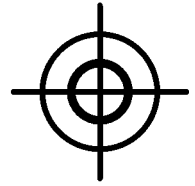

#COMP SILK

6

5

4

3

2

1

REVISION RECORD			
LTR	ECO NO:	APPROVED:	DATE:

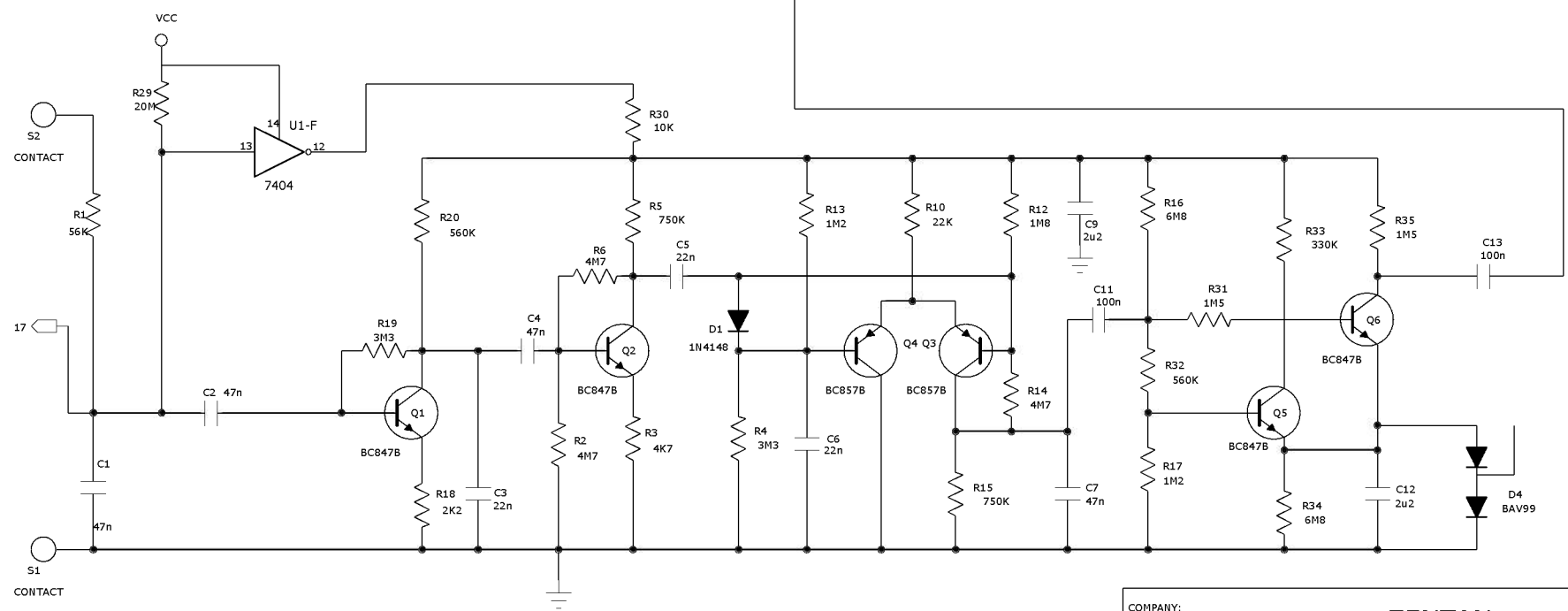
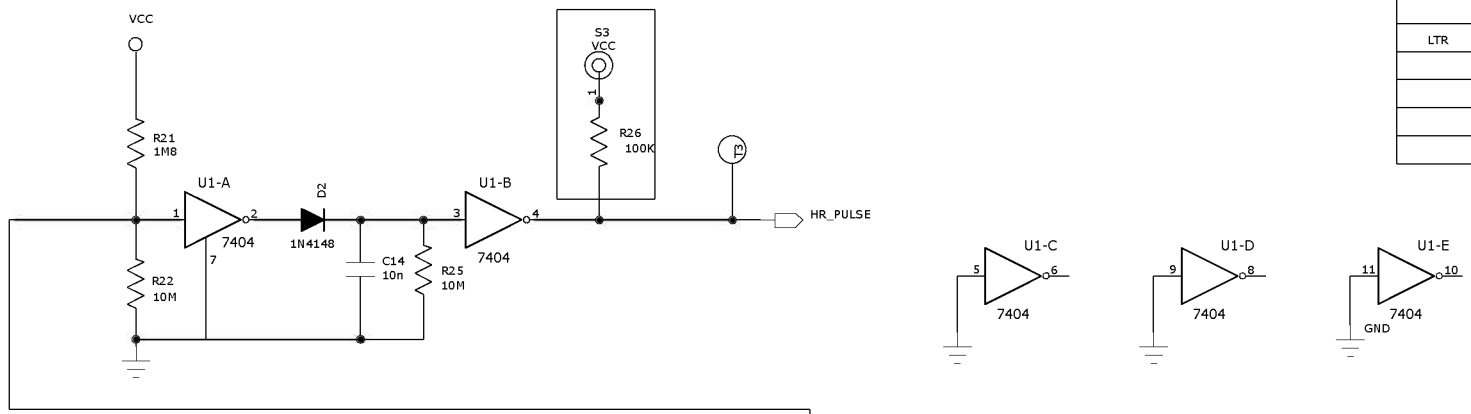

COMPANY:				ZENTAN							
TITLE:				ZT21+							
DRAWN:		DATED:		CODE:		SIZE:		DRAWING NO:		REV:	
BRIGHT		2010/05/19		<Code>		A3		<Drawing Number>		1.2	
CHECKED:		DATED:		QUALITY CONTROL:		DATED:		RELEASED:		DATED:	
<Checked By>		<Checked Date>		<QC By>		<QC Date>		<Released By>		<Release Date>	
SCALE: <Scale>				SHEET: 1 of 2							

D

C

B

A

D

C

B

A

6

5

4

3

2

1

REVISION RECORD			
LTR	ECO NO:	APPROVED:	DATE:

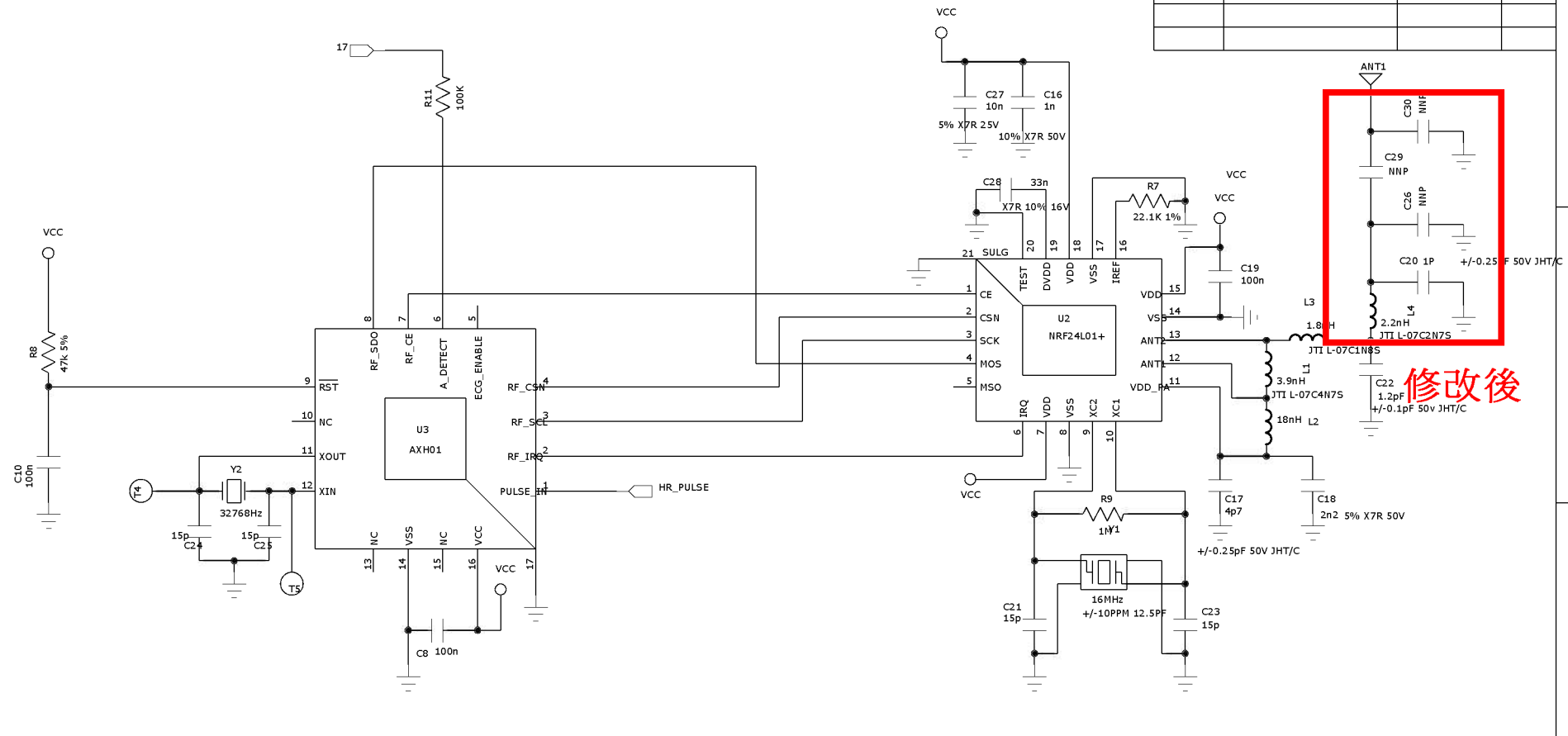

修改後

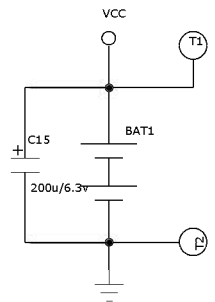

COMPANY:				ZENTAN			
TITLE:				ZT21+			
DRAWN:		DATED:		CODE:		DRAWING NO:	
BRIGHT		2010/03/04		<Code>		<Drawing Number>	
CHECKED:		DATED:		SIZE:		REV:	
<Checked By>		<Checked Date>		A3		1.2	
QUALITY CONTROL:		DATED:		SCALE: <Scale>			
<QC By>		<QC Date>		SHEET: 2 OF 2			
RELEASED:		DATED:					
<Released By>		<Release Date>					

D

C

B

A

D

C

B

A