



FCC TEST REPORT

REPORT NO.: RF920325H02

MODEL NO.: FW-C502

RECEIVED: Mar. 25, 2003

TESTED: Mar. 31 to Apr. 10, 2003

APPLICANT: FullWave Technology Co., Ltd.

ADDRESS: 7F-6,NO.26,TaiYuan St., JuBei City,
HsinChu, Taiwan

ISSUED BY: Advance Data Technology Corporation

LAB LOCATION: No. 81-1, Lu Liao Keng, 9 Ling, Wu Lung Tsuen,
Chiung Lin Hsiang, Hsin Chu Hsien,
Taiwan, R.O.C.

This test report consists of 49 pages in total. It may be duplicated completely for legal use with the approval of the applicant. It should not be reproduced except in full, without the written approval of our laboratory. The client should not use it to claim product endorsement by CNLA, NVLAP or any government agencies. The test results in the report only apply to the tested sample.



Lab Code: 200376-0



Table of Contents

1	CERTIFICATION.....	4
2	SUMMARY OF TEST RESULTS.....	5
3	GENERAL INFORMATION	6
3.1	GENERAL DESCRIPTION OF EUT.....	6
3.2	DESCRIPTION OF TEST MODES.....	7
3.3	GENERAL DESCRIPTION OF APPLIED STANDARDS	7
3.4	DESCRIPTION OF SUPPORT UNITS.....	8
4	TEST TYPES AND RESULTS	9
4.1	CONDUCTED EMISSION MEASUREMENT.....	9
4.1.1	TEST INSTRUMENTS	9
4.1.2	TEST PROCEDURES	10
4.1.3	DEVIATION FROM TEST STANDARD	10
4.1.4	TEST SETUP	11
4.1.5	EUT OPERATING CONDITIONS	12
4.1.6	TEST RESULTS.....	13
4.2	RADIATED EMISSION MEASUREMENT	19
4.2.1	LIMITS OF RADIATED EMISSION MEASUREMENT	19
4.2.2	TEST INSTRUMENTS	20
4.2.3	TEST PROCEDURES	21
4.2.4	DEVIATION FROM TEST STANDARD	21
4.2.5	TEST SETUP	22
4.2.6	EUT OPERATING CONDITIONS	22
4.2.7	TEST RESULTS.....	23
4.3	6dB BANDWIDTH MEASUREMENT	27
4.3.1	LIMITS OF 6dB BANDWIDTH MEASUREMENT	27
4.3.2	TEST INSTRUMENTS	27
4.3.3	TEST PROCEDURE.....	28
4.3.4	DEVIATION FROM TEST STANDARD	28
4.3.5	TEST SETUP	28
4.3.6	EUT OPERATING CONDITIONS	28
4.3.7	TEST RESULTS.....	29
4.4	MAXIMUM PEAK OUTPUT POWER	33
4.4.1	LIMITS OF MAXIMUM PEAK OUTPUT POWER MEASUREMENT	33
4.4.2	INSTRUMENTS.....	33
4.4.3	TEST PROCEDURES	34
4.4.4	DEVIATION FROM TEST STANDARD	34
4.4.5	TEST SETUP	34



4.4.6 EUT OPERATING CONDITIONS 34

4.4.7 TEST RESULTS..... 35

4.4.8 LIMITS OF POWER SPECTRAL DENSITY MEASUREMENT..... 36

4.4.9 TEST INSTRUMENTS 36

4.4.10 TEST PROCEDURE..... 37

4.4.11 DEVIATION FROM TEST STANDARD 37

4.4.12 TEST SETUP 37

4.4.13 EUT OPERATING CONDITION..... 37

4.4.14 TEST RESULTS..... 38

4.5 BAND EDGES MEASUREMENT.....42

4.5.1 LIMITS OF BAND EDGES MEASUREMENT..... 42

4.5.2 TEST INSTRUMENTS 42

4.5.3 TEST PROCEDURE..... 42

4.5.4 DEVIATION FROM TEST STANDARD 42

4.5.5 EUT OPERATING CONDITION..... 43

4.5.6 TEST RESULTS..... 43

4.6 ANTENNA REQUIREMENT.....46

4.6.1 STANDARD APPLICABLE..... 46

4.6.2 ANTENNA CONNECTED CONSTRUCTION..... 46

5 PHOTOGRAPHS OF THE TEST CONFIGURATION.....47

6 INFORMATION ON THE TESTING LABORATORIES.....49



1 CERTIFICATION

PRODUCT : 802.11b Wireless LAN CardBus Adapter
MODEL NO. : FW-C502
BRAND : FullWave
APPLICANT : FullWave Technology Co., Ltd.
STANDARDS : 47 CFR Part 15, Subpart C (Section 15.247),
ANSI C63.4-1992

We, **Advance Data Technology Corporation**, hereby certify that one sample of the designation has been tested in our facility from Mar. 31 to Apr. 10, 2003. The test record, data evaluation and Equipment Under Test (EUT) configurations represented herein are true and accurate accounts of the measurements of the sample's EMC characteristics under the conditions herein specified.

CHECKED BY: Amanda Chu , **DATE:** Apr. 30, 2003
(Amanda Chu)

APPROVED BY: Eric Lin , **DATE:** Apr. 30, 2003
(Eric Lin, Manager)



2 SUMMARY OF TEST RESULTS

The EUT has been tested according to the following specifications:

APPLIED STANDARD: 47 CFR Part 15, Subpart C			
Standard Section	Test Type and Limit	Result	REMARK
15.207	AC Power Conducted Emission	PASS	Meet the requirement of limit Minimum passing margin is -16.22dBuV at 0.21250MHz
15.247(a)(2)	Spectrum Bandwidth of a Direct Sequence Spread Spectrum System Limit: min. 500kHz	PASS	Meet the requirement of limit
15.247(b)	Maximum Peak Output Power Limit: max. 30dBm	PASS	Meet the requirement of limit
15.247(c)	Radiated Emissions Limit: Table 15.209	PASS	Meet the requirement of limit Minimum passing margin is -9.9dBuV at 585.26MHz
15.247(d)	Power Spectral Density Limit: max. 8dBm	PASS	Meet the requirement of limit
15.247(c)	Band Edge Measurement Limit: 20dB less than the peak value of fundamental frequency	PASS	Meet the requirement of limit



3 GENERAL INFORMATION

3.1 GENERAL DESCRIPTION OF EUT

PRODUCT	802.11b Wireless LAN CardBus Adapter
MODEL NO.	FW-C502
POWER SUPPLY	3.3VDC from host equipment
MODULATION TYPE	DBPSK for 1Mbps DQPSK for 2Mbps CCK for 5.5/11Mbps
RADIO TECHNOLOGY	DSSS
TRANSFER RATE	1/2/5.5/11Mbps
FREQUENCY RANGE	2412MHz ~ 2462MHz
NUMBER OF CHANNEL	11
OUTPUT POWER	10.93dBm
DATA CABLE	NA
ANTENNA TYPE	PIFA Antenna
I/O PORTS	NA
ASSOCIATED DEVICES	NA

NOTE:

1. For more detailed features description, please refer to the manufacturer's specifications or User's Manual.



3.2 DESCRIPTION OF TEST MODES

Eleven channels are provided to this EUT.

Channel	Frequency	Channel	Frequency
1	2412 MHz	7	2442 MHz
2	2417 MHz	8	2447 MHz
3	2422 MHz	9	2452 MHz
4	2427 MHz	10	2457 MHz
5	2432 MHz	11	2462 MHz
6	2437 MHz		

NOTE:

1. Below 1 GHz, the channel 1, 6, and 11 were pre-tested in chamber. The channel 11, worst case one, was chosen for final test.
2. Above 1 GHz, the channel 1, 6, and 11 were tested individually.

3.3 GENERAL DESCRIPTION OF APPLIED STANDARDS

The EUT is a 802.11b Wireless LAN CardBus Adapter. According to the specifications of the manufacturer, it must comply with the requirements of the following standards:

FCC CFR 47 Part 15, Subpart C. (15.247)

ANSI C63.4 : 1992

All tests have been performed and recorded as per the above standards.

NOTE: The EUT is also considered as a kind of computer peripheral, because the connection to computer is necessary for typical use. It has been verified to comply with the requirements of FCC Part 15, Subpart B, Class B (DoC). The test report has been issued separately.



3.4 DESCRIPTION OF SUPPORT UNITS

The EUT has been tested as an independent unit together with other necessary accessories or support units. The following support units or accessories were used to form a representative test configuration during the tests.

No.	Product	Brand	Model No.	Serial No.	FCC ID
1	NOTEBOOK COMPUTER	Compaq	N800C	470048-515	FCC DoC
2	PRINTER	HP	C2642A	MY7961C1FQ	B94C2642X

No.	Signal cable description
1	NA
2	1.8 m braid shielded wire, terminated with DB25 and Centronics connector via metallic frame, w/o core.

Note: 1. All power cords of the above support units are unshielded (1.8m).

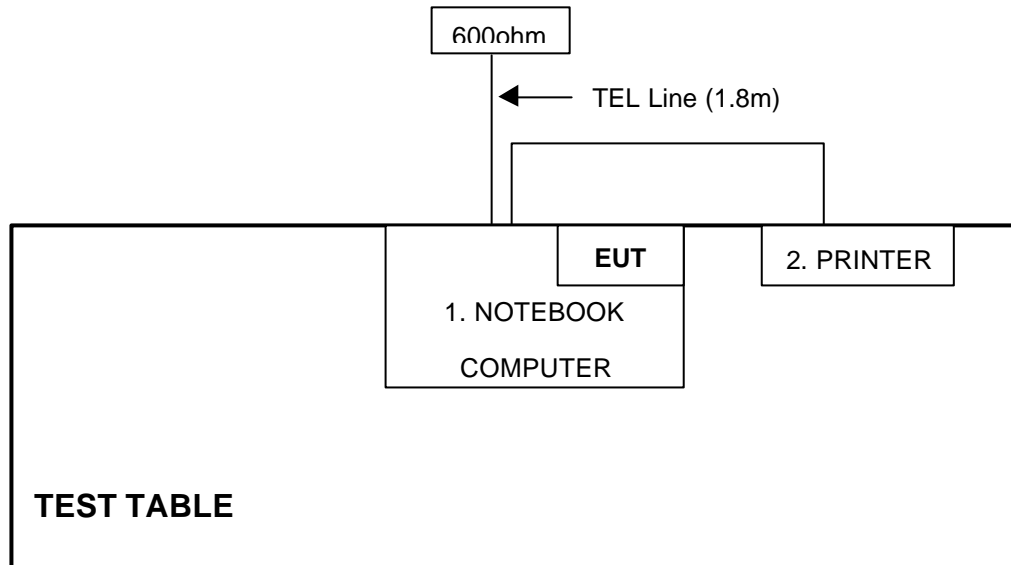

NOTE: 1. Please refer to the photos of test configuration in Item 5 also.



4 TEST TYPES AND RESULTS

4.1 CONDUCTED EMISSION MEASUREMENT

FREQUENCY OF EMISSION (MHz)	CONDUCTED LIMIT (dB μ V)	
	Quasi-peak	Average
0.15-0.5	66 to 56	56 to 46
0.5-5	56	46
5-30	60	50

- NOTE:**
1. The lower limit shall apply at the transition frequencies.
 2. The limit decreases in line with the logarithm of the frequency in the range of 0.15 to 0.50 MHz.
 3. All emanations from a class A/B digital device or system, including any network of conductors and apparatus connected thereto, shall not exceed the level of field strengths specified above.

4.1.1 TEST INSTRUMENTS

DESCRIPTION & MANUFACTURER	MODEL NO.	SERIAL NO.	CALIBRATED UNTIL
ROHDE & SCHWARZ Test Receiver	ESCS 30	847124/029	Nov. 17, 2003
ROHDE & SCHWARZ LISN (for EUT)	ESHS-Z5	848773/004	Nov. 13, 2003
KYORITSU LISN (for peripheral)	KNW-407	8/1395/12	Jul. 23, 2003
RF Cable (JETBAO)	RG233/U	Cable_CA_01	Jul. 03, 2003
Terminator(for KYORITSU)	50	3	Apr. 11, 2004
Software	Cond-V2e	NA	NA

- NOTE:**
1. The calibration interval of the above test instruments is 12 months and the calibrations are traceable to NML/ROC and NIST/USA.
 2. The test was performed in ADT Shielded Room No. A.
 3. The VCCI Con A Registration No. is C-817.



4.1.2 TEST PROCEDURES

- a. The EUT was placed 0.4 meters from the conducting wall of the shielded room with EUT being connected to the power mains through a line impedance stabilization network (LISN). Other support units were connected to the power mains through another LISN. The two LISNs provide 50 ohm/ 50uH of coupling impedance for the measuring instrument.
- b. Both lines of the power mains connected to the EUT were checked for maximum conducted interference.
- c. The frequency range from 150 kHz to 30 MHz was searched. Emission levels over 10dB under the prescribed limits could not be reported

4.1.3 DEVIATION FROM TEST STANDARD

No deviation

4.1.4 TEST SETUP

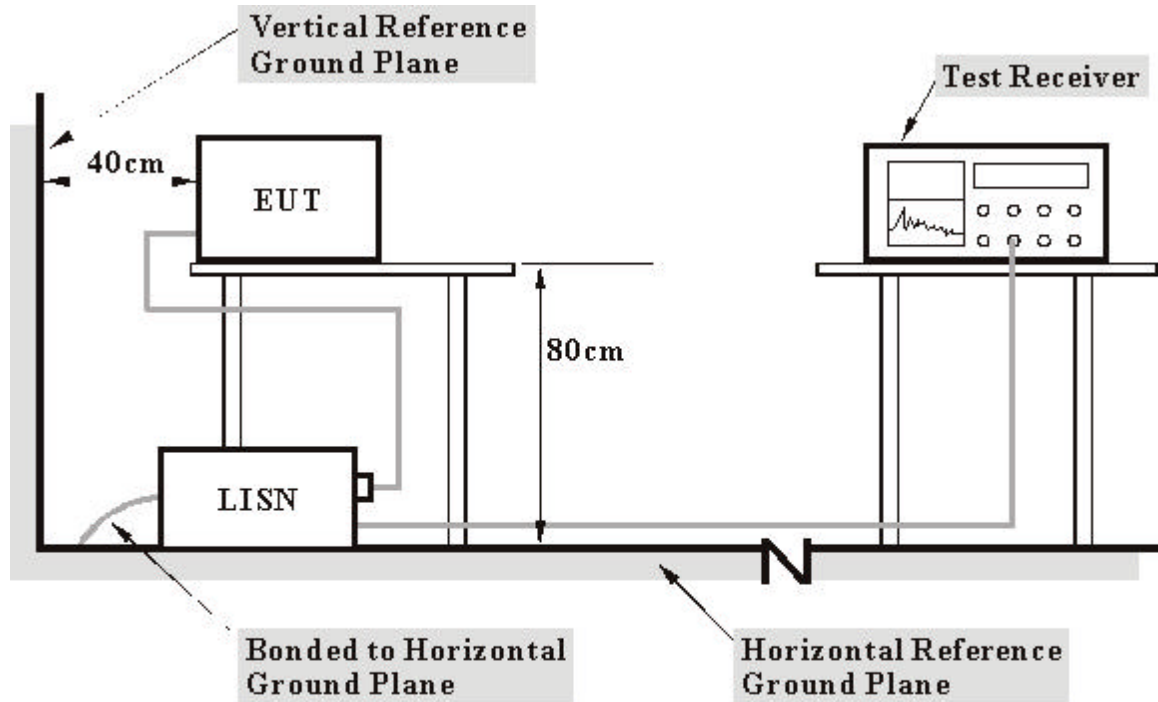

- Note:**
1. Support units were connected to second LISN.
 2. Both of LISNs (AMN) 80 cm from EUT and at the least 80 cm from other units and other metal planes support units.

For the actual test configuration, please refer to the related item – Photographs of the Test Configuration.



4.1.5 EUT OPERATING CONDITIONS

- a. Plug the EUT into the support unit 1 (Notebook computer) which placed on a testing table.
- b. The support unit 1 (Notebook computer) ran a test program to enable EUT under transmission condition continuously at specific channel frequency.



4.1.6 TEST RESULTS

EUT	802.11b Wireless LAN CardBus Adapter	MODEL	FW-C502
MODE	Channel 1	6dB BANDWIDTH	9 kHz
INPUT POWER (SYSTEM)	120Vac, 60Hz	PHASE	Line (L)
ENVIRONMENTAL CONDITIONS	25 deg. C, 70%RH, 974 hPa	TESTED BY	Tony Chen

No	Freq. [MHz]	Corr. Factor (dB)	Reading Value [dB (uV)]		Emission Level [dB (uV)]		Limit [dB (uV)]		Margin (dB)	
			Q.P.	AV.	Q.P.	AV.	Q.P.	AV.	Q.P.	AV.
1	0.209	0.10	45.83	-	45.93	-	63.26	53.26	-17.33	-
2	0.326	0.10	34.60	-	34.70	-	59.56	49.56	-24.86	-
3	0.431	0.10	31.78	-	31.88	-	57.23	47.23	-25.35	-
4	0.638	0.10	31.59	-	31.69	-	56.00	46.00	-24.31	-
5	4.555	0.27	30.14	-	30.41	-	56.00	46.00	-25.59	-
6	14.414	0.78	33.06	-	33.84	-	60.00	50.00	-26.16	-

- NOTES: (1) "": Undetectable
 (2) Q.P. and AV. are abbreviations of quasi-peak and average.
 (3) "-": The Quasi-peak reading value also meets an average limit, thus measurement with the average detector is unnecessary.
 (4) The emission levels of other frequencies were very low against the limit.
 (5) Correction Factor = Insertion loss + Cable loss
 (6) Margin value = Emission level - Limit value

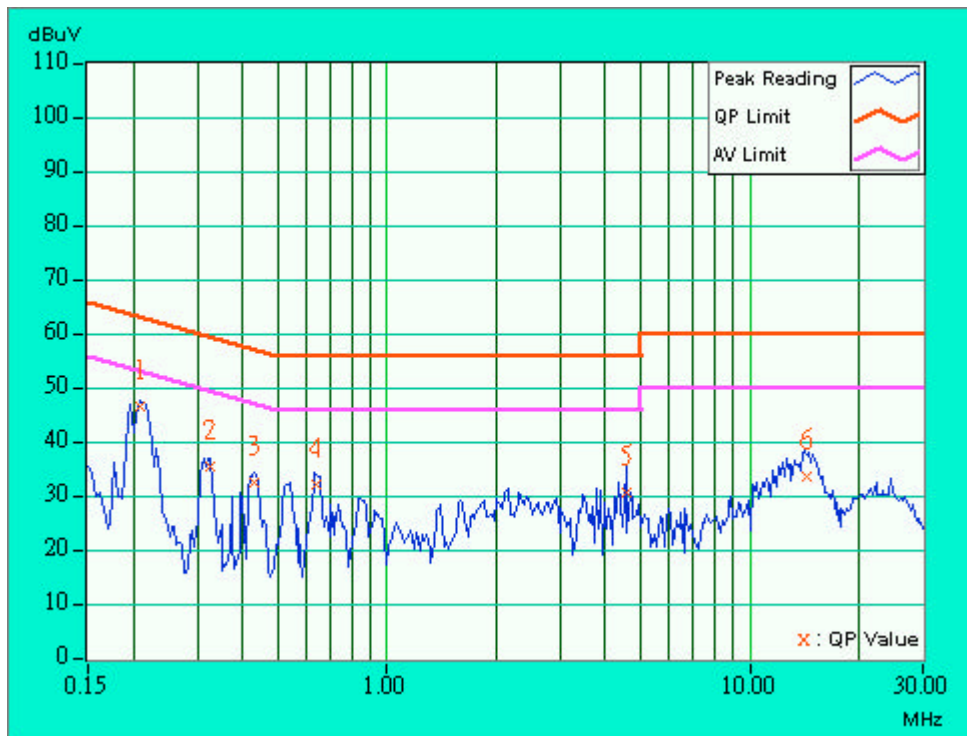



EUT	802.11b Wireless LAN CardBus Adapter	MODEL	FW-C502
MODE	Channel 1	6dB BANDWIDTH	9 kHz
INPUT POWER (SYSTEM)	120Vac, 60Hz	PHASE	Neutral (N)
ENVIRONMENTAL CONDITIONS	25 deg. C, 70%RH, 974 hPa	TESTED BY	Tony Chen

No	Freq. [MHz]	Corr. Factor (dB)	Reading Value [dB (uV)]		Emission Level [dB (uV)]		Limit [dB (uV)]		Margin (dB)	
			Q.P.	AV.	Q.P.	AV.	Q.P.	AV.	Q.P.	AV.
1	0.205	0.10	40.91	-	41.01	-	63.42	53.42	-22.41	-
2	0.322	0.10	36.40	-	36.50	-	59.66	49.66	-23.16	-
3	0.439	0.10	31.40	-	31.50	-	57.08	47.08	-25.58	-
4	0.548	0.10	32.49	-	32.59	-	56.00	46.00	-23.41	-
5	3.930	0.20	23.76	-	23.96	-	56.00	46.00	-32.04	-
6	14.617	0.59	31.78	-	32.37	-	60.00	50.00	-27.63	-

- NOTES: (1) "": Undetectable
 (2) Q.P. and AV. are abbreviations of quasi-peak and average.
 (3) "-": The Quasi-peak reading value also meets an average limit, thus measurement with the average detector is unnecessary.
 (4) The emission levels of other frequencies were very low against the limit.
 (5) Correction Factor = Insertion loss + Cable loss
 (6) Margin value = Emission level - Limit value

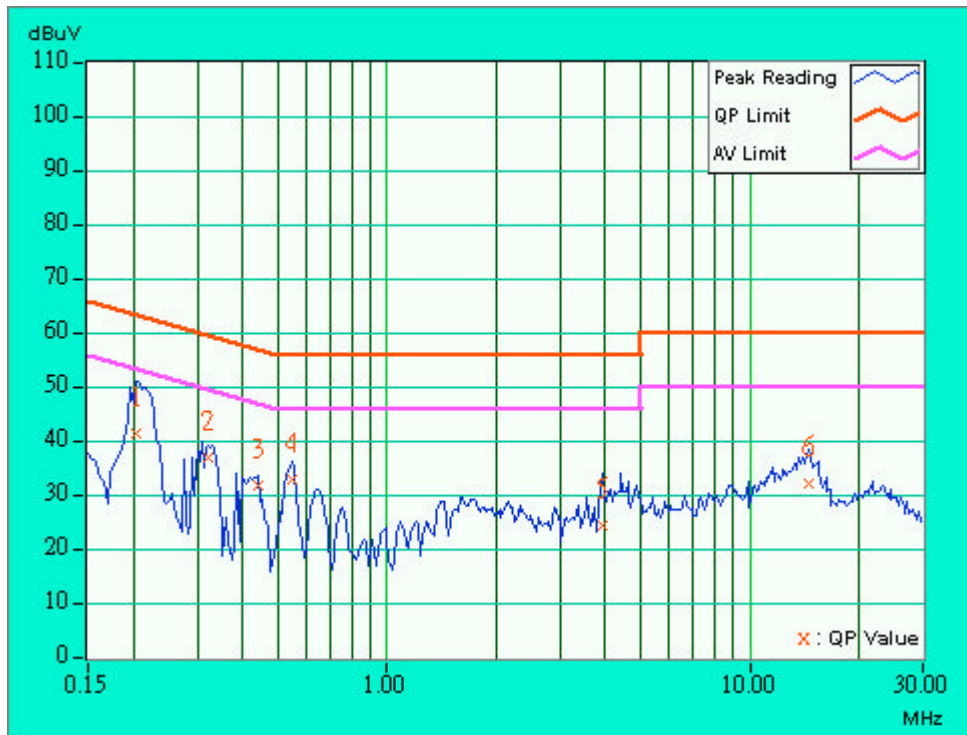



EUT	802.11b Wireless LAN CardBus Adapter	MODEL	FW-C502
MODE	Channel 6	6dB BANDWIDTH	9 kHz
INPUT POWER (SYSTEM)	120Vac, 60Hz	PHASE	Line (L)
ENVIRONMENTAL CONDITIONS	25 deg. C, 70%RH, 974 hPa	TESTED BY	Tony Chen

No	Freq. [MHz]	Corr. Factor (dB)	Reading Value [dB (uV)]		Emission Level [dB (uV)]		Limit [dB (uV)]		Margin (dB)	
			Q.P.	AV.	Q.P.	AV.	Q.P.	AV.	Q.P.	AV.
1	0.181	0.10	28.72	-	28.82	-	64.43	54.43	-35.61	-
2	0.211	0.10	45.62	-	45.72	-	63.18	53.18	-17.46	-
3	0.318	0.10	34.13	-	34.23	-	59.76	49.76	-25.53	-
4	0.434	0.10	32.42	-	32.52	-	57.18	47.18	-24.66	-
5	0.634	0.10	31.01	-	31.11	-	56.00	46.00	-24.89	-
6	14.275	0.77	33.04	-	33.81	-	60.00	50.00	-26.19	-

- NOTES: (1) "": Undetectable
 (2) Q.P. and AV. are abbreviations of quasi-peak and average.
 (3) "-": The Quasi-peak reading value also meets an average limit, thus measurement with the average detector is unnecessary.
 (4) The emission levels of other frequencies were very low against the limit.
 (5) Correction Factor = Insertion loss + Cable loss
 (6) Margin value = Emission level - Limit value

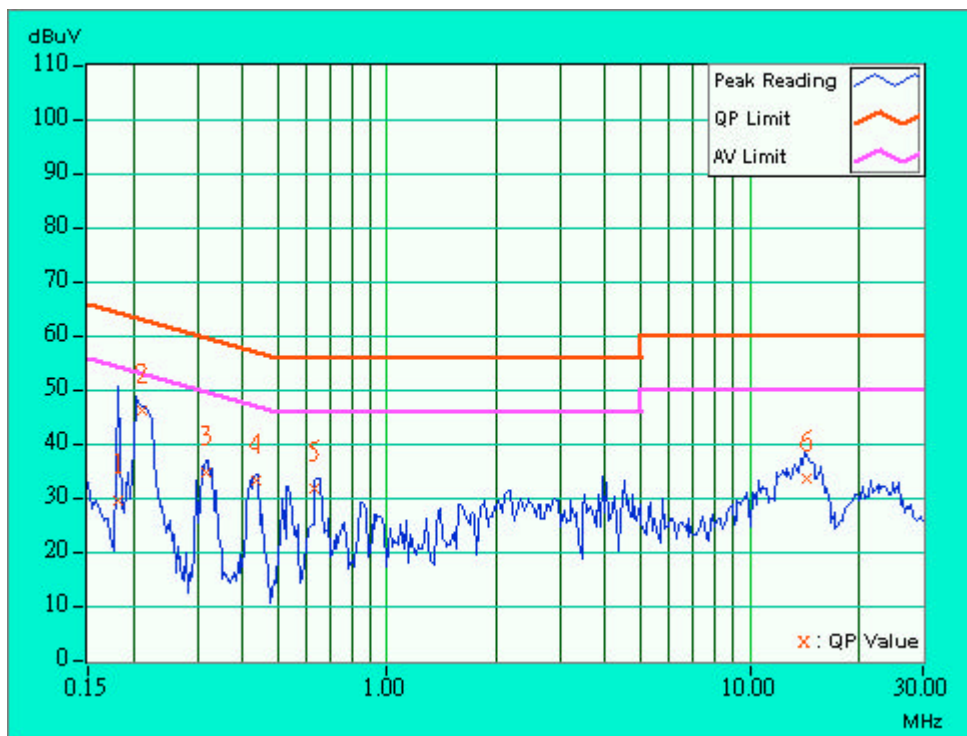



EUT	802.11b Wireless LAN CardBus Adapter	MODEL	FW-C502
MODE	Channel 6	6dB BANDWIDTH	9 kHz
INPUT POWER (SYSTEM)	120Vac, 60Hz	PHASE	Neutral (N)
ENVIRONMENTAL CONDITIONS	25 deg. C, 70%RH, 974 hPa	TESTED BY	Tony Chen

No	Freq. [MHz]	Corr. Factor (dB)	Reading Value [dB (uV)]		Emission Level [dB (uV)]		Limit [dB (uV)]		Margin (dB)	
			Q.P.	AV.	Q.P.	AV.	Q.P.	AV.	Q.P.	AV.
1	0.209	0.10	44.16	-	44.26	-	63.26	53.26	-19.00	-
2	0.326	0.10	36.90	-	37.00	-	59.56	49.56	-22.56	-
3	0.439	0.10	31.46	-	31.56	-	57.08	47.08	-25.52	-
4	0.541	0.10	32.60	-	32.70	-	56.00	46.00	-23.30	-
5	4.684	0.28	27.44	-	27.72	-	56.00	46.00	-28.28	-
6	14.957	0.60	31.67	-	32.27	-	60.00	50.00	-27.73	-

- NOTES: (1) "": Undetectable
 (2) Q.P. and AV. are abbreviations of quasi-peak and average.
 (3) "-": The Quasi-peak reading value also meets an average limit, thus measurement with the average detector is unnecessary.
 (4) The emission levels of other frequencies were very low against the limit.
 (5) Correction Factor = Insertion loss + Cable loss
 (6) Margin value = Emission level - Limit value

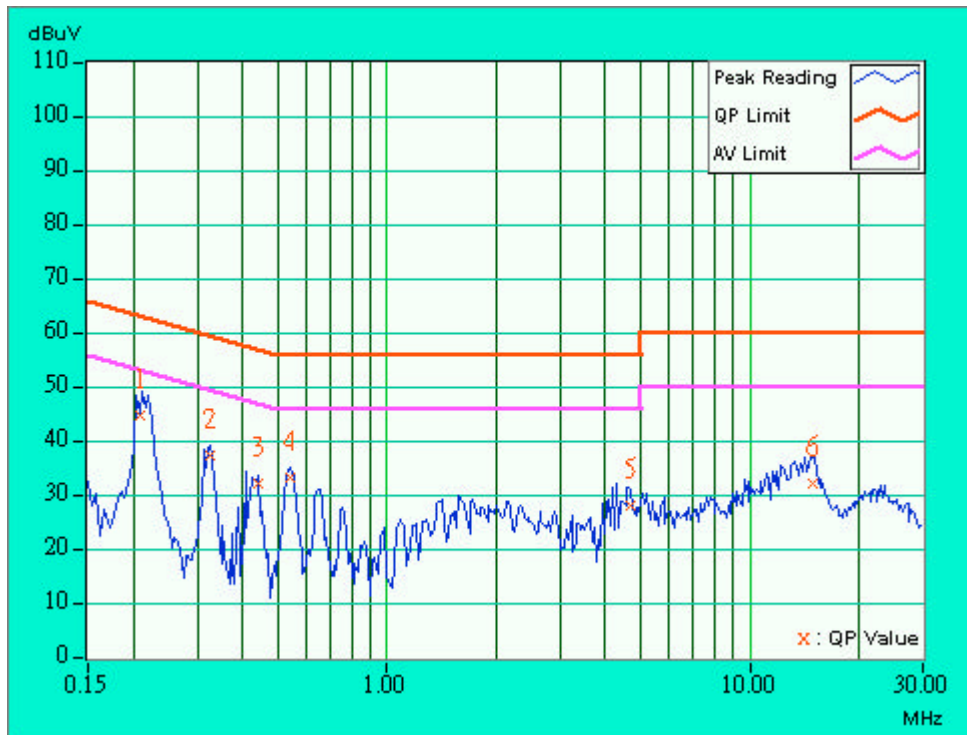



EUT	802.11b Wireless LAN CardBus Adapter	MODEL	FW-C502
MODE	Channel 11	6dB BANDWIDTH	9 kHz
INPUT POWER (SYSTEM)	120Vac, 60Hz	PHASE	Line (L)
ENVIRONMENTAL CONDITIONS	25 deg. C, 70%RH, 974 hPa	TESTED BY	Tony Chen

No	Freq. [MHz]	Corr. Factor (dB)	Reading Value [dB (uV)]		Emission Level [dB (uV)]		Limit [dB (uV)]		Margin (dB)	
			Q.P.	AV.	Q.P.	AV.	Q.P.	AV.	Q.P.	AV.
1	0.209	0.10	45.58	-	45.68	-	63.26	53.26	-17.58	-
2	0.326	0.10	34.40	-	34.50	-	59.56	49.56	-25.06	-
3	0.435	0.10	32.24	-	32.34	-	57.15	47.15	-24.81	-
4	0.642	0.10	31.55	-	31.65	-	56.00	46.00	-24.35	-
5	4.195	0.23	26.18	-	26.41	-	56.00	46.00	-29.59	-
6	15.848	0.83	29.57	-	30.40	-	60.00	50.00	-29.60	-

- NOTES: (1) "***": Undetectable
 (2) Q.P. and AV. are abbreviations of quasi-peak and average.
 (3) "-": The Quasi-peak reading value also meets an average limit, thus measurement with the average detector is unnecessary.
 (4) The emission levels of other frequencies were very low against the limit.
 (5) Correction Factor = Insertion loss + Cable loss
 (6) Margin value = Emission level - Limit value

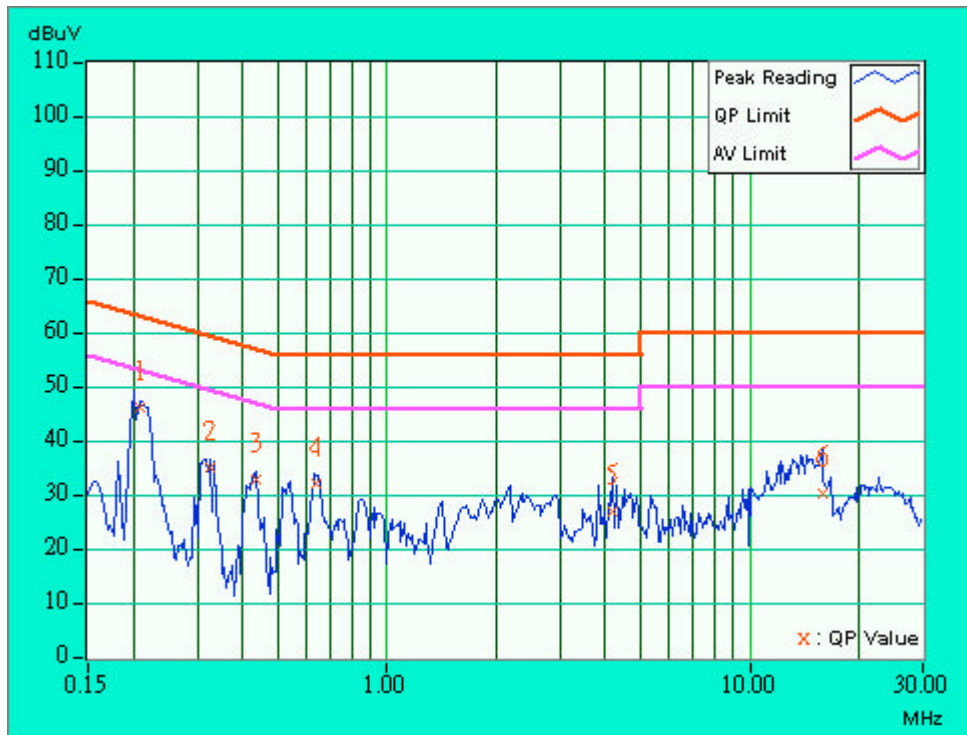



EUT	802.11b Wireless LAN CardBus Adapter	MODEL	FW-C502
MODE	Channel 11	6dB BANDWIDTH	9 kHz
INPUT POWER (SYSTEM)	120Vac, 60Hz	PHASE	Neutral (N)
ENVIRONMENTAL CONDITIONS	25 deg. C, 70%RH, 974 hPa	TESTED BY	Tony Chen

No	Freq. [MHz]	Corr. Factor (dB)	Reading Value [dB (uV)]		Emission Level [dB (uV)]		Limit [dB (uV)]		Margin (dB)	
			Q.P.	AV.	Q.P.	AV.	Q.P.	AV.	Q.P.	AV.
1	0.213	0.10	46.79	-	46.89	-	63.11	53.11	-16.22	-
2	0.326	0.10	36.24	-	36.34	-	59.56	49.56	-23.22	-
3	0.435	0.10	31.40	-	31.50	-	57.15	47.15	-25.65	-
4	0.545	0.10	32.31	-	32.41	-	56.00	46.00	-23.59	-
5	4.398	0.25	30.96	-	31.21	-	56.00	46.00	-24.79	-
6	14.688	0.59	32.28	-	32.87	-	60.00	50.00	-27.13	-

- NOTES: (1) "": Undetectable
 (2) Q.P. and AV. are abbreviations of quasi-peak and average.
 (3) "-": The Quasi-peak reading value also meets an average limit, thus measurement with the average detector is unnecessary.
 (4) The emission levels of other frequencies were very low against the limit.
 (5) Correction Factor = Insertion loss + Cable loss
 (6) Margin value = Emission level - Limit value

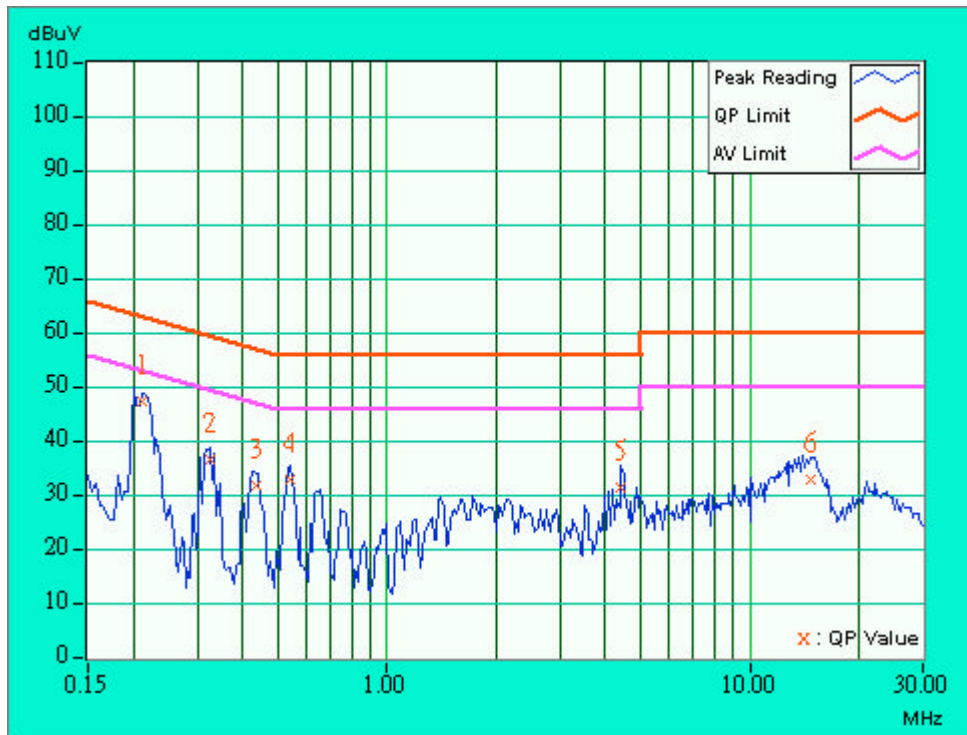



4.2 RADIATED EMISSION MEASUREMENT

4.2.1 LIMITS OF RADIATED EMISSION MEASUREMENT

Field strength limits are at the distance of 3 meters, emissions radiated outside of the specified bands, shall be according to the general radiated limits in 15.209 as following:

Frequencies (MHz)	Field Strength of Fundamental	
	uV/m	dBuV/m
30-88	100	40.0
88-216	150	43.5
216-960	200	46.0
Above 960	500	54.0

NOTE:

1. The lower limit shall apply at the transition frequencies.
2. Emission level (dBuV/m) = 20 log Emission level (uV/m).
3. As shown in 15.35(b), for frequencies above 1000MHz, the field strength limits are based on average detector, however, the peak field strength of any emission shall not exceed the maximum permitted average limits, specified above by more than 20dB under any condition of modulation.



4.2.2 TEST INSTRUMENTS

DESCRIPTION & MANUFACTURER	MODEL NO.	SERIAL NO.	CALIBRATED UNTIL
HP Spectrum Analyzer	8594ER	3829U04676	Jul. 14, 2003
ADVANTEST Spectrum Analyzer	R3271A	85060311	May 21, 2003
CHASE RF Pre_Amplifier	CPA9232	1057	Apr. 24, 2003
HP Pre_Amplifier	8449B	3008A01281	June 27, 2004
ROHDE & SCHWARZ Test Receiver	ESVS 10	849231 /019	Nov. 03, 2003
CHASE Broadband Antenna	CBL6111c	2730	Jul 17, 2003
Schwarzbeck Horn_Antenna	BBHA9120-D1	D123	Jul. 31, 2003
SCHWARZBECK Tunable Dipole Antenna	UHAP	897	Mar. 07, 2005
SCHWARZBECK Tunable Dipole Antenna	VHAP	880	Mar. 07, 2005
RF Switches (ARNITSU)	CS-201	1565157	Jul. 29, 2003
RF CABLE (Chaintek) 1GHz-20GHz	Ak 9515-D	001	Aug, 20.2003
RF Cable(RICHTEC)	9913-30M	STCCAB-30M- 1GHz-021	Nov. 5, 2003
Software	AS60P8	NA	NA
CHANCE MOST Antenna Tower	AT-100	0203	NA
CHANCE MOST Turn Table	TT-100	0203	NA

Note: 1. The calibration interval of the above test instruments is 12 months (36 months for Tunable Dipole Antenna) and the calibrations are traceable to NML/ROC and NIST/USA.

2. * = These equipment are used for the final measurement.
3. The horn antenna and HP preamplifier (model: 8449B) are used only for the measurement of emission frequency above 1GHz if tested.
4. The test was performed in ADT Open Site No. C.
5. The FCC Site Registration No. is 656396.
6. The VCCI Site Registration No. is R-1626.



4.2.3 TEST PROCEDURES

- a. The EUT was placed on the top of a rotating table 0.8 meters above the ground at a 10 meter open area test site. The table was rotated 360 degrees to determine the position of the highest radiation.
- b. The EUT was set 3 meters away from the interference-receiving antenna, which was mounted on the top of a variable-height antenna tower.
- c. The antenna is a broadband antenna, and its height is varied from one meter to four meters above the ground to determine the maximum value of the field strength. Both horizontal and vertical polarizations of the antenna are set to make the measurement.
- d. For each suspected emission, the EUT was arranged to its worst case and then the antenna was tuned to heights from 1 meter to 4 meters and the rotatable table was turned from 0 degrees to 360 degrees to find the maximum reading.
- e. The test-receiver system was set to Peak Detect Function and Specified Bandwidth with Maximum Hold Mode.
- f. If the emission level of the EUT in peak mode was 10 dB lower than the limit specified, then testing could be stopped and the peak values of the EUT would be reported. Otherwise the emissions that did not have 10 dB margin would be re-tested one by one using the quasi-peak method or average method as specified and then reported in Data sheet peak mode and QP mode.

NOTE:

1. The resolution bandwidth and video bandwidth of test receiver/spectrum analyzer is 120kHz for Quasi-peak detection at frequency below 1GHz.
2. The resolution bandwidth and video bandwidth of test receiver/spectrum analyzer is 1 MHz for Peak detection (PK) at frequency above 1GHz.
3. The resolution bandwidth of test receiver/spectrum analyzer is 1 MHz and the video bandwidth is 300 Hz for Average detection (AV) at frequency above 1GHz.

4.2.4 DEVIATION FROM TEST STANDARD

No deviation

4.2.5 TEST SETUP

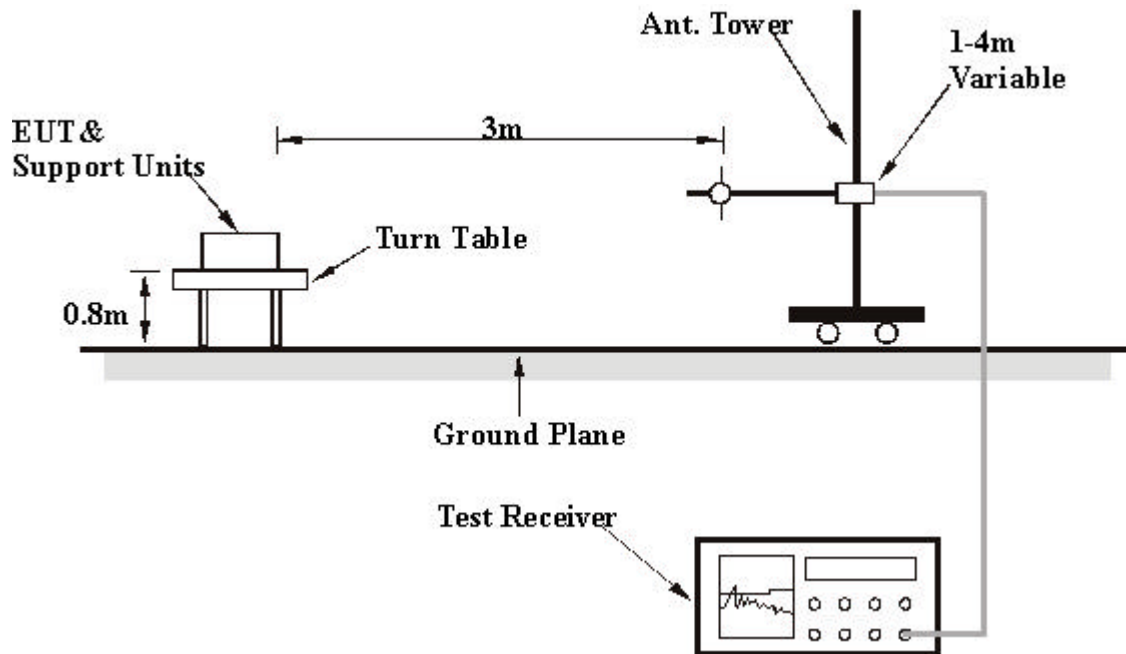

For the actual test configuration, please refer to the related item – Photographs of the Test Configuration.

4.2.6 EUT OPERATING CONDITIONS

Same as 4.1.6



4.2.7 TEST RESULTS

EUT	802.11b Wireless LAN CardBus Adapter	MODEL	FW-C502
MODE	Channel 11	FREQUENCY RANGE	30-1000 MHz
INPUT POWER (SYSTEM)	120Vac, 60Hz	DETECTOR FUNCTION	Quasi-Peak
ENVIRONMENTAL CONDITIONS	20 deg. C, 64%RH, , 974 hPa	TESTED BY	Tony Chen

ANTENNA POLARITY & TEST DISTANCE: HORIZONTAL AT 3 M

No.	Freq. (MHz)	Emission Level (dBuV/m)	Limit (dBuV/m)	Margin (dB)	Antenna Height (m)	Table Angle (Degree)	Raw Value (dBuV)	Correction Factor (dB/m)
1	125.00	19.7 QP	43.50	-23.80	1.09 H	137	7.60	12.10
2	250.00	25.0 QP	46.00	-21.00	1.17 H	49	11.80	13.20
3	264.00	22.2 QP	46.00	-23.80	1.37 H	180	8.10	14.10
4	308.01	22.4 QP	46.00	-23.60	1.82 H	255	8.10	14.30
5	352.01	23.8 QP	46.00	-22.20	1.40 H	208	8.20	15.60
6	440.02	26.9 QP	46.00	-19.10	1.21 H	219	8.80	18.00
7	480.02	28.1 QP	46.00	-17.90	1.07 H	0	9.10	18.90
8	550.00	30.3 QP	46.00	-15.70	1.07 H	87	8.40	21.90
9	584.63	29.7 QP	46.00	-16.30	1.25 H	164	8.50	21.20
10	828.02	33.8 QP	46.00	-12.20	1.00 H	249	9.40	24.40

ANTENNA POLARITY & TEST DISTANCE: VERTICAL AT 3 M

No.	Freq. (MHz)	Emission Level (dBuV/m)	Limit (dBuV/m)	Margin (dB)	Antenna Height (m)	Table Angle (Degree)	Raw Value (dBuV)	Correction Factor (dB/m)
1	125.01	23.0 QP	43.50	-20.50	1.01 V	129	10.90	12.10
2	216.02	19.2 QP	46.00	-26.80	1.33 V	191	10.00	9.20
3	250.00	33.4 QP	46.00	-12.60	1.31 V	2	20.20	13.20
4	264.01	27.1 QP	46.00	-18.90	1.52 V	170	13.00	14.10
5	319.52	21.8 QP	46.00	-24.20	1.22 V	294	7.30	14.50
6	351.99	34.0 QP	46.00	-12.00	1.62 V	14	18.40	15.60
7	480.01	26.5 QP	46.00	-19.50	1.55 V	259	7.60	18.90
8	550.05	30.4 QP	46.00	-15.60	1.01 V	1	8.60	21.80
9	585.26	36.1 QP	46.00	-9.90	1.29 V	147	14.90	21.20
10	828.02	35.4 QP	46.00	-10.60	1.34 V	346	11.00	24.40

- REMARKS:**
1. Emission level(dBuV/m)=Raw Value(dBuV) + Correction Factor(dB)
 2. Correction Factor(dB/m) = Antenna Factor (dB/m) + Cable Factor (dB)
 3. The other emission levels were very low against the limit.
 4. Margin value = Emission level – Limit value.
 5. The limit value is defined as per 15.247



EUT	802.11b Wireless LAN CardBus Adapter	MODEL	FW-C502
MODE	Channel 1	FREQUENCY RANGE	Above 1000 MHz
INPUT POWER (SYSTEM)	120Vac, 60Hz	DETECTOR FUNCTION	Peak(PK) Average (AV)
ENVIRONMENTAL CONDITIONS	20 deg. C, 64%RH, , 974 hPa	TESTED BY	Tony Chen

ANTENNA POLARITY & TEST DISTANCE: HORIZONTAL AT 3 M

No.	Freq. (MHz)	Emission Level (dBuV/m)	Limit (dBuV/m)	Margin (dB)	Antenna Height (m)	Table Angle (Degree)	Raw Value (dBuV)	Correction Factor (dB/m)
1	2038.00	35.8 PK	74.00	-38.20	1.15 H	161	6.90	28.80
2	2327.00	42.4 PK	74.00	-31.60	1.20 H	346	12.80	29.60
3	*2412.00	99.5 PK			1.09 H	120	69.60	29.90
3	*2412.00	93.9 AV			1.09 H	120	64.00	28.80
4	2496.00	42.7 PK	74.00	-31.30	1.32 H	340	12.50	30.20
5	4076.00	37.6 PK	74.00	-36.40	1.10 H	45	3.60	34.00
6	6114.00	41.8 PK	74.00	-32.20	1.11 H	50	3.50	38.30
7	8152.00	48.6 PK	74.00	-25.40	1.44 H	70	4.80	43.80

ANTENNA POLARITY & TEST DISTANCE: VERTICAL AT 3 M

No.	Freq. (MHz)	Emission Level (dBuV/m)	Limit (dBuV/m)	Margin (dB)	Antenna Height (m)	Table Angle (Degree)	Raw Value (dBuV)	Correction Factor (dB/m)
1	2038.00	41.3 PK	74.00	-32.70	1.17 V	124	12.40	28.80
2	2327.00	43.1 PK	74.00	-30.90	1.40 V	210	13.50	29.60
3	*2412.00	100.4 PK			1.10 V	210	70.50	29.90
3	*2412.00	94.5 AV			1.10 V	210	64.60	28.80
4	2496.00	44.6 PK	74.00	-29.40	1.08 V	103	14.40	30.20
5	4076.00	39.1 PK	74.00	-34.90	1.06 V	111	5.10	34.00
6	6114.00	42.9 PK	74.00	-31.10	1.35 V	113	4.70	38.30
7	8152.00	51.3 PK	74.00	-22.70	1.34 V	54	7.60	43.80
7	8152.00	44.0 AV	54.00	-10.00	1.34 V	54	0.20	29.60

- REMARKS:**
1. Emission level(dBuV/m)=Raw Value(dBuV) + Correction Factor(dB)
 2. Correction Factor(dB/m) = Antenna Factor (dB/m) + Cable Factor (dB)
 3. The other emission levels were very low against the limit.
 4. Margin value = Emission level – Limit value.
 5. The limit value is defined as per 15.247
 6. " * " : Fundamental frequency



EUT	802.11b Wireless LAN CardBus Adapter	MODEL	FW-C502
MODE	Channel 6	FREQUENCY RANGE	Above 1000 MHz
INPUT POWER (SYSTEM)	120Vac, 60Hz	DETECTOR FUNCTION	Peak(PK) Average (AV)
ENVIRONMENTAL CONDITIONS	20 deg. C, 64%RH, , 974 hPa	TESTED BY	Tony Chen

ANTENNA POLARITY & TEST DISTANCE: HORIZONTAL AT 3 M

No.	Freq. (MHz)	Emission Level (dBuV/m)	Limit (dBuV/m)	Margin (dB)	Antenna Height (m)	Table Angle (Degree)	Raw Value (dBuV)	Correction Factor (dB/m)
1	2063.00	31.5 PK	74.00	-42.50	1.62 H	210	2.60	28.90
2	2376.00	35.5 PK	74.00	-38.50	1.42 H	211	5.80	29.70
3	*2437.00	99.9 PK			1.55 H	125	69.90	30.00
3	*2437.00	93.0 AV			1.55 H	125	63.00	28.90
4	2496.00	37.5 PK	74.00	-36.50	1.46 H	327	7.30	30.20
5	4126.00	39.3 PK	74.00	-34.70	1.13 H	53	5.20	34.10
6	6189.00	39.9 PK	74.00	-34.10	1.59 H	21	1.50	38.40
7	8252.00	48.0 PK	74.00	-26.00	1.50 H	81	3.60	44.30

ANTENNA POLARITY & TEST DISTANCE: VERTICAL AT 3 M

No.	Freq. (MHz)	Emission Level (dBuV/m)	Limit (dBuV/m)	Margin (dB)	Antenna Height (m)	Table Angle (Degree)	Raw Value (dBuV)	Correction Factor (dB/m)
1	2063.00	38.8 PK	74.00	-35.20	1.16 V	214	9.90	28.90
2	2386.00	39.5 PK	74.00	-34.50	1.62 V	210	9.70	29.80
3	*2437.00	99.2 PK			1.36 V	214	69.20	30.00
3	*2437.00	92.7 AV			1.36 V	214	62.80	28.90
4	2490.00	40.1 PK	74.00	-33.90	1.54 V	10	10.00	30.20
5	4126.00	39.2 PK	74.00	-34.80	1.66 V	201	5.10	34.10
6	6189.00	44.2 PK	74.00	-29.80	1.10 V	260	5.80	38.40
7	8252.00	51.1 PK	74.00	-22.90	1.53 V	60	6.80	44.30
7	8252.00	42.0 AV	54.00	-12.00	1.53 V	60	-2.30	29.80

- REMARKS:**
1. Emission level(dBuV/m)=Raw Value(dBuV) + Correction Factor(dB)
 2. Correction Factor(dB/m) = Antenna Factor (dB/m) + Cable Factor (dB)
 3. The other emission levels were very low against the limit.
 4. Margin value = Emission level – Limit value.
 5. The limit value is defined as per 15.247
 6. “ * “ : Fundamental frequency



EUT	802.11b Wireless LAN CardBus Adapter	MODEL	FW-C502
MODE	Channel 11	FREQUENCY RANGE	Above 1000 MHz
INPUT POWER (SYSTEM)	120Vac, 60Hz	DETECTOR FUNCTION	Peak(PK) Average (AV)
ENVIRONMENTAL CONDITIONS	20 deg. C, 64%RH, , 974 hPa	TESTED BY	Tony Chen

ANTENNA POLARITY & TEST DISTANCE: HORIZONTAL AT 3 M

No.	Freq. (MHz)	Emission Level (dBuV/m)	Limit (dBuV/m)	Margin (dB)	Antenna Height (m)	Table Angle (Degree)	Raw Value (dBuV)	Correction Factor (dB/m)
1	2088.00	31.6 PK	74.00	-42.40	1.13 H	190	2.60	29.00
2	2376.00	36.3 PK	74.00	-37.70	1.60 H	11	6.60	29.70
3	*2462.00	99.2 PK			1.48 H	235	69.20	30.10
3	*2462.00	92.5 AV			1.48 H	235	62.50	29.00
4	2496.00	43.6 PK	74.00	-30.40	1.56 H	351	13.40	30.20
5	4176.00	37.9 PK	74.00	-36.10	1.13 H	162	3.80	34.20
6	6264.00	39.3 PK	74.00	-34.70	1.11 H	66	0.70	38.50
7	8352.00	47.1 PK	74.00	-26.90	1.50 H	80	2.20	44.90

ANTENNA POLARITY & TEST DISTANCE: VERTICAL AT 3 M

No.	Freq. (MHz)	Emission Level (dBuV/m)	Limit (dBuV/m)	Margin (dB)	Antenna Height (m)	Table Angle (Degree)	Raw Value (dBuV)	Correction Factor (dB/m)
1	2088.00	36.5 PK	74.00	-37.50	1.16 V	194	7.50	29.00
2	2376.00	37.3 PK	74.00	-36.70	1.51 V	211	7.60	29.70
3	*2462.00	99.4 PK			1.47 V	220	69.40	30.10
3	*2462.00	92.5 AV			1.47 V	220	62.50	29.00
4	2496.00	47.8 PK	74.00	-26.20	1.88 V	129	17.60	30.20
5	4176.00	38.3 PK	74.00	-35.70	1.65 V	241	4.20	34.20
6	6264.00	41.6 PK	74.00	-32.40	1.11 V	263	3.10	38.50
7	8352.00	49.4 PK	74.00	-24.60	1.51 V	52	4.50	44.90

- REMARKS:**
1. Emission level(dBuV/m)=Raw Value(dBuV) + Correction Factor(dB)
 2. Correction Factor(dB/m) = Antenna Factor (dB/m) + Cable Factor (dB)
 3. The other emission levels were very low against the limit.
 4. Margin value = Emission level – Limit value.
 5. The limit value is defined as per 15.247
 6. “ * “ : Fundamental frequency



4.3 6dB BANDWIDTH MEASUREMENT

4.3.1 LIMITS OF 6dB BANDWIDTH MEASUREMENT

The minimum of 6dB Bandwidth Measurement is 0.5 MHz.

4.3.2 TEST INSTRUMENTS

Description & Manufacturer	Model No.	Serial No.	Calibrated Until
R&S SPECTRUM ANALYZER	FSP	1093.4495.30	Dec. 19, 2003

NOTE:

- 1.The measurement uncertainty is less than +/- 2.6dB, which is calculated as per the NAMAS document NIS81.
- 2.The calibration interval of the above test instruments is 12 months and the calibrations are traceable to NML/ROC and NIST/USA.

4.3.3 TEST PROCEDURE

The transmitter output was connected to the spectrum analyzer through an attenuator. The bandwidth of the fundamental frequency was measured by spectrum analyzer with 100 kHz RBW and 100 kHz VBW. The 6 dB bandwidth is defined as the total spectrum the power of which is higher than peak power minus 6 dB.

4.3.4 DEVIATION FROM TEST STANDARD

No deviation

4.3.5 TEST SETUP

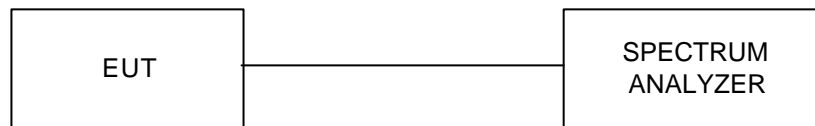

4.3.6 EUT OPERATING CONDITIONS

The software provided by client to enable the EUT under transmission condition continuously at lowest, middle and highest channel frequencies individually.



4.3.7 TEST RESULTS

EUT	802.11b Wireless LAN CardBus Adapter	MODEL	FW-C502
INPUT POWER (SYSTEM)	120Vac, 60Hz	ENVIRONMENTAL CONDITIONS	20deg. C, 64%RH, 974 hPa
TEST BY	Hank Chung		

CHANNEL	CHANNEL FREQUENCY (MHz)	6 dB BANDWIDTH (MHz)	MINIMUM LIMIT (MHz)	PASS/FAIL
1	2412	12.00	0.5	PASS
6	2437	12.12	0.5	PASS
11	2462	11.96	0.5	PASS



CH1

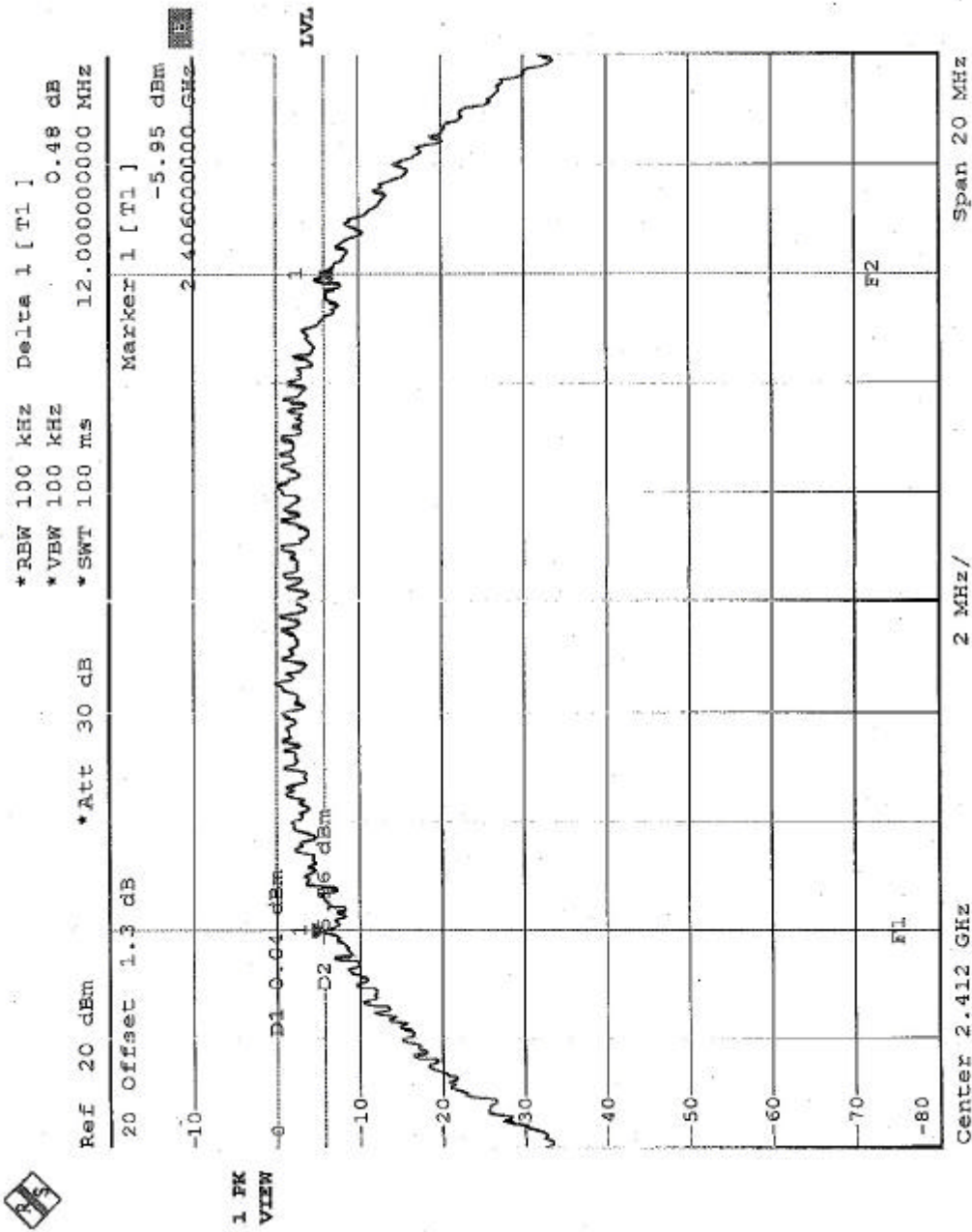



CH6

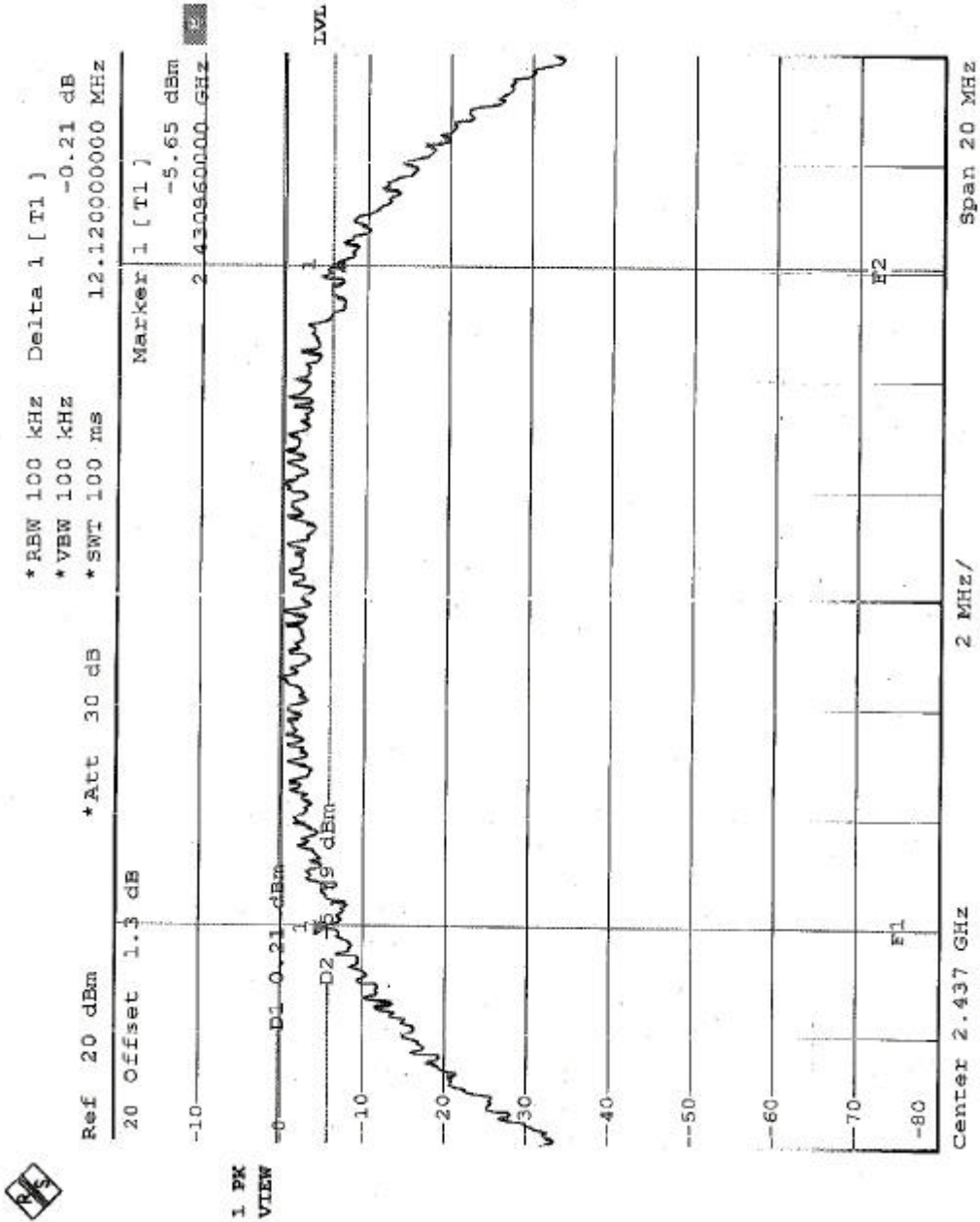



CH11

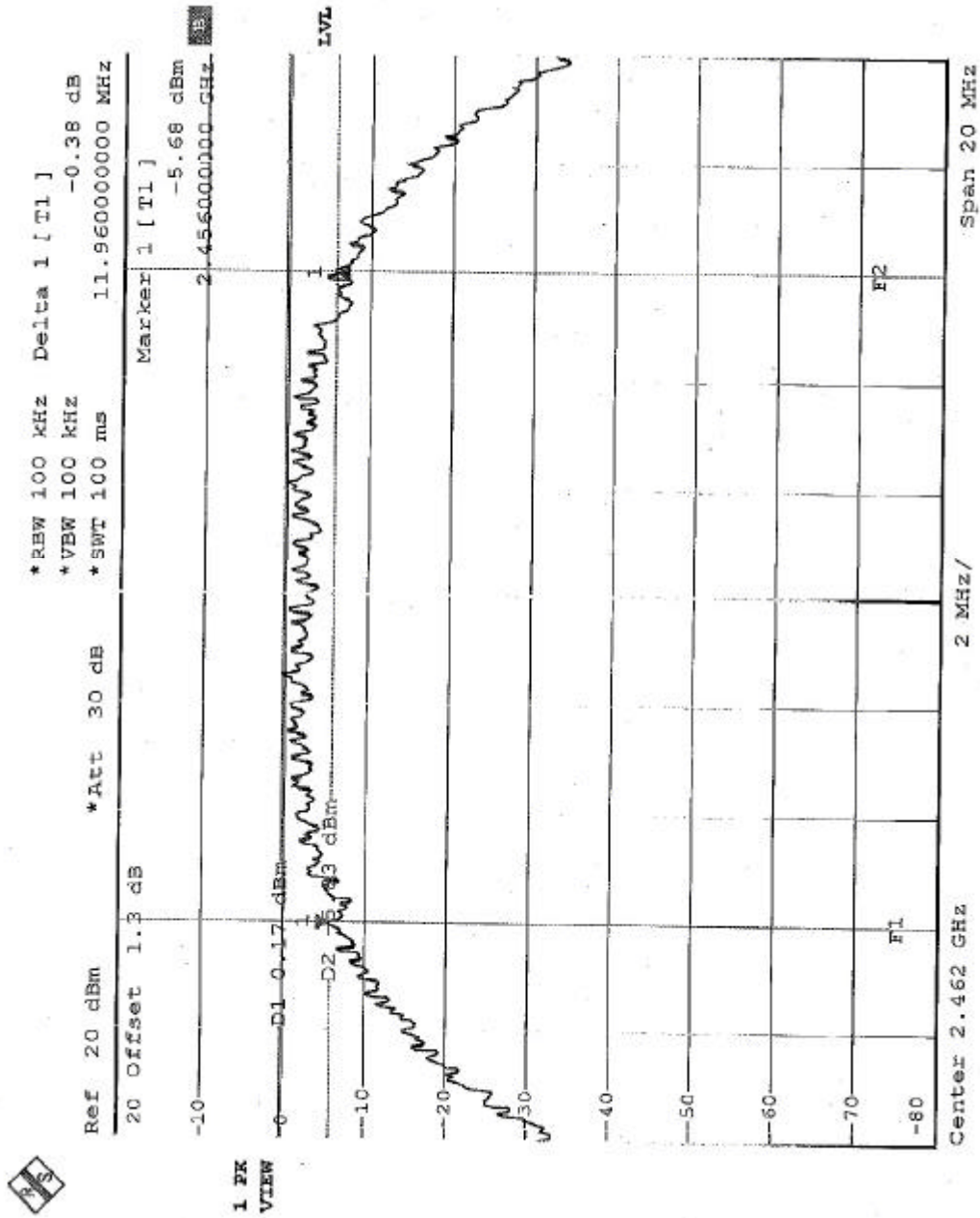



4.4 MAXIMUM PEAK OUTPUT POWER

4.4.1 LIMITS OF MAXIMUM PEAK OUTPUT POWER MEASUREMENT

The Maximum Peak Output Power Measurement is 30dBm.

4.4.2 INSTRUMENTS

Description & Manufacturer	Model No.	Serial No.	Calibrated Until
SINGLE CHANNEL POWER METER	NRVS	100026	Mar. 06, 2004
PEAK POWER SENSOR	NRV-Z32	100013	Mar. 06, 2004

NOTE:

1. The measurement uncertainty is less than +/- 2.6dB, which is calculated as per the NAMAS document NIS81.
2. The calibration interval of the above test instruments is 12 months and the calibrations are traceable to NML/ROC and NIST/USA.



4.4.3 TEST PROCEDURES

The transmitter output was connected to the peak power meter.

4.4.4 DEVIATION FROM TEST STANDARD

No deviation

4.4.5 TEST SETUP

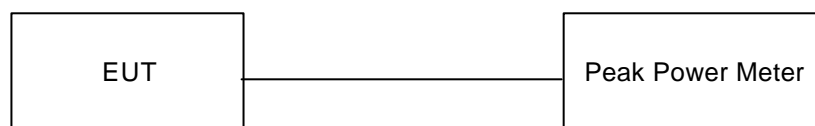

4.4.6 EUT OPERATING CONDITIONS

Same as Item 4.3.6



4.4.7 TEST RESULTS

EUT	802.11b Wireless LAN CardBus Adapter	MODEL	FW-C502
INPUT POWER (SYSTEM)	120Vac, 60Hz	ENVIRONMENTAL CONDITIONS	20deg.C, 64%RH, 974 hPa
TEST BY	Hank Chung		

CHANNEL	CHANNEL FREQUENCY (MHz)	PEAK POWER OUTPUT (dBm)	PEAK POWER LIMIT (dBm)	PASS/FAIL
1	2412	10.53	30	PASS
6	2437	10.93	30	PASS
11	2462	10.83	30	PASS



4.4.8 LIMITS OF POWER SPECTRAL DENSITY MEASUREMENT

The Maximum of Power Spectral Density Measurement is 8dBm.

4.4.9 TEST INSTRUMENTS

Description & Manufacturer	Model No.	Serial No.	Calibrated Until
R&S SPECTRUM ANALYZER	FSP	1093.4495.30	Dec. 19, 2003

NOTE:

- 1.The measurement uncertainty is less than +/- 2.6dB, which is calculated as per the NAMAS document NIS81.
- 2.The calibration interval of the above test instruments is 12 months and the calibrations are traceable to NML/ROC and NIST/USA.

4.4.10 TEST PROCEDURE

The transmitter output was connected to the spectrum analyzer through an attenuator, the bandwidth of the fundamental frequency was measured with the spectrum analyzer using 3 kHz RBW and 30 kHz VBW, set sweep time = span/3 kHz. The power spectral density was measured and recorded.

The sweep time is allowed to be longer than span/3 kHz for a full response of the mixer in the spectrum analyzer.

4.4.11 DEVIATION FROM TEST STANDARD

No deviation

4.4.12 TEST SETUP

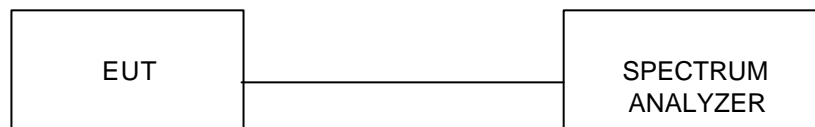

4.4.13 EUT OPERATING CONDITION

Same as Item 4.3.6



4.4.14 TEST RESULTS

EUT	802.11b Wireless LAN CardBus Adapter	MODEL	FW-C502
INPUT POWER (SYSTEM)	120Vac, 60Hz	ENVIRONMENTAL CONDITIONS	20deg. C, 64%RH, 974 hPa
TEST BY	Hank Chung		

CHANNEL NUMBER	CHANNEL FREQUENCY (MHz)	RF POWER LEVEL IN 3 kHz BW (dBm)	MAXIMUM LIMIT (dBm)	PASS/FAIL
1	2412	-14.49	8	PASS
6	2437	-14.01	8	PASS
11	2462	-14.05	8	PASS



CH1

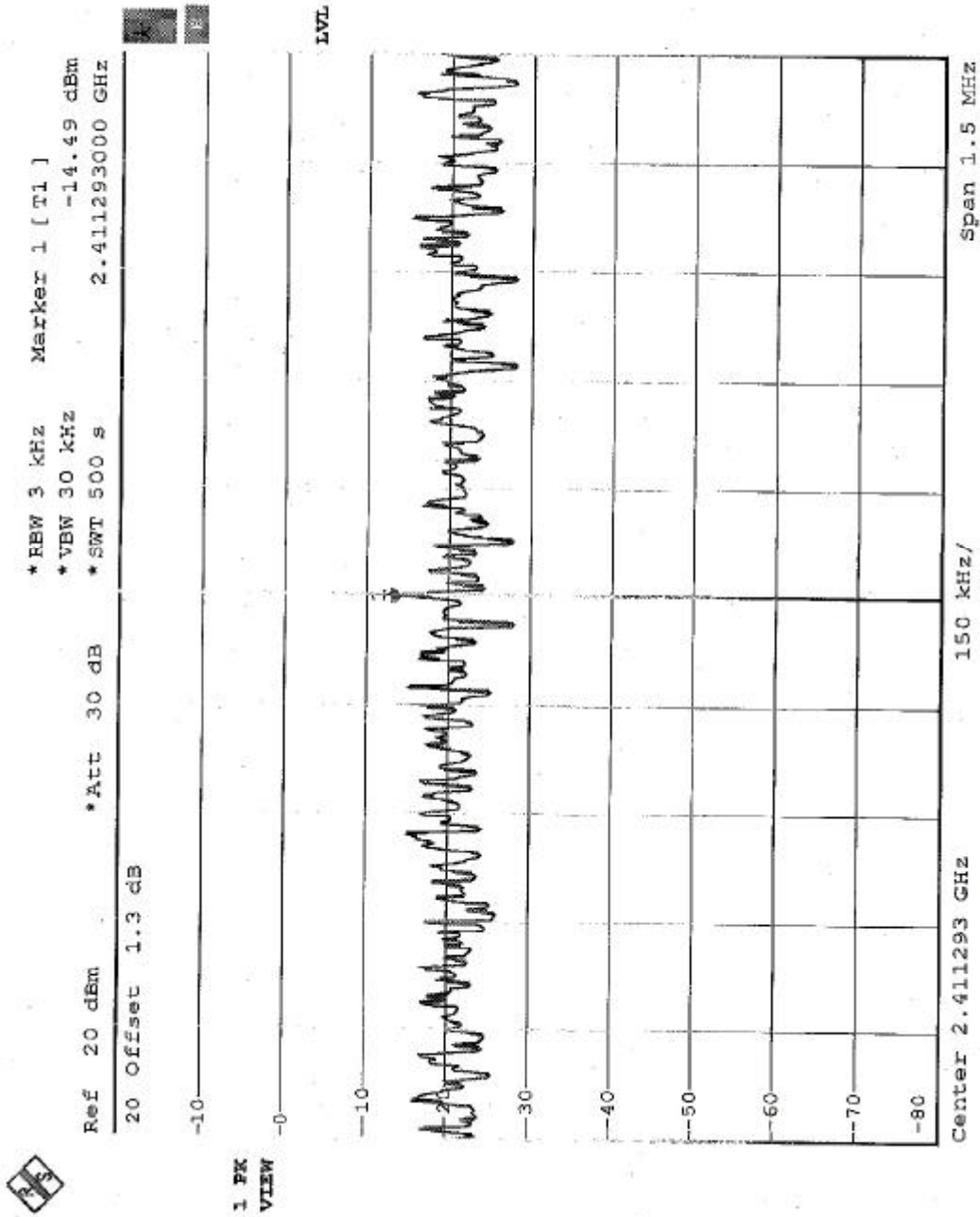



CH6

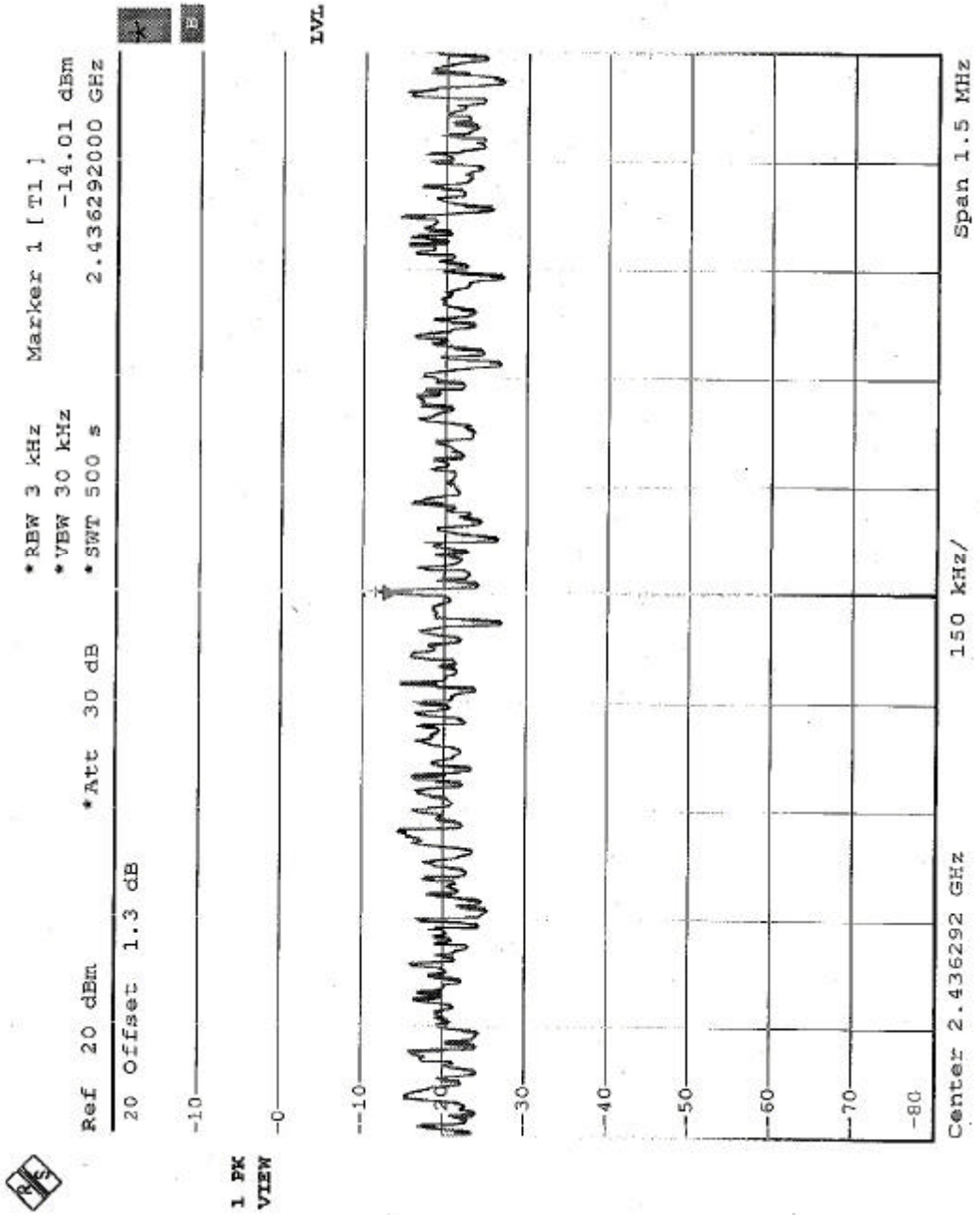



CH11

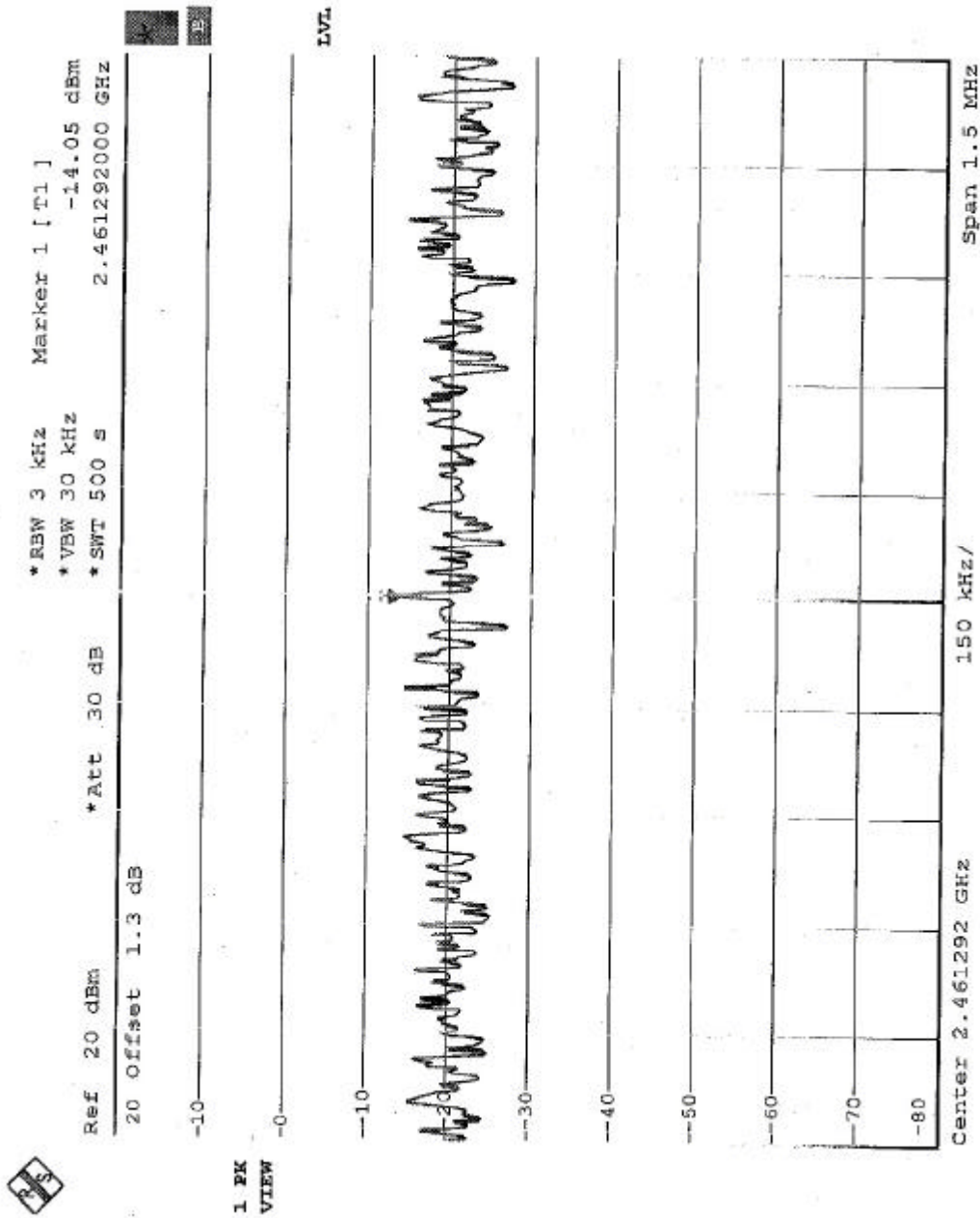



4.5 BAND EDGES MEASUREMENT

4.5.1 LIMITS OF BAND EDGES MEASUREMENT

Below -20dB of the highest emission level of operating band (in 100KHz Resolution Bandwidth).

4.5.2 TEST INSTRUMENTS

Description & Manufacturer	Model No.	Serial No.	Calibrated Until
R&S SPECTRUM ANALYZER	FSP	1093.4495.30	Dec. 19, 2003

NOTE:

- 1.The measurement uncertainty is less than +/- 2.6dB, which is calculated as per the NAMAS document NIS81.
- 2.The calibration interval of the above test instruments is 12 months and the calibrations are traceable to NML/ROC and NIST/USA.

4.5.3 TEST PROCEDURE

The transmitter output was connected to the spectrum analyzer via a low lose cable. Set both RBW and VBW of spectrum analyzer to 100 kHz with suitable frequency span including 100 kHz bandwidth from band edge. The band edges was measured and recorded.

4.5.4 DEVIATION FROM TEST STANDARD

No deviation



4.5.5 EUT OPERATING CONDITION

Same as Item 4.3.6

4.5.6 TEST RESULTS

The spectrum plots are attached on the following 2 pages. D1 line indicates the highest level, D2 line indicates the 20dB offset below D1. It shows compliance with the requirement in part 15.247(C).

NOTE: The band edge emission plot on the following two pages shows 47.04 / 46.68 dB delta between carrier maximum power and local maximum emission in restrict band (2.3764GHz / 2.4856 GHz). The emission of carrier strength list in the test result of channel 1 at the item 4.2.7 (Page 24) is 94.5dBuV/m, so the maximum field strength in restrict band is $94.5 - 47.04 = 47.46$ dBuV/m which is under 54dBuV/m limit.

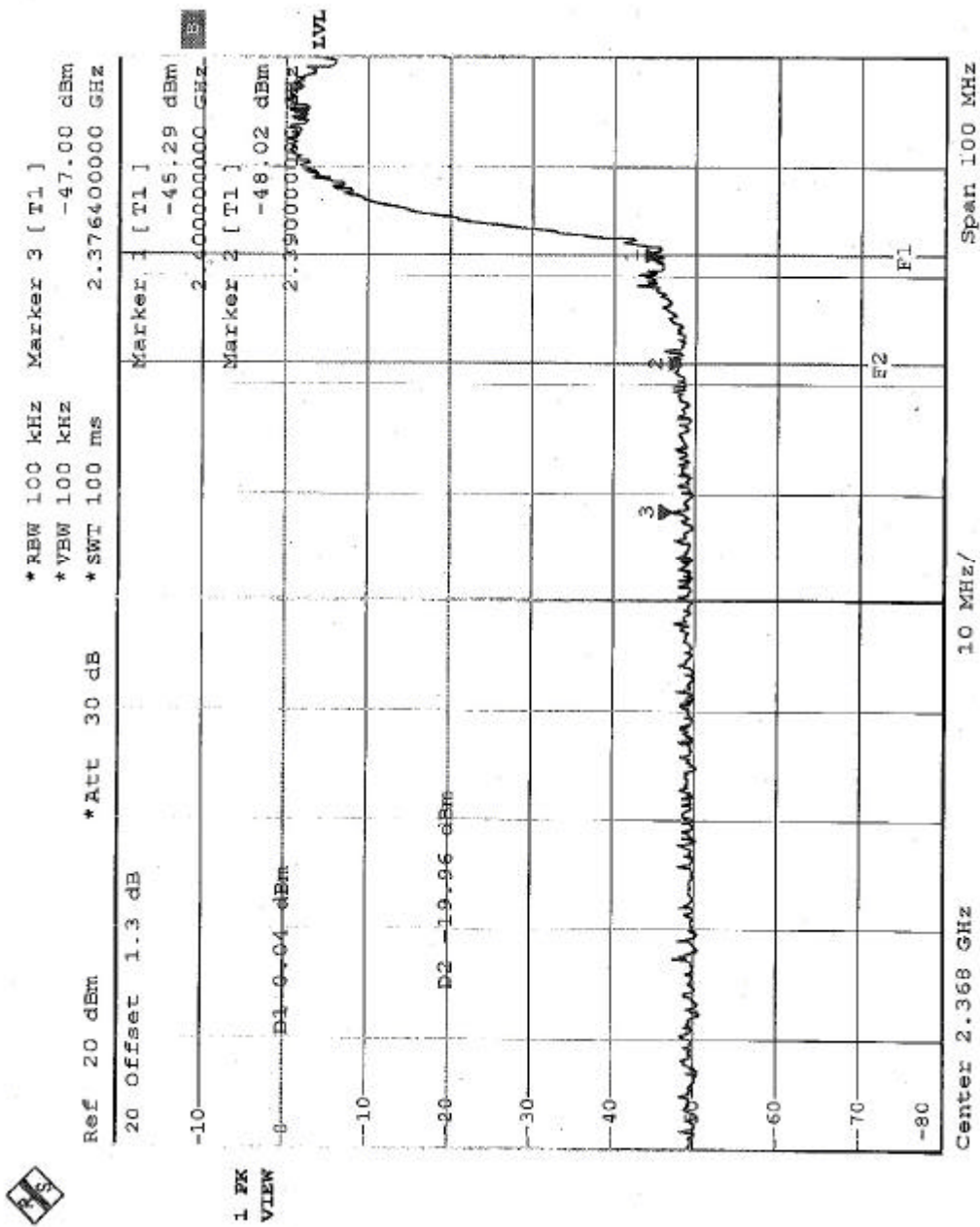

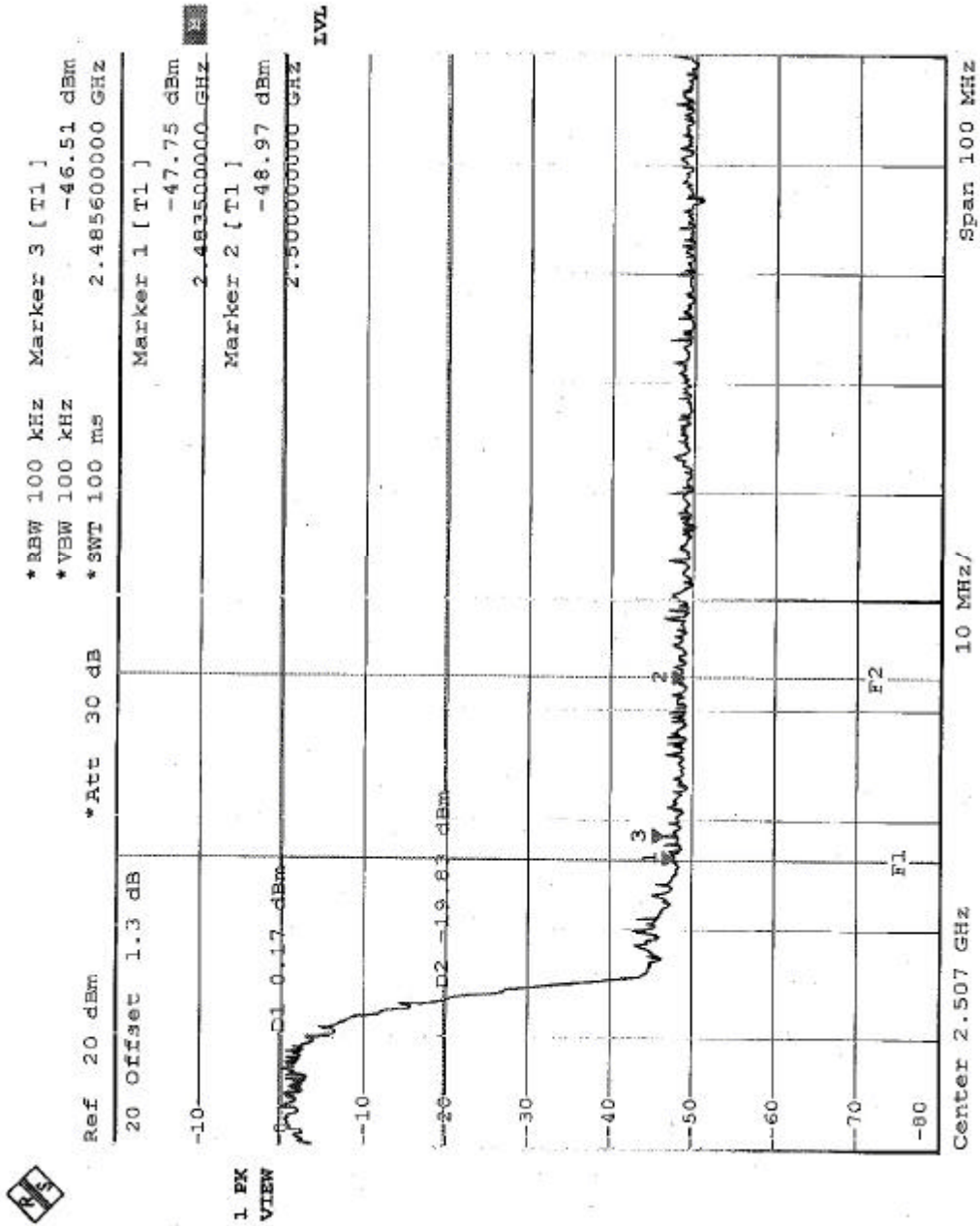



4.6 ANTENNA REQUIREMENT

4.6.1 STANDARD APPLICABLE

For intentional device, according to FCC 47 CFR Section 15.203, an intentional radiator shall be designed to ensure that no antenna other than that furnished by the responsible party shall be used with the device. And according to FCC 47 CFR Section 15.247 (b), if transmitting antennas of directional gain greater than 6dBi are used, the power shall be reduced by the amount in dB that the directional gain of the antenna exceeds 6dBi.

4.6.2 ANTENNA CONNECTED CONSTRUCTION

The antenna used in this product is PIFA Antenna without connector. The maximum Gain of the antenna is 0dBi.

5 PHOTOGRAPHS OF THE TEST CONFIGURATION CONDUCTED EMISSION TEST



RADIATED EMISSION TEST

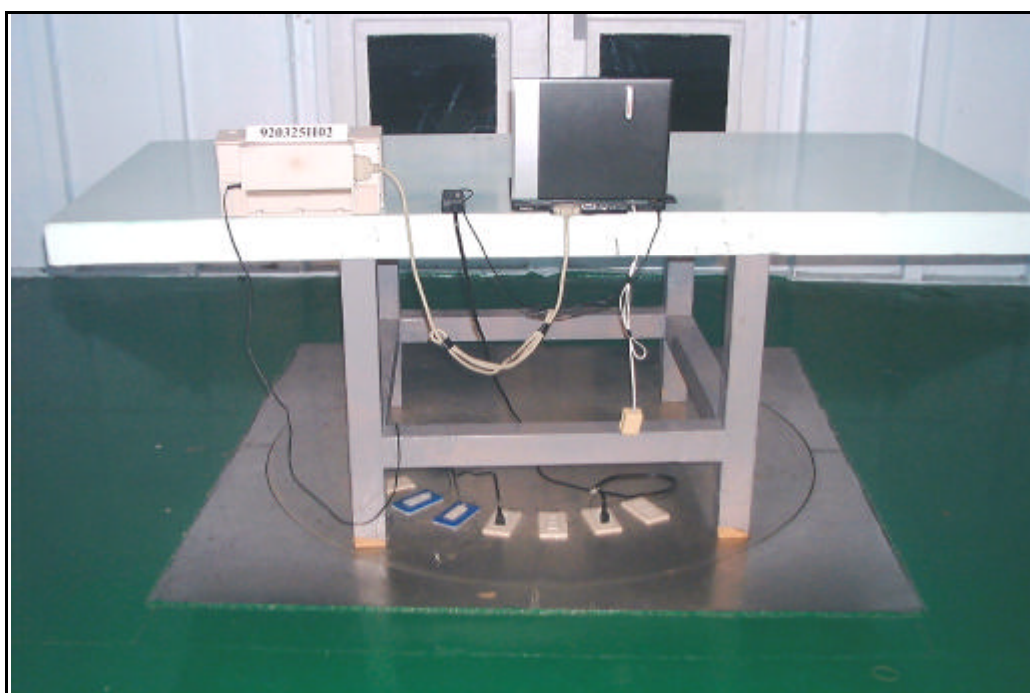



6 INFORMATION ON THE TESTING LABORATORIES

We, ADT Corp., were founded in 1988 to provide our best service in EMC and Safety consultation. Our laboratories are accredited and approved by the following approval agencies according to ISO/IEC 17025, Guide 25 or EN 45001:

USA	FCC, NVLAP, UL
Germany	TUV Rheinland
Japan	VCCI
New Zealand	MoC
Norway	NEMKO
R.O.C.	BSMI, DGT, CNLA

Copies of accreditation certificates of our laboratories obtained from approval agencies can be downloaded from our web site:

www.adt.com.tw/index.5/phtml.

If you have any comments, please feel free to contact us at the following:

Lin Kou EMC Lab:

Tel: 886-2-26052180

Fax: 886-2-26052943

Hsin Chu EMC Lab:

Tel: 886-35-935343

Fax: 886-35-935342

Lin Kou Safety Lab:

Tel: 886-2-26093195

Fax: 886-2-26093184

Lin Kou RF&Telecom Lab

Tel: 886-3-3270910

Fax: 886-3-3270892

Email: service@mail.adt.com.tw

Web Site: www.adt.com.tw

The address and road map of all our labs can be found in our web site also.