

FCC RADIO TEST REPORT

FCC ID: QRP-SP-023

Product: Mobile Phone
Trade Mark: AZUMI
Model No.: V60
Family Model: N/A
Report No.: S21020301002004
Issue Date: 27 Mar. 2021

Prepared for

Azumi S.A

Avenida Aquilino de la Guardia con Calle 47, PH Ocean Plaza,
Piso 16 of. 16-01, Marbella, Ciudad de Panama, Panama

Prepared by

Shenzhen NTEK Testing Technology Co., Ltd.
1/F, Building E, Fenda Science Park, Sanwei Community,
Xixiang Street Bao'an District, Shenzhen P.R. China
Tel:400-800-6106,0755-2320 0050 / 2320 0090
Website: <http://www.ntek.org.cn>

TABLE OF CONTENTS

1	TEST RESULT CERTIFICATION	3
2	SUMMARY OF TEST RESULTS.....	4
3	FACILITIES AND ACCREDITATIONS	5
3.1	FACILITIES.....	5
3.2	LABORATORY ACCREDITATIONS AND LISTINGS	5
3.3	MEASUREMENT UNCERTAINTY	5
4	GENERAL DESCRIPTION OF EUT	6
5	DESCRIPTION OF TEST MODES	8
6	SETUP OF EQUIPMENT UNDER TEST	9
6.1	BLOCK DIAGRAM CONFIGURATION OF TEST SYSTEM.....	9
6.2	SUPPORT EQUIPMENT.....	10
6.3	EQUIPMENTS LIST FOR ALL TEST ITEMS.....	11
7	TEST REQUIREMENTS	12
7.1	FIELD STRENGTH OF SPURIOUS RADIATION	12
7.2	EFFECTIVE RADIATED POWER AND EFFECTIVE ISOTROPIC RADIATED POWER.....	23
7.3	CONDUCTED OUTPUT POWER.....	29
7.4	FREQUENCY STABILITY.....	31
7.5	PEAK-TO-AVERAGE RATIO	38
7.6	26DB BANDWIDTH AND 99% OCCUPIED BANDWIDTH	39
7.7	CONDUCTED BAND EDGE	41
7.8	CONDUCTED SPURIOUS EMISSION AT ANTENNA TERMINAL	42
8	TEST RESULTS	43
8.1	CONDUCTED OUTPUT POWER.....	43
8.2	PEAK-TO-AVERAGE RATIO	44
8.3	OCCUPIED BANDWIDTH	44
8.4	BAND EDGE.....	52
8.5	OUT-OF-BAND EMISSIONS	66
8.6	CONDUCTED OUTPUT POWER.....	66
8.7	CONDUCTED OUTPUT POWER.....	76
8.8	PEAK-TO-AVERAGE RATIO	78
8.9	OCCUPIED BANDWIDTH	82
8.10	BAND EDGE.....	86
8.11	OUT-OF-BAND EMISSIONS	89
8.12	PEAK-TO-AVERAGE RATIO	93
8.13	OCCUPIED BANDWIDTH	97
8.14	BAND EDGE.....	101
8.15	OUT-OF-BAND EMISSIONS	104

1 TEST RESULT CERTIFICATION

Applicant's name.....:	Azumi S.A
Address	Avenida Aquilino de la Guardia con Calle 47, PH Ocean Plaza, Piso 16 of. 16-01, Marbella, Ciudad de Panama, Panama
Manufacturer's Name.....:	AZUMI HK LTD
Address	FLAT/RM 18 BLK 1 14/F GOLDEN INDUSTRIAL BUILDING 16-26 KWAI TAK STREET KWAI CHUNG, HK
Product description	
Product name.....:	Mobile Phone
Model and/or type reference	V60
Family Model.....:	N/A

Measurement Procedure Used:

APPLICABLE STANDARDS	
APPLICABLE STANDARD/ TEST PROCEDURE	TEST RESULT
47 CFR Part 2, Part 22H, Part 24E, Part 27L ANSI/TIA-603-E-2016 FCC KDB 971168 D01 Power Meas License Digital Systems v03r01 ANSI C63.26:2015	Complied

This device described above has been tested by Shenzhen NTEK Testing Technology Co., Ltd., and the test results show that the equipment under test (EUT) is in compliance with the FCC requirements. And it is applicable only to the tested sample identified in the report.

This report shall not be reproduced except in full, without the written approval of Shenzhen NTEK Testing Technology Co., Ltd., this document may be altered or revised by Shenzhen NTEK Testing Technology Co., Ltd., personnel only, and shall be noted in the revision of the document.

The test results of this report relate only to the tested sample identified in this report.

Date of Test : 03 Feb. 2021 ~ 27 Mar. 2021

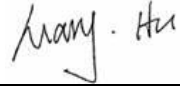
Testing Engineer : 
(Mary Hu)

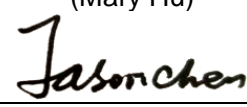
Technical Manager : 
(Jason Chen)

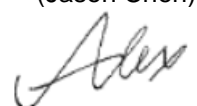
Authorized Signatory : 
(Alex Li)

2 SUMMARY OF TEST RESULTS

FCC Part22, Subpart H/ FCC Part24, Subpart E, FCC Part27, Subpart L, KDB 971168 D01 Power Meas License Digital Systems v03r01			
FCC Rule	Test Item	Verdict	Remark
2.1046	Conducted Output Power	PASS	
24.232(d) 27.50(d)(5) KDB 971168 D01 Clause 5.7	Peak-to-Average Ratio	PASS	
2.1049 22.917(b) 24.238(b) KDB 971168 D01 Clause 4.2	Occupied Bandwidth	PASS	
2.1051 22.917(a) 24.238(a) 27.53(h) KDB 971168 D01 Clause 6	Band Edge	PASS	
22.913(a)(5) KDB 971168 D01 Clause 5.6	Effective Radiated Power	PASS	
24.232(c) 27.50(d)(4) KDB 971168 D01 Clause 5.6	Equivalent Isotropic Radiated Power	PASS	
2.1053 22.917(a) 24.238(a) 27.53(h) KDB 971168 D01 Clause 7	Field Strength of Spurious Radiation	PASS	
2.1055 22.355 24.235 27.54 KDB 971168 D01 Clause 9	Frequency Stability for Temperature & Voltage	PASS	
2.1051 22.917(a) 24.238(a) 27.53(h) KDB 971168 D01 Clause 6	Conducted Emission	PASS	

Remark:

1. "N/A" denotes test is not applicable in this Test Report.
2. All test items were verified and recorded according to the standards and without any deviation during the test.
3. No modifications are made to the EUT during all test items.
4. This EUT has also been tested and complied with the requirements of FCC Part 15, Subpart B, recorded in a separate test report.

3 FACILITIES AND ACCREDITATIONS

3.1 FACILITIES

All measurement facilities used to collect the measurement data are located at 1/F, Building E, Fenda Science Park, Sanwei Community, Xixiang Street, Bao'an District, Shenzhen 518126 P.R. China.

The sites are constructed in conformance with the requirements of ANSI C63.7, ANSI C63.26 and CISPR Publication 22.

3.2 LABORATORY ACCREDITATIONS AND LISTINGS

Site Description

CNAS-Lab. : The Certificate Registration Number is L5516.

IC-Registration : The Certificate Registration Number is 9270A.
CAB identifier:CN0074

FCC- Accredited : Test Firm Registration Number: 463705.
Designation Number: CN1184

A2LA-Lab. : The Certificate Registration Number is 4298.01
This laboratory is accredited in accordance with the recognized International Standard ISO/IEC 17025:2005 General requirements for the competence of testing and calibration laboratories.

This accreditation demonstrates technical competence for a defined scope and the operation of a laboratory quality management system (refer to joint ISO-ILAC-IAF Communiqué dated 8 January 2009).

Name of Firm : Shenzhen NTEK Testing Technology Co., Ltd.

Site Location : 1/F, Building E, Fenda Science Park, Sanwei Community, Xixiang Street, Bao'an District, Shenzhen 518126 P.R. China.

3.3 MEASUREMENT UNCERTAINTY

The reported uncertainty of measurement, where expanded uncertainty U is based on a standard uncertainty multiplied by a coverage factor of k=2, providing a level of confidence of approximately 95 %.

No.	Item	Uncertainty
1	Measuring Uncertainty for a Level of Confidence of 95% (U = 2Uc(y))	2.5dB

4 GENERAL DESCRIPTION OF EUT

Product Feature and Specification	
Equipment	Mobile Phone
Trade Mark	AZUMI
FCC ID	QRP-SP-023
Model No.	V60
Family Model	N/A
Model Difference	N/A
Operating Frequency	<input checked="" type="checkbox"/> GSM850: TX824.2MHz~848.8MHz /RX869.2MHz~893.8MHz; <input checked="" type="checkbox"/> UMTS FDD Band V: TX826.4MHz~846.6MHz /RX871.4MHz~891.6MHz; <input checked="" type="checkbox"/> PCS1900: TX1850.2MHz~1909.8MHz /RX1930.2MHz~1989.8MHz; <input checked="" type="checkbox"/> UMTS FDD Band II: TX1852.4MHz~1907.6MHz /RX1932.4MHz~1987.6MHz; <input checked="" type="checkbox"/> UMTS-FDD Band IV:TX1710MHz~1755MHz /RX2110MHz~2155MHz
Modulation	<input checked="" type="checkbox"/> GMSK for GSM/GPRS; <input checked="" type="checkbox"/> 8PSK for EGPRS; <input checked="" type="checkbox"/> QPSK for UMTS bands;
GPRS Class	<input checked="" type="checkbox"/> Multi-Class12 <input checked="" type="checkbox"/> Only 4 timeslots are used for GPRS
SIM CARD	SIM 1 and SIM 2 is a chipset unit and tested as a single chipset. The SIM 1 is chosen for test.
Antenna Type	PIFA Antenna
Antenna Gain	GSM850: -1.5 dBi , PCS1900: 0.4 dBi, Band II: 0.5 dBi, Band V: -1.5 dBi, Band IV: -0.2 dBi
Power supply	<input checked="" type="checkbox"/> DC supply: DC 3.8V/3000mAh from battery or DC 5V from Adapter.
	<input checked="" type="checkbox"/> Adapter supply: Input: 100-240V~50-60Hz 0.2A Output: 5.0V---1A
HW Version	AZUMI_V60_HW_V001
SW Version	AZUMI_V60_OM_LTM_V001_20210301-NV

Note: Based on the application, features, or specification exhibited in User's Manual, the EUT is considered as an ITE/Computing Device. More details of EUT technical specification, please refer to the User's Manual. The High Voltage 4.4V and Low Voltage 3.4V was declared by manufacturer, The EUT couldn't be operate normally with higher or lower voltage.

Revision History

Report No.	Version	Description	Issued Date
S21020301002004	Rev.01	Initial issue of report	27 Mar. 2021

5 DESCRIPTION OF TEST MODES

During the testing, the EUT was controlled via Rhode & Schwarz Digital Radio Communication Tester(CMU 200) to ensure max power transmission and proper modulation. Three channels (The low channel, the middle channel and the high channel) were chosen for testing on all frequency band.

Note: GSM/GPRS/EGPRS 850, GSM/GPRS/EGPRS 1900, HSDPA band II, HSUPA band II, RMC 12.2k band II, HSDPA band V, HSUPA band V, RMC 12.2k band V, HSDPA band IV, HSUPA band IV. RMC 12.2k HSDPA band IV, modes have been tested during the test. the worst condition (GSM850, GSM1900, RMC 12.2k) be recorded in the test report if no other modes test data.

Antenna port conducted and radiated test items were performed according to KDB 971168 D01 Power Meas. License Digital Systems v03r01 with maximum output power.

Radiated measurements were performed with rotating EUT in different three orthogonal test planes to find the maximum emission.

Radiated emissions were investigated as following frequency range:

1. 30 MHz to 10th harmonic for GSM850/UMTS FDD Band V/ UMTS FDD Band IV.
2. 30 MHz to 10th harmonic for GSM1900/UMTS FDD Band II.

All modes and data rates and positions were investigated.

Test modes are chosen to be reported as the worst case configuration below:

Test Modes		
Band	For Conducted Test Cases	For Radiated Test Cases
GSM 850	GSM Link	GSM Link
GSM 1900	GSM Link	GSM Link
UMTS Band II	RMC 12.2Kbps Link	RMC 12.2Kbps Link
UMTS Band V	RMC 12.2Kbps Link	RMC 12.2Kbps Link
UMTS Band IV	RMC 12.2Kbps Link	RMC 12.2Kbps Link

Test Frequency and Channels:

Frequency Band	<input checked="" type="checkbox"/> GSM 850		<input checked="" type="checkbox"/> GSM 1900		<input checked="" type="checkbox"/> UMTS Band II		<input checked="" type="checkbox"/> UMTS Band V	
	Channel	Frequency (MHz)	Channel	Frequency (MHz)	Channel	Frequency (MHz)	Channel	Frequency (MHz)
CH_H	251	848.8	810	1909.8	9538	1907.6	4233	846.6
CH_M	189	836.4	661	1880.0	9400	1880.0	4182	836.4
CH_L	128	824.2	512	1850.2	9262	1852.4	4132	826.4

Frequency Band	<input checked="" type="checkbox"/> UMTS Band IV	
	Channel	Frequency (MHz)
CH_H	1513	1752.6
CH_M	1412	1732.4
CH_L	1312	1712.4

6 SETUP OF EQUIPMENT UNDER TEST

6.1 BLOCK DIAGRAM CONFIGURATION OF TEST SYSTEM

For Radiated Test Cases

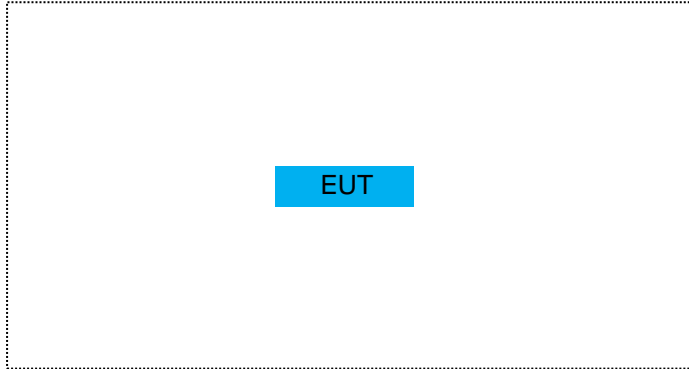

For Conducted Output Power

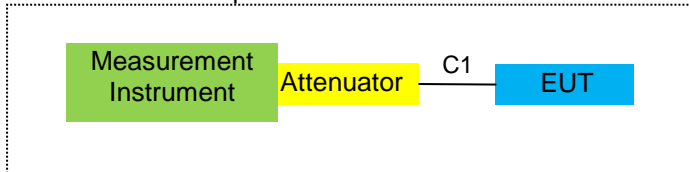

For Peak-to Average Ratio, Occupied Bandwidth, Conducted Band edge and Conducted Spurious Emission

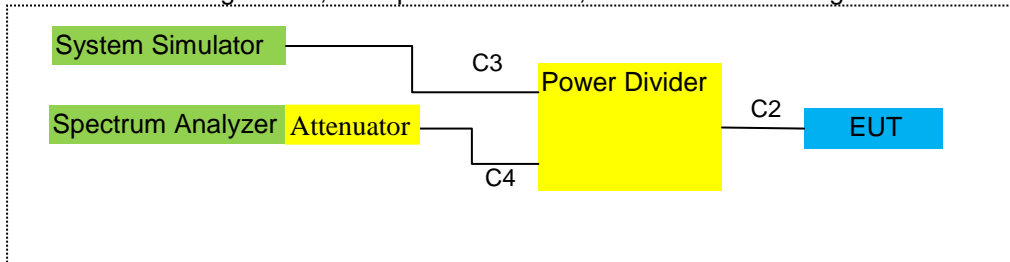

For Frequency Stability

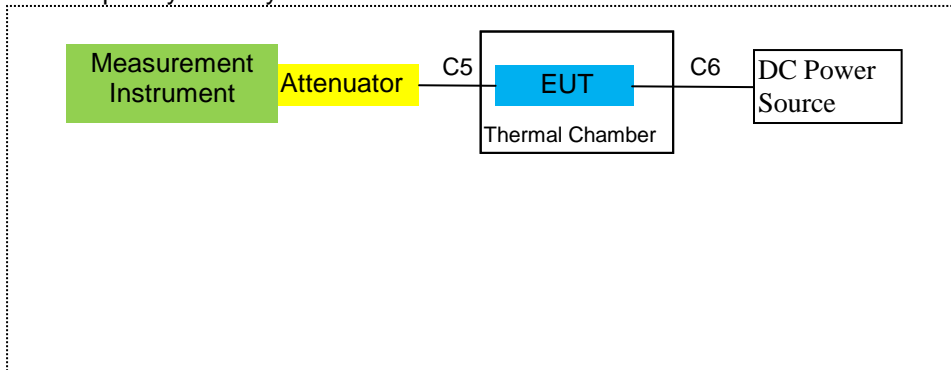

Note: EUT built-in battery-powered, the battery is fully-charged.

6.2 SUPPORT EQUIPMENT

The EUT has been tested as an independent unit together with other necessary accessories or support units. The following support units or accessories were used to form a representative test configuration during the tests.

Item	Equipment	Mfr/Brand	Model/Type No.	Series No.	Note

Item	Cable Type	Shielded Type	Ferrite Core	Length
C-1	RF Cable	YES	NO	0.1m
C-2	RF Cable	YES	NO	0.1m
C-3	RF Cable	YES	NO	0.1m
C-4	RF Cable	YES	NO	0.2m
C-5	RF Cable	YES	NO	0.2m
C-6	DC Cable	NO	NO	1.0m

Notes:

- (1) The support equipment was authorized by Declaration of Confirmation.
- (2) For detachable type I/O cable should be specified the length in cm in 『Length』 column.
- (3) “YES” is means “shielded” “with core”; “NO” is means “unshielded” “without core”.

6.3 EQUIPMENTS LIST FOR ALL TEST ITEMS

Item	Kind of Equipment	Manufacturer	Type No.	Serial No.	Last calibration	Calibrated until	Calibration period
1	MXA Signal Analyzer	Agilent	N9020A	MY49100060	2020.07.13	2021.07.12	1 year
2	Test Receiver	R&S	ESPI	101318	2020.05.11	2021.05.10	1 year
3	Bilog Antenna	TESEQ	CV6011D	31216	2020.04.11	2021.04.10	1 year
4	50Ω Coaxial Switch	Anritsu	MP59B	6200983705	2020.05.11	2023.05.10	3 year
5	Horn Antenna	EM	EM-AH-10180	2011071402	2020.04.11	2021.04.10	1 year
6	Horn Ant	Schwarzbeck	BBHA 9170	9170-181	2020.05.11	2021.05.10	1 year
7	Amplifier	EM	EM-30180	060538	2020.07.13	2021.07.12	1 year
8	Loop Antenna	ARA	PLA-1030/B	1029	2020.05.11	2021.05.10	1 year
9	Power Meter	R&S	NRVS	100696	2020.07.13	2021.07.12	1 year
10	Power Sensor	R&S	URV5-Z4	0395.1619.05	2020.05.11	2021.05.10	1 year
11	Test Cable	N/A	R-01	N/A	2019.08.06	2022.08.05	3 year
12	Test Cable	N/A	R-02	N/A	2020.05.11	2023.05.10	3 year
13	Test Cable	N/A	R-03	N/A	2019.06.28	2022.06.27	3 year
14	Test Receiver	R&S	ESCI	101160	2020.05.11	2021.05.10	1 year
15	LISN	R&S	ENV216	101313	2020.05.11	2021.05.10	1 year
16	LISN	EMCO	3816/2	00042990	2020.05.11	2021.05.10	1 year
17	50Ω Coaxial Switch	Anritsu	MP59B	6200264417	2020.05.11	2021.05.10	1 year
18	Passive Voltage Probe	R&S	ESH2-Z3	100196	2020.05.11	2023.05.10	3 year
19	Test Cable	N/A	C01	N/A	2020.05.11	2023.05.10	3 year
20	Test Cable	N/A	C02	N/A	2020.05.11	2023.05.10	3 year
21	Test Cable	N/A	C03	N/A	2020.05.11	2021.05.10	1 year
22	Attenuator	MCE	24-10-34	BN9258	2020.05.11	2021.05.10	1 year
23	Spectrum Analyzer	agilent	e4440a	us44300399	2020.05.11	2021.05.10	1 year
24	test receiver	R&S	ESCI	a0304218	2020.05.11	2021.05.10	1 year
25	Communication Tester	R&S	CMU200	A0304247	2020.07.13	2021.07.12	1 year
26	Thermal Chamber	Ten Billion	TTC-B3C	TBN-960502	2020.05.11	2021.05.10	1 year
27	DC Power Source	N/A	PS-6005D	20170402923	2019.08.06	2022.08.05	3 year

Note: Each piece of equipment is scheduled for calibration once a year except the Test Cable& DC Power Source which is scheduled for calibration every 3 years.

7 TEST REQUIREMENTS

7.1 FIELD STRENGTH OF SPURIOUS RADIATION

7.1.1 Applicable Standard

According to FCC KDB 971168 D01 v03r01 Section 5.8 and ANSI/TIA-603-E-2016 Section 2.2.12

7.1.2 Conformance Limit

The power of any emission outside of the authorized operating frequency ranges must be attenuated below the transmitter power (P) by a factor of at least $43 + 10 \log (P)$ dB. The spectrum is scanned from 30 MHz up to a frequency including its 10th harmonic.

7.1.3 Measuring Instruments

The Measuring equipment is listed in the section 6.3 of this test report.

7.1.4 Test Configuration

According to the ANSI/TIA-603-E-2016 test method, The Receiver or Spectrum was scanned from 9 KHz to the 10th harmonic of the highest frequency generated within the equipment, which is the transmitted carrier that can be as high as 1910 MHz The resolution bandwidth is set as outlined in Part 24.238, Part 22.917, Part 27.53 The spectrum is scanned with the mobile station transmitting at carrier frequencies that pertain to low, mid and high channels of WCDMA Band II / WCDMA Band V / WCDMA Band IV/ GSM 850/ GSM 1900.

TEST CONFIGURATION

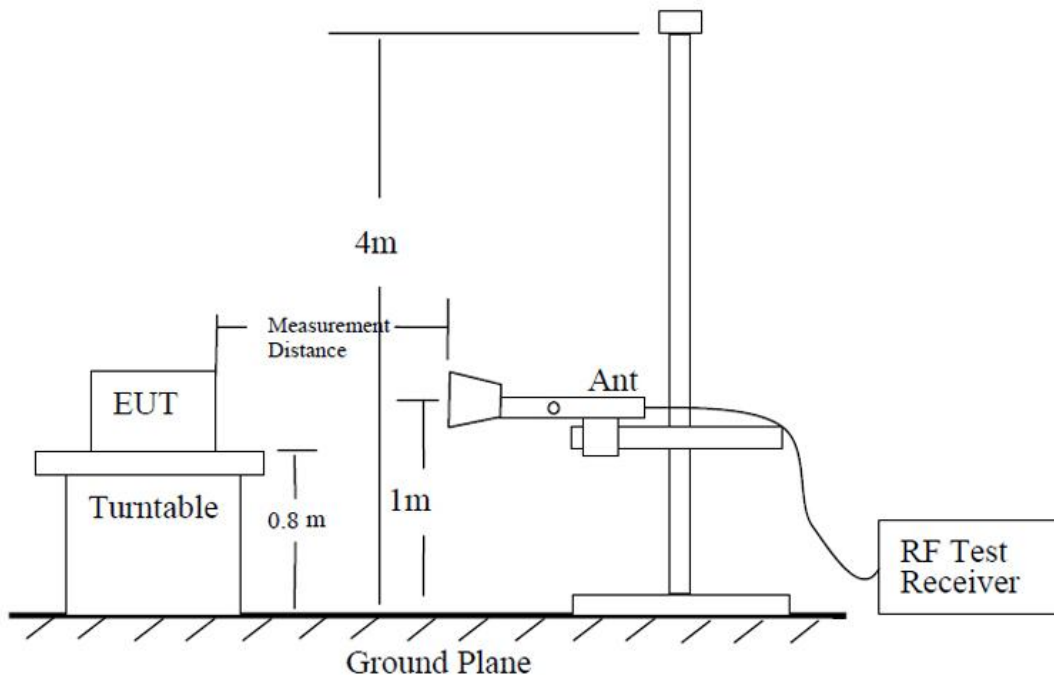



7.1.5 Test Procedure

1. EUT was placed on a 0.8 meter (For frequency above 1G, EUT should be placed on 1.5m) high non-conductive stand at a 3 meter test distance from the receive antenna. A receiving antenna was placed on the antenna mast 3 meters from the EUT for emission measurements. The height of receiving antenna is 1.50 meter. Detected emissions were maximized at each frequency by rotating the EUT through 360° and adjusting the receiving antenna polarization. The radiated emission measurements of all transmit frequencies in three channels (High, Middle, Low) were measured with peak detector.
2. A log-periodic antenna or double-ridged waveguide horn antenna shall be substituted in place of the EUT. The log-periodic antenna will be driven by a signal generator and the level will be adjusted till the same power value on the spectrum analyzer or receiver. The level of the spurious emissions can be calculated through the level of the signal generator, cable loss, the gain of the substitution antenna and the reading of the spectrum analyzer or receiver.
3. The EUT is then put into continuously transmitting mode at its maximum power level during the test. Set Test Receiver or Spectrum RBW=1MHz, VBW=3MHz, And the maximum value of the receiver should be recorded as (P_r).
4. The EUT shall be replaced by a substitution antenna. In the chamber, an substitution antenna for the frequency band of interest is placed at the reference point of the chamber. An RF Signal source for the frequency band of interest is connected to the substitution antenna with a cable that has been constructed to not interfere with the radiation pattern of the antenna. A power (SG Level) is applied to the input of the substitution antenna, and adjust the level of the signal generator output until the value of the receiver reach the previously recorded (P_r). The power of signal source (SG Level) is recorded. The test should be performed by rotating the test item and adjusting the receiving antenna polarization.
5. A amplifier should be connected to the Signal Source output port. And the cable should be connect between the Amplifier and the Substitution Antenna. The cable loss (Cable Loss) ,the Substitution Antenna Gain should be recorded after test.
 The measurement results are obtained as described below:
 $Power(EIRP) = SG\ Level - Cable\ Loss + Antenna\ Gain$
6. This value is EIRP since the measurement is calibrated using an antenna of known gain (2.15 dBi) and known input power.
7. ERP can be calculated from EIRP by subtracting the gain of the dipole, $ERP = EIRP - 2.15dBi$.

7.1.6 Test Results

EUT:	Mobile Phone	Model No.:	V60
Temperature:	20 °C	Relative Humidity:	48%
Test Mode:	GSM/GPRS/EGPRS 850/ GSM/GPRS/EGPRS 1900 UMTS band II/ UMTS band V/ UMTS band IV	Test By:	Mary Hu

■ Radiated Spurious Emission

GSM 850							
Frequency	SG Level	Cable Loss	Antenna Factor	Absolute Level	Limit	Over Limit	Polarity
(MHz)	(dBm)	(dB)	(dB)	(dBm)	(dBm)	(dBm)	
Test Results for Channel 128/824.2 MHz							
1648.4	-49.56	2.80	27.50	-24.86	-13	-11.86	Vertical
1648.4	-53.13	2.80	27.50	-28.43	-13	-15.43	Horizontal
2472.6	-47.66	2.91	27.80	-22.77	-13	-9.77	Vertical
2472.6	-52.35	2.91	27.80	-27.46	-13	-14.46	Horizontal
3296.8	-52.31	4.02	29.87	-26.46	-13	-13.46	Vertical
3296.8	-50.01	4.02	29.87	-24.16	-13	-11.16	Horizontal
Test Results for Channel 189/836.4 MHz							
1672.8	-50.16	2.80	27.48	-25.48	-13	-12.48	Vertical
1672.8	-50.90	2.80	27.48	-26.22	-13	-13.22	Horizontal
2509.2	-51.57	2.91	27.70	-26.78	-13	-13.78	Vertical
2509.2	-50.33	2.91	27.70	-25.54	-13	-12.54	Horizontal
3345.6	-52.44	4.02	29.82	-26.64	-13	-13.64	Vertical
3345.6	-52.24	4.02	29.82	-26.44	-13	-13.44	Horizontal
Test Results for Channel 251/848.8 MHz							
1697.6	-50.95	2.80	27.42	-26.33	-13	-13.33	Vertical
1697.6	-51.89	2.80	27.42	-27.27	-13	-14.27	Horizontal
2546.4	-49.59	2.91	27.68	-24.82	-13	-11.82	Vertical
2546.4	-53.56	2.91	27.68	-28.79	-13	-15.79	Horizontal
3395.2	-50.91	4.02	29.80	-25.13	-13	-12.13	Vertical
3395.2	-51.08	4.02	29.80	-25.30	-13	-12.30	Horizontal

Remark:

1. We were tested all Configuration refer 3GPP TS134 121.
2. Absolute Level = SG Level- Cable Loss+ Antenna Factor
3. Over Limit= Absolute Level (dBm)-Limit(dBm)

GPRS 850							
Frequency	SG Level	Cable Loss	Antenna Factor	Absolute Level	Limit	Over Limit	Polarity
(MHz)	(dBm)	(dB)	(dB)	(dBm)	(dBm)	(dBm)	
Test Results for Channel 128/824.2 MHz							
1648.4	-50.61	2.80	27.50	-25.91	-13	-12.91	Vertical
1648.4	-51.40	2.80	27.50	-26.70	-13	-13.70	Horizontal
2472.6	-51.31	2.91	27.80	-26.42	-13	-13.42	Vertical
2472.6	-51.65	2.91	27.80	-26.76	-13	-13.76	Horizontal
3296.8	-51.78	4.02	29.87	-25.93	-13	-12.93	Vertical
3296.8	-51.20	4.02	29.87	-25.35	-13	-12.35	Horizontal
Test Results for Channel 189/836.4 MHz							
1672.8	-51.77	2.80	27.48	-27.09	-13	-14.09	Vertical
1672.8	-51.55	2.80	27.48	-26.87	-13	-13.87	Horizontal
2509.2	-50.83	2.91	27.70	-26.04	-13	-13.04	Vertical
2509.2	-51.46	2.91	27.70	-26.67	-13	-13.67	Horizontal
3345.6	-49.97	4.02	29.82	-24.17	-13	-11.17	Vertical
3345.6	-51.82	4.02	29.82	-26.02	-13	-13.02	Horizontal
Test Results for Channel 251/848.8 MHz							
1697.6	-47.99	2.80	27.42	-23.37	-13	-10.37	Vertical
1697.6	-47.99	2.80	27.42	-23.37	-13	-10.37	Horizontal
2546.4	-51.53	2.91	27.68	-26.76	-13	-13.76	Vertical
2546.4	-49.32	2.91	27.68	-24.55	-13	-11.55	Horizontal
3395.2	-50.60	4.02	29.80	-24.82	-13	-11.82	Vertical
3395.2	-51.71	4.02	29.80	-25.93	-13	-12.93	Horizontal

Remark:

1. We were tested all Configuration refer 3GPP TS134 121.
2. Absolute Level = SG Level- Cable Loss+ Antenna Factor
3. Over Limit= Absolute Level (dBm)-Limit(dBm)

EGPRS 850							
Frequency	SG Level	Cable Loss	Antenna Factor	Absolute Level	Limit	Over Limit	Polarity
(MHz)	(dBm)	(dB)	(dB)	(dBm)	(dBm)	(dBm)	
Test Results for Channel 128/824.2 MHz							
1648.4	-50.35	2.80	27.50	-25.65	-13	-12.65	Vertical
1648.4	-50.62	2.80	27.50	-25.92	-13	-12.92	Horizontal
2472.6	-49.59	2.91	27.80	-24.70	-13	-11.70	Vertical
2472.6	-50.90	2.91	27.80	-26.01	-13	-13.01	Horizontal
3296.8	-53.26	4.02	29.87	-27.41	-13	-14.41	Vertical
3296.8	-48.86	4.02	29.87	-23.01	-13	-10.01	Horizontal
Test Results for Channel 189/836.4 MHz							
1672.8	-51.31	2.80	27.48	-26.63	-13	-13.63	Vertical
1672.8	-51.87	2.80	27.48	-27.19	-13	-14.19	Horizontal
2509.2	-49.01	2.91	27.70	-24.22	-13	-11.22	Vertical
2509.2	-51.87	2.91	27.70	-27.08	-13	-14.08	Horizontal
3345.6	-48.82	4.02	29.82	-23.02	-13	-10.02	Vertical
3345.6	-51.11	4.02	29.82	-25.31	-13	-12.31	Horizontal
Test Results for Channel 251/848.8 MHz							
1697.6	-46.70	2.80	27.42	-22.08	-13	-9.08	Vertical
1697.6	-48.59	2.80	27.42	-23.97	-13	-10.97	Horizontal
2546.4	-51.03	2.91	27.68	-26.26	-13	-13.26	Vertical
2546.4	-49.67	2.91	27.68	-24.90	-13	-11.90	Horizontal
3395.2	-48.57	4.02	29.80	-22.79	-13	-9.79	Vertical
3395.2	-50.30	4.02	29.80	-24.52	-13	-11.52	Horizontal

Remark:

1. We were tested all Configuration refer 3GPP TS134 121.
2. Absolute Level = SG Level- Cable Loss+ Antenna Factor
3. Over Limit= Absolute Level (dBm)-Limit(dBm)

GSM 1900							
Frequency	SG Level	Cable Loss	Antenna Factor	Absolute Level	Limit	Over Limit	Polarity
(MHz)	(dBm)	(dB)	(dB)	(dBm)	(dBm)	(dBm)	
Test Results for Channel 512/1850.2MHz							
3700.4	-50.87	4.04	33.51	-21.40	-13	-8.40	Vertical
3700.4	-48.60	4.04	33.51	-19.13	-13	-6.13	Horizontal
5550.6	-49.91	5.24	35.84	-19.31	-13	-6.31	Vertical
5550.6	-50.31	5.24	35.84	-19.71	-13	-6.71	Horizontal
Test Results for Channel 661/1880.0MHz							
3760	-49.81	4.04	33.56	-20.29	-13	-7.29	Vertical
3760	-52.45	4.04	33.56	-22.93	-13	-9.93	Horizontal
5640	-51.11	5.24	35.91	-20.44	-13	-7.44	Vertical
5640	-50.56	5.24	35.91	-19.89	-13	-6.89	Horizontal
Test Results for Channel 810/1909.8MHz							
3819.6	-50.37	4.04	34.00	-20.41	-13	-7.41	Vertical
3819.6	-49.68	4.04	34.00	-19.72	-13	-6.72	Horizontal
5729.4	-49.30	5.24	36.04	-18.50	-13	-5.50	Vertical
5729.4	-52.45	5.24	36.04	-21.65	-13	-8.65	Horizontal

Remark:

1. We were tested all Configuration refer 3GPP TS134 121.
2. Absolute Level = SG Level- Cable Loss+ Antenna Factor
3. Over Limit= Absolute Level (dBm)-Limit(dBm)

GPRS 1900							
Frequency	SG Level	Cable Loss	Antenna Factor	Absolute Level	Limit	Over Limit	Polarity
(MHz)	(dBm)	(dB)	(dB)	(dBm)	(dBm)	(dBm)	
Test Results for Channel 512/1850.2MHz							
3700.4	-53.04	4.04	33.51	-23.57	-13	-10.57	Vertical
3700.4	-51.01	4.04	33.51	-21.54	-13	-8.54	Horizontal
5550.6	-51.43	5.24	35.84	-20.83	-13	-7.83	Vertical
5550.6	-50.45	5.24	35.84	-19.85	-13	-6.85	Horizontal
Test Results for Channel 661/1880.0MHz							
3760	-54.39	4.04	33.56	-24.87	-13	-11.87	Vertical
3760	-53.27	4.04	33.56	-23.75	-13	-10.75	Horizontal
5640	-51.27	5.24	35.91	-20.60	-13	-7.60	Vertical
5640	-49.86	5.24	35.91	-19.19	-13	-6.19	Horizontal
Test Results for Channel 810/1909.8MHz							
3819.6	-49.30	4.04	34.00	-19.34	-13	-6.34	Vertical
3819.6	-51.18	4.04	34.00	-21.22	-13	-8.22	Horizontal
5729.4	-51.67	5.24	36.04	-20.87	-13	-7.87	Vertical
5729.4	-51.20	5.24	36.04	-20.40	-13	-7.40	Horizontal

Remark:

1. We were tested all Configuration refer 3GPP TS134 121.
2. Absolute Level = SG Level- Cable Loss+ Antenna Factor
3. Over Limit= Absolute Level (dBm)-Limit(dBm)

EGPRS 1900							
Frequency	SG Level	Cable Loss	Antenna Factor	Absolute Level	Limit	Over Limit	Polarity
(MHz)	(dBm)	(dB)	(dB)	(dBm)	(dBm)	(dBm)	
Test Results for Channel 512/1850.2MHz							
3700.4	-51.82	4.04	33.51	-22.35	-13	-9.35	Vertical
3700.4	-51.10	4.04	33.51	-21.63	-13	-8.63	Horizontal
5550.6	-53.42	5.24	35.84	-22.82	-13	-9.82	Vertical
5550.6	-50.65	5.24	35.84	-20.05	-13	-7.05	Horizontal
Test Results for Channel 661/1880.0MHz							
3760	-53.78	4.04	33.56	-24.26	-13	-11.26	Vertical
3760	-52.04	4.04	33.56	-22.52	-13	-9.52	Horizontal
5640	-51.64	5.24	35.91	-20.97	-13	-7.97	Vertical
5640	-50.18	5.24	35.91	-19.51	-13	-6.51	Horizontal
Test Results for Channel 810/1909.8MHz							
3819.6	-49.71	4.04	34.00	-19.75	-13	-6.75	Vertical
3819.6	-52.02	4.04	34.00	-22.06	-13	-9.06	Horizontal
5729.4	-52.76	5.24	36.04	-21.96	-13	-8.96	Vertical
5729.4	-52.13	5.24	36.04	-21.33	-13	-8.33	Horizontal

Remark:

1. We were tested all Configuration refer 3GPP TS134 121.
2. Absolute Level = SG Level- Cable Loss+ Antenna Factor
3. Over Limit= Absolute Level (dBm)-Limit(dBm)

WCDMA Band II							
Frequency	SG Level	Cable Loss	Antenna Factor	Absolute Level	Limit	Over Limit	Polarity
(MHz)	(dBm)	(dB)	(dB)	(dBm)	(dBm)	(dBm)	
Test Results for Channel 9262/1852.4MHz							
3700.8	-53.26	4.04	33.51	-23.79	-13	-10.79	Vertical
3700.8	-53.50	4.04	33.51	-24.03	-13	-11.03	Horizontal
5551.2	-52.48	5.24	35.84	-21.88	-13	-8.88	Vertical
5551.2	-49.44	5.24	35.84	-18.84	-13	-5.84	Horizontal
Test Results for Channel 9400/1880MHz							
3760	-53.78	4.04	33.56	-24.26	-13	-11.26	Vertical
3760	-51.43	4.04	33.56	-21.91	-13	-8.91	Horizontal
5640	-49.90	5.24	35.91	-19.23	-13	-6.23	Vertical
5640	-51.43	5.24	35.91	-20.76	-13	-7.76	Horizontal
Test Results for Channel 9538/1907.6MHz							
3819.2	-52.25	4.04	34.00	-22.29	-13	-9.29	Vertical
3819.2	-48.16	4.04	34.00	-18.20	-13	-5.20	Horizontal
5728.8	-52.91	5.24	36.04	-22.11	-13	-9.11	Vertical
5728.8	-52.06	5.24	36.04	-21.26	-13	-8.26	Horizontal

Remark:

1. We were tested all Configuration refer 3GPP TS134 121.
2. Absolute Level = SG Level- Cable Loss+ Antenna Factor
3. Over Limit= Absolute Level (dBm)-Limit(dBm)

WCDMA Band V							
Frequency	SG Level	Cable Loss	Antenna Factor	Absolute Level	Limit	Over Limit	Polarity
(MHz)	(dBm)	(dB)	(dB)	(dBm)	(dBm)	(dBm)	
Test Results for Channel 4233/846.6MHz							
1673.2	-49.49	2.80	27.50	-24.79	-13	-11.79	Vertical
1673.2	-49.25	2.80	27.50	-24.55	-13	-11.55	Horizontal
2509.8	-48.38	2.91	27.80	-23.49	-13	-10.49	Vertical
2509.8	-52.88	2.91	27.80	-27.99	-13	-14.99	Horizontal
3346.4	-49.09	4.02	29.87	-23.24	-13	-10.24	Vertical
3346.4	-49.01	4.02	29.87	-23.16	-13	-10.16	Horizontal
Test Results for Channel 4182/836.4MHz							
1672.8	-47.88	2.80	27.48	-23.20	-13	-10.20	Vertical
1672.8	-50.56	2.80	27.48	-25.88	-13	-12.88	Horizontal
2509.2	-51.72	2.91	27.70	-26.93	-13	-13.93	Vertical
2509.2	-50.84	2.91	27.70	-26.05	-13	-13.05	Horizontal
3345.6	-48.14	4.02	29.82	-22.34	-13	-9.34	Vertical
3345.6	-51.14	4.02	29.82	-25.34	-13	-12.34	Horizontal
Test Results for Channel 4132/826.4MHz							
1652.8	-54.84	2.80	27.42	-30.22	-13	-17.22	Vertical
1652.8	-47.79	2.80	27.42	-23.17	-13	-10.17	Horizontal
2479.2	-51.54	2.91	27.68	-26.77	-13	-13.77	Vertical
2479.2	-52.79	2.91	27.68	-28.02	-13	-15.02	Horizontal
3305.6	-51.36	4.02	29.80	-25.58	-13	-12.58	Vertical
3305.6	-52.04	4.02	29.80	-26.26	-13	-13.26	Horizontal

Remark:

1. We were tested all Configuration refer 3GPP TS134 121.
2. Absolute Level = SG Level- Cable Loss+ Antenna Factor
3. Over Limit= Absolute Level (dBm)-Limit(dBm)

WCDMA Band IV							
Frequency	SG Level	Cable Loss	Antenna Factor	Absolute Level	Limit	Over Limit	Polarity
(MHz)	(dBm)	(dB)	(dB)	(dBm)	(dBm)	(dBm)	
Test Results for Channel 1312/1712.4MHz							
3424.8	-55.64	4.01	33.51	-26.14	-13	-13.14	Vertical
3424.8	-55.40	4.01	33.51	-25.90	-13	-12.90	Horizontal
5137.2	-54.25	5.13	35.84	-23.54	-13	-10.54	Vertical
5137.2	-54.08	5.13	35.84	-23.37	-13	-10.37	Horizontal
Test Results for Channel 1412/1732.4MHz							
3465.2	-54.19	4.02	33.56	-24.65	-13	-11.65	Vertical
3465.2	-54.36	4.02	33.56	-24.82	-13	-11.82	Horizontal
5197.8	-52.98	5.19	35.91	-22.26	-13	-9.26	Vertical
5197.8	-52.67	5.19	35.91	-21.95	-13	-8.95	Horizontal
Test Results for Channel 1513/1752.6MHz							
3505.2	-53.43	4.03	34.00	-23.46	-13	-10.46	Vertical
3505.2	-53.59	4.03	34.00	-23.62	-13	-10.62	Horizontal
5257.8	-53.95	5.18	36.04	-23.09	-13	-10.09	Vertical
5257.8	-54.15	5.18	36.04	-23.29	-13	-10.29	Horizontal

Remark:

1. We were tested all Configuration refer 3GPP TS134 121.
2. Absolute Level = SG Level- Cable Loss+ Antenna Factor
3. Over Limit= Absolute Level (dBm)-Limit(dBm)

7.2 EFFECTIVE RADIATED POWER AND EFFECTIVE ISOTROPIC RADIATED POWER

7.2.1 Applicable Standard

According to FCC KDB 971168 D01 v03r01 Section 5.2.1/ Section 5.2.2.2 and ANSI/TIA-603-E-2016 Section 2.2.17

7.2.2 Conformance Limit

The substitution method, in ANSI/TIA-603-E-2016, was used for ERP/EIRP measurement, and the spectrum analyzer configuration follows KDB 971168 D01 Power Meas. License Digital Systems v03r01. The ERP of mobile transmitters must not exceed 7 Watts (Cellular Band) and the EIRP of mobile transmitters are limited to 2 Watts (PCS Band), and the EIRP of mobile transmitters are limited to 1 Watts (PCS Band)

7.2.3 Measuring Instruments

The Measuring equipment is listed in the section 6.3 of this test report.

7.2.4 Test Configuration

Reference 7.1.4

7.2.5 Test Procedure

The measurements procedures specified in ANSI/TIA-603-E-2016 were applied. In an anechoic antenna test chamber, a half-wave dipole antenna for the frequency band of interest is placed at the reference centre of the chamber. An RF Signal source for the frequency band of interest is connected to the dipole with a cable that has been constructed to not interfere with the radiation pattern of the antenna. A known (measured) power (P_{in}) is applied to the input of the dipole, and the power received (P_r) at the chamber's probe antenna is recorded.

The relevant equation for determining the ERP or EIRP from the conducted RF output power measured using the guidance provided above is:

$$ERP/EIRP = SGLevel - P_{cl} + G_a$$

where:

ERP/EIRP = effective or equivalent radiated power, respectively (expressed in the same units as SGLevel, typically dBW or dBm);

SGLevel = Signal generator output power or PSD, in dBm or dBW;

G_a = gain of the transmitting antenna, in dBd (ERP) or dBi (EIRP);

P_{cl} = signal attenuation in the connecting cable between the transmitter and antenna, in dB.²

The EUT is substituted for the dipole at the reference centre of the chamber and a scan is performed to obtain the radiation pattern.

From the radiation pattern, the co-ordinates where the maximum antenna gain occurs are identified.

The EUT is then put into continuously transmitting mode at its maximum power level.

Power mode measurements are performed with the receiving antenna placed at the coordinates determined in Step 3 to determine the output power as defined in Rule 24.232 (b) and (c). The "reference path loss" from Step1 is added to this result.

This value is EIRP since the measurement is calibrated using a half-wave dipole antenna of known gain (2.15 dBi) and known input power (P_{in}).

ERP can be calculated from EIRP by subtracting the gain of the dipole, $ERP = EIRP - 2.15dBi$.

Both horizontal and vertical antenna polarities were tested and performed pretest to three orthogonal axis. The worst case emissions were reported.

Substitution antenna and Receiving Antenna:

Item	Kind of Equipment	Manufacturer	Type No.	Serial No.	Character	Note
1	Bilog Antenna	TESEQ	CV6011D	31216	30MHz~2GHz	Receiving Antenna
2	Horn Antenna	EM	EM-AH-10180	2011071402	1GHz~18GHz	Receiving Antenna
3	Bilog Antenna	TESEQ	CV6011D	31216	30MHz~2GHz	Substitution antenna
4	Horn Antenna	EM	EM-AH-10180	2011071402	1GHz~18GHz	Substitution antenna

Use the following spectrum analyzer settings:

	GSM/GPRS/EGPRS	UMTS band
Span	500KHz	10MHz
RBW	10KHz	300KHz
VBW	30KHz	1MHz
Detector	RMS	RMS
Trace	Average	Average
Average Type	Power	Power
Sweep Count	100	100

7.2.6 Test Results

EUT:	Mobile Phone	Model No.:	V60
Temperature:	20 °C	Relative Humidity:	48%
Test Mode:	GSM/GPRS/EGPRS 850/ GSM/GPRS/EGPRS 1900 UMTS band II/ UMTS band V/ UMTS band IV	Test By:	Mary Hu

■ Effective Radiated Power

Radiated Power (ERP) for GSM850							
Frequency	Polarization	SG Level	Pcl	Ga Factor Gain	Correction	ERP	ERP
(MHz)		(dBm)	(dB)	(dB)	(dB)	(dBm)	(W)
824.2	H	11.96	2.11	23.84	2.15	31.54	1.42561
836.4	H	11.59	2.13	23.15	2.15	30.46	1.11173
848.8	H	12.15	2.13	23.06	2.15	30.93	1.23745
824.2	V	12.76	2.11	23.11	2.15	31.61	1.44877
836.4	V	12.16	2.13	23.07	2.15	30.95	1.24451
848.8	V	11.64	2.13	23.25	2.15	30.61	1.15080

Radiated Power (ERP) for GPRS850							
Frequency	Polarization	SG Level	Pcl	Ga Factor Gain	Correction	ERP	ERP
(MHz)		(dBm)	(dB)	(dB)	(dB)	(dBm)	(W)
824.2	H	12.24	2.11	23.84	2.15	31.82	1.52055
836.4	H	12.37	2.13	23.15	2.15	31.24	1.33045
848.8	H	12.61	2.13	23.06	2.15	31.39	1.37721
824.2	V	12.63	2.11	23.11	2.15	31.48	1.40605
836.4	V	12.72	2.13	23.07	2.15	31.51	1.41579
848.8	V	12.64	2.13	23.25	2.15	31.61	1.44877

Radiated Power (ERP) for EGPRS850							
Frequency	Polarization	SG Level	Pcl	Ga Factor Gain	Correction	ERP	ERP
(MHz)		(dBm)	(dB)	(dB)	(dB)	(dBm)	(W)
824.2	H	10.99	2.11	23.84	2.15	30.57	1.14154
836.6	H	11.61	2.13	23.15	2.15	30.48	1.11567
848.8	H	11.74	2.13	23.06	2.15	30.52	1.12669
824.2	V	12.04	2.11	23.11	2.15	30.89	1.22652
836.6	V	11.99	2.13	23.07	2.15	30.78	1.19559
848.8	V	11.44	2.13	23.25	2.15	30.41	1.09802

Radiated Power (ERP) for UMTS band V							
Frequency	Polarization	SG Level	Pcl	Ga Factor Gain	Correction	ERP	ERP
(MHz)		(dBm)	(dB)	(dB)	(dB)	(dBm)	(W)
826.4	H	0.90	2.11	23.84	2.15	20.48	0.11169
835	H	0.92	2.13	23.15	2.15	19.79	0.09528
846.6	H	0.90	2.13	23.06	2.15	19.68	0.09290
826.4	V	0.87	2.11	23.11	2.15	19.72	0.09376
835	V	0.88	2.13	23.07	2.15	19.67	0.09268
846.6	V	0.87	2.13	23.25	2.15	19.84	0.09638

Note:

SG Level= Signal generator output

Pcl= cable loss

Ga= Factor Gain

Peak EIRP(dBm)= SGLevel -Pcl +Ga

ERP(dBm)=EIRP-2.15

■ Effective Isotropic Radiated Power

Radiated Power (E.I.R.P) for GSM1900						
Frequency	Polarization	SG Level	Pcl	Ga Factor Gain	EIRP	EIRP
(MHz)		(dBm)	(dB)	(dB)	(dBm)	(W)
1850.2	H	5.42	3.76	28.24	29.90	0.97724
1880	H	5.45	3.91	28.22	29.76	0.94624
1909.8	H	6.12	3.93	28.20	30.39	1.09396
1850.2	V	5.56	3.76	27.32	29.12	0.81658
1880	V	5.54	3.91	27.33	28.96	0.78705
1909.8	V	6.26	3.93	27.31	29.64	0.92045

Radiated Power (E.I.R.P) for GPRS1900						
Frequency	Polarization	SG Level	Pcl	Ga Factor Gain	EIRP	EIRP
(MHz)		(dBm)	(dB)	(dB)	(dBm)	(W)
1850.2	H	5.47	3.76	28.24	29.95	0.98855
1880	H	5.50	3.91	28.22	29.81	0.95719
1909.8	H	5.91	3.93	28.20	30.18	1.04232
1850.2	V	5.94	3.76	27.32	29.50	0.89125
1880	V	5.73	3.91	27.33	29.15	0.82224
1909.8	V	5.42	3.93	27.31	28.80	0.75858

Radiated Power (E.I.R.P) for EGPRS1900						
Frequency	Polarization	SG Level	Pcl	Ga Factor Gain	EIRP	EIRP
(MHz)		(dBm)	(dB)	(dB)	(dBm)	(W)
1850.2	H	4.60	3.76	28.24	29.08	0.80906
1880	H	3.58	3.91	28.22	27.89	0.61577
1909.8	H	4.24	3.93	28.20	28.51	0.70991
1850.2	V	4.33	3.76	27.32	27.89	0.61451
1880	V	4.27	3.91	27.33	27.69	0.58716
1909.8	V	3.90	3.93	27.31	27.28	0.53437

Radiated Power (E.I.R.P) for UMTS band II						
Frequency	Polarization	SG	Pcl	Ga	EIRP	EIRP
(MHz)		Level	(dB)	Factor Gain	(dBm)	(W)
1852.4	H	-2.53	3.76	28.24	21.95	0.15668
1880	H	-2.67	3.91	28.22	21.64	0.14588
1907.6	H	-2.64	3.93	28.20	21.63	0.14555
1852.4	V	-2.26	3.76	27.32	21.3	0.13490
1880	V	-2.22	3.91	27.33	21.2	0.13183
1907.6	V	-2.30	3.93	27.31	21.08	0.12823

Note:

SG Level= Signal generator output

Pcl= cable loss

Ga= Antenna Gain

Peak EIRP(dBm)= SGLevel –Pcl+Ga.

Radiated Power (E.I.R.P) for UMTS band IV						
Frequency	Polarization	SG	Pcl	Ga	EIRP	EIRP
(MHz)		Level				
1712.4	H	-1.25	3.72	28.24	23.27	0.21232
1732.6	H	-1.71	3.90	28.22	22.61	0.18239
1752.6	H	-1.67	3.91	28.20	22.62	0.18281
1712.4	V	-1.77	3.76	27.32	21.79	0.15101
1732.6	V	-1.70	3.89	27.33	21.74	0.14928
1752.6	V	-1.77	3.92	27.31	21.62	0.14521

Note:

SG Level= Signal generator output

Pcl= cable loss

Ga= Factor Gain

Peak EIRP(dBm)= SGLevel –Pcl+Ga.

7.3 CONDUCTED OUTPUT POWER

7.3.1 Applicable Standard

According to FCC Part 2.1046 and FCC Part 22.913(a)(2) and FCC Part 24.232(c) and FCC KDB 971168 D01 v03r01 Section 5.2

7.3.2 Conformance Limit

Extend coverage on a secondary basis into cellular unserved areas, as those areas are defined in §22.949, the ERP of base transmitters and cellular repeaters of such systems must not exceed 1000 Watts. The ERP of mobile transmitters and auxiliary test transmitters must not exceed 7 Watts(38.5dBm).

Mobile and portable stations are limited to 2 watts (33dBm)EIRP and the equipment must employ a means for limiting power to the minimum necessary for successful communications..

7.3.3 Measuring Instruments

The Measuring equipment is listed in the section 6.3 of this test report.

7.3.4 Test Setup

Please refer to Section 6.1 of this test report.

7.3.5 Test Procedure

Connect the EUT to Universal Radio Communication Tester CMU200 or CMU500 via the antenna connector. A call is set up by the SS according to the generic call set up procedure on a channel with ARFCN in the ARFCN range, power control level set to Max power. The frequency band is set as selected frequency, The RF output of the transmitter was connected to base station simulator.

Set EUT at maximum average power by base station simulator.

Set RBW = 1-5% of the OBW, not to exceed 1 MHz.

Set VBW $\geq 3 \times$ RBW.

Number of points in sweep $\geq 2 \times$ span / RBW. (This gives bin-to-bin spacing \leq RBW/2, so that narrowband signals are not lost between frequency bins.)

Sweep time = auto.

Detector = RMS (power averaging).

Set sweep trigger to "free run".

Trace average at least 100 traces in power averaging (i.e., RMS) mode; however, the number of traces to be averaged shall be increased above 100 as needed such that the average accurately represents the true average over the on and off periods of the transmitter.

Compute power by integrating the spectrum across the OBW of the signal using the instrument's band power measurement function with band limits set equal to the OBW band edges. If the instrument does not have a band power function, sum the spectrum levels (in power units) at intervals equal to the RBW extending across the entire OBW of the spectrum.

Add $10 \log(1/x)$, where x is the duty cycle, to the measured power in order to compute the average power during the actual transmission times (because the measurement represents an average over both the on and off times of the transmission). For example, add $10 \log(1/0.25) = 6$ dB if the duty cycle is a constant 25%.

Measure lowest, middle, and highest channels for each bandwidth and different modulation.

Measure and record the results in the test report.

7.3.6 Test Results

EUT:	Mobile Phone	Model No.:	V60
Temperature:	20 °C	Relative Humidity:	48%
Test Mode:	GSM/GPRS/EGPRS 850/ GSM/GPRS/EGPRS 1900 UMTS band II/ UMTS band V/ UMTS band IV	Test By:	Mary Hu

Test data reference attachment

7.4 FREQUENCY STABILITY

7.4.1 Applicable Standard

According to FCC Part 2.1055 and FCC Part 22.355 and FCC Part 24.235 and FCC KDB 971168 D01 Section 9.0

7.4.2 Conformance Limit

The frequency stability shall be measured by variation of ambient temperature and variation of primary supply voltage to ensure that the fundamental emission stays within the authorized frequency block. The frequency stability of the transmitter shall be maintained within $\pm 0.00025\%$ ($\pm 2.5\text{ppm}$) of the center frequency.

7.4.3 Measuring Instruments

The Measuring equipment is listed in the section 6.3 of this test report.

7.4.4 Test Setup

Please refer to Section 6.1 of this test report.

7.4.5 Test Procedure

Connect the EUT to Universal Radio Communication Tester CMU200 or CMU500 via the antenna connector. A call is set up by the SS according to the generic call set up procedure on a channel with ARFCN in the ARFCN range, power control level set to Max power. MS TXPWR_MAX_CCH is set to the maximum value supported by the Power Class of the Mobile under test.

EUT was placed at temperature chamber and connected to an external power supply.

Temperature and voltage condition shall be tested to confirm frequency stability.

For Temperature Variation

1. The testing follows FCC KDB 971168 D01 v03r01 Section 9.0.
2. The EUT was set up in the thermal chamber and connected with the system simulator.
3. With power OFF, the temperature was decreased to -30°C and the EUT was stabilized before testing. Power was applied and the maximum change in frequency was recorded within one minute.
4. With power OFF, the temperature was raised in 10°C steps up to 50°C . The EUT was stabilized at each step for at least half an hour. Power was applied and the maximum frequency change was recorded within one minute.

For Voltage Variation

1. The testing follows FCC KDB 971168 D01 v03r01 Section 9.0.
2. The EUT was placed in a temperature chamber at $25\pm 5^{\circ}\text{C}$ and connected with the system simulator.
3. The power supply voltage to the EUT was varied from 85% to 115% of the nominal value measured at the input to the EUT.
4. The variation in frequency was measured for the worst case.

7.4.6 Test Results

EUT:	Mobile Phone	Model No.:	V60
Temperature:	20 °C	Relative Humidity:	48%
Test Mode:	GSM/GPRS/EGPRS 850/ GSM/GPRS/EGPRS 1900 UMTS band II/ UMTS band V/ UMTS band IV	Test By:	Mary Hu
Results: PASS			

Frequency Error Against Voltage for GSM 850 band CH189		
Voltage (V)	Frequency Error (Hz)	Frequency Error (ppm)
3.4	8	0.00956
3.8	7	0.00837
4.4	4	0.00478

Frequency Error Against Temperature for GSM 850 band CH189		
Temperature (°C)	Frequency Error (Hz)	Frequency Error (ppm)
-30	6	0.00717
-20	7	0.00837
-10	4	0.00478
0	13	0.01554
10	9	0.01076
20	8	0.00956
30	7	0.00837
40	10	0.01196
50	5	0.00598

Frequency Error Against Voltage for GPRS850 band CH189		
Voltage (V)	Frequency Error (Hz)	Frequency Error (ppm)
3.4	14	0.01674
3.8	11	0.01315
4.4	5	0.00598

Frequency Error Against Temperature for GPRS850 band CH189		
Temperature (°C)	Frequency Error (Hz)	Frequency Error (ppm)
-30	8	0.00956
-20	8	0.00956
-10	7	0.00837
0	6	0.00717
10	16	0.01913
20	3	0.00359
30	7	0.00837
40	1	0.00120
50	6	0.00717

Frequency Error Against Voltage for EGPRS850 band CH189		
Voltage (V)	Frequency Error (Hz)	Frequency Error (ppm)
3.4	10	0.01196
3.8	5	0.00598
4.4	15	0.01793

Frequency Error Against Temperature for EGPRS850 band CH189		
Temperature (°C)	Frequency Error (Hz)	Frequency Error (ppm)
-30	18	0.02152
-20	14	0.01674
-10	11	0.01315
0	11	0.01315
10	10	0.01196
20	8	0.00956
30	5	0.00598
40	8	0.00956
50	7	0.00837

Note:

1. Normal Voltage = 3.8V; Battery End Point (BEP) = 3.4V; Maximum Voltage = 4.4V
2. The frequency fundamental emissions stay within the authorized frequency block based on the frequency deviation measured is small.

Frequency Error Against Voltage for PCS 1900 band CH 661		
Voltage (V)	Frequency Error (Hz)	Frequency Error (ppm)
3.4	11	0.00585
3.8	15	0.00798
4.4	2	0.00106

Frequency Error Against Temperature for PCS 1900 band CH 661		
Temperature (°C)	Frequency Error (Hz)	Frequency Error (ppm)
-30	11	0.00585
-20	6	0.00319
-10	16	0.00851
0	10	0.00532
10	3	0.00160
20	8	0.00426
30	13	0.00691
40	9	0.00479
50	8	0.00426

Frequency Error Against Voltage for GPRS1900 band CH 661		
Voltage (V)	Frequency Error (Hz)	Frequency Error (ppm)
3.4	12	0.00638
3.8	15	0.00798
4.4	11	0.00585

Frequency Error Against Temperature for GPRS1900 band CH 661		
Temperature (°C)	Frequency Error (Hz)	Frequency Error (ppm)
-30	11	0.00585
-20	13	0.00691
-10	2	0.00106
0	9	0.00479
10	9	0.00479
20	16	0.00851
30	1	0.00053
40	10	0.00532
50	15	0.00798

Frequency Error Against Voltage for EGPRS1900 band CH 661		
Voltage (V)	Frequency Error (Hz)	Frequency Error (ppm)
3.4	11	0.00585
3.8	5	0.00266
4.4	5	0.00266

Frequency Error Against Temperature for EGPRS1900 band CH 661		
Temperature (°C)	Frequency Error (Hz)	Frequency Error (ppm)
-30	10	0.00532
-20	2	0.00106
-10	1	0.00053
0	8	0.00426
10	7	0.00372
20	5	0.00266
30	6	0.00319
40	7	0.00372
50	3	0.00160

Frequency Error Against Voltage for UMTS band II CH 9400		
Voltage (V)	Frequency Error (Hz)	Frequency Error (ppm)
3.4	5	0.00266
3.8	8	0.00426
4.4	7	0.00372

Frequency Error Against Temperature for UMTS band II CH 9400		
Temperature (°C)	Frequency Error (Hz)	Frequency Error (ppm)
-30	9	0.00479
-20	8	0.00426
-10	13	0.00691
0	3	0.00160
10	8	0.00426
20	5	0.00266
30	7	0.00372
40	8	0.00426
50	11	0.00585

Frequency Error Against Voltage for UMTS band V CH 4182		
Voltage (V)	Frequency Error (Hz)	Frequency Error (ppm)
3.4	14	0.01673
3.8	3	0.00359
4.4	10	0.01195

Frequency Error Against Temperature for UMTS band V CH 4182		
Temperature (°C)	Frequency Error (Hz)	Frequency Error (ppm)
-30	3	0.00359
-20	15	0.01793
-10	2	0.00239
0	13	0.01554
10	5	0.00598
20	11	0.01315
30	11	0.01315
40	3	0.00359
50	11	0.01315

Note:

1. Normal Voltage = 3.8V; Battery End Point (BEP) = 3.4V; Maximum Voltage = 4.4V
2. The frequency fundamental emissions stay within the authorized frequency block based on the frequency deviation measured is small.

Frequency Error Against Voltage for UMTS band IVCH 1413		
Voltage (V)	Frequency Error (Hz)	Frequency Error (ppm)
3.4	11	0.00635
3.8	10	0.00577
4.4	17	0.00981

Frequency Error Against Temperature for UMTS band IVCH 1413		
Temperature (°C)	Frequency Error (Hz)	Frequency Error (ppm)
-30	10	0.00577
-20	15	0.00866
-10	7	0.00404
0	12	0.00693
10	14	0.00808
20	9	0.00520
30	17	0.00981
40	4	0.00231
50	9	0.00520

Note:

1. Normal Voltage = 3.85V; Battery End Point (BEP) = 3.4V; Maximum Voltage = 4.4V
2. The frequency fundamental emissions stay within the authorized frequency block based on the frequency deviation measured is small.

7.5 PEAK-TO-AVERAGE RATIO

7.5.1 Applicable Standard

According to FCC 22.913 and FCC 24.232(d) and FCC KDB 971168 D01 Section 5.7.1

7.5.2 Conformance Limit

The peak-to-average power ratio (PAPR) of the transmitter output power must not exceed 13 dB. The PAPR measurements should be made using either an instrument with complementary cumulative distribution function (CCDF) capabilities to determine that PAPR will not exceed 13 dB for more than 0.1 percent of the time or other Commission approved procedure. The measurement must be performed using a signal corresponding to the highest PAPR expected during periods of continuous transmission.

7.5.3 Measuring Instruments

The Measuring equipment is listed in the section 6.3 of this test report.

7.5.4 Test Setup

Please refer to Section 6.1 of this test report.

7.5.5 Test Procedure

The EUT was connected to Spectrum Analyzer and Base Station via power divider.
 The RF output of EUT was connected to the spectrum analyzer by RF cable and attenuator. The path loss was compensated to the results for each measurement.
 Set the number of counts to a value that stabilizes the measured CCDF curve.
 Set the measurement interval to 1 ms.
 Record the maximum PAPR level associated with a probability of 0.1%.
 a) Refer to instrument's analyzer instruction manual for details on how to use the power statistics/CCDF function;
 b) Set resolution/measurement bandwidth \geq signal's occupied bandwidth;
 c) Set the number of counts to a value that stabilizes the measured CCDF curve;
 d) Set the measurement interval as follows:
 1) for continuous transmissions, set to 1 ms,
 2) for burst transmissions, employ an external trigger that is synchronized with the EUT burst timing sequence, or use the internal burst trigger with a trigger level that allows the burst to stabilize and set the measurement interval to a time that is less than or equal to the burst duration.
 e) Record the maximum PAPR level associated with a probability of 0.1%.

7.5.6 Test Results

EUT:	Mobile Phone	Model No.:	V60
Temperature:	20 °C	Relative Humidity:	48%
Test Mode:	GSM/GPRS/EGPRS 850/ GSM/GPRS/EGPRS 1900 UMTS band II/ UMTS band V/ UMTS band IV	Test By:	Mary Hu
Results: PASS			

Test data reference attachment

7.6 26DB BANDWIDTH AND 99% OCCUPIED BANDWIDTH

7.6.1 Applicable Standard

According to FCC Part 2.1049 and FCC Part 22H and FCC Part 24E and FCC KDB 971168 D01 Section 4.0

7.6.2 Conformance Limit

The occupied bandwidth is the width of a frequency band such that, below the lower and above the upper frequency limits, the mean powers emitted are each equal to a specified percentage 0.5% of the total mean transmitted power.

The 26 dB emission bandwidth is defined as the frequency range between two points, one above and one below the carrier frequency, at which the spectral density of the emission is attenuated 26 dB below the maximum in-band spectral density of the modulated signal. Spectral density (power per unit bandwidth) is to be measured with a detector of resolution bandwidth equal to approximately 1.0% of the emission bandwidth.

7.6.3 Measuring Instruments

The Measuring equipment is listed in the section 6.3 of this test report.

7.6.4 Test Setup

Please refer to Section 6.1 of this test report.

7.6.5 Test Procedure

The testing follows FCC KDB 971168 v03r01 Section 4.0.

The EUT was connected to Spectrum Analyzer and Base Station via power divider.

The RF output of EUT was connected to the spectrum analyzer by RF cable and attenuator. The path loss was compensated to the results for each measurement.

The spectrum analyzer center frequency is set to the nominal EUT channel center frequency. The span range for the spectrum analyzer shall be between two and five times the anticipated OBW.

The nominal resolution bandwidth (RBW) shall be in the range of 1 to 5 % of the anticipated OBW, and the VBW shall be at least 3 times the RBW.

Set the detection mode to peak, and the trace mode to max hold.

Determine the reference value: Set the EUT to transmit a modulated signal. Allow the trace to stabilize. Set the spectrum analyzer marker to the highest level of the displayed trace.

(this is the reference value)

Determine the “-26 dB down amplitude” as equal to (Reference Value – X).

Place two markers, one at the lowest and the other at the highest frequency of the envelope of the spectral display such that each marker is at or slightly below the “-X dB down amplitude” determined in step 6. If a marker is below this “-X dB down amplitude” value it shall be placed as close as possible to this value. The OBW is the positive frequency difference between the two markers.

Use the 99 % power bandwidth function of the spectrum analyzer and report the measured bandwidth.

7.6.6 Test Results

EUT:	Mobile Phone	Model No.:	V60
Temperature:	20 °C	Relative Humidity:	48%
Test Mode:	GSM/GPRS/EGPRS 850/ GSM/GPRS/EGPRS 1900 UMTS band II/ UMTS band V/ UMTS band IV	Test By:	Mary Hu
Results: PASS			

Test data reference attachment

7.7 CONDUCTED BAND EDGE

7.7.1 Applicable Standard

According to FCC Part 2.1051 and FCC Part 22.917(a) and 24.238(a) and FCC KDB 971168 D01 Section 6.0

7.7.2 Conformance Limit

The power of any emission outside of the authorized operating frequency ranges must be lower than the transmitter power (P) by a factor of at least $43 + 10 \log (P)$ dB.

7.7.3 Measuring Instruments

The Measuring equipment is listed in the section 6.3 of this test report.

7.7.4 Test Setup

Please refer to Section 6.1 of this test report.

7.7.5 Test Procedure

The testing follows FCC KDB 971168 v03r01 Section 6.0.
 The EUT was connected to Spectrum Analyzer and Base Station via power divider.
 The RF output of EUT was connected to the spectrum analyzer by RF cable and attenuator.
 The path loss was compensated to the results for each measurement.
 The band edges of low and high channels for the highest RF powers were measured.
 The RF fundamental frequency should be excluded against the limit line in the operating frequency band.
 The limit line is derived from $43 + 10\log(P)$ dB below the transmitter power P(Watts)
 $= P(W) - [43 + 10\log(P)]$ (dB)
 $= [30 + 10\log(P)]$ (dBm) - $[43 + 10\log(P)]$ (dB)
 $= -13\text{dBm}$.

7.7.6 Test Results

EUT:	Mobile Phone	Model No.:	V60
Temperature:	20 °C	Relative Humidity:	48%
Test Mode:	GSM/GPRS/EGPRS 850/ GSM/GPRS/EGPRS 1900 UMTS band II/ UMTS band V/ UMTS band IV	Test By:	Mary Hu
Results: PASS			

Test data reference attachment

7.8 CONDUCTED SPURIOUS EMISSION AT ANTENNA TERMINAL

7.8.1 Applicable Standard

According to FCC Part 2.1051 and FCC Part 22.917(a) and Part 24.238(a) and FCC KDB 971168 D01 Section 6.0

7.8.2 Conformance Limit

The power of any emission outside of the authorized operating frequency ranges must be lower than the transmitter power (P) by a factor of at least $43 + 10 \log(P)$ dB.
It is measured by means of a calibrated spectrum analyzer and scanned from 30 MHz up to a frequency including its 10th harmonic.

7.8.3 Measuring Instruments

The Measuring equipment is listed in the section 6.3 of this test report.

7.8.4 Test Setup

Please refer to Section 6.1 of this test report.

7.8.5 Test Procedure

The testing follows FCC KDB 971168 v03r01 Section 6.0.
The EUT was connected to Spectrum Analyzer and Base Station via power divider.
The RF output of EUT was connected to the spectrum analyzer by RF cable and attenuator.
The path loss was compensated to the results for each measurement.
The middle channel for the highest RF power within the transmitting frequency was measured.
The conducted spurious emission for the whole frequency range was taken.
The RF fundamental frequency should be excluded against the limit line in the operating frequency band.
The limit line is derived from $43 + 10\log(P)$ dB below the transmitter power P(Watts)
 $= P(W) - [43 + 10\log(P)]$ (dB)
 $= [30 + 10\log(P)]$ (dBm) - $[43 + 10\log(P)]$ (dB)
 $= -13\text{dBm}$.

7.8.6 Test Results

EUT:	Mobile Phone	Model No.:	V60
Temperature:	20 °C	Relative Humidity:	48%
Test Mode:	GSM/GPRS/EGPRS 850/ GSM/GPRS/EGPRS 1900 UMTS band II/ UMTS band V/ UMTS band IV	Test By:	Mary Hu
Results: PASS			

Test data reference attachment

8 TEST RESULTS

8.1 CONDUCTED OUTPUT POWER

Band	Channel	Frequency (MHz)	Power (dBm)	Verdict
WCDMA Band2	9262	1852.4	21.90	PASS
WCDMA Band2	9400	1880	21.89	PASS
WCDMA Band2	9538	1907.6	21.87	PASS
WCDMA Band4	1312	1712.4	22.42	PASS
WCDMA Band4	1413	1732.6	22.40	PASS
WCDMA Band4	1513	1752.6	22.38	PASS
WCDMA Band5	4132	826.4	22.13	PASS
WCDMA Band5	4182	836.4	22.12	PASS
WCDMA Band5	4233	846.6	22.74	PASS
GSM1900	512	1850.2	29.79	PASS
GSM1900	661	1880	29.73	PASS
GSM1900	810	1909.8	29.72	PASS
GSM850	128	824.2	32.34	PASS
GSM850	189	836.4	32.44	PASS
GSM850	251	848.8	32.28	PASS

8.2 PEAK-TO-AVERAGE RATIO

Band	Channel	Frequency (MHz)	Result (dB)	high Limit (dB)	Verdict
WCDMA Band2	9262	1852.4	2.87	13	PASS
WCDMA Band2	9400	1880	2.89	13	PASS
WCDMA Band2	9538	1907.6	2.81	13	PASS
WCDMA Band4	1312	1712.4	3.03	13	PASS
WCDMA Band4	1413	1732.6	2.99	13	PASS
WCDMA Band4	1513	1752.6	3.02	13	PASS
WCDMA Band5	4132	826.4	3.01	13	PASS
WCDMA Band5	4182	836.4	3.04	13	PASS
WCDMA Band5	4233	846.6	2.97	13	PASS
GSM1900	512	1850.2	2.62	13	PASS
GSM1900	661	1880	2.62	13	PASS
GSM1900	810	1909.8	2.65	13	PASS
GSM850	128	824.2	2.62	13	PASS
GSM850	189	836.4	2.62	13	PASS
GSM850	251	848.8	2.61	13	PASS

WCDMA Band2 Channel=9262

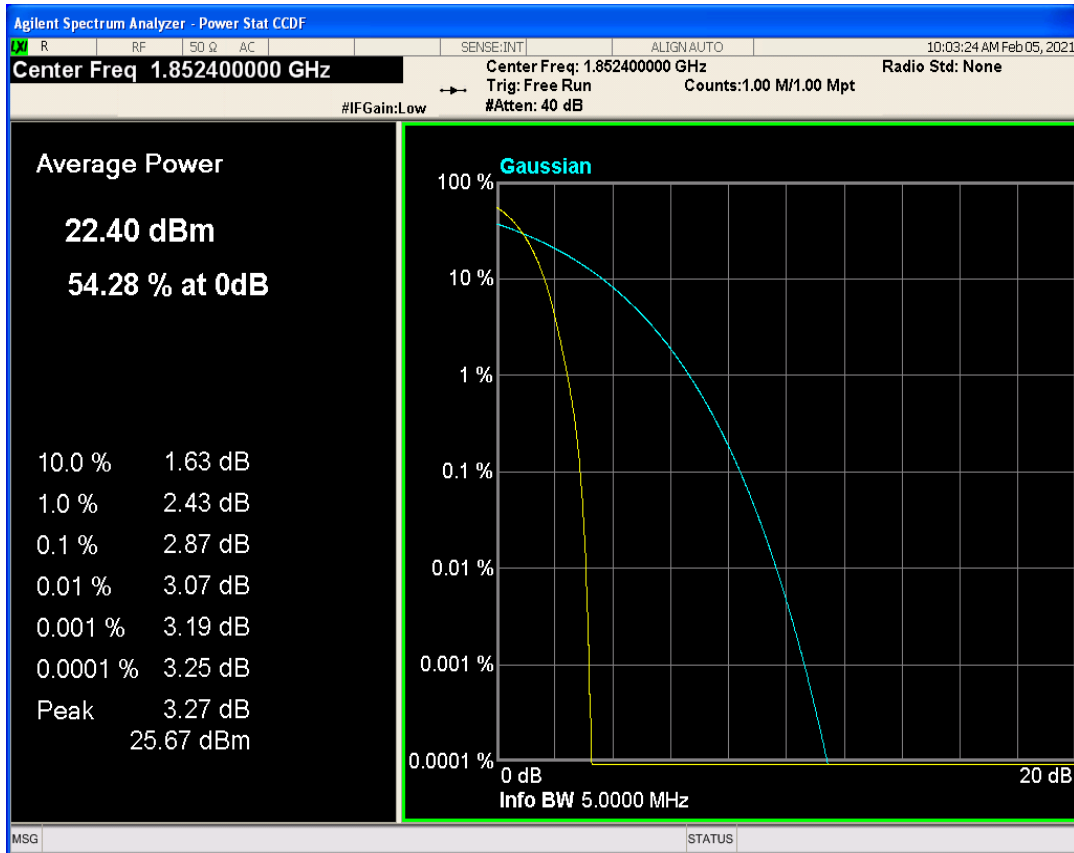

WCDMA Band2 Channel=9400

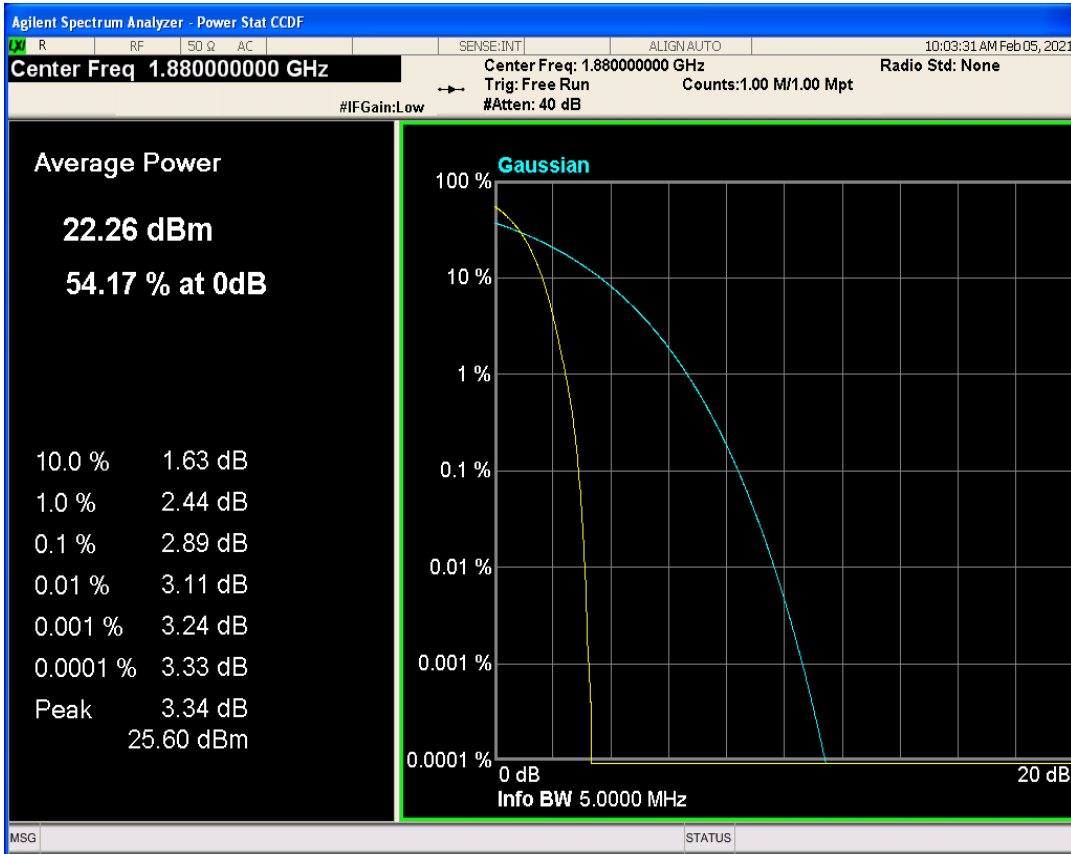

WCDMA Band2 Channel=9538

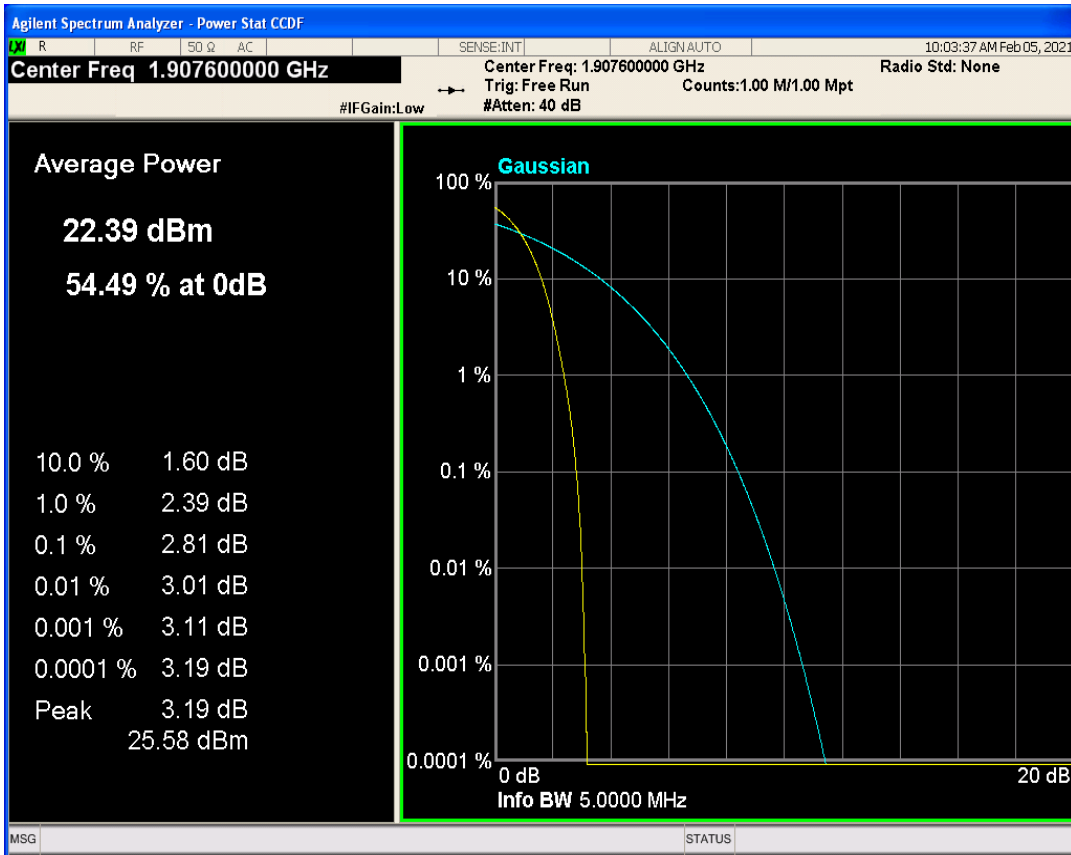

WCDMA Band4 Channel=1413

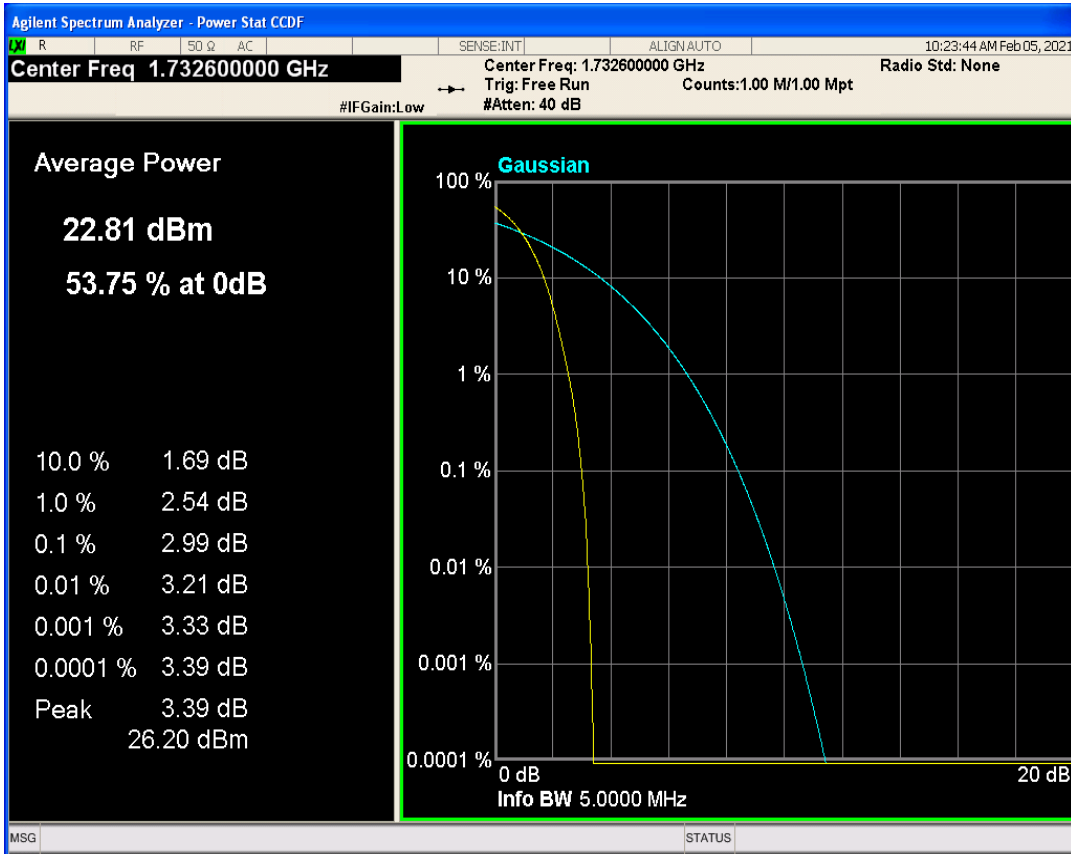

WCDMA Band4 Channel=1312

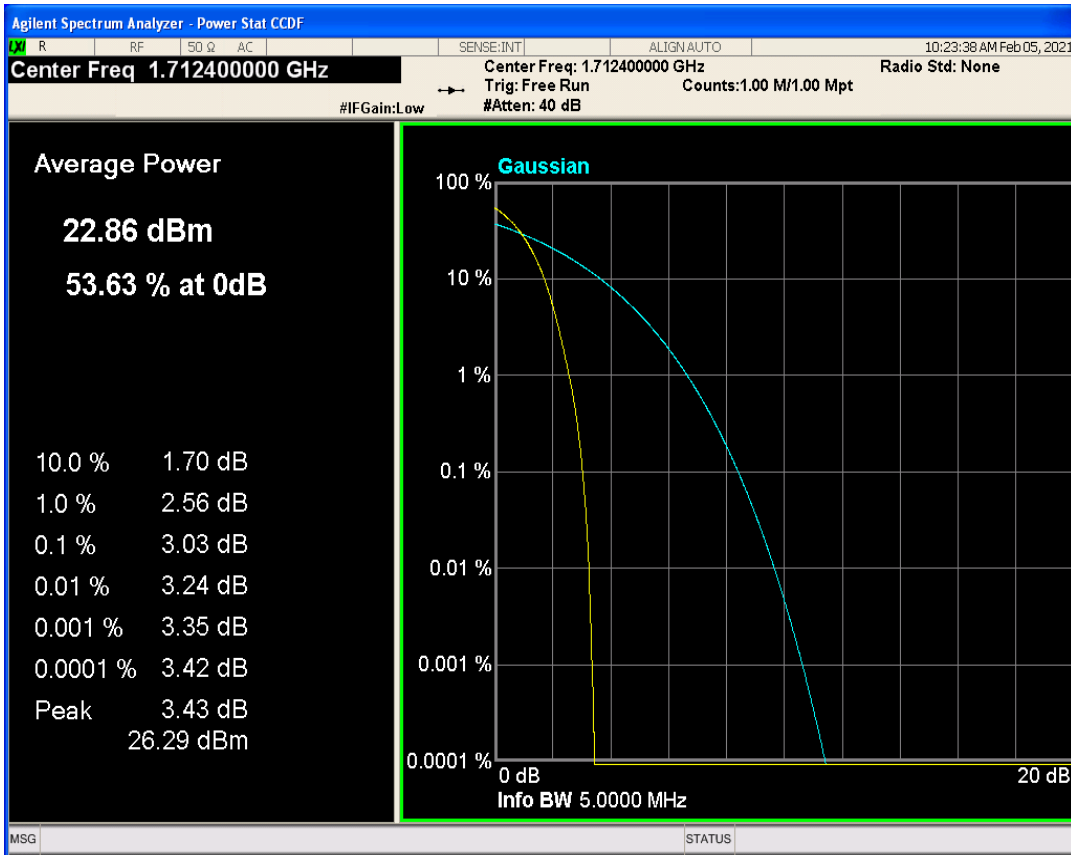

WCDMA Band4 Channel=1513

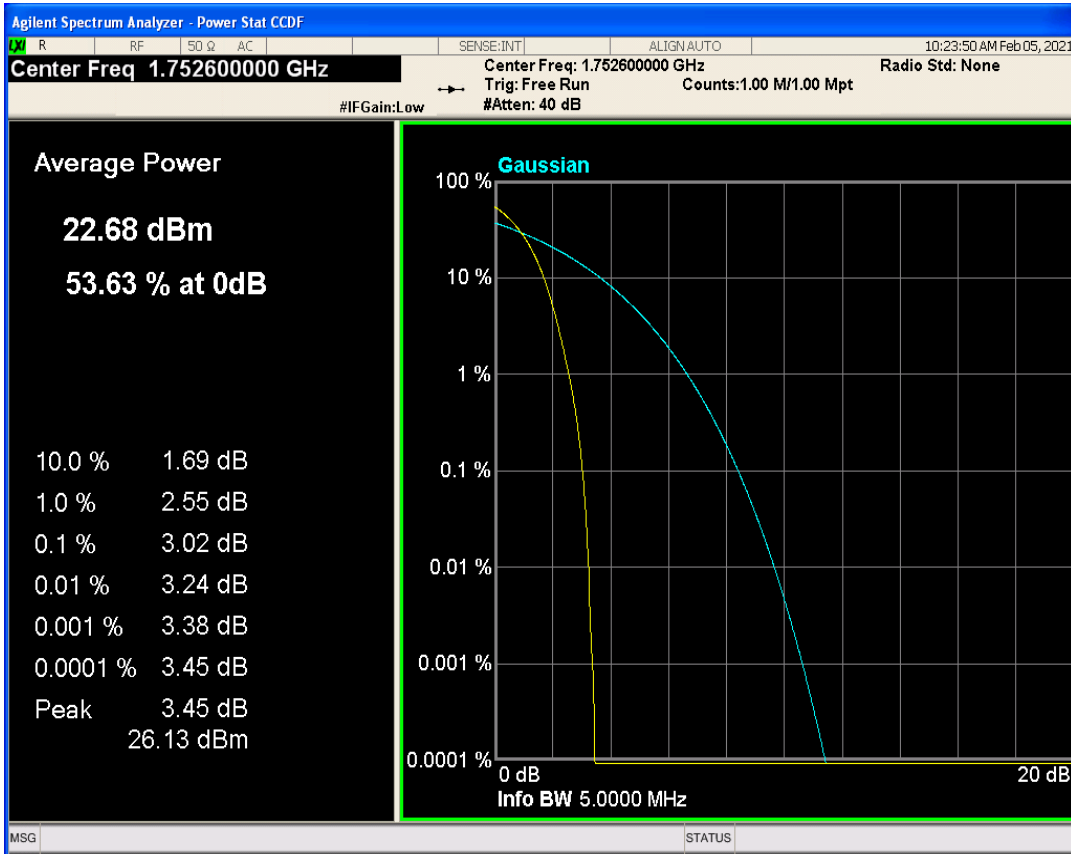

WCDMA Band5 Channel=4182

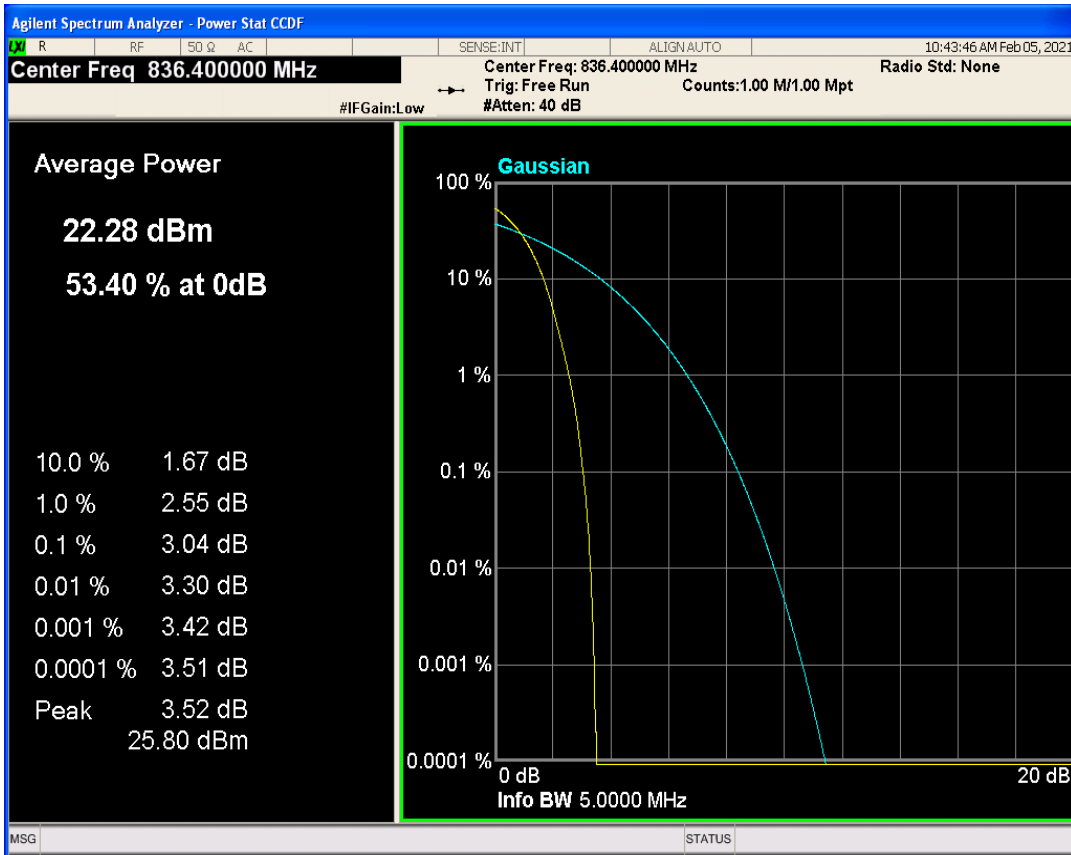

WCDMA Band5 Channel=4132

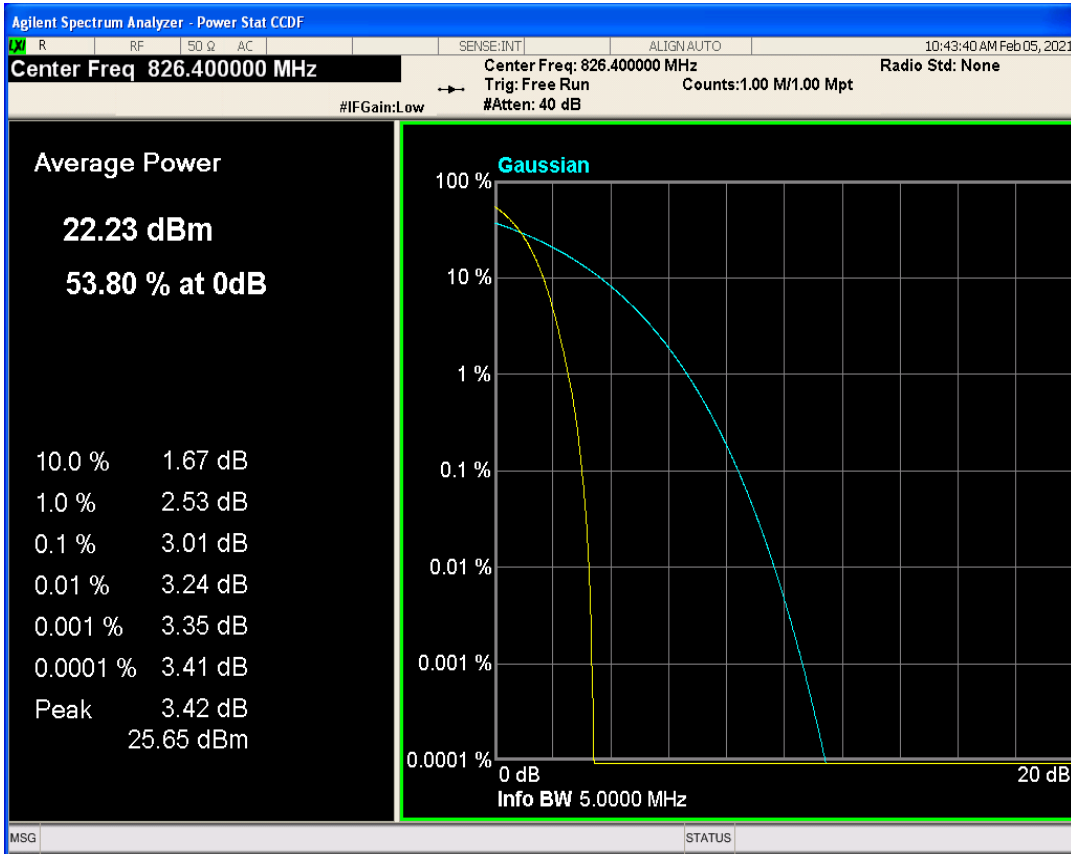

WCDMA Band5 Channel=4233

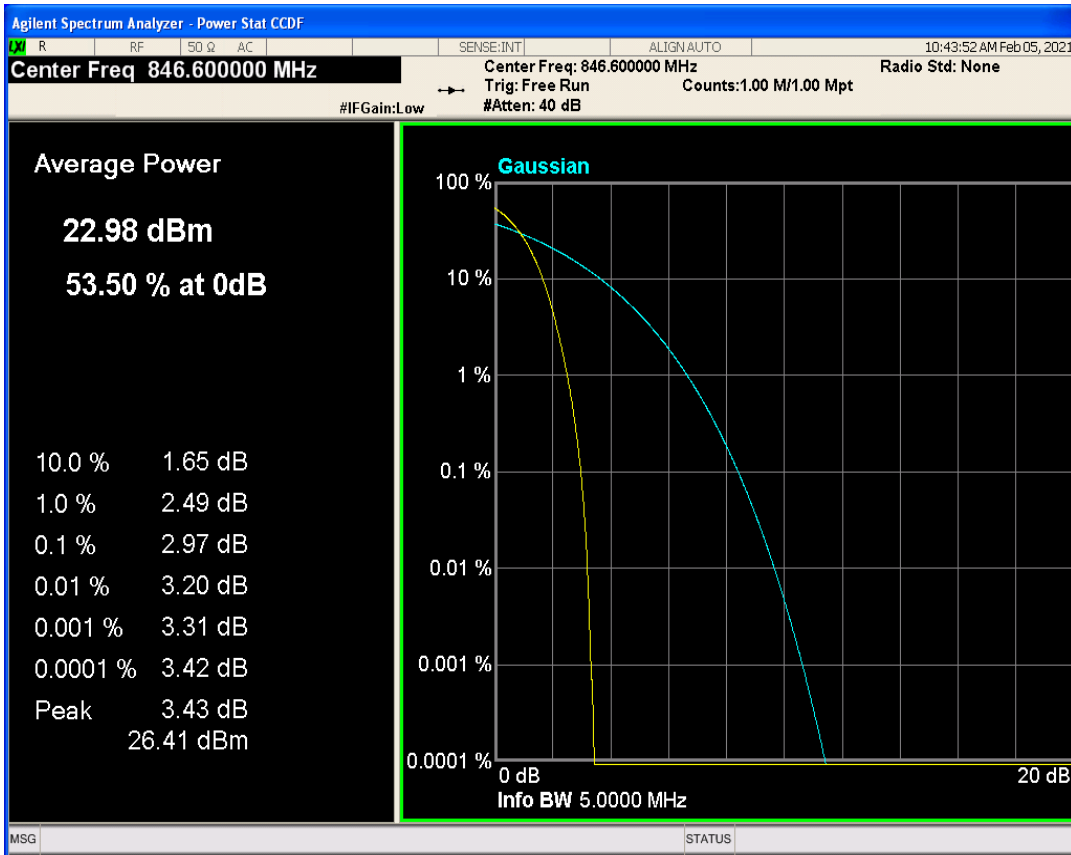

GSM1900 Channel=512

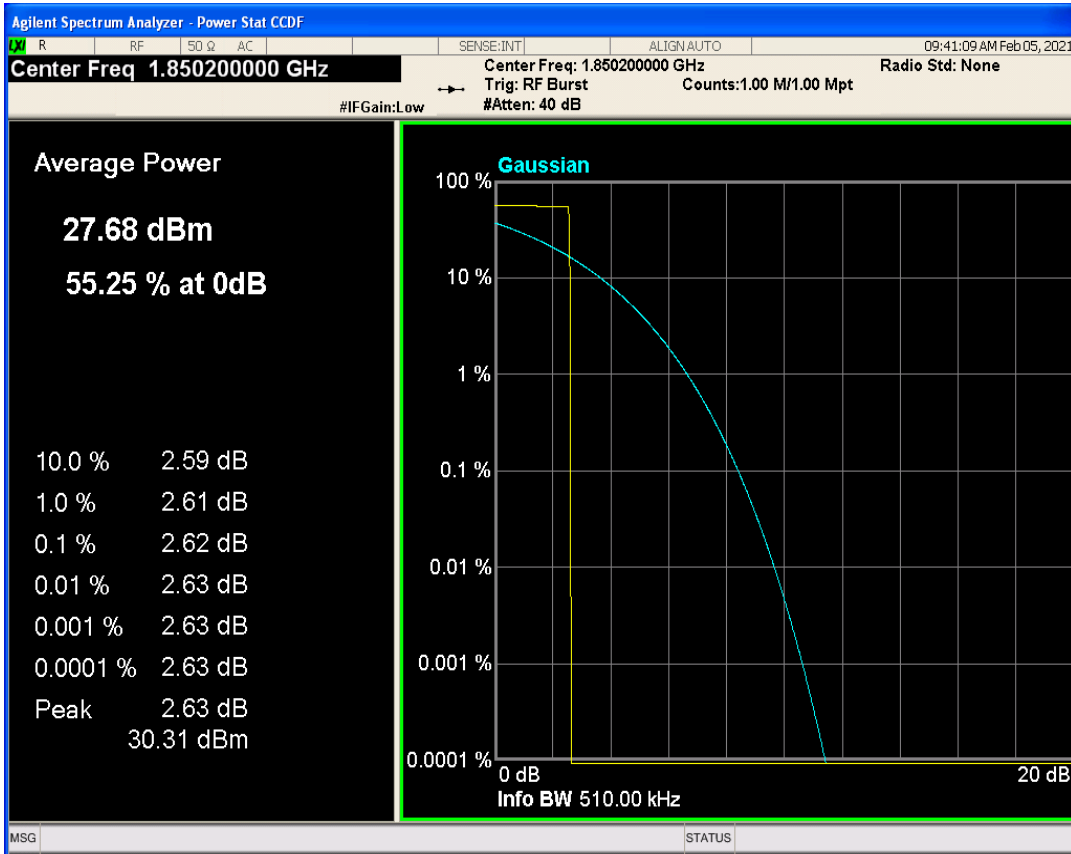

GSM1900 Channel=661

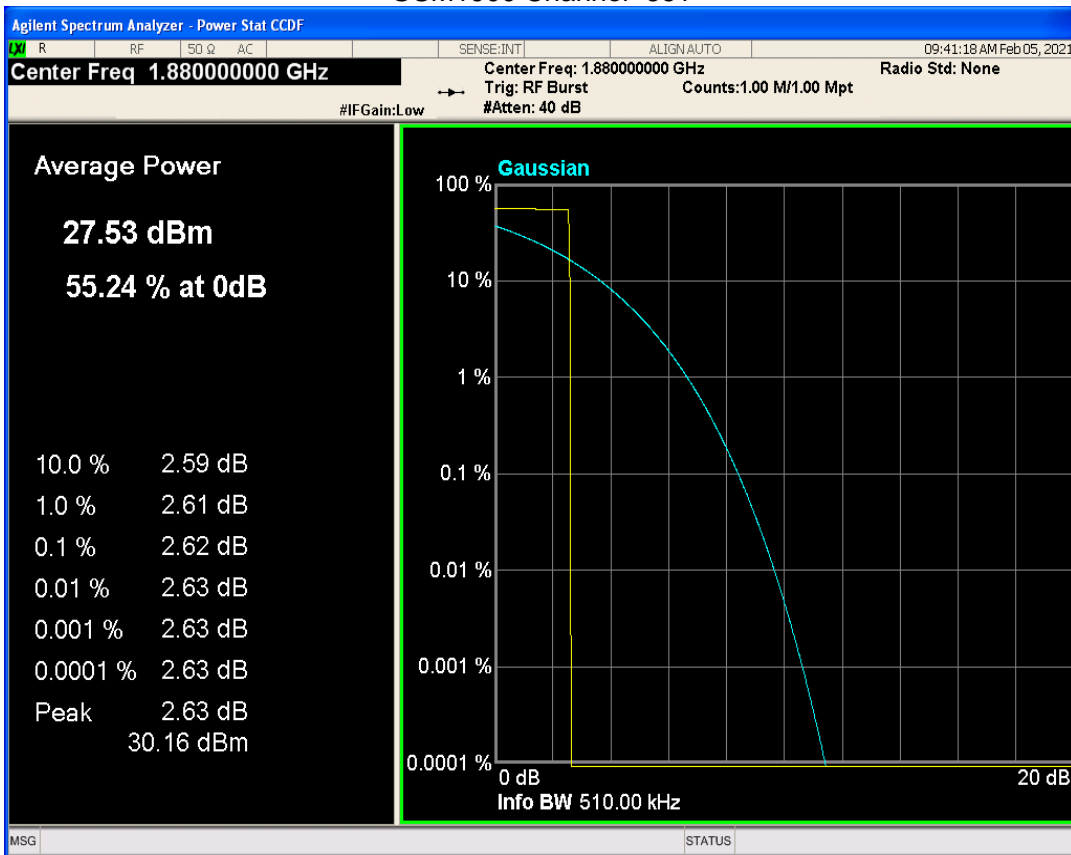

GSM1900 Channel=810

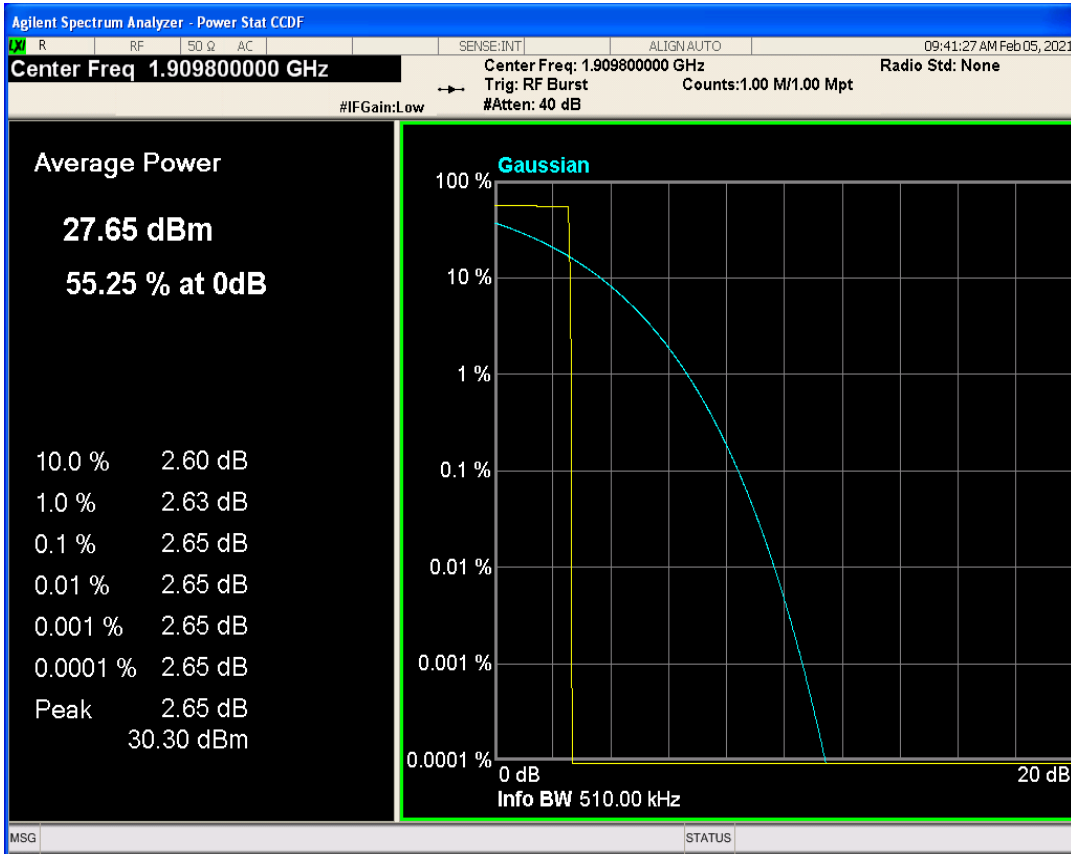

GSM850 Channel=128

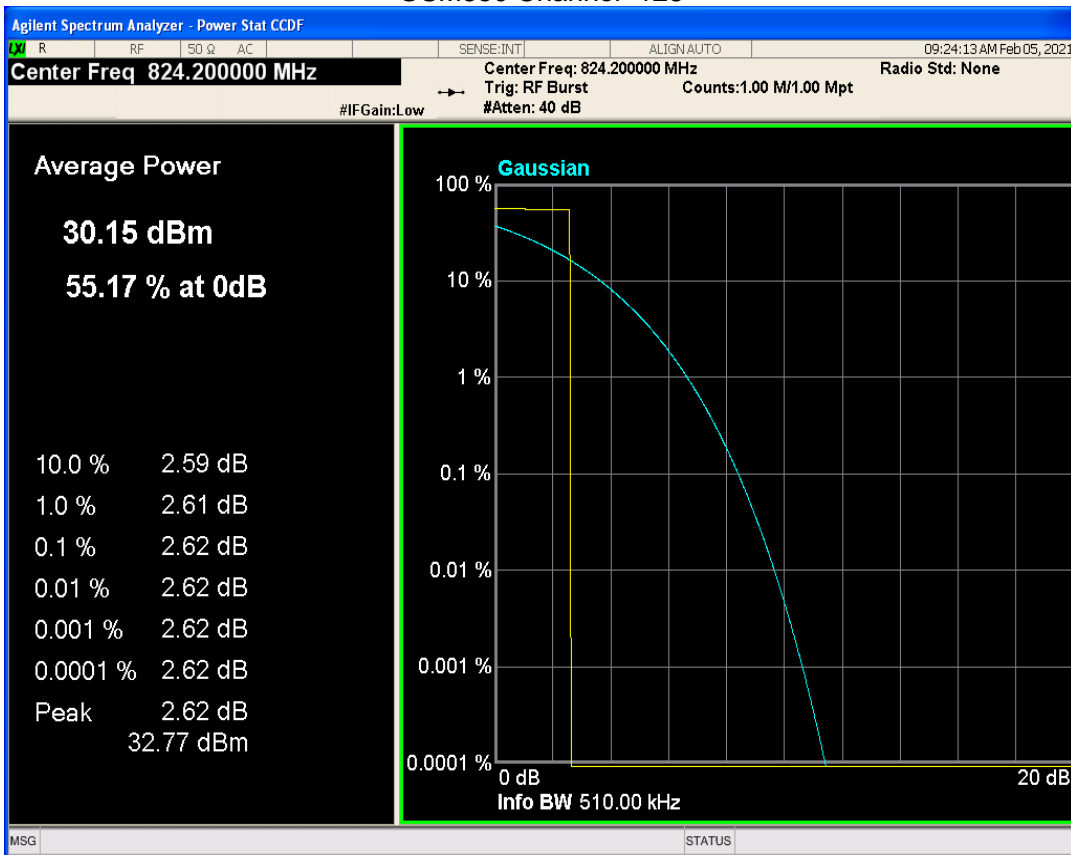

GSM850 Channel=251

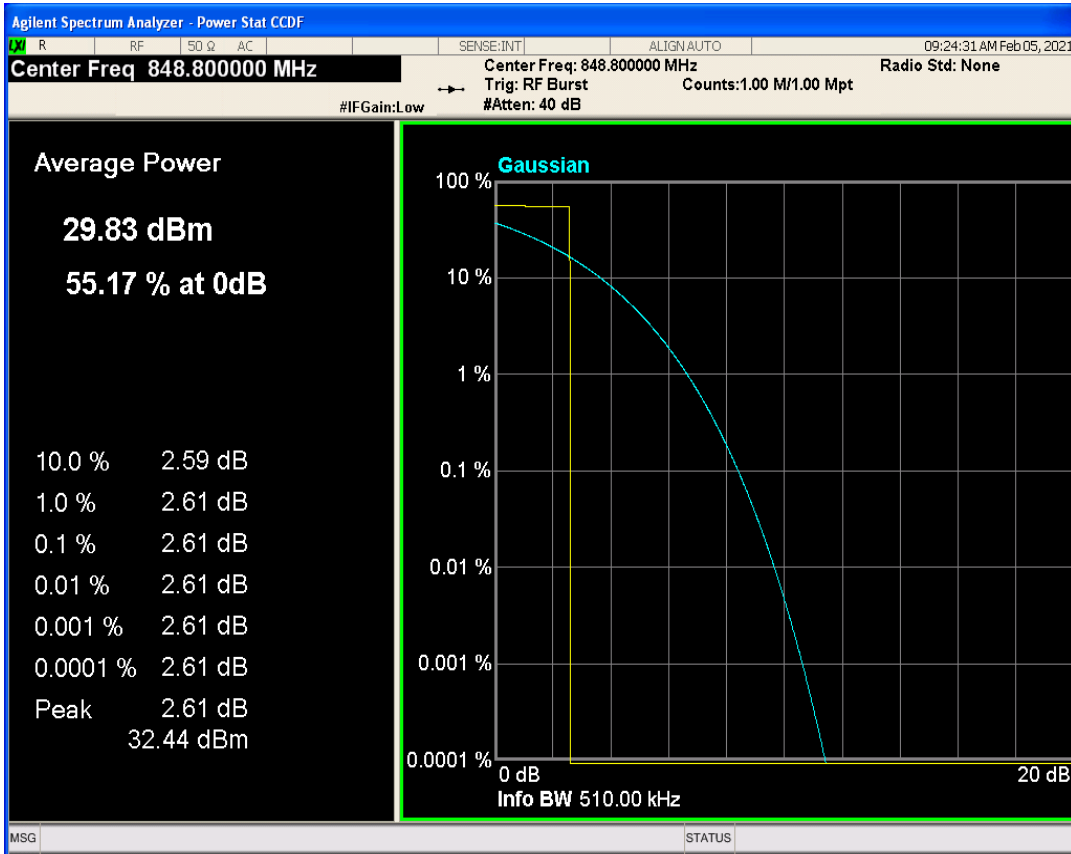

GSM850 Channel=189

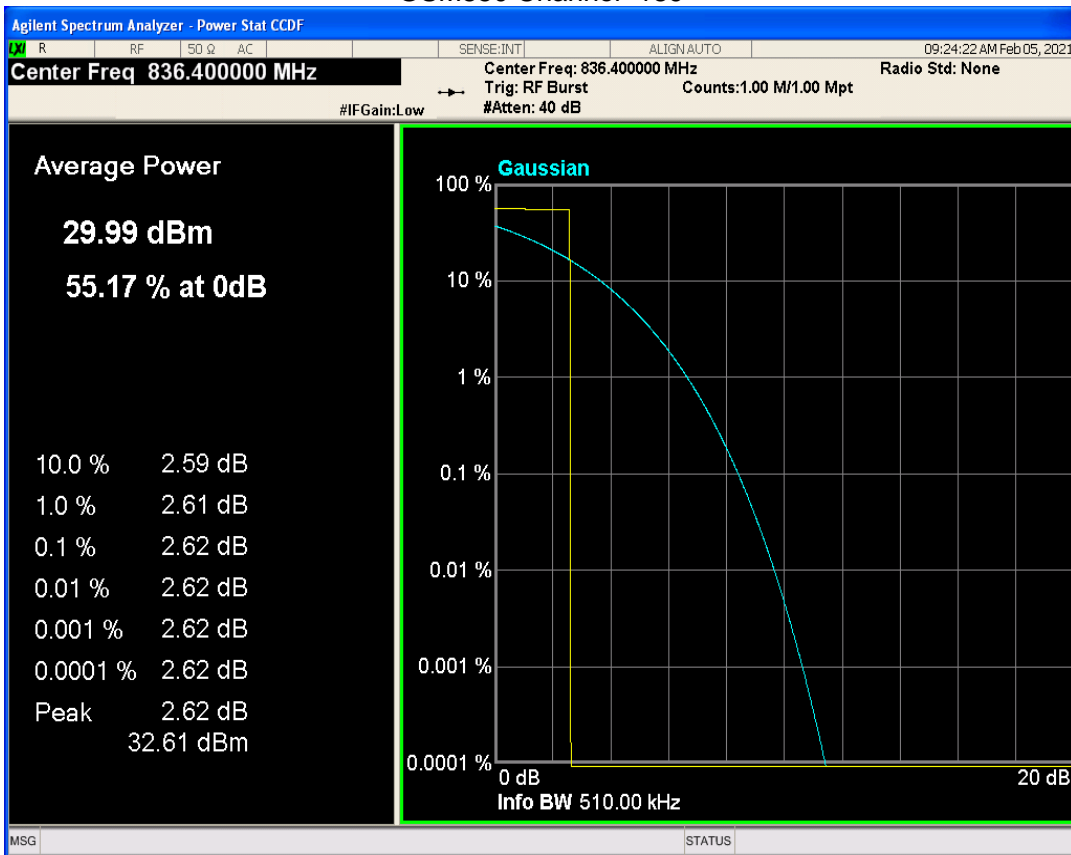

8.3 OCCUPIED BANDWIDTH

Band	Channel	Frequency (MHz)	99% OBW (kHz)	-26dB EBW (kHz)	Verdict
WCDMA Band2	9262	1852.4	4144.998	4683.937	PASS
WCDMA Band2	9400	1880	4162.958	4678.615	PASS
WCDMA Band2	9538	1907.6	4146.366	4686.278	PASS
WCDMA Band4	1312	1712.4	4153.113	4665.814	PASS
WCDMA Band4	1413	1732.6	4158.556	4661.859	PASS
WCDMA Band4	1513	1752.6	4147.511	4667.947	PASS
WCDMA Band5	4132	826.4	4158.475	4661.889	PASS
WCDMA Band5	4182	836.4	4160.640	4668.309	PASS
WCDMA Band5	4233	846.6	4146.361	4693.293	PASS
GSM1900	512	1850.2	249.514	320.360	PASS
GSM1900	661	1880	249.172	319.336	PASS
GSM1900	810	1909.8	248.262	324.240	PASS
GSM850	128	824.2	244.961	315.476	PASS
GSM850	189	836.4	241.582	314.483	PASS
GSM850	251	848.8	247.618	320.091	PASS

WCDMA Band2 Channel=9400

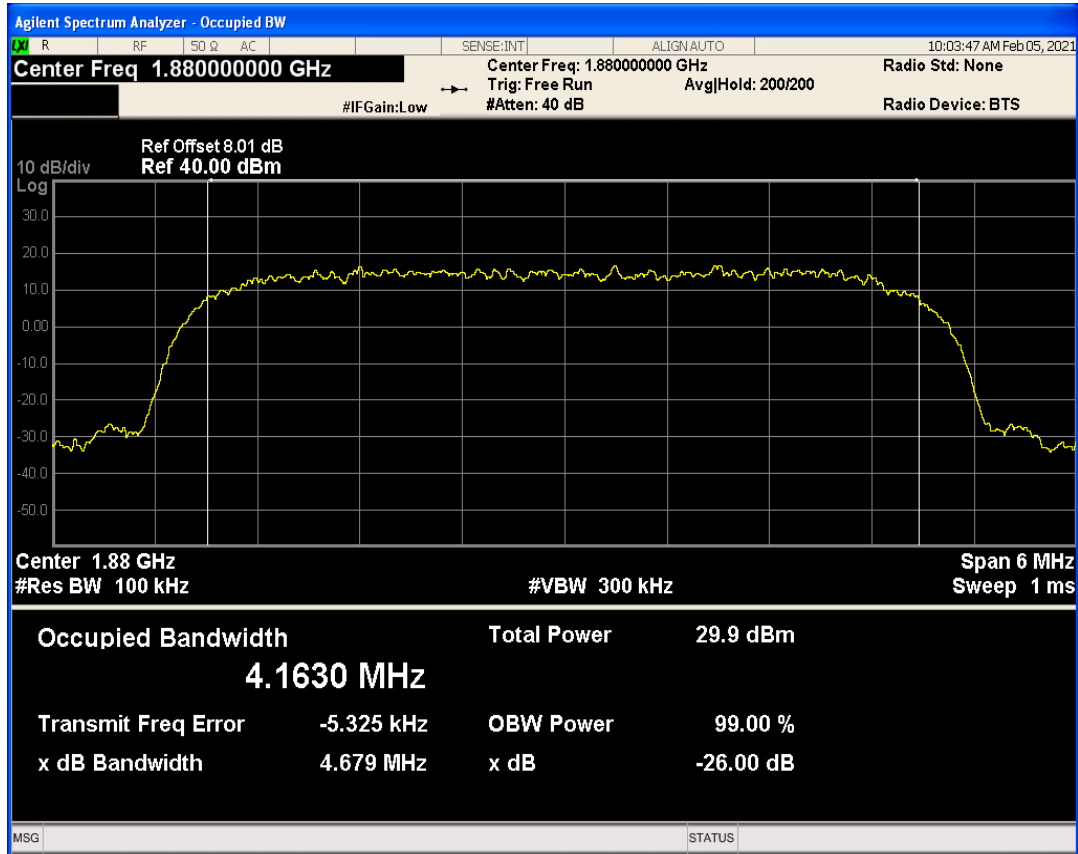

WCDMA Band2 Channel=9262

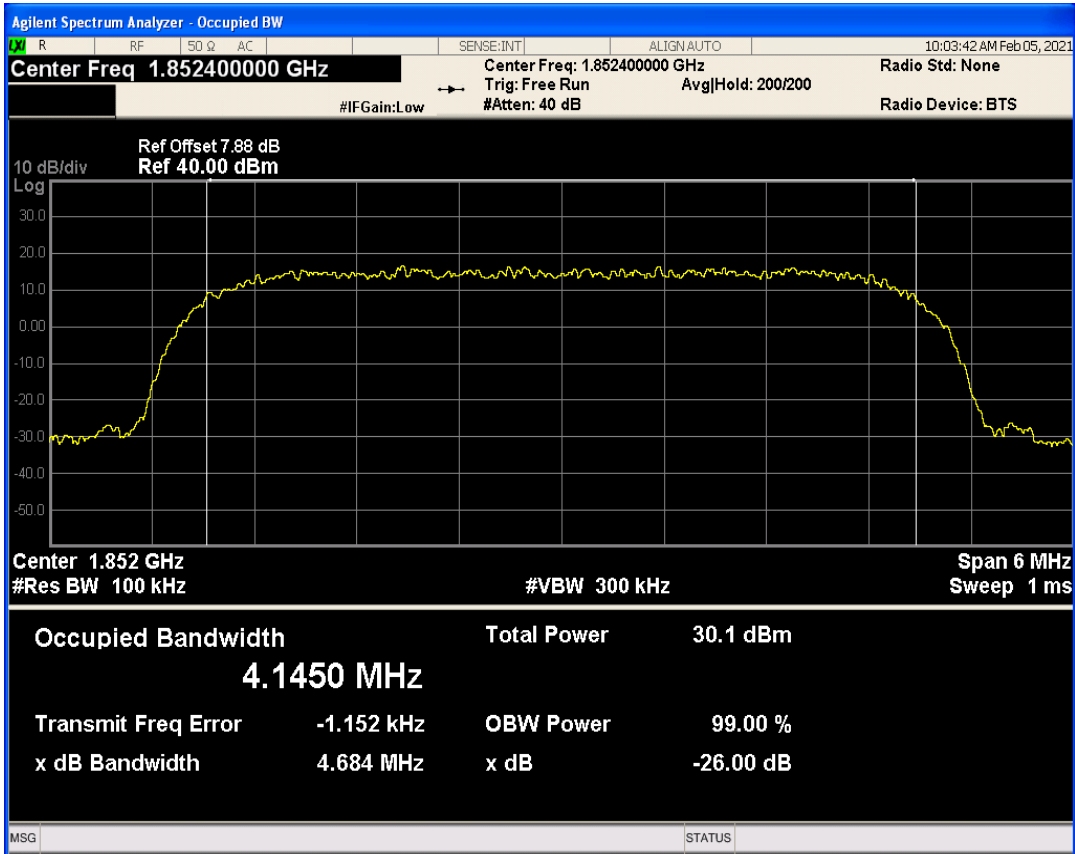

WCDMA Band2 Channel=9538

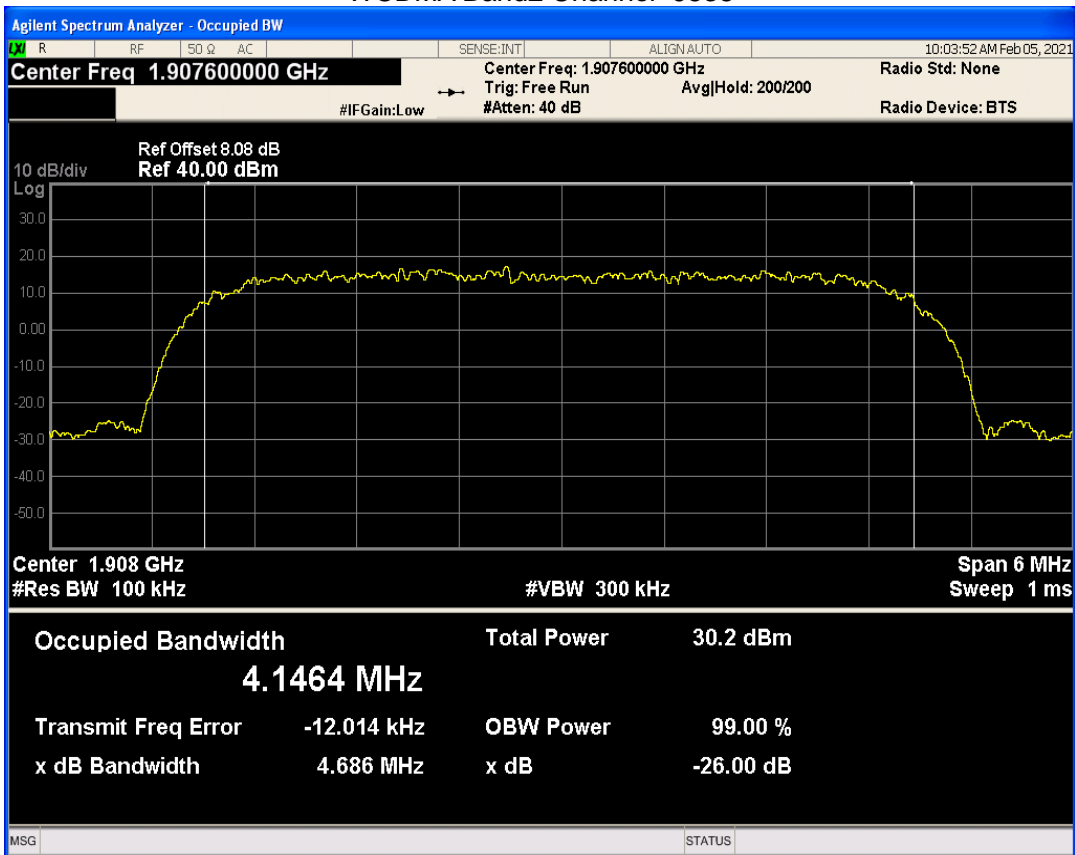

WCDMA Band4 Channel=1312

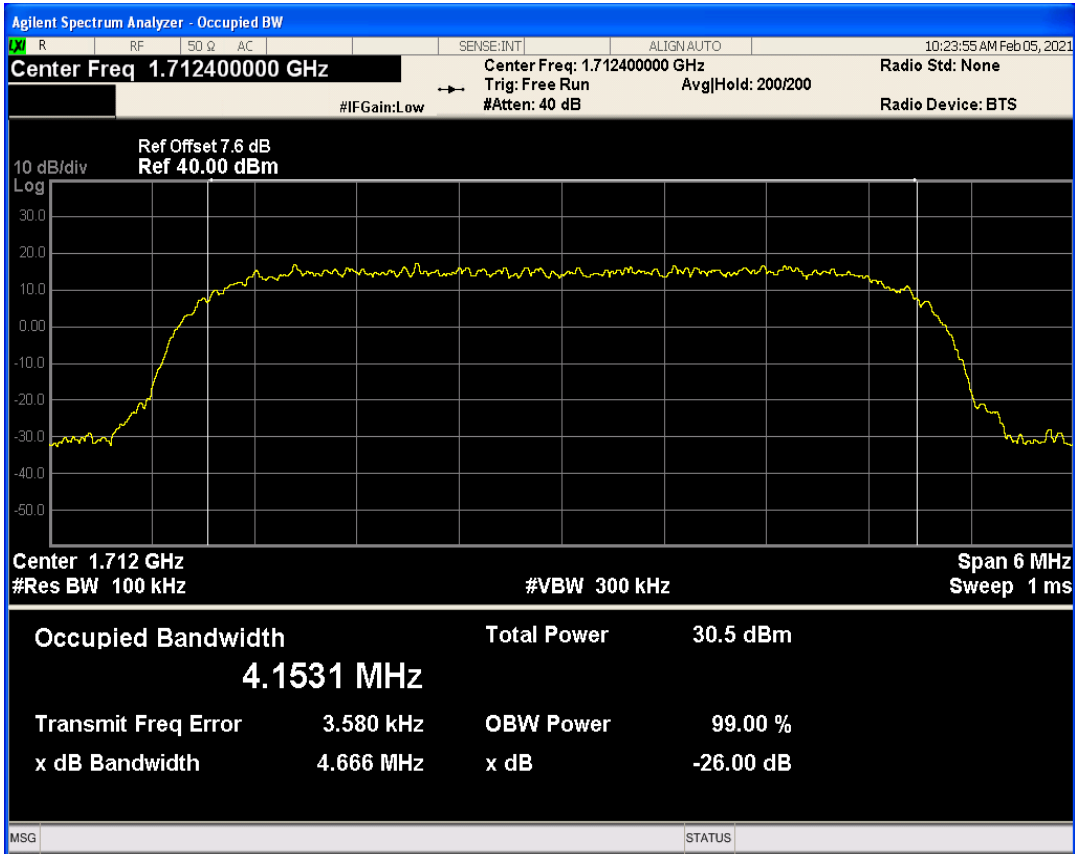

WCDMA Band4 Channel=1513

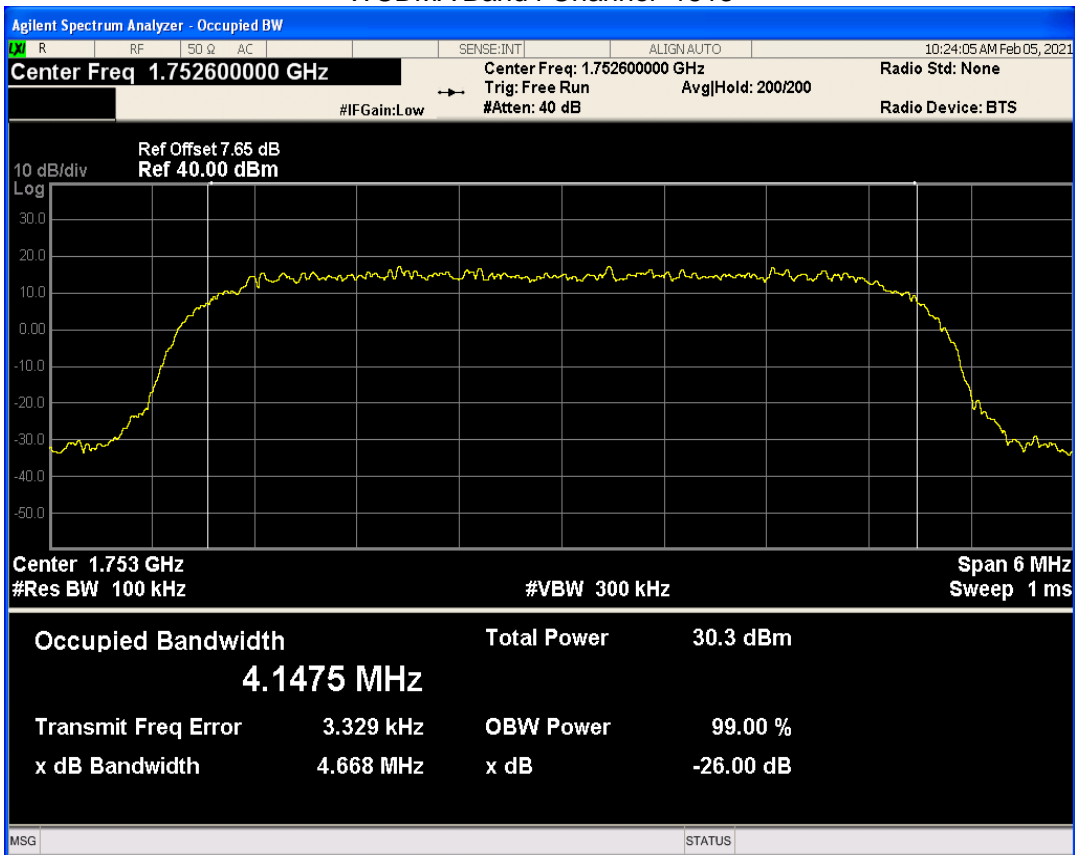

WCDMA Band4 Channel=1413

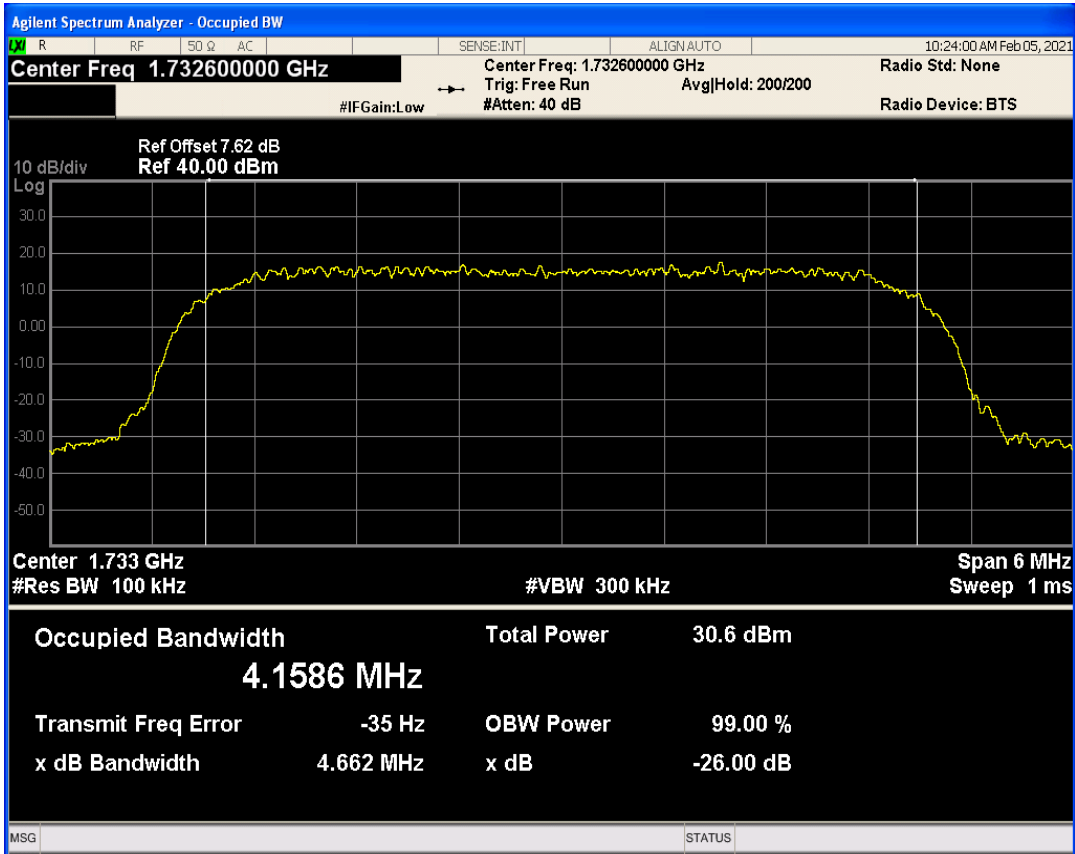

WCDMA Band5 Channel=4182

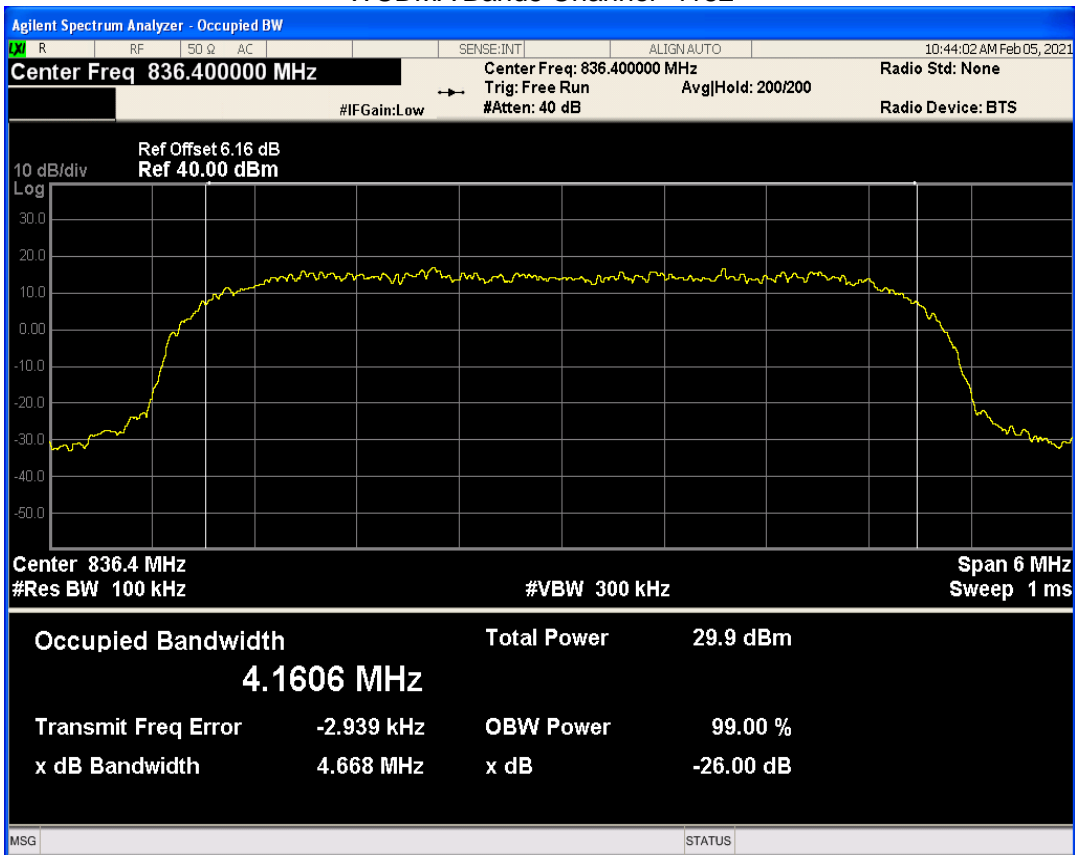

WCDMA Band5 Channel=4132

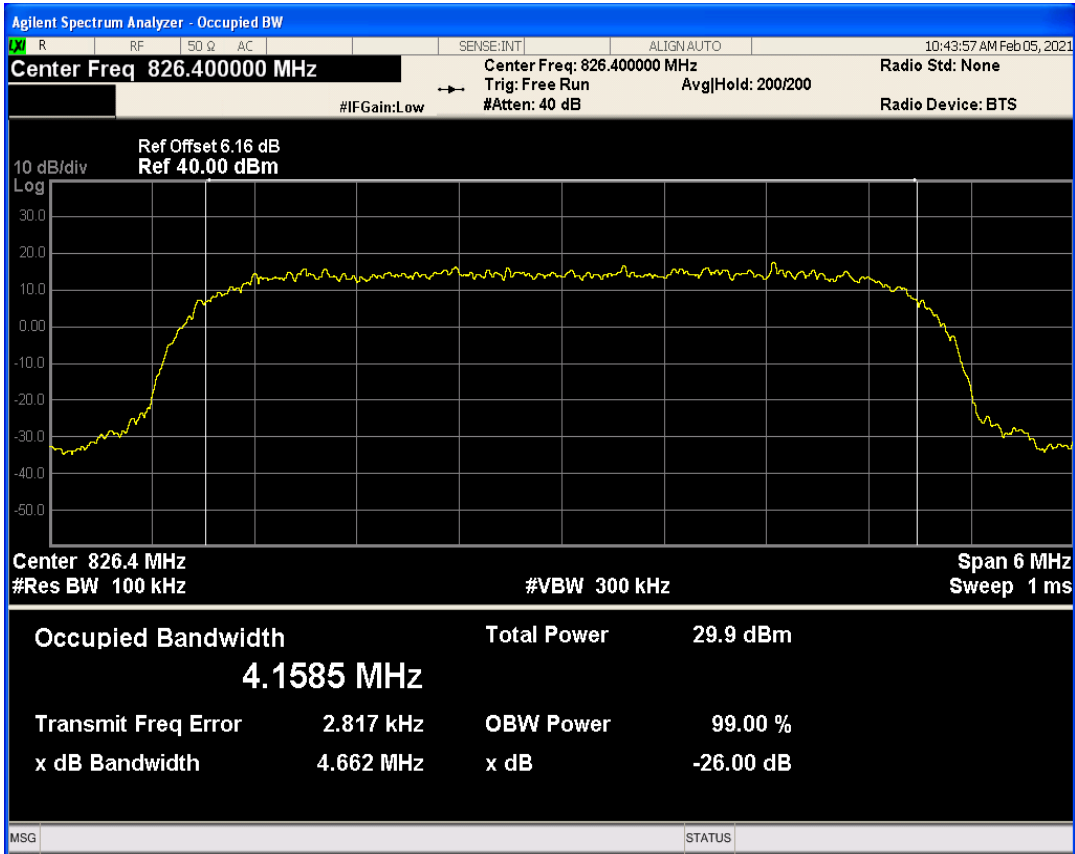

WCDMA Band5 Channel=4233

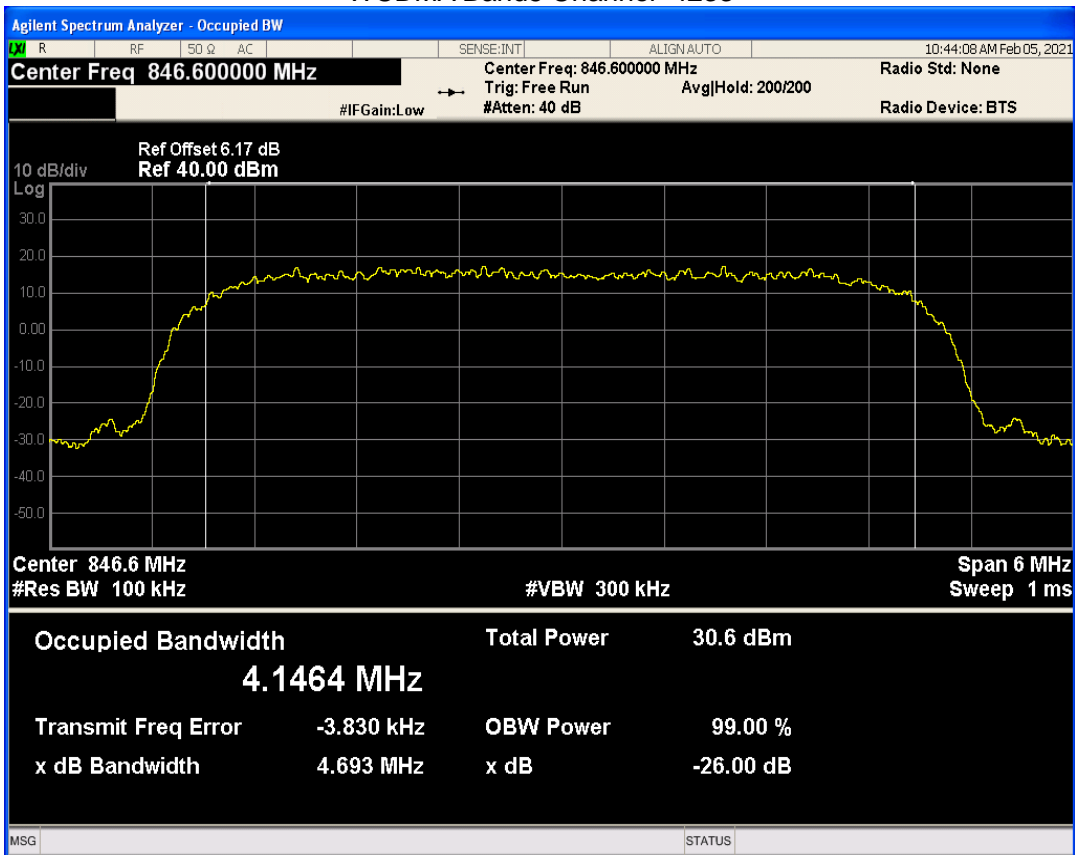

GSM1900 Channel=512

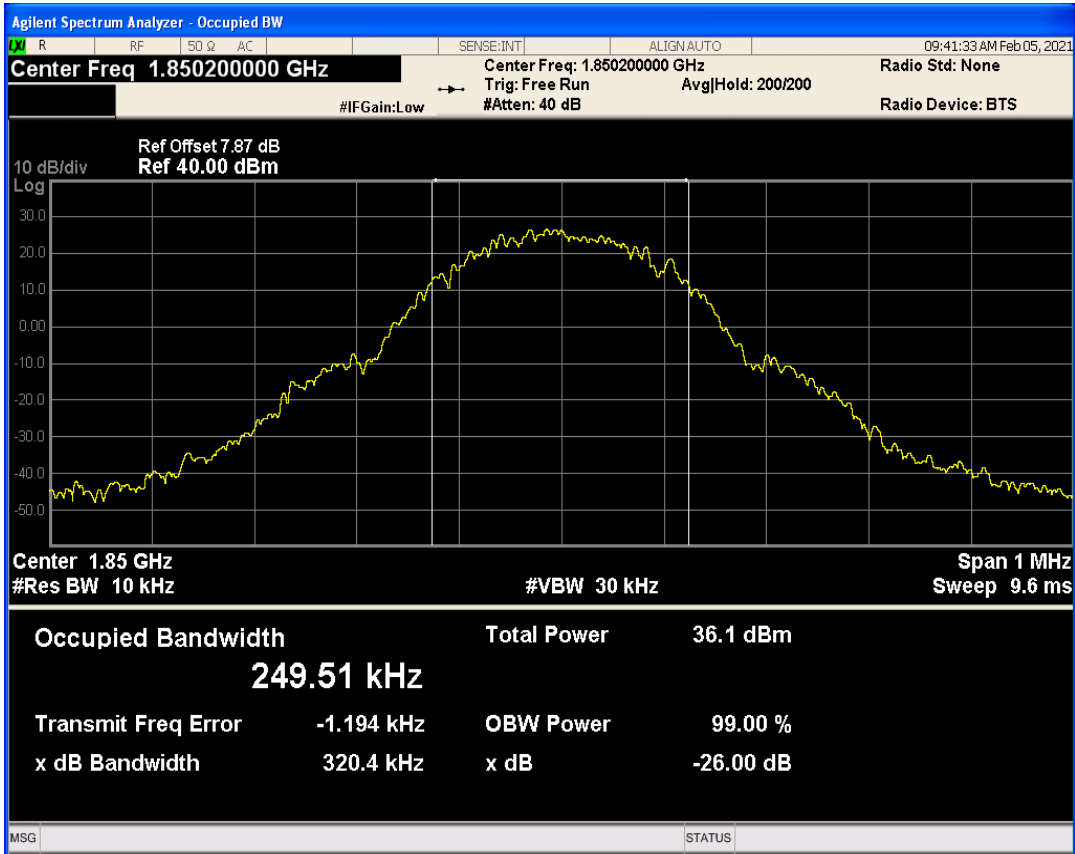

GSM1900 Channel=810

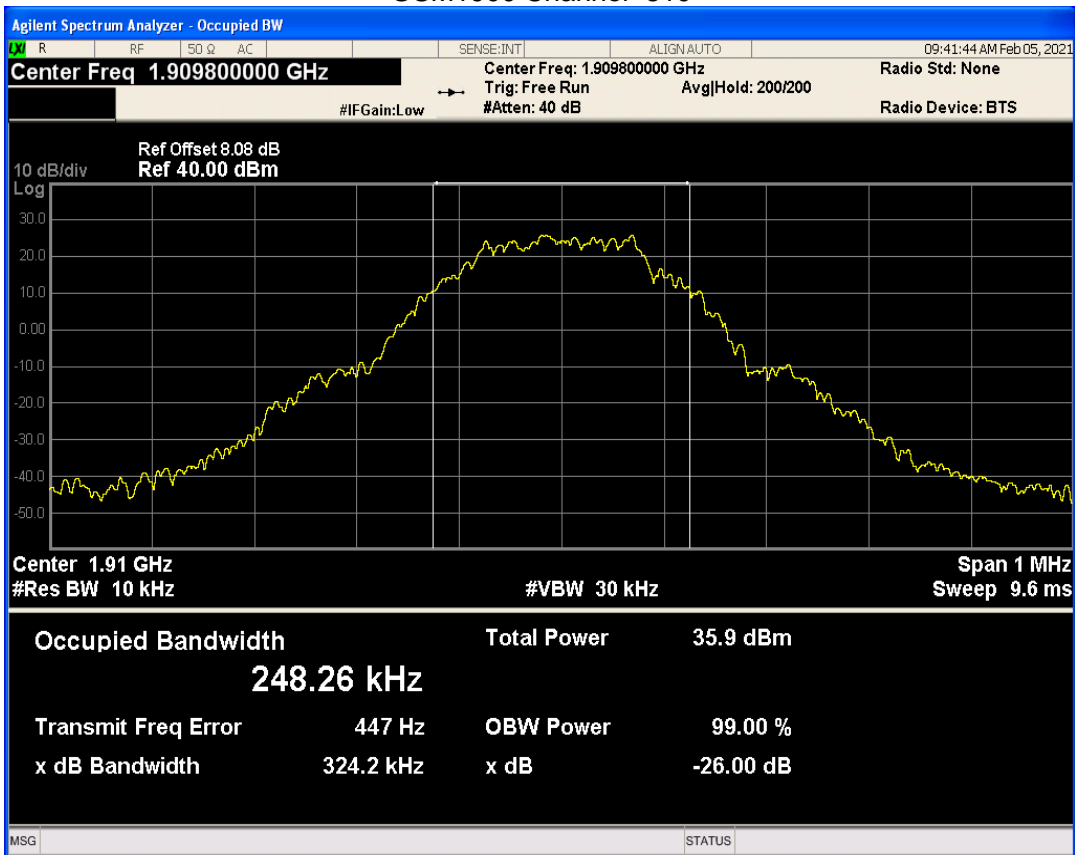

GSM1900 Channel=661

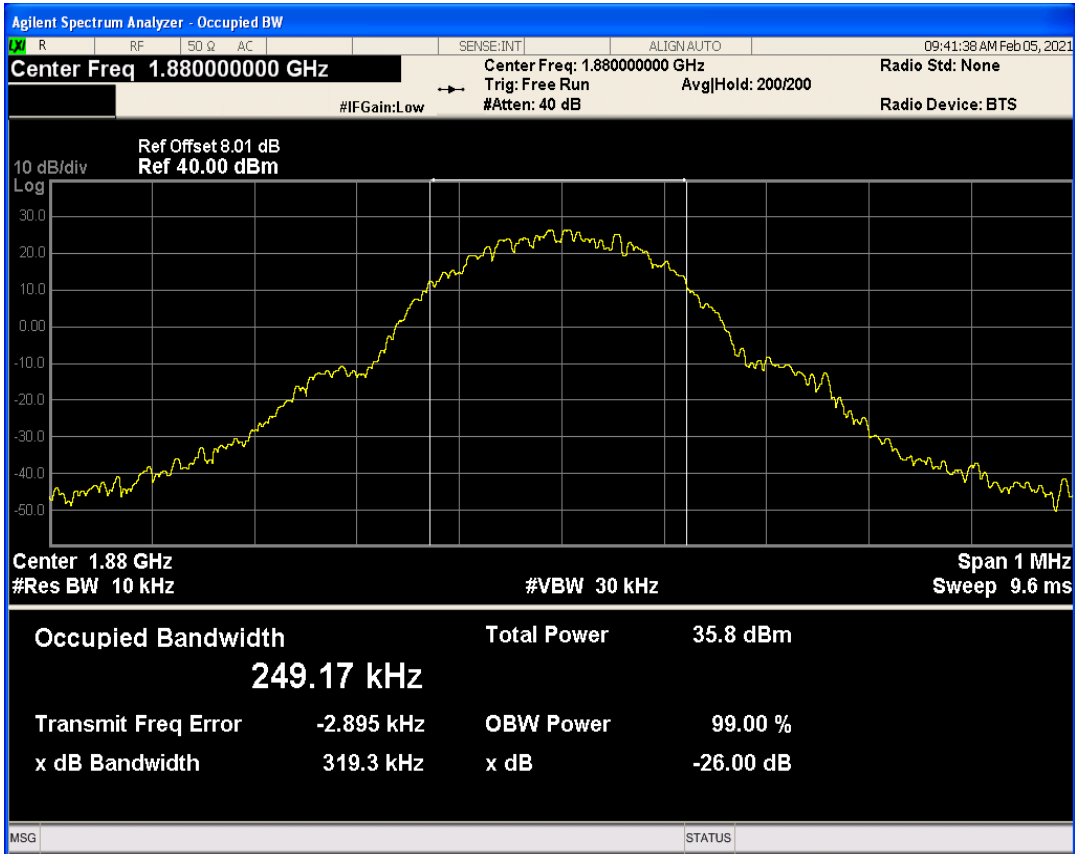

GSM850 Channel=189

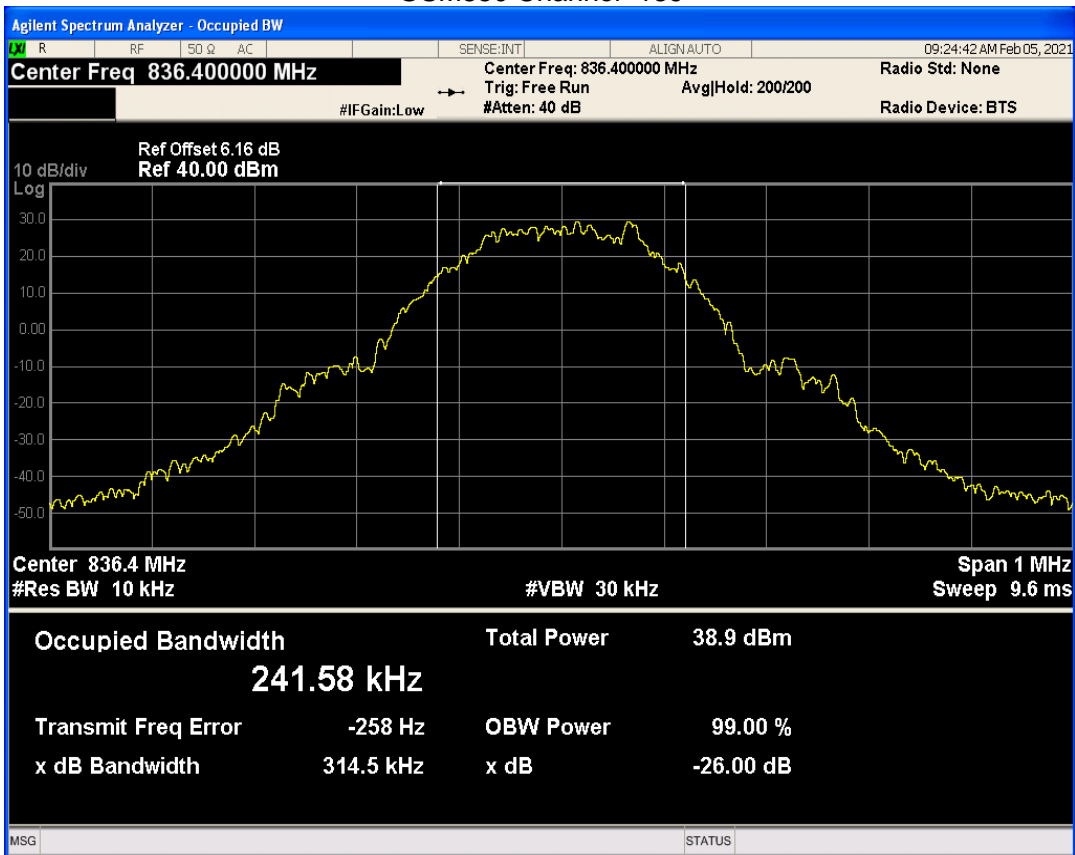

GSM850 Channel=128

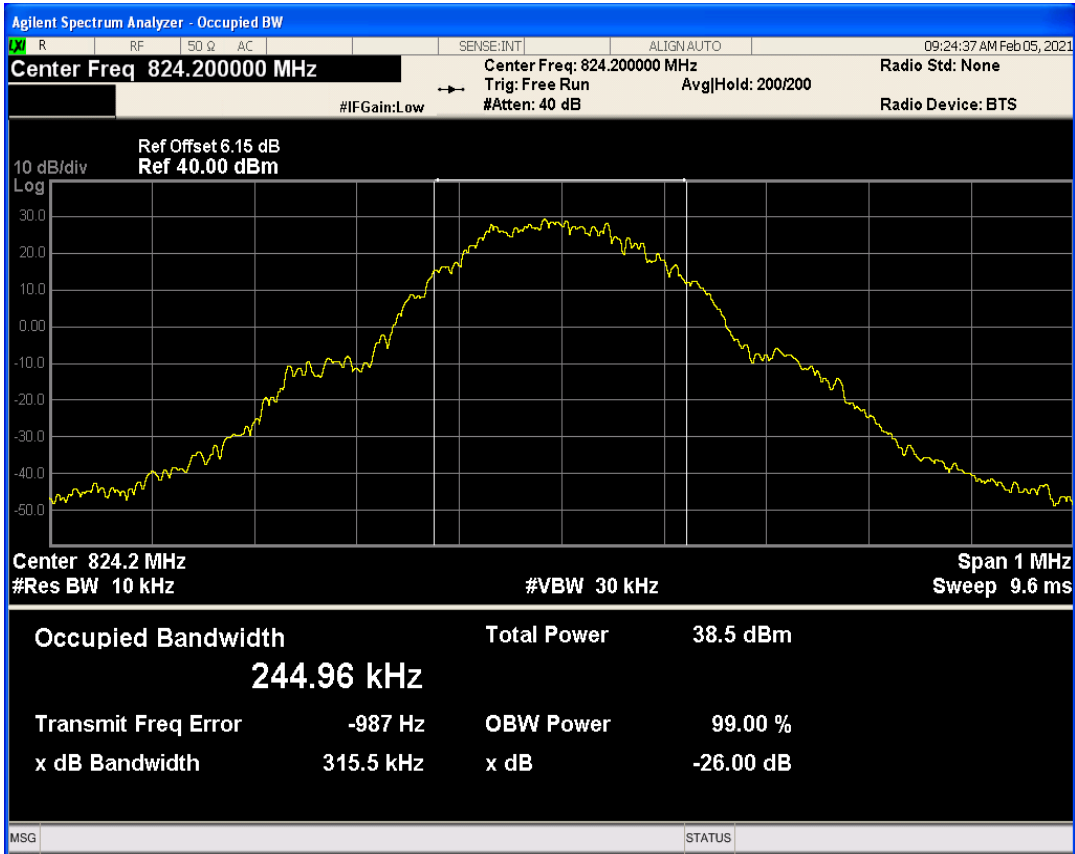

GSM850 Channel=251

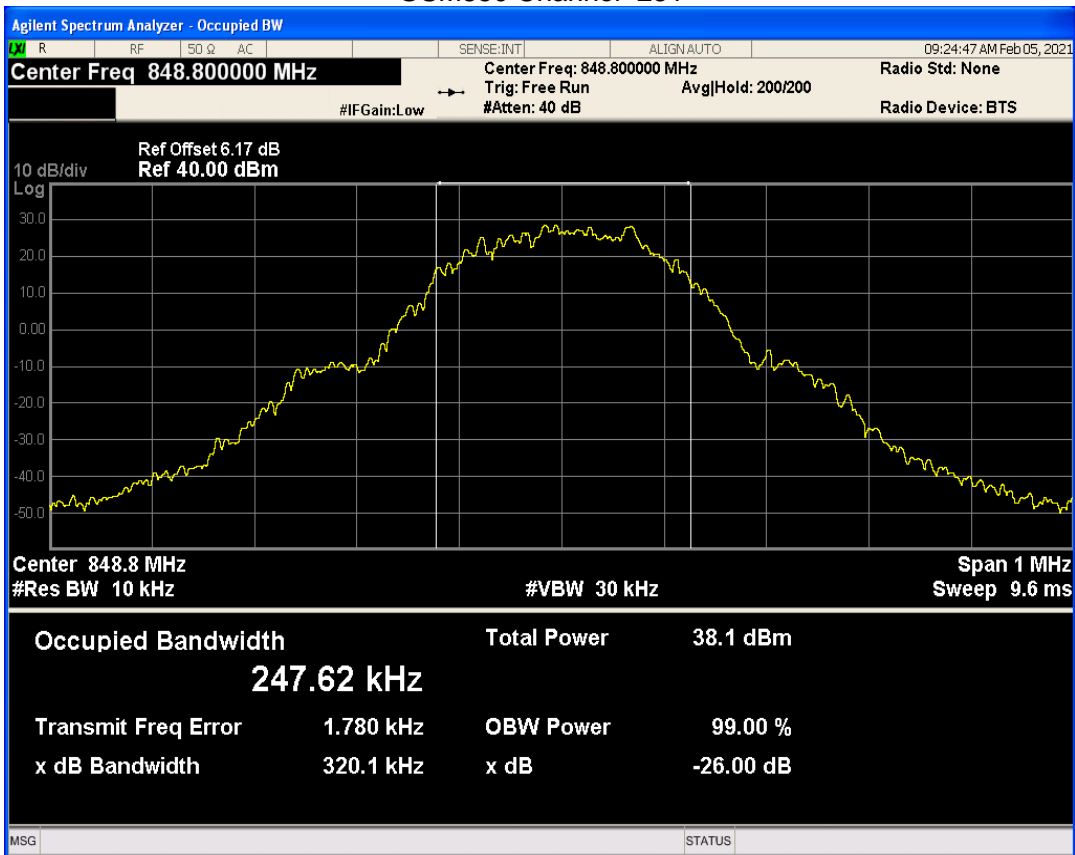

8.4 BAND EDGE

Band	Channel	Frequency (MHz)	Spur Freq (MHz)	Spur Level (dBm)	Limit (dBm)	Verdict
WCDMA Band2	9262	1852.4	1850.00	-25.96	-13	PASS
WCDMA Band2	9538	1907.6	1910.00	-24.75	-13	PASS
WCDMA Band4	1312	1712.4	1710.00	-26.90	-13	PASS
WCDMA Band4	1513	1752.6	1755.00	-26.34	-13	PASS
WCDMA Band5	4132	826.4	824.00	-28.16	-13	PASS
WCDMA Band5	4233	846.6	849.00	-25.82	-13	PASS
GSM1900	512	1850.2	1850.00	-28.54	-13	PASS
GSM1900	810	1909.8	1910.02	-29.04	-13	PASS
GSM850	128	824.2	823.98	-26.58	-13	PASS
GSM850	251	848.8	849.02	-25.72	-13	PASS

WCDMA Band2 Channel=9262

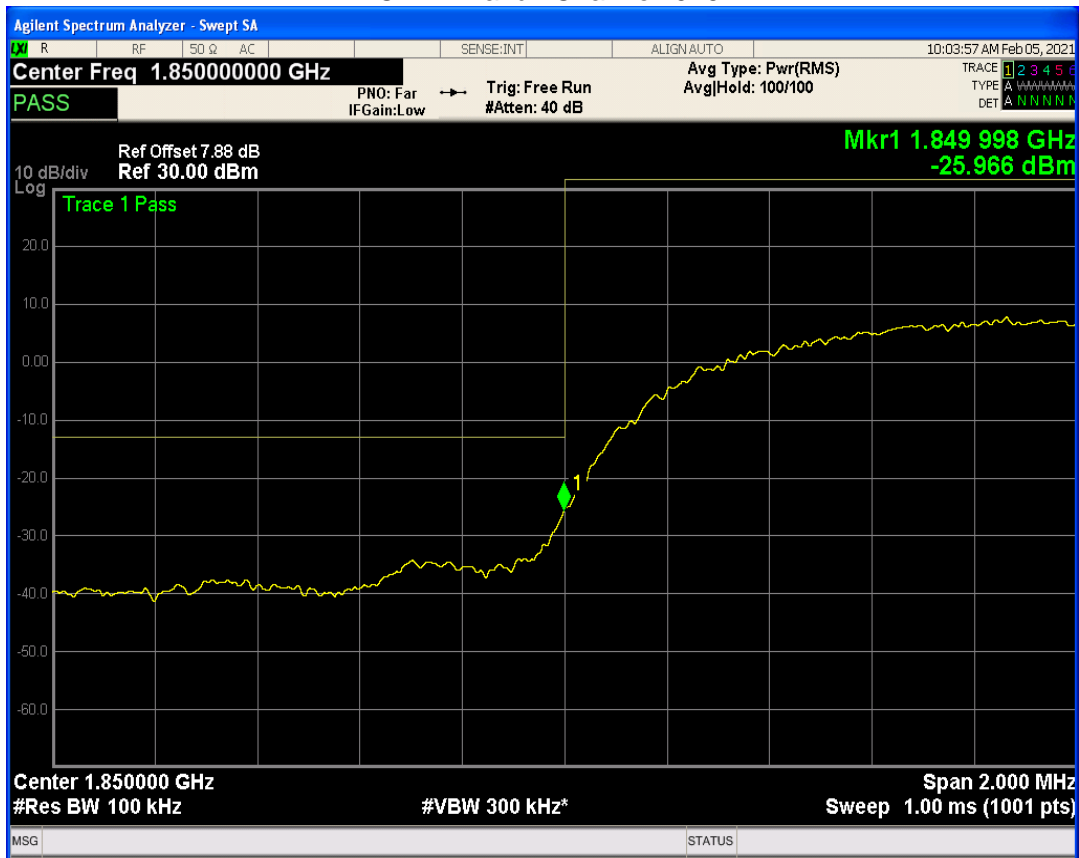

WCDMA Band2 Channel=9538

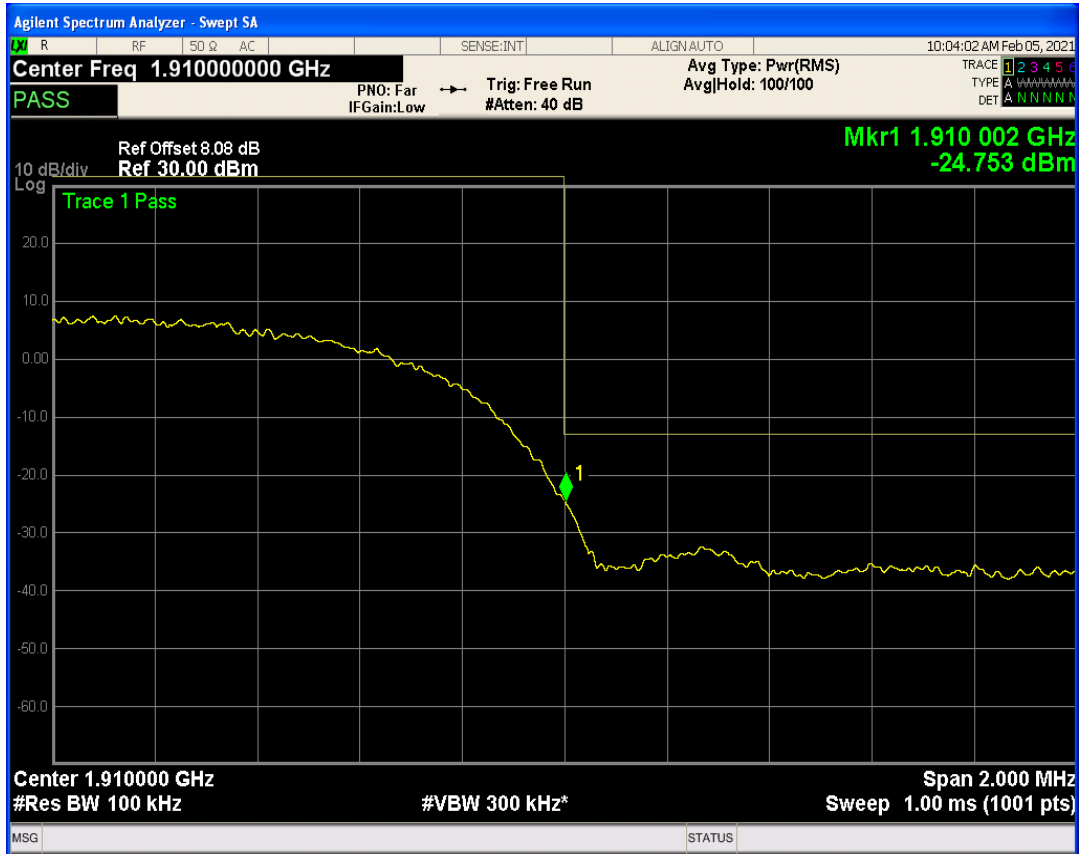

WCDMA Band4 Channel=1513

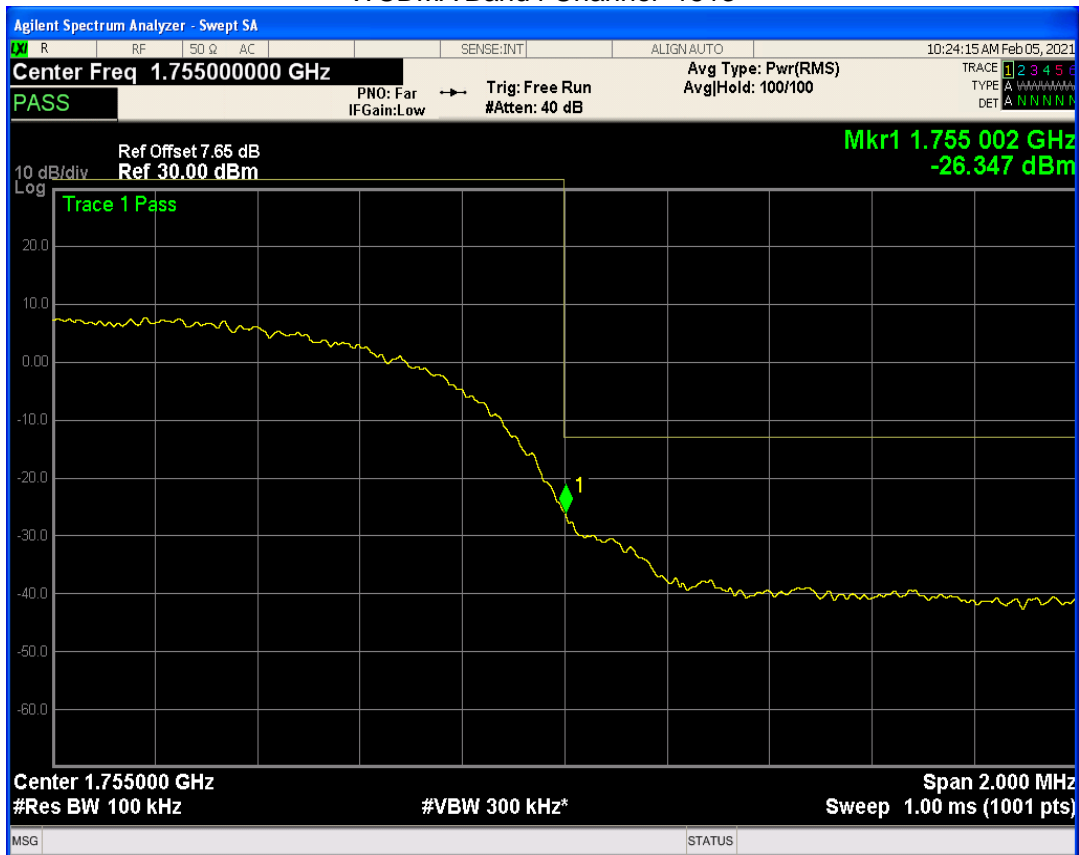

WCDMA Band4 Channel=1312

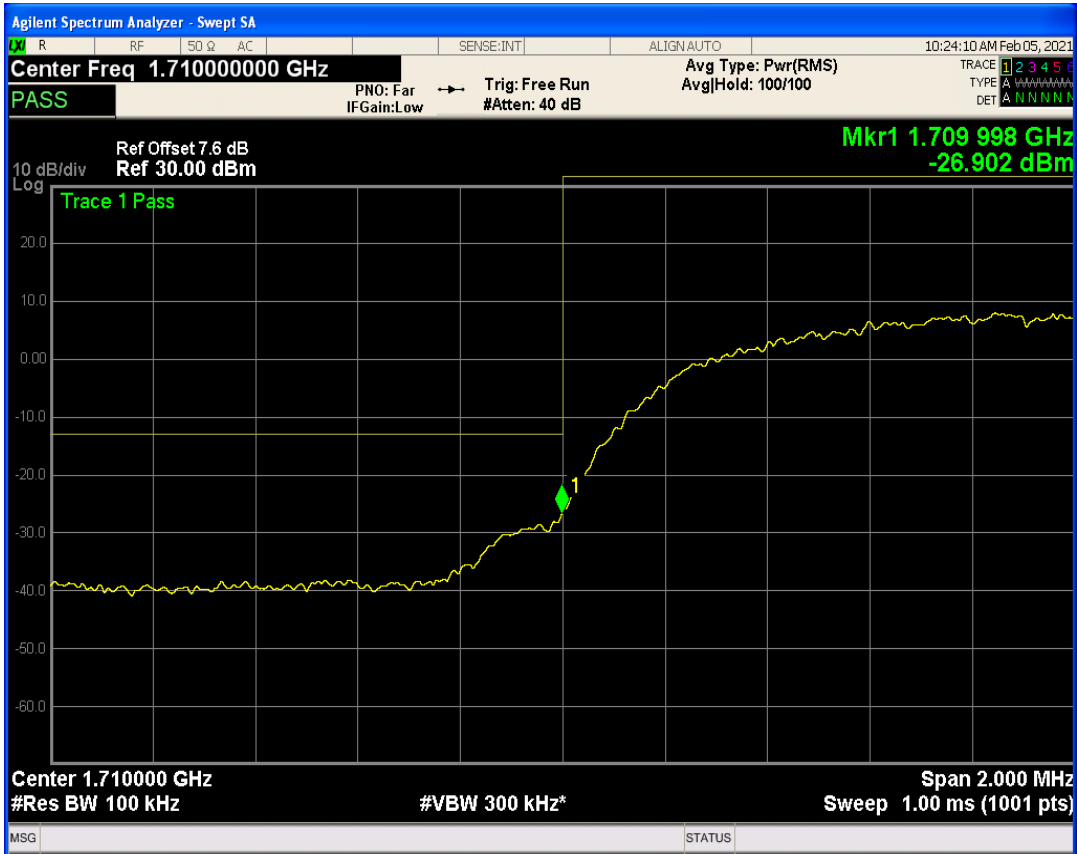

WCDMA Band5 Channel=4233

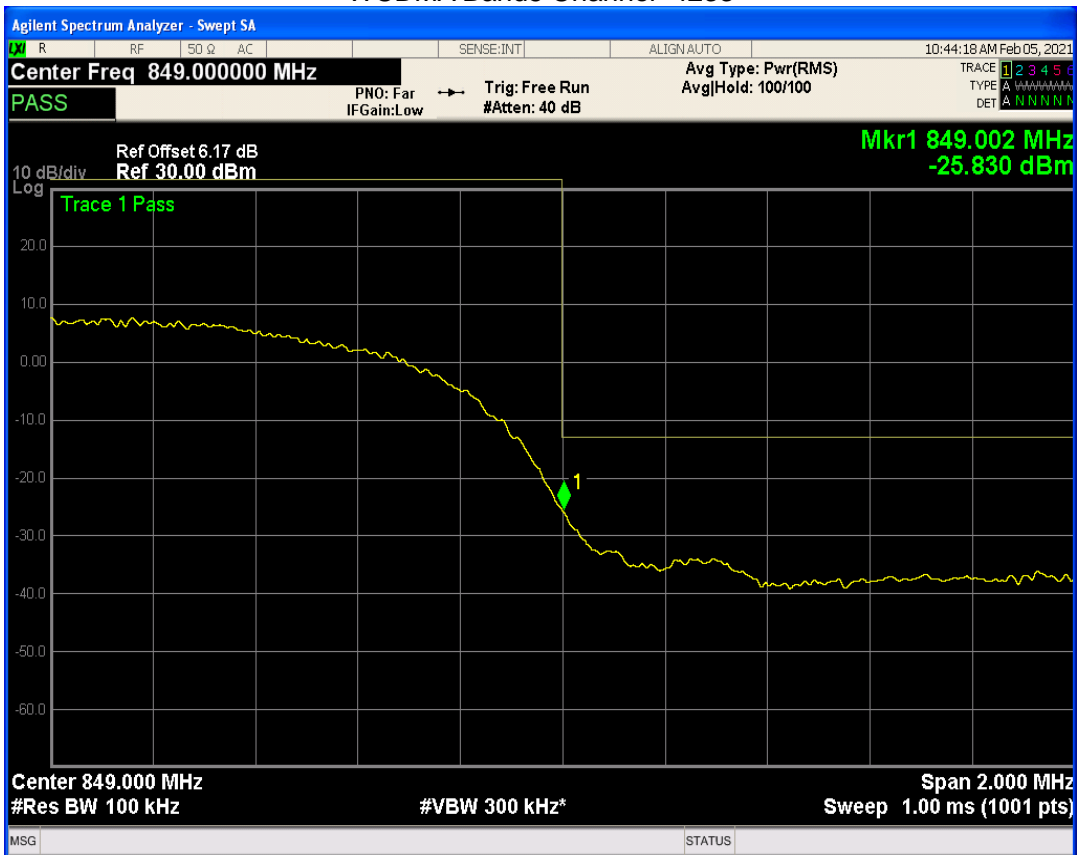

WCDMA Band5 Channel=4132

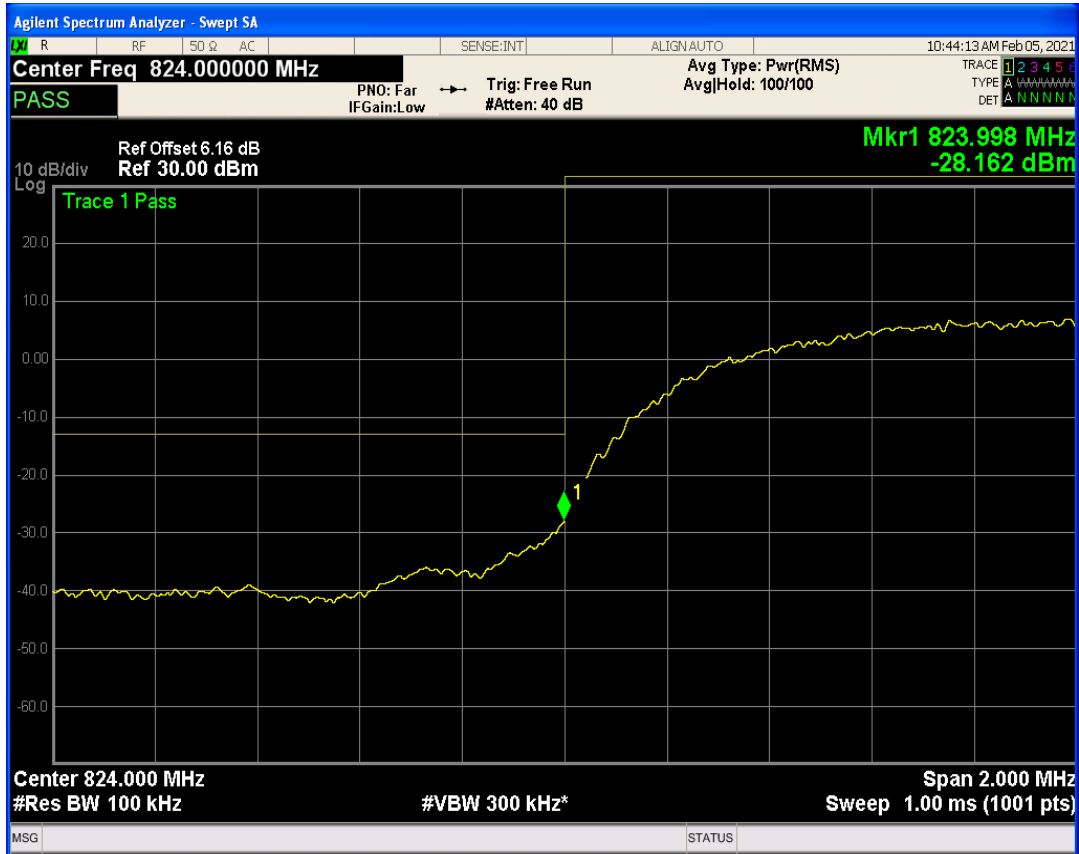

GSM1900 Channel=810

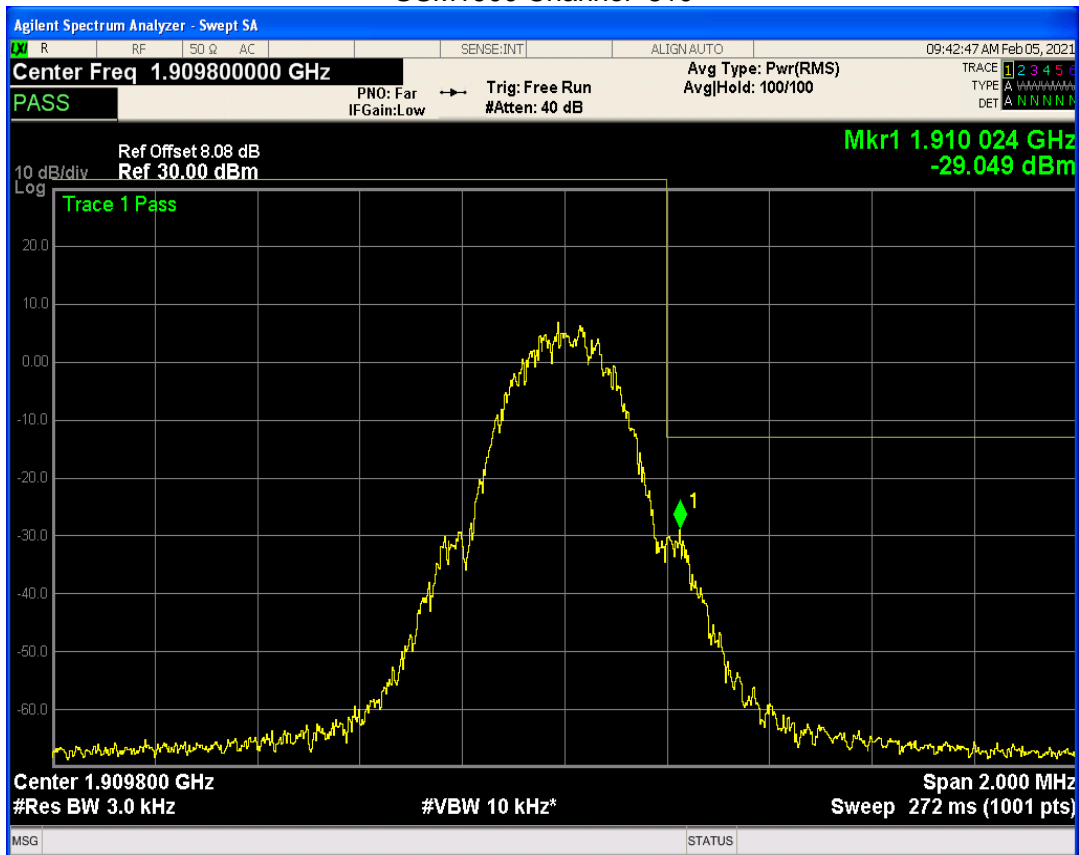

GSM1900 Channel=512

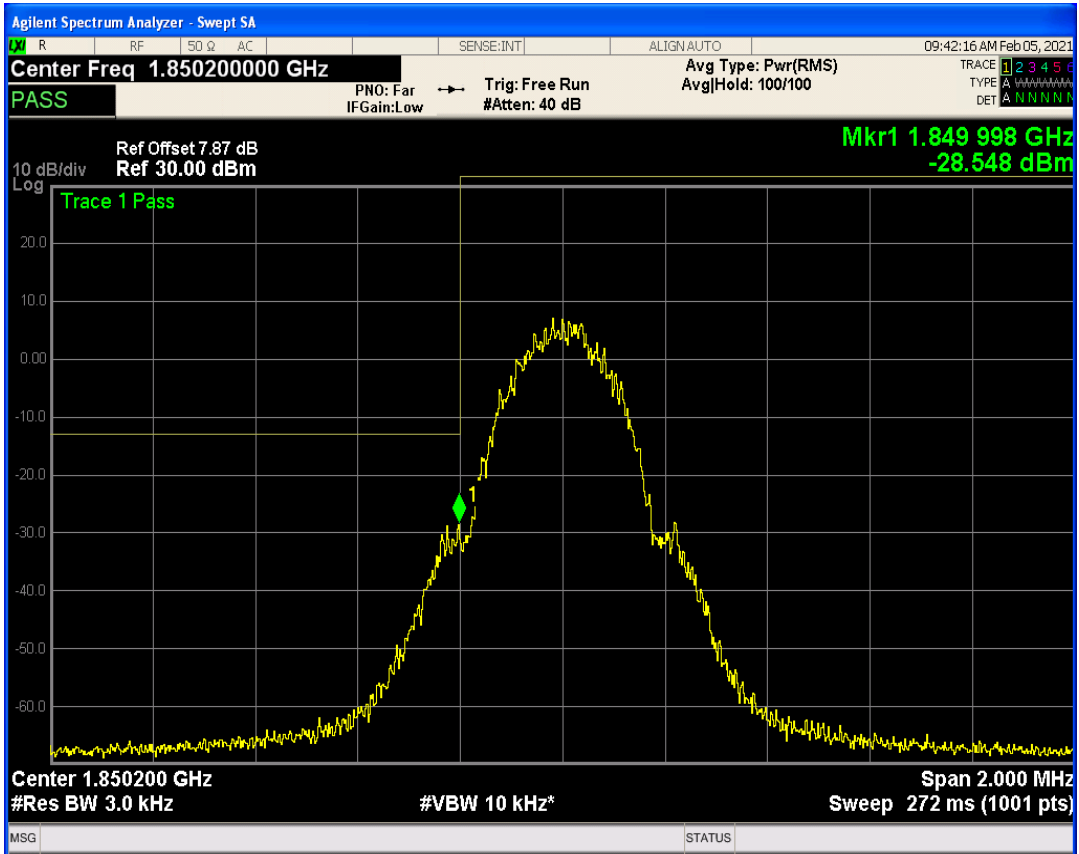

GSM850 Channel=251

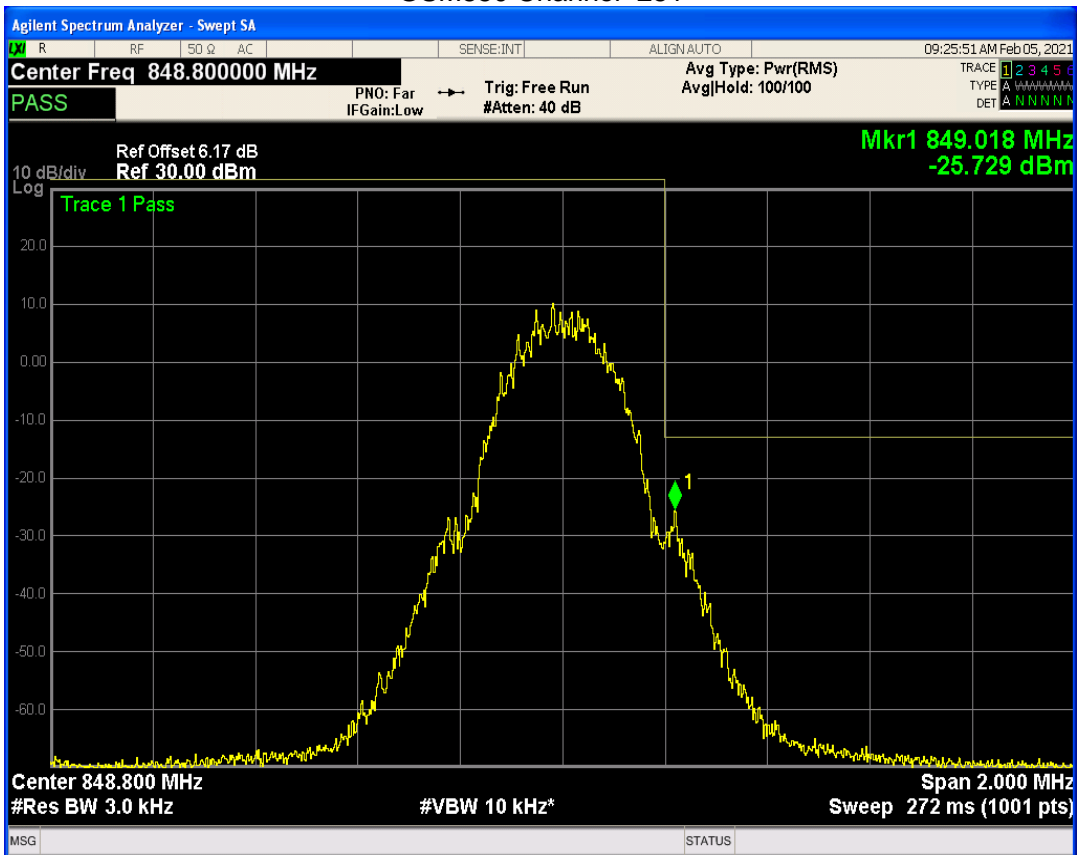

GSM850 Channel=128

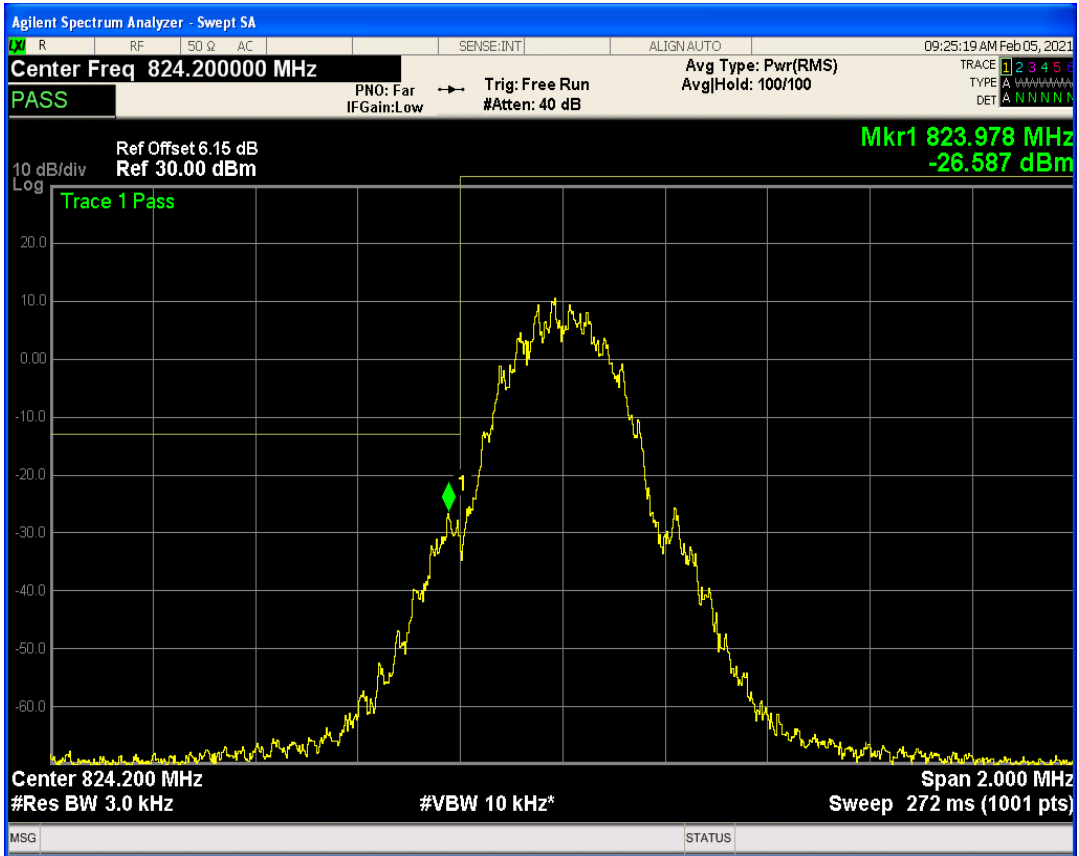

8.5 OUT-OF-BAND EMISSIONS

Band	Channel	Frequency (MHz)	Spur Freq (MHz)	Spur Level (dBm)	Limit (dBm)	Verdict
WCDMA Band2	9262	1852.4	19897.65	-23.60	-13	PASS
WCDMA Band2	9400	1880	19912.13	-23.52	-13	PASS
WCDMA Band2	9538	1907.6	19855.22	-22.96	-13	PASS
WCDMA Band4	1312	1712.4	17094.86	-23.50	-13	PASS
WCDMA Band4	1413	1732.6	19749.38	-23.92	-13	PASS
WCDMA Band4	1513	1752.6	19915.13	-23.71	-13	PASS
WCDMA Band5	4132	826.4	3310.13	-28.47	-13	PASS
WCDMA Band5	4182	836.4	3124.44	-30.21	-13	PASS
WCDMA Band5	4233	846.6	3383.66	-29.65	-13	PASS
GSM1900	512	1850.2	19872.19	-24.15	-13	PASS
GSM1900	661	1880	19964.05	-23.28	-13	PASS
GSM1900	810	1909.8	19904.64	-23.74	-13	PASS
GSM850	128	824.2	1648.38	-29.44	-13	PASS
GSM850	189	836.4	3148.12	-30.09	-13	PASS
GSM850	251	848.8	2637.40	-29.74	-13	PASS

WCDMA Band2 Channel=9400

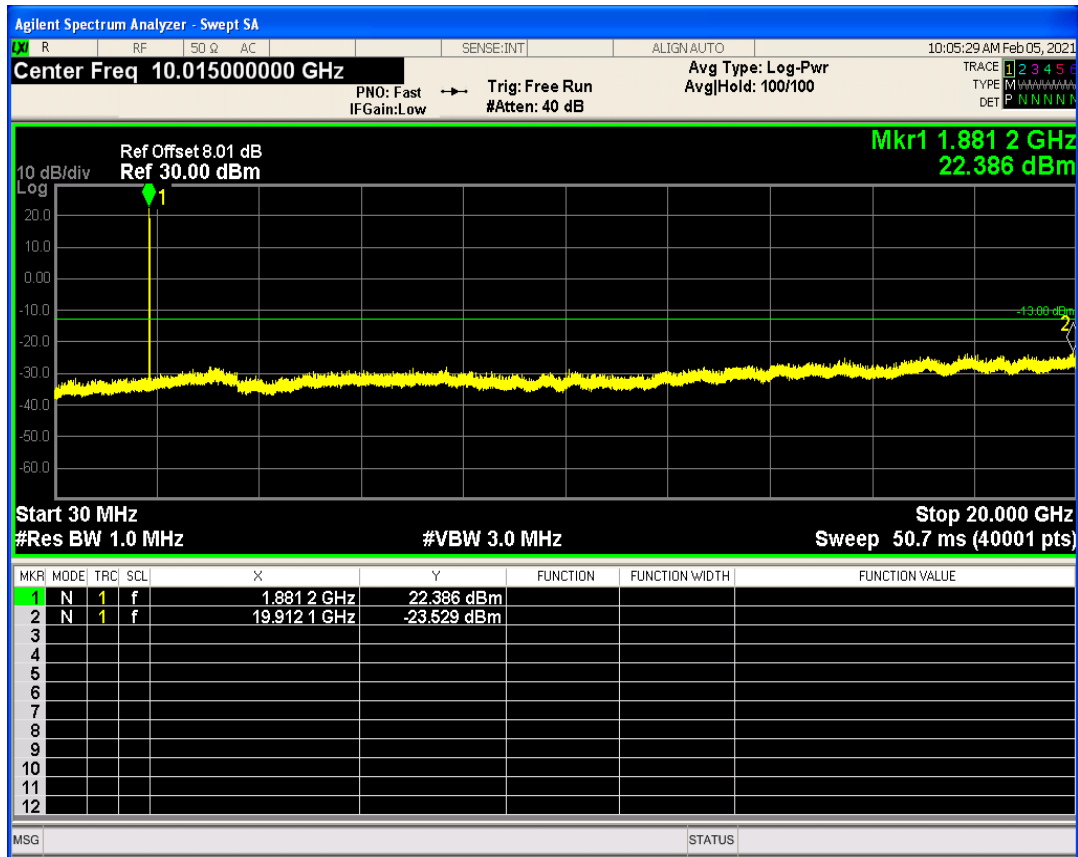

WCDMA Band2 Channel=9262

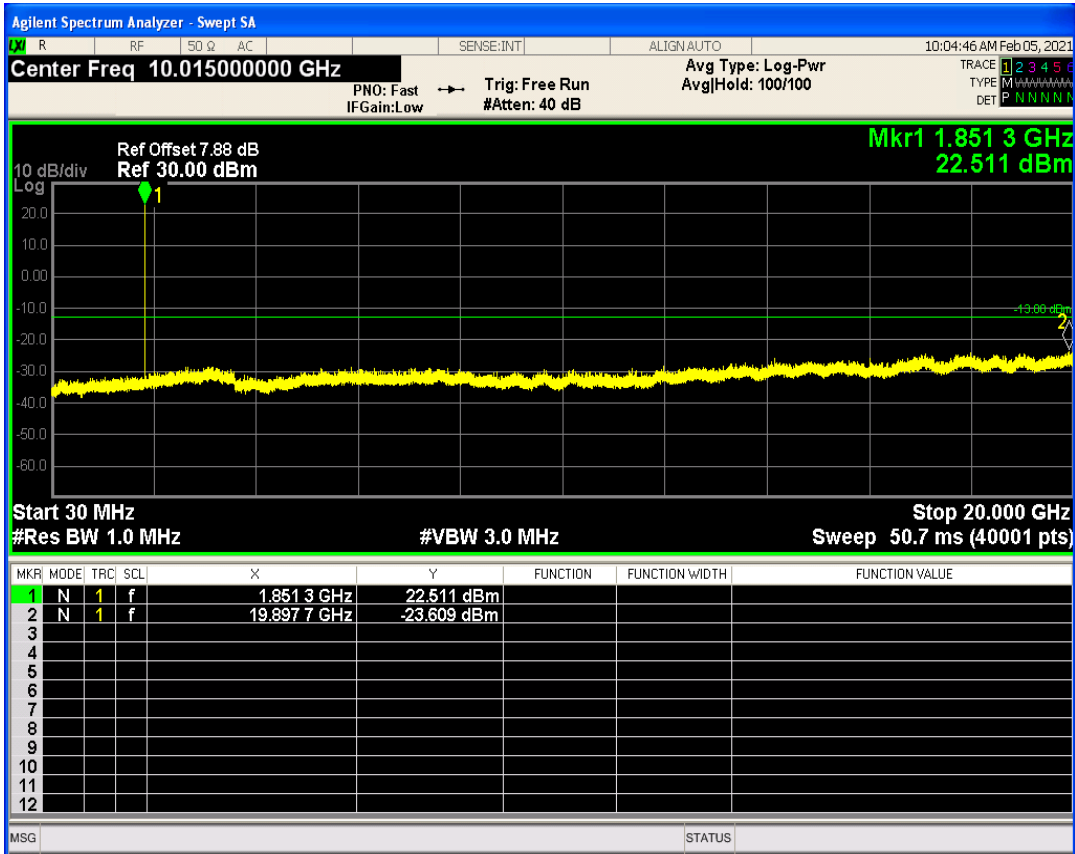

WCDMA Band2 Channel=9538

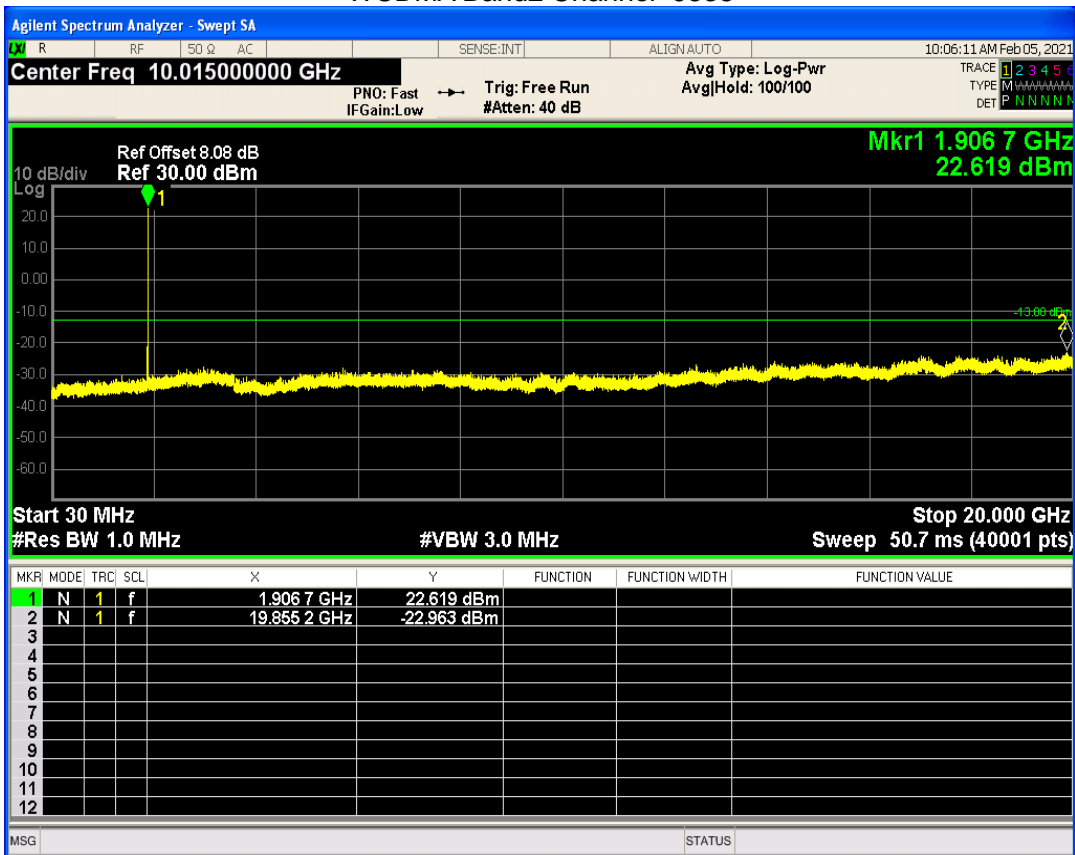

WCDMA Band4 Channel=1413

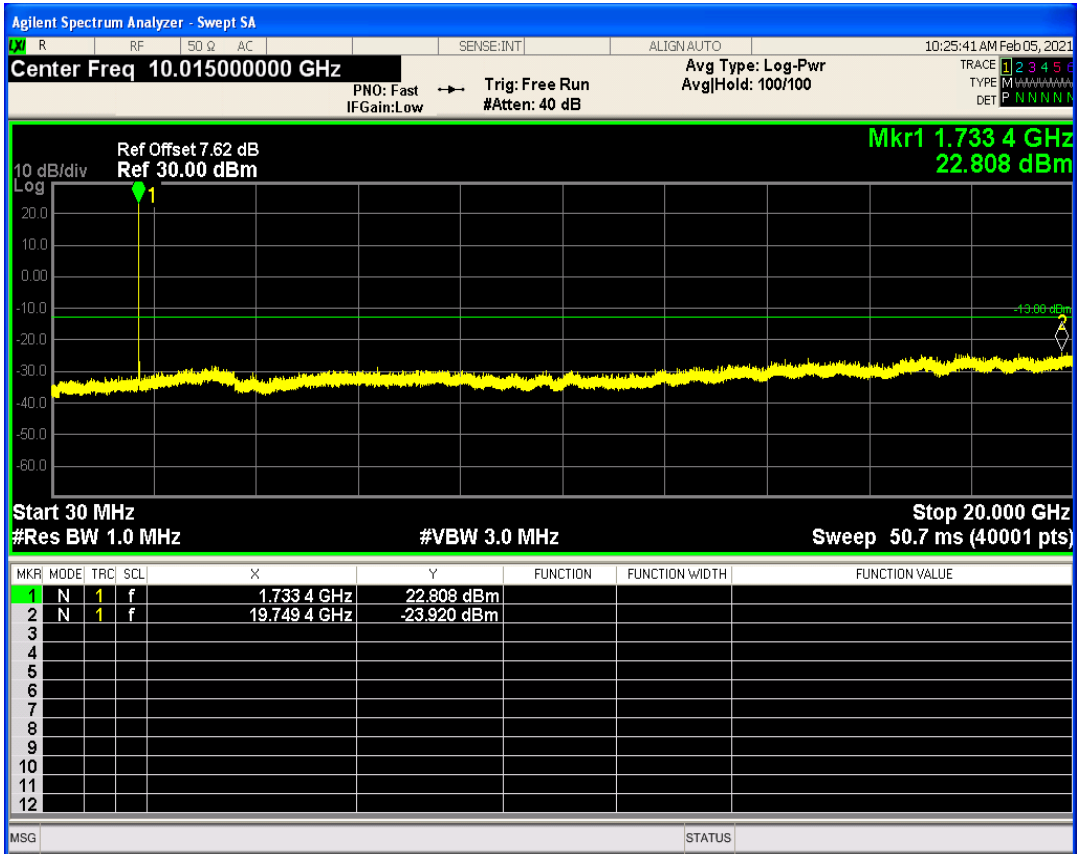

WCDMA Band4 Channel=1312

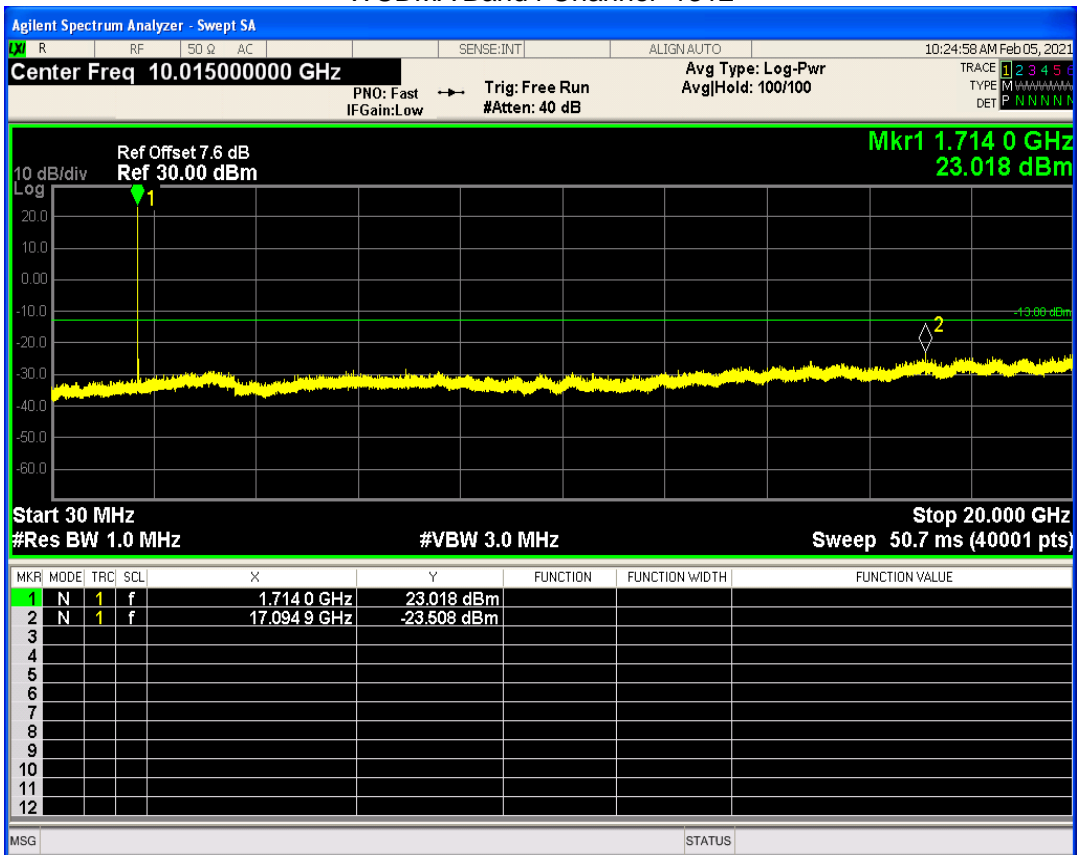

WCDMA Band4 Channel=1513

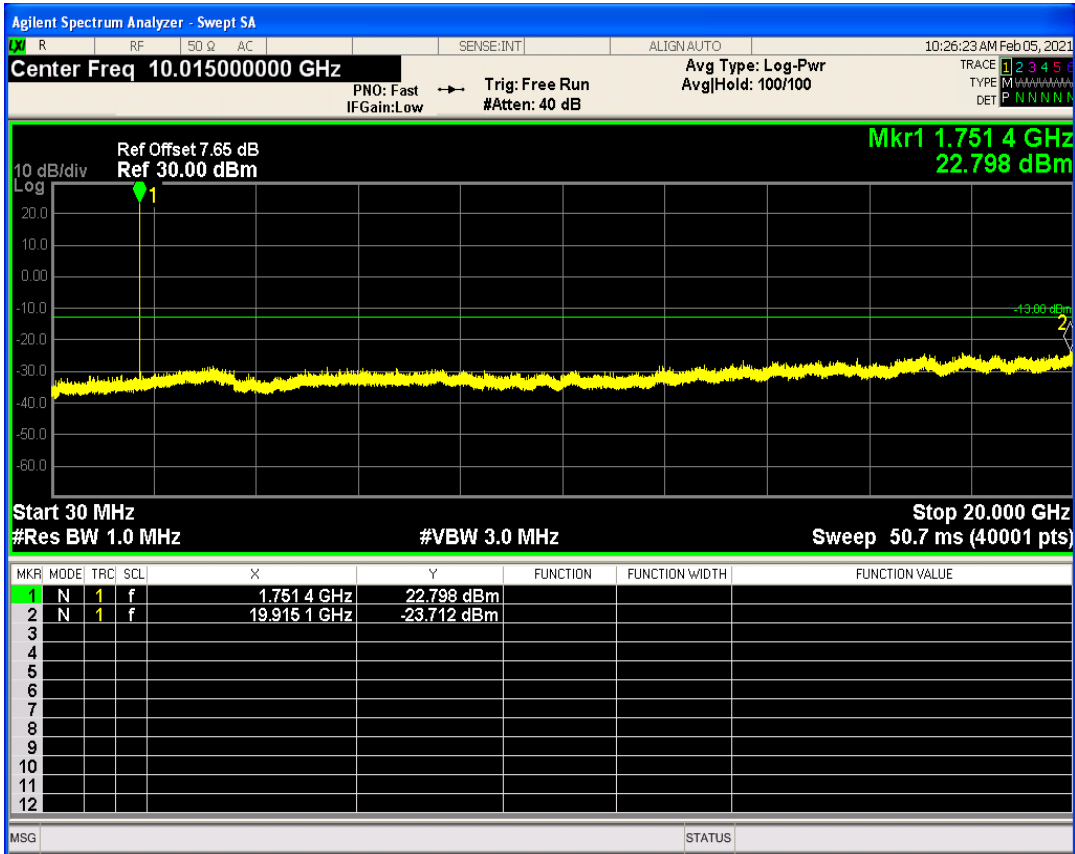

WCDMA Band5 Channel=4132

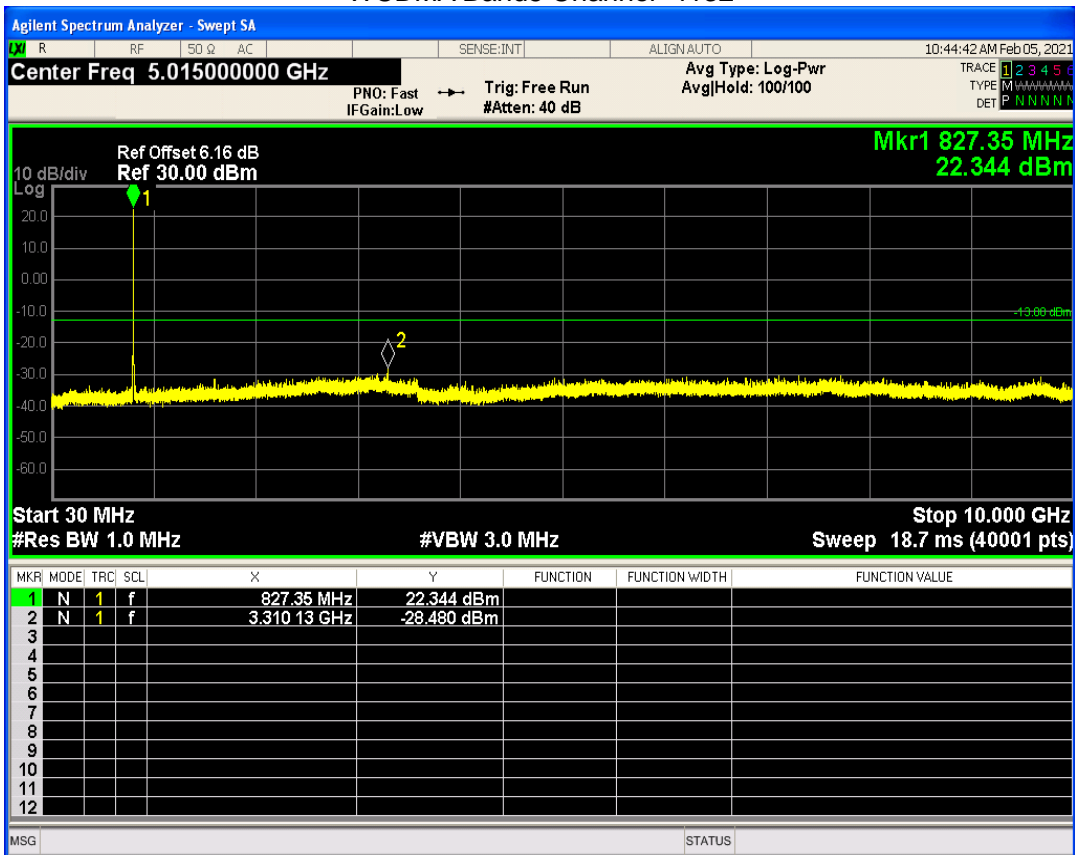

WCDMA Band5 Channel=4182

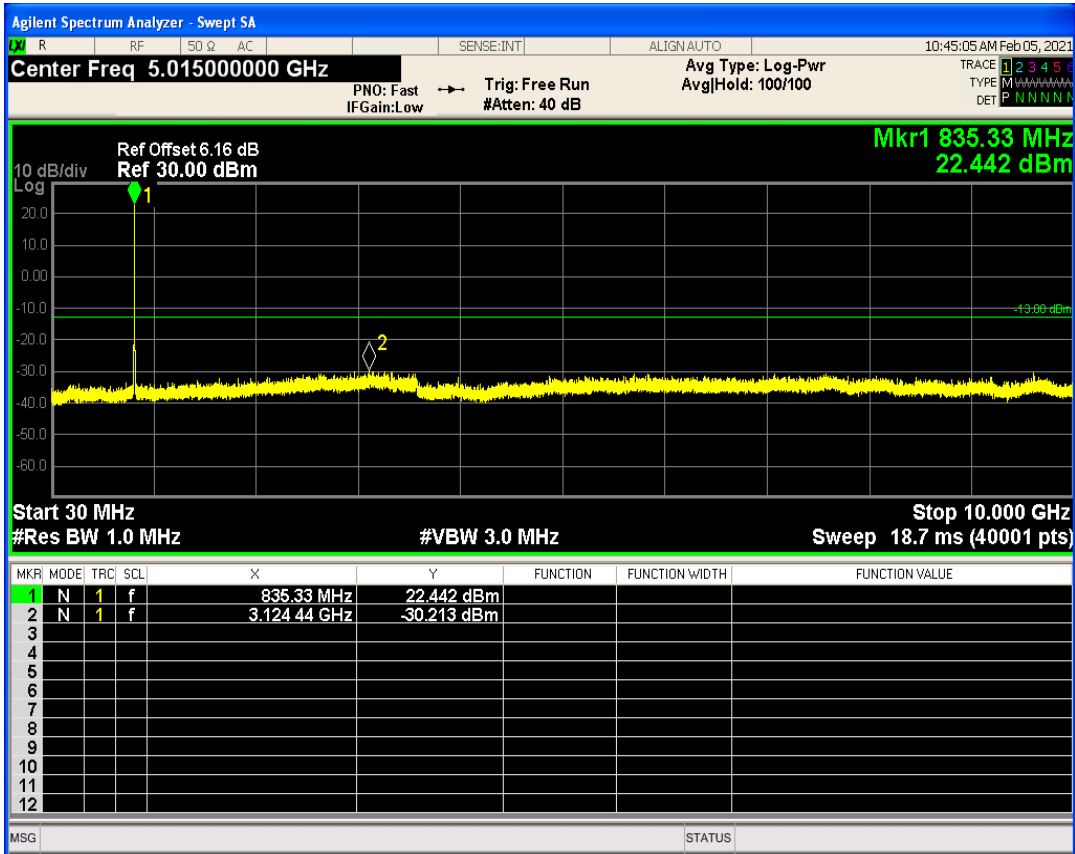

WCDMA Band5 Channel=4233

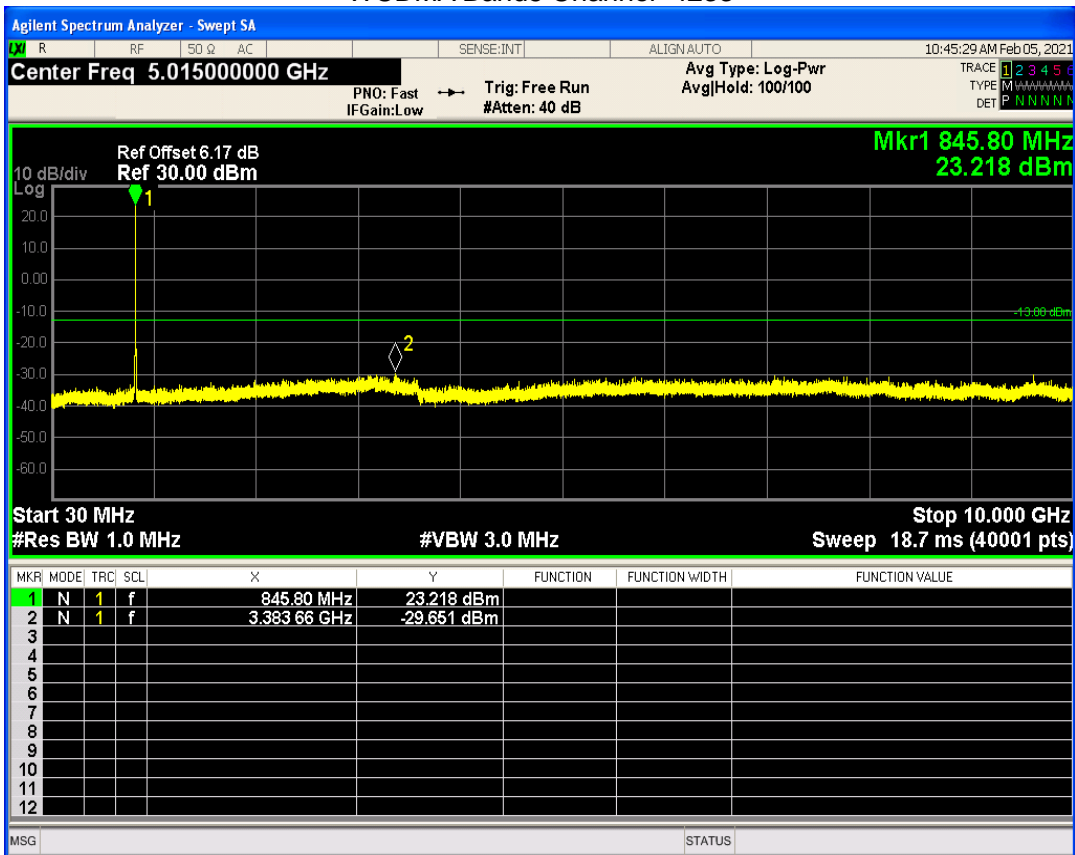

GSM1900 Channel=512

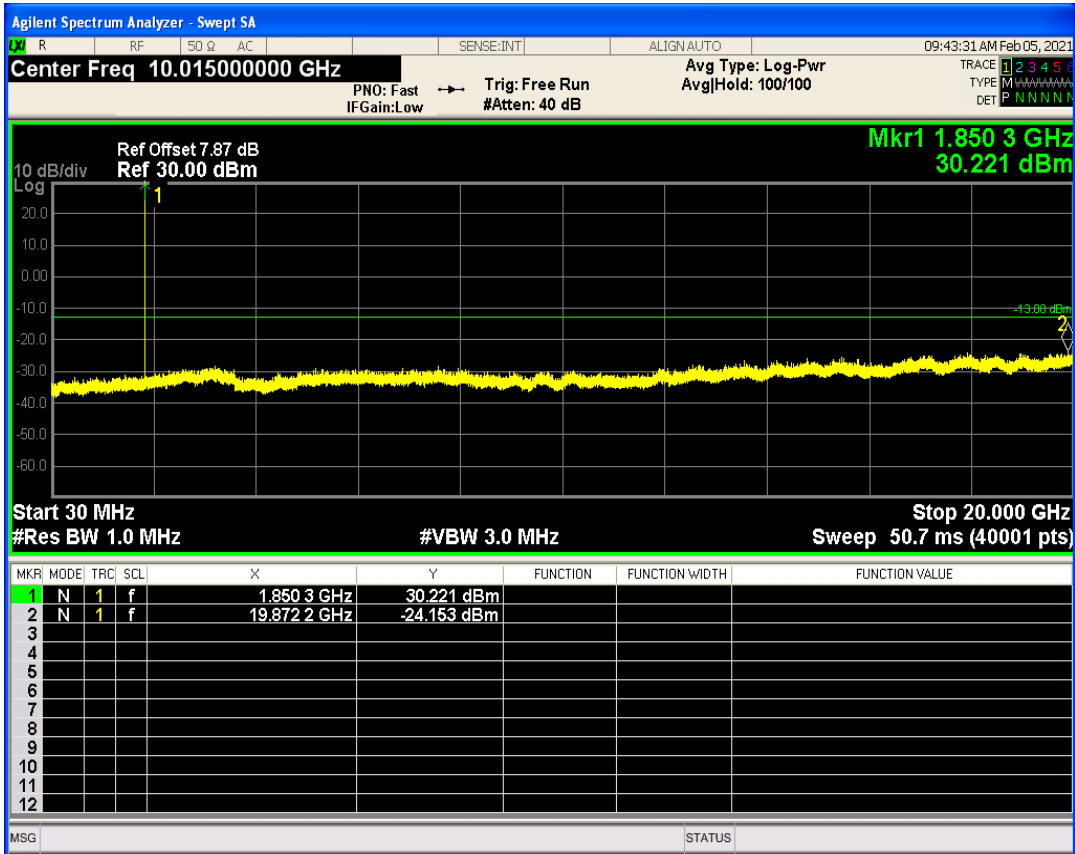

GSM1900 Channel=661

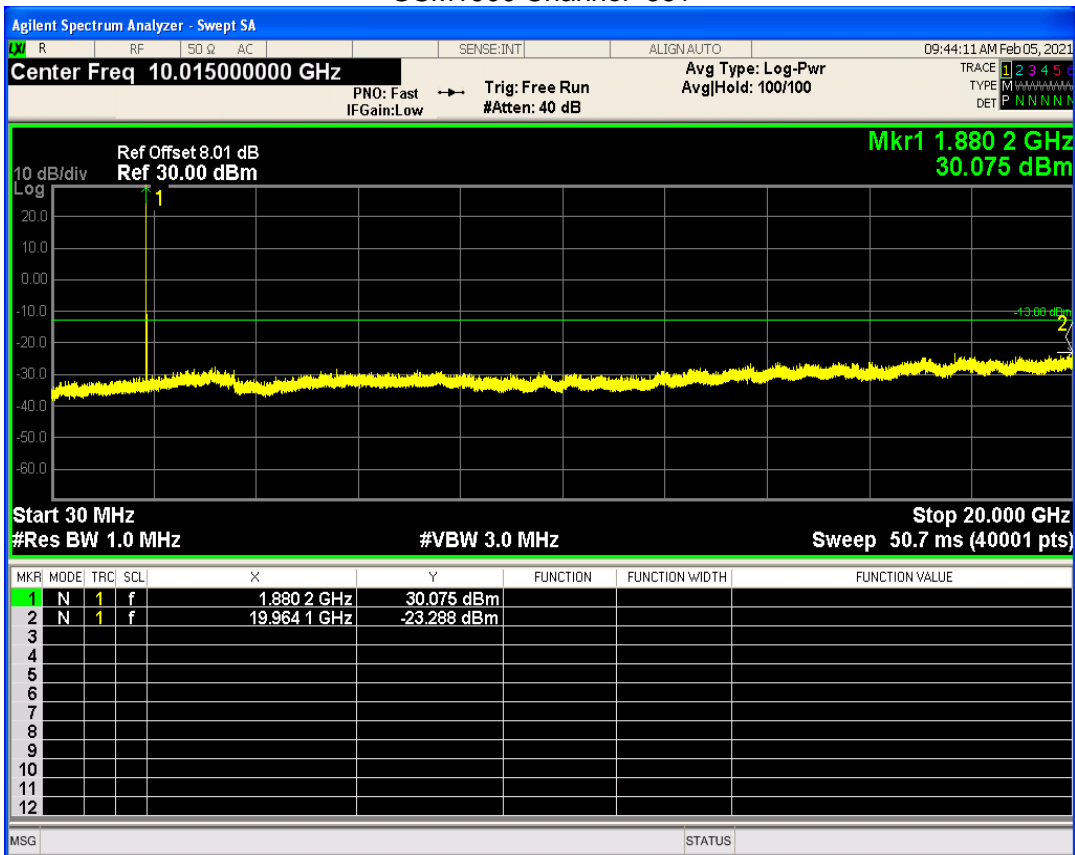

GSM1900 Channel=810

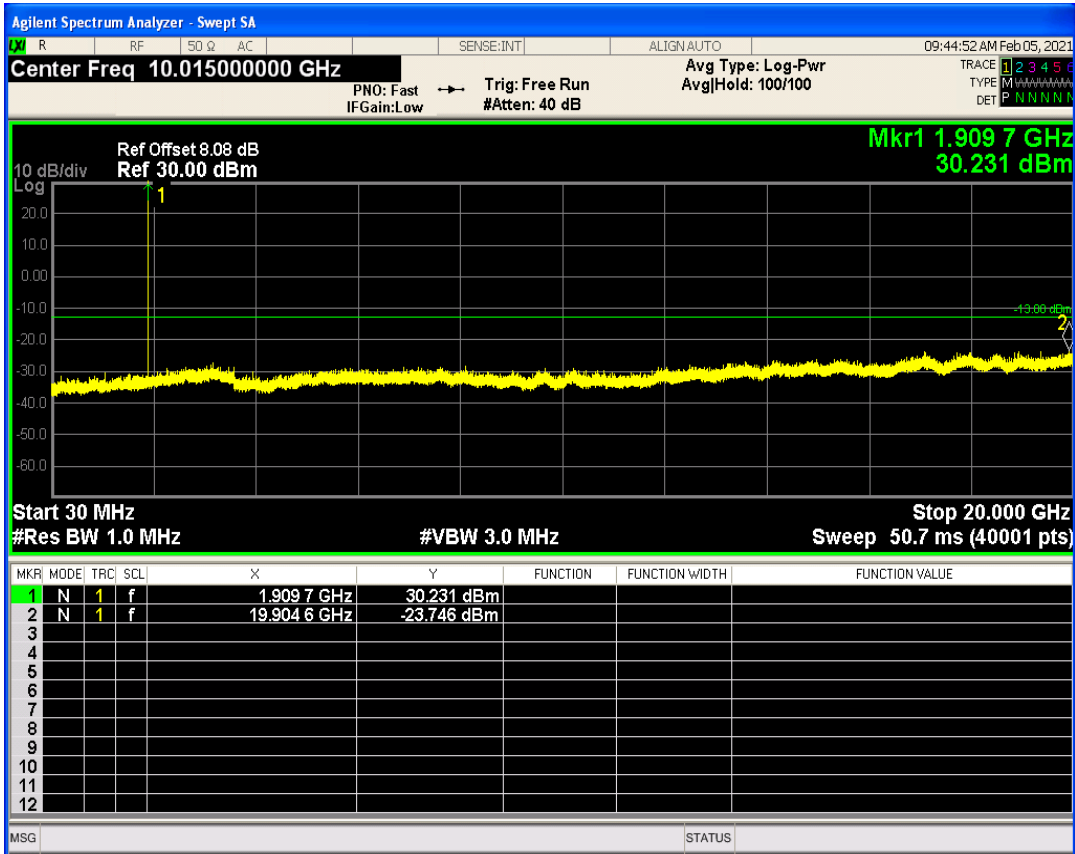

GSM850 Channel=128

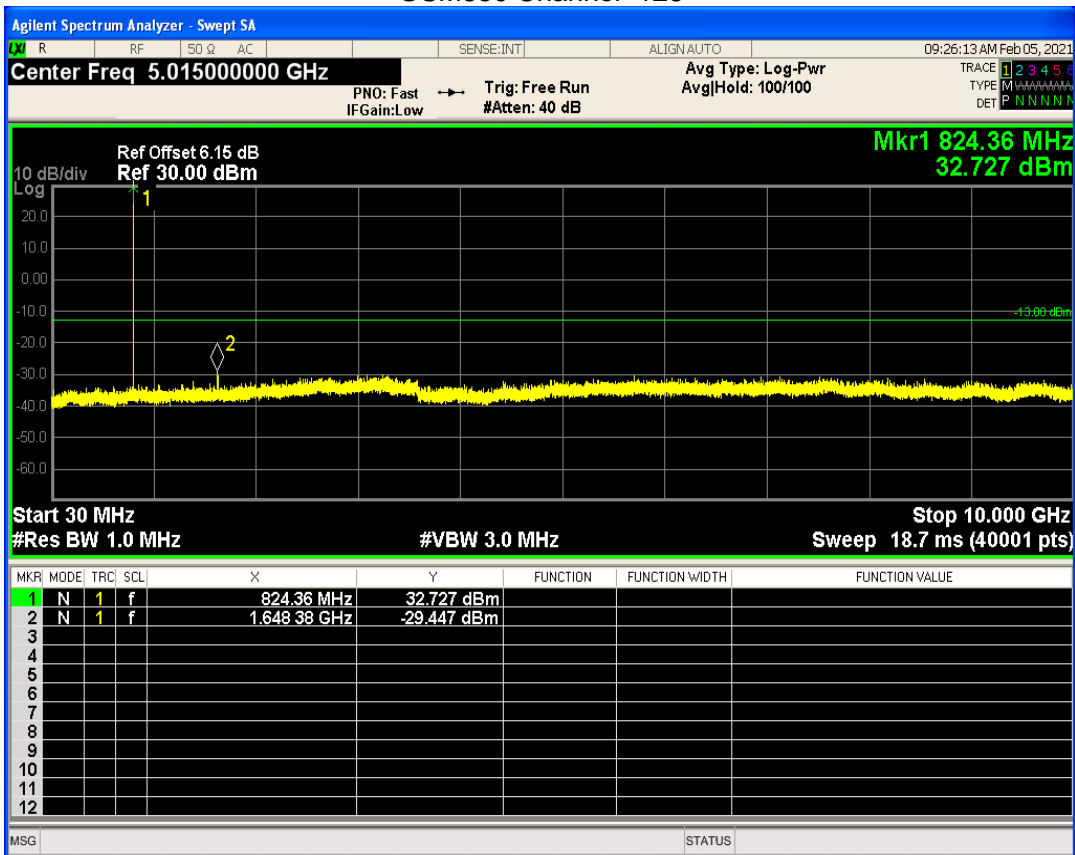

GSM850 Channel=251

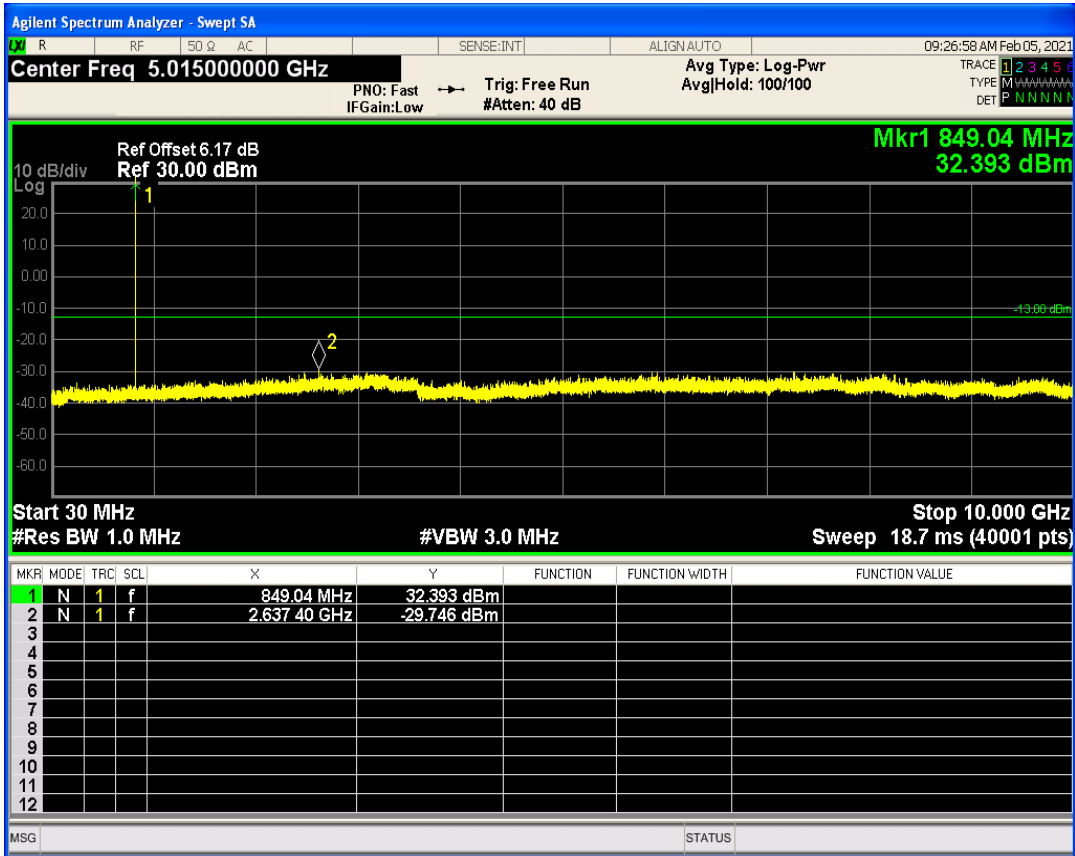

GSM850 Channel=189

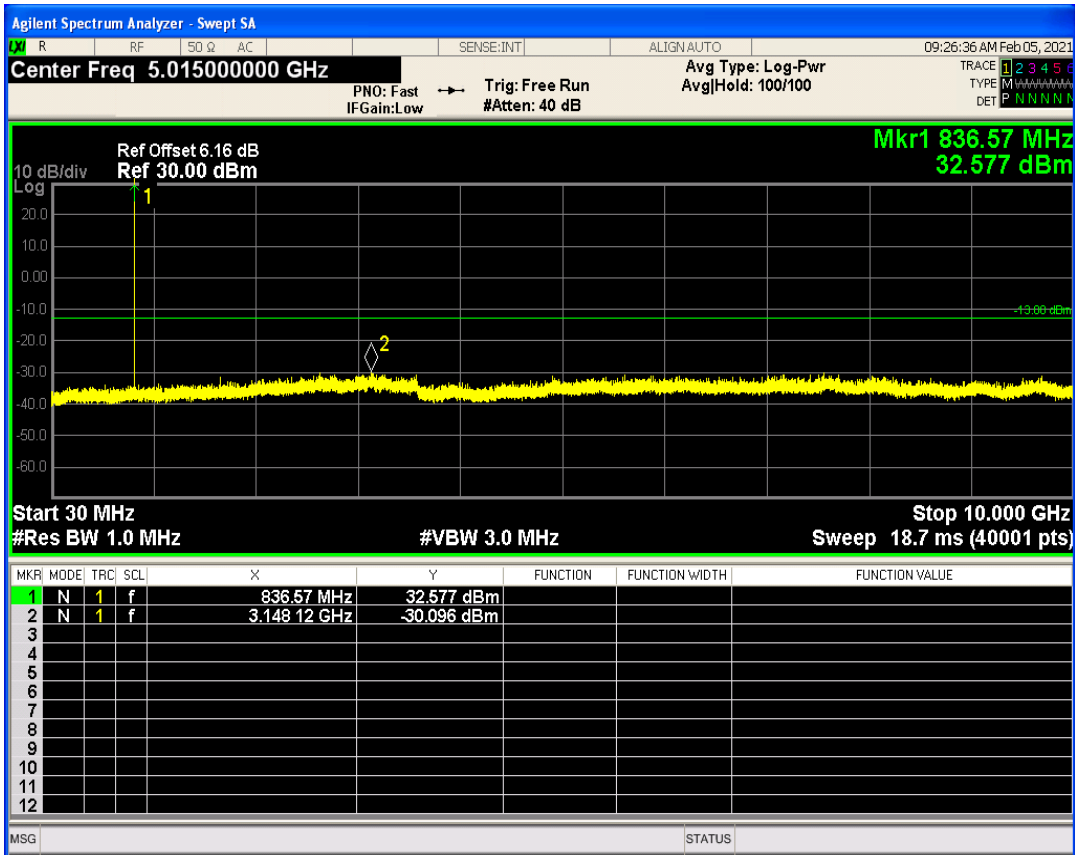

8.6 CONDUCTED OUTPUT POWER

Band	Channel	Frequency (MHz)	Power (dBm)	Verdict
HSDPA Band2 Subtest1	9262	1852.4	21.72	PASS
HSDPA Band2 Subtest2	9262	1852.4	21.42	PASS
HSDPA Band2 Subtest3	9262	1852.4	21.12	PASS
HSDPA Band2 Subtest4	9262	1852.4	20.92	PASS
HSDPA Band2 Subtest1	9400	1880	21.52	PASS
HSDPA Band2 Subtest2	9400	1880	21.24	PASS
HSDPA Band2 Subtest3	9400	1880	20.79	PASS
HSDPA Band2 Subtest4	9400	1880	20.65	PASS
HSDPA Band2 Subtest1	9538	1907.6	21.48	PASS
HSDPA Band2 Subtest2	9538	1907.6	21.23	PASS
HSDPA Band2 Subtest3	9538	1907.6	20.99	PASS
HSDPA Band2 Subtest4	9538	1907.6	20.77	PASS
HSDPA Band4 Subtest1	1312	1712.4	22.03	PASS
HSDPA Band4 Subtest2	1312	1712.4	21.71	PASS
HSDPA Band4 Subtest3	1312	1712.4	21.37	PASS
HSDPA Band4 Subtest4	1312	1712.4	21.01	PASS
HSDPA Band4 Subtest1	1413	1732.6	22.19	PASS
HSDPA Band4 Subtest2	1413	1732.6	21.97	PASS
HSDPA Band4 Subtest3	1413	1732.6	21.66	PASS
HSDPA Band4 Subtest4	1413	1732.6	21.55	PASS
HSDPA Band4 Subtest1	1513	1752.6	21.72	PASS
HSDPA Band4 Subtest2	1513	1752.6	21.43	PASS
HSDPA Band4 Subtest3	1513	1752.6	21.22	PASS
HSDPA Band4 Subtest4	1513	1752.6	20.96	PASS
HSDPA Band5 Subtest1	4132	826.4	22.01	PASS
HSDPA Band5 Subtest2	4132	826.4	21.70	PASS
HSDPA Band5 Subtest3	4132	826.4	21.46	PASS
HSDPA Band5 Subtest4	4132	826.4	21.36	PASS
HSDPA Band5 Subtest1	4182	836.4	21.67	PASS
HSDPA Band5 Subtest2	4182	836.4	21.58	PASS
HSDPA Band5 Subtest3	4182	836.4	21.27	PASS
HSDPA Band5 Subtest4	4182	836.4	21.10	PASS
HSDPA Band5 Subtest1	4233	846.6	22.37	PASS
HSDPA Band5 Subtest2	4233	846.6	22.13	PASS
HSDPA Band5 Subtest3	4233	846.6	21.88	PASS
HSDPA Band5 Subtest4	4233	846.6	21.55	PASS
GPRS1900 1 Slot	512	1850.2	29.79	PASS
GPRS1900 1 Slot	661	1880	29.74	PASS
GPRS1900 1 Slot	810	1909.8	29.73	PASS
GPRS1900 2 Slot	512	1850.2	27.63	PASS
GPRS1900 2 Slot	661	1880	27.41	PASS
GPRS1900 2 Slot	810	1909.8	27.23	PASS
GPRS1900 3 Slot	512	1850.2	26.18	PASS
GPRS1900 3 Slot	661	1880	25.95	PASS
GPRS1900 3 Slot	810	1909.8	25.76	PASS
GPRS1900 4 Slot	512	1850.2	24.05	PASS
GPRS1900 4 Slot	661	1880	23.80	PASS
GPRS1900 4 Slot	810	1909.8	23.58	PASS
GPRS850 1 Slot	128	824.2	32.37	PASS
GPRS850 1 Slot	189	836.4	32.47	PASS
GPRS850 1 Slot	251	848.8	32.30	PASS
GPRS850 2 Slot	128	824.2	30.27	PASS

GPRS850 2 Slot	189	836.4	30.34	PASS
GPRS850 2 Slot	251	848.8	30.19	PASS
GPRS850 3 Slot	128	824.2	28.31	PASS
GPRS850 3 Slot	189	836.4	28.40	PASS
GPRS850 3 Slot	251	848.8	28.21	PASS
GPRS850 4 Slot	128	824.2	26.13	PASS
GPRS850 4 Slot	189	836.4	26.17	PASS
GPRS850 4 Slot	251	848.8	26.06	PASS

8.7 CONDUCTED OUTPUT POWER

Band	Channel	Frequency (MHz)	Power (dBm)	Verdict
EGPRS1900 1 Slot	512	1850.2	29.75	PASS
EGPRS1900 1 Slot	661	1880	29.70	PASS
EGPRS1900 1 Slot	810	1909.8	29.70	PASS
EGPRS1900 2 Slot	512	1850.2	27.60	PASS
EGPRS1900 2 Slot	661	1880	27.39	PASS
EGPRS1900 2 Slot	810	1909.8	27.19	PASS
EGPRS1900 3 Slot	512	1850.2	26.14	PASS
EGPRS1900 3 Slot	661	1880	25.90	PASS
EGPRS1900 3 Slot	810	1909.8	25.74	PASS
EGPRS1900 4 Slot	512	1850.2	24.02	PASS
EGPRS1900 4 Slot	661	1880	23.78	PASS
EGPRS1900 4 Slot	810	1909.8	23.57	PASS
EGPRS850 1 Slot	128	824.2	32.35	PASS
EGPRS850 1 Slot	189	836.4	32.45	PASS
EGPRS850 1 Slot	251	848.8	32.28	PASS
EGPRS850 2 Slot	128	824.2	30.27	PASS
EGPRS850 2 Slot	189	836.4	30.32	PASS
EGPRS850 2 Slot	251	848.8	30.16	PASS
EGPRS850 3 Slot	128	824.2	28.30	PASS
EGPRS850 3 Slot	189	836.4	28.36	PASS
EGPRS850 3 Slot	251	848.8	28.20	PASS
EGPRS850 4 Slot	128	824.2	26.08	PASS
EGPRS850 4 Slot	189	836.4	26.12	PASS
EGPRS850 4 Slot	251	848.8	26.02	PASS
HSUPA Band2 Subtest1	9262	1852.4	21.62	PASS
HSUPA Band2 Subtest2	9262	1852.4	21.76	PASS
HSUPA Band2 Subtest3	9262	1852.4	21.51	PASS
HSUPA Band2 Subtest4	9262	1852.4	21.41	PASS
HSUPA Band2 Subtest5	9262	1852.4	21.31	PASS
HSUPA Band2 Subtest1	9400	1880	21.33	PASS
HSUPA Band2 Subtest2	9400	1880	21.50	PASS
HSUPA Band2 Subtest3	9400	1880	21.07	PASS
HSUPA Band2 Subtest4	9400	1880	21.36	PASS
HSUPA Band2 Subtest5	9400	1880	21.32	PASS
HSUPA Band2 Subtest1	9538	1907.6	21.32	PASS
HSUPA Band2 Subtest2	9538	1907.6	21.48	PASS
HSUPA Band2 Subtest3	9538	1907.6	21.11	PASS
HSUPA Band2 Subtest4	9538	1907.6	21.24	PASS
HSUPA Band2 Subtest5	9538	1907.6	21.32	PASS
HSUPA Band4 Subtest1	1312	1712.4	21.93	PASS
HSUPA Band4 Subtest2	1312	1712.4	21.87	PASS
HSUPA Band4 Subtest3	1312	1712.4	21.59	PASS
HSUPA Band4 Subtest4	1312	1712.4	21.87	PASS
HSUPA Band4 Subtest5	1312	1712.4	21.56	PASS
HSUPA Band4 Subtest1	1413	1732.6	21.96	PASS
HSUPA Band4 Subtest2	1413	1732.6	22.16	PASS
HSUPA Band4 Subtest3	1413	1732.6	21.76	PASS
HSUPA Band4 Subtest4	1413	1732.6	22.13	PASS
HSUPA Band4 Subtest5	1413	1732.6	21.88	PASS
HSUPA Band4 Subtest1	1513	1752.6	21.59	PASS
HSUPA Band4 Subtest2	1513	1752.6	21.68	PASS

HSUPA Band4 Subtest3	1513	1752.6	21.27	PASS
HSUPA Band4 Subtest4	1513	1752.6	21.67	PASS
HSUPA Band4 Subtest5	1513	1752.6	21.40	PASS
HSUPA Band5 Subtest1	4132	826.4	22.04	PASS
HSUPA Band5 Subtest2	4132	826.4	21.86	PASS
HSUPA Band5 Subtest3	4132	826.4	21.56	PASS
HSUPA Band5 Subtest4	4132	826.4	21.65	PASS
HSUPA Band5 Subtest5	4132	826.4	21.82	PASS
HSUPA Band5 Subtest1	4182	836.4	21.57	PASS
HSUPA Band5 Subtest2	4182	836.4	21.63	PASS
HSUPA Band5 Subtest3	4182	836.4	21.22	PASS
HSUPA Band5 Subtest4	4182	836.4	21.33	PASS
HSUPA Band5 Subtest5	4182	836.4	21.35	PASS
HSUPA Band5 Subtest1	4233	846.6	22.08	PASS
HSUPA Band5 Subtest2	4233	846.6	22.31	PASS
HSUPA Band5 Subtest3	4233	846.6	21.66	PASS
HSUPA Band5 Subtest4	4233	846.6	22.10	PASS
HSUPA Band5 Subtest5	4233	846.6	22.10	PASS

8.8 PEAK-TO-AVERAGE RATIO

Band	Channel	Frequency (MHz)	Result (dB)	high Limit (dB)	Verdict
EGPRS1900	512	1850.2	2.66	13.00	PASS
EGPRS1900	661	1880	2.67	13.00	PASS
EGPRS1900	810	1909.8	2.69	13.00	PASS
EGPRS850	128	824.2	2.66	13.00	PASS
EGPRS850	189	836.4	2.65	13.00	PASS
EGPRS850	251	848.8	2.65	13.00	PASS

EGPRS1900 Channel=512

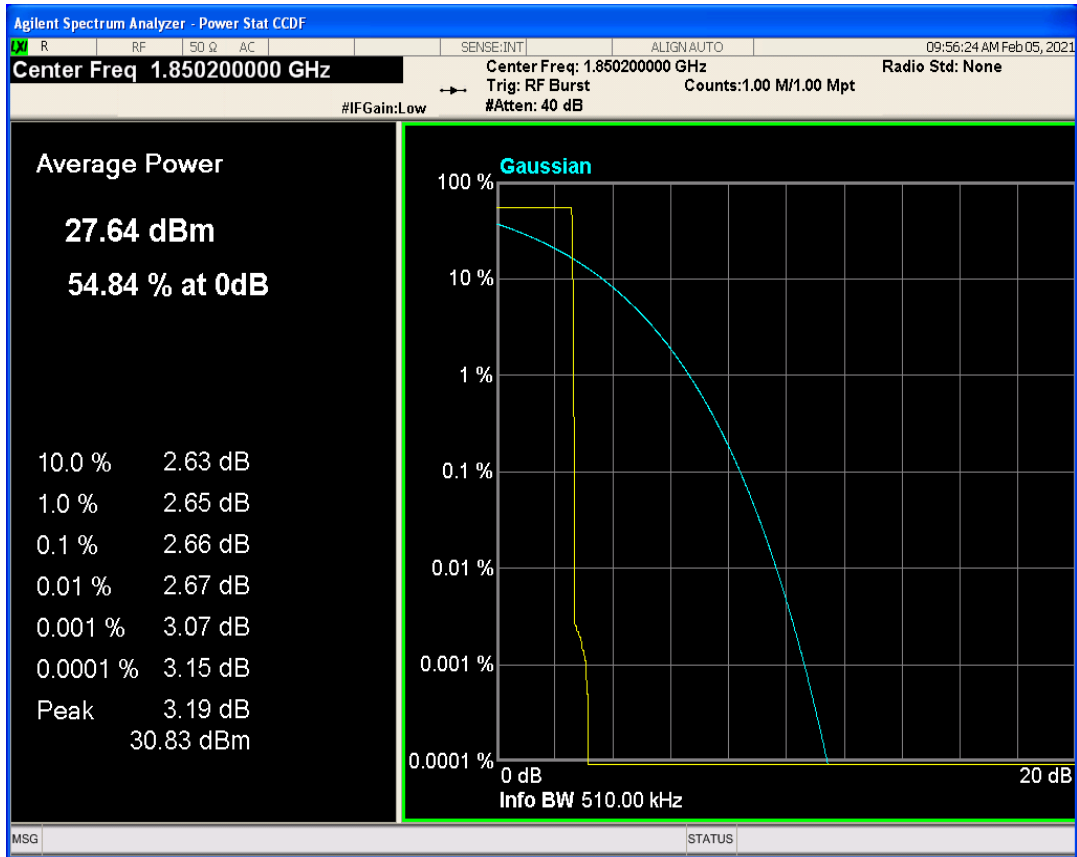

EGPRS1900 Channel=661

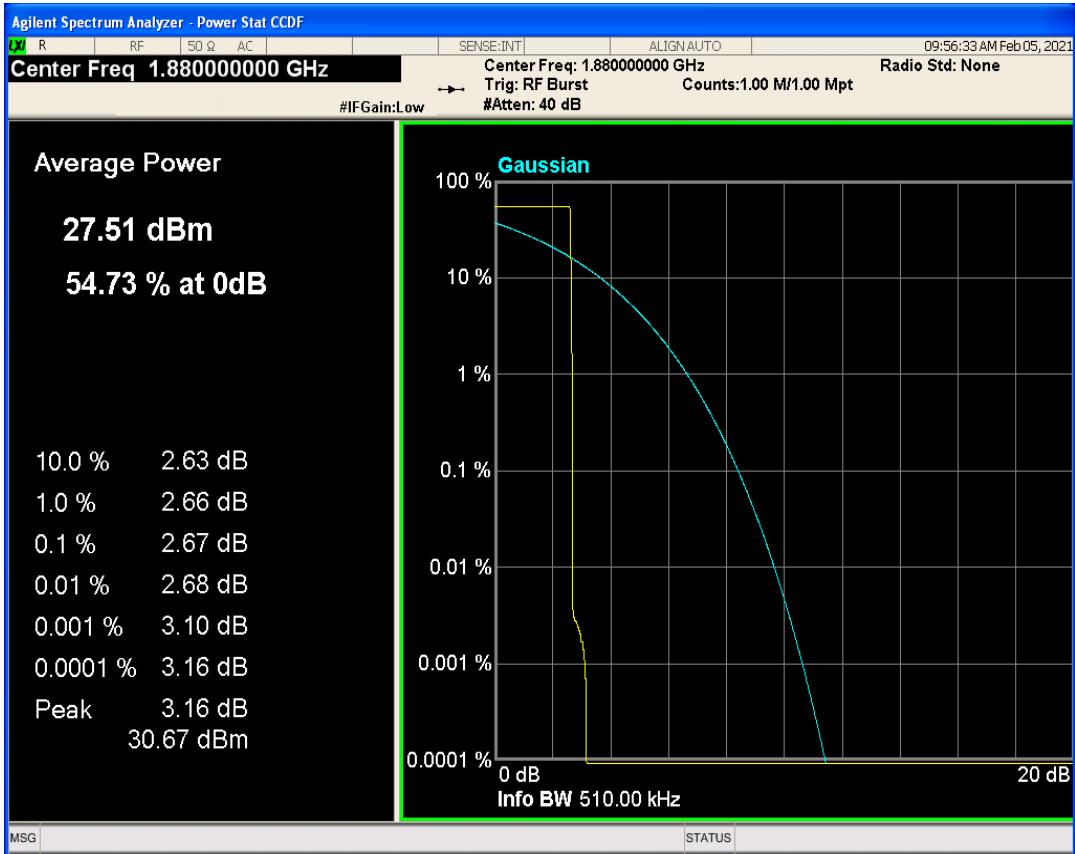

EGPRS1900 Channel=810

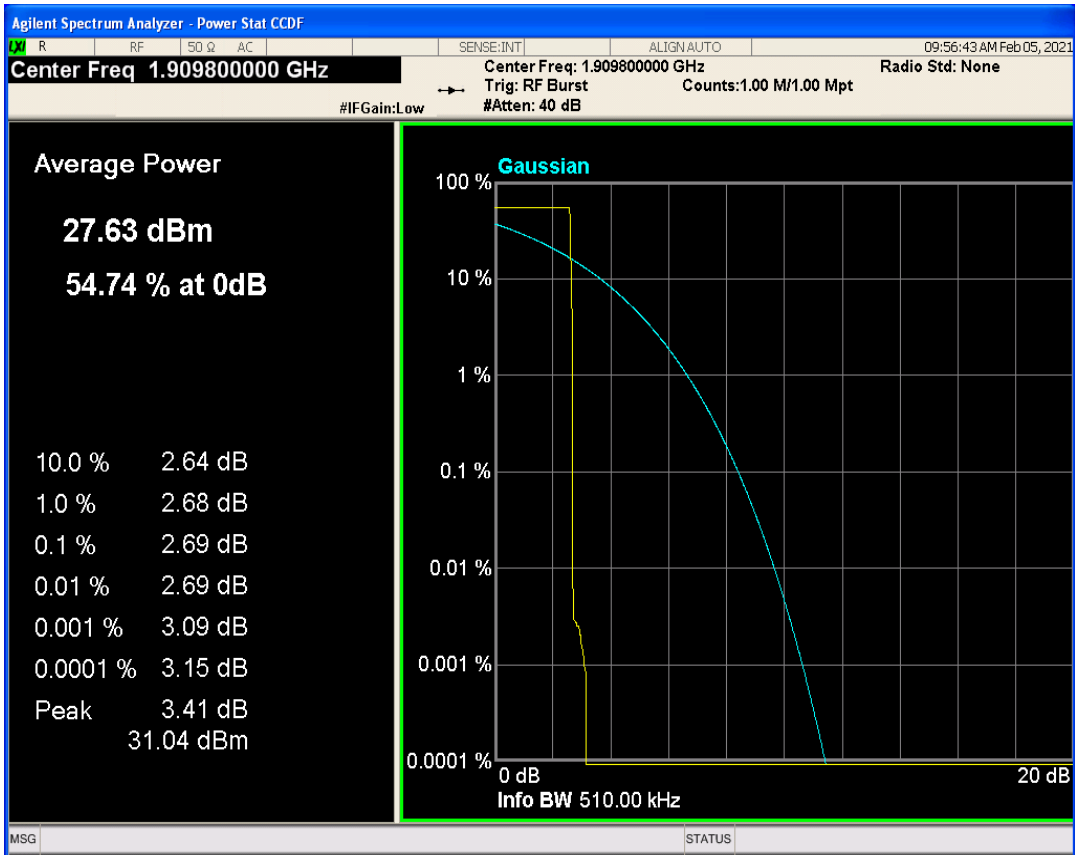

EGPRS850 Channel=128

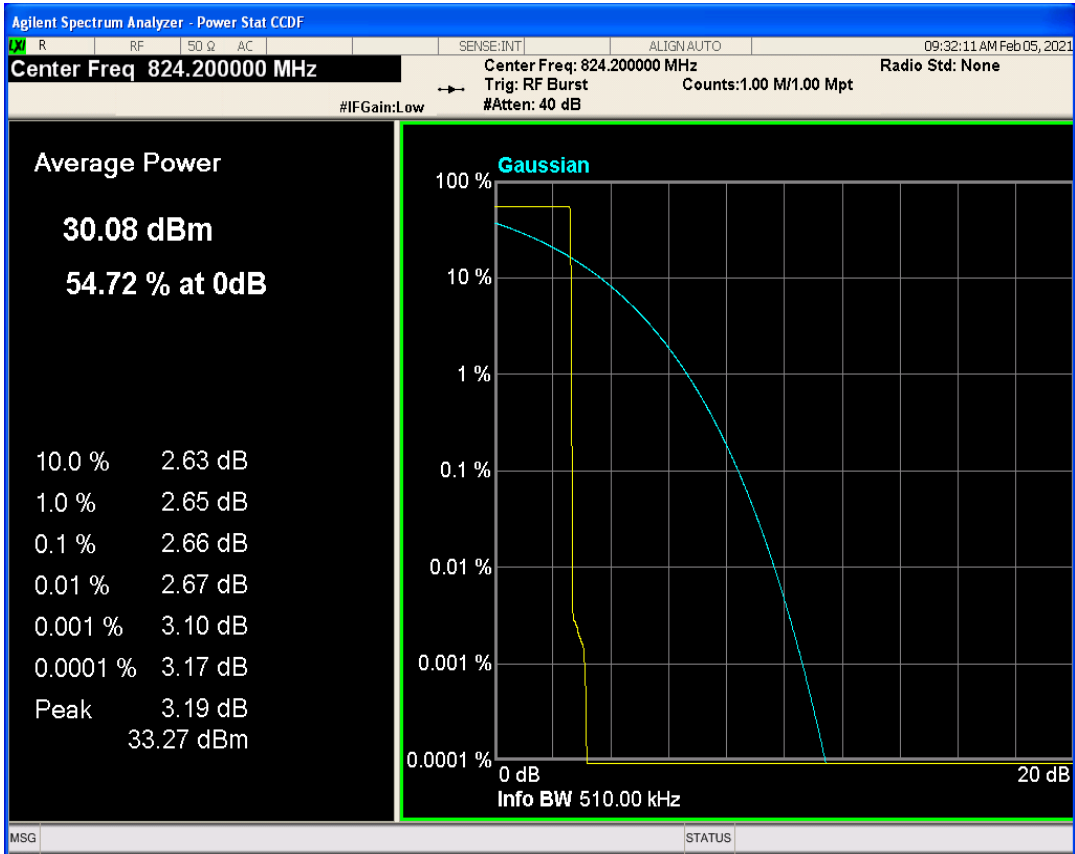

EGPRS850 Channel=251

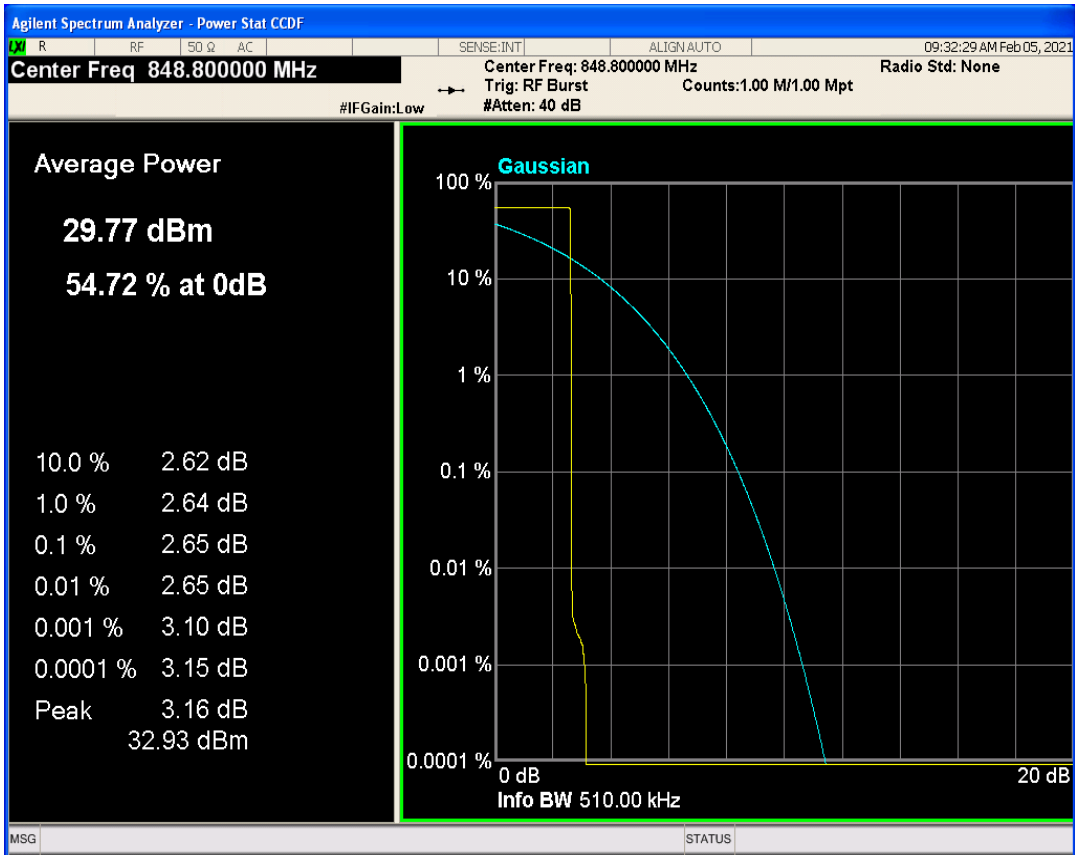

EGPRS850 Channel=189

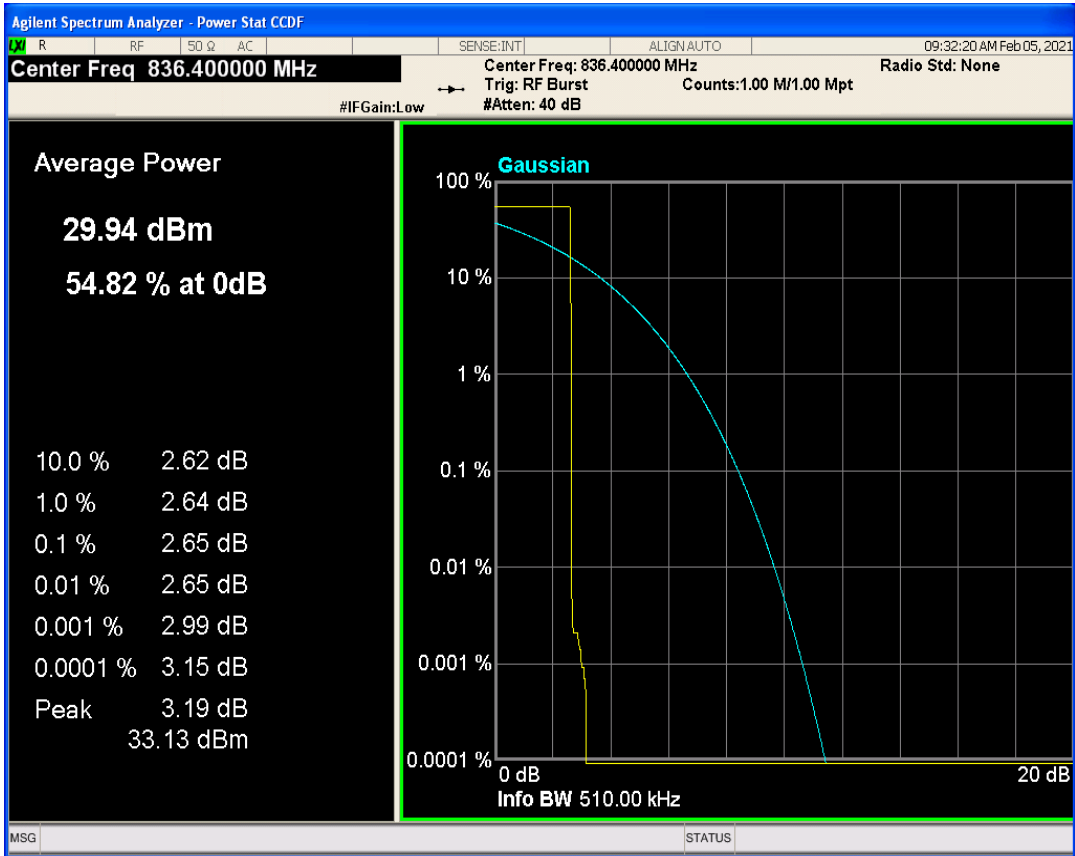

8.9 OCCUPIED BANDWIDTH

Band	Channel	Frequency (MHz)	99% OBW (kHz)	-26dB EBW (kHz)	Verdict
EGPRS1900	512	1850.2	247.163	312.808	PASS
EGPRS1900	661	1880	248.695	314.043	PASS
EGPRS1900	810	1909.8	253.336	329.584	PASS
EGPRS850	128	824.2	247.358	311.855	PASS
EGPRS850	189	836.4	248.002	322.779	PASS
EGPRS850	251	848.8	246.405	324.276	PASS

EGPRS1900 Channel=512

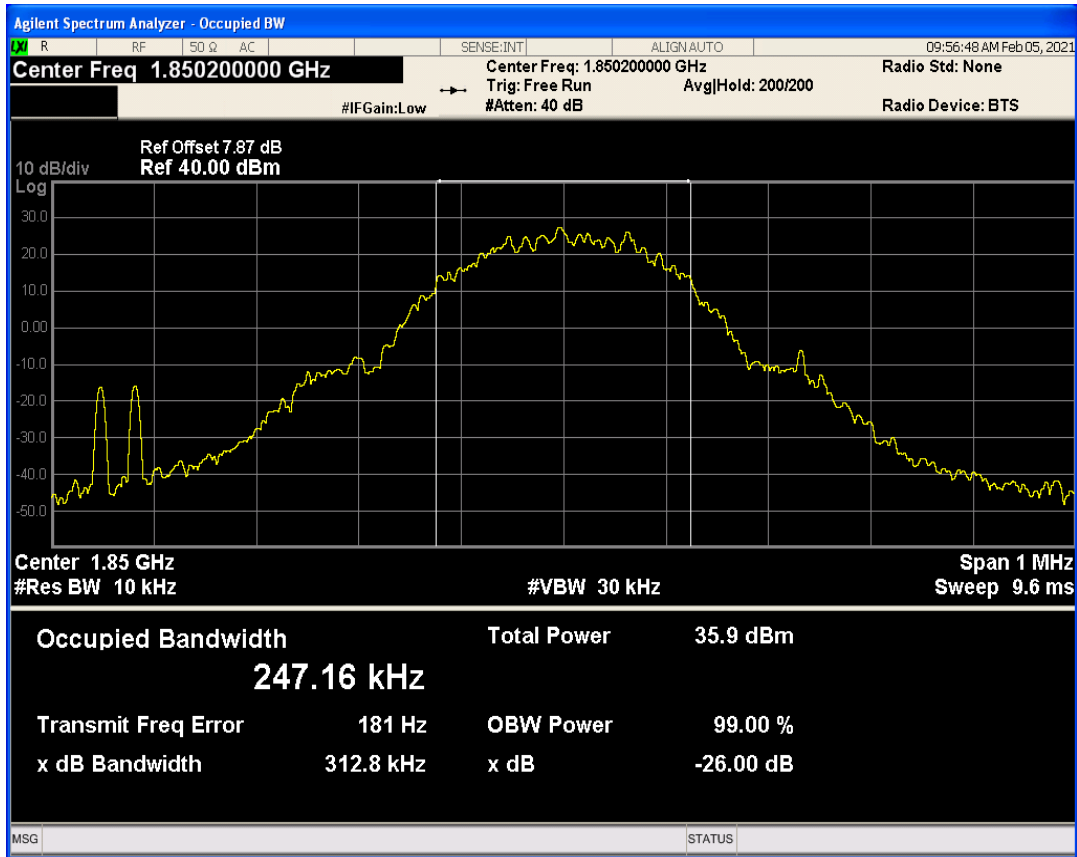

EGPRS1900 Channel=810

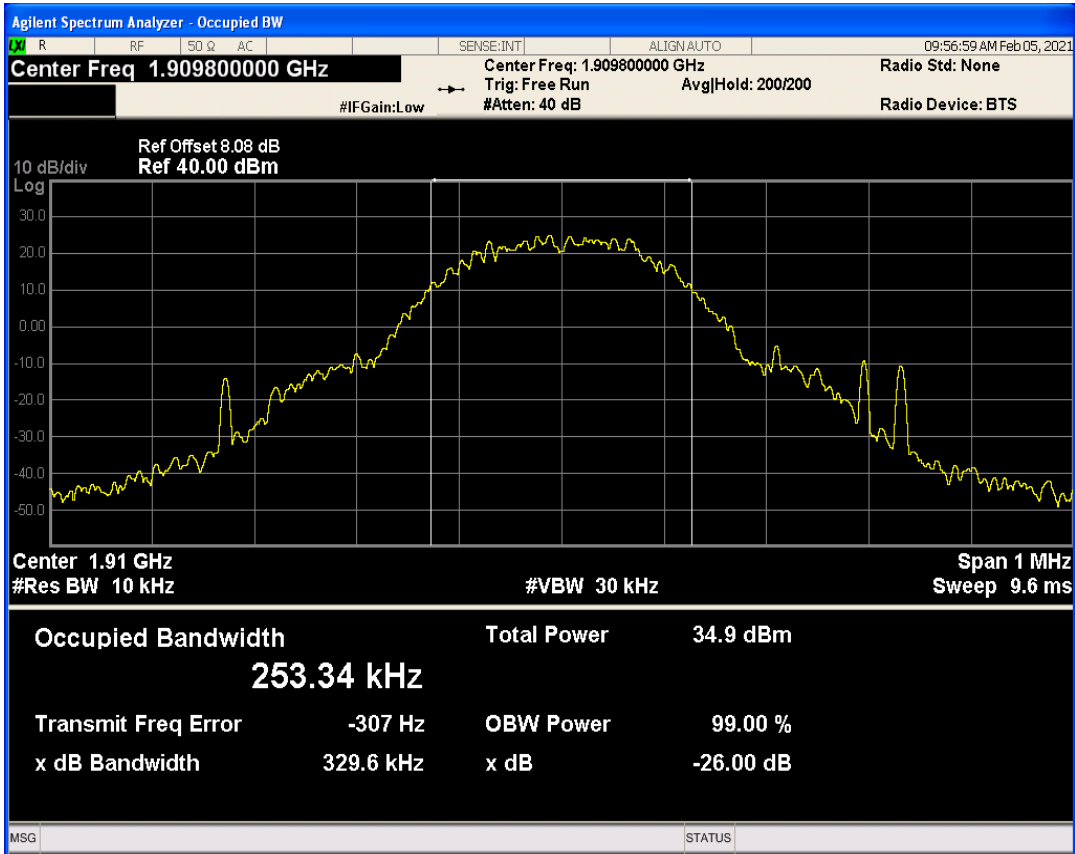

EGPRS1900 Channel=661

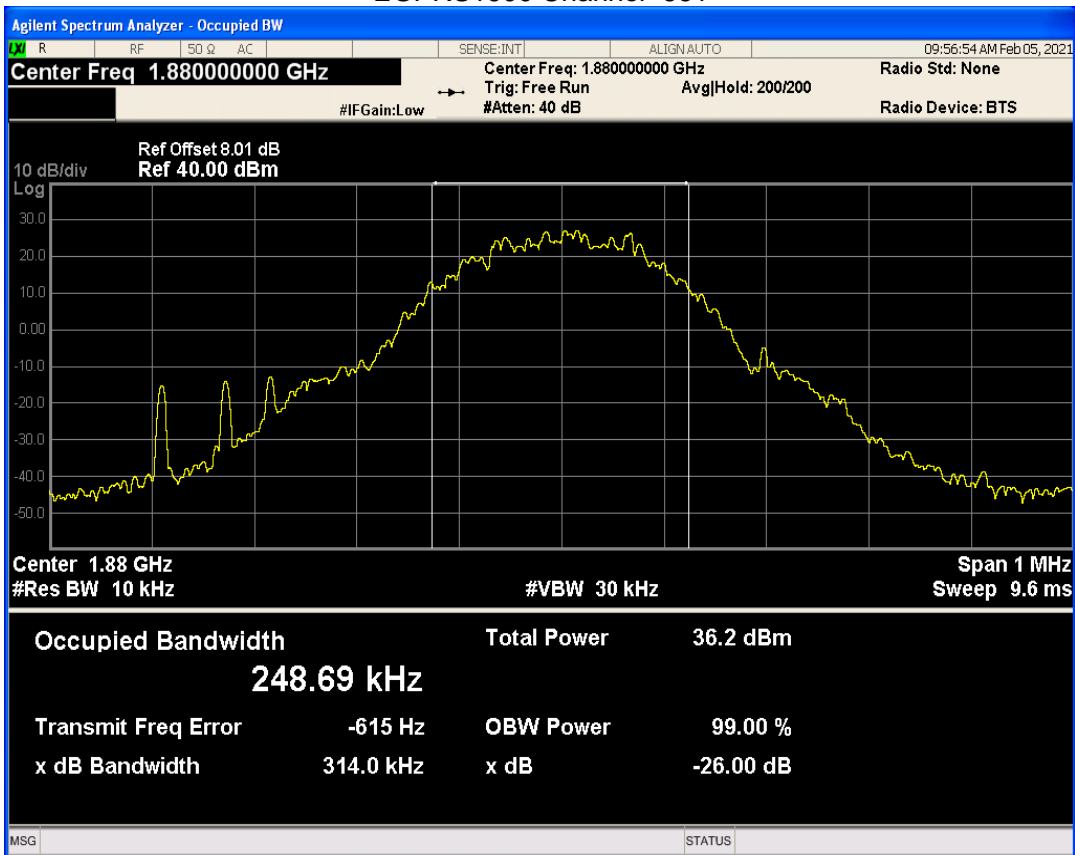

EGPRS850 Channel=128

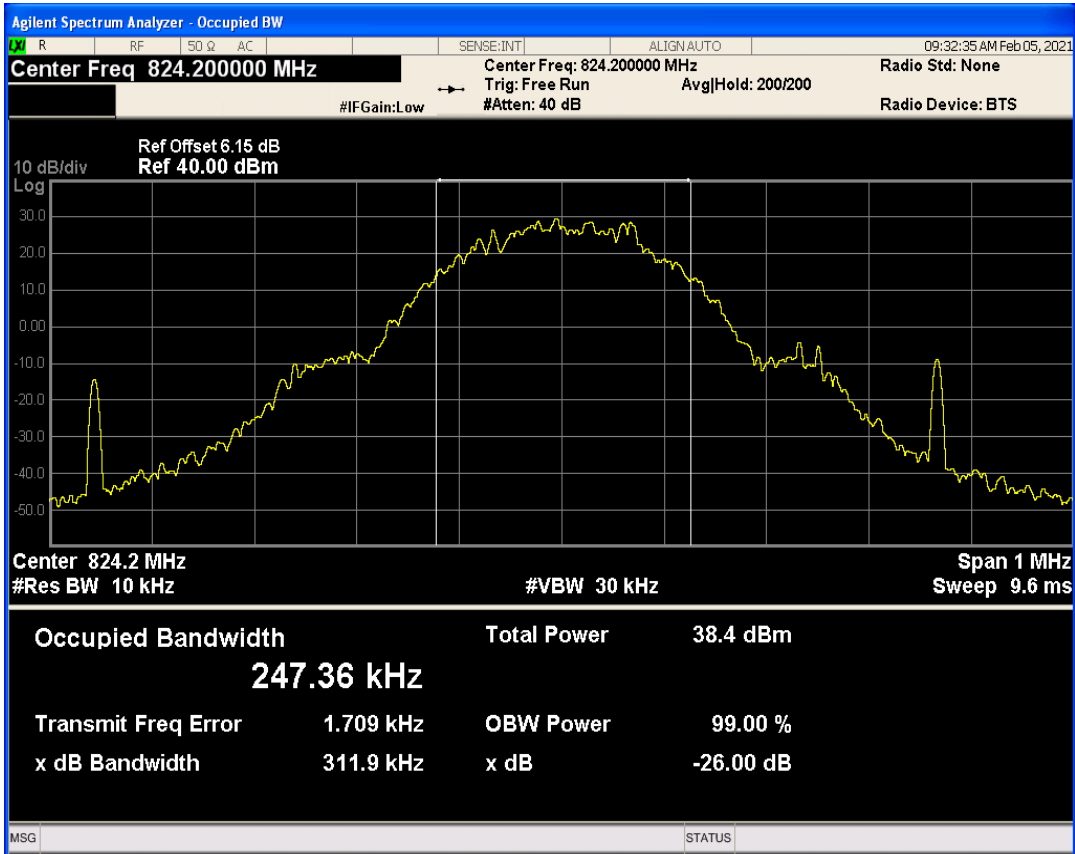

EGPRS850 Channel=251

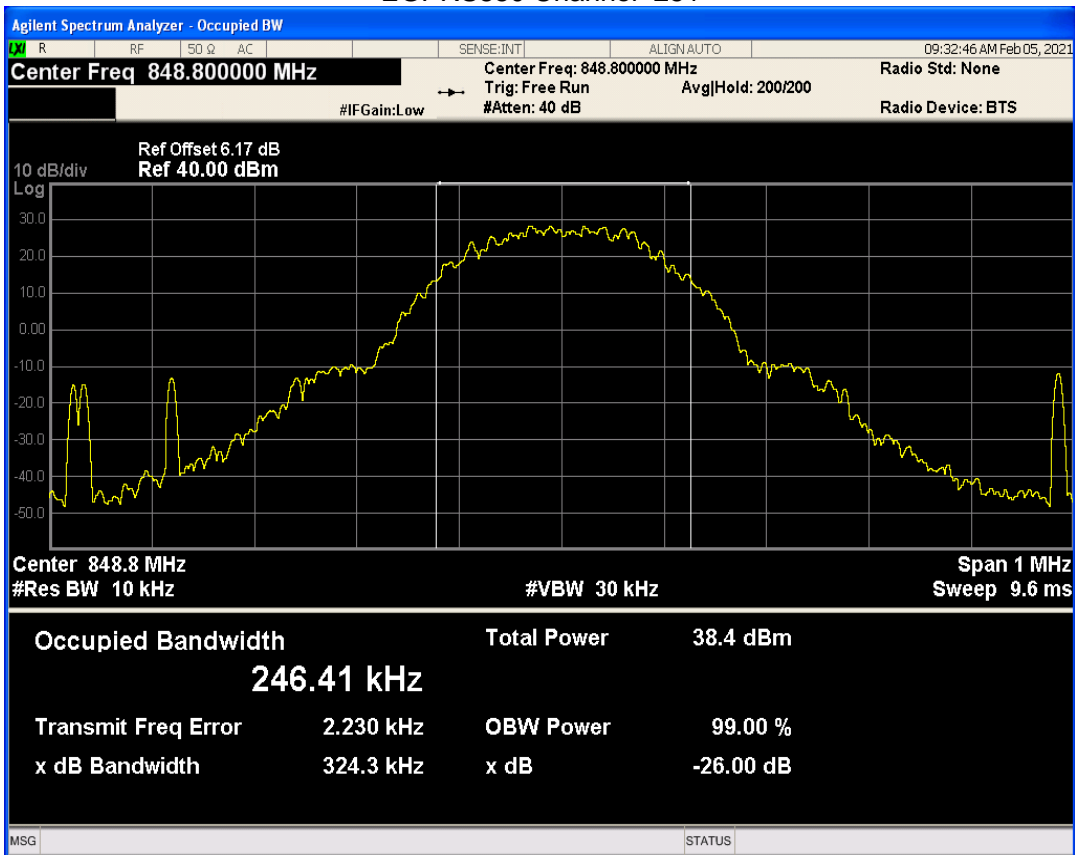

EGPRS850 Channel=189

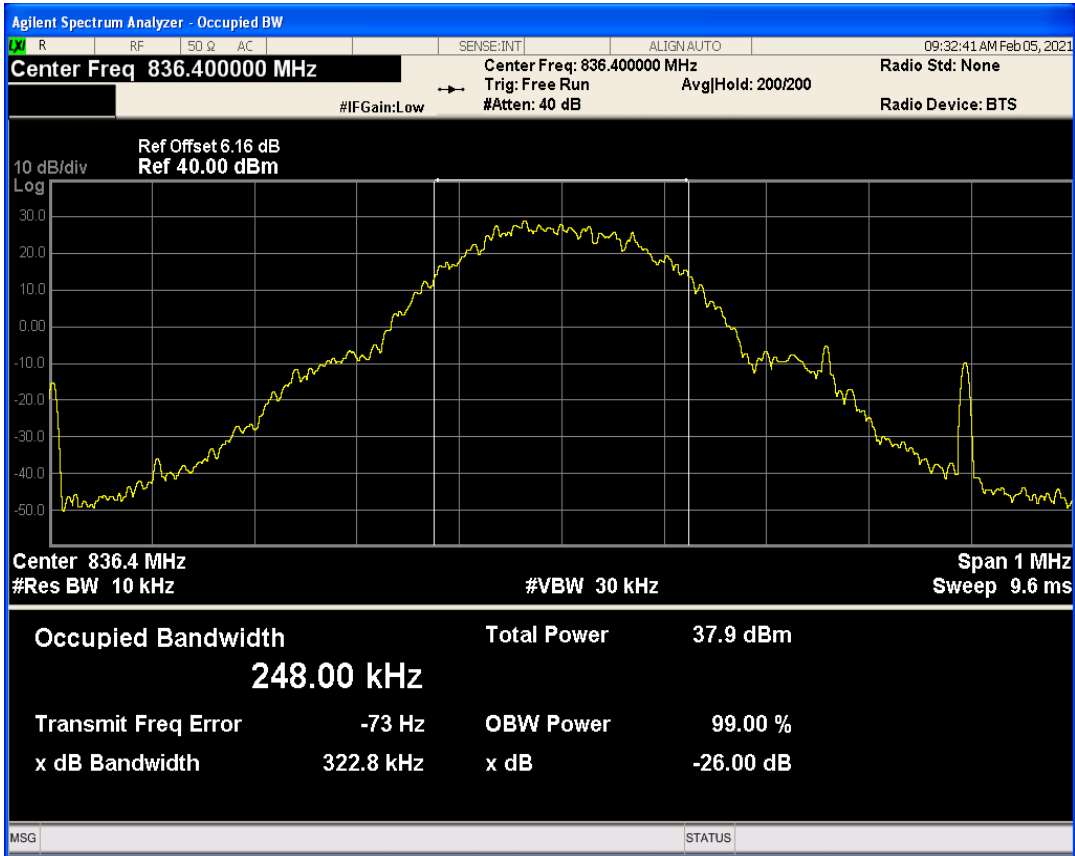

8.10 BAND EDGE

Band	Channel	Frequency (MHz)	Spur Freq (MHz)	Spur Level (dBm)	Limit (dBm)	Verdict
EGPRS1900	512	1850.2	1849.98	-29.77	-13	PASS
EGPRS1900	810	1909.8	1910.02	-27.83	-13	PASS
EGPRS850	128	824.2	823.98	-27.00	-13	PASS
EGPRS850	251	848.8	849.02	-27.40	-13	PASS

EGPRS1900 Channel=810

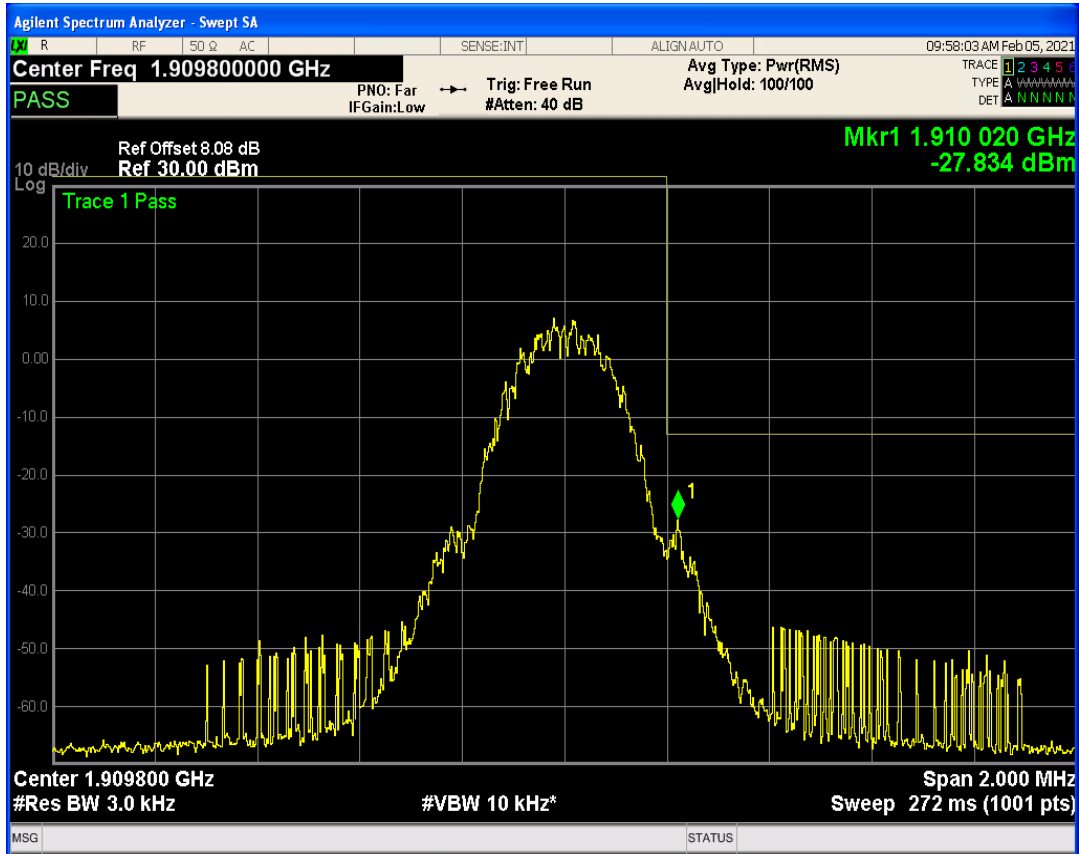

EGPRS1900 Channel=512

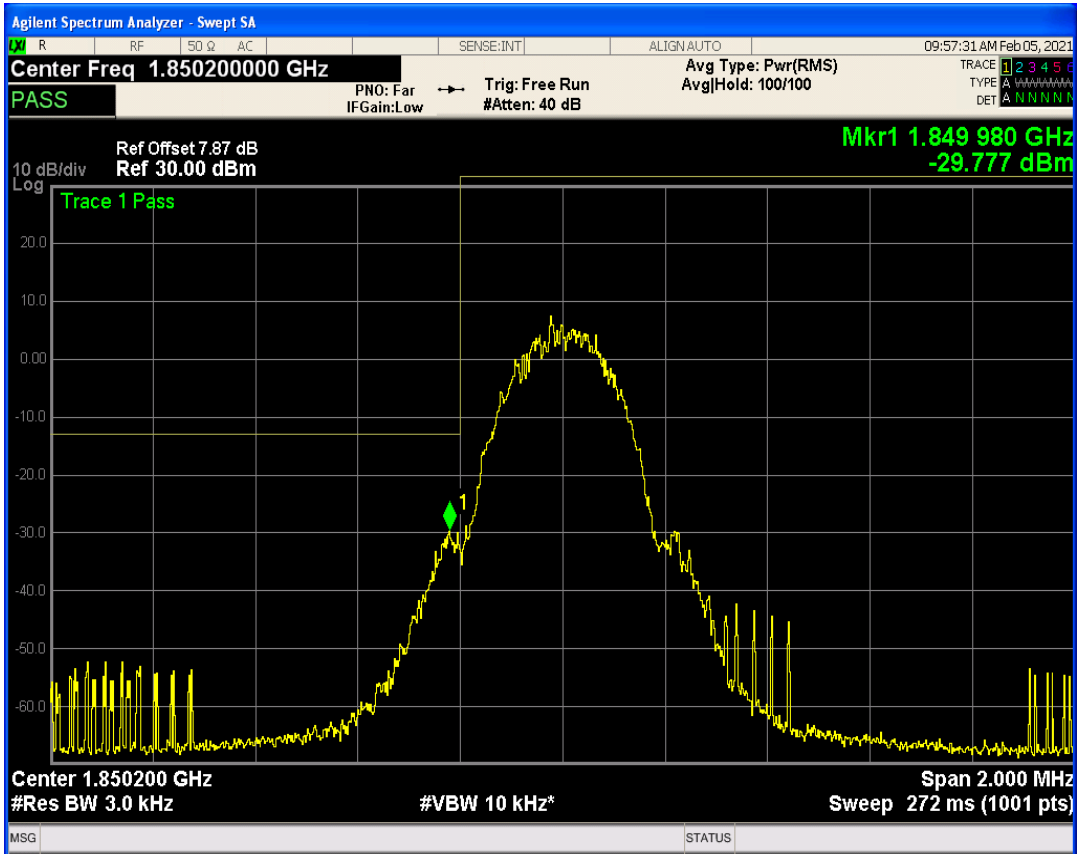

EGPRS850 Channel=128

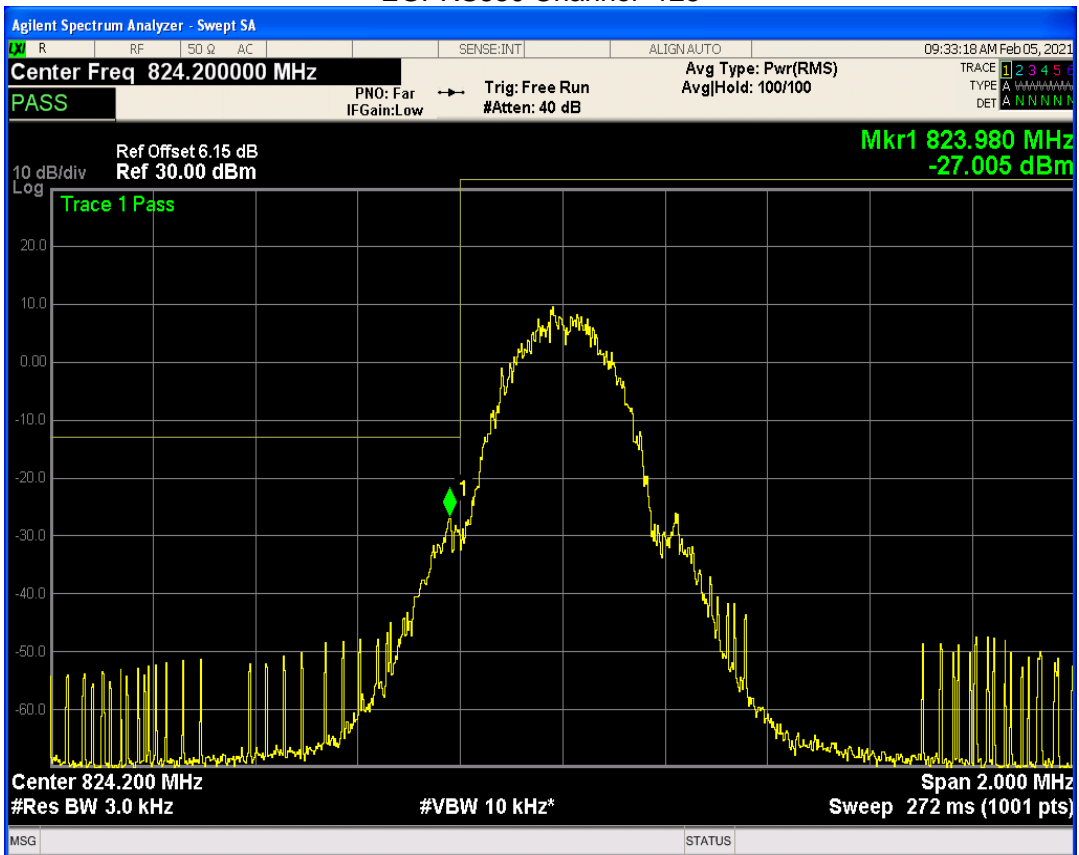

EGPRS850 Channel=251

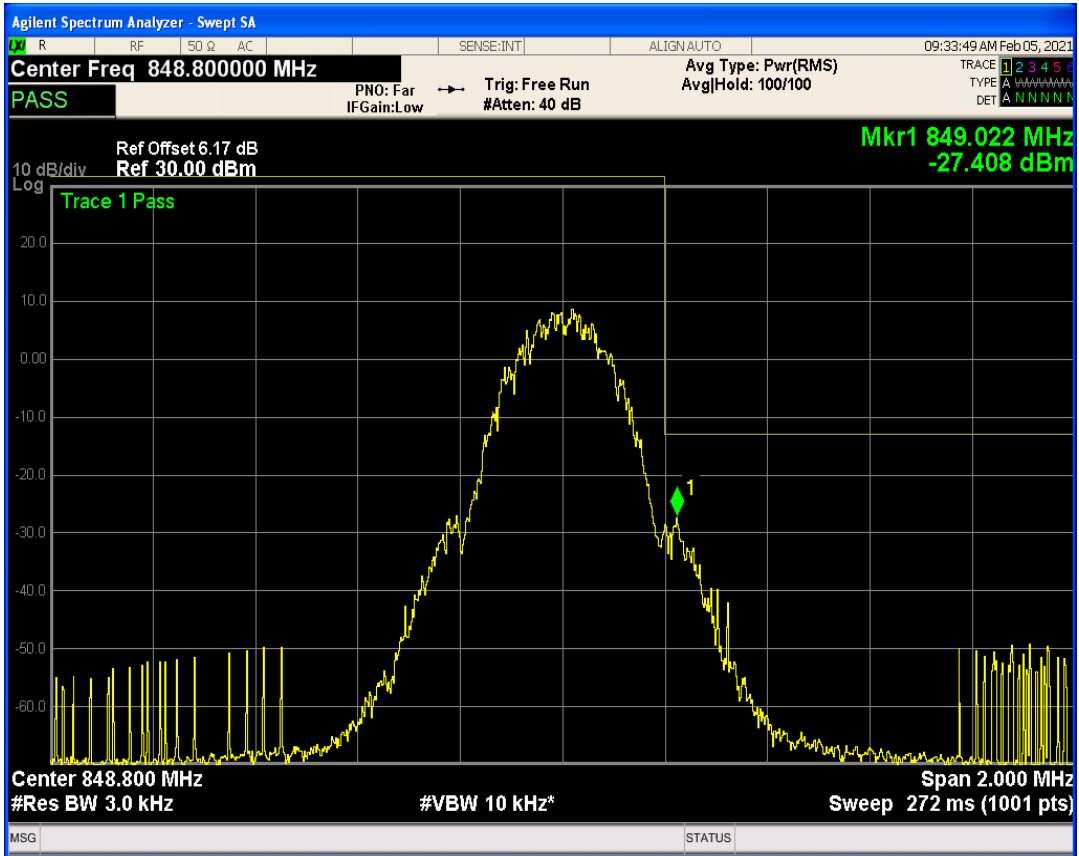

8.11 OUT-OF-BAND EMISSIONS

Band	Channel	Frequency (MHz)	Spur Freq (MHz)	Spur Level (dBm)	Limit (dBm)	Verdict
EGPRS1900	512	1850.2	19915.13	-23.55	-13	PASS
EGPRS1900	661	1880	19861.21	-23.49	-13	PASS
EGPRS1900	810	1909.8	19995.51	-23.32	-13	PASS
EGPRS850	128	824.2	1648.38	-30.14	-13	PASS
EGPRS850	189	836.4	3261.03	-29.23	-13	PASS
EGPRS850	251	848.8	3039.44	-30.09	-13	PASS

EGPRS1900 Channel=512

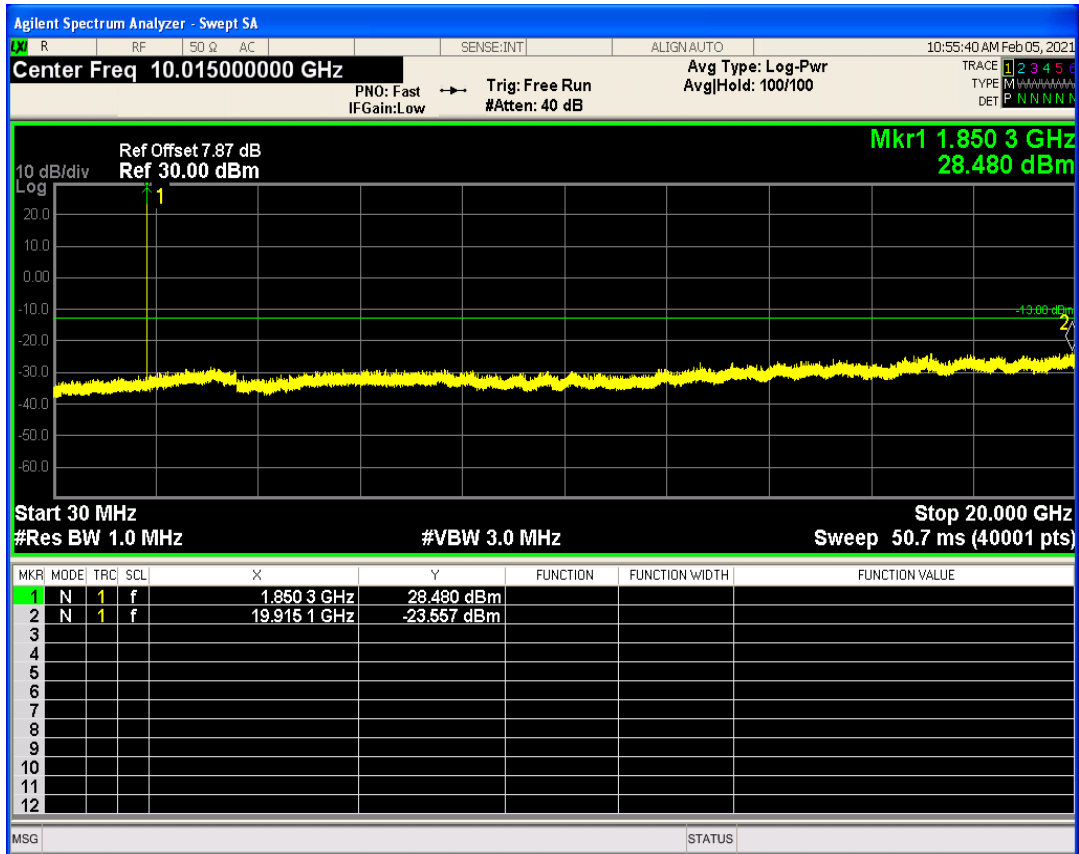

EGPRS1900 Channel=661

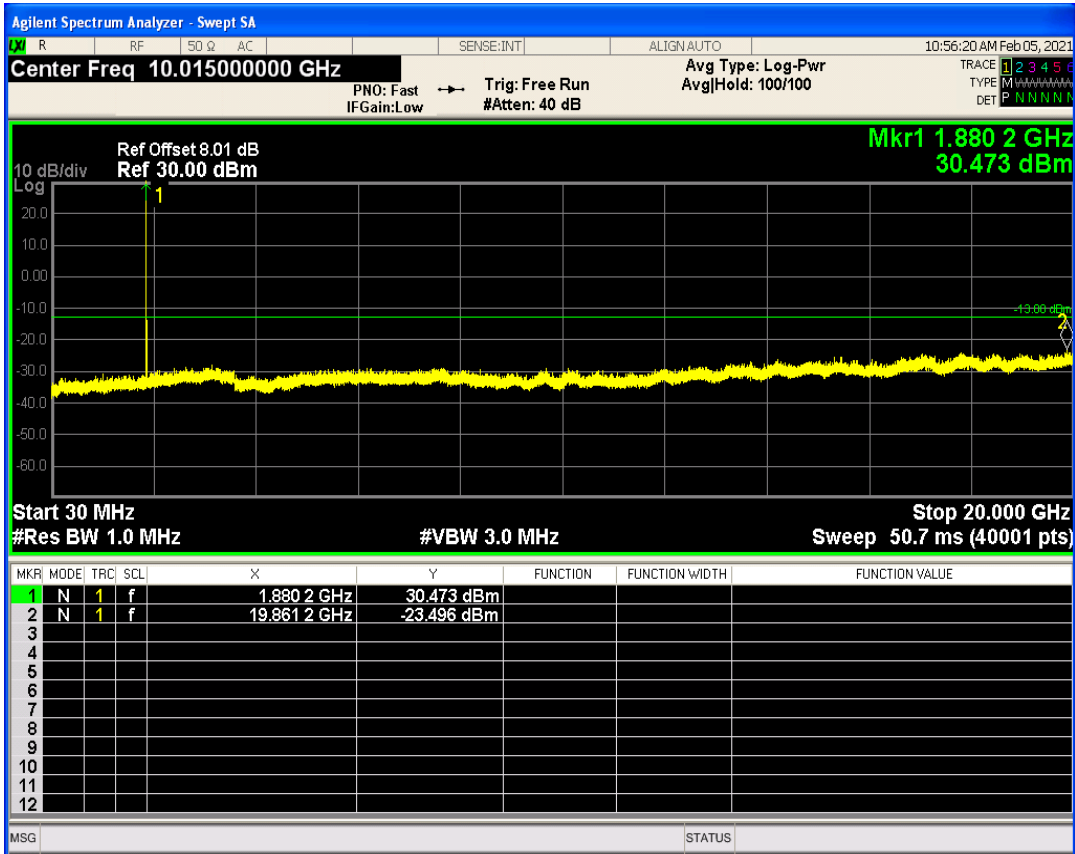

EGPRS1900 Channel=810

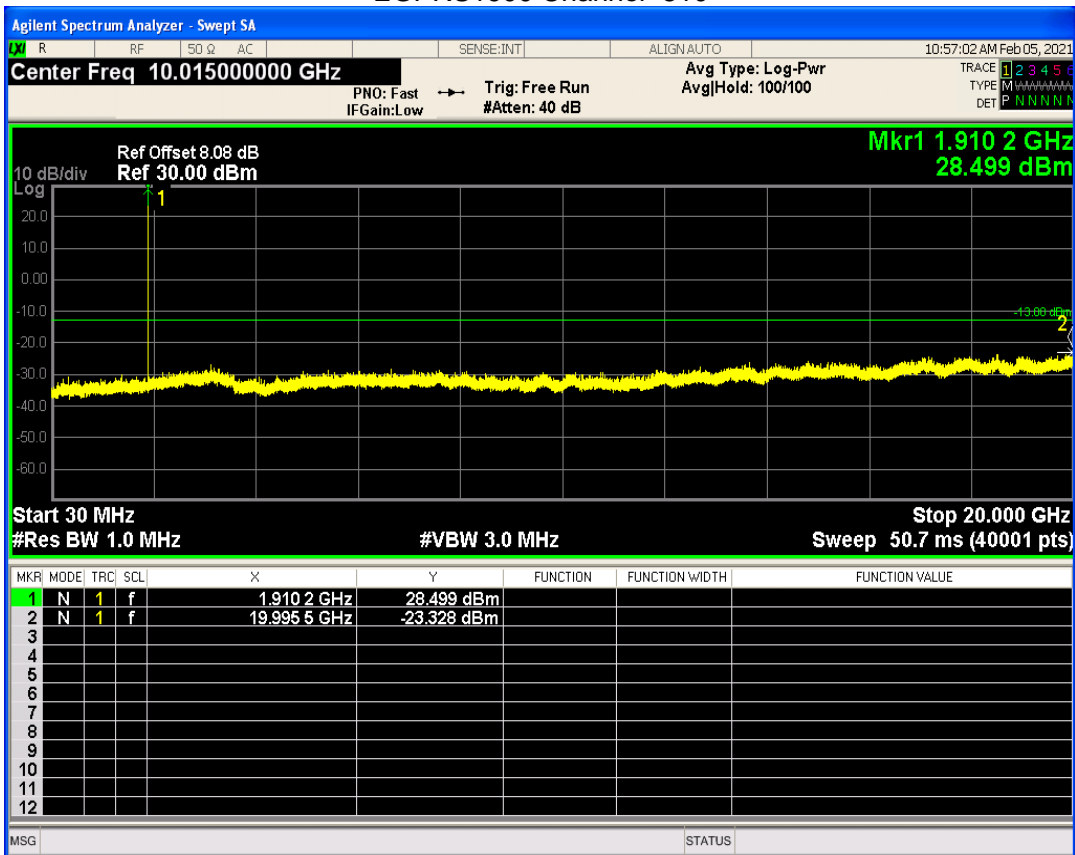

EGPRS850 Channel=189

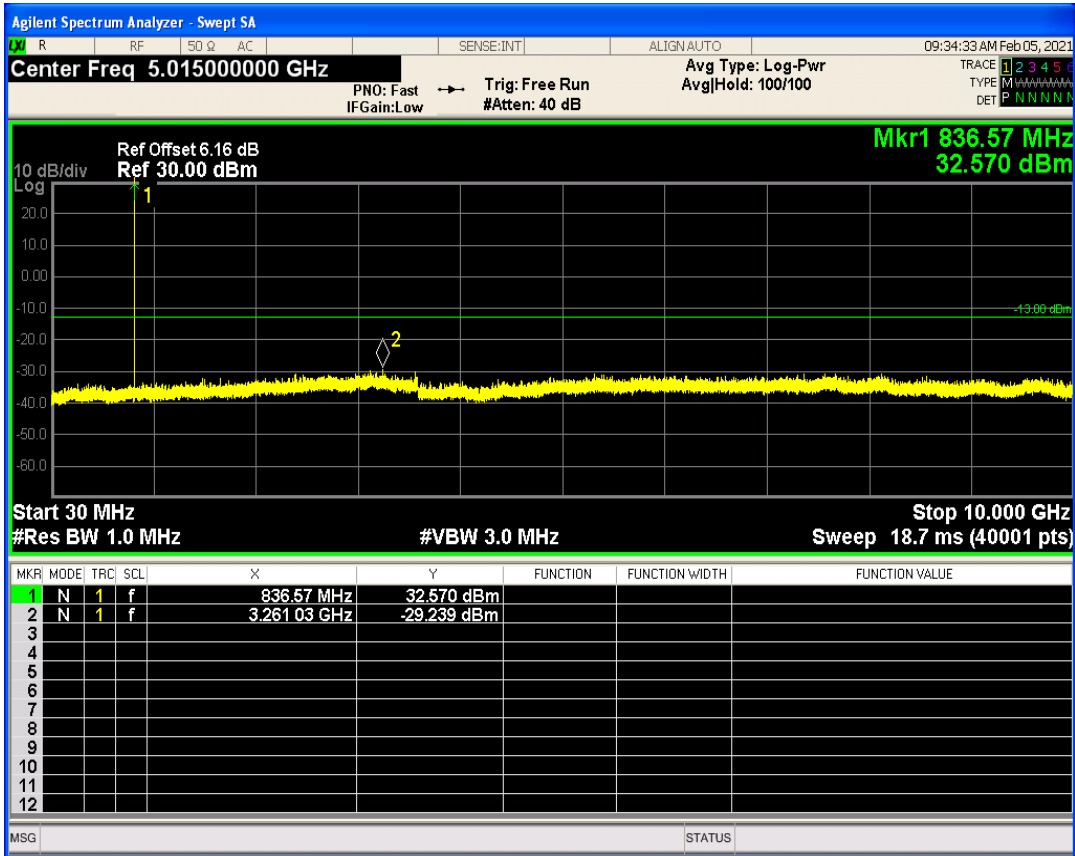

EGPRS850 Channel=128

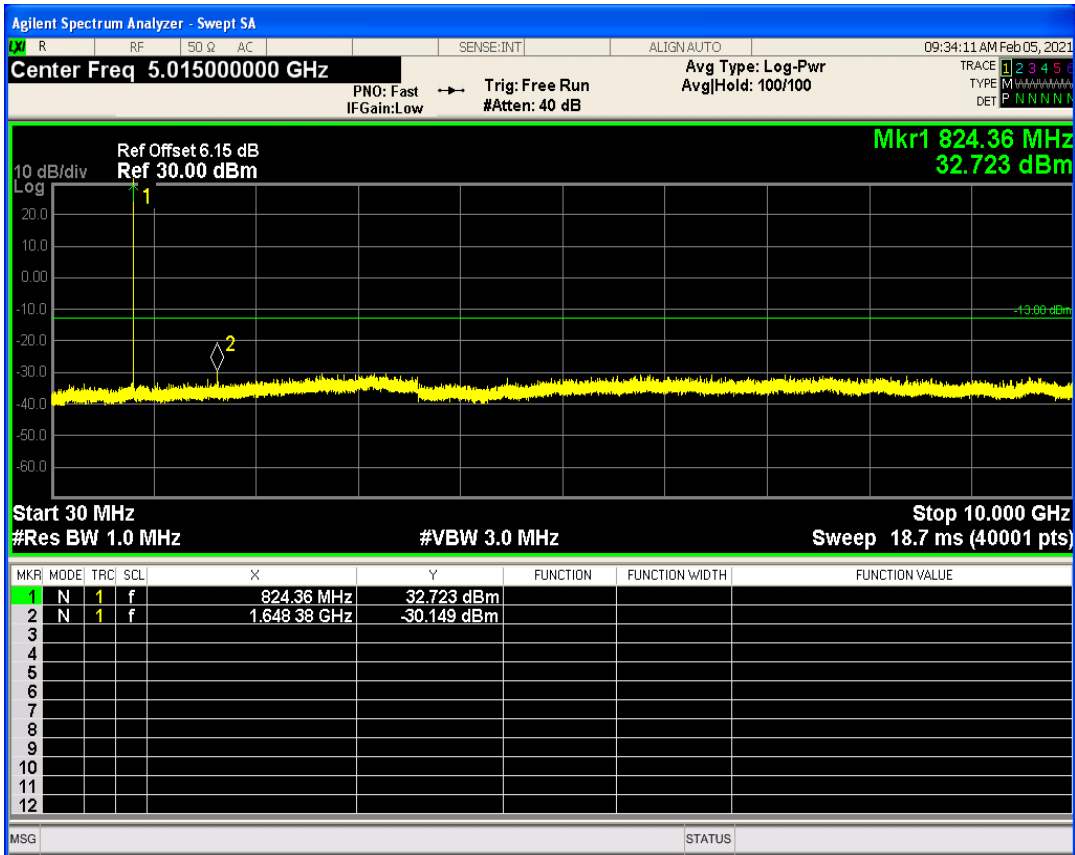

EGPRS850 Channel=251

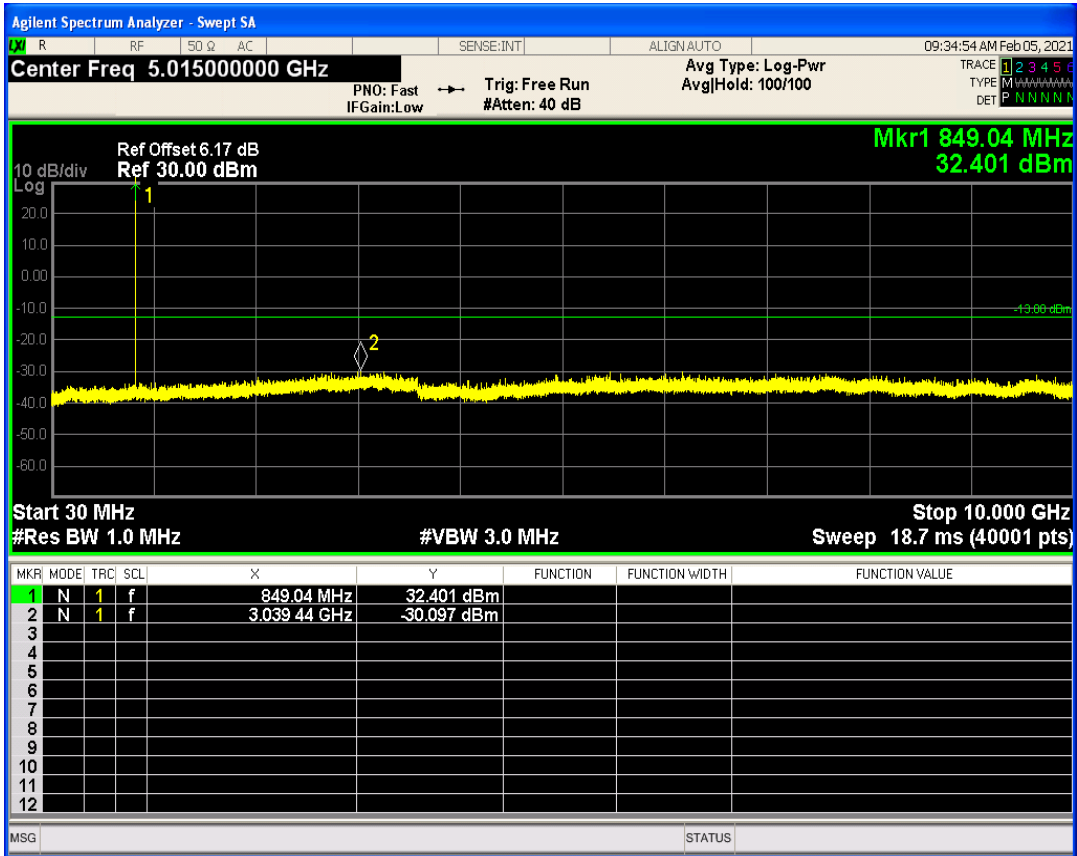

8.12 PEAK-TO-AVERAGE RATIO

Band	Channel	Frequency (MHz)	Result (dB)	high Limit (dB)	Verdict
GPRS1900	512	1850.2	2.678	13.00	PASS
GPRS1900	661	1880	2.66	13.00	PASS
GPRS1900	810	1909.8	2.678	13.00	PASS
GPRS850	128	824.2	2.67	13.00	PASS
GPRS850	189	836.4	2.65	13.00	PASS
GPRS850	251	848.8	2.65	13.00	PASS

GPRS1900 Channel=512

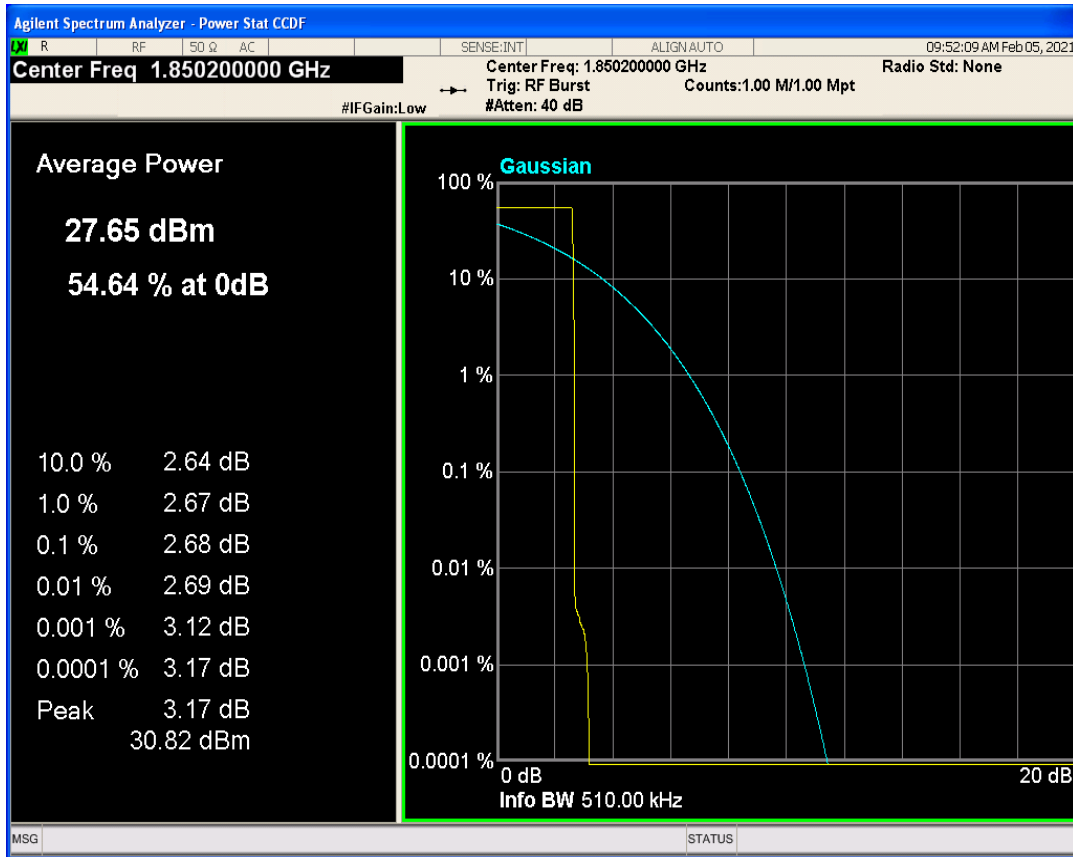

GPRS1900 Channel=810

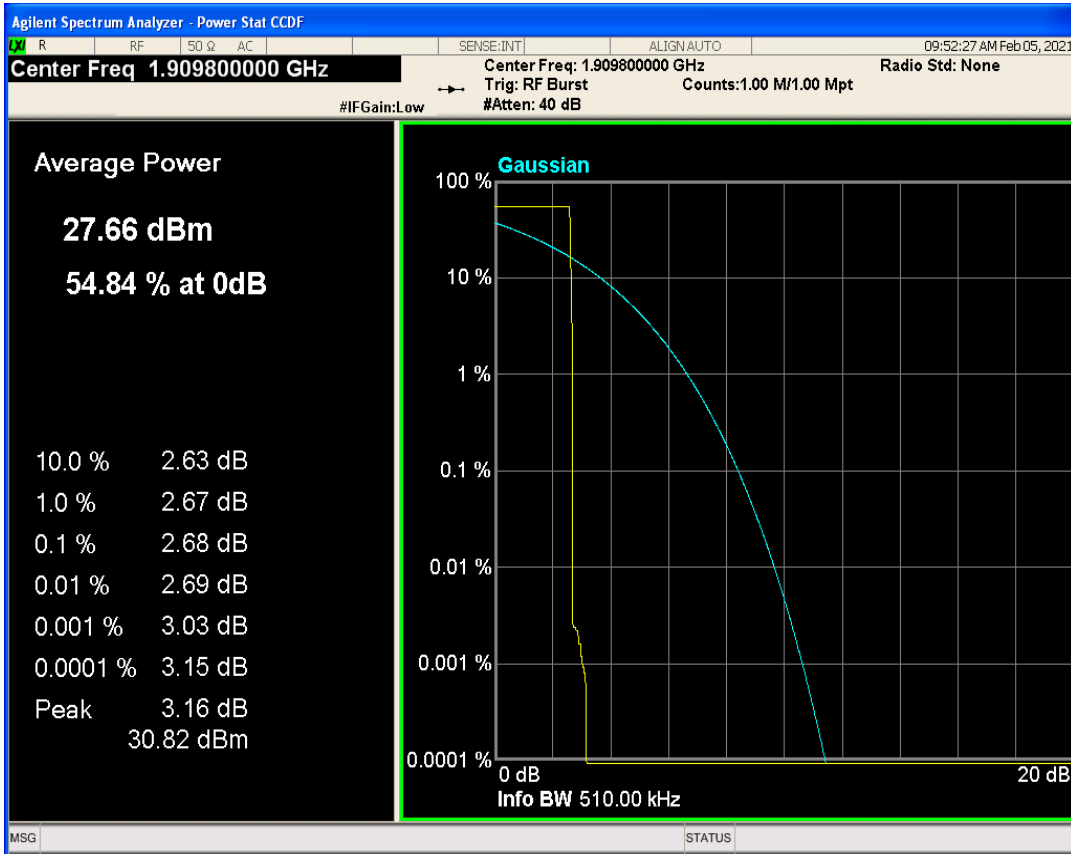

GPRS1900 Channel=661

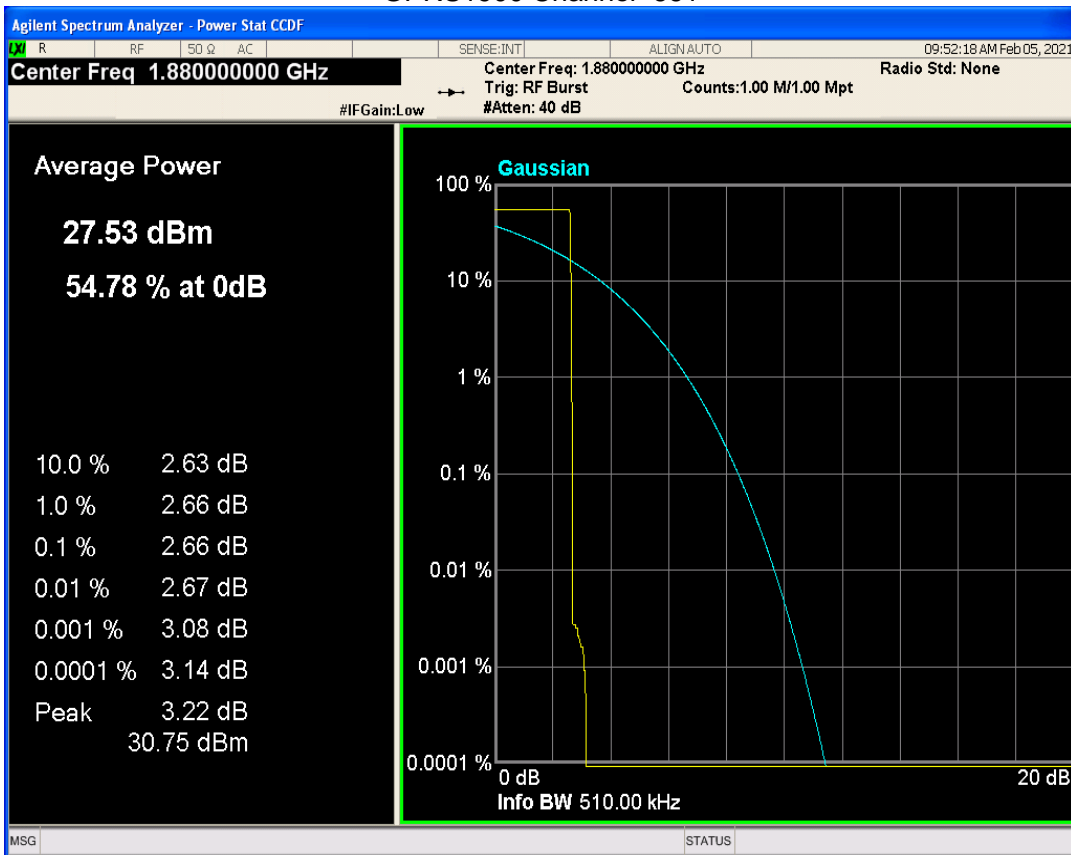

GPRS850 Channel=128

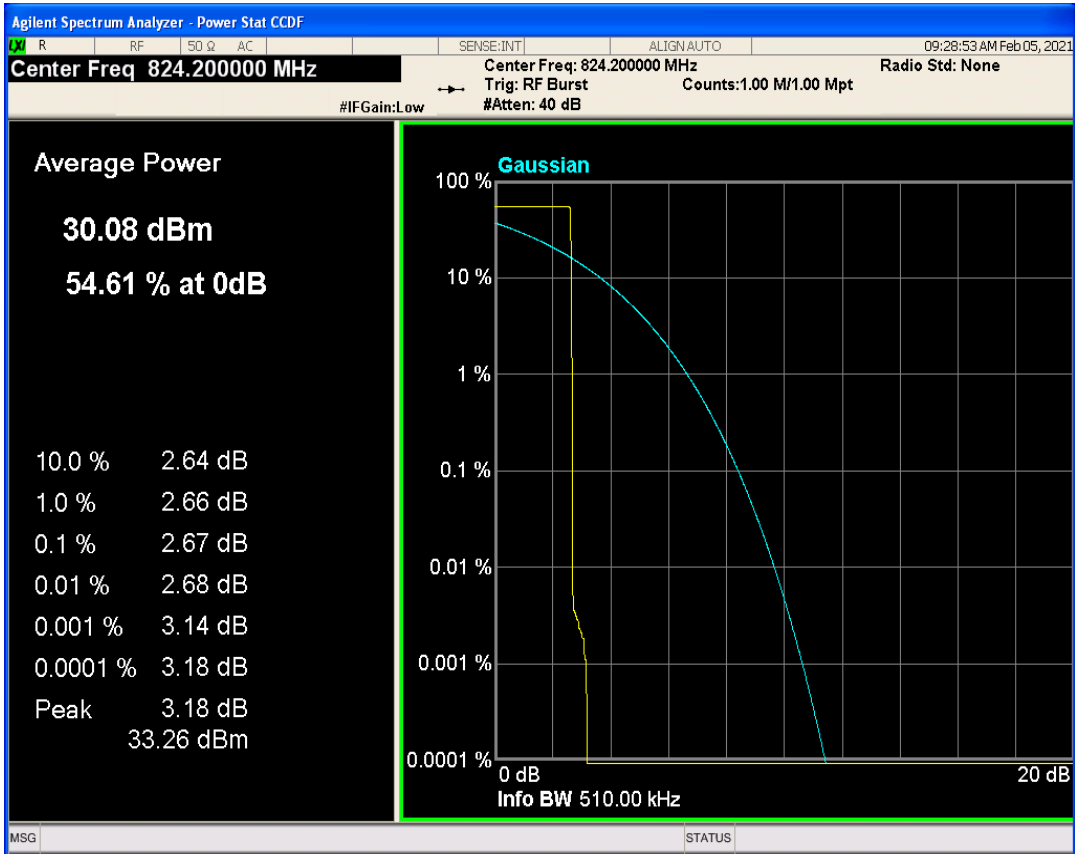

GPRS850 Channel=251

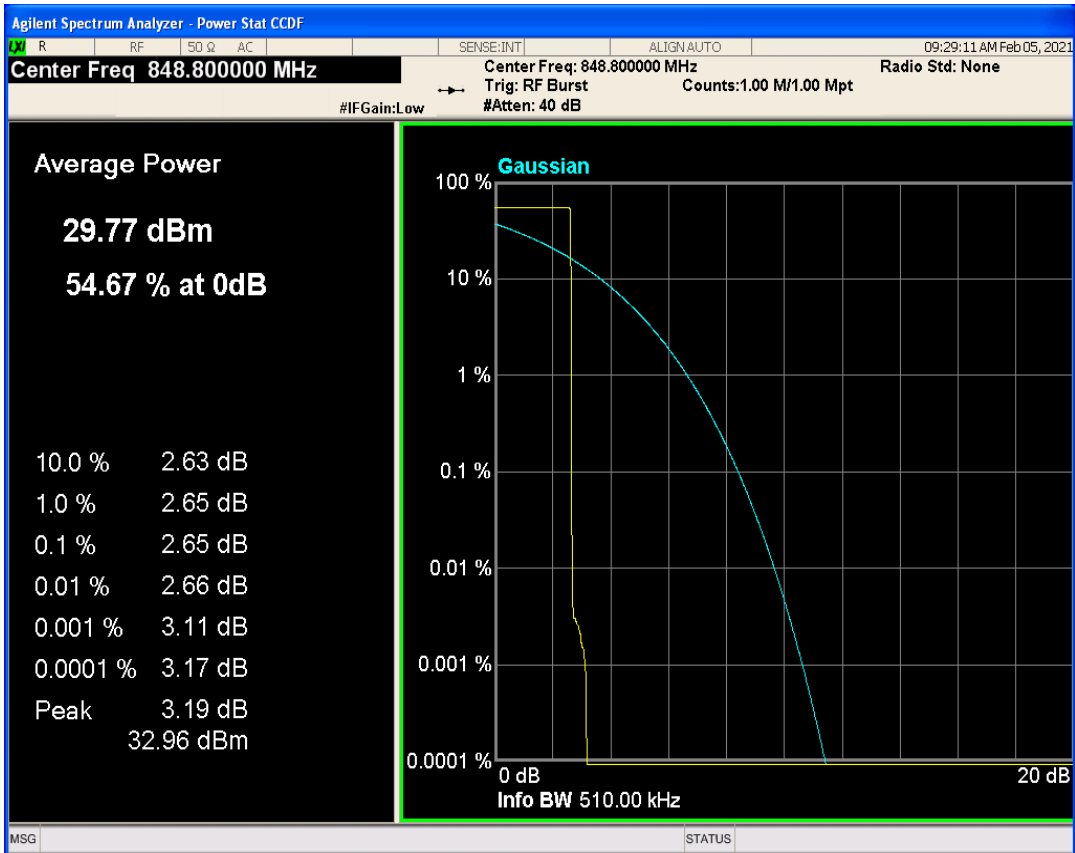

GPRS850 Channel=189

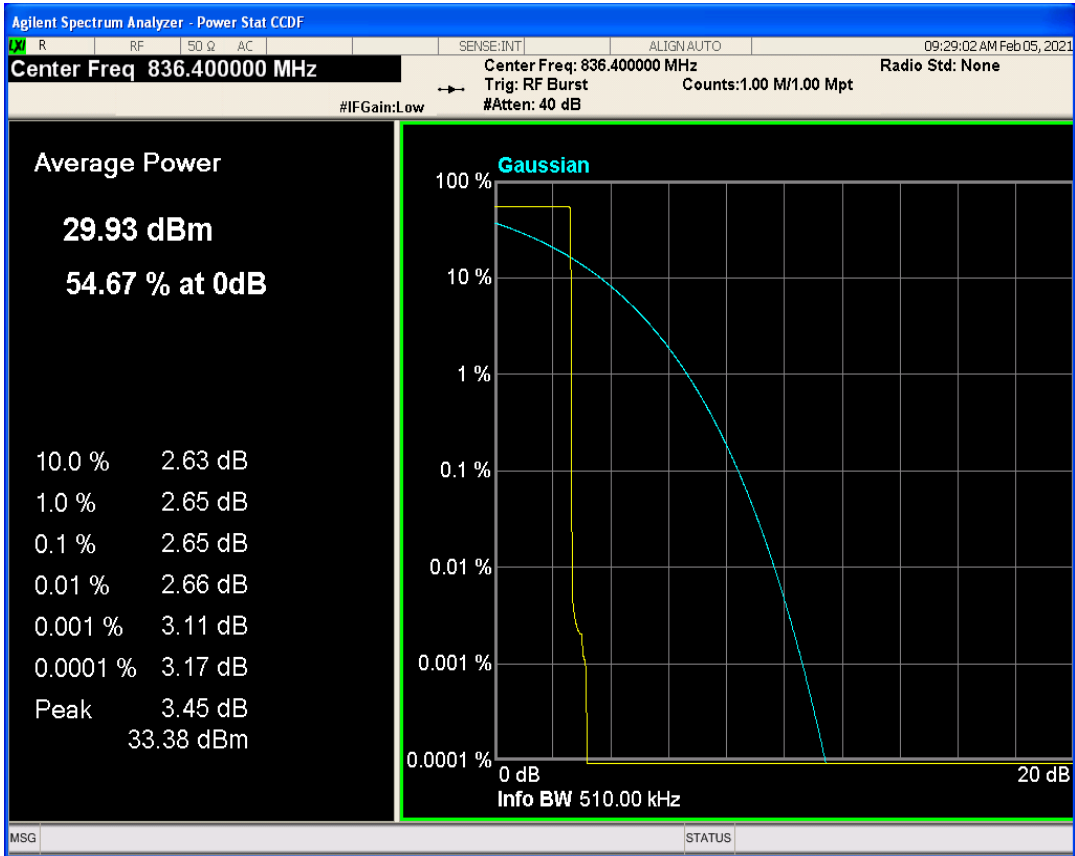

8.13 OCCUPIED BANDWIDTH

Band	Channel	Frequency (MHz)	99% OBW (kHz)	-26dB EBW (kHz)	Verdict
GPRS1900	512	1850.2	244.750	314.056	PASS
GPRS1900	661	1880	249.254	312.845	PASS
GPRS1900	810	1909.8	255.166	323.303	PASS
GPRS850	128	824.2	247.693	320.312	PASS
GPRS850	189	836.4	244.099	316.962	PASS
GPRS850	251	848.8	247.198	319.711	PASS

GPRS1900 Channel=661

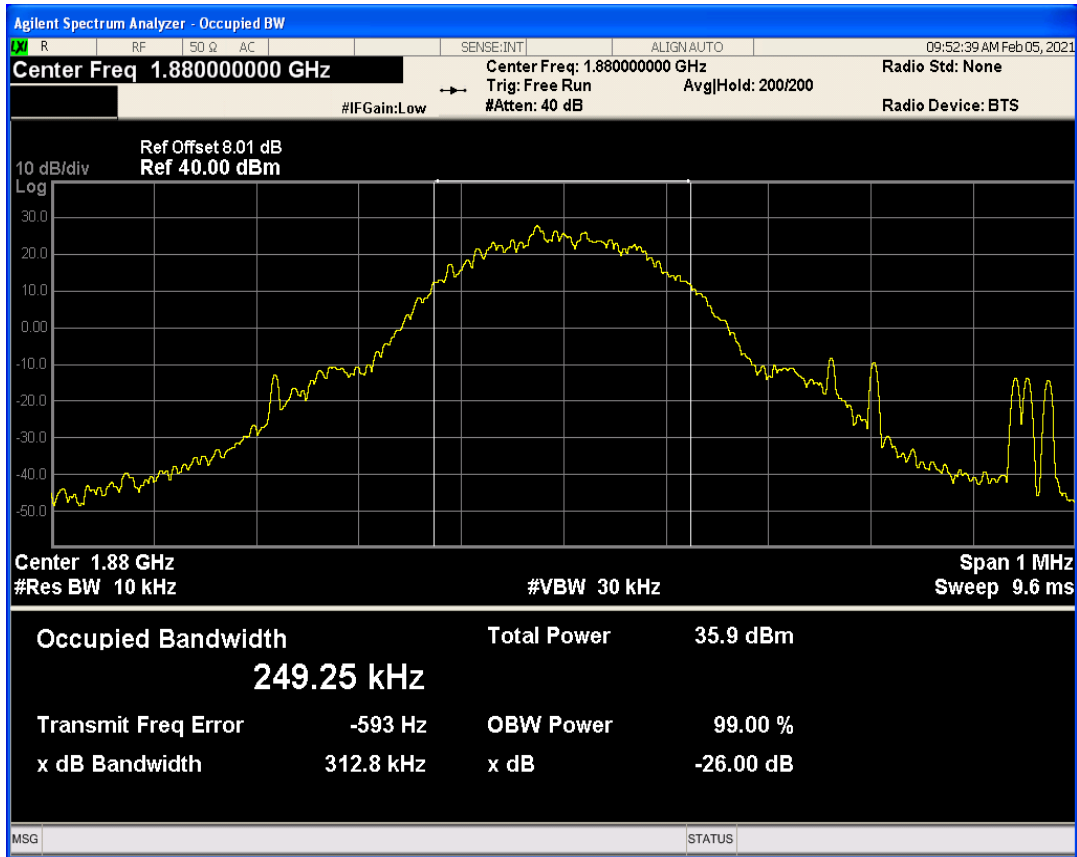

GPRS1900 Channel=512

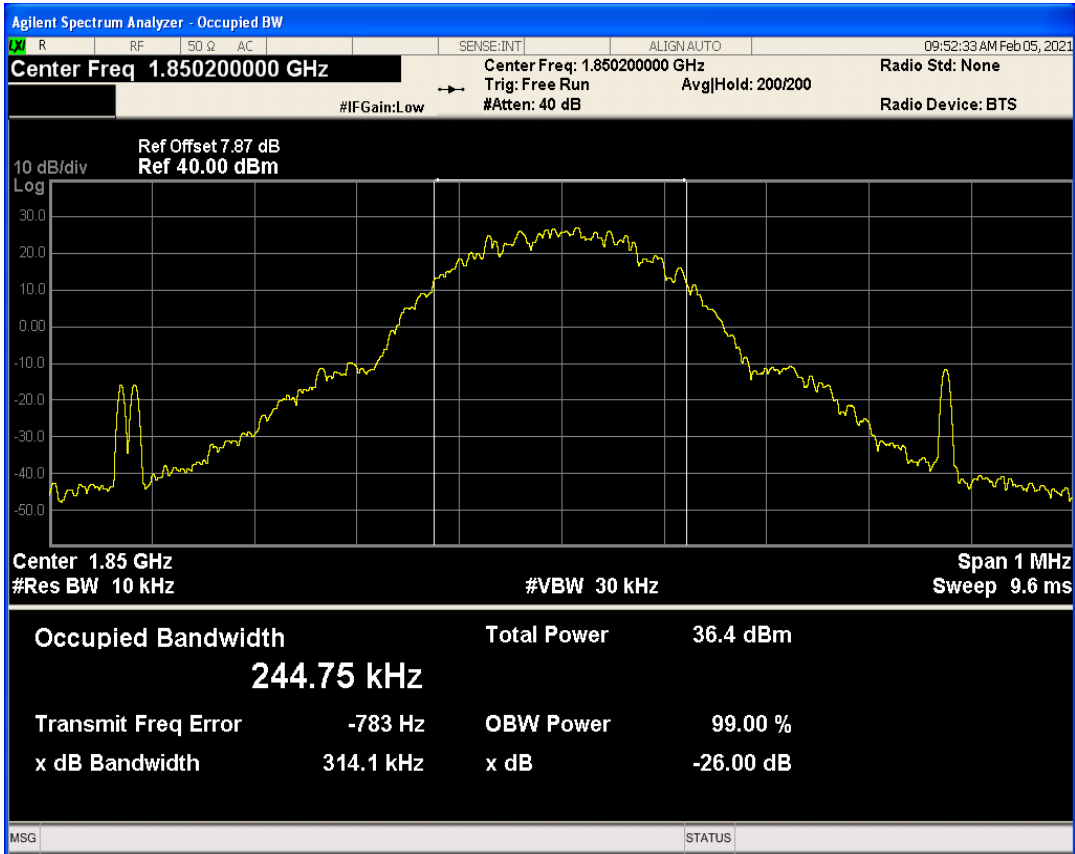

GPRS1900 Channel=810

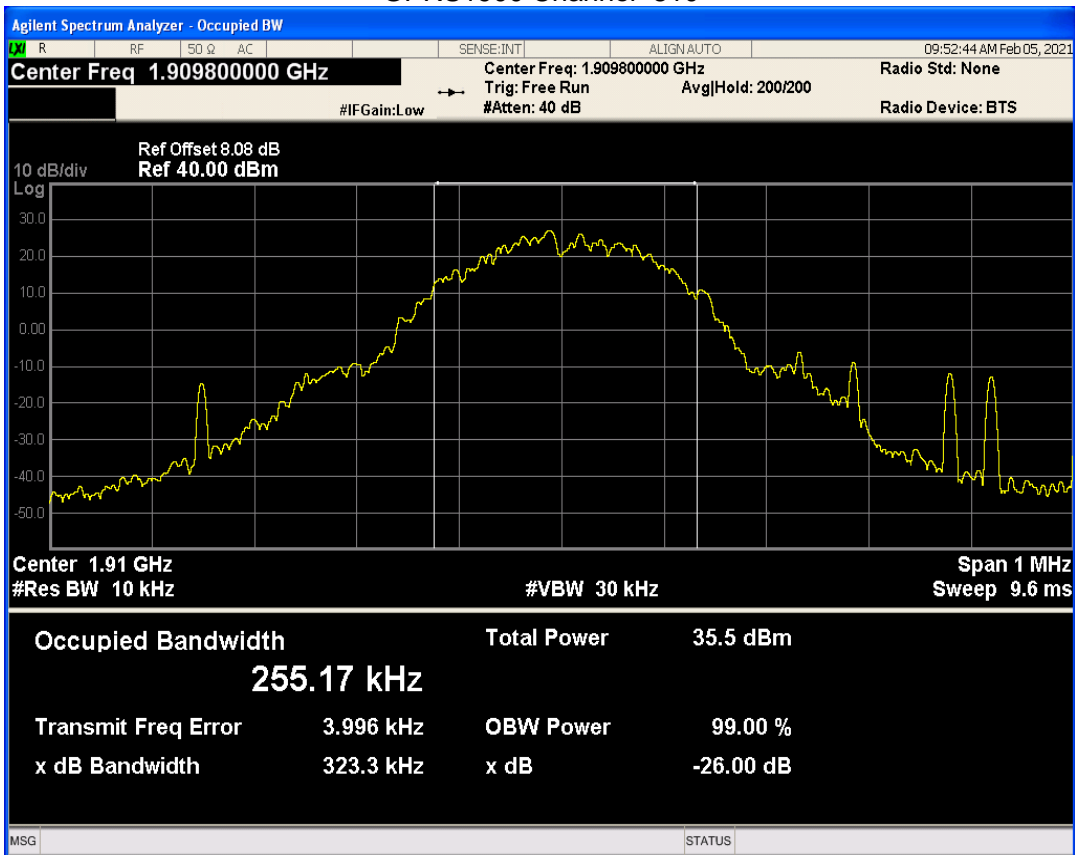

GPRS850 Channel=128

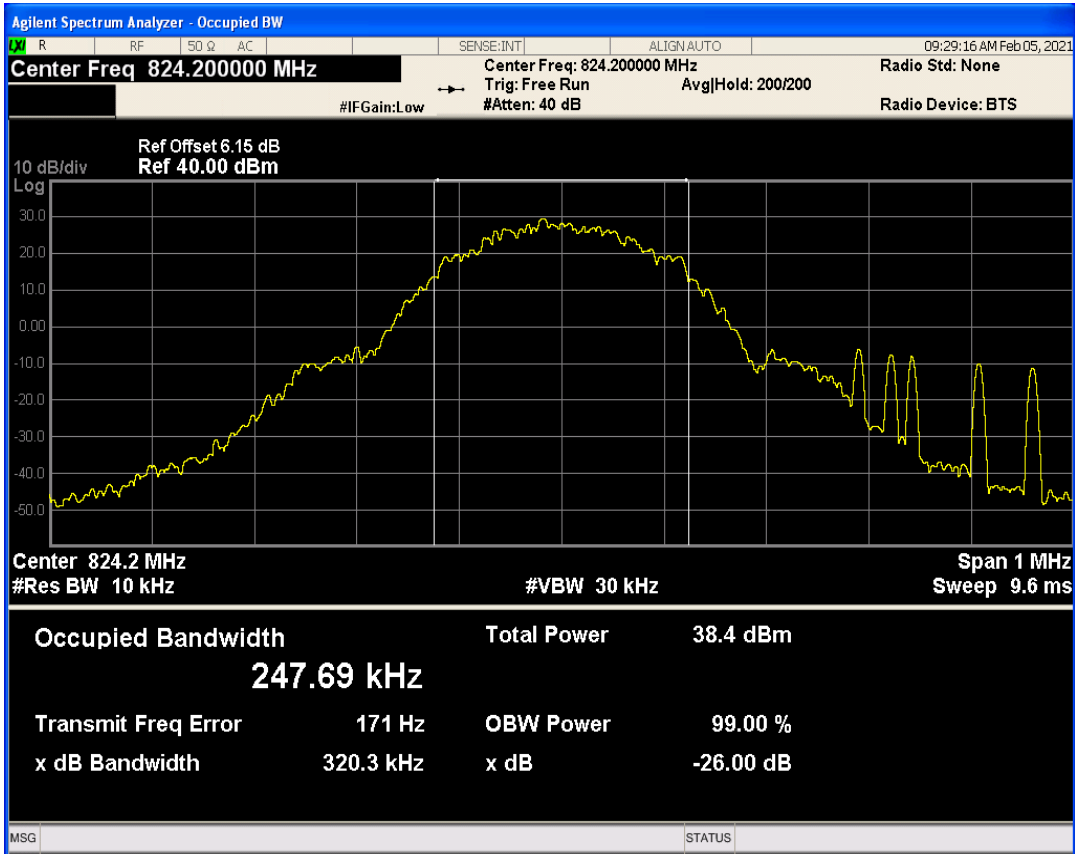

GPRS850 Channel=189

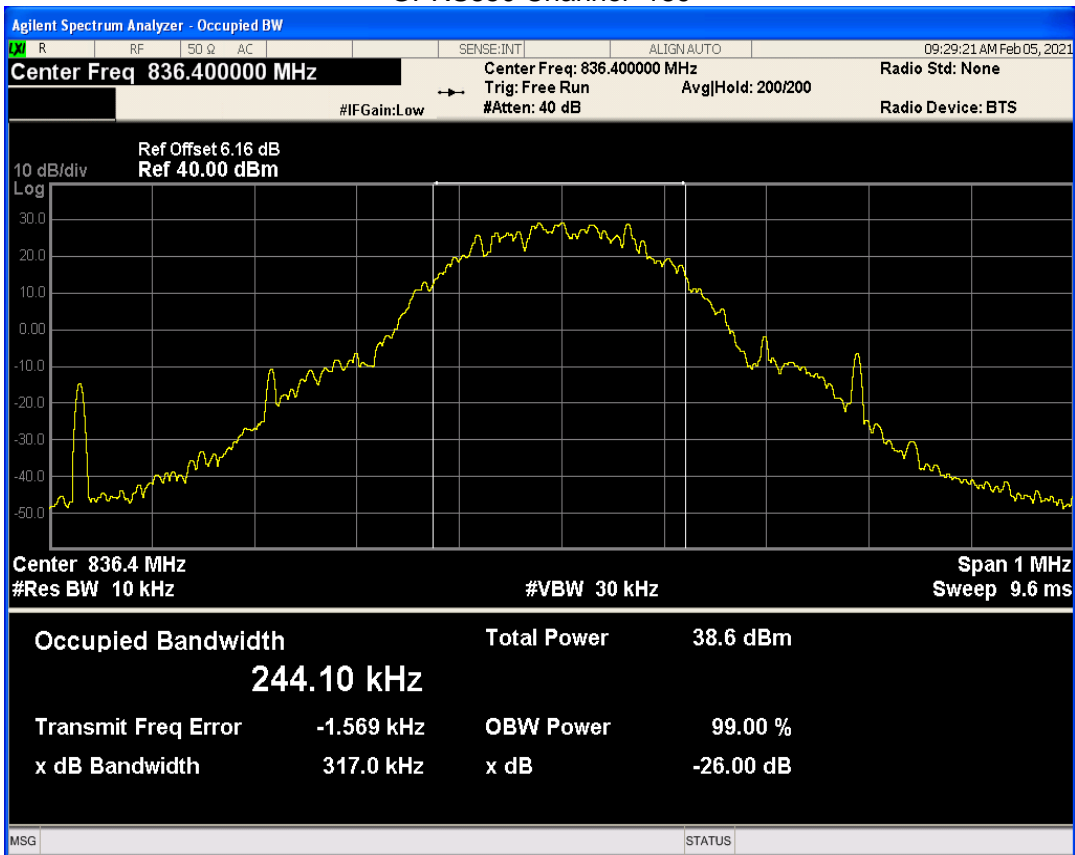

GPRS850 Channel=251

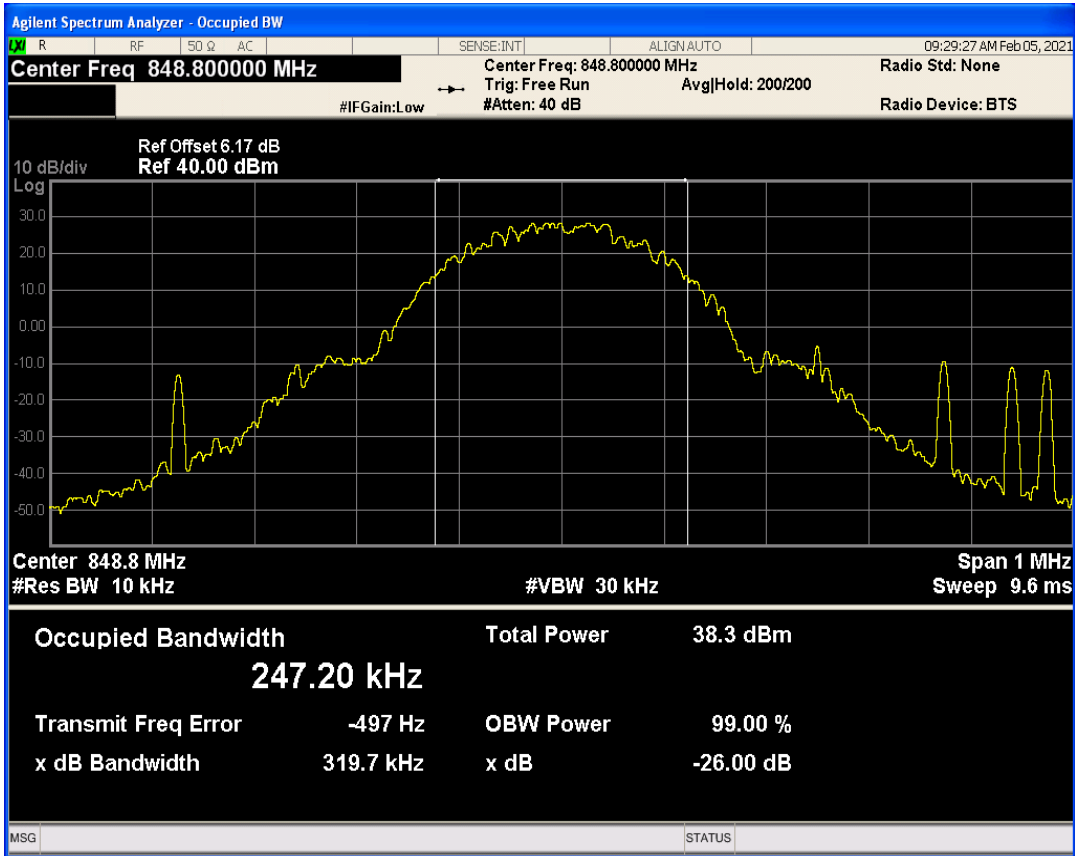

8.14 BAND EDGE

Band	Channel	Frequency (MHz)	Spur Freq (MHz)	Spur Level (dBm)	Limit (dBm)	Verdict
GPRS1900	512	1850.2	1850.00	-26.97	-13	PASS
GPRS1900	810	1909.8	1910.02	-28.37	-13	PASS
GPRS850	128	824.2	824.00	-24.97	-13	PASS
GPRS850	251	848.8	849.02	-26.46	-13	PASS

GPRS1900 Channel=512

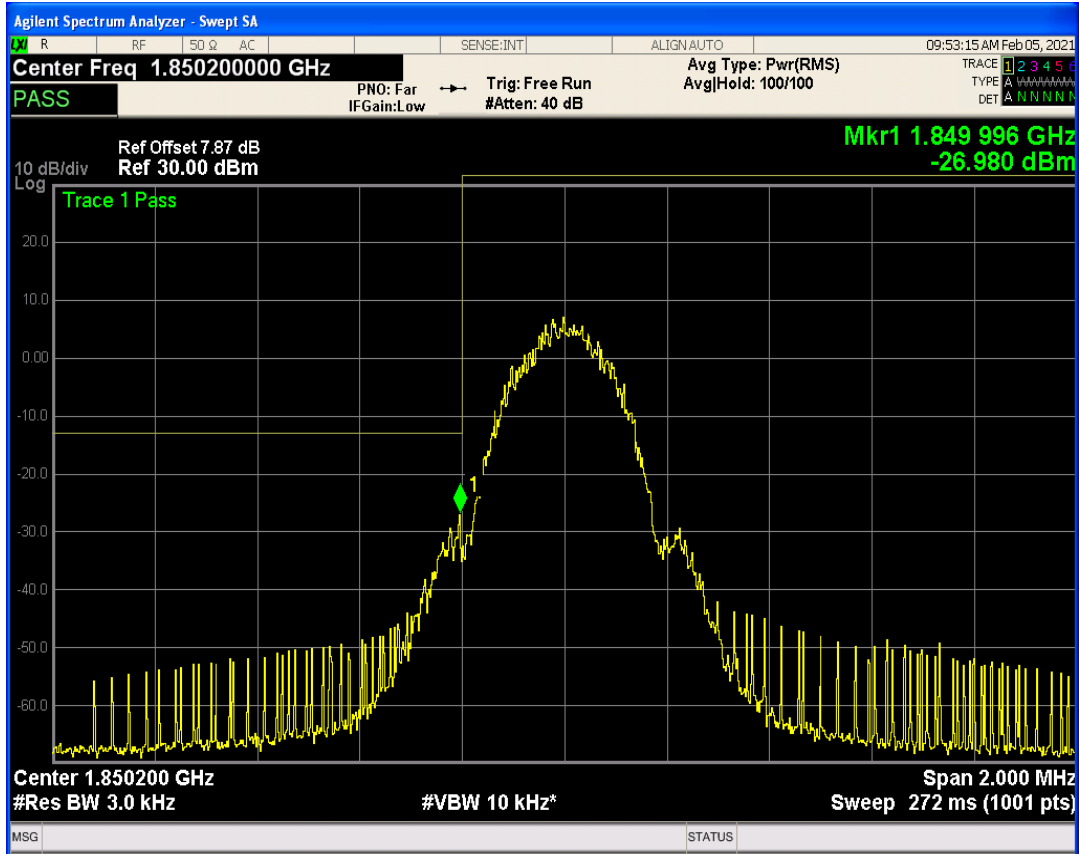

GPRS1900 Channel=810

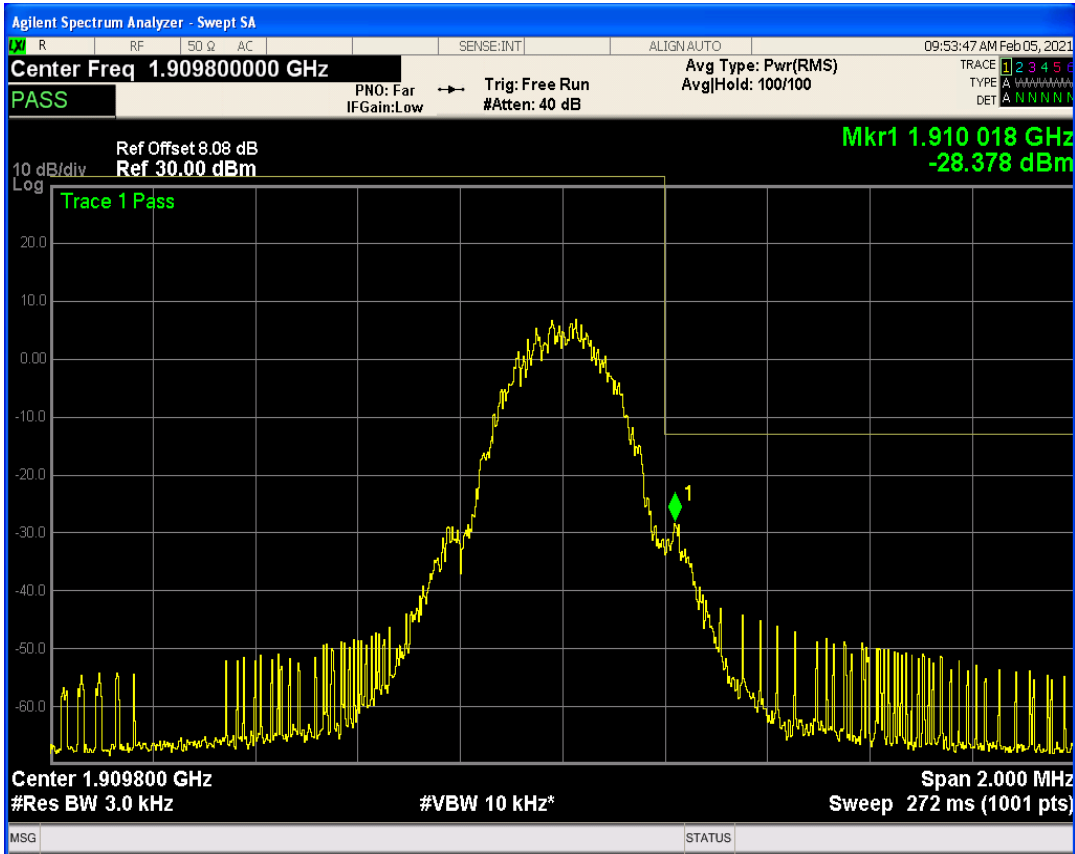

GPRS850 Channel=128

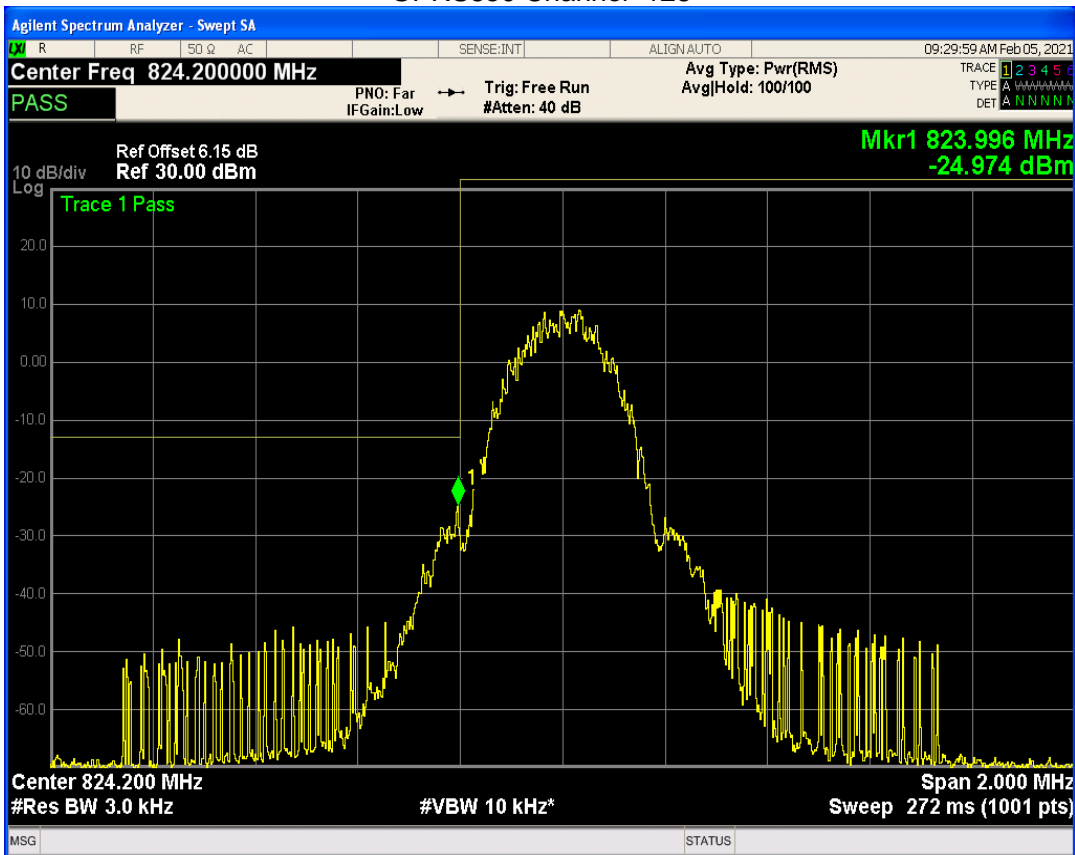

GPRS850 Channel=251

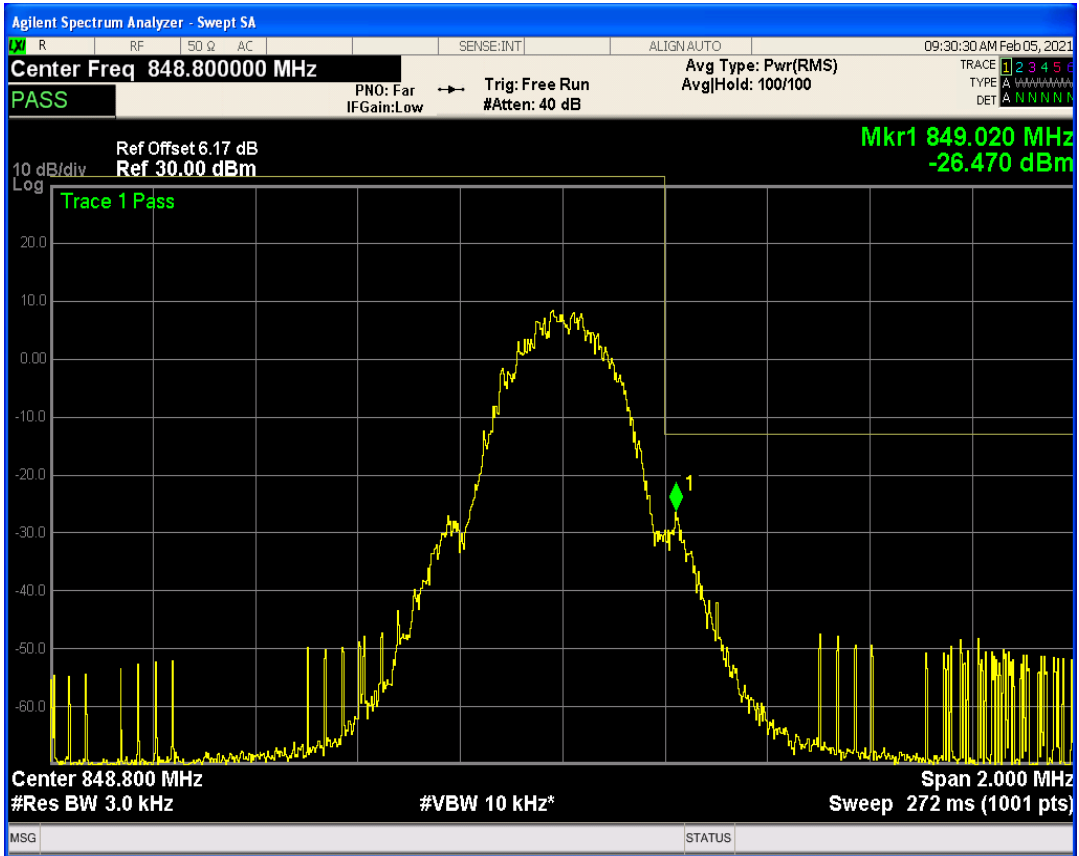

8.15 OUT-OF-BAND EMISSIONS

Band	Channel	Frequency (MHz)	Spur Freq (MHz)	Spur Level (dBm)	Limit (dBm)	Verdict
GPRS1900	512	1850.2	19877.68	-23.95	-13	PASS
GPRS1900	661	1880	19958.56	-23.70	-13	PASS
GPRS1900	810	1909.8	19872.19	-23.22	-13	PASS
GPRS850	128	824.2	7626.39	-30.10	-13	PASS
GPRS850	189	836.4	3146.87	-28.58	-13	PASS
GPRS850	251	848.8	3126.43	-29.66	-13	PASS

GPRS1900 Channel=661

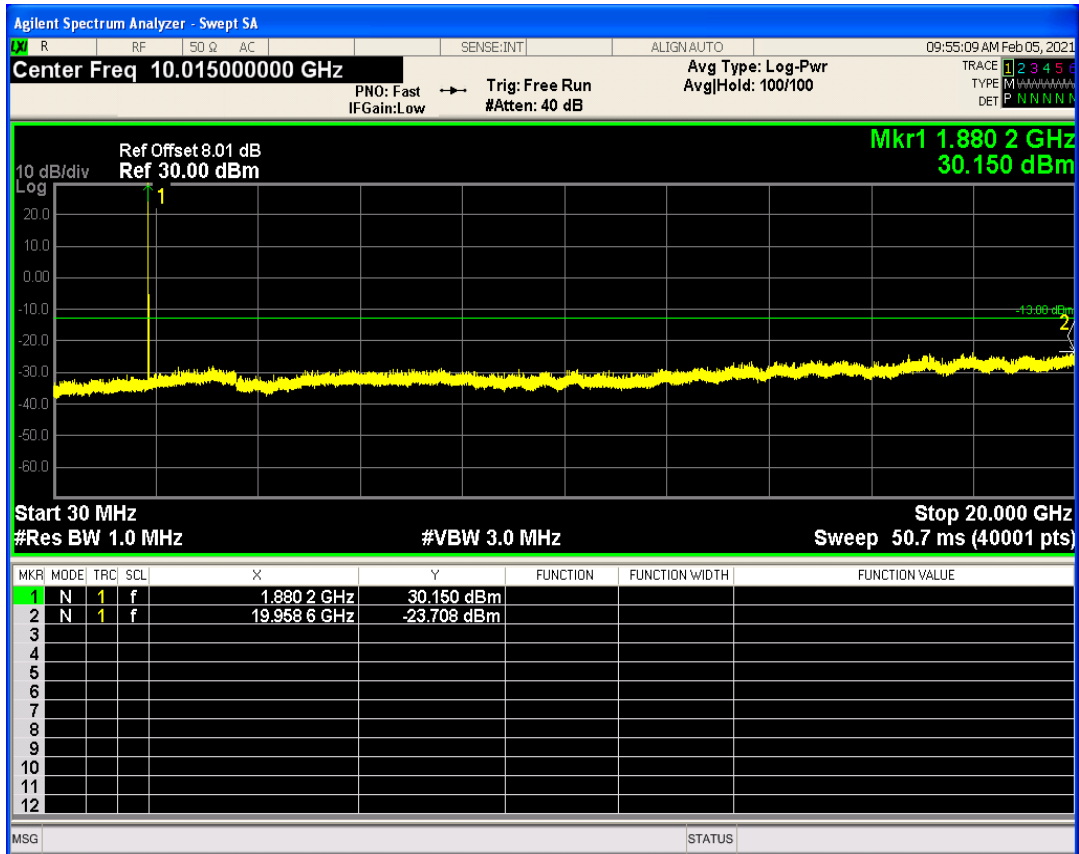

GPRS1900 Channel=512

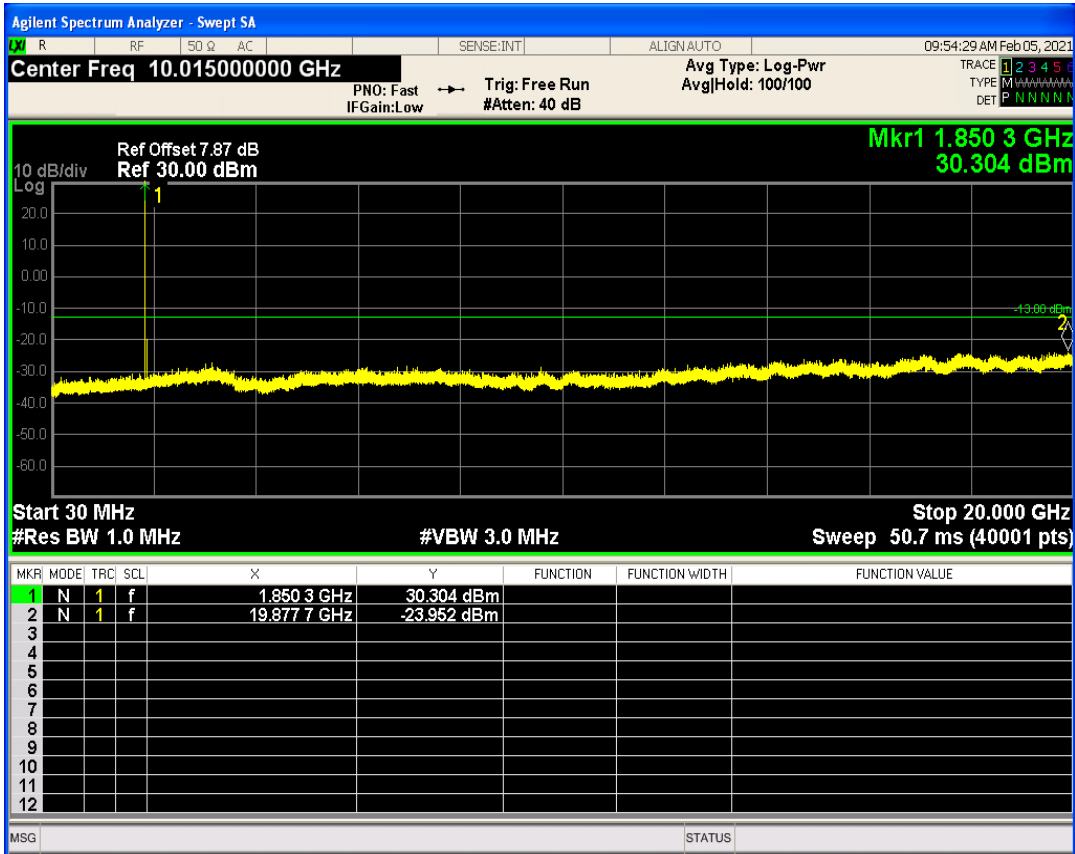

GPRS1900 Channel=810

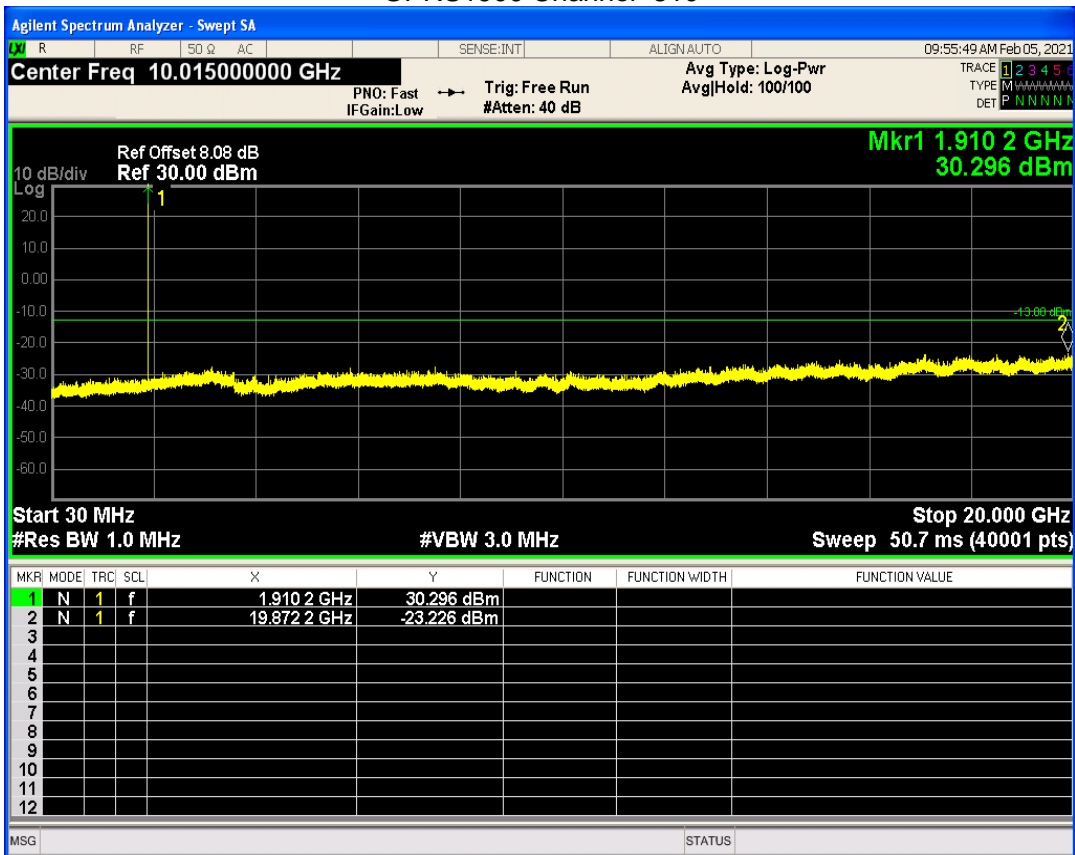

GPRS850 Channel=189

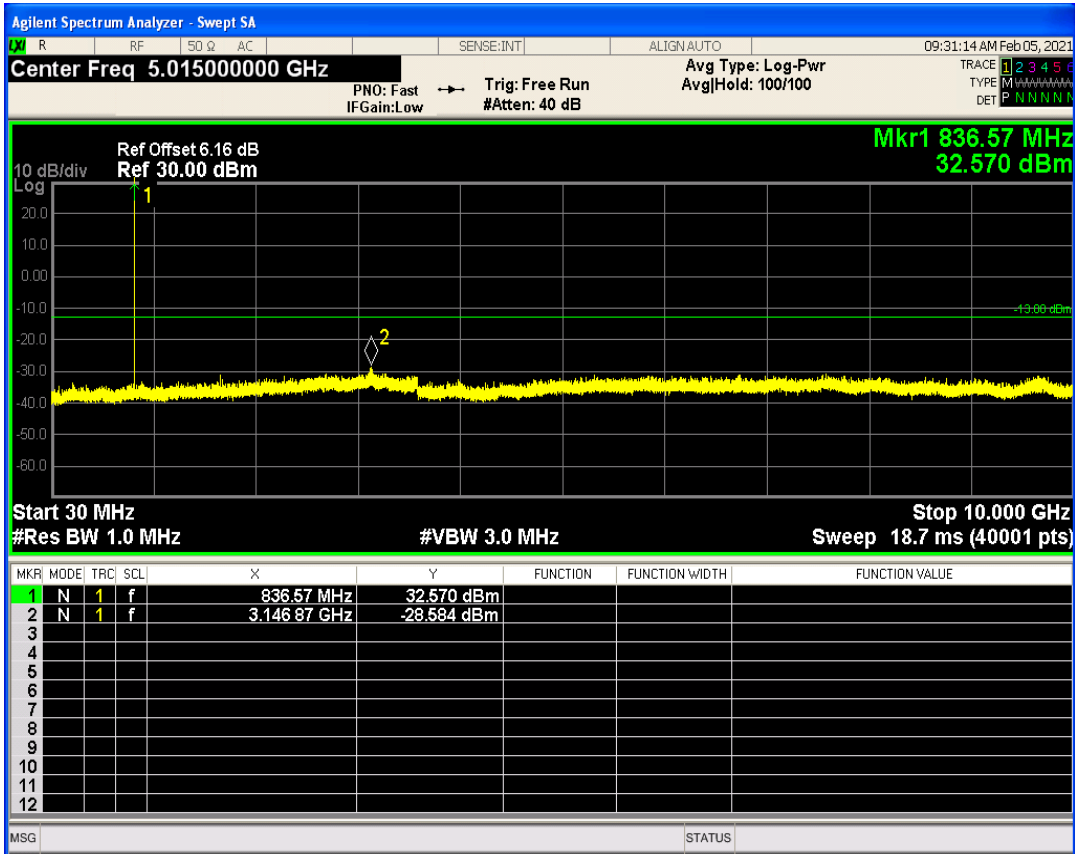

GPRS850 Channel=128

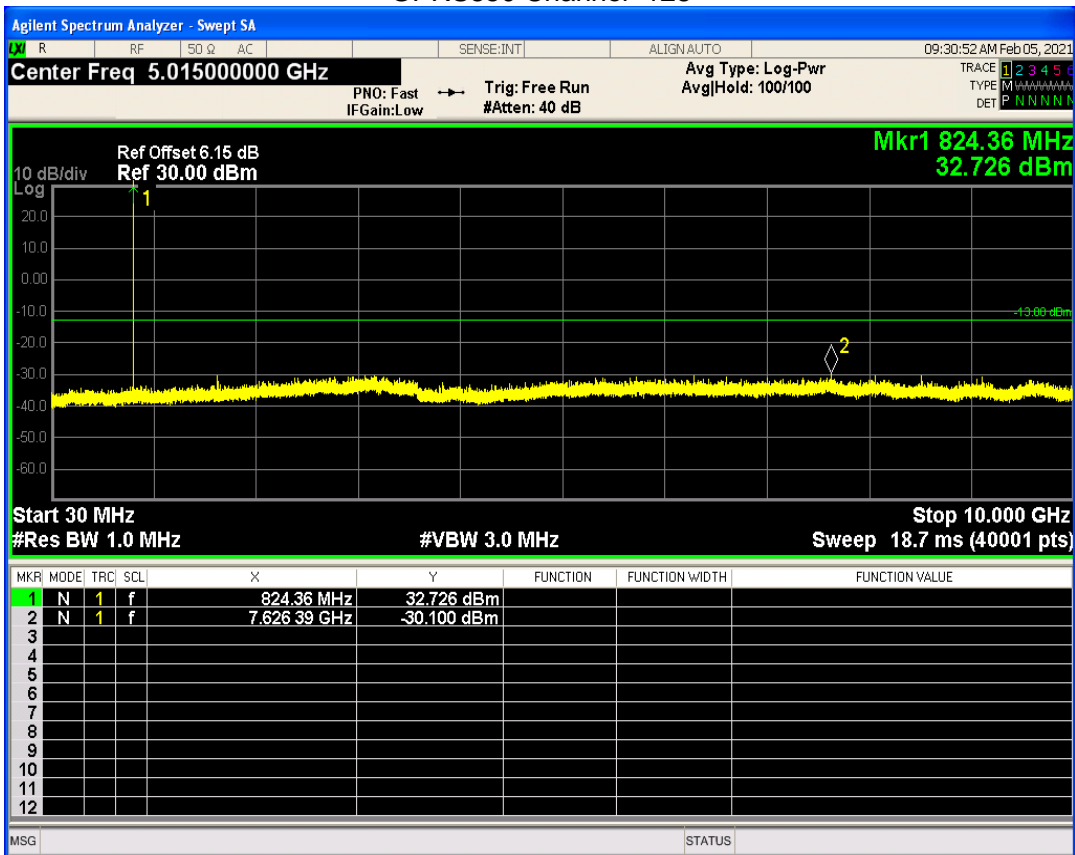

GPRS850 Channel=251

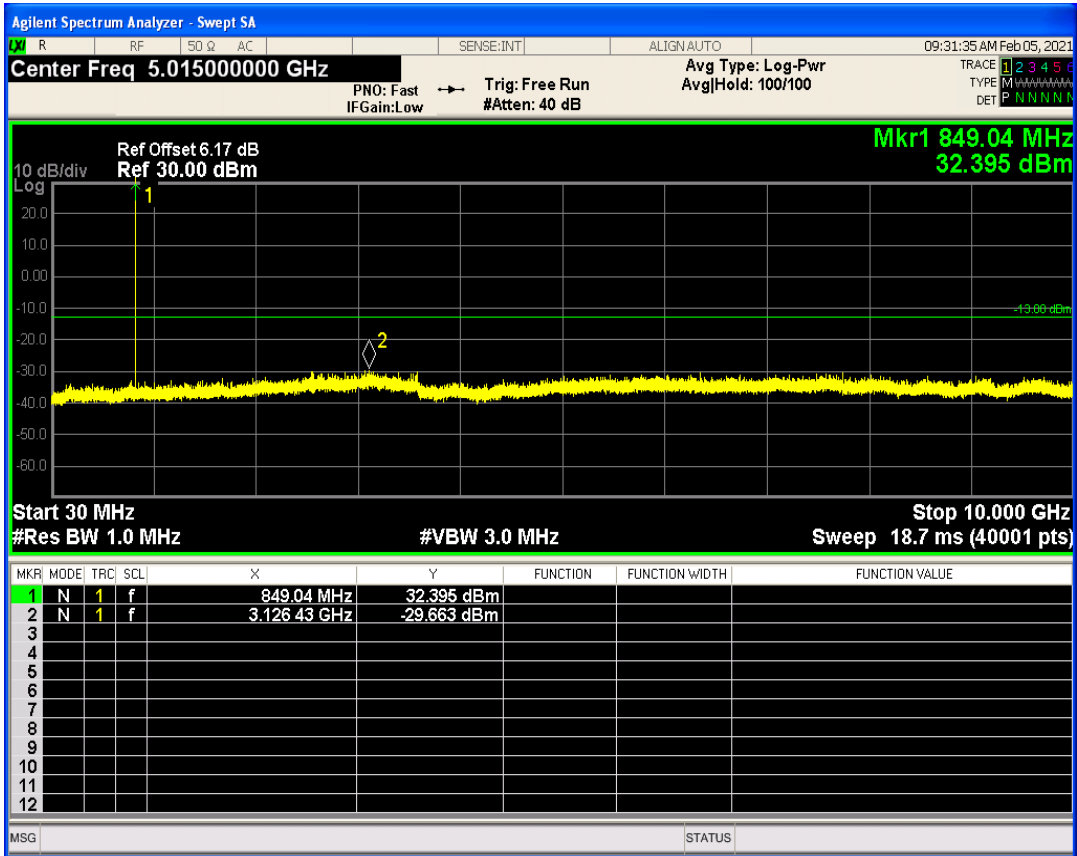

END OF REPORT