

FCC RADIO TEST REPORT

FCC ID: QRP-SP-016

Product: Mobile phone

Trade Mark: AZUMI

Model No.: A4 GO

Family Model: N/A

Report No.: S20080606402004

Issue Date: 19 Aug.2020

Prepared for

Azumi S.A

Avenida Aquilino de la Guardia con Calle 47, PH Ocean Plaza,
Piso 16 of. 16-01, Marbella, Ciudad de Panama, Panama

Prepared by

Shenzhen NTEK Testing Technology Co., Ltd.

1/F, Building E, Fenda Science Park Sanwei, Xixiang, Bao'an District
Shenzhen, Guangdong, China

Tel.: +86-755-6115 6588

Fax.: +86-755-6115 6599

Website: <http://www.ntek.org.cn>

TABLE OF CONTENTS

| | | |
|----------|--|-----------|
| 1 | TEST RESULT CERTIFICATION | 3 |
| 2 | SUMMARY OF TEST RESULTS..... | 4 |
| 3 | FACILITIES AND ACCREDITATIONS | 5 |
| 3.1 | FACILITIES..... | 5 |
| 3.2 | LABORATORY ACCREDITATIONS AND LISTINGS | 5 |
| 3.3 | MEASUREMENT UNCERTAINTY | 5 |
| 4 | GENERAL DESCRIPTION OF EUT | 6 |
| 5 | DESCRIPTION OF TEST MODES | 8 |
| 6 | SETUP OF EQUIPMENT UNDER TEST | 9 |
| 6.1 | BLOCK DIAGRAM CONFIGURATION OF TEST SYSTEM..... | 9 |
| 6.2 | SUPPORT EQUIPMENT..... | 10 |
| 6.3 | EQUIPMENTS LIST FOR ALL TEST ITEMS..... | 11 |
| 7 | TEST REQUIREMENTS | 12 |
| 7.1 | FIELD STRENGTH OF SPURIOUS RADIATION | 12 |
| 7.2 | EFFECTIVE RADIATED POWER AND EFFECTIVE ISOTROPIC RADIATED POWER..... | 20 |
| 7.3 | CONDUCTED OUTPUT POWER..... | 25 |
| 7.4 | FREQUENCY STABILITY | 27 |
| 7.5 | PEAK-TO-AVERAGE RATIO | 32 |
| 7.6 | 26DB BANDWIDTH AND 99% OCCUPIED BANDWIDTH | 33 |
| 7.7 | CONDUCTED BAND EDGE | 35 |
| 7.8 | CONDUCTED SPURIOUS EMISSION AT ANTENNA TERMINAL | 36 |
| 8 | TEST RESULTS | 37 |
| 8.1 | CONDUCTED OUTPUT POWER | 37 |
| 8.2 | PEAK-TO-AVERAGE RATIO | 39 |
| 8.3 | OCCUPIED BANDWIDTH..... | 49 |
| 8.4 | BAND EDGE..... | 59 |
| 8.5 | OUT-OF-BAND EMISSIONS | 66 |

1 TEST RESULT CERTIFICATION

| | |
|-----------------------------------|--|
| Applicant's name | Azumi S.A |
| Address | Avenida Aquilino de la Guardia con Calle 47, PH Ocean Plaza, Piso 16 of. 16-01, Marbella, Ciudad de Panama, Panama |
| Manufacturer's Name | AZUMI HK LTD |
| Address | FLAT/RM 18 BLK 1 14/F GOLDEN INDUSTRIAL BUILDING 16-26 KWAI TAK STREET KWAI CHUNG, HK |
| Product description | |
| Product name | Mobile phone |
| Model and/or type reference | A4 GO |
| Family Model | N/A |

Measurement Procedure Used:

| APPLICABLE STANDARDS | |
|--|-------------|
| APPLICABLE STANDARD/ TEST PROCEDURE | TEST RESULT |
| 47 CFR Part 2, Part 22H, Part 24E ANSI/TIA-603-E-2016 FCC KDB 971168 D01 Power Meas License Digital Systems v03r01 ANSI C63.26:2015 | Complied |

This device described above has been tested by Shenzhen NTEK Testing Technology Co., Ltd., and the test results show that the equipment under test (EUT) is in compliance with the FCC requirements. And it is applicable only to the tested sample identified in the report.

This report shall not be reproduced except in full, without the written approval of Shenzhen NTEK Testing Technology Co., Ltd., this document may be altered or revised by Shenzhen NTEK Testing Technology Co., Ltd., personnel only, and shall be noted in the revision of the document.

The test results of this report relate only to the tested sample identified in this report.

Date of Test : 06 Aug.2020 ~ 19 Aug.2020

Testing Engineer : *Cheng Jiawen*
(Cheng Jiawen)

Technical Manager : *Jason Chen*
(Jason Chen)

Authorized Signatory : *Alex*
(Alex Li)

2 SUMMARY OF TEST RESULTS

| FCC Part22, Subpart H/ FCC Part24 KDB 971168 D01 Power Meas License Digital Systems v03r01 | | | |
|---|---|---------|--------|
| FCC Rule | Test Item | Verdict | Remark |
| 2.1046 | Conducted Output Power | PASS | |
| 24.232(d) KDB 971168 D01 Clause 5.7 | Peak-to-Average Ratio | PASS | |
| 2.1049 22.917(b) 24.238(b) KDB 971168 D01 Clause 4.2 | Occupied Bandwidth | PASS | |
| 2.1051 22.917(a) 24.238(a) KDB 971168 D01 Clause 6 | Band Edge | PASS | |
| 22.913(a)(2) KDB 971168 D01 Clause 5.6 | Effective Radiated Power | PASS | |
| 24.232(c) KDB 971168 D01 Clause 5.6 | Equivalent Isotropic Radiated Power | PASS | |
| 2.1053 22.917(a) 24.238(a) KDB 971168 D01 Clause 7 | Field Strength of Spurious Radiation | PASS | |
| 2.1055 22.355 24.235 KDB 971168 D01 Clause 9 | Frequency Stability for Temperature & Voltage | PASS | |
| 2.1051 22.917(a) 24.238(a) KDB 971168 D01 Clause 6 | Conducted Emission | PASS | |

Remark:

1. "N/A" denotes test is not applicable in this Test Report.
2. All test items were verified and recorded according to the standards and without any deviation during the test.
3. No modifications are made to the EUT during all test items.
4. This EUT has also been tested and complied with the requirements of FCC Part 15, Subpart B, recorded in a separate test report.

3 FACILITIES AND ACCREDITATIONS

3.1 FACILITIES

All measurement facilities used to collect the measurement data are located at 1/F, Building E, Fenda Science Park Sanwei, Xixiang, Bao'an District Shenzhen, Guangdong, China

The sites are constructed in conformance with the requirements of ANSI C63.7, ANSI C63.26 and CISPR Publication 22.

3.2 LABORATORY ACCREDITATIONS AND LISTINGS

Site Description

- CNAS-Lab. : The Laboratory has been assessed and proved to be in compliance with CNAS-CL01:2006 (identical to ISO/IEC 17025:2005)
The Certificate Registration Number is L5516.
- IC-Registration : The Certificate Registration Number is 9270A.
CAB identifier:CN0074
- FCC- Accredited : Test Firm Registration Number: 463705.
Designation Number: CN1184
- A2LA-Lab. : The Certificate Registration Number is 4298.01
This laboratory is accredited in accordance with the recognized International Standard ISO/IEC 17025:2005 General requirements for the competence of testing and calibration laboratories.
This accreditation demonstrates technical competence for a defined scope and the operation of a laboratory quality management system (refer to joint ISO-ILAC-IAF Communiqué dated 8 January 2009).
- Name of Firm : Shenzhen NTEK Testing Technology Co., Ltd.
- Site Location : 1/F, Building E, Fenda Science Park, Sanwei Community, Xixiang Street, Bao'an District, Shenzhen 518126 P.R. China.

3.3 MEASUREMENT UNCERTAINTY

The reported uncertainty of measurement, where expanded uncertainty U is based on a standard uncertainty multiplied by a coverage factor of k=2, providing a level of confidence of approximately 95 %.

| No. | Item | Uncertainty |
|-----|---|-------------|
| 1 | Measuring Uncertainty for a Level of Confidence of 95% (U = 2Uc(y)) | 2.5dB |
| | | |
| | | |
| | | |
| | | |
| | | |
| | | |

4 GENERAL DESCRIPTION OF EUT

| Product Feature and Specification | |
|-----------------------------------|--|
| Equipment | Mobile phone |
| Trade Mark | AZUMI |
| FCC ID | QRP-SP-016 |
| Model No. | A4 GO |
| Family Model | N/A |
| Model Difference | N/A |
| Operating Frequency | <input checked="" type="checkbox"/> GSM850: TX824.2MHz~848.8MHz /RX869.2MHz~893.8MHz; <input checked="" type="checkbox"/> UMTS FDD Band V: TX826.4MHz~846.6MHz /RX871.4MHz~891.6MHz; <input checked="" type="checkbox"/> PCS1900: TX1850.2MHz~1909.8MHz /RX1930.2MHz~1989.8MHz; <input checked="" type="checkbox"/> UMTS FDD Band II: TX1852.4MHz~1907.6MHz /RX1932.4MHz~1987.6MHz; |
| Modulation | <input checked="" type="checkbox"/> GMSK for GSM/GPRS; <input checked="" type="checkbox"/> QPSK for UMTS bands; |
| GPRS Class | <input checked="" type="checkbox"/> Multi-Class12 <input checked="" type="checkbox"/> Only 4 timeslots are used for GPRS |
| SIM CARD | SIM 1 and SIM 2 is a chipset unit and tested as a single chipset. The SIM 1 is chosen for test. |
| Antenna Type | PIFA Antenna |
| Antenna Gain | GSM850:-2.0dBi, PCS1900:-1.2dBi, W850:-2.0dBi, W1900:-1.2dBi |
| Power supply | <input checked="" type="checkbox"/> DC supply: DC 3.7V/1300mAh from Battery |
| | <input checked="" type="checkbox"/> Adapter supply: Input: AC100~240V 0.2A 50~60Hz Output: DC 5V 500mA |
| HW Version | V1.0 |
| SW Version | AZUMI_A4_GO_OM_V001 |

Note: Based on the application, features, or specification exhibited in User's Manual, the EUT is considered as an ITE/Computing Device. More details of EUT technical specification, please refer to the User's Manual. The High Voltage 4.2V and Low Voltage 3.4V was declared by manufacturer, The EUT couldn't be operate normally with higher or lower voltage.

5 DESCRIPTION OF TEST MODES

During the testing, the EUT was controlled via Rhode & Schwarz Digital Radio Communication Tester(CMU 200) to ensure max power transmission and proper modulation. Three channels (The low channel, the middle channel and the high channel) were chosen for testing on all frequency band.

Note: GSM/GPRS 850, GSM/GPRS 1900, RMC12.2K/HSDPA/HSUPA band II, RMC12.2K/HSDPA/HSUPA band V modes have been tested during the test. the worst condition (GSM850, GSM1900, RMC 12.2k) be recorded in the test report if no other modes test data.

Antenna port conducted and radiated test items were performed according to KDB 971168 D01 Power Meas. License Digital Systems v03r01 with maximum output power.

Radiated measurements were performed with rotating EUT in different three orthogonal test planes to find the maximum emission.

Radiated emissions were investigated as following frequency range:

1. 30 MHz to 10th harmonic for GSM850/UMTS FDD Band V.
2. 30 MHz to 10th harmonic for GSM1900/UMTS FDD Band II.

All modes and data rates and positions were investigated.

Test modes are chosen to be reported as the worst case configuration below:

| Test Modes | | |
|--------------|--------------------------|-------------------------|
| Band | For Conducted Test Cases | For Radiated Test Cases |
| GSM 850 | GSM Link | GSM Link |
| GSM 1900 | GSM Link | GSM Link |
| UMTS Band II | RMC 12.2Kbps Link | RMC 12.2Kbps Link |
| UMTS Band V | RMC 12.2Kbps Link | RMC 12.2Kbps Link |

Test Frequency and Channels:

| Frequency Band | <input checked="" type="checkbox"/> GSM 850 | | <input checked="" type="checkbox"/> GSM 1900 | | <input checked="" type="checkbox"/> UMTS Band II | | <input checked="" type="checkbox"/> UMTS Band V | |
|----------------|---|-----------------|--|-----------------|--|-----------------|---|-----------------|
| | Channel | Frequency (MHz) | Channel | Frequency (MHz) | Channel | Frequency (MHz) | Channel | Frequency (MHz) |
| CH_H | 251 | 848.8 | 810 | 1909.8 | 9538 | 1907.6 | 4233 | 846.6 |
| CH_M | 189 | 836.4 | 661 | 1880.0 | 9400 | 1880.0 | 4182 | 836.4 |
| CH_L | 128 | 824.2 | 512 | 1850.2 | 9262 | 1852.4 | 4132 | 826.4 |

1. EUT built-in battery-powered, the battery is fully-charged.

6 SETUP OF EQUIPMENT UNDER TEST

6.1 BLOCK DIAGRAM CONFIGURATION OF TEST SYSTEM

For Radiated Test Cases

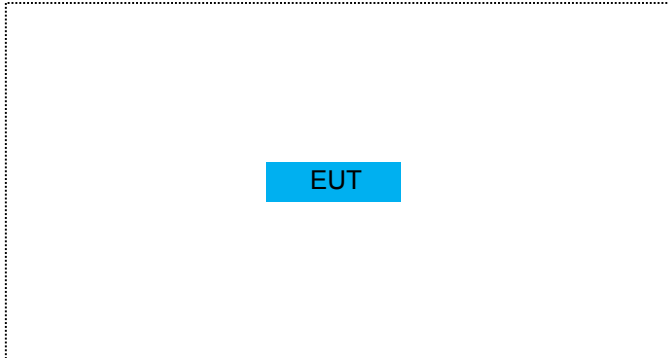

For Conducted Output Power

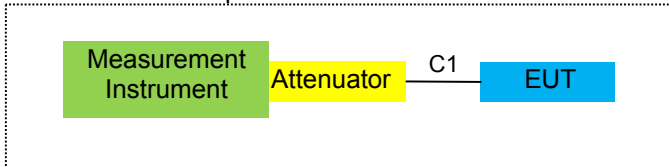

For Peak-to Average Ratio, Occupied Bandwidth, Conducted Band edge and Conducted Spurious Emission

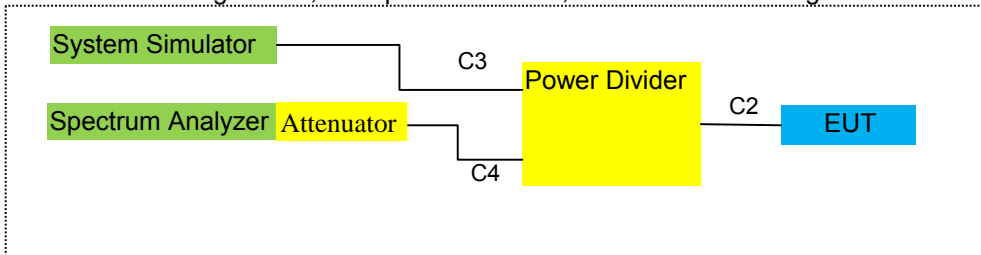

For Frequency Stability

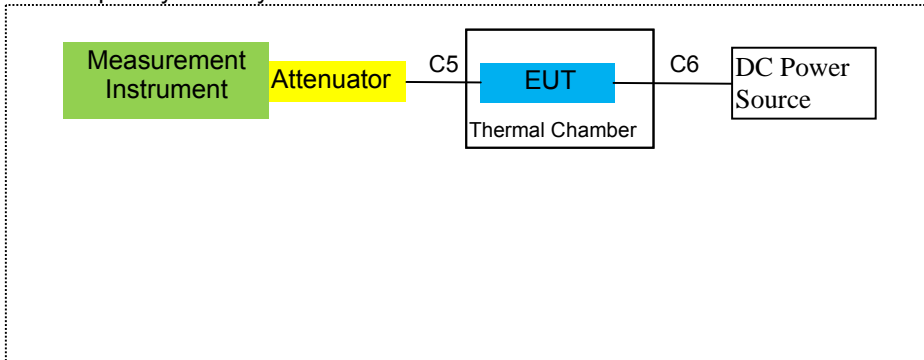

6.2 SUPPORT EQUIPMENT

The EUT has been tested as an independent unit together with other necessary accessories or support units. The following support units or accessories were used to form a representative test configuration during the tests.

| Item | Equipment | Mfr/Brand | Model/Type No. | Series No. | Note |
|------|-----------|-----------|----------------|------------|------|
| | | | | | |
| | | | | | |
| | | | | | |
| | | | | | |
| | | | | | |

| Item | Cable Type | Shielded Type | Ferrite Core | Length |
|------|------------|---------------|--------------|--------|
| C-1 | RF Cable | YES | NO | 0.1m |
| C-2 | RF Cable | YES | NO | 0.1m |
| C-3 | RF Cable | YES | NO | 0.1m |
| C-4 | RF Cable | YES | NO | 0.2m |
| C-5 | RF Cable | YES | NO | 0.2m |
| C-6 | DC Cable | NO | NO | 1.0m |
| | | | | |
| | | | | |

Notes:

- (1) The support equipment was authorized by Declaration of Confirmation.
- (2) For detachable type I/O cable should be specified the length in cm in 『Length』 column.
- (3) “YES” is means “shielded” “with core”; “NO” is means “unshielded” “without core”.

6.3 EQUIPMENTS LIST FOR ALL TEST ITEMS

| Item | Kind of Equipment | Manufacturer | Type No. | Serial No. | Last calibration | Calibrated until | Calibration period |
|------|-----------------------|--------------|-----------------|------------------|------------------|------------------|--------------------|
| 1 | MXA Signal Analyzer | Agilent | N9020A | MY49100060 | 2020.7.13 | 2021.7.12 | 1 year |
| 2 | Test Receiver | R&S | ESPI | 101318 | 2020.05.11 | 2021.05.10 | 1 year |
| 3 | Bilog Antenna | TESEQ | CBL6111D | 31216 | 2020.04.11 | 2021.04.10 | 1 year |
| 4 | 50Ω Coaxial Switch | Anritsu | MP59B | 6200983705 | 2020.05.11 | 2023.05.10 | 3 year |
| 5 | Horn Antenna | EM | EM-AH-1018 0 | 2011071402 | 2018.04.08 | 2021.04.07 | 3 year |
| 6 | Horn Ant | Schwarzbeck | BBHA 9170 | 9170-181 | 2019.11.18 | 2020.11.17 | 1 year |
| 7 | Amplifier | EM | EM-30180 | 060538 | 2020.7.13 | 2021.7.12 | 1 year |
| 8 | Loop Antenna | ARA | PLA-1030/B | 1029 | 2020.05.11 | 2021.05.10 | 1 year |
| 9 | Power Meter | R&S | NRVS | 100696 | 2020.7.13 | 2021.7.12 | 1 year |
| 10 | Power Sensor | R&S | URV5-Z4 | 0395.1619.0 5 | 2020.05.11 | 2021.05.10 | 1 year |
| 11 | Test Cable | N/A | R-01 | N/A | 2019.08.06 | 2022.08.05 | 3 year |
| 12 | Test Cable | N/A | R-02 | N/A | 2019.08.06 | 2022.08.05 | 3 year |
| 13 | Test Cable | N/A | R-03 | N/A | 2019.08.06 | 2022.08.05 | 3 year |
| 14 | Test Receiver | R&S | ESCI | 101160 | 2020.05.11 | 2021.05.10 | 1 year |
| 15 | LISN | R&S | ENV216 | 101313 | 2020.05.11 | 2021.05.10 | 1 year |
| 16 | LISN | EMCO | 3816/2 | 00042990 | 2020.05.11 | 2021.05.10 | 1 year |
| 17 | 50Ω Coaxial Switch | Anritsu | MP59B | 6200264417 | 2020.05.11 | 2021.05.10 | 1 year |
| 18 | Passive Voltage Probe | R&S | ESH2-Z3 | 100196 | 2020.05.11 | 2023.05.10 | 3 year |
| 19 | Test Cable | N/A | C01 | N/A | 2020.05.11 | 2023.05.10 | 3 year |
| 20 | Test Cable | N/A | C02 | N/A | 2020.05.11 | 2023.05.10 | 3 year |
| 21 | Test Cable | N/A | C03 | N/A | 2020.05.11 | 2023.05.10 | 3 year |
| 22 | Spectrum Analyzer | agilent | e4440a | us44300399 | 2020.05.11 | 2021.05.10 | 1 year |
| 23 | test receiver | R&S | ESCI | a0304218 | 2020.05.11 | 2021.05.10 | 1 year |
| 24 | Communication Tester | R&S | CMU200 | A0304247 | 2020.05.11 | 2021.05.10 | 1 year |
| 25 | Thermal Chamber | Ten Billion | TTC-B3C | TBN-960502 | 2020.05.11 | 2021.05.10 | 1 year |
| 26 | DC Power Source | N/A | PS-6005D | 2017040292 3 | 2020.05.11 | 2023.05.10 | 3 year |

Note: Each piece of equipment is scheduled for calibration once a year except the Test Cable& DC Power Source which is scheduled for calibration every 3 years.

7 TEST REQUIREMENTS

7.1 FIELD STRENGTH OF SPURIOUS RADIATION

7.1.1 Applicable Standard

According to FCC KDB 971168 D01 v03r01 Section 5.8 and ANSI/TIA-603-E-2016 Section 2.2.12

7.1.2 Conformance Limit

The power of any emission outside of the authorized operating frequency ranges must be attenuated below the transmitter power (P) by a factor of at least $43 + 10 \log (P)$ dB. The spectrum is scanned from 30 MHz up to a frequency including its 10th harmonic.

7.1.3 Measuring Instruments

The Measuring equipment is listed in the section 6.3 of this test report.

7.1.4 Test Configuration

According to the ANSI/TIA-603-E-2016 test method, The Receiver or Spectrum was scanned from 9 KHz to the 10th harmonic of the highest frequency generated within the equipment, which is the transmitted carrier that can be as high as 1910 MHz The resolution bandwidth is set as outlined in Part 24.238, Part 22.917. The spectrum is scanned with the mobile station transmitting at carrier frequencies that pertain to low, mid and high channels of WCDMA Band II / WCDMA Band V / GSM 850/ GSM 1900.

TEST CONFIGURATION

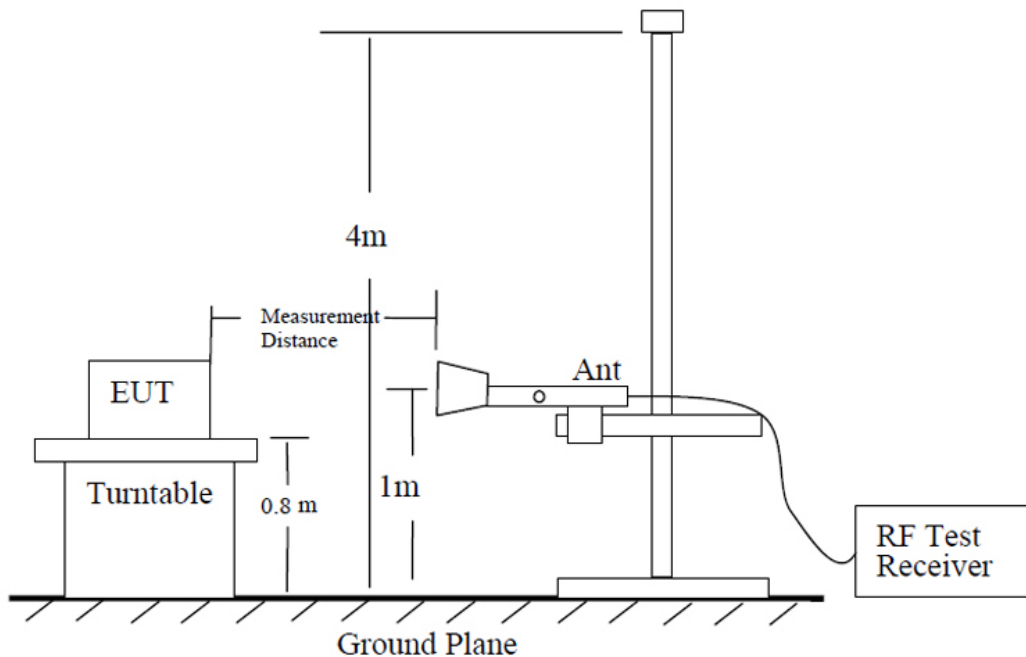

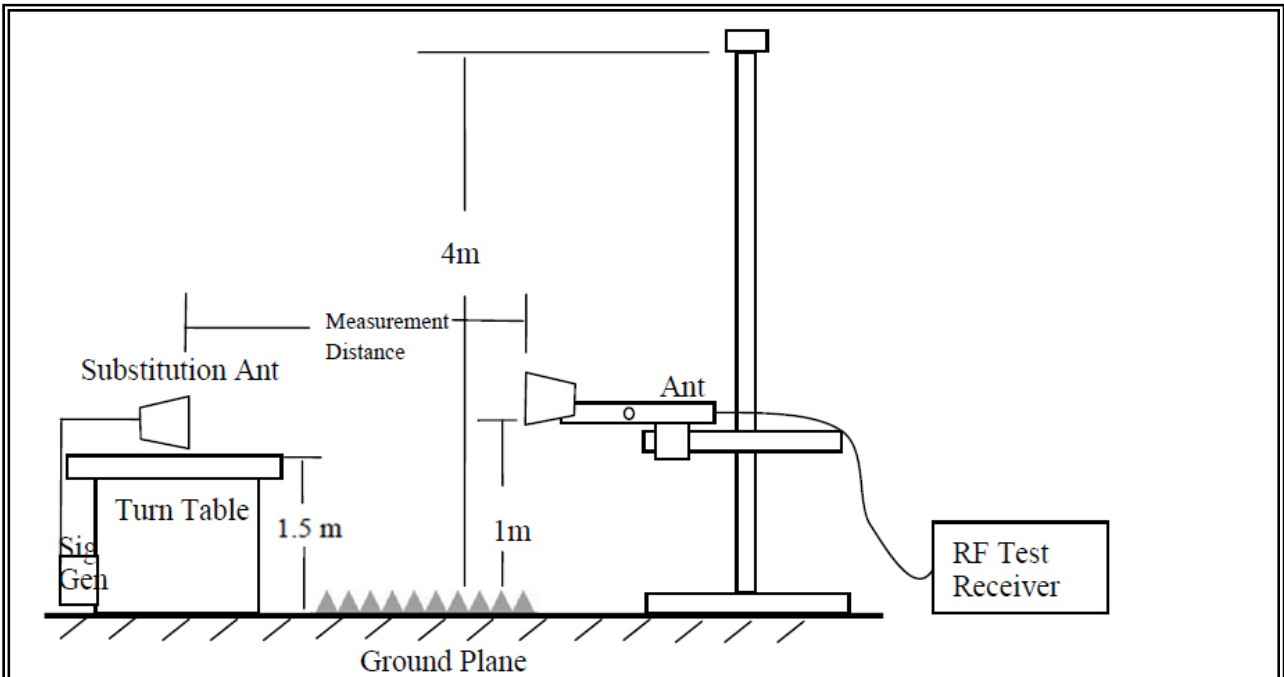

7.1.5 Test Procedure

1. EUT was placed on a 0.8 meter (For frequency above 1G, EUT should be placed on 1.5m) high non-conductive stand at a 3 meter test distance from the receive antenna. A receiving antenna was placed on the antenna mast 3 meters from the EUT for emission measurements. The height of receiving antenna is 1.50 meter. Detected emissions were maximized at each frequency by rotating the EUT through 360° and adjusting the receiving antenna polarization. The radiated emission measurements of all transmit frequencies in three channels (High, Middle, Low) were measured with peak detector.
2. A log-periodic antenna or double-ridged waveguide horn antenna shall be substituted in place of the EUT. The log-periodic antenna will be driven by a signal generator and the level will be adjusted till the same power value on the spectrum analyzer or receiver. The level of the spurious emissions can be calculated through the level of the signal generator, cable loss, the gain of the substitution antenna and the reading of the spectrum analyzer or receiver.
3. The EUT is then put into continuously transmitting mode at its maximum power level during the test. Set Test Receiver or Spectrum RBW=1MHz, VBW=3MHz, And the maximum value of the receiver should be recorded as (P_r).
4. The EUT shall be replaced by a substitution antenna. In the chamber, an substitution antenna for the frequency band of interest is placed at the reference point of the chamber. An RF Signal source for the frequency band of interest is connected to the substitution antenna with a cable that has been constructed to not interfere with the radiation pattern of the antenna. A power (SG Level) is applied to the input of the substitution antenna, and adjust the level of the signal generator output until the value of the receiver reach the previously recorded (P_r). The power of signal source (SG Level) is recorded. The test should be performed by rotating the test item and adjusting the receiving antenna polarization.
5. A amplifier should be connected to the Signal Source output port. And the cable should be connect between the Amplifier and the Substitution Antenna. The cable loss (Cable Loss), the Substitution Antenna Gain should be recorded after test.
The measurement results are obtained as described below:
Power(EIRP)= SG Level- Cable Loss+ Antenna Gain
6. This value is EIRP since the measurement is calibrated using an antenna of known gain (2.15 dBi) and known input power.
7. ERP can be calculated from EIRP by subtracting the gain of the dipole, ERP = EIRP -2.15dBi.

7.1.6 Test Results

| | | | |
|--------------|---|--------------------|--------------|
| EUT: | Mobile phone | Model No.: | A4 GO |
| Temperature: | 20 °C | Relative Humidity: | 48% |
| Test Mode: | GSM/GPRS 850/ GSM/GPRS 1900 UMTS band II/ UMTS band V | Test By: | Cheng Jiawen |

■ Radiated Spurious Emission

| GSM 850 | | | | | | | |
|--|----------|------------|--------------|----------------|-------|------------|------------|
| Frequency | SG Level | Cable Loss | Antenna Gain | Absolute Level | Limit | Over Limit | Polarity |
| (MHz) | (dBm) | (dB) | (dB) | (dBm) | (dBm) | (dBm) | |
| Test Results for Channel 128/824.2 MHz | | | | | | | |
| 1648.4 | -51.75 | 2.80 | 27.50 | -27.05 | -13 | -14.05 | Vertical |
| 1648.4 | -46.04 | 2.80 | 27.50 | -21.34 | -13 | -8.34 | Horizontal |
| 2472.6 | -51.57 | 2.91 | 27.80 | -26.68 | -13 | -13.68 | Vertical |
| 2472.6 | -53.62 | 2.91 | 27.80 | -28.73 | -13 | -15.73 | Horizontal |
| 3296.8 | -45.35 | 4.02 | 29.87 | -19.50 | -13 | -6.50 | Vertical |
| 3296.8 | -49.99 | 4.02 | 29.87 | -24.14 | -13 | -11.14 | Horizontal |
| 131.2 | -45.18 | 1.35 | 17.77 | -28.76 | -13 | -15.76 | Vertical |
| 116.8 | -45.70 | 1.77 | 17.83 | -29.64 | -13 | -16.64 | Horizontal |
| Test Results for Channel 189/836.4 MHz | | | | | | | |
| 1673.2 | -53.24 | 2.80 | 27.48 | -28.56 | -13 | -15.56 | Vertical |
| 1673.2 | -48.59 | 2.80 | 27.48 | -23.91 | -13 | -10.91 | Horizontal |
| 2509.8 | -48.70 | 2.91 | 27.70 | -23.91 | -13 | -10.91 | Vertical |
| 2509.8 | -44.56 | 2.91 | 27.70 | -19.77 | -13 | -6.77 | Horizontal |
| 3346.4 | -47.11 | 4.02 | 29.82 | -21.31 | -13 | -8.31 | Vertical |
| 3346.4 | -48.55 | 4.02 | 29.82 | -22.75 | -13 | -9.75 | Horizontal |
| 208.8 | -50.55 | 1.44 | 15.26 | -36.74 | -13 | -23.74 | Vertical |
| 131.6 | -44.02 | 1.51 | 17.23 | -28.30 | -13 | -15.30 | Horizontal |
| Test Results for Channel 251/848.8 MHz | | | | | | | |
| 1697.6 | -50.66 | 2.80 | 27.42 | -26.04 | -13 | -13.04 | Vertical |
| 1697.6 | -51.72 | 2.80 | 27.42 | -27.10 | -13 | -14.10 | Horizontal |
| 2546.4 | -50.45 | 2.91 | 27.68 | -25.68 | -13 | -12.68 | Vertical |
| 2546.4 | -49.78 | 2.91 | 27.68 | -25.01 | -13 | -12.01 | Horizontal |
| 3395.2 | -52.21 | 4.02 | 29.80 | -26.43 | -13 | -13.43 | Vertical |
| 3395.2 | -51.16 | 4.02 | 29.80 | -25.38 | -13 | -12.38 | Horizontal |
| 95.0 | -44.45 | 1.74 | 16.46 | -29.73 | -13 | -16.73 | Vertical |
| 208.3 | -49.82 | 1.68 | 16.21 | -35.29 | -13 | -22.29 | Horizontal |

Note:

1. Pre-test tests all modes, only the worst mode data is recorded in the report
2. All other emissions more than 20dB below the limit.

| GPRS 850 | | | | | | | |
|--|----------|------------|--------------|----------------|-------|------------|------------|
| Frequency | SG Level | Cable Loss | Antenna Gain | Absolute Level | Limit | Over Limit | Polarity |
| (MHz) | (dBm) | (dB) | (dB) | (dBm) | (dBm) | (dBm) | |
| Test Results for Channel 128/824.2 MHz | | | | | | | |
| 1648.4 | -49.95 | 2.80 | 27.50 | -25.25 | -13 | -12.25 | Vertical |
| 1648.4 | -44.21 | 2.80 | 27.50 | -19.51 | -13 | -6.51 | Horizontal |
| 2472.6 | -46.12 | 2.91 | 27.80 | -21.23 | -13 | -8.23 | Vertical |
| 2472.6 | -45.03 | 2.91 | 27.80 | -20.14 | -13 | -7.14 | Horizontal |
| 3296.8 | -44.07 | 4.02 | 29.87 | -18.22 | -13 | -5.22 | Vertical |
| 3296.8 | -47.34 | 4.02 | 29.87 | -21.49 | -13 | -8.49 | Horizontal |
| 154.8 | -48.93 | 1.35 | 16.91 | -33.37 | -13 | -20.37 | Vertical |
| 238.4 | -48.38 | 1.59 | 17.39 | -32.57 | -13 | -19.57 | Horizontal |
| Test Results for Channel 189/836.4 MHz | | | | | | | |
| 1673.2 | -47.98 | 2.80 | 27.48 | -23.30 | -13 | -10.30 | Vertical |
| 1673.2 | -50.18 | 2.80 | 27.48 | -25.50 | -13 | -12.50 | Horizontal |
| 2509.8 | -48.82 | 2.91 | 27.70 | -24.03 | -13 | -11.03 | Vertical |
| 2509.8 | -45.76 | 2.91 | 27.70 | -20.97 | -13 | -7.97 | Horizontal |
| 3346.4 | -48.39 | 4.02 | 29.82 | -22.59 | -13 | -9.59 | Vertical |
| 3346.4 | -49.89 | 4.02 | 29.82 | -24.09 | -13 | -11.09 | Horizontal |
| 110.1 | -53.52 | 1.36 | 17.36 | -37.52 | -13 | -24.52 | Vertical |
| 148.2 | -51.44 | 1.32 | 15.19 | -37.58 | -13 | -24.58 | Horizontal |
| Test Results for Channel 251/848.8 MHz | | | | | | | |
| 1697.6 | -51.53 | 2.80 | 27.42 | -26.91 | -13 | -13.91 | Vertical |
| 1697.6 | -47.21 | 2.80 | 27.42 | -22.59 | -13 | -9.59 | Horizontal |
| 2546.4 | -52.55 | 2.91 | 27.68 | -27.78 | -13 | -14.78 | Vertical |
| 2546.4 | -45.44 | 2.91 | 27.68 | -20.67 | -13 | -7.67 | Horizontal |
| 3395.2 | -47.03 | 4.02 | 29.80 | -21.25 | -13 | -8.25 | Vertical |
| 3395.2 | -45.00 | 4.02 | 29.80 | -19.22 | -13 | -6.22 | Horizontal |
| 198.1 | -48.81 | 1.46 | 17.68 | -32.59 | -13 | -19.59 | Vertical |
| 220.2 | -48.05 | 1.31 | 15.79 | -33.57 | -13 | -20.57 | Horizontal |

Remark:

1. We were tested all Configuration refer 3GPP TS134 121.
2. Absolute Level = SG Level- Cable Loss+ Antenna Gain
3. Over Limit= Absolute Level (dBm)-Limit(dBm)

| GSM 1900 | | | | | | | |
|--|----------|------------|----------------|----------------|-------|------------|------------|
| Frequency | SG Level | Cable Loss | Antenna Factor | Absolute Level | Limit | Over Limit | Polarity |
| (MHz) | (dBm) | (dB) | (dB) | (dBm) | (dBm) | (dBm) | |
| Test Results for Channel 512/1850.2MHz | | | | | | | |
| 3700.4 | -45.08 | 4.04 | 33.51 | -15.61 | -13 | -2.61 | Vertical |
| 3700.4 | -52.77 | 4.04 | 33.51 | -23.30 | -13 | -10.30 | Horizontal |
| 5550.6 | -52.14 | 5.24 | 35.84 | -21.54 | -13 | -8.54 | Vertical |
| 5550.6 | -47.12 | 5.24 | 35.84 | -16.52 | -13 | -3.52 | Horizontal |
| 105.3 | -50.44 | 1.40 | 15.14 | -36.70 | -13 | -23.70 | Vertical |
| 247.6 | -50.66 | 1.45 | 17.54 | -34.57 | -13 | -21.57 | Horizontal |
| Test Results for Channel 661/1880.0MHz | | | | | | | |
| 3760 | -47.01 | 4.04 | 33.56 | -17.49 | -13 | -4.49 | Vertical |
| 3760 | -48.28 | 4.04 | 33.56 | -18.76 | -13 | -5.76 | Horizontal |
| 5640 | -52.19 | 5.24 | 35.91 | -21.52 | -13 | -8.52 | Vertical |
| 5640 | -50.77 | 5.24 | 35.91 | -20.10 | -13 | -7.10 | Horizontal |
| 187.9 | -51.02 | 1.74 | 16.40 | -36.36 | -13 | -23.36 | Vertical |
| 86.7 | -48.62 | 1.42 | 15.72 | -34.31 | -13 | -21.31 | Horizontal |
| Test Results for Channel 810/1909.8MHz | | | | | | | |
| 3819.6 | -48.87 | 4.04 | 34.00 | -18.91 | -13 | -5.91 | Vertical |
| 3819.6 | -49.82 | 4.04 | 34.00 | -19.86 | -13 | -6.86 | Horizontal |
| 5729.4 | -51.89 | 5.24 | 36.04 | -21.09 | -13 | -8.09 | Vertical |
| 5729.4 | -46.89 | 5.24 | 36.04 | -16.09 | -13 | -3.09 | Horizontal |
| 217.3 | -48.85 | 1.67 | 17.51 | -33.01 | -13 | -20.01 | Vertical |
| 112.7 | -47.09 | 1.58 | 17.73 | -30.94 | -13 | -17.94 | Horizontal |

Remark:

1. We were tested all Configuration refer 3GPP TS134 121.
2. Absolute Level = SG Level- Cable Loss+ Antenna Gain
3. Over Limit= Absolute Level (dBm)-Limit(dBm)

| GPRS 1900 | | | | | | | |
|--|----------|------------|----------------|----------------|-------|------------|------------|
| Frequency | SG Level | Cable Loss | Antenna Factor | Absolute Level | Limit | Over Limit | Polarity |
| (MHz) | (dBm) | (dB) | (dB) | (dBm) | (dBm) | (dBm) | |
| Test Results for Channel 512/1850.2MHz | | | | | | | |
| 3700.4 | -52.40 | 4.04 | 33.51 | -22.93 | -13 | -9.93 | Vertical |
| 3700.4 | -51.78 | 4.04 | 33.51 | -22.31 | -13 | -9.31 | Horizontal |
| 5550.6 | -49.21 | 5.24 | 35.84 | -18.61 | -13 | -5.61 | Vertical |
| 5550.6 | -49.28 | 5.24 | 35.84 | -18.68 | -13 | -5.68 | Horizontal |
| 249.9 | -47.14 | 1.66 | 17.06 | -31.75 | -13 | -18.75 | Vertical |
| 237.9 | -52.03 | 1.34 | 15.54 | -37.83 | -13 | -24.83 | Horizontal |
| Test Results for Channel 661/1880.0MHz | | | | | | | |
| 3760 | -45.82 | 4.04 | 33.56 | -16.30 | -13 | -3.30 | Vertical |
| 3760 | -51.01 | 4.04 | 33.56 | -21.49 | -13 | -8.49 | Horizontal |
| 5640 | -49.38 | 5.24 | 35.91 | -18.71 | -13 | -5.71 | Vertical |
| 5640 | -44.88 | 5.24 | 35.91 | -14.21 | -13 | -1.21 | Horizontal |
| 168.5 | -53.30 | 1.33 | 16.18 | -38.45 | -13 | -25.45 | Vertical |
| 249.4 | -51.18 | 1.60 | 17.99 | -34.79 | -13 | -21.79 | Horizontal |
| Test Results for Channel 810/1909.8MHz | | | | | | | |
| 3819.6 | -50.16 | 4.04 | 34.00 | -20.20 | -13 | -7.20 | Vertical |
| 3819.6 | -48.21 | 4.04 | 34.00 | -18.25 | -13 | -5.25 | Horizontal |
| 5729.4 | -49.44 | 5.24 | 36.04 | -18.64 | -13 | -5.64 | Vertical |
| 5729.4 | -50.77 | 5.24 | 36.04 | -19.97 | -13 | -6.97 | Horizontal |
| 206.6 | -52.08 | 1.65 | 17.27 | -36.47 | -13 | -23.47 | Vertical |
| 227.8 | -50.97 | 1.39 | 15.49 | -36.88 | -13 | -23.88 | Horizontal |

Remark:

1. We were tested all Configuration refer 3GPP TS134 121.
2. Absolute Level = SG Level- Cable Loss+ Antenna Gain
3. Over Limit= Absolute Level (dBm)-Limit(dBm)

| WCDMA Band II | | | | | | | |
|---|----------|------------|----------------|----------------|-------|------------|------------|
| Frequency | SG Level | Cable Loss | Antenna Factor | Absolute Level | Limit | Over Limit | Polarity |
| (MHz) | (dBm) | (dB) | (dB) | (dBm) | (dBm) | (dBm) | |
| Test Results for Channel 9262/1852.4MHz | | | | | | | |
| 3704.8 | -45.02 | 4.04 | 33.51 | -15.55 | -13 | -2.55 | Vertical |
| 3704.8 | -47.41 | 4.04 | 33.51 | -17.94 | -13 | -4.94 | Horizontal |
| 5557.2 | -50.52 | 5.24 | 35.84 | -19.92 | -13 | -6.92 | Vertical |
| 5557.2 | -49.35 | 5.24 | 35.84 | -18.75 | -13 | -5.75 | Horizontal |
| 91.6 | -46.9 | 1.66 | 17.47 | -31.09 | -13 | -18.09 | Vertical |
| 104.4 | -47.02 | 1.38 | 16.18 | -32.22 | -13 | -19.22 | Horizontal |
| Test Results for Channel 9400/1880MHz | | | | | | | |
| 3760 | -47.32 | 4.04 | 33.56 | -17.80 | -13 | -4.80 | Vertical |
| 3760 | -47.34 | 4.04 | 33.56 | -17.82 | -13 | -4.82 | Horizontal |
| 5640 | -44.62 | 5.24 | 35.91 | -13.95 | -13 | -0.95 | Vertical |
| 5640 | -48.93 | 5.24 | 35.91 | -18.26 | -13 | -5.26 | Horizontal |
| 121.2 | -45.37 | 1.38 | 16.34 | -30.41 | -13 | -17.41 | Vertical |
| 167.8 | -44.31 | 1.34 | 16.03 | -29.62 | -13 | -16.62 | Horizontal |
| Test Results for Channel 9538/1907.6MHz | | | | | | | |
| 3815.2 | -47.4 | 4.04 | 34.00 | -17.44 | -13 | -4.44 | Vertical |
| 3815.2 | -46.66 | 4.04 | 34.00 | -16.70 | -13 | -3.70 | Horizontal |
| 5722.8 | -45.45 | 5.24 | 36.04 | -14.65 | -13 | -1.65 | Vertical |
| 5722.8 | -47.91 | 5.24 | 36.04 | -17.11 | -13 | -4.11 | Horizontal |
| 135.9 | -44.07 | 1.51 | 15.52 | -30.06 | -13 | -17.06 | Vertical |
| 247.5 | -49.21 | 1.32 | 17.18 | -33.36 | -13 | -20.36 | Horizontal |

Remark:

1. We were tested all Configuration refer 3GPP TS134 121.
2. Absolute Level = SG Level- Cable Loss+ Antenna Gain
3. Over Limit= Absolute Level (dBm)-Limit(dBm)

| WCDMA Band V | | | | | | | |
|--|----------|------------|--------------|----------------|-------|------------|------------|
| Frequency | SG Level | Cable Loss | Antenna Gain | Absolute Level | Limit | Over Limit | Polarity |
| (MHz) | (dBm) | (dB) | (dB) | (dBm) | (dBm) | (dBm) | |
| Test Results for Channel 4233/846.6MHz | | | | | | | |
| 1693.2 | -48.81 | 2.80 | 27.50 | -24.11 | -13 | -11.11 | Vertical |
| 1693.2 | -49.84 | 2.80 | 27.50 | -25.14 | -13 | -12.14 | Horizontal |
| 2539.8 | -49.65 | 2.91 | 27.80 | -24.76 | -13 | -11.76 | Vertical |
| 2539.8 | -52.42 | 2.91 | 27.80 | -27.53 | -13 | -14.53 | Horizontal |
| 3386.4 | -46.14 | 4.02 | 29.87 | -20.29 | -13 | -7.29 | Vertical |
| 3386.4 | -48.72 | 4.02 | 29.87 | -22.87 | -13 | -9.87 | Horizontal |
| 264.3 | -53.86 | 1.75 | 15.49 | -40.12 | -13 | -27.12 | Vertical |
| 209.9 | -47.89 | 1.37 | 16.58 | -32.68 | -13 | -19.68 | Horizontal |
| Test Results for Channel 4182/836.4MHz | | | | | | | |
| 1672.8 | -45.82 | 2.80 | 27.48 | -21.14 | -13 | -8.14 | Vertical |
| 1672.8 | -51.46 | 2.80 | 27.48 | -26.78 | -13 | -13.78 | Horizontal |
| 2509.2 | -44.85 | 2.91 | 27.70 | -20.06 | -13 | -7.06 | Vertical |
| 2509.2 | -53.67 | 2.91 | 27.70 | -28.88 | -13 | -15.88 | Horizontal |
| 3345.6 | -44.44 | 4.02 | 29.82 | -18.64 | -13 | -5.64 | Vertical |
| 3345.6 | -46.11 | 4.02 | 29.82 | -20.31 | -13 | -7.31 | Horizontal |
| 255.8 | -52.48 | 1.68 | 17.84 | -36.32 | -13 | -23.32 | Vertical |
| 129.8 | -47.11 | 1.49 | 16.34 | -32.25 | -13 | -19.25 | Horizontal |
| Test Results for Channel 4132/826.4MHz | | | | | | | |
| 1652.8 | -53.87 | 2.80 | 27.42 | -29.25 | -13 | -16.25 | Vertical |
| 1652.8 | -48.38 | 2.80 | 27.42 | -23.76 | -13 | -10.76 | Horizontal |
| 2479.2 | -49.86 | 2.91 | 27.68 | -25.09 | -13 | -12.09 | Vertical |
| 2479.2 | -45.17 | 2.91 | 27.68 | -20.40 | -13 | -7.40 | Horizontal |
| 3305.6 | -48.67 | 4.02 | 29.80 | -22.89 | -13 | -9.89 | Vertical |
| 3305.6 | -49.66 | 4.02 | 29.80 | -23.88 | -13 | -10.88 | Horizontal |
| 135.6 | -50.42 | 1.36 | 17.52 | -34.26 | -13 | -21.26 | Vertical |
| 190.6 | -45.39 | 1.63 | 15.02 | -32.00 | -13 | -19.00 | Horizontal |

Remark:

1. We were tested all Configuration refer 3GPP TS134 121.
2. Absolute Level = SG Level- Cable Loss+ Antenna Gain
3. Over Limit= Absolute Level (dBm)-Limit(dBm)

7.2 EFFECTIVE RADIATED POWER AND EFFECTIVE ISOTROPIC RADIATED POWER

7.2.1 Applicable Standard

According to FCC KDB 971168 D01 v03r01 Section 5.2.1/ Section 5.2.2.2 and ANSI/TIA-603-E-2016 Section 2.2.17

7.2.2 Conformance Limit

The substitution method, in ANSI/TIA-603-E-2016, was used for ERP/EIRP measurement, and the spectrum analyzer configuration follows KDB 971168 D01 Power Meas. License Digital Systems v03r01. The ERP of mobile transmitters must not exceed 7 Watts (Cellular Band) and the EIRP of mobile transmitters are limited to 2 Watts (PCS Band).

7.2.3 Measuring Instruments

The Measuring equipment is listed in the section 6.3 of this test report.

7.2.4 Test Configuration

Please refer to Section 7.1.4 of this test report.

7.2.5 Test Procedure

The measurements procedures specified in ANSI/TIA-603-E-2016 were applied.

In an anechoic antenna test chamber, a half-wave dipole antenna for the frequency band of interest is placed at the reference centre of the chamber. An RF Signal source for the frequency band of interest is connected to the dipole with a cable that has been constructed to not interfere with the radiation pattern of the antenna. A known (measured) power (P_{in}) is applied to the input of the dipole, and the power received (P_r) at the chamber's probe antenna is recorded.

The relevant equation for determining the ERP or EIRP from the conducted RF output power measured using the guidance provided above is:

$$ERP/EIRP = SGLevel - P_{cl} + G_a$$

where:

ERP/EIRP = effective or equivalent radiated power, respectively (expressed in the same units as SGLevel, typically dBW or dBm);

SGLevel = Signal generator output power or PSD, in dBm or dBW;

G_a = gain of the transmitting antenna, in dBd (ERP) or dBi (EIRP);

P_{cl} = signal attenuation in the connecting cable between the transmitter and antenna, in dB.²

The EUT is substituted for the dipole at the reference centre of the chamber and a scan is performed to obtain the radiation pattern.

From the radiation pattern, the co-ordinates where the maximum antenna gain occurs are identified.

The EUT is then put into continuously transmitting mode at its maximum power level.

Power mode measurements are performed with the receiving antenna placed at the coordinates determined in Step 3 to determine the output power as defined in Rule 24.232 (b) and (c). The "reference path loss" from Step1 is added to this result.

This value is EIRP since the measurement is calibrated using a half-wave dipole antenna of known gain (2.15 dBi) and known input power (Pin).

ERP can be calculated from EIRP by subtracting the gain of the dipole, $ERP = EIRP - 2.15\text{dBi}$.

Both horizontal and vertical antenna polarities were tested and performed pretest to three orthogonal axis. The worst case emissions were reported.

Substitution antenna and Receiving Antenna:

| Item | Kind of Equipment | Manufacturer | Type No. | Serial No. | Character | Note |
|------|-------------------|--------------|-------------|------------|------------|----------------------|
| 1 | Bilog Antenna | TESEQ | CBL6111D | 31216 | 30MHz~2GHz | Receiving Antenna |
| 2 | Horn Antenna | EM | EM-AH-10180 | 2011071402 | 1GHz~18GHz | Receiving Antenna |
| 3 | Bilog Antenna | TESEQ | CBL6111D | 31216 | 30MHz~2GHz | Substitution antenna |
| 4 | Horn Antenna | EM | EM-AH-10180 | 2011071402 | 1GHz~18GHz | Substitution antenna |

Use the following spectrum analyzer settings:

| | GSM/GPRS/EGPRS | UMTS band |
|--------------|----------------|-----------|
| Span | 500KHz | 10MHz |
| RBW | 10KHz | 300KHz |
| VBW | 30KHz | 1MHz |
| Detector | RMS | RMS |
| Trace | Average | Average |
| Average Type | Power | Power |
| Sweep Count | 100 | 100 |

7.2.6 Test Results

| | | | |
|--------------|---|--------------------|--------------|
| EUT: | Mobile phone | Model No.: | A4 GO |
| Temperature: | 20 °C | Relative Humidity: | 48% |
| Test Mode: | GSM/GPRS 850/ GSM/GPRS 1900 UMTS band II/ UMTS band V | Test By: | Cheng Jiawen |

■ Effective Radiated Power

| Radiated Power (ERP) for GSM850 | | | | | | | |
|---------------------------------|--------------|-------|------|---------|------------|-------|----------|
| Frequency | Polarization | SG | Pcl | Ga | Correction | ERP | ERP |
| (MHz) | | Level | (dB) | Antenna | | (dBm) | (W) |
| | | (dBm) | (dB) | Gain | (dB) | (dBm) | (W) |
| 824.2 | H | 10.66 | 2.11 | 23.84 | 2.15 | 30.24 | 1.056818 |
| 836.6 | H | 11.16 | 2.13 | 23.15 | 2.15 | 30.03 | 1.006932 |
| 848.8 | H | 10.88 | 2.13 | 23.06 | 2.15 | 29.66 | 0.924698 |
| 824.2 | V | 9.40 | 2.11 | 23.11 | 2.15 | 28.25 | 0.668344 |
| 836.6 | V | 10.91 | 2.13 | 23.07 | 2.15 | 29.70 | 0.933254 |
| 848.8 | V | 10.73 | 2.13 | 23.25 | 2.15 | 29.70 | 0.933254 |

| Radiated Power (ERP) for GPRS850 | | | | | | | |
|----------------------------------|--------------|-------|------|---------|------------|-------|----------|
| Frequency | Polarization | SG | Pcl | Ga | Correction | ERP | ERP |
| (MHz) | | Level | (dB) | Antenna | | (dBm) | (W) |
| | | (dBm) | (dB) | Gain | (dB) | (dBm) | (W) |
| 824.2 | H | 10.31 | 2.11 | 23.84 | 2.15 | 29.89 | 0.974990 |
| 836.6 | H | 11.13 | 2.13 | 23.15 | 2.15 | 30.00 | 1.000000 |
| 848.8 | H | 10.94 | 2.13 | 23.06 | 2.15 | 29.72 | 0.937562 |
| 824.2 | V | 10.38 | 2.11 | 23.11 | 2.15 | 29.23 | 0.837529 |
| 836.6 | V | 10.11 | 2.13 | 23.07 | 2.15 | 28.90 | 0.776247 |
| 848.8 | V | 10.44 | 2.13 | 23.25 | 2.15 | 29.41 | 0.872971 |

| Radiated Power (ERP) for UMTS band V | | | | | | | |
|--------------------------------------|--------------|-------|------|---------|------------|-------|----------|
| Frequency | Polarization | SG | Pcl | Ga | Correction | ERP | ERP |
| (MHz) | | Level | (dB) | Antenna | | (dBm) | (W) |
| | | (dBm) | (dB) | Gain | (dB) | (dBm) | (W) |
| 826.4 | H | 0.73 | 2.11 | 23.84 | 2.15 | 20.31 | 0.107399 |
| 835 | H | 0.81 | 2.13 | 23.15 | 2.15 | 19.68 | 0.092897 |
| 846.6 | H | 1.68 | 2.13 | 23.06 | 2.15 | 20.46 | 0.111173 |
| 826.4 | V | -0.08 | 2.11 | 23.11 | 2.15 | 18.77 | 0.075336 |
| 835 | V | -0.74 | 2.13 | 23.07 | 2.15 | 18.05 | 0.063826 |
| 846.6 | V | -0.84 | 2.13 | 23.25 | 2.15 | 18.13 | 0.065013 |

Note:

SG Level= Signal generator output

Pcl= cable loss

Ga= Antenna Gain

Peak EIRP(dBm)= SGLevel -Pcl +Ga

ERP(dBm)=EIRP-2.15

■ Effective Isotropic Radiated Power

| Radiated Power (E.I.R.P) for GSM1900 | | | | | | |
|--------------------------------------|--------------|----------|------|-----------------|-------|----------|
| Frequency | Polarization | SG Level | Pcl | Ga Antenna Gain | EIRP | EIRP |
| (MHz) | | (dBm) | (dB) | (dB) | (dBm) | (W) |
| 1850.2 | H | 2.56 | 3.76 | 28.24 | 27.04 | 0.505825 |
| 1880 | H | 3.00 | 3.91 | 28.22 | 27.31 | 0.538270 |
| 1909.8 | H | 3.01 | 3.93 | 28.20 | 27.28 | 0.534564 |
| 1850.2 | V | 2.39 | 3.76 | 27.32 | 25.95 | 0.393550 |
| 1880 | V | 3.12 | 3.91 | 27.33 | 26.54 | 0.450817 |
| 1909.8 | V | 3.36 | 3.93 | 27.31 | 26.74 | 0.472063 |

| Radiated Power (E.I.R.P) for GPRS1900 | | | | | | |
|---------------------------------------|--------------|----------|------|-----------------|-------|----------|
| Frequency | Polarization | SG Level | Pcl | Ga Antenna Gain | EIRP | EIRP |
| (MHz) | | (dBm) | (dB) | (dB) | (dBm) | (W) |
| 1850.2 | H | 2.43 | 3.76 | 28.24 | 26.91 | 0.490908 |
| 1880 | H | 2.87 | 3.91 | 28.22 | 27.18 | 0.522396 |
| 1909.8 | H | 2.89 | 3.93 | 28.20 | 27.16 | 0.519996 |
| 1850.2 | V | 2.63 | 3.76 | 27.32 | 26.19 | 0.415911 |
| 1880 | V | 3.12 | 3.91 | 27.33 | 26.54 | 0.450817 |
| 1909.8 | V | 3.19 | 3.93 | 27.31 | 26.57 | 0.453942 |

| Radiated Power (E.I.R.P) for UMTS band II | | | | | | |
|---|--------------|----------|------|-----------------|-------|----------|
| Frequency | Polarization | SG Level | Pcl | Ga Antenna Gain | EIRP | EIRP |
| (MHz) | | (dBm) | (dB) | (dB) | (dBm) | (W) |
| 1852.4 | H | -3.86 | 3.76 | 28.24 | 20.62 | 0.115345 |
| 1880 | H | -2.90 | 3.91 | 28.22 | 21.41 | 0.138357 |
| 1907.6 | H | -3.15 | 3.93 | 28.20 | 21.12 | 0.129420 |
| 1852.4 | V | -3.63 | 3.76 | 27.32 | 19.93 | 0.098401 |
| 1880 | V | -2.84 | 3.91 | 27.33 | 20.58 | 0.114288 |
| 1907.6 | V | -3.14 | 3.93 | 27.31 | 20.24 | 0.105682 |

Note:

SG Level= Signal generator output

Pcl= cable loss

Ga= Antenna Gain

Peak EIRP(dBm)= SGLevel -Pcl+Ga.

7.3 CONDUCTED OUTPUT POWER

7.3.1 Applicable Standard

According to FCC Part 2.1046 and FCC Part 22.913(a)(2) and FCC Part 24.232(c) and FCC KDB 971168 D01 v03r01 Section 5.2

7.3.2 Conformance Limit

Extend coverage on a secondary basis into cellular unserved areas, as those areas are defined in §22.949, the ERP of base transmitters and cellular repeaters of such systems must not exceed 1000 Watts. The ERP of mobile transmitters and auxiliary test transmitters must not exceed 7 Watts(38.5dBm).

Mobile and portable stations are limited to 2 watts (33dBm)EIRP and the equipment must employ a means for limiting power to the minimum necessary for successful communications..

7.3.3 Measuring Instruments

The Measuring equipment is listed in the section 6.3 of this test report.

7.3.4 Test Setup

Please refer to Section 6.1 of this test report.

7.3.5 Test Procedure

Connect the EUT to Universal Radio Communication Tester CMU200 or CMU500 via the antenna connector. A call is set up by the SS according to the generic call set up procedure on a channel with ARFCN in the ARFCN range, power control level set to Max power. The frequency band is set as selected frequency, The RF output of the transmitter was connected to base station simulator.

Set EUT at maximum average power by base station simulator.

Set RBW = 1-5% of the OBW, not to exceed 1 MHz.

Set VBW $\geq 3 \times$ RBW.

Number of points in sweep $\geq 2 \times$ span / RBW. (This gives bin-to-bin spacing \leq RBW/2, so that narrowband signals are not lost between frequency bins.)

Sweep time = auto.

Detector = RMS (power averaging).

Set sweep trigger to "free run".

Trace average at least 100 traces in power averaging (i.e., RMS) mode; however, the number of traces to be averaged shall be increased above 100 as needed such that the average accurately represents the true average over the on and off periods of the transmitter.

Compute power by integrating the spectrum across the OBW of the signal using the instrument's band power measurement function with band limits set equal to the OBW band edges. If the instrument does not have a band power function, sum the spectrum levels (in power units) at intervals equal to the RBW extending across the entire OBW of the spectrum.

Add $10 \log(1/x)$, where x is the duty cycle, to the measured power in order to compute the average power during the actual transmission times (because the measurement represents an average over both the on and off times of the transmission). For example, add $10 \log(1/0.25) = 6$ dB if the duty cycle is a constant 25%.

Measure lowest, middle, and highest channels for each bandwidth and different modulation.

Measure and record the results in the test report.

7.3.6 Test Results

| | | | |
|--------------|---|--------------------|--------------|
| EUT: | Mobile phone | Model No.: | A4 GO |
| Temperature: | 20 °C | Relative Humidity: | 48% |
| Test Mode: | GSM/GPRS 850/ GSM/GPRS 1900 UMTS band II/ UMTS band V | Test By: | Cheng Jiawen |

Test data reference attachment

7.4 FREQUENCY STABILITY

7.4.1 Applicable Standard

According to FCC Part 2.1055 and FCC Part 22.355 and FCC Part 24.235 and FCC KDB 971168 D01 Section 9.0

7.4.2 Conformance Limit

The frequency stability shall be measured by variation of ambient temperature and variation of primary supply voltage to ensure that the fundamental emission stays within the authorized frequency block. The frequency stability of the transmitter shall be maintained within $\pm 0.00025\%$ ($\pm 2.5\text{ppm}$) of the center frequency.

7.4.3 Measuring Instruments

The Measuring equipment is listed in the section 6.3 of this test report.

7.4.4 Test Setup

Please refer to Section 6.1 of this test report.

7.4.5 Test Procedure

Connect the EUT to Universal Radio Communication Tester CMU200 or CMU500 via the antenna connector. A call is set up by the SS according to the generic call set up procedure on a channel with ARFCN in the ARFCN range, power control level set to Max power. MS TXPWR_MAX_CCH is set to the maximum value supported by the Power Class of the Mobile under test.

EUT was placed at temperature chamber and connected to an external power supply.

Temperature and voltage condition shall be tested to confirm frequency stability.

For Temperature Variation

1. The testing follows FCC KDB 971168 D01 v03r01 Section 9.0.
2. The EUT was set up in the thermal chamber and connected with the system simulator.
3. With power OFF, the temperature was decreased to -30°C and the EUT was stabilized before testing. Power was applied and the maximum change in frequency was recorded within one minute.
4. With power OFF, the temperature was raised in 10°C steps up to 50°C . The EUT was stabilized at each step for at least half an hour. Power was applied and the maximum frequency change was recorded within one minute.

For Voltage Variation

1. The testing follows FCC KDB 971168 D01 v03r01 Section 9.0.
2. The EUT was placed in a temperature chamber at $25\pm 5^{\circ}\text{C}$ and connected with the system simulator.
3. The power supply voltage to the EUT was varied from 85% to 115% of the nominal value measured at the input to the EUT.
4. The variation in frequency was measured for the worst case.

7.4.6 Test Results

| | | | |
|---------------|---|--------------------|--------------|
| EUT: | Mobile phone | Model No.: | A4 GO |
| Temperature: | 20 °C | Relative Humidity: | 48% |
| Test Mode: | GSM/GPRS 850/ GSM/GPRS 1900 UMTS band II/ UMTS band V | Test By: | Cheng Jiawen |
| Results: PASS | | | |

| Frequency Error Against Voltage for GSM 850 band Mid CH | | |
|---|----------------------|-----------------------|
| Voltage (V) | Frequency Error (Hz) | Frequency Error (ppm) |
| 3.4 | 8.63 | 0.010318 |
| 3.7 | 8.45 | 0.010103 |
| 4.2 | 6.05 | 0.007233 |

| Frequency Error Against Temperature for GSM 850 band Mid CH | | |
|---|----------------------|-----------------------|
| Temperature (°C) | Frequency Error (Hz) | Frequency Error (ppm) |
| -30 | 7.03 | 0.008405 |
| -20 | 6.92 | 0.008274 |
| -10 | 8.63 | 0.010318 |
| 0 | 6.15 | 0.007353 |
| 10 | 7.71 | 0.009218 |
| 20 | 9.06 | 0.010832 |
| 30 | 8.63 | 0.010318 |
| 40 | 8.11 | 0.009696 |
| 50 | 12.22 | 0.014610 |

| Frequency Error Against Voltage for GPRS850 band Mid CH | | |
|---|----------------------|-----------------------|
| Voltage (V) | Frequency Error (Hz) | Frequency Error (ppm) |
| 3.4 | 7.24 | 0.008656 |
| 3.7 | 10 | 0.011956 |
| 4.2 | 9.15 | 0.010940 |

| Frequency Error Against Temperature for GPRS850 band Mid CH | | |
|---|----------------------|-----------------------|
| Temperature (°C) | Frequency Error (Hz) | Frequency Error (ppm) |
| -30 | 8.71 | 0.010414 |
| -20 | 7.66 | 0.009158 |
| -10 | 7.33 | 0.008764 |
| 0 | 6.18 | 0.007389 |
| 10 | 7.46 | 0.008919 |
| 20 | 8.01 | 0.009577 |
| 30 | 7.6 | 0.009087 |
| 40 | 9.93 | 0.011872 |
| 50 | 13.33 | 0.015937 |

Note:

1. Normal Voltage = 3.7V; Battery End Point (BEP) = 3.4V; Maximum Voltage = 4.2V
2. The frequency fundamental emissions stay within the authorized frequency block based on the frequency deviation measured is small.

| Frequency Error Against Voltage for PCS 1900 band Mid CH | | |
|--|----------------------|-----------------------|
| Voltage (V) | Frequency Error (Hz) | Frequency Error (ppm) |
| 3.4 | 17.55 | 0.009335 |
| 3.7 | 18.9 | 0.010053 |
| 4.2 | 18.95 | 0.010080 |

| Frequency Error Against Temperature for PCS 1900 band Mid CH | | |
|--|----------------------|-----------------------|
| Temperature (°C) | Frequency Error (Hz) | Frequency Error (ppm) |
| -30 | 17.85 | 0.009495 |
| -20 | 16.44 | 0.008745 |
| -10 | 18.34 | 0.009755 |
| 0 | 17.11 | 0.009101 |
| 10 | 19.54 | 0.010394 |
| 20 | 16.21 | 0.008622 |
| 30 | 18.55 | 0.009867 |
| 40 | 18.22 | 0.009691 |
| 50 | 20.95 | 0.011144 |

| Frequency Error Against Voltage for GPRS1900 band Mid CH | | |
|--|----------------------|-----------------------|
| Voltage (V) | Frequency Error (Hz) | Frequency Error (ppm) |
| 3.4 | 16.48 | 0.008766 |
| 3.7 | 20.62 | 0.010968 |
| 4.2 | 16.36 | 0.008702 |

| Frequency Error Against Temperature for GPRS1900 band Mid CH | | |
|--|----------------------|-----------------------|
| Temperature (°C) | Frequency Error (Hz) | Frequency Error (ppm) |
| -30 | 20.38 | 0.010840 |
| -20 | 18.25 | 0.009707 |
| -10 | 19.41 | 0.010324 |
| 0 | 16.82 | 0.008947 |
| 10 | 16.09 | 0.008559 |
| 20 | 17.92 | 0.009532 |
| 30 | 18.24 | 0.009702 |
| 40 | 19.14 | 0.010181 |
| 50 | 19.49 | 0.010367 |

Note:

1. Normal Voltage = 3.7V; Battery End Point (BEP) = 3.4V; Maximum Voltage = 4.2V
2. The frequency fundamental emissions stay within the authorized frequency block based on the frequency deviation measured is small.

| Frequency Error Against Voltage for UMTS band II Mid CH | | |
|---|----------------------|-----------------------|
| Voltage (V) | Frequency Error (Hz) | Frequency Error (ppm) |
| 3.4 | -17.04 | -0.009064 |
| 3.7 | -16.36 | -0.008702 |
| 4.2 | -18.16 | -0.009660 |

| Frequency Error Against Temperature for UMTS band II Mid CH | | |
|---|----------------------|-----------------------|
| Temperature (°C) | Frequency Error (Hz) | Frequency Error (ppm) |
| -30 | -15.46 | -0.008223 |
| -20 | -18.62 | -0.009904 |
| -10 | -19.25 | -0.010239 |
| 0 | -18.99 | -0.010101 |
| 10 | -15.66 | -0.008330 |
| 20 | -19.59 | -0.010420 |
| 30 | -19.37 | -0.010303 |
| 40 | -15.46 | -0.008223 |
| 50 | -21.18 | -0.011266 |

| Frequency Error Against Voltage for UMTS band V Mid CH | | |
|--|----------------------|-----------------------|
| Voltage (V) | Frequency Error (Hz) | Frequency Error (ppm) |
| 3.4 | -16.18 | -0.019345 |
| 3.8 | -18.3 | -0.021879 |
| 4.2 | -15.69 | -0.018759 |

| Frequency Error Against Temperature for UMTS band V Mid CH | | |
|--|----------------------|-----------------------|
| Temperature (°C) | Frequency Error (Hz) | Frequency Error (ppm) |
| -30 | -17.69 | -0.021150 |
| -20 | -19.46 | -0.023266 |
| -10 | -16.52 | -0.019751 |
| 0 | -16.43 | -0.019644 |
| 10 | -18.27 | -0.021844 |
| 20 | -15.26 | -0.018245 |
| 30 | -15.19 | -0.018161 |
| 40 | -16.23 | -0.019405 |
| 50 | -24.25 | -0.028993 |

Note:

1. Normal Voltage = 3.7V; Battery End Point (BEP) = 3.4V; Maximum Voltage = 4.2V
2. The frequency fundamental emissions stay within the authorized frequency block based on the frequency deviation measured is small.

7.5 PEAK-TO-AVERAGE RATIO

7.5.1 Applicable Standard

According to FCC 22.913 and FCC 24.232(d) and FCC KDB 971168 D01 Section 5.7.1

7.5.2 Conformance Limit

The peak-to-average power ratio (PAPR) of the transmitter output power must not exceed 13 dB. The PAPR measurements should be made using either an instrument with complementary cumulative distribution function (CCDF) capabilities to determine that PAPR will not exceed 13 dB for more than 0.1 percent of the time or other Commission approved procedure. The measurement must be performed using a signal corresponding to the highest PAPR expected during periods of continuous transmission.

7.5.3 Measuring Instruments

The Measuring equipment is listed in the section 6.3 of this test report.

7.5.4 Test Setup

Please refer to Section 6.1 of this test report.

7.5.5 Test Procedure

The EUT was connected to Spectrum Analyzer and Base Station via power divider.
 The RF output of EUT was connected to the spectrum analyzer by RF cable and attenuator. The path loss was compensated to the results for each measurement.
 Set the number of counts to a value that stabilizes the measured CCDF curve.
 Set the measurement interval to 1 ms.
 Record the maximum PAPR level associated with a probability of 0.1%.
 a) Refer to instrument's analyzer instruction manual for details on how to use the power statistics/CCDF function;
 b) Set resolution/measurement bandwidth \geq signal's occupied bandwidth;
 c) Set the number of counts to a value that stabilizes the measured CCDF curve;
 d) Set the measurement interval as follows:
 1) for continuous transmissions, set to 1 ms,
 2) for burst transmissions, employ an external trigger that is synchronized with the EUT burst timing sequence, or use the internal burst trigger with a trigger level that allows the burst to stabilize and set the measurement interval to a time that is less than or equal to the burst duration.
 e) Record the maximum PAPR level associated with a probability of 0.1%.

7.5.6 Test Results

| | | | |
|---------------|--|--------------------|--------------|
| EUT: | Mobile phone | Model No.: | A4 GO |
| Temperature: | 20 °C | Relative Humidity: | 48% |
| Test Mode: | GSM/GPRS 850/ GSM/GPRS 1900 /UMTS band II/ UMTS band V | Test By: | Cheng Jiawen |
| Results: PASS | | | |

Test data reference attachment

7.6 26DB BANDWIDTH AND 99% OCCUPIED BANDWIDTH

7.6.1 Applicable Standard

According to FCC Part 2.1049 and FCC Part 22H and FCC Part 24E and FCC KDB 971168 D01 Section 4.0

7.6.2 Conformance Limit

The occupied bandwidth is the width of a frequency band such that, below the lower and above the upper frequency limits, the mean powers emitted are each equal to a specified percentage 0.5% of the total mean transmitted power.

The 26 dB emission bandwidth is defined as the frequency range between two points, one above and one below the carrier frequency, at which the spectral density of the emission is attenuated 26 dB below the maximum in-band spectral density of the modulated signal. Spectral density (power per unit bandwidth) is to be measured with a detector of resolution bandwidth equal to approximately 1.0% of the emission bandwidth.

7.6.3 Measuring Instruments

The Measuring equipment is listed in the section 6.3 of this test report.

7.6.4 Test Setup

Please refer to Section 6.1 of this test report.

7.6.5 Test Procedure

The testing follows FCC KDB 971168 v03r01 Section 4.0.

The EUT was connected to Spectrum Analyzer and Base Station via power divider.

The RF output of EUT was connected to the spectrum analyzer by RF cable and attenuator. The path loss was compensated to the results for each measurement.

The spectrum analyzer center frequency is set to the nominal EUT channel center frequency. The span range for the spectrum analyzer shall be between two and five times the anticipated OBW.

The nominal resolution bandwidth (RBW) shall be in the range of 1 to 5 % of the anticipated OBW, and the VBW shall be at least 3 times the RBW.

Set the detection mode to peak, and the trace mode to max hold.

Determine the reference value: Set the EUT to transmit a modulated signal. Allow the trace to stabilize. Set the spectrum analyzer marker to the highest level of the displayed trace.

(this is the reference value)

Determine the “-26 dB down amplitude” as equal to (Reference Value – X).

Place two markers, one at the lowest and the other at the highest frequency of the envelope of the spectral display such that each marker is at or slightly below the “-X dB down amplitude” determined in step 6. If a marker is below this “-X dB down amplitude” value it shall be placed as close as possible to this value. The OBW is the positive frequency difference between the two markers.

Use the 99 % power bandwidth function of the spectrum analyzer and report the measured bandwidth.

7.6.6 Test Results

| | | | |
|---------------|--|--------------------|--------------|
| EUT: | Mobile phone | Model No.: | A4 GO |
| Temperature: | 20 °C | Relative Humidity: | 48% |
| Test Mode: | GSM/GPRS 850/ GSM/GPRS 1900 /UMTS band II/ UMTS band V | Test By: | Cheng Jiawen |
| Results: PASS | | | |

Test data reference attachment

7.7 CONDUCTED BAND EDGE

7.7.1 Applicable Standard

According to FCC Part 2.1051 and FCC Part 22.917(a) and 24.238(a) and FCC KDB 971168 D01 Section 6.0

7.7.2 Conformance Limit

The power of any emission outside of the authorized operating frequency ranges must be lower than the transmitter power (P) by a factor of at least $43 + 10 \log(P)$ dB.

7.7.3 Measuring Instruments

The Measuring equipment is listed in the section 6.3 of this test report.

7.7.4 Test Setup

Please refer to Section 6.1 of this test report.

7.7.5 Test Procedure

The testing follows FCC KDB 971168 v03r01 Section 6.0.

The EUT was connected to Spectrum Analyzer and Base Station via power divider.

The RF output of EUT was connected to the spectrum analyzer by RF cable and attenuator.

The path loss was compensated to the results for each measurement.

The band edges of low and high channels for the highest RF powers were measured.

The RF fundamental frequency should be excluded against the limit line in the operating frequency band.

The limit line is derived from $43 + 10\log(P)$ dB below the transmitter power P(Watts)

$$= P(W) - [43 + 10\log(P)] \text{ (dB)}$$

$$= [30 + 10\log(P)] \text{ (dBm)} - [43 + 10\log(P)] \text{ (dB)}$$

$$= -13\text{dBm}$$

7.7.6 Test Results

| | | | |
|---------------|--|--------------------|--------------|
| EUT: | Mobile phone | Model No.: | A4 GO |
| Temperature: | 20 °C | Relative Humidity: | 48% |
| Test Mode: | GSM/GPRS 850/ GSM/GPRS 1900/ UMTS band II/ UMTS band V | Test By: | Cheng Jiawen |
| Results: PASS | | | |

Test data reference attachment

7.8 CONDUCTED SPURIOUS EMISSION AT ANTENNA TERMINAL

7.8.1 Applicable Standard

According to FCC Part 2.1051 and FCC Part 22.917(a) and Part 24.238(a) and FCC KDB 971168 D01 Section6.0

7.8.2 Conformance Limit

The power of any emission outside of the authorized operating frequency ranges must be lower than the transmitter power (P) by a factor of at least $43 + 10 \log(P)$ dB.
It is measured by means of a calibrated spectrum analyzer and scanned from 30 MHz up to a frequency including its 10th harmonic.

7.8.3 Measuring Instruments

The Measuring equipment is listed in the section 6.3 of this test report.

7.8.4 Test Setup

Please refer to Section 6.1 of this test report.

7.8.5 Test Procedure

The testing follows FCC KDB 971168 v03r01 Section 6.0.
The EUT was connected to Spectrum Analyzer and Base Station via power divider.
The RF output of EUT was connected to the spectrum analyzer by RF cable and attenuator.
The path loss was compensated to the results for each measurement.
The middle channel for the highest RF power within the transmitting frequency was measured.
The conducted spurious emission for the whole frequency range was taken.
The RF fundamental frequency should be excluded against the limit line in the operating frequency band.
The limit line is derived from $43 + 10\log(P)$ dB below the transmitter power P(Watts)
 $= P(W) - [43 + 10\log(P)]$ (dB)
 $= [30 + 10\log(P)]$ (dBm) - $[43 + 10\log(P)]$ (dB)
 $= -13\text{dBm}$.

7.8.6 Test Results

| | | | |
|---------------|--|--------------------|--------------|
| EUT: | Mobile phone | Model No.: | A4 GO |
| Temperature: | 20 °C | Relative Humidity: | 48% |
| Test Mode: | GSM/GPRS 850/ GSM/GPRS 1900/ UMTS band II/ UMTS band V | Test By: | Cheng Jiawen |
| Results: PASS | | | |

Test data reference attachment

8 TEST RESULTS

8.1 CONDUCTED OUTPUT POWER

| Band | Channel | Frequency (MHz) | Power (dBm) | high Limit (dBm) | Verdict |
|----------------------|---------|-----------------|-------------|------------------|---------|
| GSM850 | 128 | 824.2 | 32.24 | 37 | PASS |
| GSM850 | 189 | 836.4 | 32.03 | 37 | PASS |
| GSM850 | 251 | 848.8 | 31.66 | 37 | PASS |
| GSM1900 | 512 | 1850.2 | 28.24 | 37 | PASS |
| GSM1900 | 661 | 1880 | 28.51 | 37 | PASS |
| GSM1900 | 810 | 1909.8 | 28.48 | 37 | PASS |
| GPRS850 1 Slot | 128 | 824.2 | 31.89 | 37 | PASS |
| GPRS850 1 Slot | 189 | 836.4 | 32.00 | 37 | PASS |
| GPRS850 1 Slot | 251 | 848.8 | 31.72 | 37 | PASS |
| GPRS850 2 Slot | 128 | 824.2 | 30.40 | 37 | PASS |
| GPRS850 2 Slot | 189 | 836.4 | 30.33 | 37 | PASS |
| GPRS850 2 Slot | 251 | 848.8 | 29.88 | 37 | PASS |
| GPRS850 3 Slot | 128 | 824.2 | 28.95 | 37 | PASS |
| GPRS850 3 Slot | 189 | 836.4 | 28.76 | 37 | PASS |
| GPRS850 3 Slot | 251 | 848.8 | 28.26 | 37 | PASS |
| GPRS850 4 Slot | 128 | 824.2 | 27.40 | 37 | PASS |
| GPRS850 4 Slot | 189 | 836.4 | 27.17 | 37 | PASS |
| GPRS850 4 Slot | 251 | 848.8 | 26.68 | 37 | PASS |
| GPRS1900 1 Slot | 512 | 1850.2 | 28.11 | 37 | PASS |
| GPRS1900 1 Slot | 661 | 1880 | 28.38 | 37 | PASS |
| GPRS1900 1 Slot | 810 | 1909.8 | 28.36 | 37 | PASS |
| GPRS1900 2 Slot | 512 | 1850.2 | 26.02 | 37 | PASS |
| GPRS1900 2 Slot | 661 | 1880 | 26.09 | 37 | PASS |
| GPRS1900 2 Slot | 810 | 1909.8 | 26.03 | 37 | PASS |
| GPRS1900 3 Slot | 512 | 1850.2 | 24.64 | 37 | PASS |
| GPRS1900 3 Slot | 661 | 1880 | 24.68 | 37 | PASS |
| GPRS1900 3 Slot | 810 | 1909.8 | 24.60 | 37 | PASS |
| GPRS1900 4 Slot | 512 | 1850.2 | 22.90 | 37 | PASS |
| GPRS1900 4 Slot | 661 | 1880 | 22.92 | 37 | PASS |
| GPRS1900 4 Slot | 810 | 1909.8 | 22.85 | 37 | PASS |
| WCDMA Band2 | 9262 | 1852.4 | 21.82 | 37 | PASS |
| WCDMA Band2 | 9400 | 1880 | 22.61 | 37 | PASS |
| WCDMA Band2 | 9538 | 1907.6 | 22.32 | 37 | PASS |
| WCDMA Band2 Subtest1 | 9262 | 1852.4 | 20.11 | 37 | PASS |
| WCDMA Band2 Subtest1 | 9400 | 1880 | 19.30 | 37 | PASS |
| WCDMA Band2 Subtest1 | 9538 | 1907.6 | 19.86 | 37 | PASS |
| WCDMA Band2 Subtest2 | 9262 | 1852.4 | 19.62 | 37 | PASS |
| WCDMA Band2 Subtest2 | 9400 | 1880 | 19.10 | 37 | PASS |
| WCDMA Band2 Subtest2 | 9538 | 1907.6 | 19.41 | 37 | PASS |
| WCDMA Band2 Subtest3 | 9262 | 1852.4 | 19.59 | 37 | PASS |
| WCDMA Band2 Subtest3 | 9400 | 1880 | 18.58 | 37 | PASS |
| WCDMA Band2 Subtest3 | 9538 | 1907.6 | 19.24 | 37 | PASS |
| WCDMA Band2 Subtest4 | 9262 | 1852.4 | 19.49 | 37 | PASS |
| WCDMA Band2 Subtest4 | 9400 | 1880 | 18.96 | 37 | PASS |
| WCDMA Band2 Subtest4 | 9538 | 1907.6 | 18.82 | 37 | PASS |
| WCDMA Band2 Subtest1 | 9262 | 1852.4 | 20.02 | 37 | PASS |
| WCDMA Band2 Subtest1 | 9400 | 1880 | 19.22 | 37 | PASS |
| WCDMA Band2 Subtest1 | 9538 | 1907.6 | 19.42 | 37 | PASS |
| WCDMA Band2 Subtest2 | 9262 | 1852.4 | 20.15 | 37 | PASS |
| WCDMA Band2 Subtest2 | 9400 | 1880 | 19.39 | 37 | PASS |

| | | | | | |
|----------------------|------|--------|-------|----|------|
| WCDMA Band2 Subtest2 | 9538 | 1907.6 | 19.87 | 37 | PASS |
| WCDMA Band2 Subtest3 | 9262 | 1852.4 | 19.73 | 37 | PASS |
| WCDMA Band2 Subtest3 | 9400 | 1880 | 19.06 | 37 | PASS |
| WCDMA Band2 Subtest3 | 9538 | 1907.6 | 19.58 | 37 | PASS |
| WCDMA Band2 Subtest4 | 9262 | 1852.4 | 20.27 | 37 | PASS |
| WCDMA Band2 Subtest4 | 9400 | 1880 | 19.56 | 37 | PASS |
| WCDMA Band2 Subtest4 | 9538 | 1907.6 | 19.92 | 37 | PASS |
| WCDMA Band2 Subtest5 | 9262 | 1852.4 | 19.96 | 37 | PASS |
| WCDMA Band2 Subtest5 | 9400 | 1880 | 19.15 | 37 | PASS |
| WCDMA Band2 Subtest5 | 9538 | 1907.6 | 19.80 | 37 | PASS |
| WCDMA Band5 | 4132 | 826.4 | 22.31 | 37 | PASS |
| WCDMA Band5 | 4182 | 836.4 | 21.68 | 37 | PASS |
| WCDMA Band5 | 4233 | 846.6 | 22.46 | 37 | PASS |
| WCDMA Band5 Subtest1 | 4132 | 826.4 | 20.18 | 37 | PASS |
| WCDMA Band5 Subtest1 | 4182 | 836.4 | 21.19 | 37 | PASS |
| WCDMA Band5 Subtest1 | 4233 | 846.6 | 20.67 | 37 | PASS |
| WCDMA Band5 Subtest2 | 4132 | 826.4 | 20.06 | 37 | PASS |
| WCDMA Band5 Subtest2 | 4182 | 836.4 | 21.12 | 37 | PASS |
| WCDMA Band5 Subtest2 | 4233 | 846.6 | 20.21 | 37 | PASS |
| WCDMA Band5 Subtest3 | 4132 | 826.4 | 19.75 | 37 | PASS |
| WCDMA Band5 Subtest3 | 4182 | 836.4 | 20.59 | 37 | PASS |
| WCDMA Band5 Subtest3 | 4233 | 846.6 | 20.18 | 37 | PASS |
| WCDMA Band5 Subtest4 | 4132 | 826.4 | 19.44 | 37 | PASS |
| WCDMA Band5 Subtest4 | 4182 | 836.4 | 20.24 | 37 | PASS |
| WCDMA Band5 Subtest4 | 4233 | 846.6 | 19.71 | 37 | PASS |
| WCDMA Band5 Subtest1 | 4132 | 826.4 | 20.11 | 37 | PASS |
| WCDMA Band5 Subtest1 | 4182 | 836.4 | 20.99 | 37 | PASS |
| WCDMA Band5 Subtest1 | 4233 | 846.6 | 20.50 | 37 | PASS |
| WCDMA Band5 Subtest2 | 4132 | 826.4 | 20.00 | 37 | PASS |
| WCDMA Band5 Subtest2 | 4182 | 836.4 | 21.30 | 37 | PASS |
| WCDMA Band5 Subtest2 | 4233 | 846.6 | 20.59 | 37 | PASS |
| WCDMA Band5 Subtest3 | 4132 | 826.4 | 19.92 | 37 | PASS |
| WCDMA Band5 Subtest3 | 4182 | 836.4 | 20.92 | 37 | PASS |
| WCDMA Band5 Subtest3 | 4233 | 846.6 | 20.18 | 37 | PASS |
| WCDMA Band5 Subtest4 | 4132 | 826.4 | 20.19 | 37 | PASS |
| WCDMA Band5 Subtest4 | 4182 | 836.4 | 21.38 | 37 | PASS |
| WCDMA Band5 Subtest4 | 4233 | 846.6 | 20.74 | 37 | PASS |
| WCDMA Band5 Subtest5 | 4132 | 826.4 | 19.86 | 37 | PASS |
| WCDMA Band5 Subtest5 | 4182 | 836.4 | 20.99 | 37 | PASS |
| WCDMA Band5 Subtest5 | 4233 | 846.6 | 20.11 | 37 | PASS |

8.2 PEAK-TO-AVERAGE RATIO

| Band | Channel | Frequency (MHz) | Result (dB) | high Limit (dB) | Verdict |
|-------------|---------|-----------------|-------------|-----------------|---------|
| GSM850 | 128 | 824.2 | 2.66 | 13 | PASS |
| GSM850 | 189 | 836.4 | 2.92 | 13 | PASS |
| GSM850 | 251 | 848.8 | 2.65 | 13 | PASS |
| GSM1900 | 512 | 1850.2 | 2.72 | 13 | PASS |
| GSM1900 | 661 | 1880 | 2.71 | 13 | PASS |
| GSM1900 | 810 | 1909.8 | 2.74 | 13 | PASS |
| GPRS850 | 128 | 824.2 | 2.66 | 13 | PASS |
| GPRS850 | 189 | 836.4 | 2.91 | 13 | PASS |
| GPRS850 | 251 | 848.8 | 2.65 | 13 | PASS |
| GPRS1900 | 512 | 1850.2 | 2.65 | 13 | PASS |
| GPRS1900 | 661 | 1880 | 2.65 | 13 | PASS |
| GPRS1900 | 810 | 1909.8 | 2.65 | 13 | PASS |
| WCDMA Band2 | 9262 | 1852.4 | 2.88 | 13 | PASS |
| WCDMA Band2 | 9400 | 1880 | 3.04 | 13 | PASS |
| WCDMA Band2 | 9538 | 1907.6 | 2.81 | 13 | PASS |
| WCDMA Band5 | 4132 | 826.4 | 3.13 | 13 | PASS |
| WCDMA Band5 | 4182 | 836.4 | 2.67 | 13 | PASS |
| WCDMA Band5 | 4233 | 846.6 | 2.81 | 13 | PASS |

GSM850 Channel=128

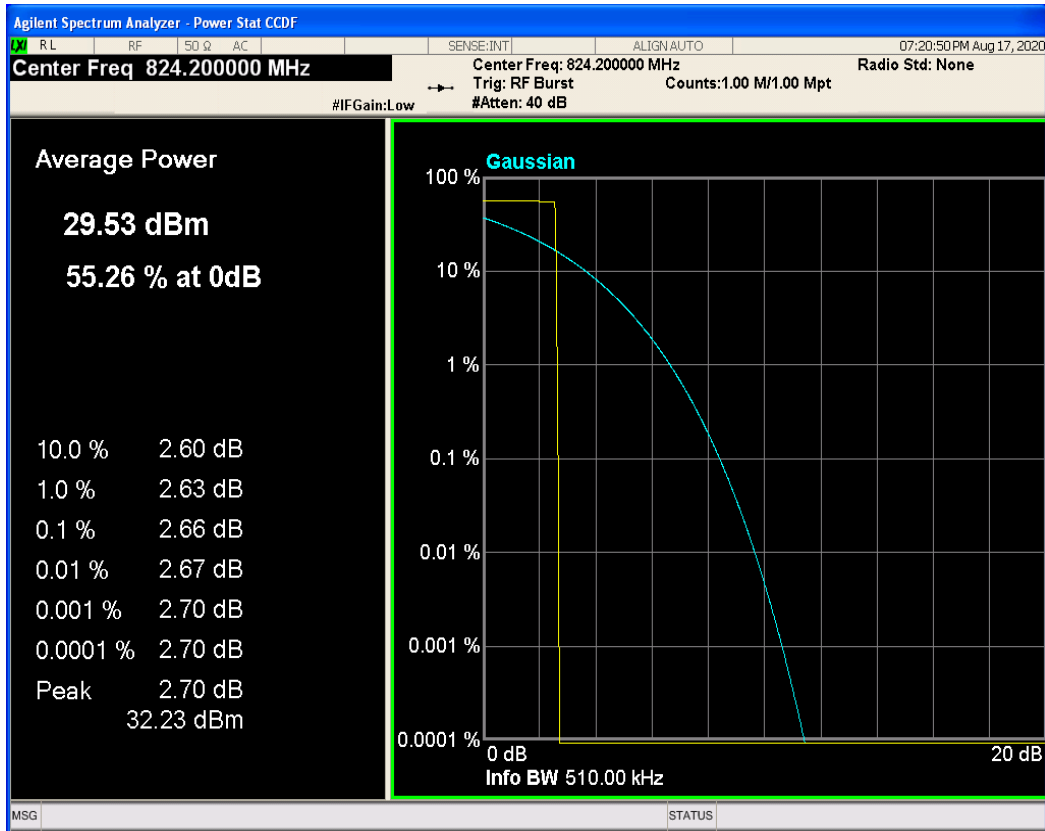

GSM850 Channel=189

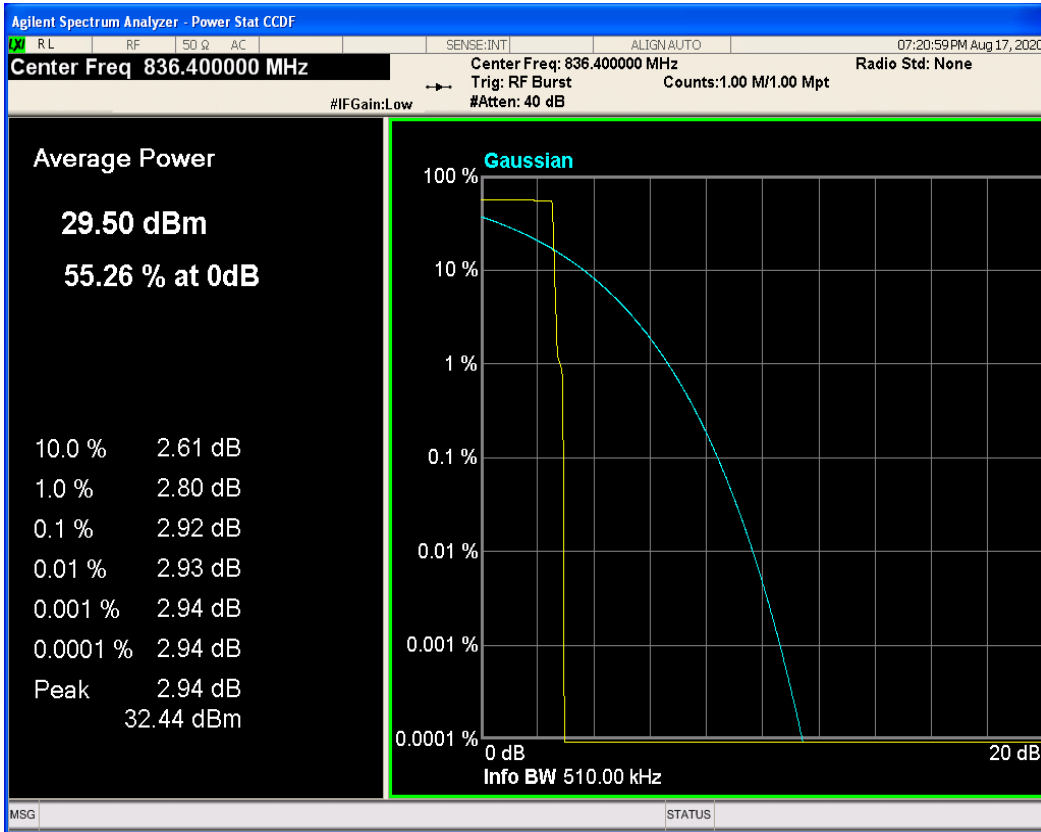

GSM850 Channel=251

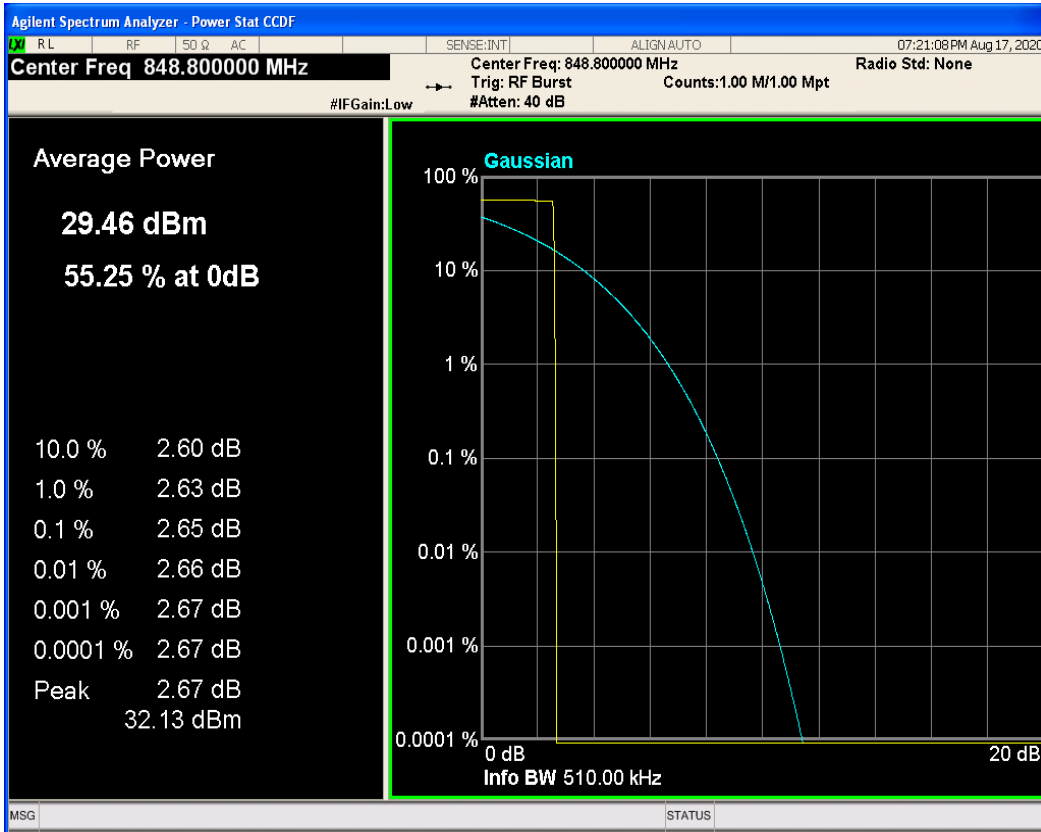

GSM1900 Channel=661

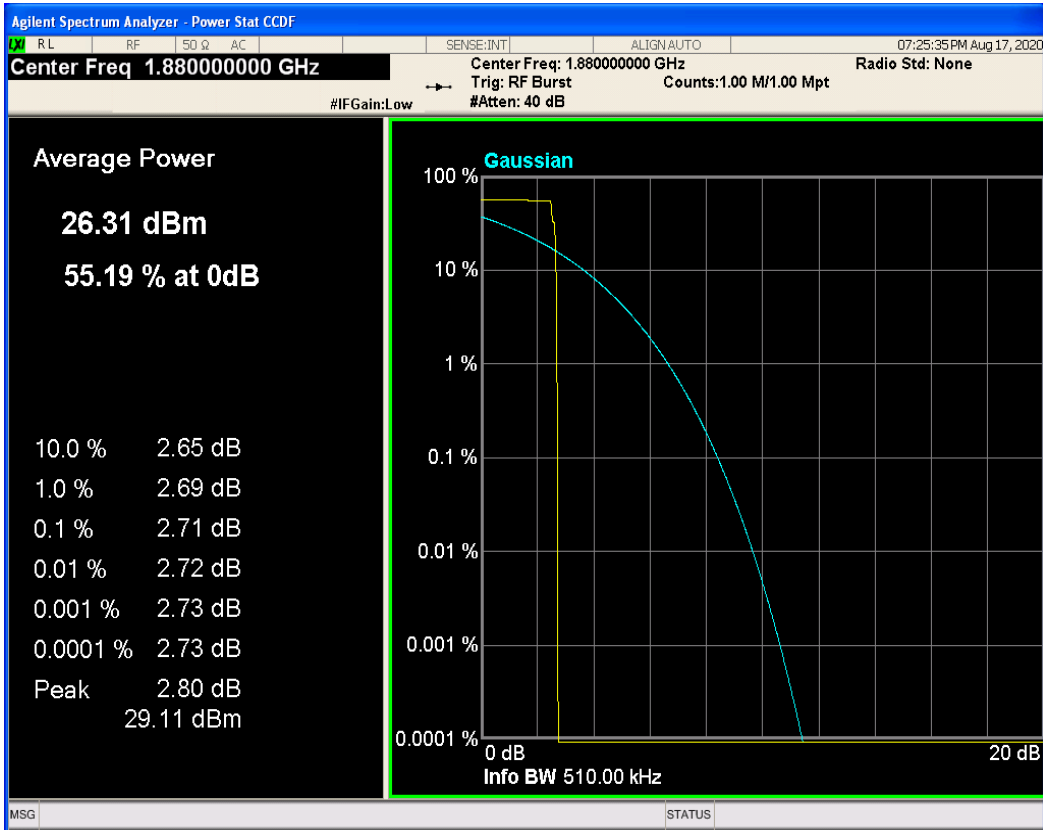

GSM1900 Channel=512

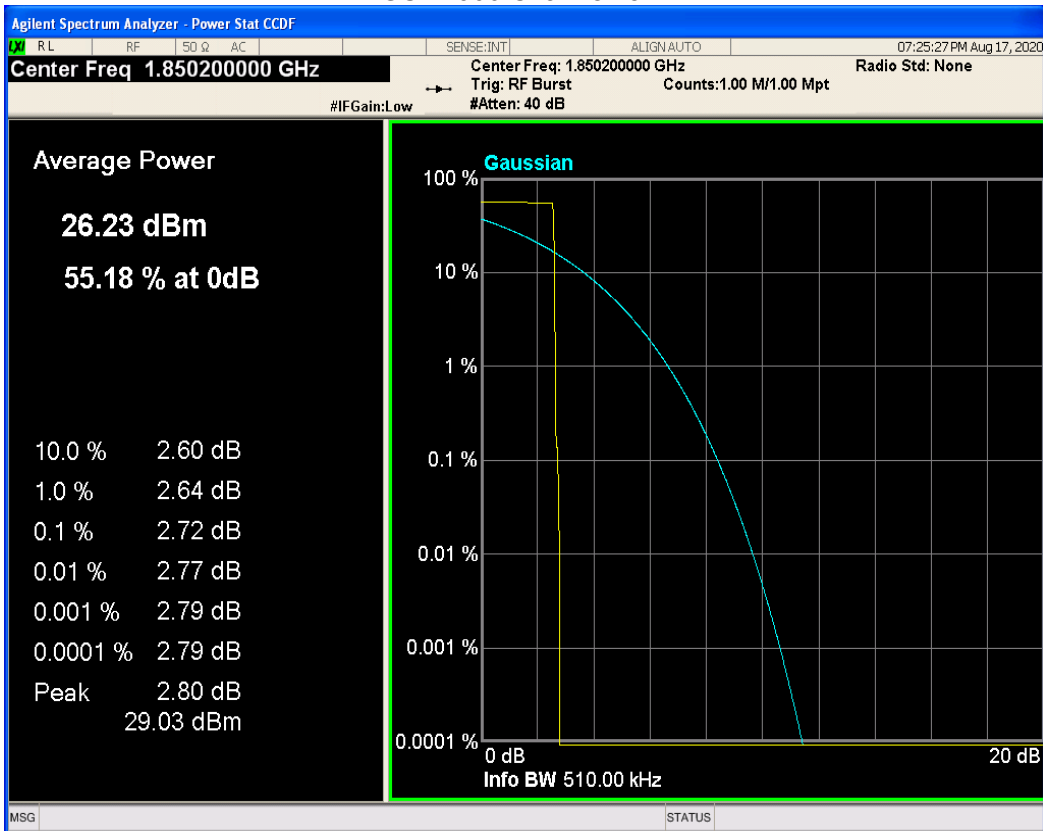

GSM1900 Channel=810

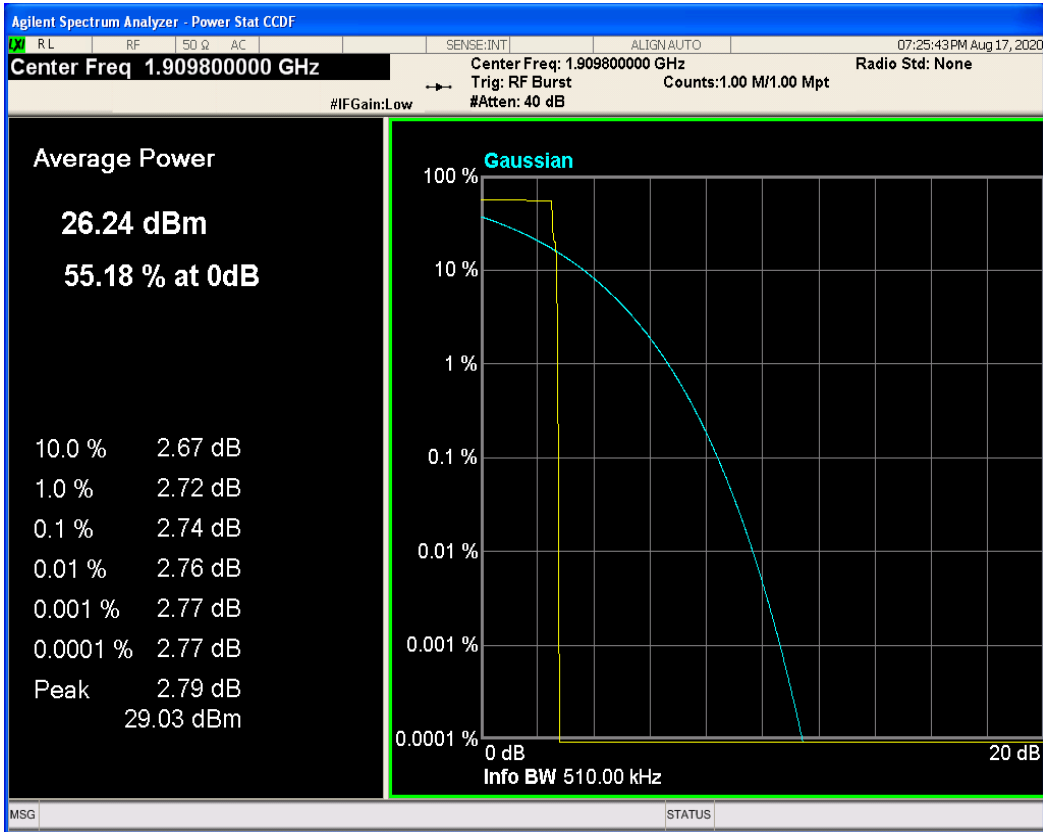

GPRS850 Channel=128

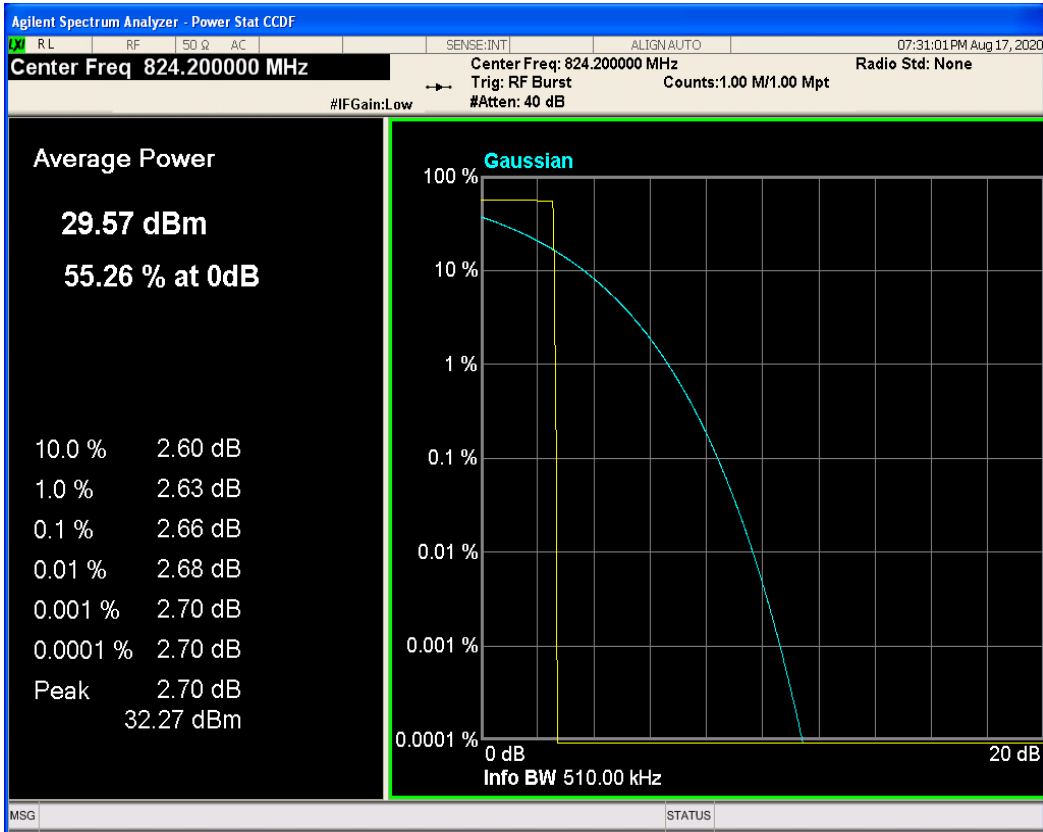

GPRS850 Channel=189

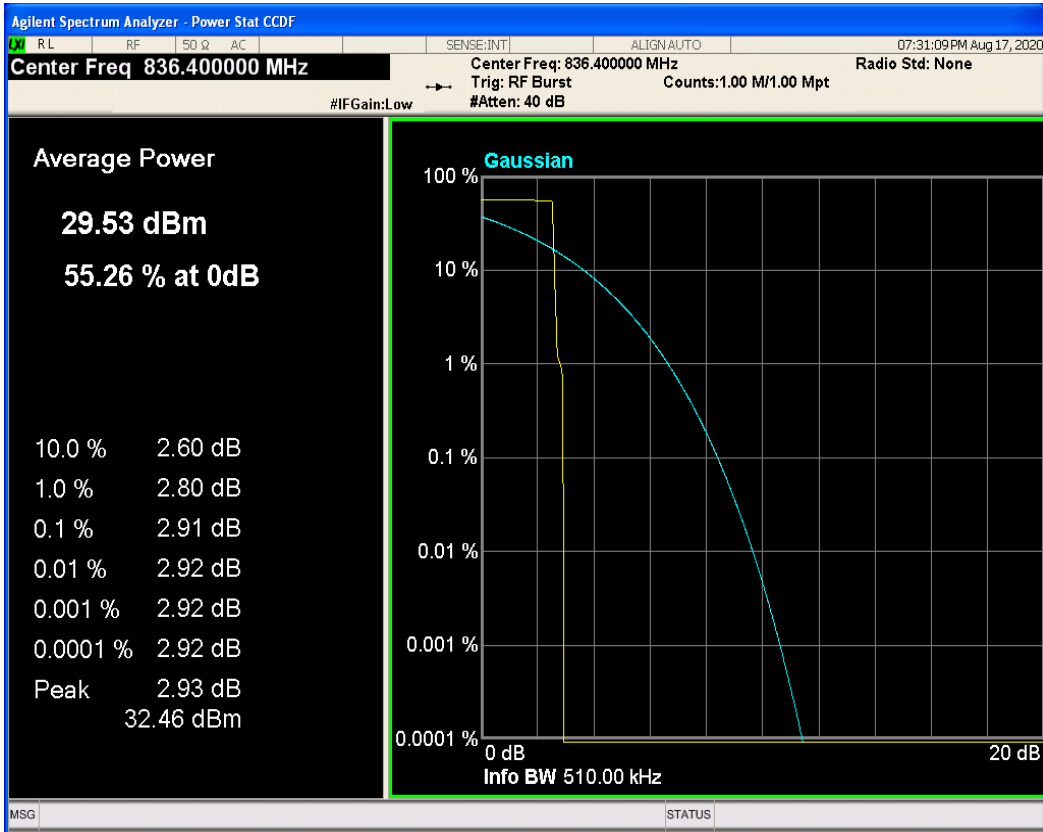

GPRS850 Channel=251

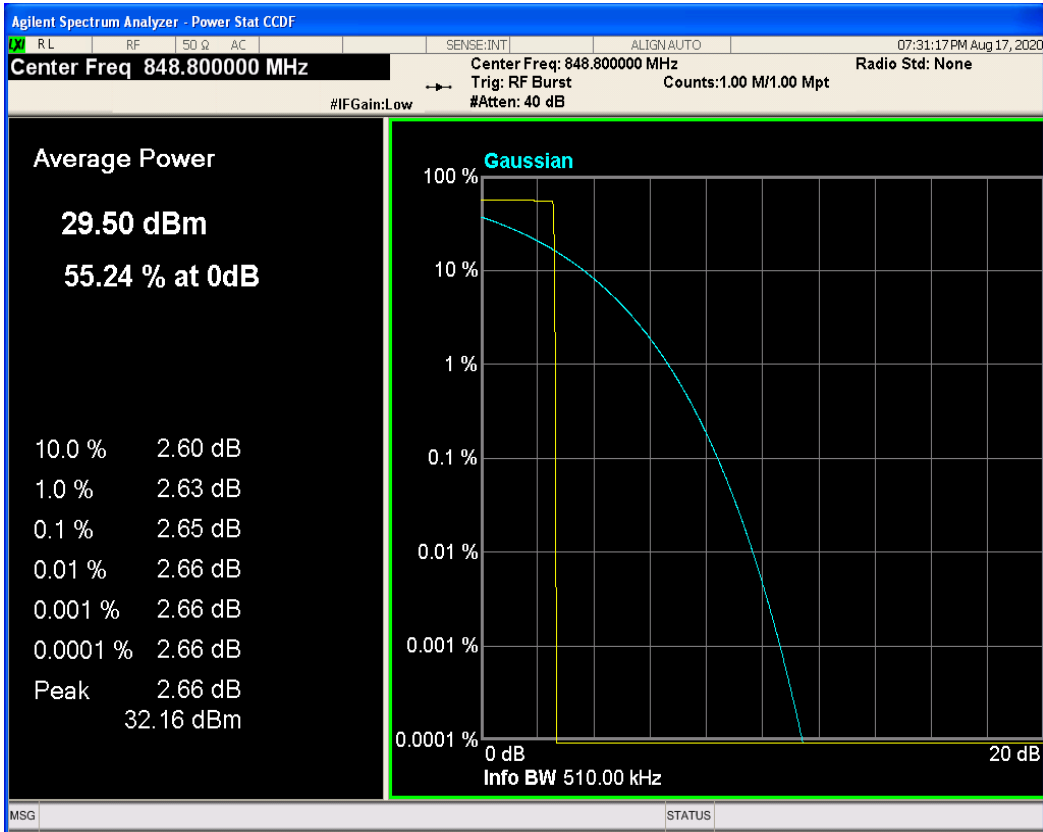

GPRS1900 Channel=512

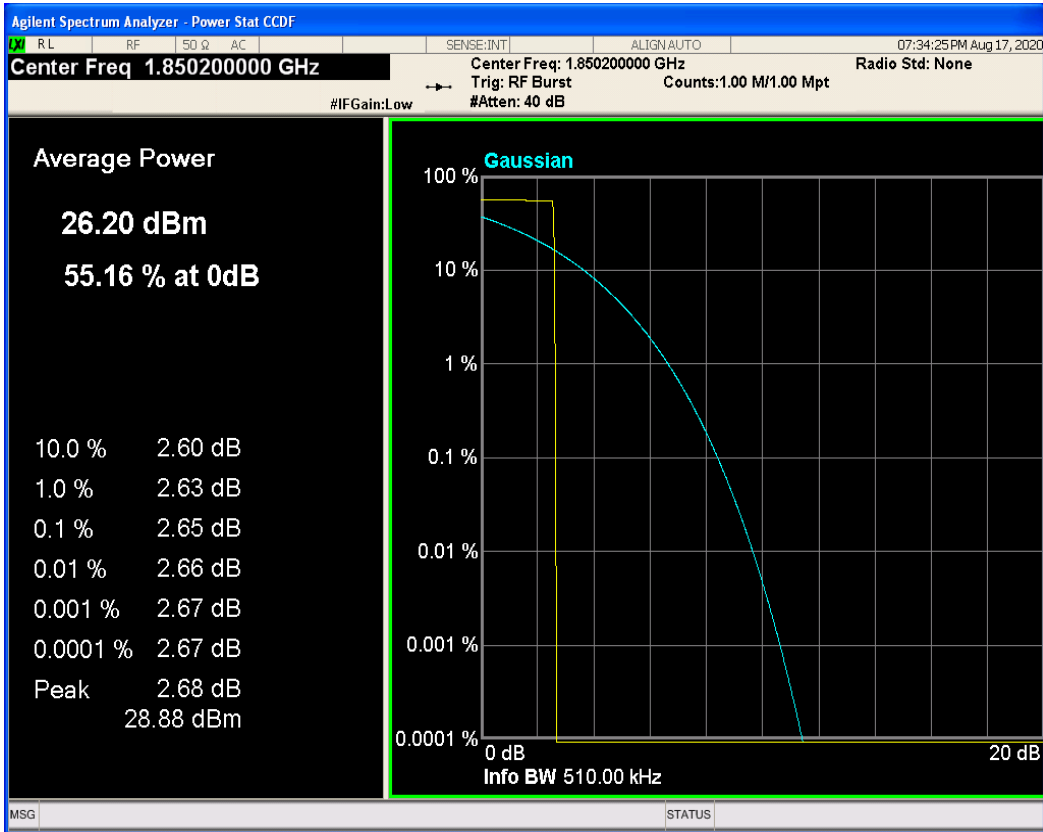

GPRS1900 Channel=661

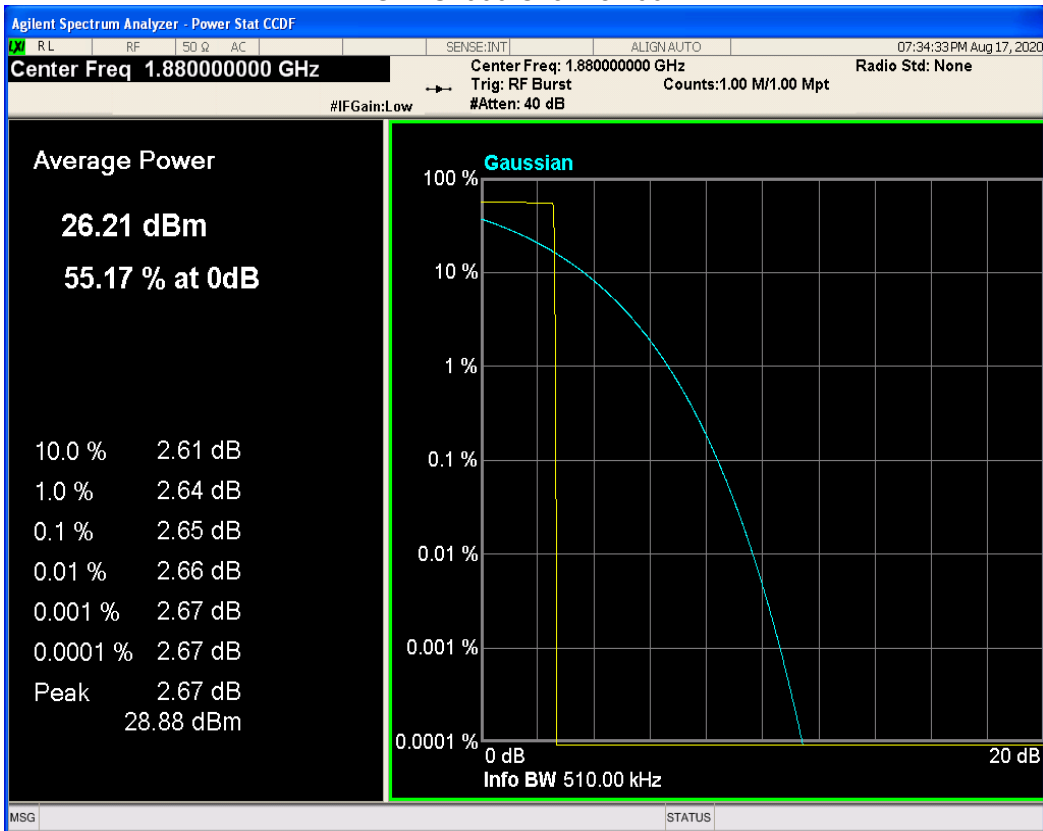

GPRS1900 Channel=810

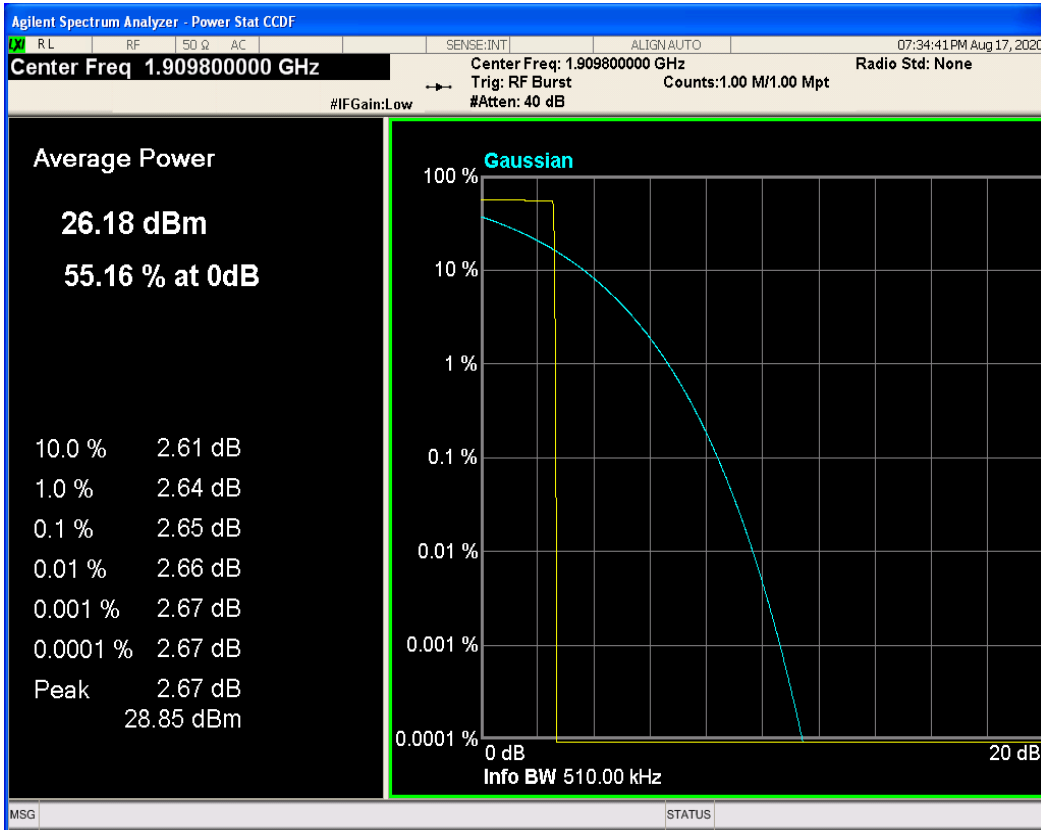

WCDMA Band2 Channel=9262

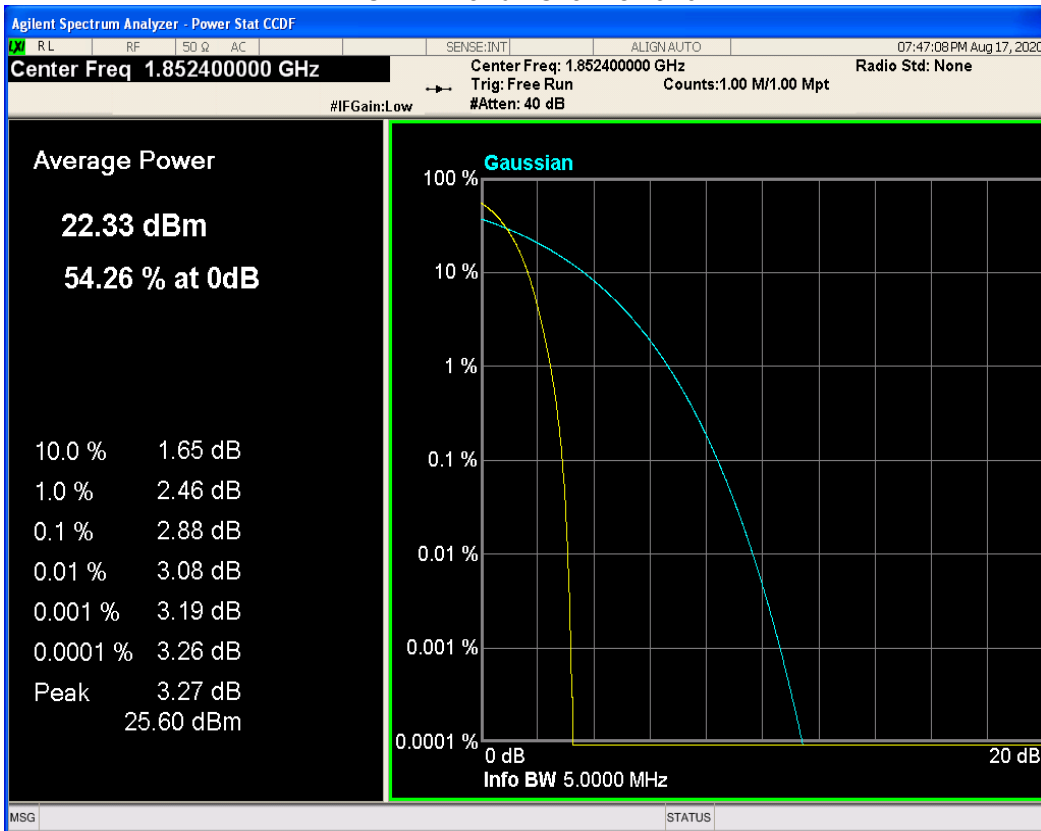

WCDMA Band2 Channel=9400

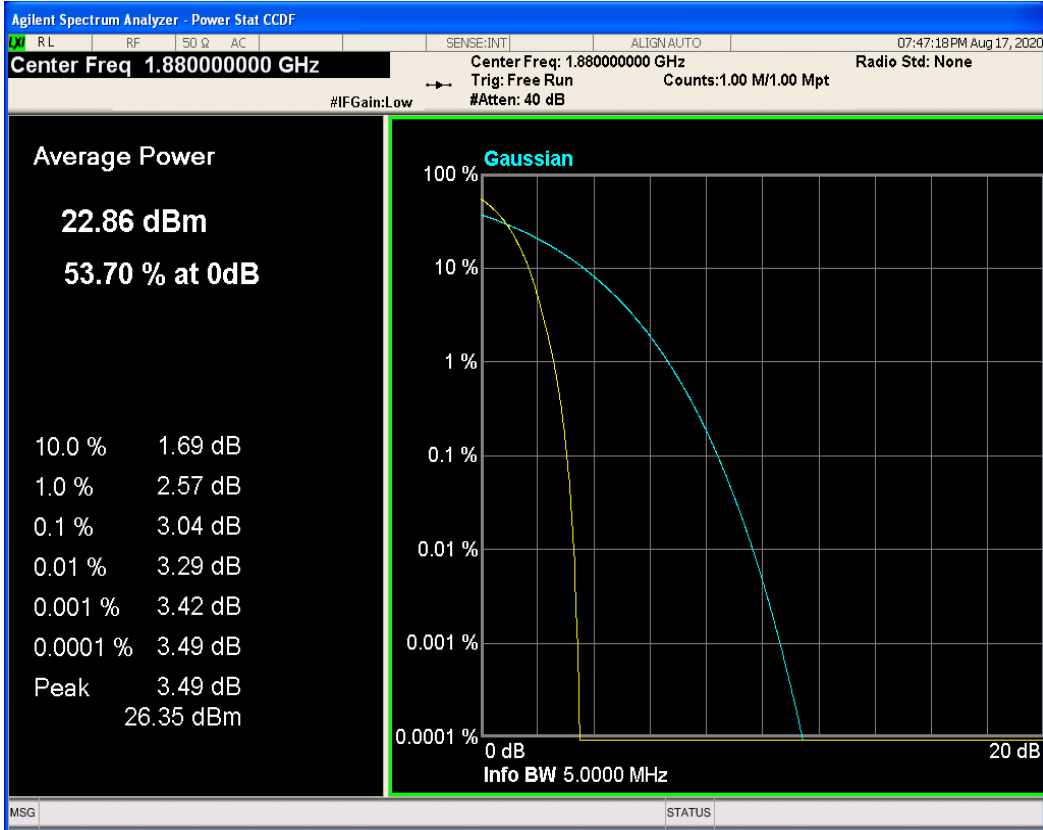

WCDMA Band2 Channel=9538

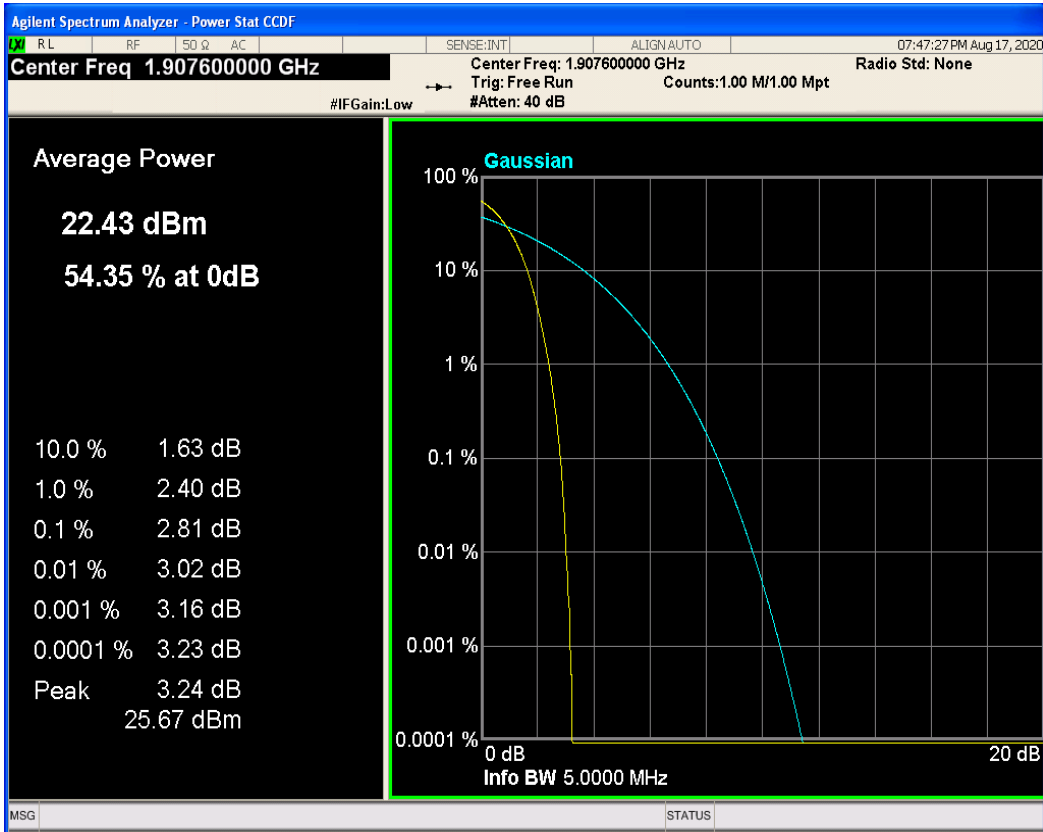

WCDMA Band5 Channel=4132

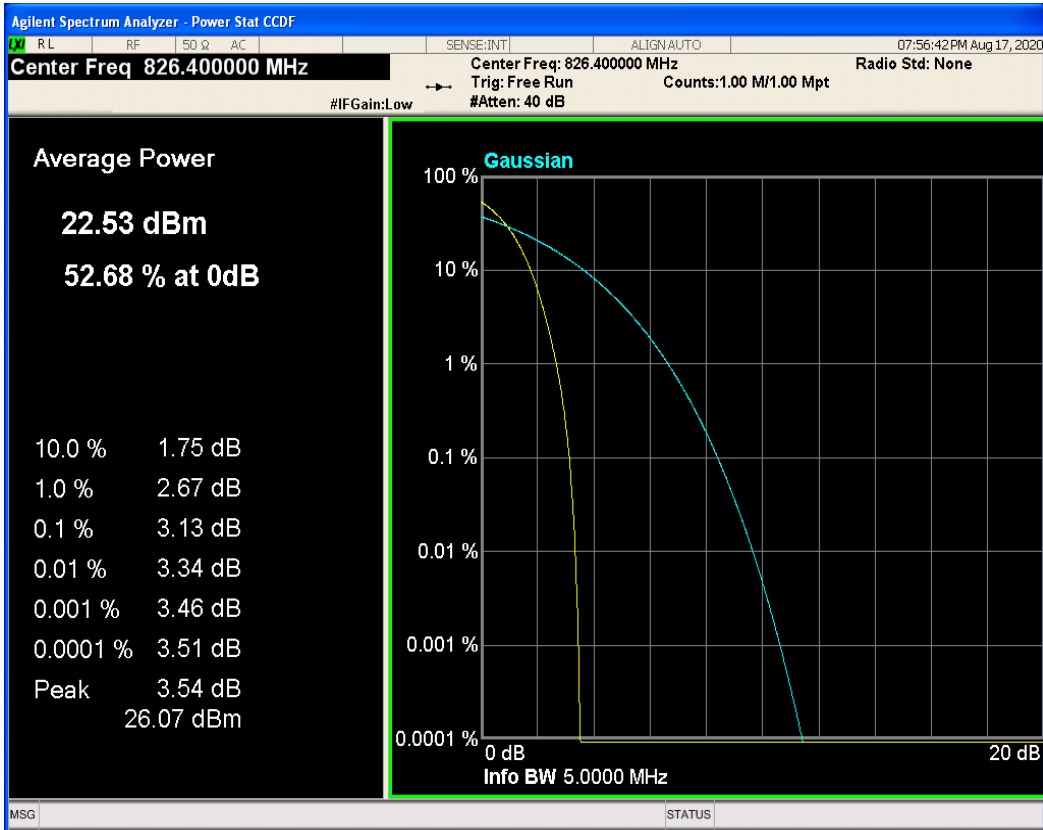

WCDMA Band5 Channel=4182

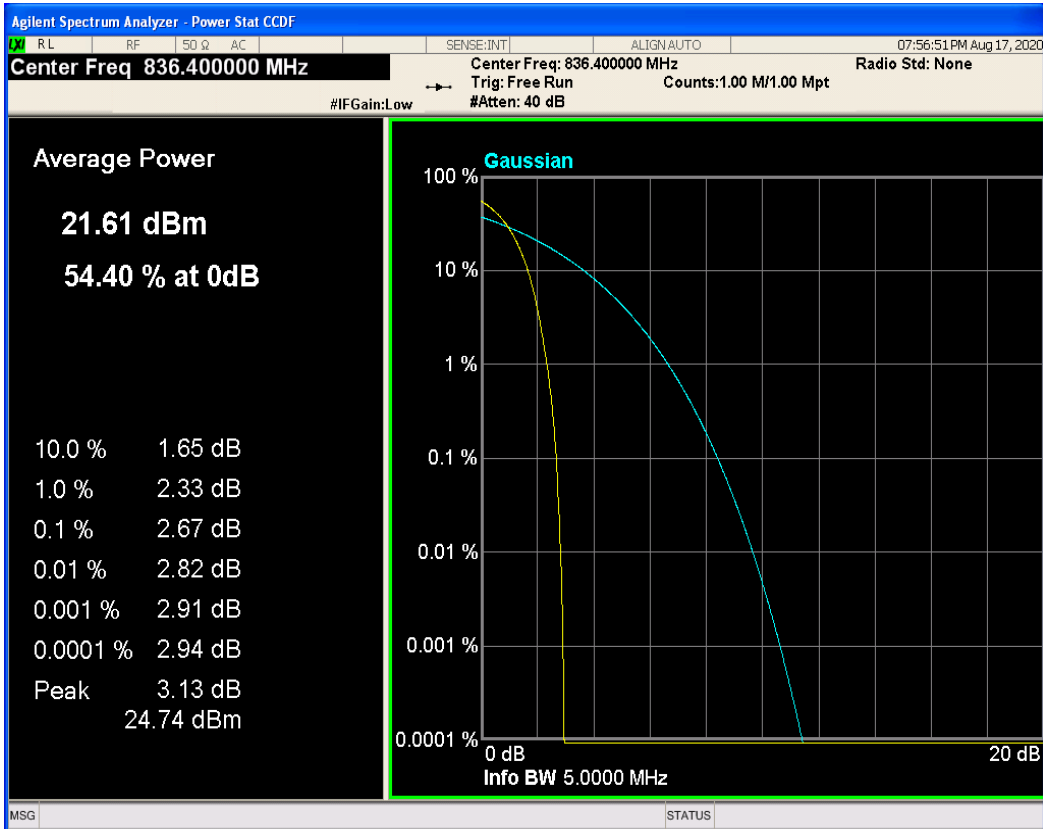

WCDMA Band5 Channel=4233

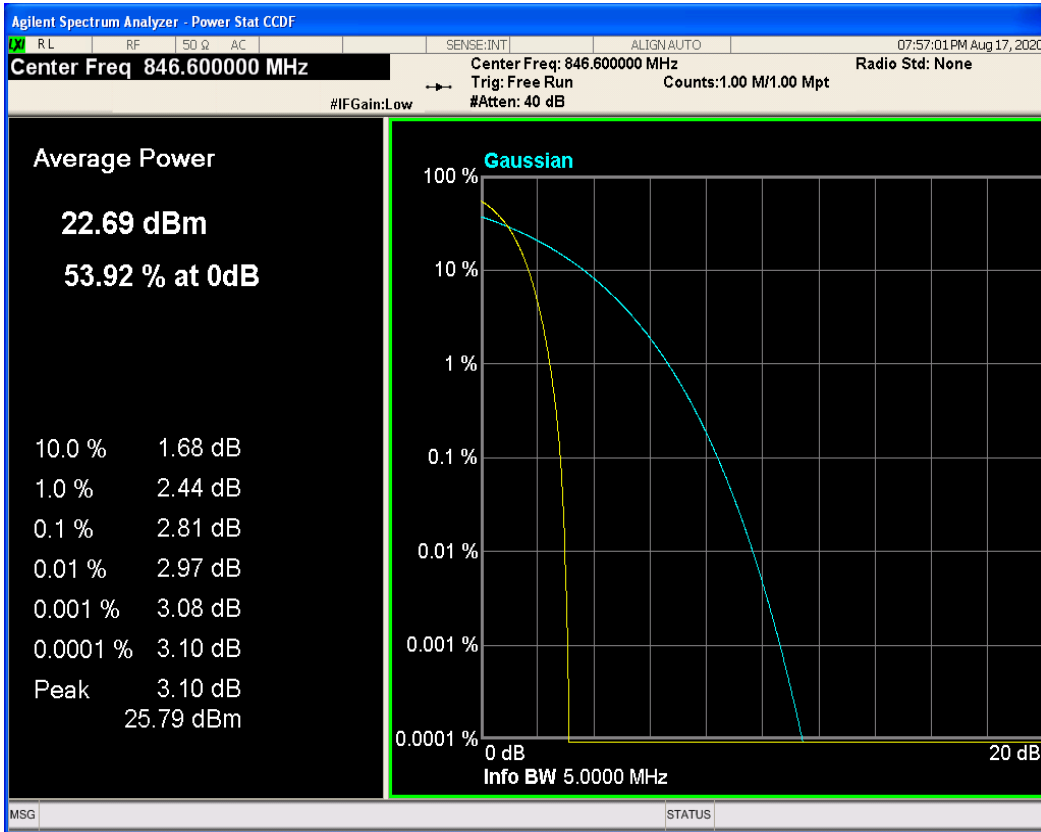

8.3 OCCUPIED BANDWIDTH

| Band | Channel | Frequency (MHz) | 99% OBW (kHz) | -26dB EBW (kHz) | Verdict |
|-------------|---------|-----------------|---------------|-----------------|---------|
| GSM850 | 128 | 824.2 | 250.742 | 323.046 | PASS |
| GSM850 | 189 | 836.4 | 245.025 | 319.240 | PASS |
| GSM850 | 251 | 848.8 | 244.249 | 314.586 | PASS |
| GSM1900 | 512 | 1850.2 | 248.258 | 324.574 | PASS |
| GSM1900 | 661 | 1880 | 245.810 | 315.748 | PASS |
| GSM1900 | 810 | 1909.8 | 254.260 | 321.186 | PASS |
| GPRS850 | 128 | 824.2 | 246.945 | 318.729 | PASS |
| GPRS850 | 189 | 836.4 | 245.977 | 310.289 | PASS |
| GPRS850 | 251 | 848.8 | 243.216 | 319.112 | PASS |
| GPRS1900 | 512 | 1850.2 | 246.039 | 315.710 | PASS |
| GPRS1900 | 661 | 1880 | 244.416 | 320.965 | PASS |
| GPRS1900 | 810 | 1909.8 | 245.050 | 320.098 | PASS |
| WCDMA Band2 | 9262 | 1852.4 | 4159.401 | 4674.745 | PASS |
| WCDMA Band2 | 9400 | 1880 | 4139.274 | 4671.489 | PASS |
| WCDMA Band2 | 9538 | 1907.6 | 4152.012 | 4679.382 | PASS |
| WCDMA Band5 | 4132 | 826.4 | 4144.032 | 4635.008 | PASS |
| WCDMA Band5 | 4182 | 836.4 | 4161.875 | 4657.155 | PASS |
| WCDMA Band5 | 4233 | 846.6 | 4140.302 | 4661.334 | PASS |

GSM850 Channel=128

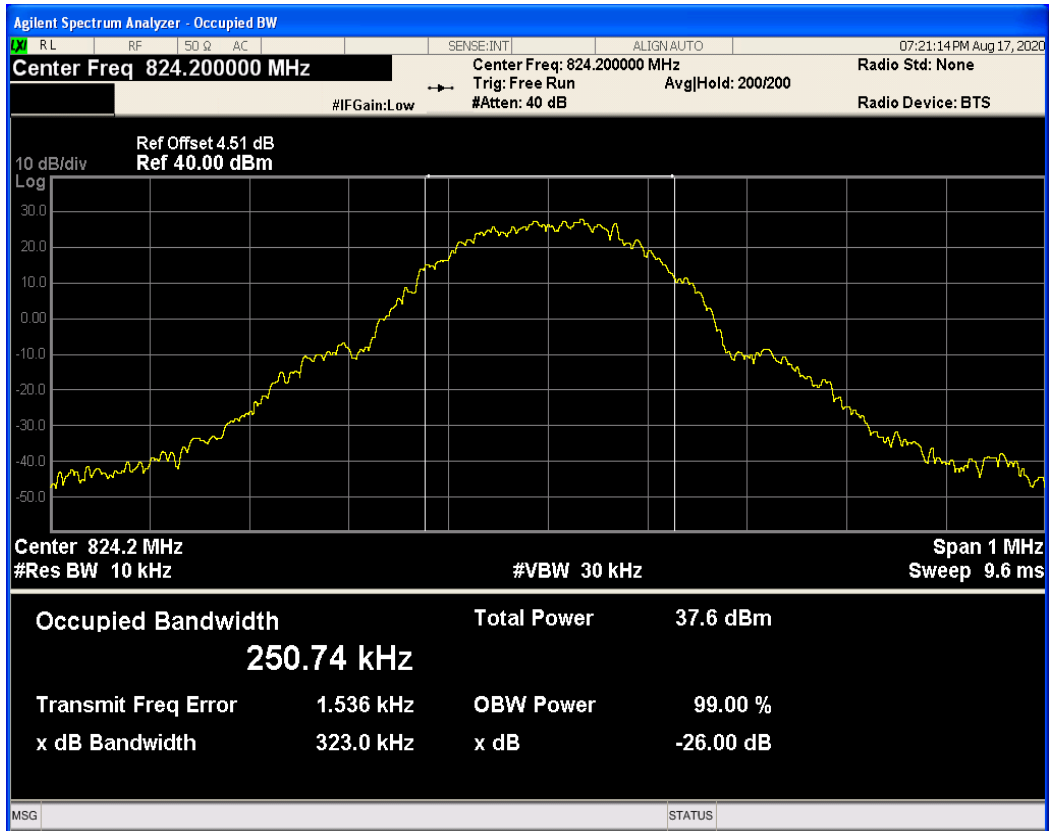

GSM850 Channel=189

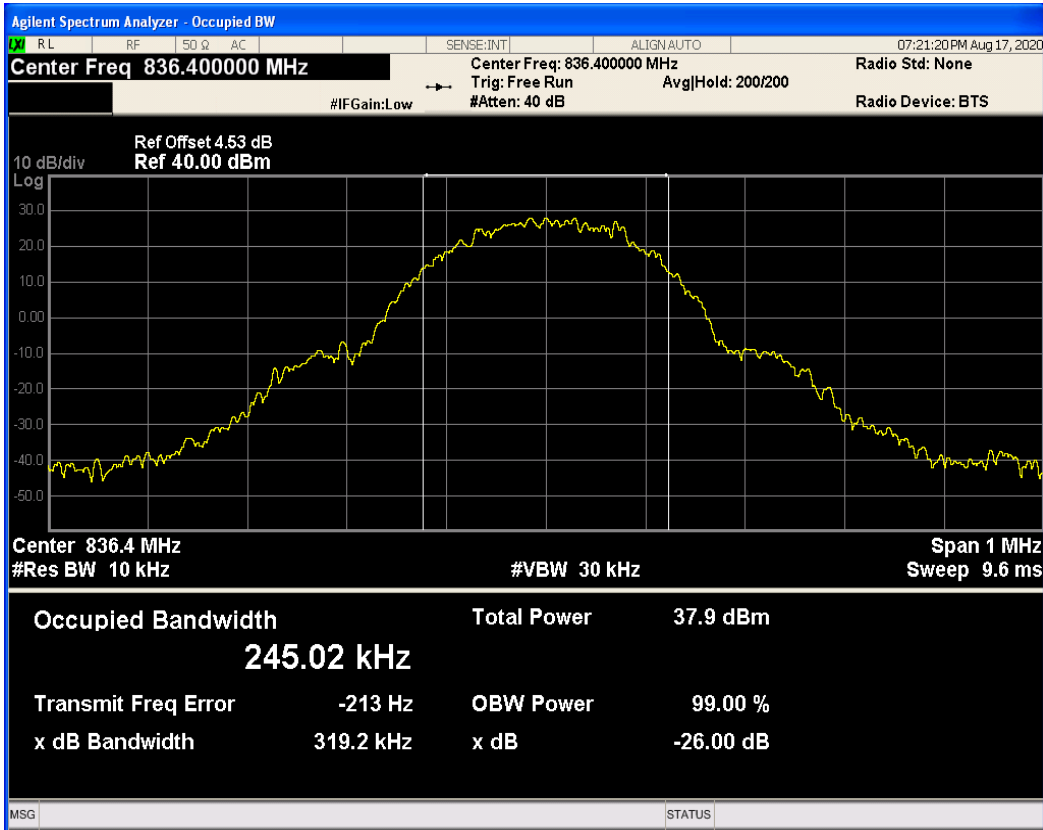

GSM850 Channel=251

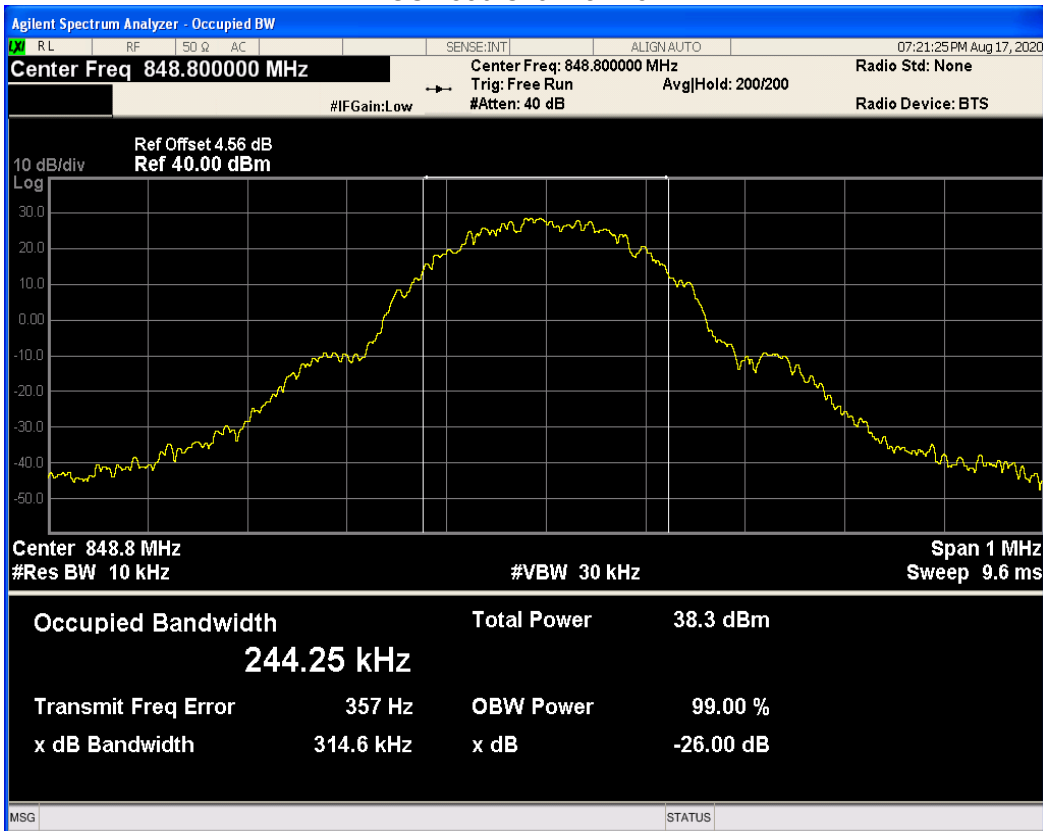

GSM1900 Channel=512

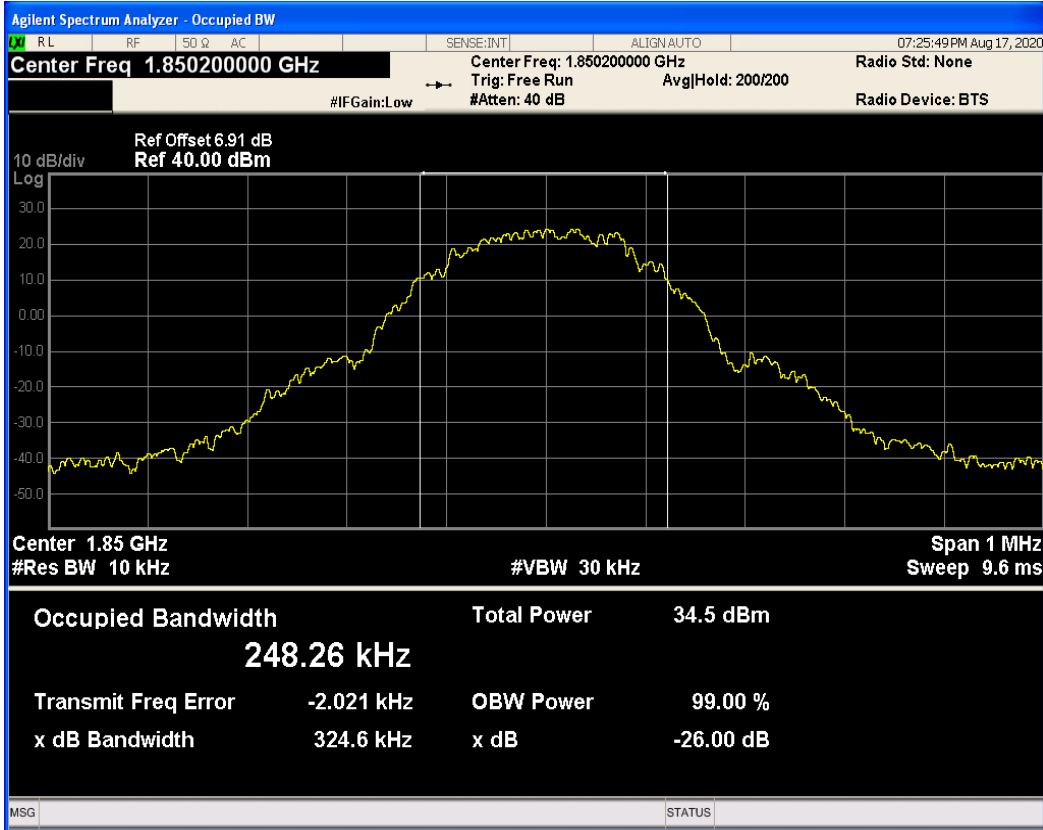

GSM1900 Channel=661

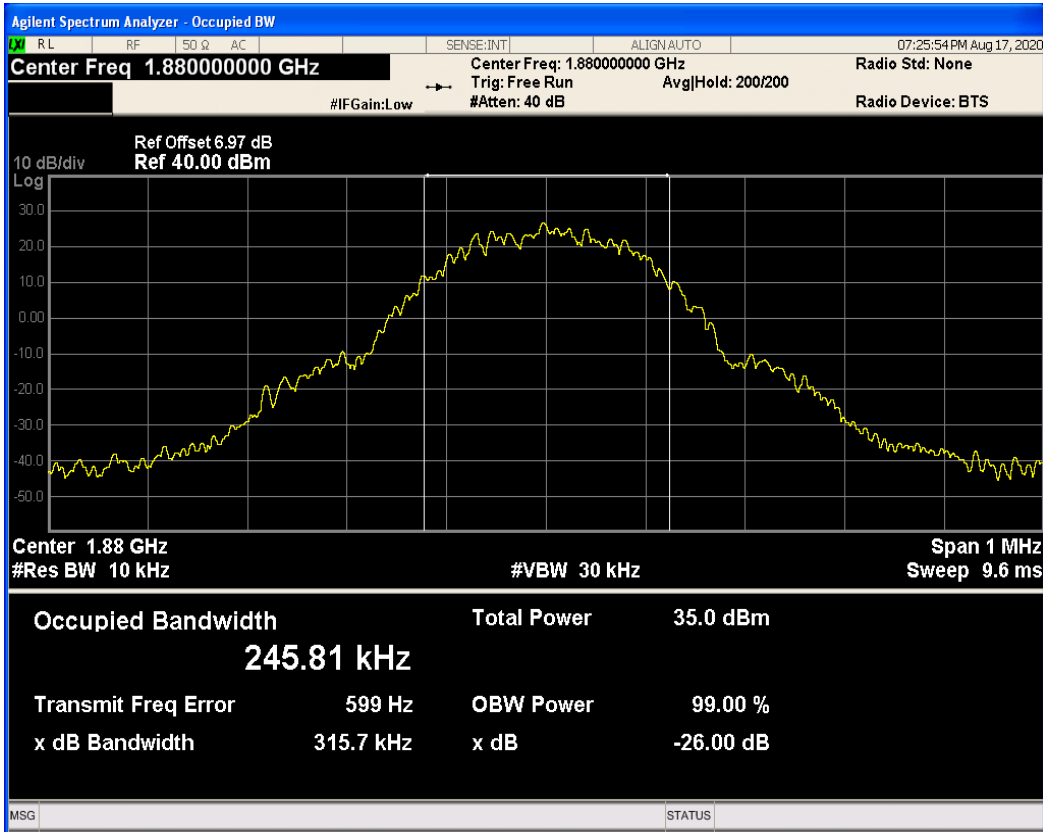

GSM1900 Channel=810

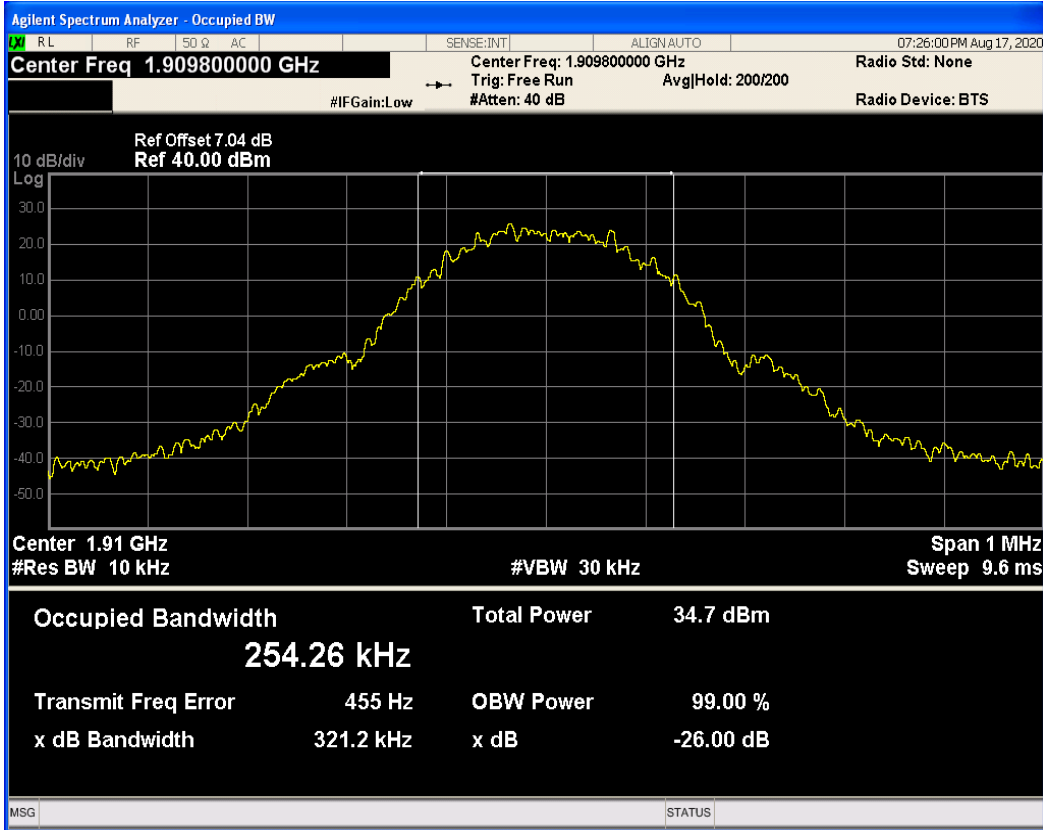

GPRS850 Channel=128

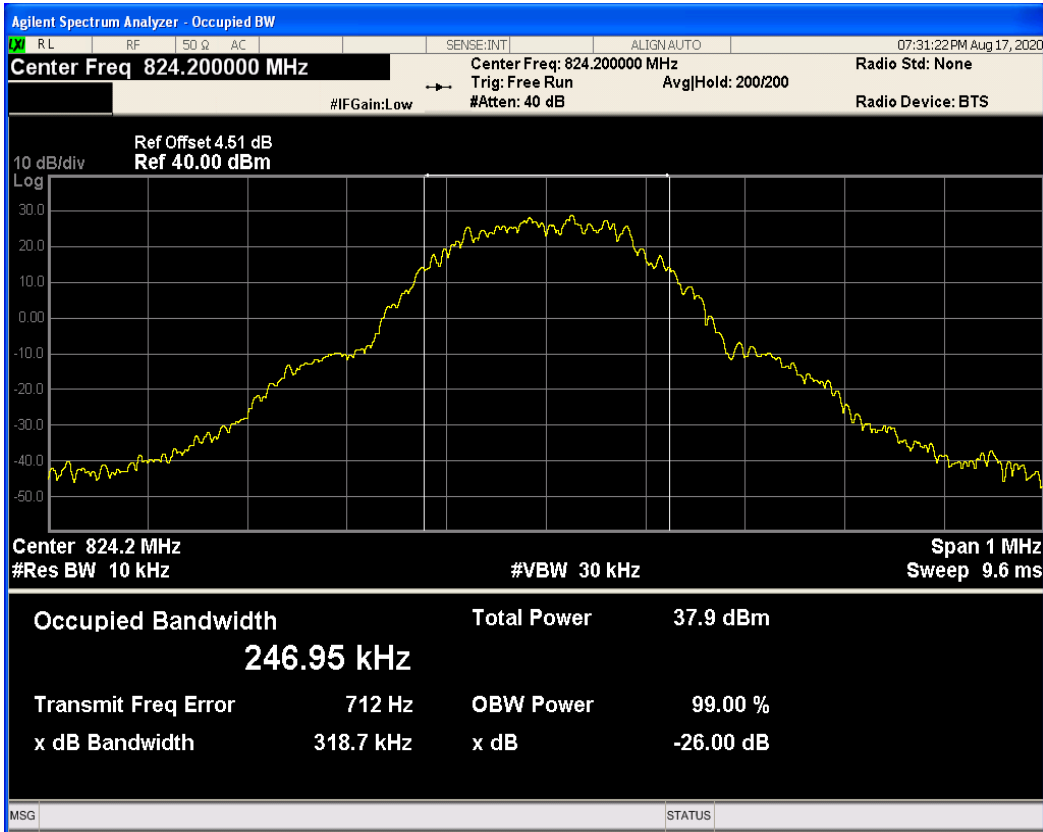

GPRS850 Channel=189

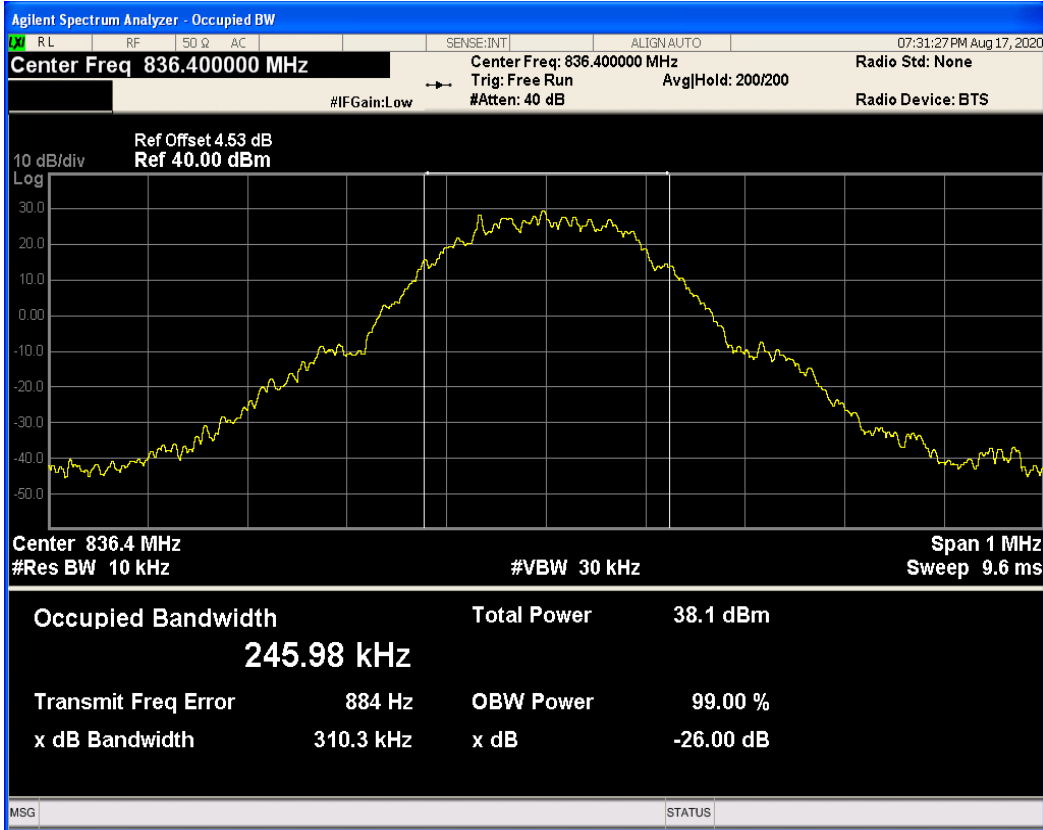

GPRS850 Channel=251

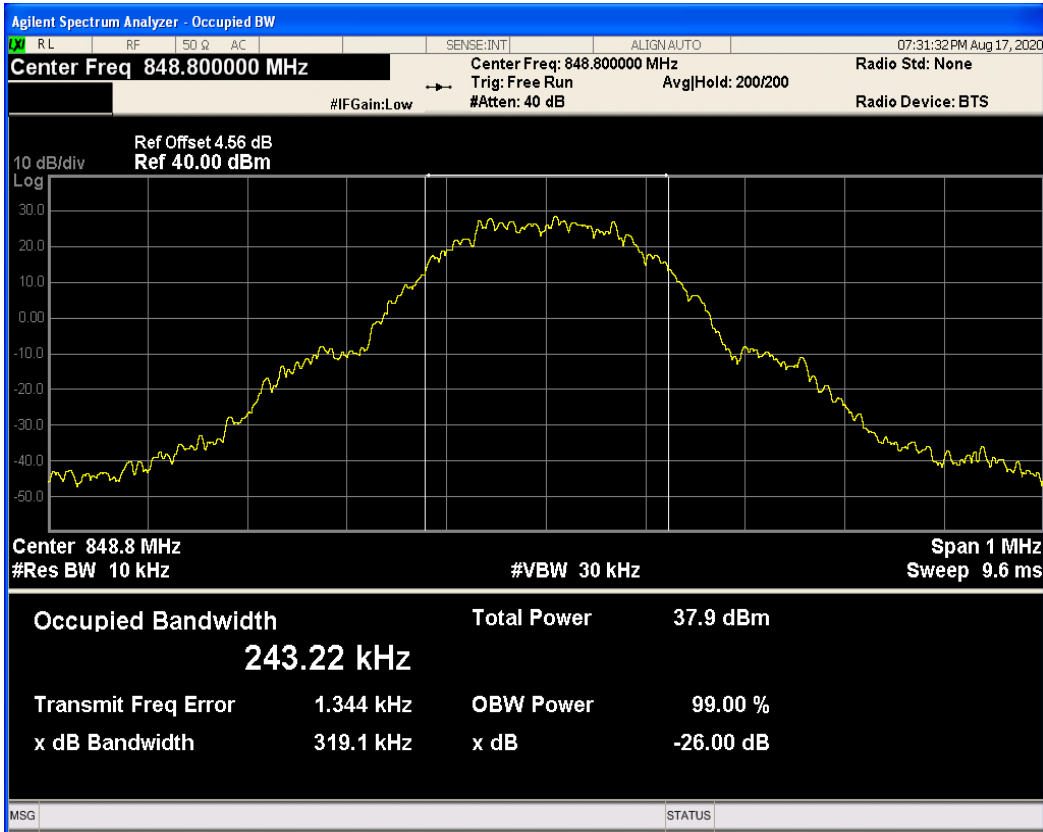

GPRS1900 Channel=512

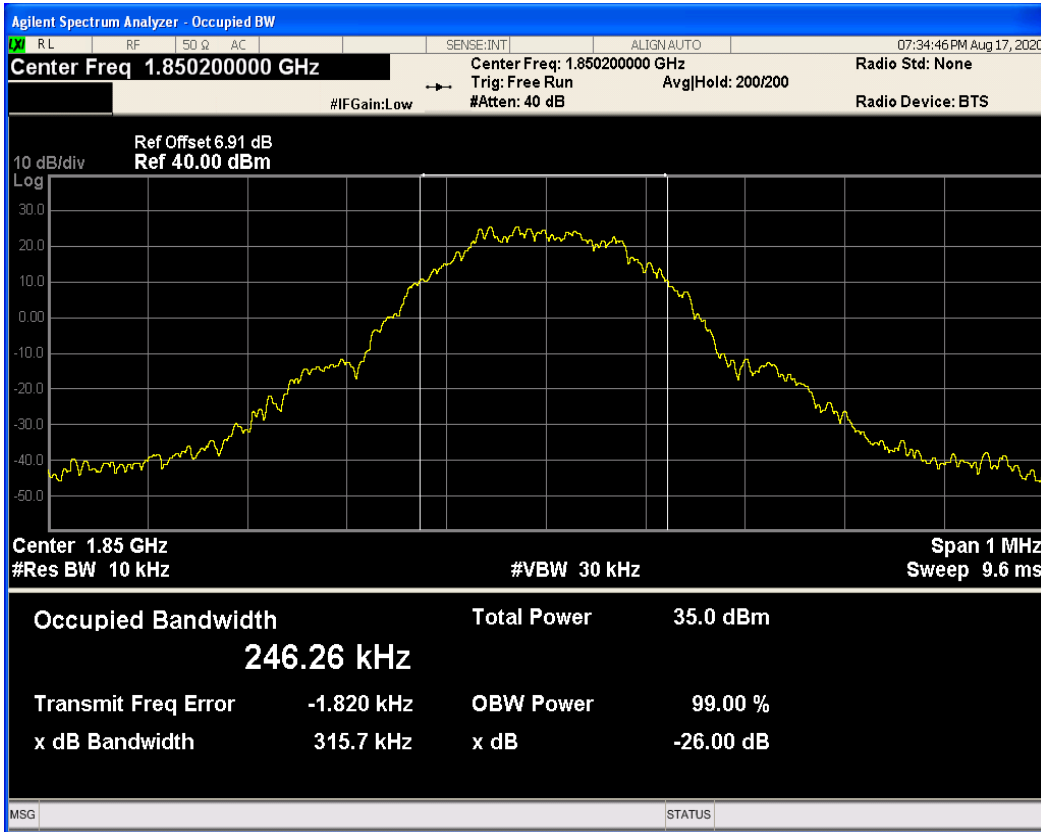

GPRS1900 Channel=661

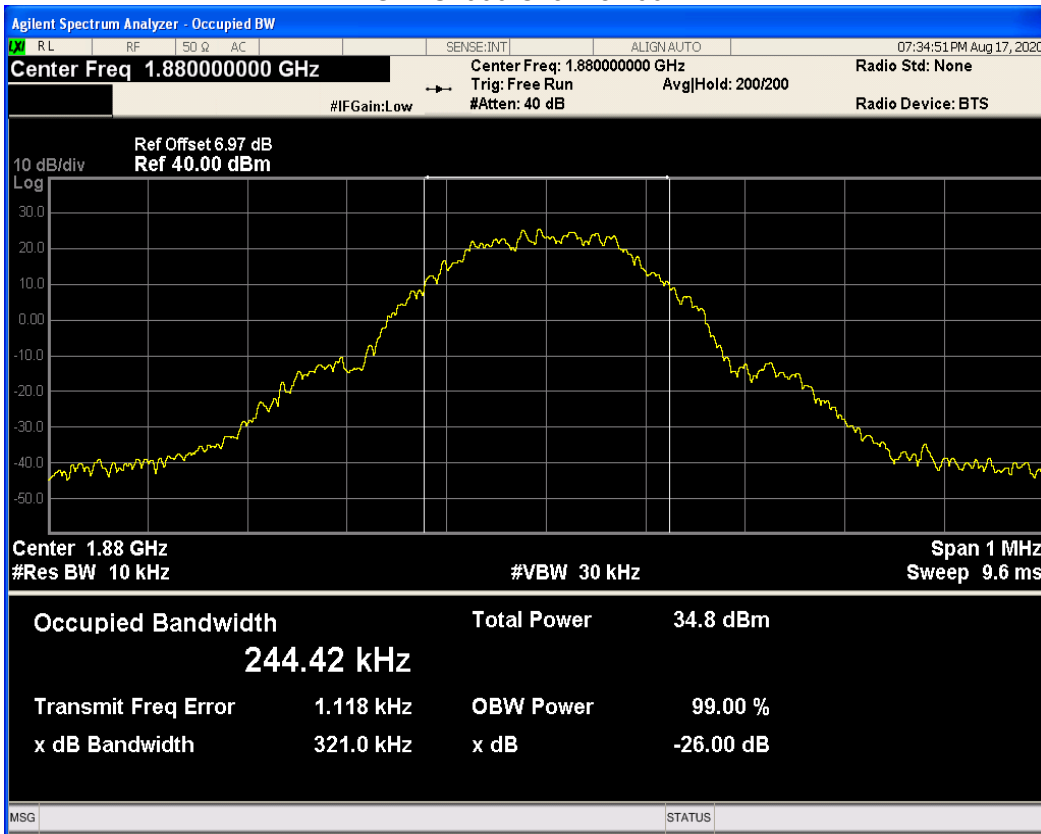

GPRS1900 Channel=810

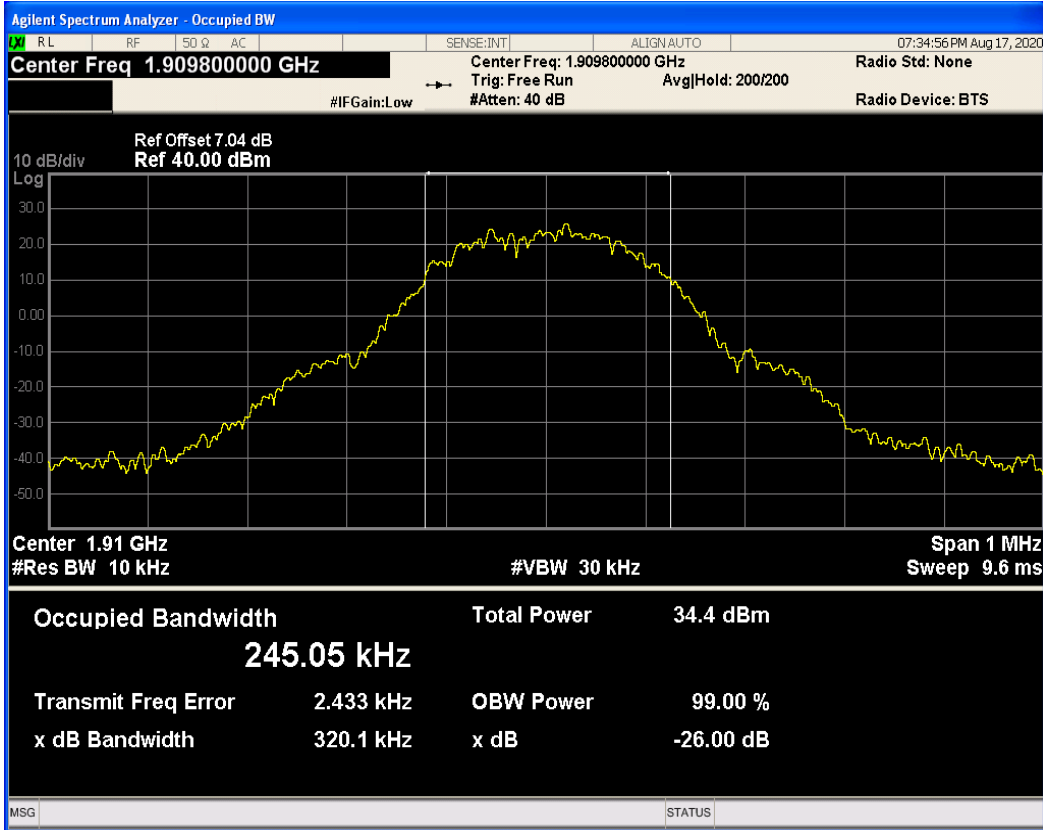

WCDMA Band2 Channel=9262

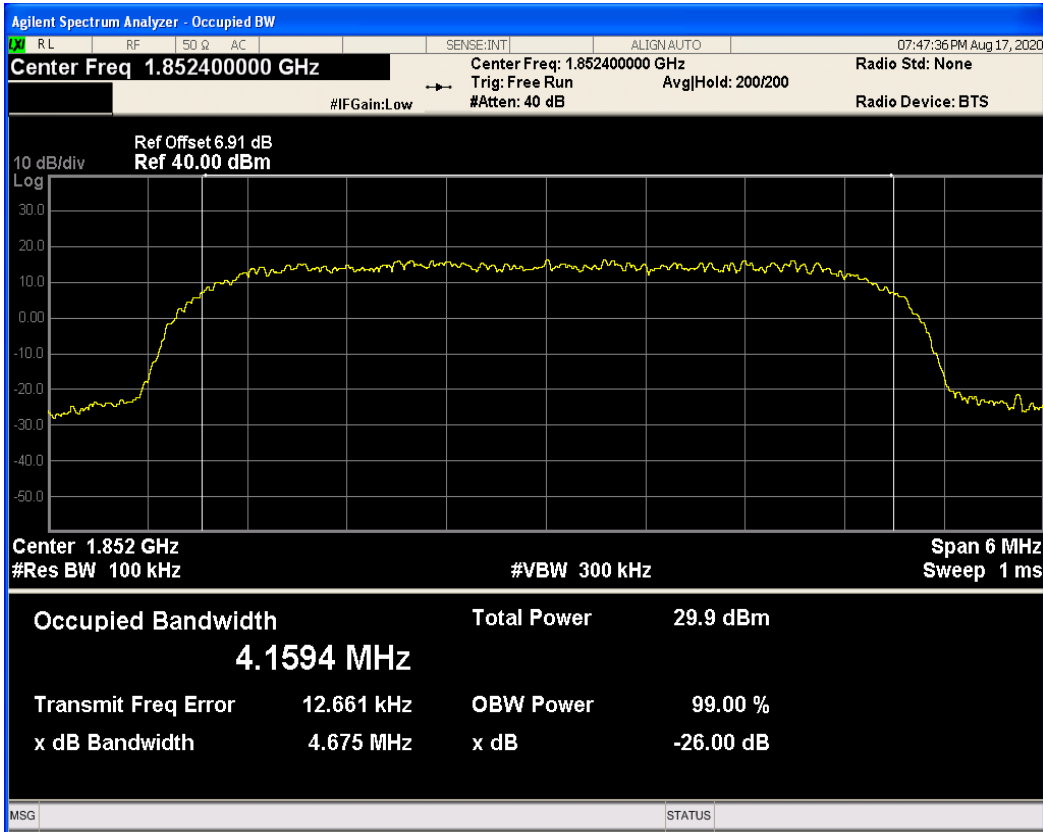

WCDMA Band2 Channel=9400

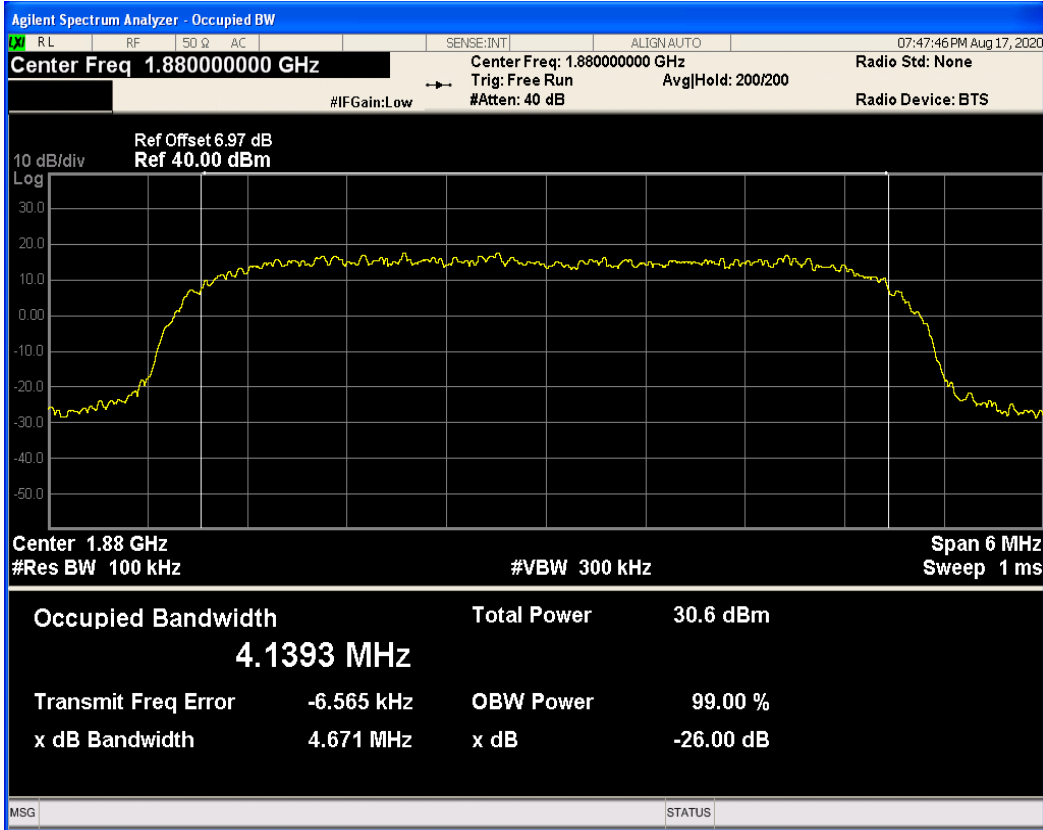

WCDMA Band2 Channel=9538

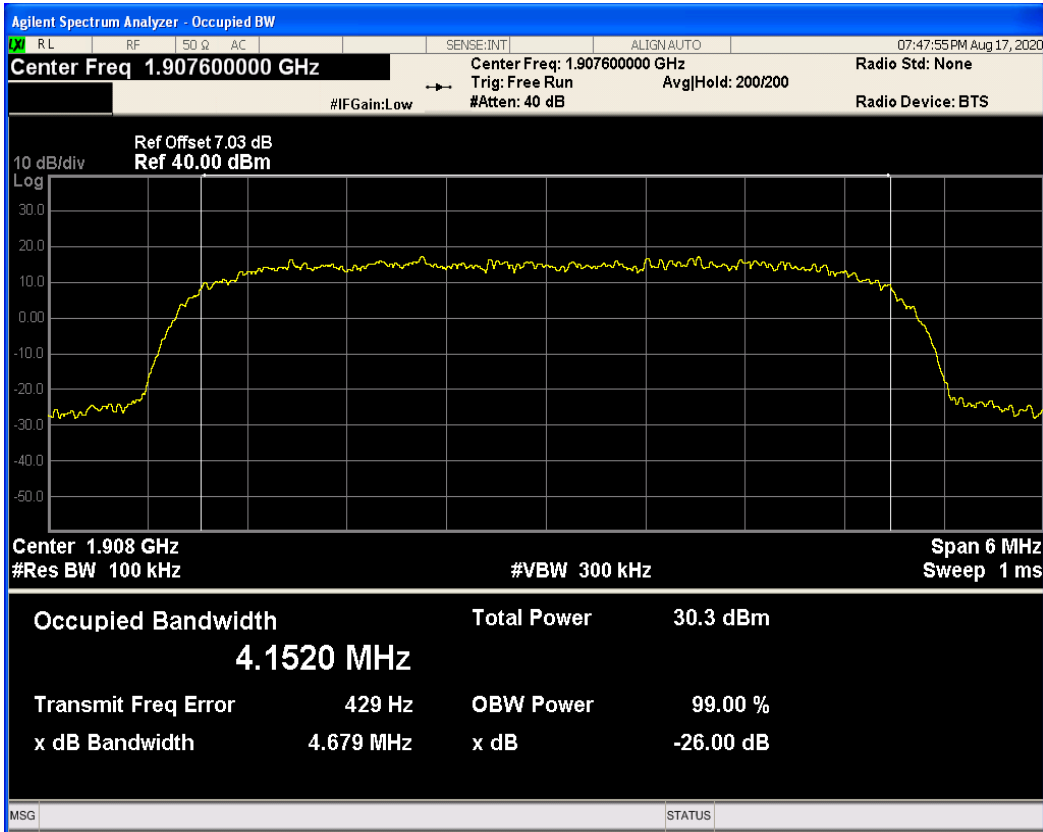

WCDMA Band5 Channel=4182

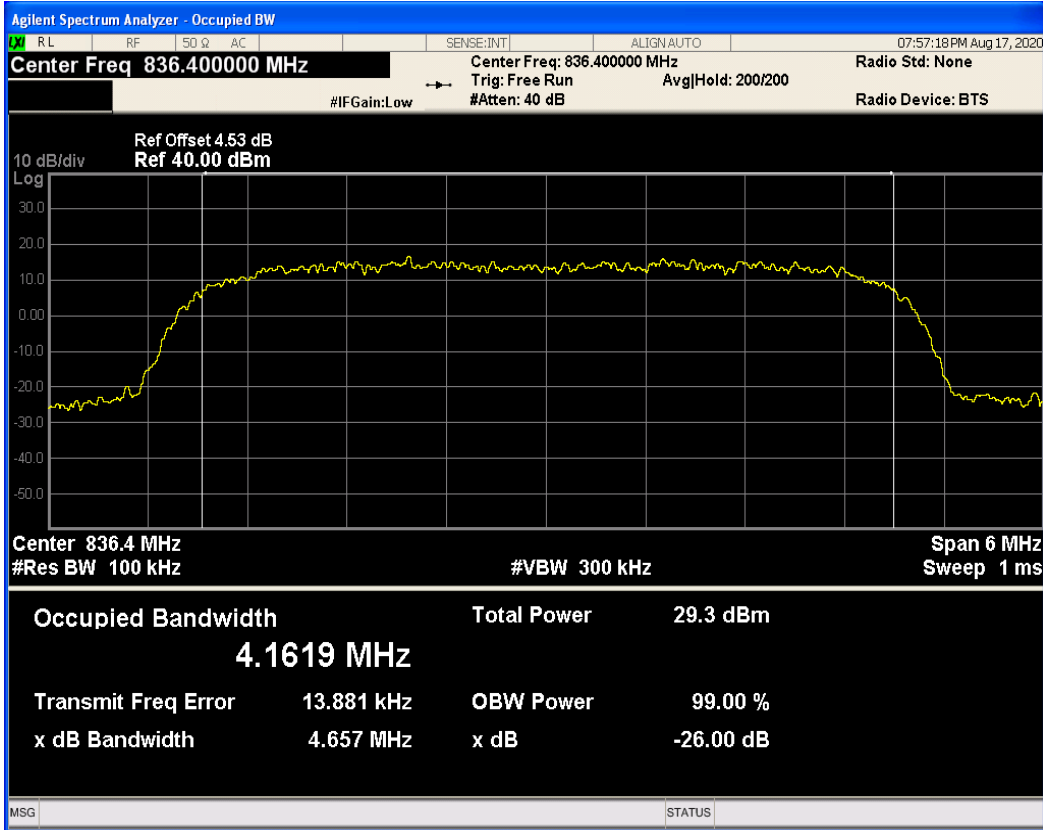

WCDMA Band5 Channel=4132

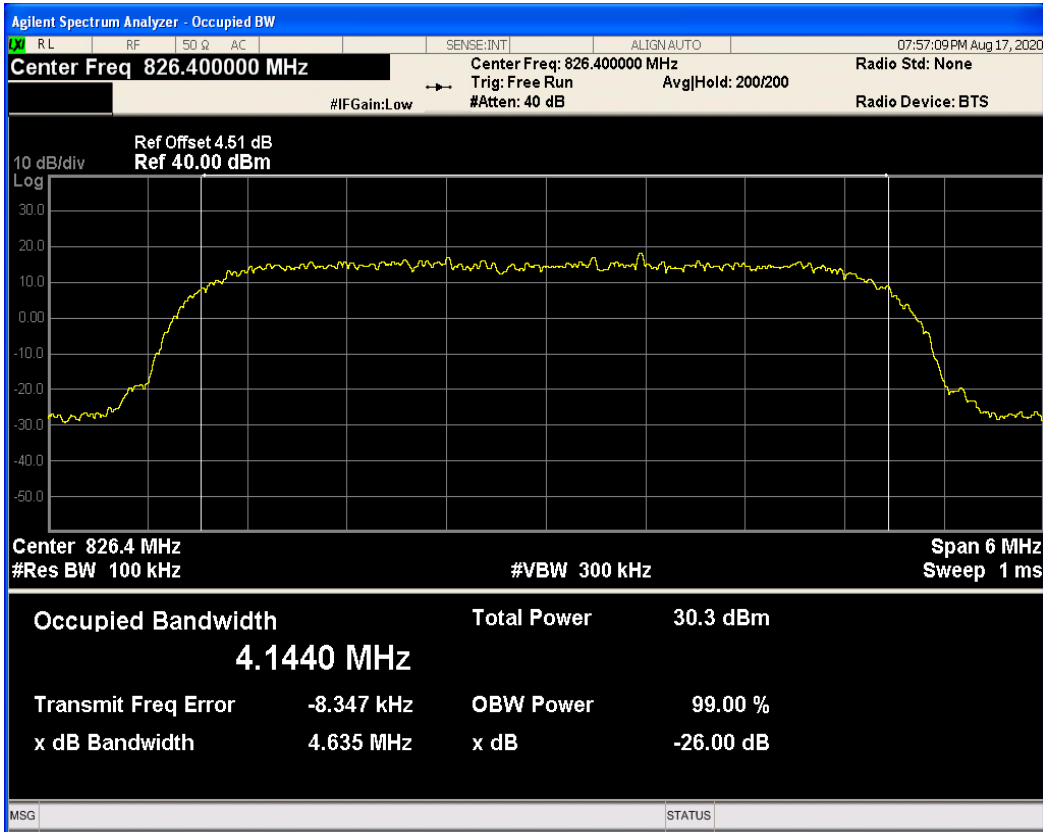

WCDMA Band5 Channel=4233

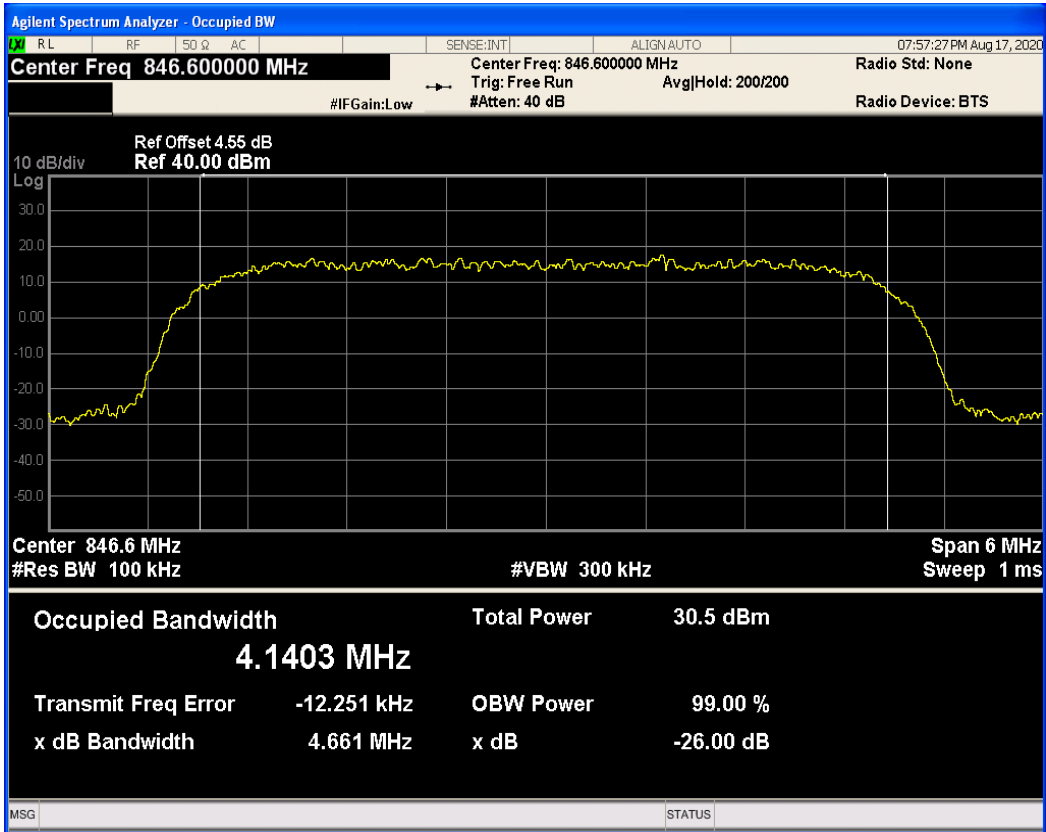

8.4 BAND EDGE

| Band | Channel | Frequency (MHz) | Spur Freq (MHz) | Spur Level (dBm) | Limit (dBm) | Verdict |
|-------------|---------|-----------------|-----------------|------------------|-------------|---------|
| GSM850 | 128 | 824.2 | 823.99 | -25.15 | -13 | PASS |
| GSM850 | 251 | 848.8 | 849.01 | -26.99 | -13 | PASS |
| GSM1900 | 512 | 1850.2 | 1849.98 | -30.19 | -13 | PASS |
| GSM1900 | 810 | 1909.8 | 1910.02 | -27.69 | -13 | PASS |
| GPRS850 | 128 | 824.2 | 823.98 | -25.24 | -13 | PASS |
| GPRS850 | 251 | 848.8 | 849.02 | -25.15 | -13 | PASS |
| GPRS1900 | 512 | 1850.2 | 1849.98 | -29.14 | -13 | PASS |
| GPRS1900 | 810 | 1909.8 | 1910.02 | -29.44 | -13 | PASS |
| WCDMA Band2 | 9262 | 1852.4 | 1849.93 | -32.03 | -13 | PASS |
| WCDMA Band2 | 9538 | 1907.6 | 1910.00 | -31.85 | -13 | PASS |
| WCDMA Band5 | 4132 | 826.4 | 824.00 | -26.09 | -13 | PASS |
| WCDMA Band5 | 4233 | 846.6 | 849.00 | -25.81 | -13 | PASS |

GSM850 Channel=128

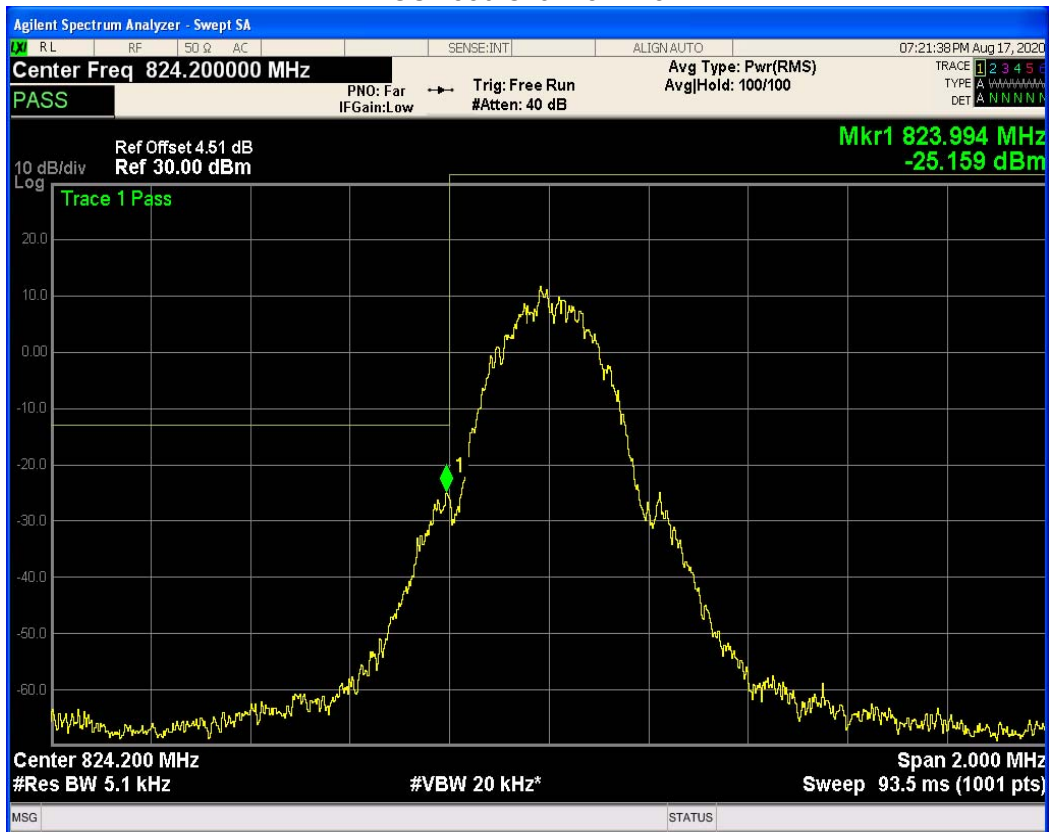

GSM850 Channel=251

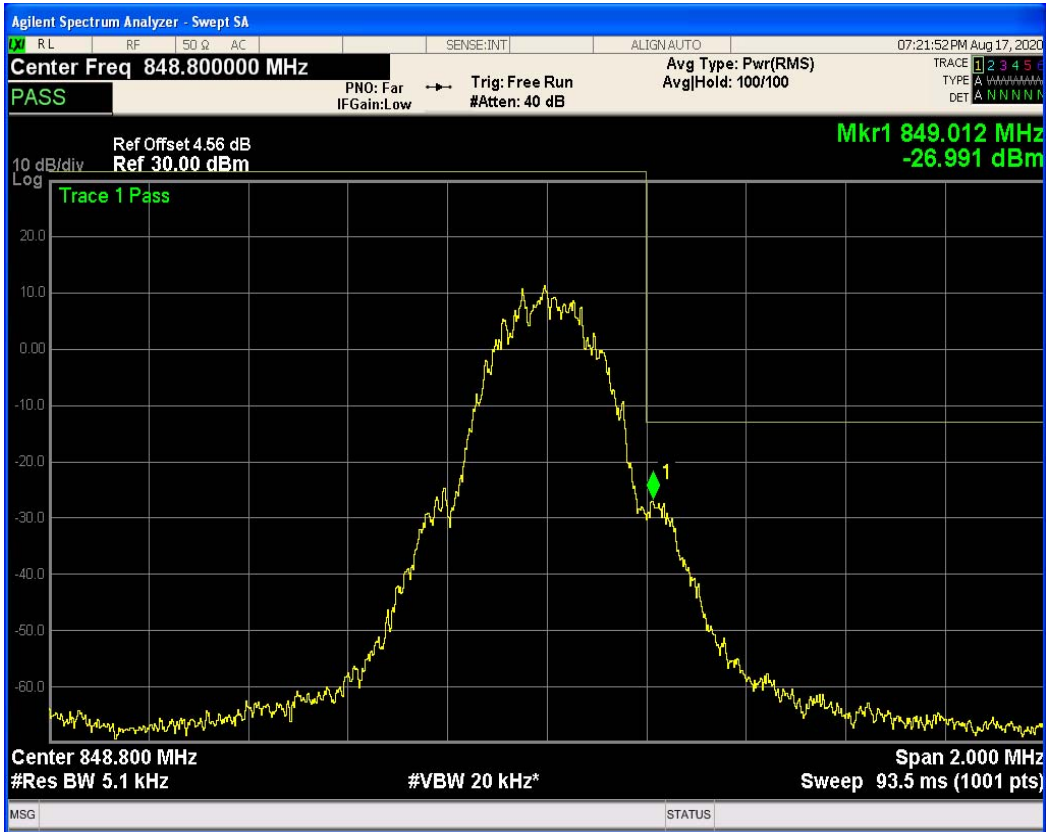

GSM1900 Channel=512

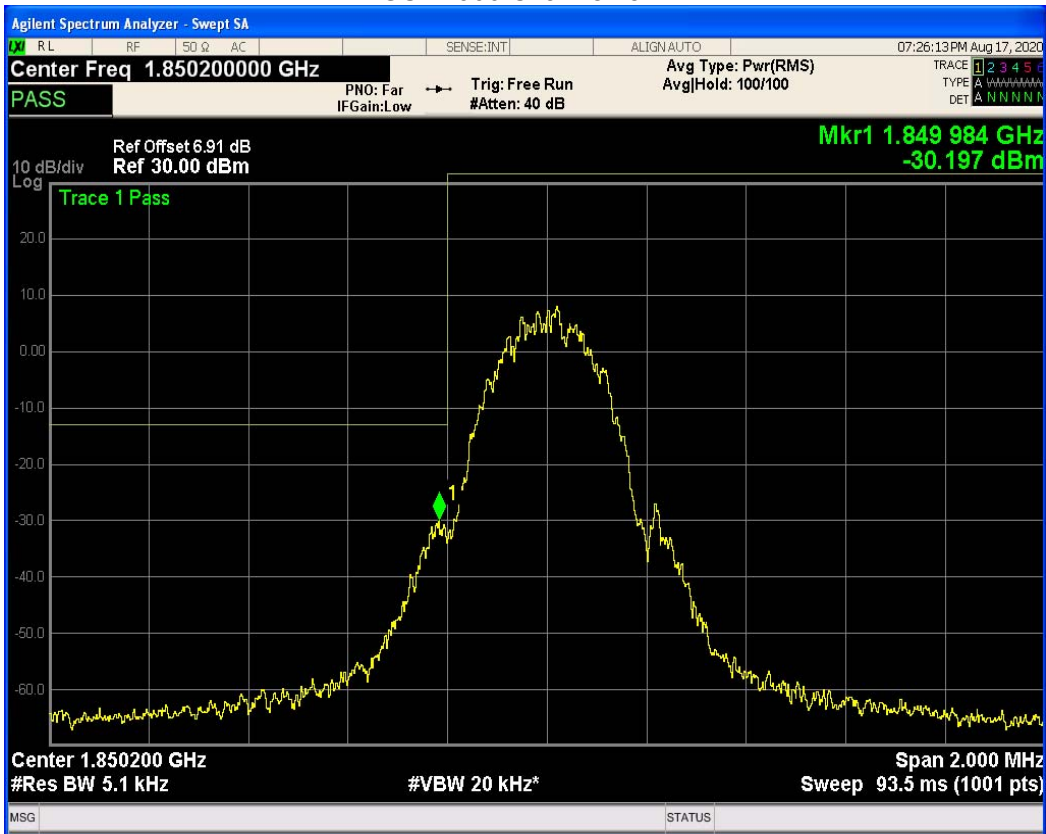

GSM1900 Channel=810

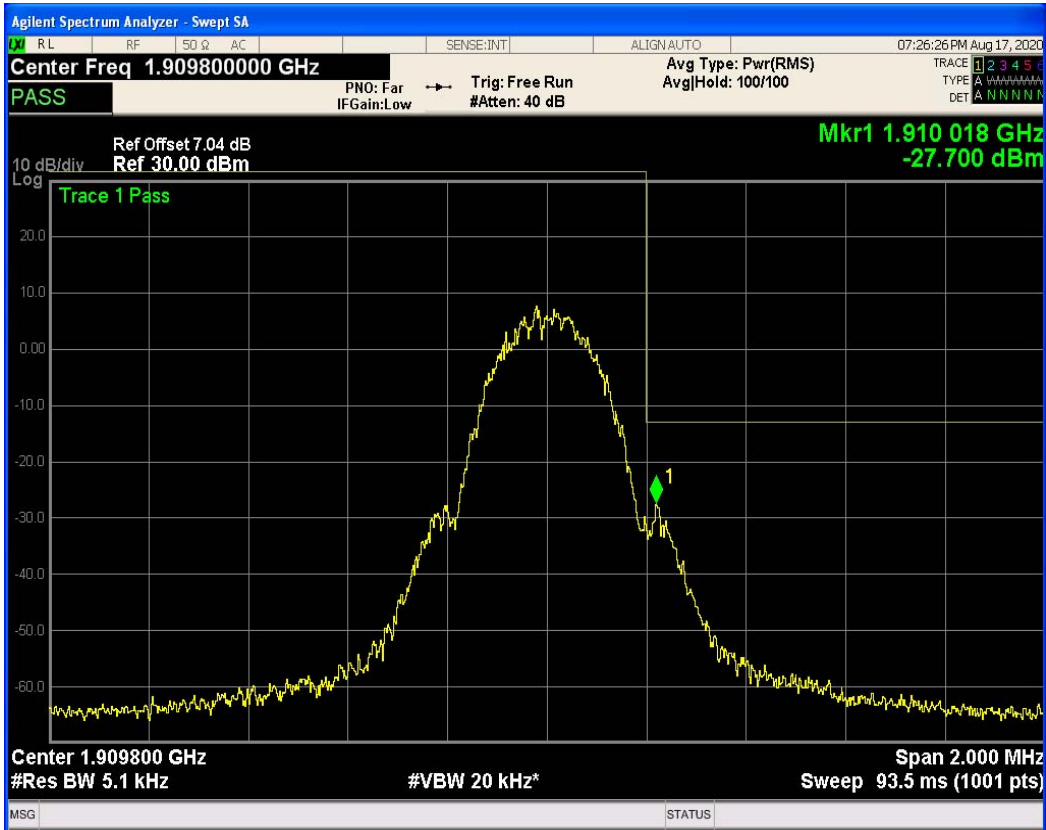

GPRS850 Channel=251

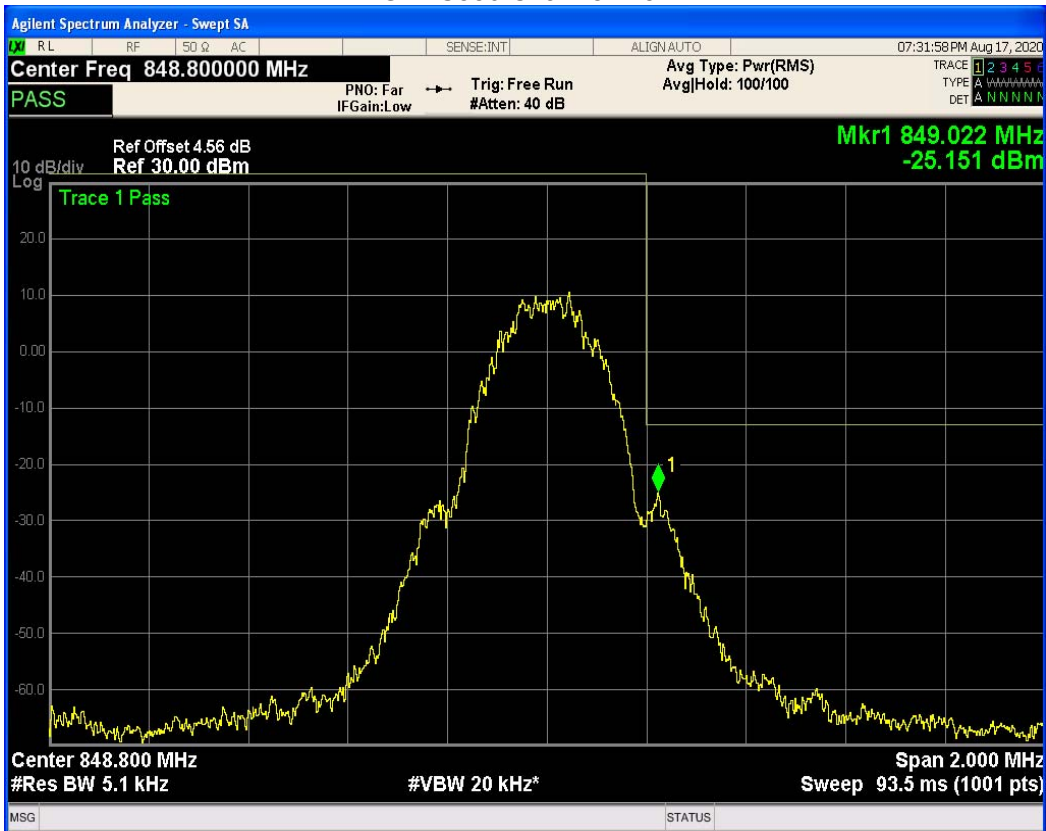

GPRS850 Channel=128

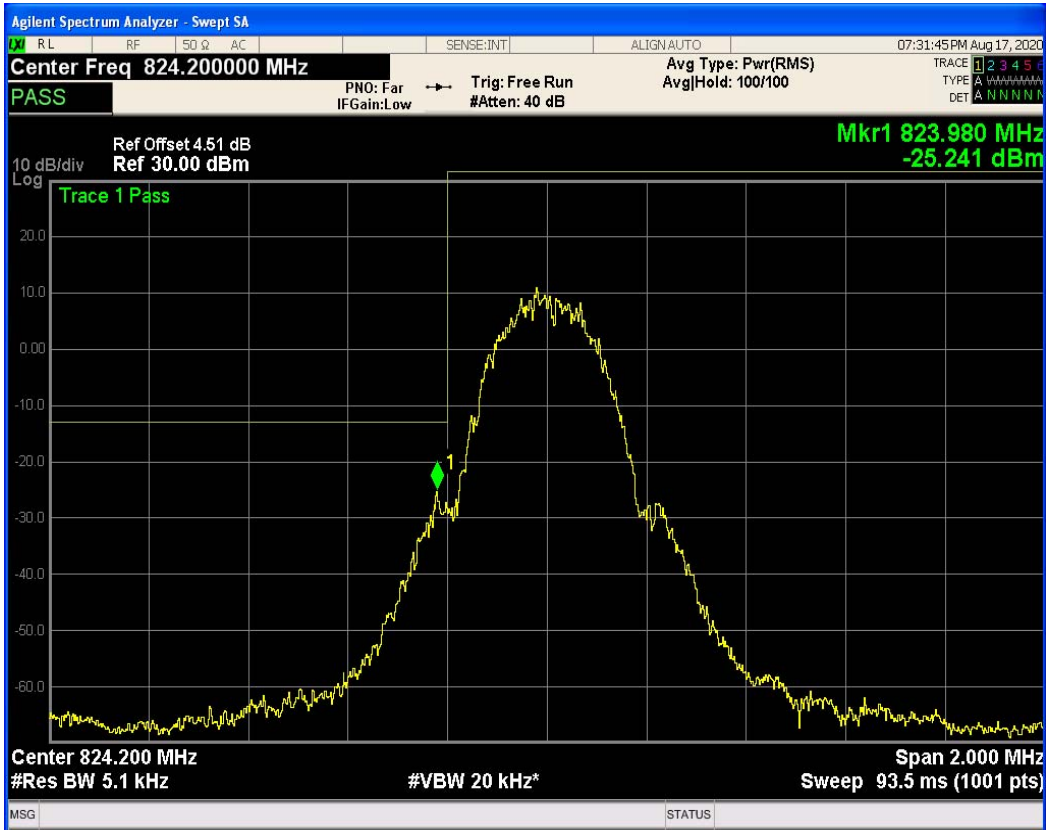

GPRS1900 Channel=810

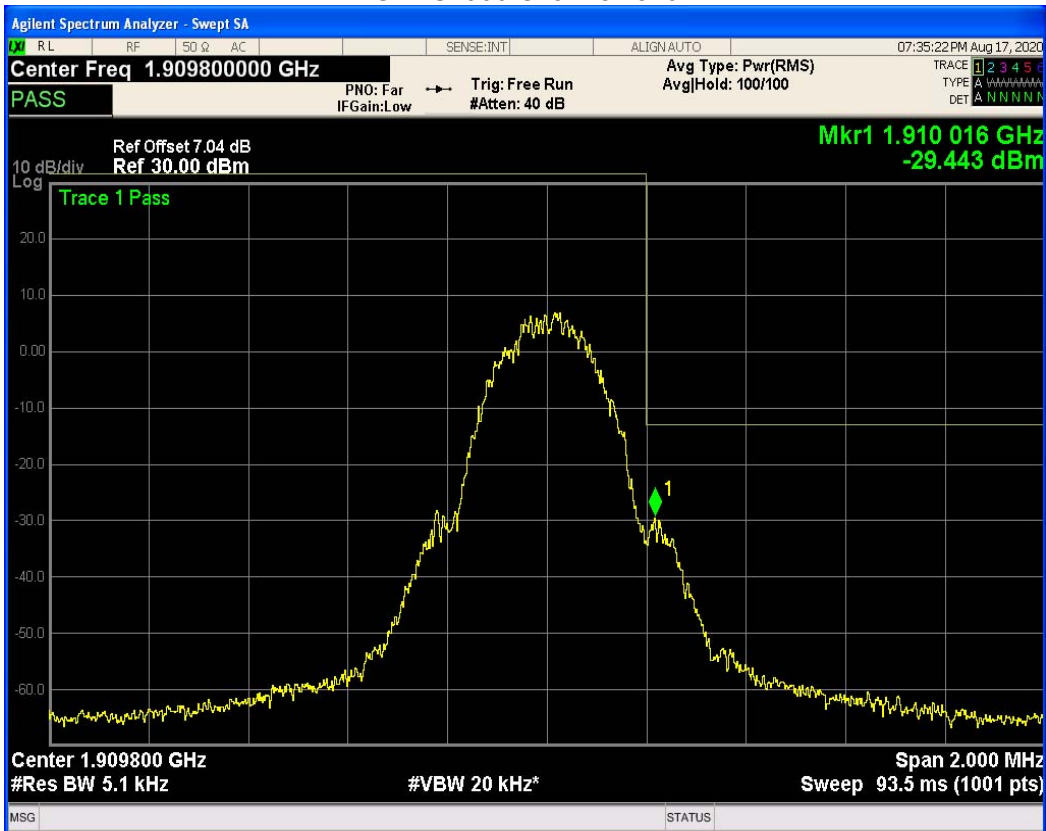

GPRS1900 Channel=512

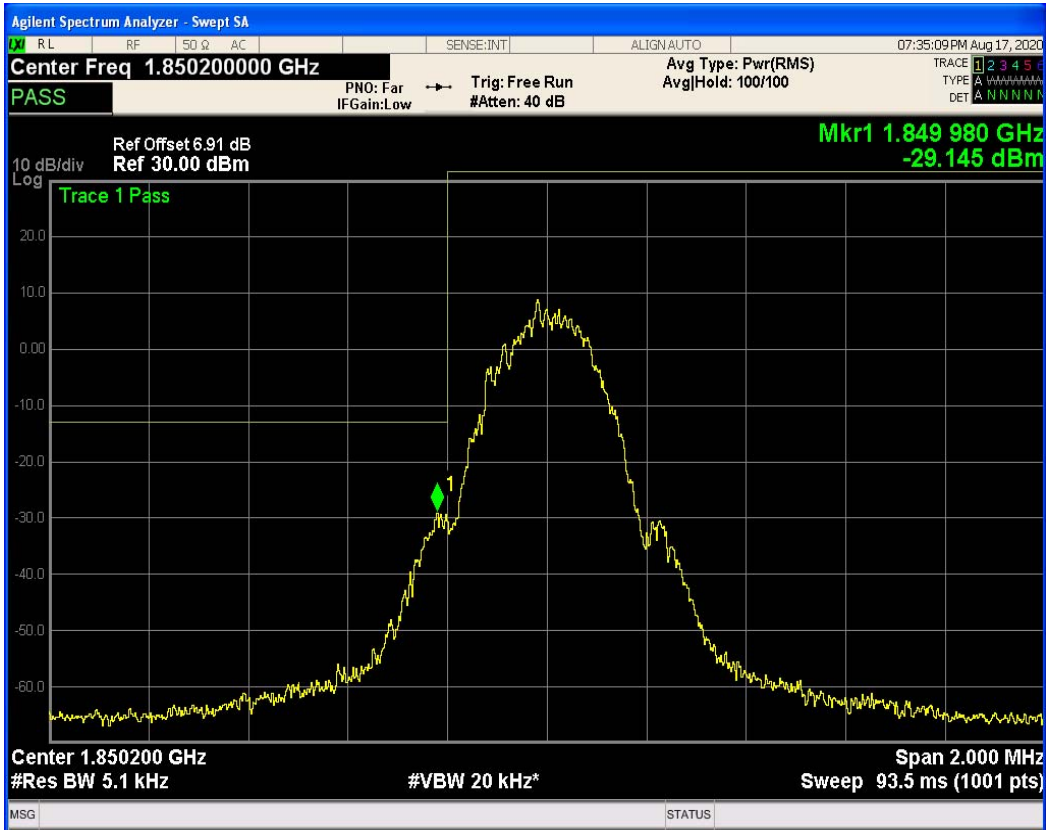

WCDMA Band2 Channel=9262

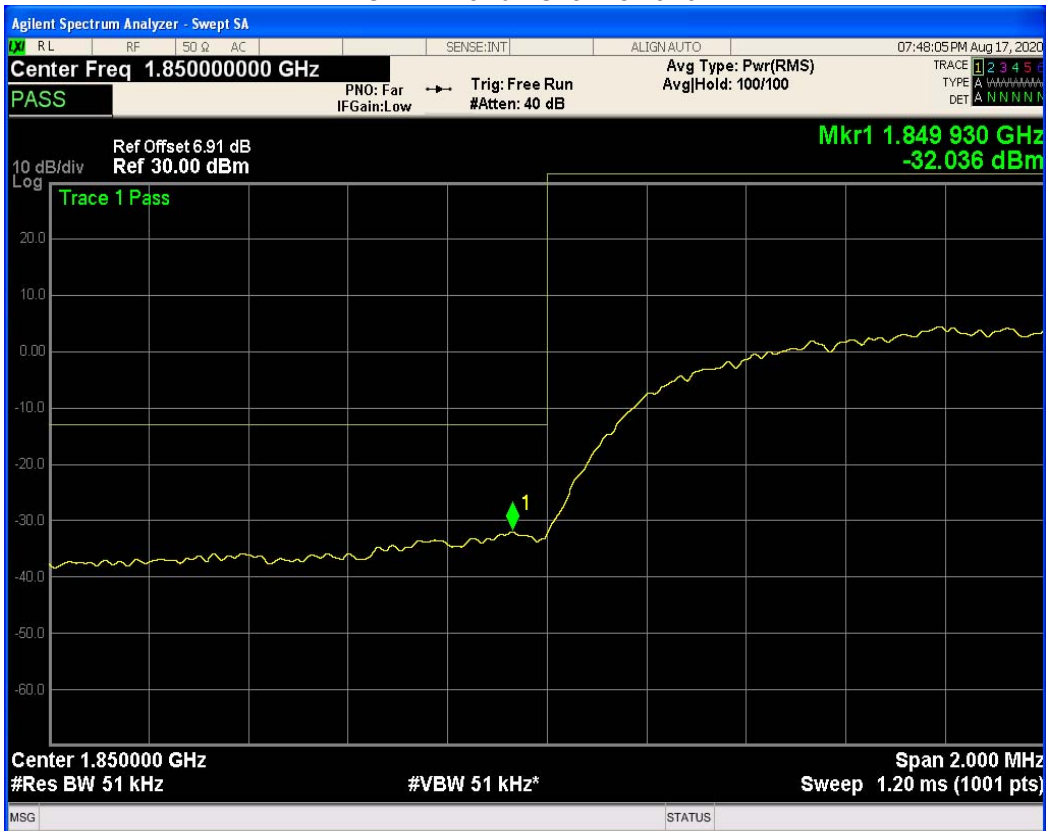

WCDMA Band2 Channel=9538



WCDMA Band5 Channel=4132

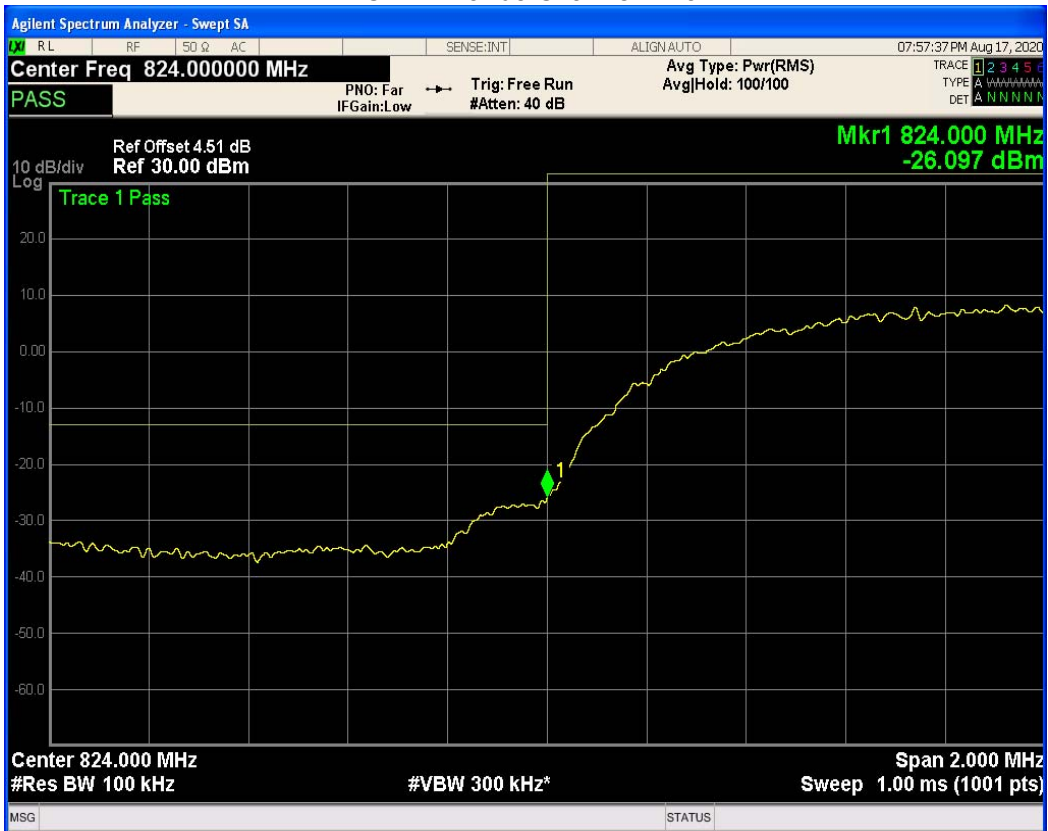

WCDMA Band5 Channel=4233

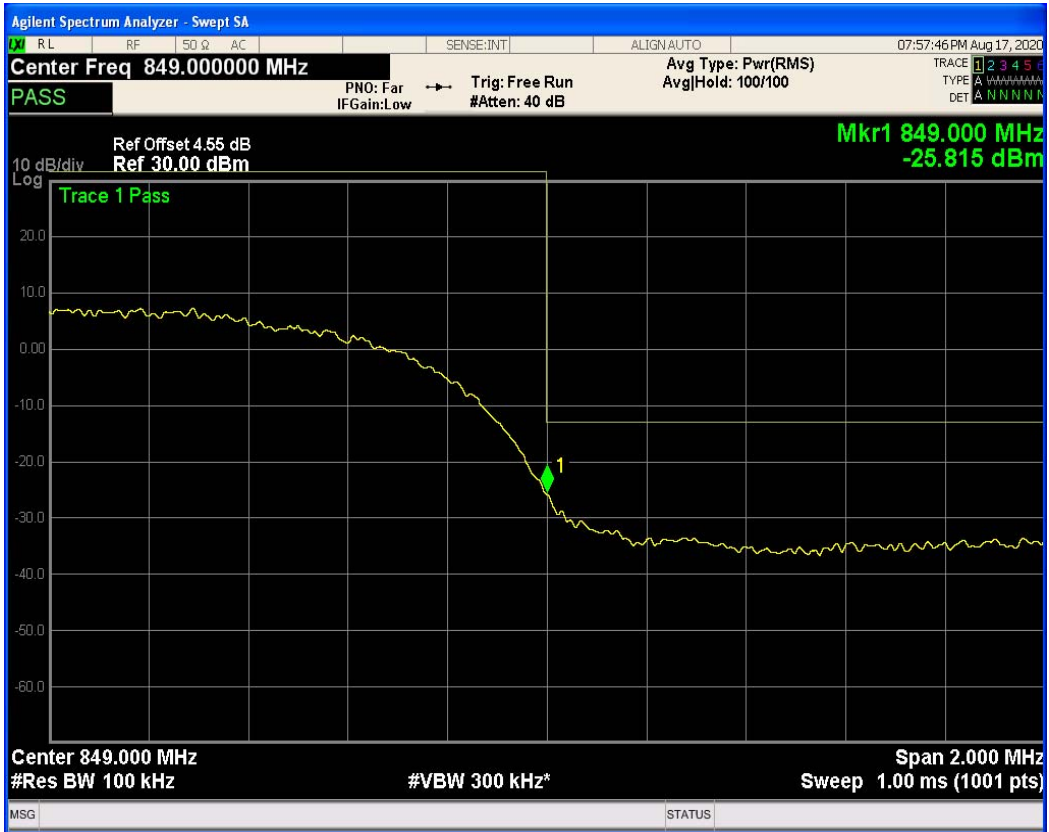

8.5 OUT-OF-BAND EMISSIONS

| Band | Channel | Frequency (MHz) | Spur Freq (MHz) | Spur Level (dBm) | Limit (dBm) | Verdict |
|-------------|---------|-----------------|-----------------|------------------|-------------|---------|
| GSM850 | 128 | 824.2 | 3136.90 | -31.40 | -13 | PASS |
| GSM850 | 189 | 836.4 | 1673.06 | -29.64 | -13 | PASS |
| GSM850 | 251 | 848.8 | 3162.57 | -30.18 | -13 | PASS |
| GSM1900 | 512 | 1850.2 | 17093.87 | -24.48 | -13 | PASS |
| GSM1900 | 661 | 1880 | 18006.99 | -25.10 | -13 | PASS |
| GSM1900 | 810 | 1909.8 | 19908.14 | -23.97 | -13 | PASS |
| GPRS850 | 128 | 824.2 | 1648.88 | -30.85 | -13 | PASS |
| GPRS850 | 189 | 836.4 | 3293.43 | -31.28 | -13 | PASS |
| GPRS850 | 251 | 848.8 | 3176.53 | -31.57 | -13 | PASS |
| GPRS1900 | 512 | 1850.2 | 17861.21 | -25.24 | -13 | PASS |
| GPRS1900 | 661 | 1880 | 19930.11 | -24.40 | -13 | PASS |
| GPRS1900 | 810 | 1909.8 | 19896.66 | -24.64 | -13 | PASS |
| WCDMA Band2 | 9262 | 1852.4 | 19921.62 | -25.09 | -13 | PASS |
| WCDMA Band2 | 9400 | 1880 | 19777.83 | -25.17 | -13 | PASS |
| WCDMA Band2 | 9538 | 1907.6 | 19946.58 | -24.75 | -13 | PASS |
| WCDMA Band5 | 4132 | 826.4 | 3312.62 | -30.48 | -13 | PASS |
| WCDMA Band5 | 4182 | 836.4 | 3024.99 | -30.51 | -13 | PASS |
| WCDMA Band5 | 4233 | 846.6 | 3007.04 | -32.26 | -13 | PASS |

GSM850 Channel=128

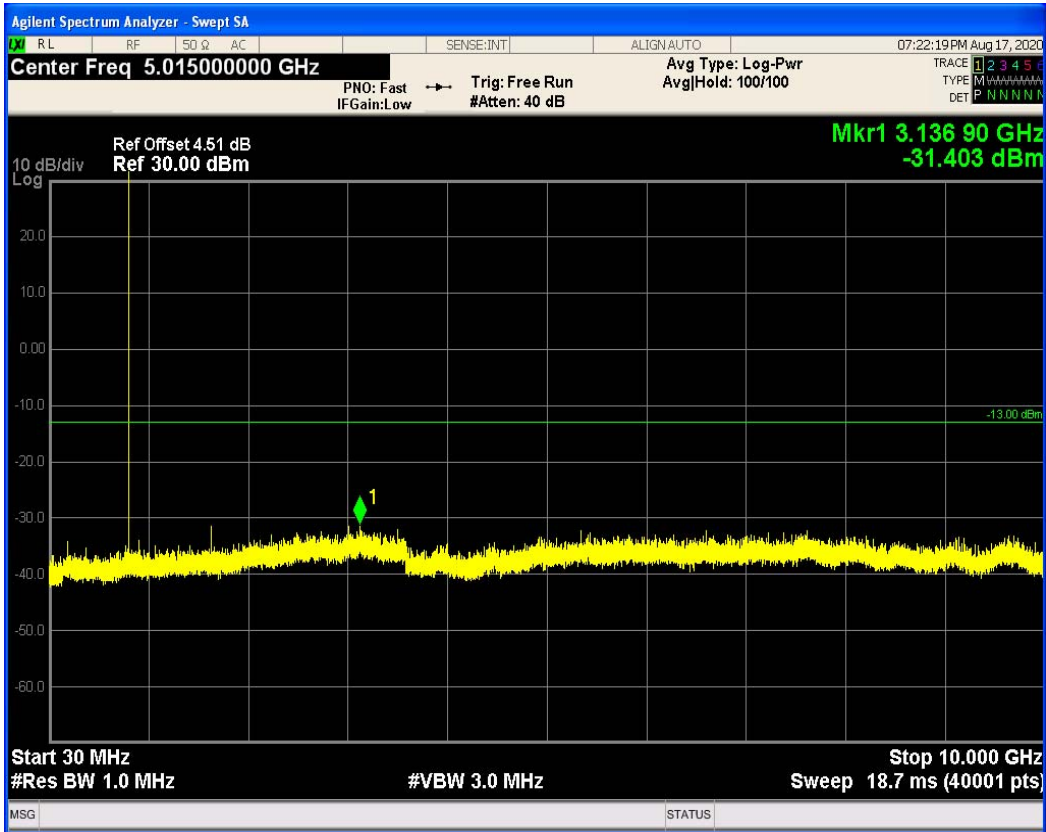

GSM850 Channel=189

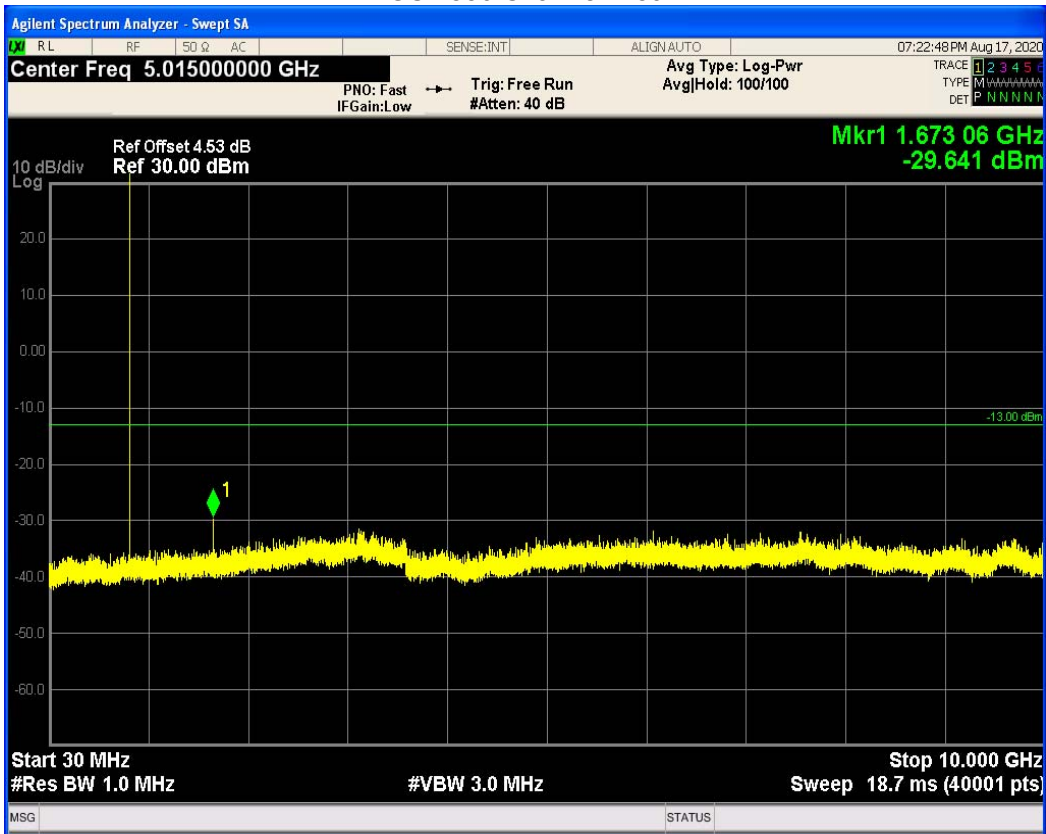

GSM850 Channel=251

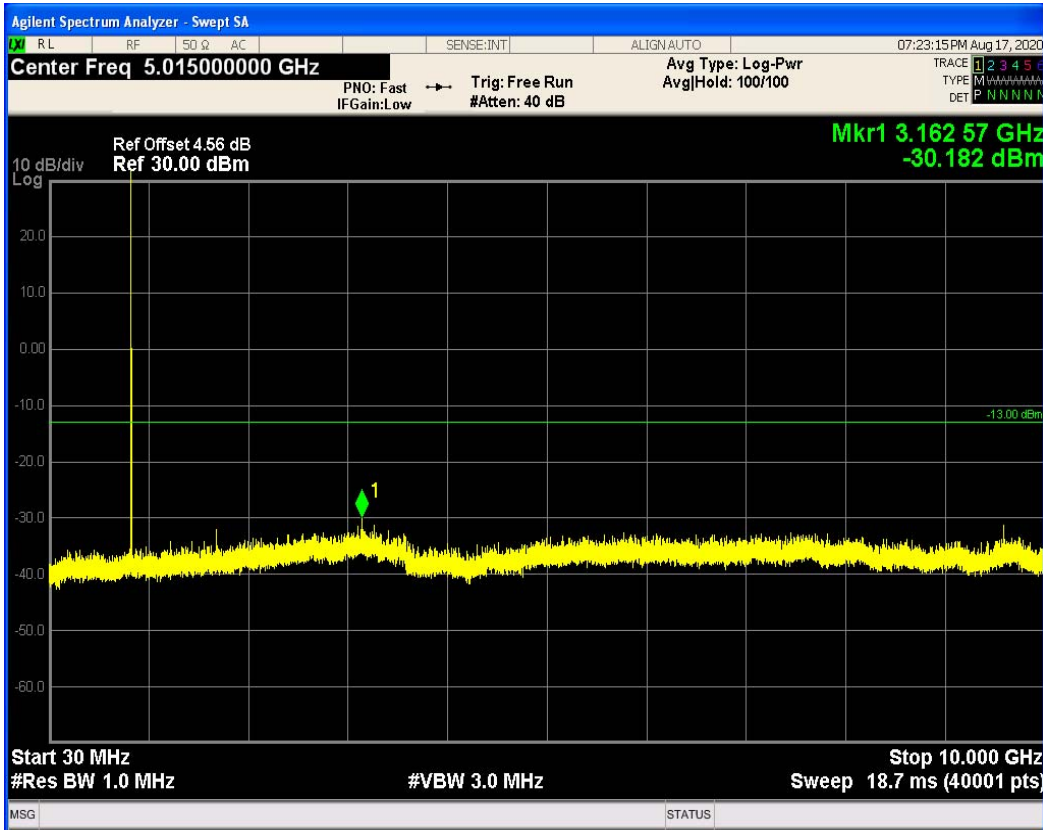

GSM1900 Channel=512

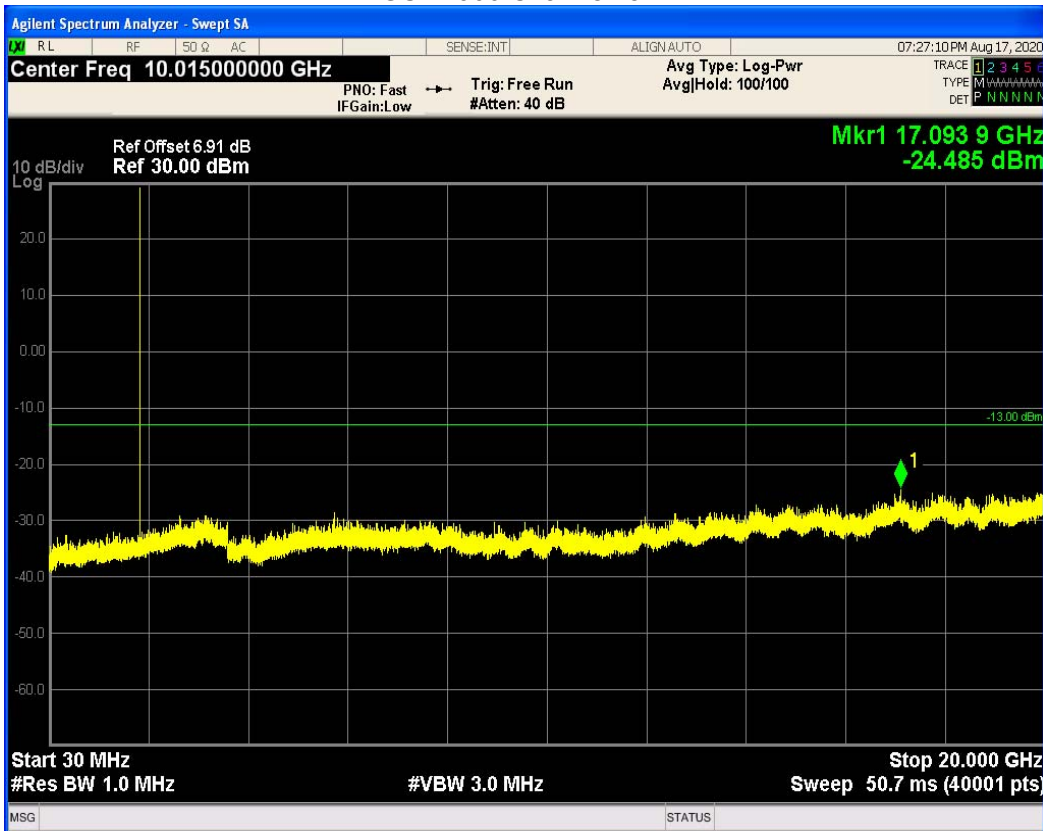

GSM1900 Channel=810

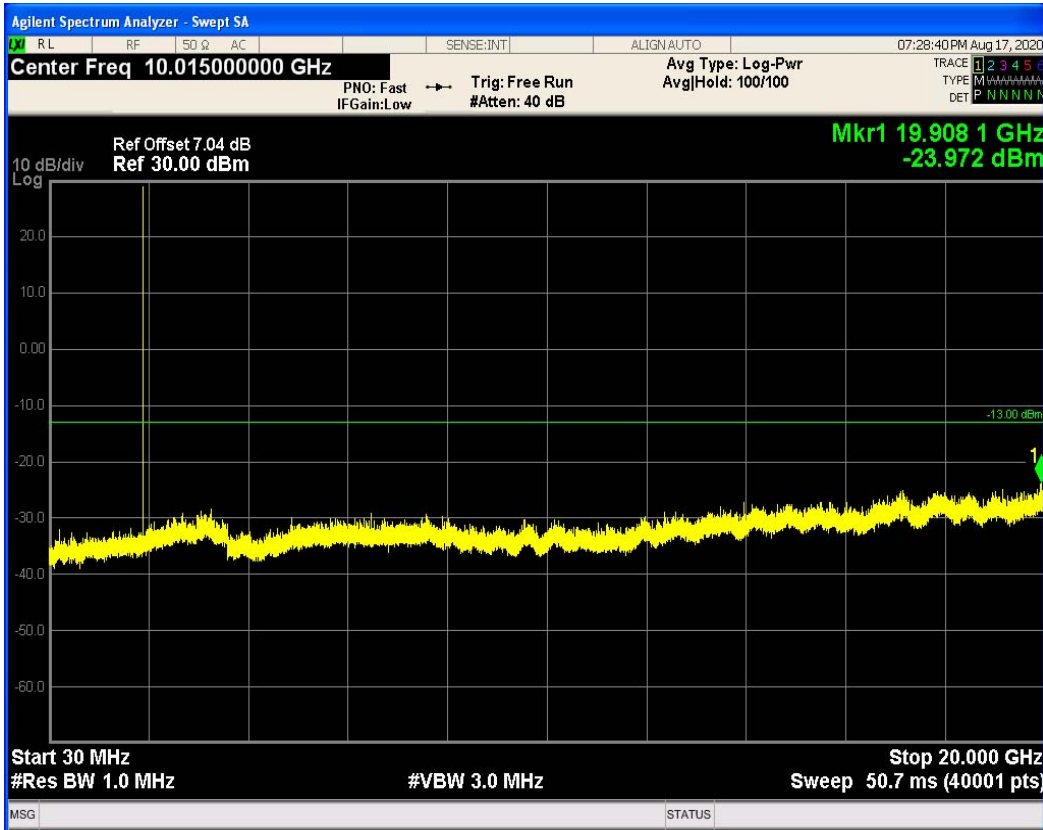

GSM1900 Channel=661

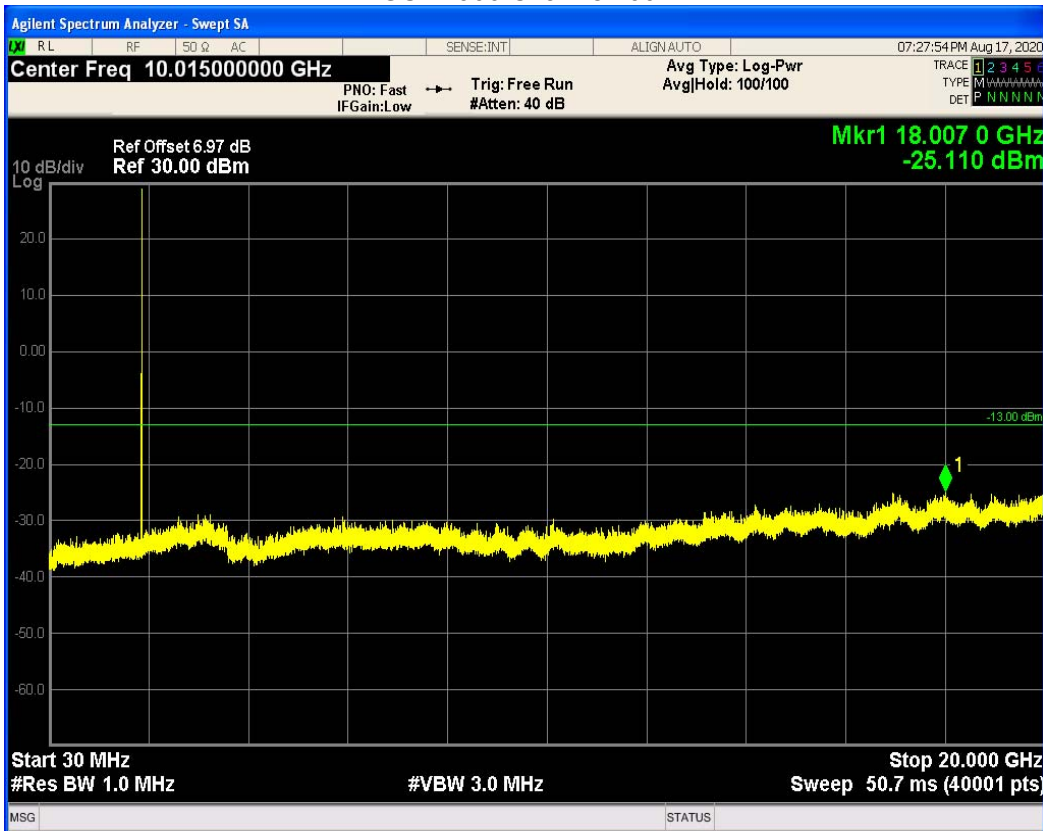

GPRS850 Channel=128

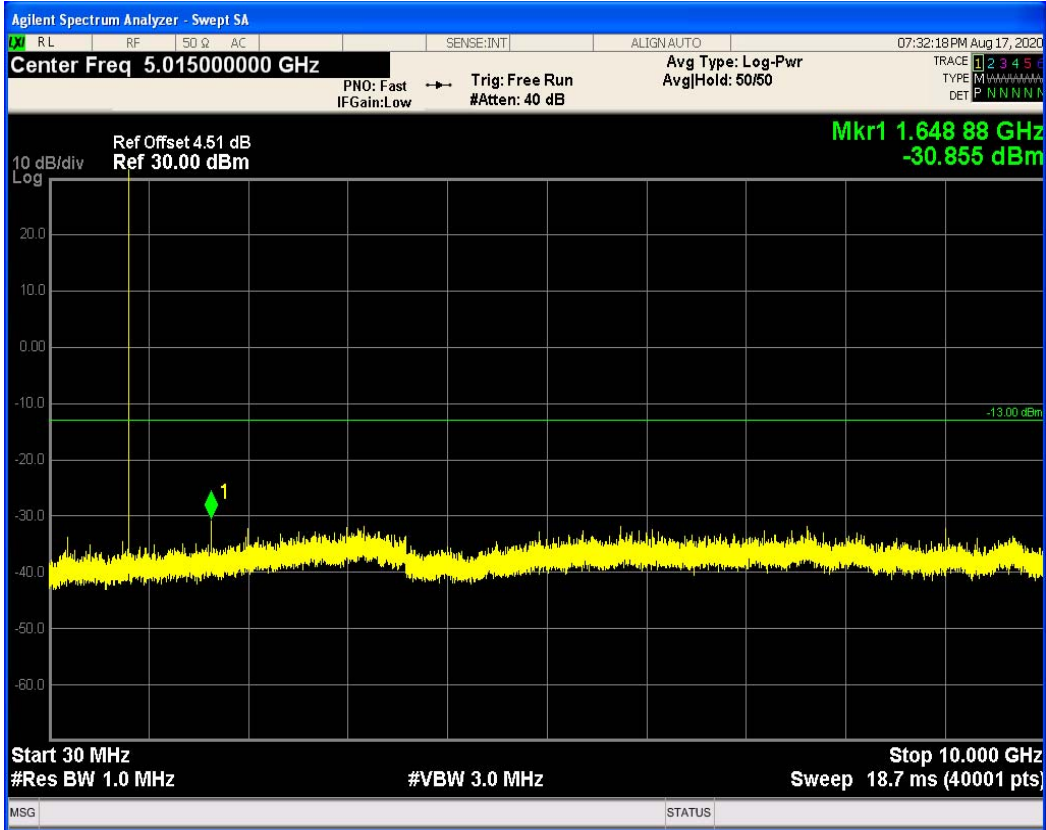

GPRS850 Channel=189

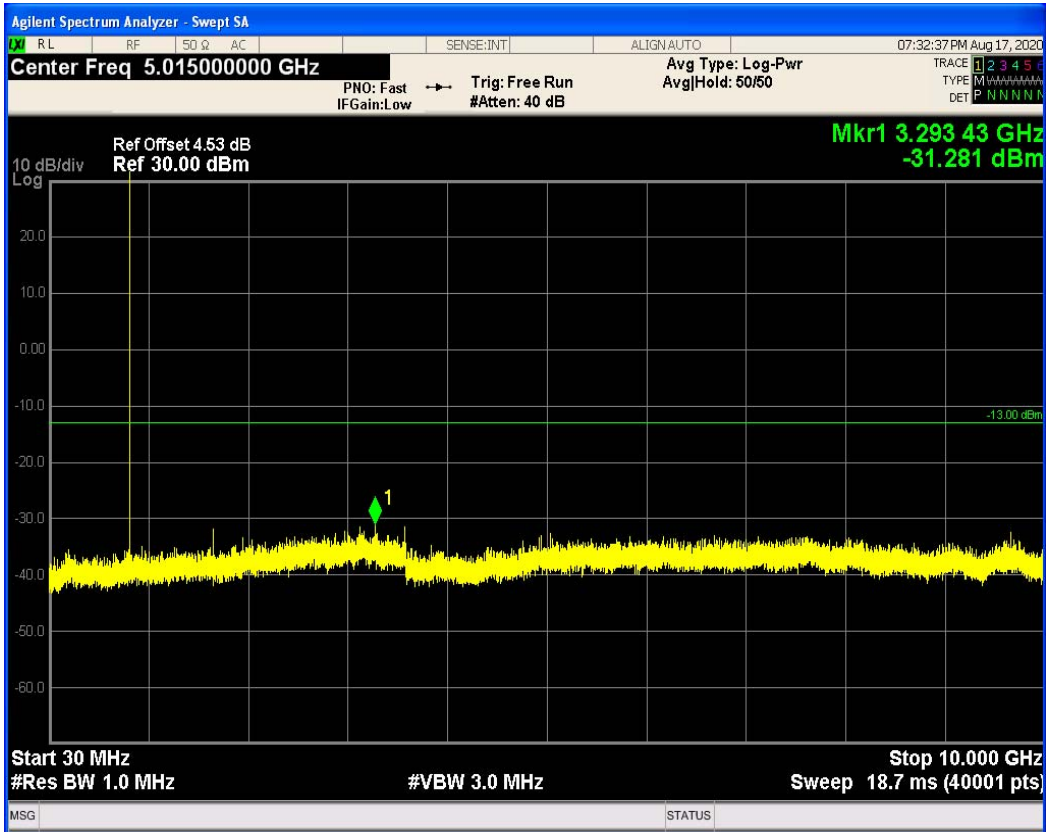

GPRS850 Channel=251

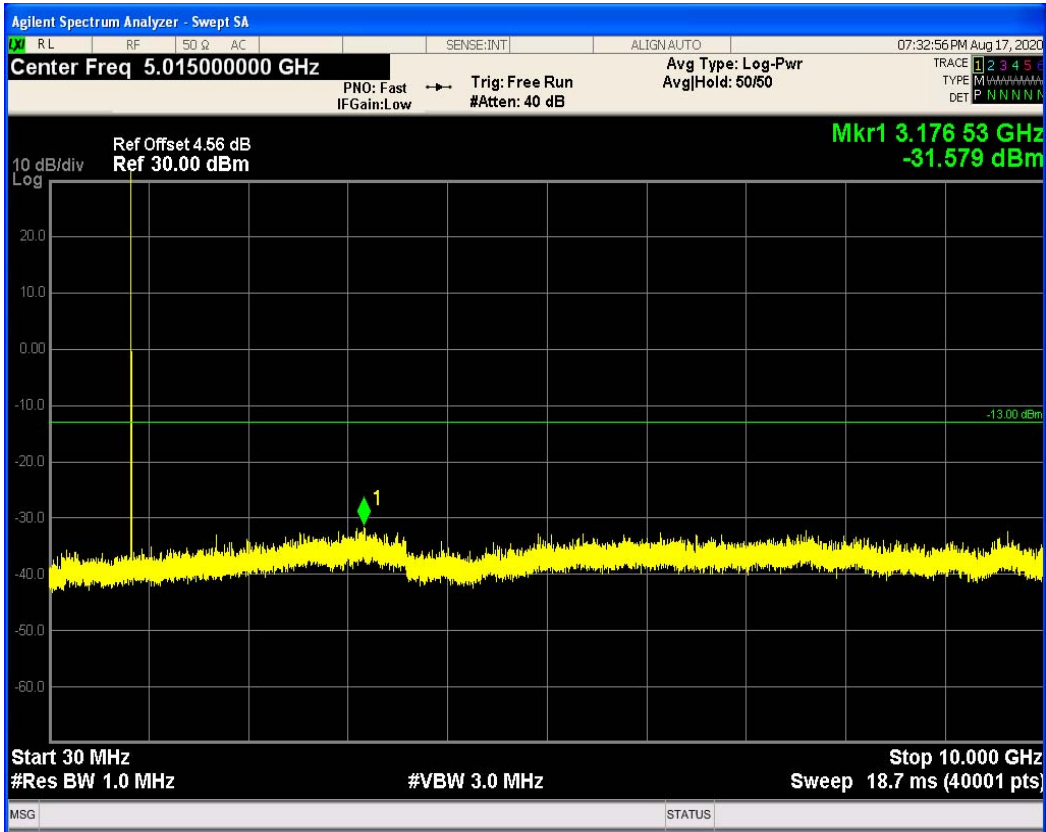

GPRS1900 Channel=512

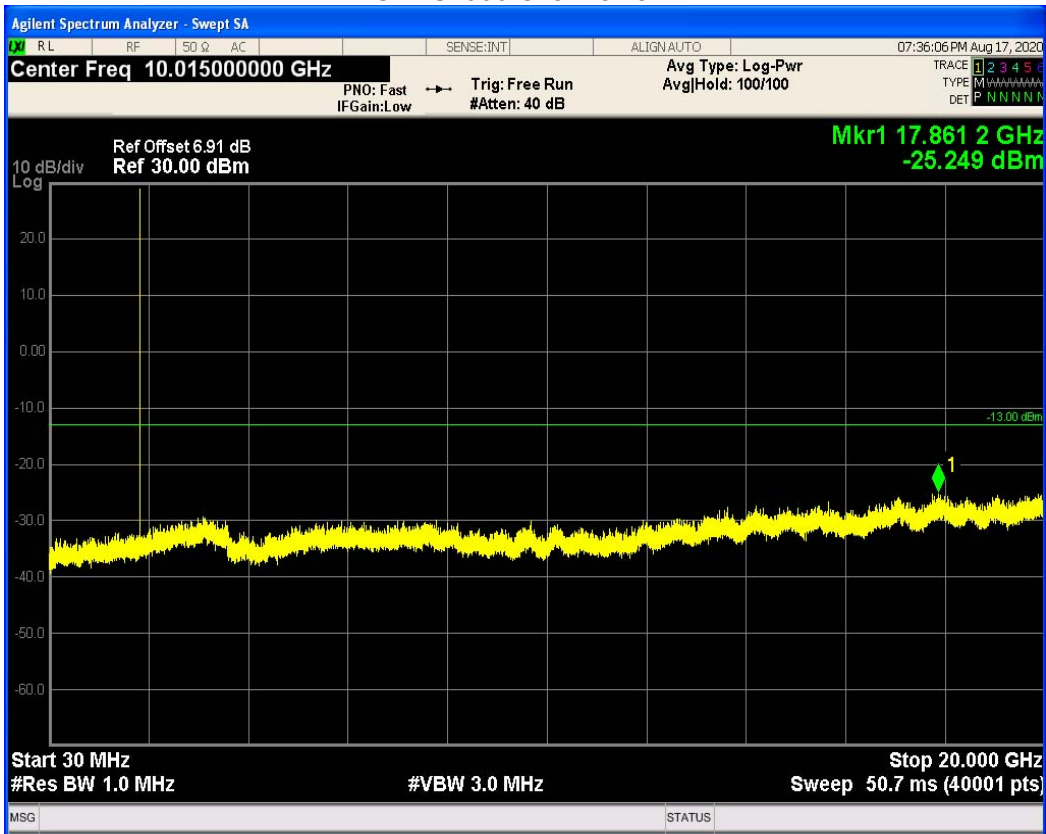

GPRS1900 Channel=810

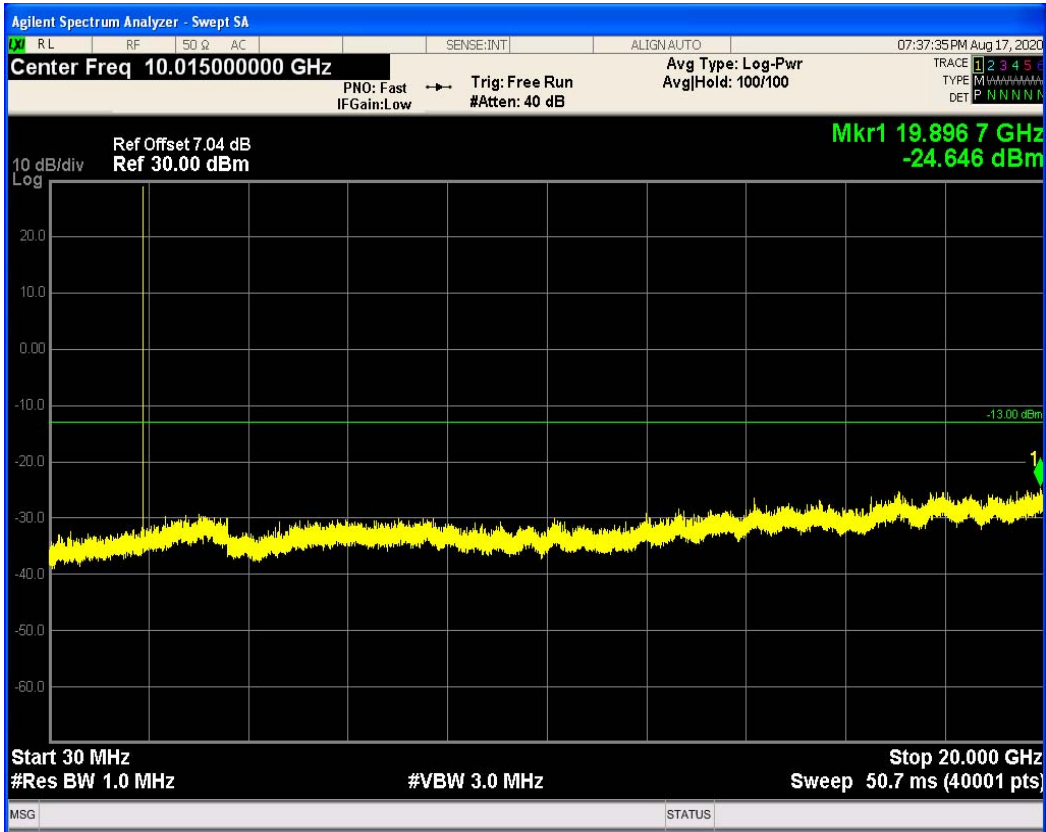

GPRS1900 Channel=661

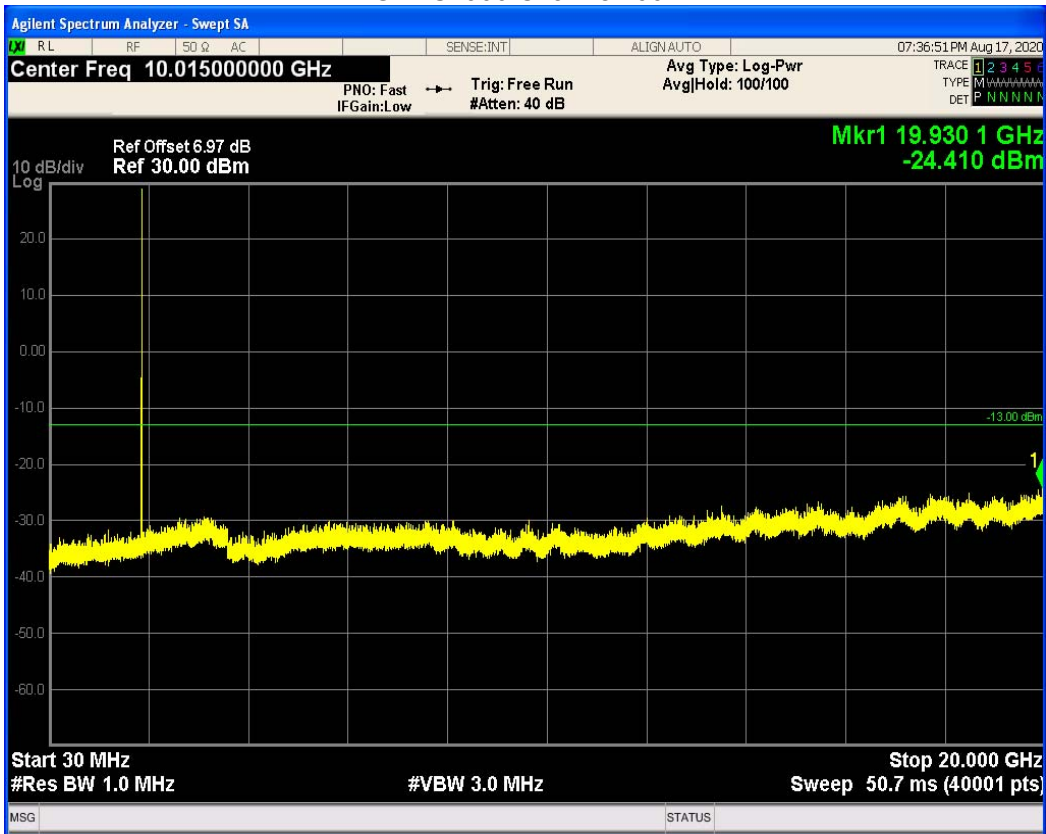

WCDMA Band2 Channel=9262

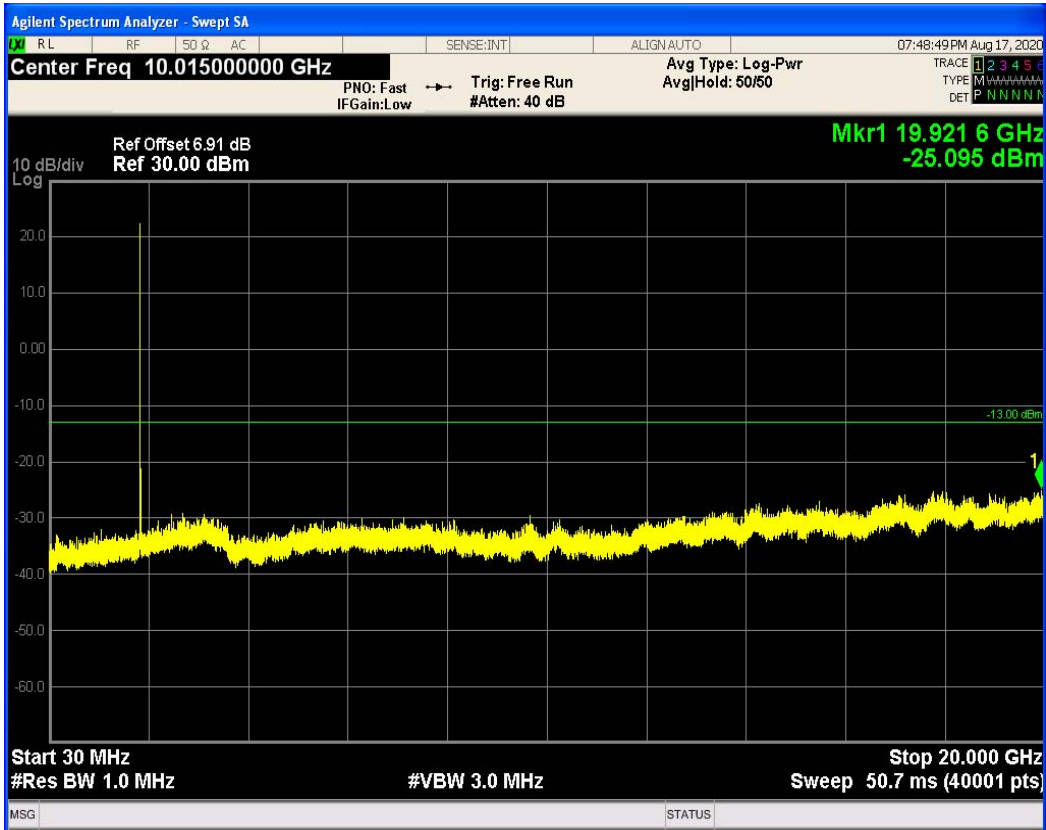

WCDMA Band2 Channel=9400

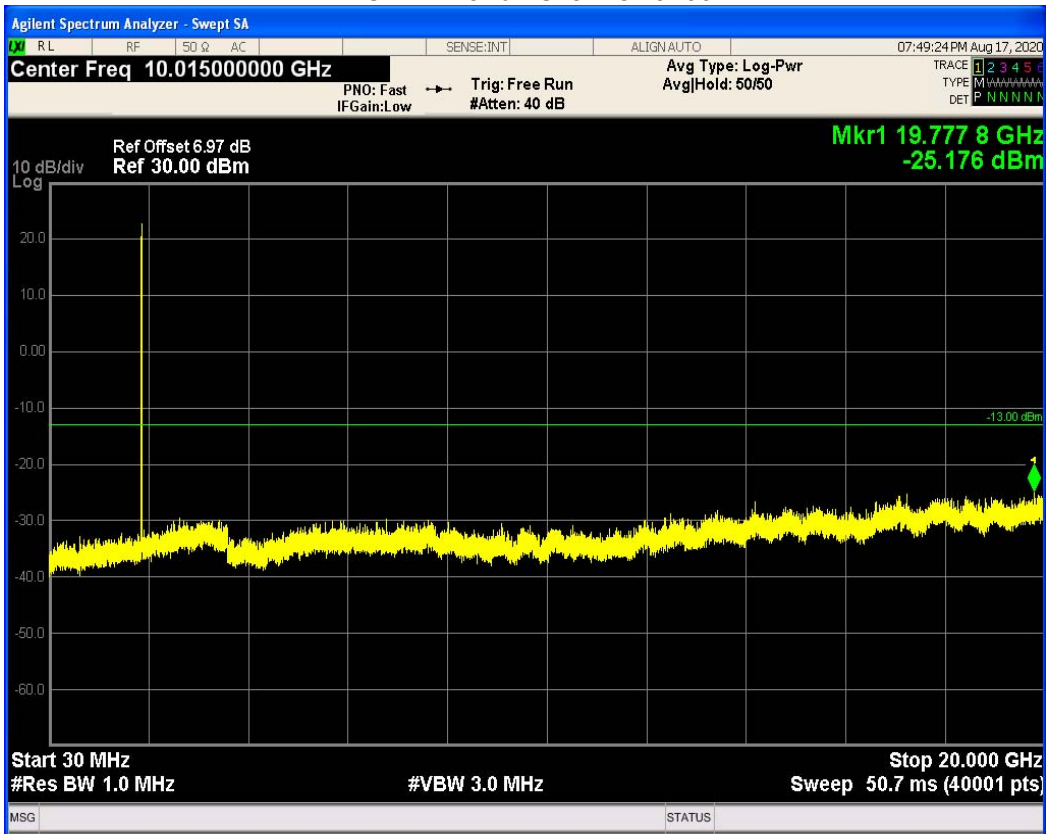

WCDMA Band2 Channel=9538

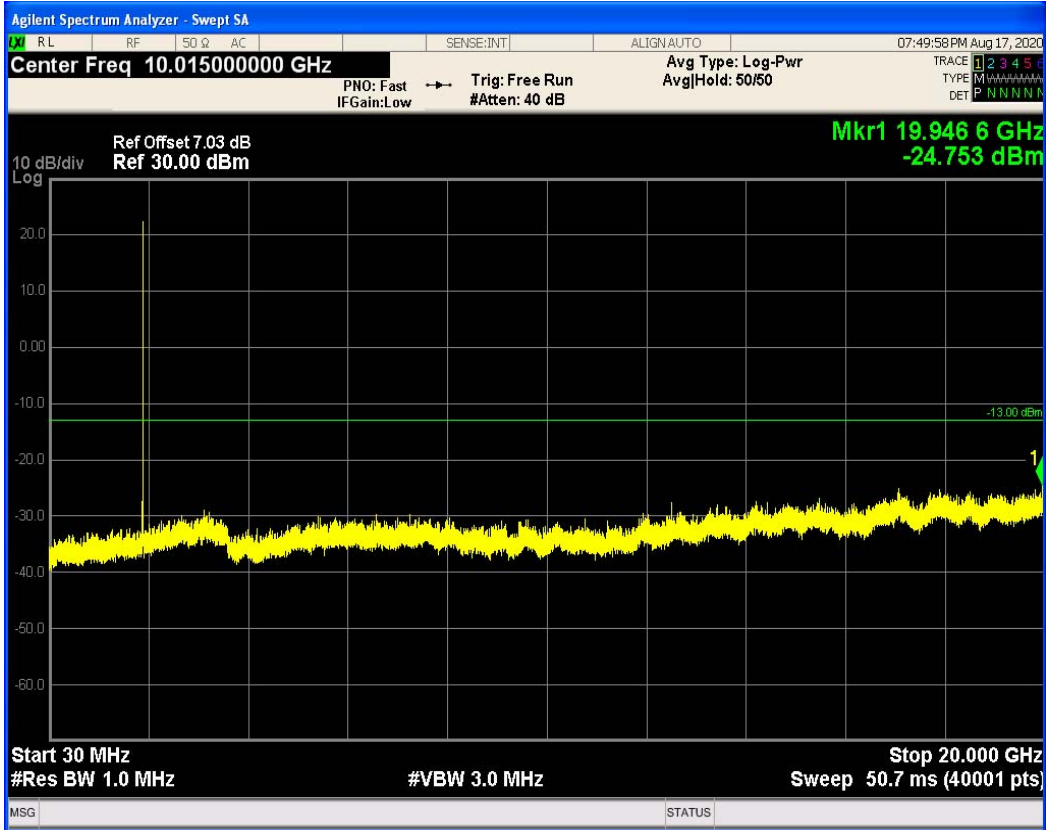

WCDMA Band5 Channel=4132

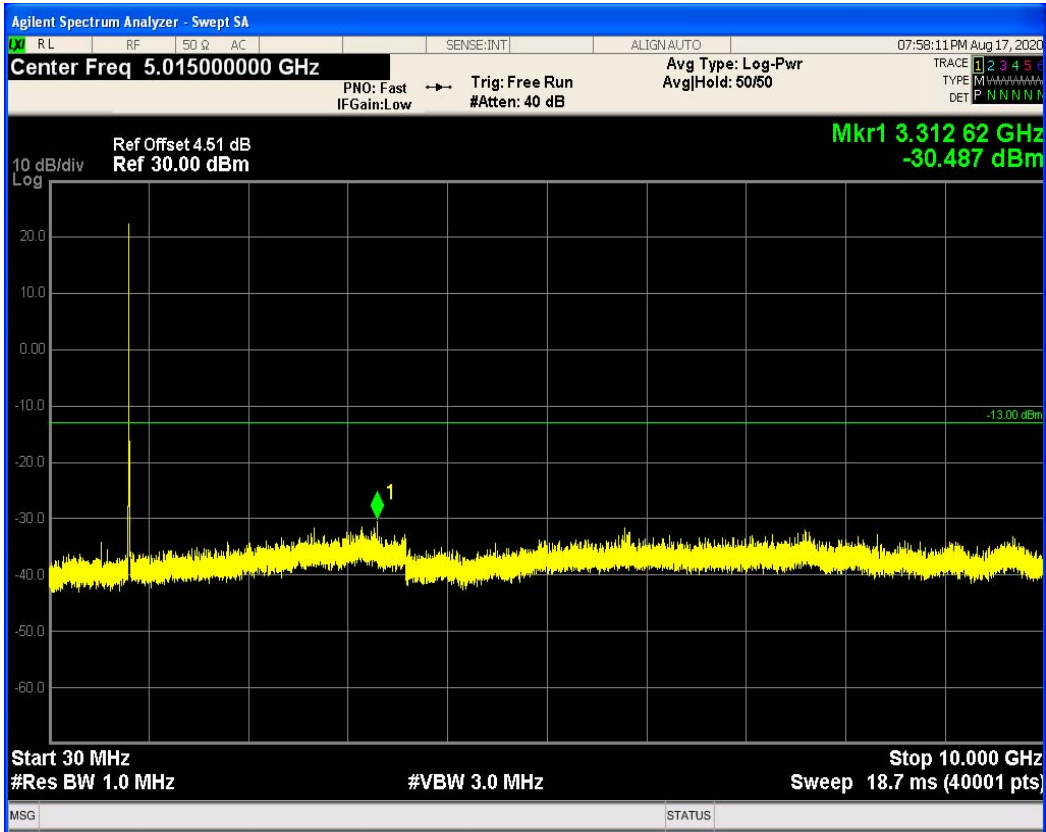

WCDMA Band5 Channel=4233

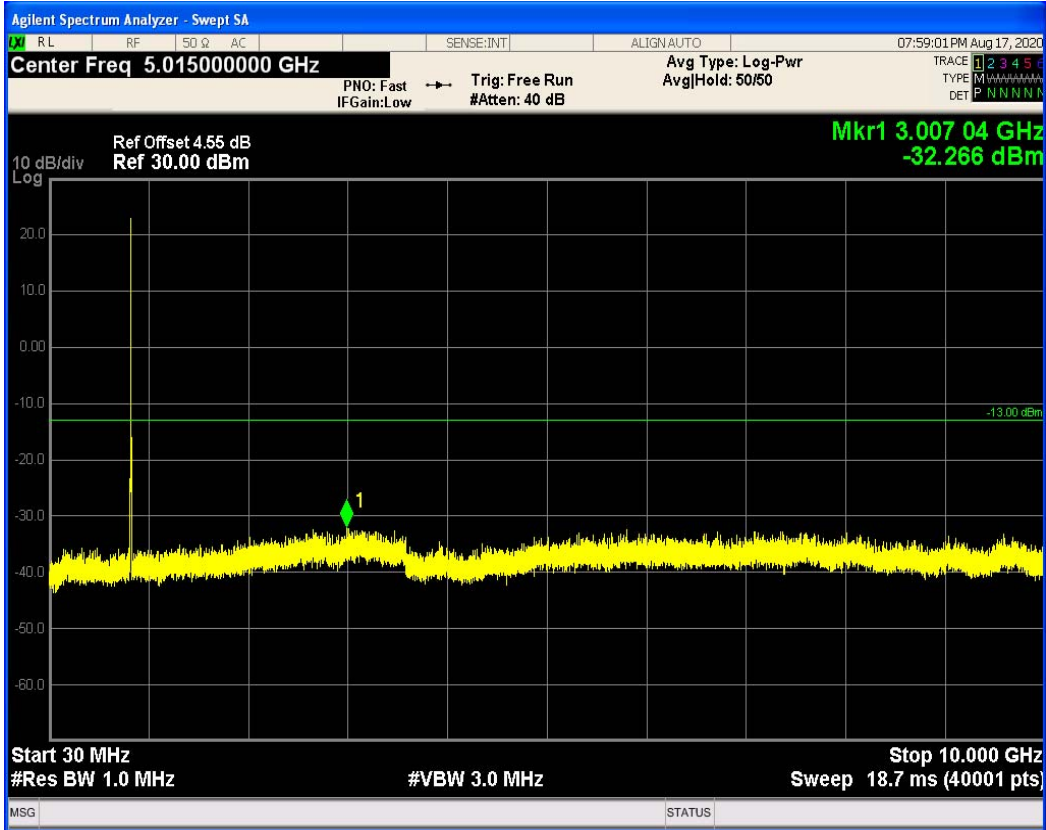

WCDMA Band5 Channel=4182

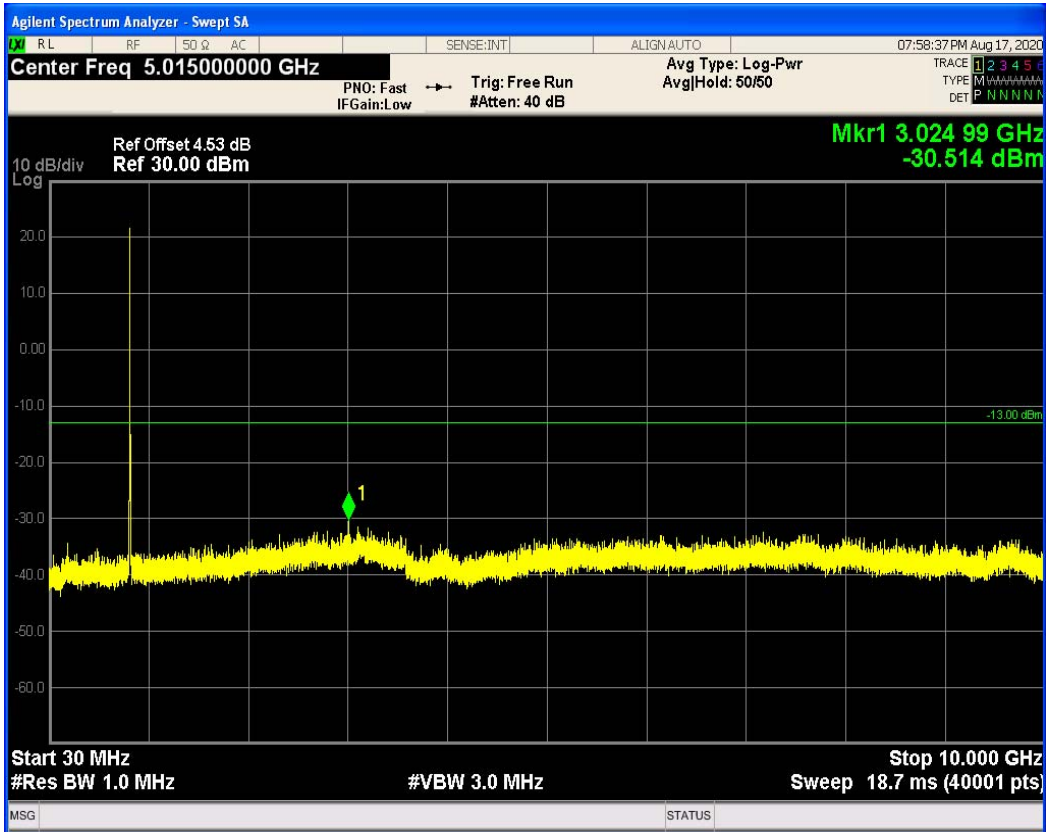

END OF REPORT